

A: GENERAL INFORMATION

Terms and Conditions	A:1
General Information	A:3
Weights and Measurements	A:12
Order Forms	A:15

B: NEW PRODUCTS

Kevo	B:1
915 SmartCode	B:3
Ladera	B:5
Powerbolt 2	B:7
SmartKey Padlock	B:9
Aliso Knobs	B:11
Burbank Levers	B:13
Lisbon Levers	B:15
Uptown & Downtown Deadbolts	B:17
Montreal Levers	B:19
Sydney Levers	B:21

C: KWIKSET SIGNATURE SERIES

Handlesets	C:2
Levers	C:8
Knobs	C:11
Deadbolts	C:13
Specifications	C:14

D: KWIKSET

Handlesets	D:2
Levers	D:3
Knobs	D:5
Deadbolts	D:6
Combo Packs	D:6
Specifications	D:7

E: ELECTRONIC LOCKS

Kevo	E:1
Specifications	E:2
915 SmartCode	E:3
Specifications	E:4
Electronics	E:5
Specifications	E:6

F: LIGHT COMMERCIAL

Residential/Light Commercial	F:1
Specifications	F:2
Key Control Deadbolt	F:3
Specifications	F:4

G: ACCESSORIES

Bath Hardware	G:1
Designer Roses	G:2
Pocket Door Locks	G:3
SmartKey Padlocks	G:3
Trim and Installation Aids	G:4

H: SERVICE PARTS

Keys	H:1
Pin & Tumbler	H:2
SmartKey	H:6
Key Control	H:7
Latches	H:8
Strikes	H:11
Screw Packs	H:14
Miscellaneous	H:18
Electronics	H:20



TERMS AND CONDITIONS OF SALE

Standard terms are 2% prompt payment discount for payment within 25 days from date of invoice; net 30 days from the date of invoice. Kwikset® reserves the right to charge and recover on invoices which are not paid within the above terms, a service charge of 1-1/2% a month for each month or fraction thereof during which the invoice remains unpaid, said service charge, however, not to exceed the highest applicable legal rate of interest. All orders, whether solicited or written by our sales representatives or forwarded by our customers are deemed to be mere offers to purchase in accordance with these Terms and Conditions of Sale until actually accepted by us at our home office in Lake Forest, CA. We reserve the right to refuse any order as well as the right to sell or not sell to any firm at our sole discretion. The acceptance of an order is expressly made conditional upon your assent to these Terms and Conditions of Sale. We object to the inclusion of any different or additional terms or conditions, even if the same are included in your order, a contract of sale will result upon the Terms and Conditions of Sale stated herein only. Prices reflected in this book apply to Wholesale customers only.

All sales are final.

PRICES

Pricing based on full-case quantities only; orders for less than full case will be automatically adjusted up to the next full-case quantity. All prices are subject to change without notice and are not guaranteed. All taxes, duties or other charges are the responsibility of the customer.

CLAIMS

Price claims must be submitted in writing to Kwikset, 19701 Da Vinci, Lake Forest, CA 92610 within 30 days from the date of invoice.

CHANGES OR CANCELLATIONS

Beyond 5 working days of our acknowledgement date no changes can be made. Additions to an order will be handled as a separate order and must meet applicable minimum order requirements. Order cancellation on regular stock items only, or any portion thereof is allowed only upon prior written consent from Kwikset, and the payment of cancellation charges deemed appropriate.

MINIMUM CHARGE

No order will be invoiced for less than \$100.00 net plus shipping charges except for lock accessory parts.

MINIMUM ANNUAL SALES VOLUME

The company reserves the right to discontinue direct sales to any customer who does not meet the minimum annual sales volume requirement. The current annual requirement is \$50,000.00. Your annual purchases are determined by accepted, non-cancelled, and shipped orders received during each calendar year. Kwikset reserves the right to change any or all minimum annual sales volume requirements at any time. Any customer who does not meet the annual sales volume requirements may continue to purchase Kwikset products through a Kwikset distributor.

RETURNS

Defective merchandise returned to our factories requires prior written authorization from a Kwikset Sales Rep or the Sales Office. A factory return authorization must accompany the returned shipment. The return authorization must include an itemized listing of the merchandise and an explanation stating the reason for return.

There will be a 20% product restocking fee on all returned merchandise.

FREIGHT

All goods are invoiced FOB to our factory. Upon delivery of shipments to the carrier, title to, and the risk of loss or damage in transit for such shipments, passes to our customer. Kwikset's standard policy is to pay freight charges on all orders over \$1,000.00 net invoice value to a single destination in the continental U.S., by carrier and route of our choice. Shipments less than these quantities will not be shipped on a

prepaid basis. If higher freight charges are incurred from customers specifying a carrier or route of their choice the additional cost will be added to that customer's invoice.

DELIVERY CONDITIONS

Shipping schedules are our best estimates, and cannot be guaranteed. Kwikset is not responsible for any direct or consequential loss or damage resulting from an inability or delay in meeting shipping schedules.

PRODUCT WARRANTY

Warranties cover the original residential user of Kwikset Products against defects in material and workmanship as long as the original user occupies the residential premises upon which the Product was originally installed. This warranty DOES NOT COVER abused or misused products or non-commercial products used in commercial applications. Upon return of a defective product to Kwikset Corporation, Kwikset shall either replace the product or refund the purchase price, at our discretion. If a covered defect occurs, call 1-800-327-LOCK (5625) in the U.S. and Canada or return it to Kwikset Corporation, Consumer Services, 19701 DaVinci, Lake Forest, California 92610. A finish deterioration occurring from the use of paints, solvents, or other chemicals is not a defect in the finish and is not covered by this warranty. Kwikset is not liable for incidental or consequential damages. Some states do not allow the exclusion or limitation of incidental or consequential damages, so the above exclusion may not apply to you. This warranty gives you specific legal rights and you may also have other rights that vary from state to state.

PATENT INDEMNITY

We agree to defend any suit or proceeding brought against our customer so far as based on claim that our products, or any part thereof, made solely to our specifications and furnished to our customer constitute an infringement of any U.S. patent, if notified promptly in writing and given authority, information and assistance at our expense for the defense of same, and we shall pay all damages and costs awarded therein against our customer. In case our products, or any part thereof, is in such suit held to constitute infringement and their use is enjoined, we will, at our expense and discretion, either procure for our customer the right to continue using the products or replace same with non-infringing products, or modify them so they become non-infringing, or remove such products and refund the purchase price (less depreciation, prorated from the purchase date). The foregoing states our entire liability for patent infringement by our products or any part thereof.

INTELLECTUAL PROPERTY

No person or entity may sell, distribute, advertise, market or promote Kwikset branded products distributed by Kwikset Corporation ("Kwikset"), a member of Black & Decker's HHI Group, without prior authorization from Kwikset. Customers of Kwikset who are authorized to sell Kwikset branded products are referred to herein as "Customers."

The Kwikset brand and all Kwikset trademarks, trade names, product depictions, colors, graphics or logos, whether or not registered or otherwise protected (the "Marks"), remain the sole and exclusive property of Kwikset and nothing arising out of the relationship between Kwikset and any Customer conveys to Customer any ownership rights in the Marks. Customer may use the Marks and then only in the sale or promotion of authentic Kwikset products in compliance with the terms of this policy. The Marks must be used exactly in the form provided and in conformity with all Kwikset trademark usage policies or guidelines, including, but not limited to, those relating to shape, color match and imprint quality. Any proposed deviation must be approved in writing by Kwikset prior to use. The Marks may not be used in or as part of any Customer domain name on the Internet. Prior to any use of the Marks on goods or services, Customer must submit samples for Kwikset's approval.

Additionally, no Customer may use product depictions, graphics, logos or text relating to Kwikset products that have not been provided by Kwikset in connection with the advertising, promotion or sale of Kwikset products without Kwikset's prior review and written approval of each such use. The Marks may not be used in or as part of any reseller or other third party (i) domain name or VRL on the Internet, (ii) trademark or service mark, or (iii) company or trade name. Any action on the part of a Customer that violates the terms of this policy or otherwise impairs the value of or goodwill associated with the Marks or is otherwise not in conformity with Kwikset's standards may result



in the suspension or termination of the Customer's authorization or any other remedy permitted by law.

Kwikset grants to each of its Customers limited, non-transferable, non-sublicenseable licenses of the patents relating to the Kwikset products that the Customer is authorized to sell and of the copyrights in any packaging or other written materials included therewith or related thereto. Said patent and copyright licenses are solely to sell such Kwikset products covered by such patents and to which such copyrights relate only to end-users and other Customers in compliance with the terms of this document. The sale of such patented Kwikset products and the sale or use of such copyrighted materials by a Customer that violate the terms of this document exceed the scope of the licenses herein granted to the Customer and may constitute patent and/or copyright infringement.

STANDARDS

Kwikset meets or exceeds the testing requirements specified for each product grade or rating.

- American National Standards Institute (ANSI)
- Builders Hardware Manufacturers Association (BHMA)
- Underwriters Laboratories, Inc. (UL)
- Americans with Disabilities Act (ADA)

MISCELLANEOUS

Substitution of non-Kwikset components/parts, and any alteration or modification of factory parts, and other lock manufacturer's parts may result in door hardware which does not function properly or will fail and will void all warranties. Orders not specified with keying requirements will be shipped Keyed Differently (KD). Orders with keying requirements of K10 or more must have a "Letter of Release" on file with Kwikset stating that Kwikset Corporation will not be held liable for cost and expense arising from any loss or damage to property utilizing Kwikset products where 10 or more locks have been keyed alike. Contact your Sales Office account representative for a copy of the release form. Kwikset reserves the right to revise or modify products, product information, or pricing without notice. Product specifications and pricing reflect available information at the time of printing. Kwikset is not responsible for typographic or printing errors.

ORDER CODE BREAKOUT

Quantity	Specifies Quantity
Function & Style	Specifies Model and Function
Rose Design	Specifies Designer Rose
Handing	Handing Right or Left
Finish	Exterior/Interior
Keying	Special Keying
Code	Keying Code
Latch	Specifies Latch
Strike	Indicates Strike
Key Alike Qty	Keyed Alike

Example: "I would like to order 12 SmartKey Commonwealth levers, satin nickel finish, round corner latch & strike, 3 keyed alike" Written as:

12-740CHL 15 SMT RCAL RCS K3.

NOTE: All handlesets ordered LIP only.

UNDERWRITERS LABORATORIES LISTED LOCKSETS



To meet Underwriters Laboratories' fire rating requirements UL listed locksets, UL listed latches, and UL listed strikes must be used together.

AMERICAN WITH DISABILITIES ACT



Products displaying this symbol comply with the Americans with Disabilities Act of 1990.

HOW TO ORDER 20MIN UL LOCKS

FD = 20 minute UL designation

Example: "I would like to order 12 passage Tustin levers with round corner latch and strike with 20 minute UL in Satin Nickel"

12-720TNL 15 RCALFD RCS.

NOTE: The latch configuration is not available with FD. There is a \$2.50 list price upcharge for 20 minute UL.

KEYING

Code	Option
KD	Keyed Differently
K2, K3	Keyed Alike (2 Locksets, 3 Locksets)
MK	Master Keyed
PK	Builder (Protecto) Keyed
GMK	Grand Master Keyed
PMK	Builder (Protecto) Master Keyed
MAIS	Maison Keying
SEQ	Sequential Construction Keying
KBOX	Keys in One Box
SMT	SmartKey

NOTE: There is a \$2.55 upcharge per lock for specialty keying.

BACKSET

Backset is the distance from center edge of door to center of the 2-1/8" (54mm) diameter hole, 2-3/8" or 2-3/4" in most cases.

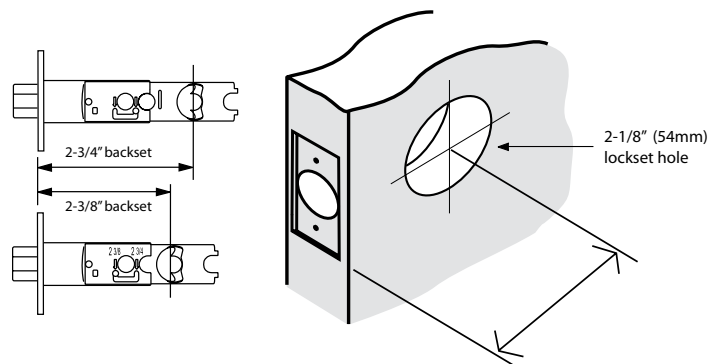

Kwikset

Model	Function
154/200/407/420/720/721/725	Passage/Hall/Closet
155/300/408/430/730/733/735	Privacy/Bed/Bath
334/335	Round Pocket Door Lock
400/401/438/740/741/756	Entry
405/406/409/413	Lever Keyed Entry
450/462/412/439/755/781	Storeroom/Vestibule
157/488/788	Half Dummy Trim, Surface Mounted
502/505/506/507/508	Interconnect
553/687/800/815	Single Cylinder Handleset
554/689/801	Double Cylinder Handleset
699/802	Dummy Handleset
598	Single Cylinder Gatelatch
599	Double Cylinder Gatelatch
604/605/606	Interior Pack for Kwikset Handlesets
158/258/660/780/782/980/982/816/817	Single Cylinder Deadbolts
159/665/784/785/984/985	Double Cylinder Deadbolts
907/909/911/913/915	Powerbolt/SmartCode Deadbolt/SmartCode Lever
925	Bluetooth Enabled Deadbolt
966/967/968	Interior Pack for Kwikset Signature Series Handleset
978/979	Interior Pack for Montara Handleset

HANDING

To determine the handing of a door face the OUTSIDE of the door. If the hinge is on the left side of the door, the door is left handed (LH). If the hinge is on the right side of the door, the door is right handed (RH).

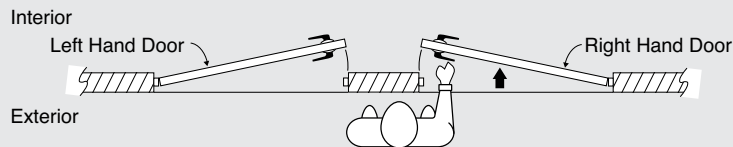

NOTE: Handing required for dummy levers and interior packs with levers when lever design is not symmetric.

Finish	Description	ANSI/BHMA	Latch	Description
3	Polished Brass	605	WFL	Wide Face Latch 2-1/4" x 1-1/8"
L03	Lifetime Polished Brass	605E	RCAL	Round Corner Adjustable Latch
5	Antique Brass	609	6AL	6-Way Adjustable Latch. All Parts Loose
11P	Venetian Bronze	---	SCAL	Square Corner Adjustable Latch
15	Satin Nickel	619	RFAL	Round Face Adjustable Latch
15A	Antique Nickel	620	RCAL FD	Round Corner Adjustable 20 Minute UL
26	Polished Chrome	625	SCAL FD	Square Corner Adjustable 20 Minute UL
26D	Satin Chrome	626	RFAL FD	Round Adjustable 20 Minute UL
501	Rustic Bronze	---		
502	Rustic Pewter	---		
514	Iron Black	---		

NOTE: List charge for 20 minute UL is \$2.50

Kwikset

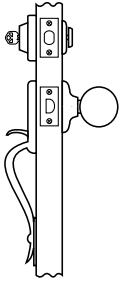
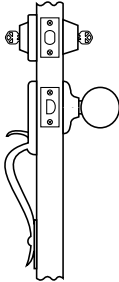
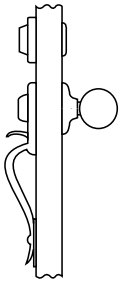
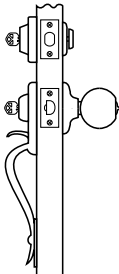
HANDLESETS	Function Name	Description	KWIKSET	KWIKSET SIGNATURE SERIES
	Handleset with Single Cylinder Deadbolt	Latch bolt operated by thumb piece outside and grip inside. Deadbolt operated by key outside and thumb turn inside.	687	800
	Handleset with Double Cylinder Deadbolt	Latch bolt operated by thumb piece outside and grip inside. Deadbolt operated by key both sides.	689	801
	Dummy Handleset with Dummy Deadbolt	Handle and grip act as a pull only. For inactive leaf of double doors. No operation.	699	802
	Two Point Locking Handleset with Single Cylinder Deadbolt	Latch bolt operated by thumb piece outside and grip inside, except when both are locked by key outside or turn button inside. Deadbolt operated by key outside or thumb turn inside.	N/A	553 F94

Kwikset

HANDLESETS **Function Name** **Description** **KWIKSET** **KWIKSET SIGNATURE SERIES**

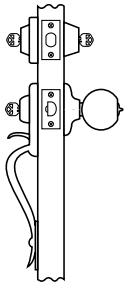

Two Point Locking Handleset with Double Cylinder Deadbolt

Latch bolt operated by thumb piece outside and grip inside, except when both are locked by key outside or turn button inside. Deadbolt operated by key both sides.

N/A

554 F94

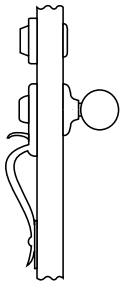

Two Point Locking Dummy Handleset with Dummy Deadbolt

Handle and grip act as a pull only. For inactive leaf of double doors. No operation.

N/A

555

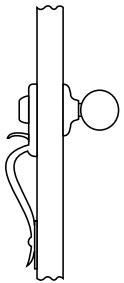



Handleset with Knob or Lever

Latch bolt operated by thumb piece outside and grip inside.

N/A

815

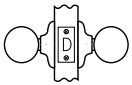
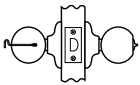
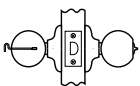
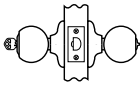
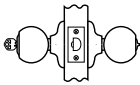
Kwikset

KNOB	Function Name	Description	KWIKSET w/ BHMA	KWIKSET SIGNATURE SERIES w/ BHMA
	Passage/Hall/Closet	Both knobs always free.	200 <i>F75</i>	720/725UL <i>F75</i>
	Privacy/Bed/Bath	Both knobs locked or unlocked by turn button inside. Outside knob unlocked by emergency key.	300 <i>F76</i>	730/735UL <i>F76</i>
	Privacy/Bathroom	Same function as above. Inside knob polished chrome finish.	300 <i>F76</i>	730 <i>F76</i>
	Entry	Both knobs locked or unlocked by key outside or turn button inside.	400 <i>F82</i>	740/745UL <i>F82</i>
	Entry, Free Interior	Outside locked or unlocked by key outside or turn button inside. Inside always free.	401 <i>F81</i>	741/746UL <i>F81</i>
	Storeroom/Vestibule	Outside unlocked only while key is turned. Inside always free.	450 <i>F86</i>	750/755UL <i>F86</i>
	Half Dummy Trim, Surface Mounted	For doors where only a pull is required. No operation.	488	788





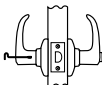
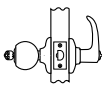
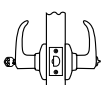
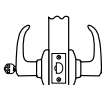
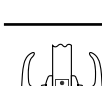

NOTE: BHMA code in *italics*. *Optional UL 1/3 hour rating for all functions.*

Kwikset

LEVERS	Function Name	Description	KWIKSET w/ BHMA	KWIKSET SIGNATURE SERIES w/ BHMA
	Passage/Hall/Closet	Both levers always free.	200/407/420UL <i>F75</i>	154/720/725/725UL <i>F75</i>
	Privacy/Bed/Bath	Both levers locked or unlocked by turn button inside. Outside lever unlocked by emergency key.	300/408UL/430UL <i>F76</i>	155/730/733UL <i>F76</i>
	Privacy/Bathroom	Same function as above. Inside lever polished chrome finish.	300/408/430 <i>F76</i>	155/730/733/735UL <i>F76</i>
	Entry	Both sides locked or unlocked by key outside or turn button inside.	401/405/406 <i>F82</i>	740/745/756UL <i>F82</i>
	Keyed Entry Lever	Both levers locked or unlocked by key outside or turn button inside.	401/405/406UL <i>F82</i>	740/745/756UL <i>F82</i>
	Entry, Free Interior	Outside locked or unlocked by key outside or turn button inside. Inside always free.	401/406/413UL <i>F81</i>	741/746UL/911 <i>F81</i>
	Storeroom/Vestibule	Outside unlocked only while key is turned. Inside always free.	439/450/462/412UL <i>F86</i>	750/755UL/781 <i>F86</i>
	Half Dummy Trim, Surface Mounted	For doors where only a pull is required. No operation.	488	788/157

NOTE: BHMA code in *italics*. Optional UL 1/3 hour rating for all functions.

Kwikset

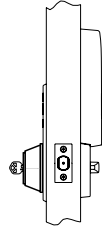
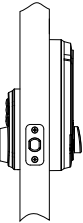
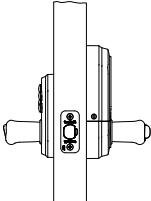
DEADBOLTS		Function Name	Description	KWIKSET w/ BHMA	KWIKSET SIGNATURE SERIES w/ BHMA
	Single Cylinder	Deadbolt operated by key outside and thumb turn inside.	660 <i>E0153</i>	980/982UL <i>E0151</i> 780/782UL/909 <i>E0152</i> 816/817UL <i>E0152</i> 158/258/913/925/997 <i>E0142</i>	
	Double Cylinder	Deadbolt operated by key both sides.	665/667 <i>E0143</i>	985/984UL <i>E0141</i> 785/784UL <i>E0142</i> 994/996 159 <i>E0152</i>	
	Thumb Turn Only	Deadbolt operated by thumb turn one side. No trim on exterior.	663 <i>E0193</i>	N/A	
	Conversion Kit	Converts 663 to 667 when door is bored through.	664	N/A	
	Thumb Turn x Plate	Deadbolt operated by thumb turn on interior. Blank plate on exterior.	667/677UL <i>E01113</i>	N/A	
	Single Cylinder Gatelatch	Deadbolt operated by key outside and thumb turn inside.	N/A	598	
	Double Cylinder Gatelatch	Deadbolt operated by key both sides.	N/A	599	
ELECTRONIC DEADBOLTS		Function Name	Description	KWIKSET w/ BHMA	KWIKSET SIGNATURE SERIES w/ BHMA
	Kevo®	Deadbolt operated by key outside or bluetooth enabled device	N/A	925 <i>E0152</i>	
	SmartCode™ Deadbolt	Deadbolt operated by key outside or electronic keypad and thumb turn inside.	N/A	909/913/915 <i>E0152</i>	
	SmartCode™ Lever	Keyed lever operated by key outside or electronic keypad and thumb turn inside.	N/A	911 F81	

NOTE: BHMA code in *italics*

Kwikset

ROUND POCKET

DOOR LOCK

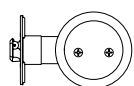

Passage

Pocket door lock always free.

KWIKSET w/ BHMA

334

KWIKSET SIGNATURE

SERIES w/ BHMA

N/A

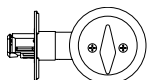

Privacy

Pocket door lock operated by thumb turn.

335

N/A

LIGHT COMMERCIAL

LEVER

Function Name

Description

LIGHT COMMERCIAL

w/ BHMA



Passage/Hall/Closet

Both levers always free.

407/720/721/725UL *F75*

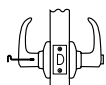

Privacy/Bed/Bath

Both levers locked or unlocked by ADA turn button inside. Outside lever unlocked by emergency key.

408/730/733/735UL *F76*

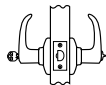

Entry

Both levers locked or unlocked by key outside or ADA turn button inside.

409/410/438/740/745UL/756 *F82*

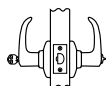

Entry, Free Interior

Outside locked or unlocked by key outside or turn button inside. Inside always free.

401/406/413/741/746UL *F81*

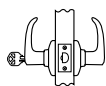

Storeroom/Vestibule

Outside unlocked only while key is turned. Inside always free.

412/439/750/755UL/781 *F86*



Half Dummy Trim,
Surface Mounted

For doors where only a pull is required. No operation.



788

NOTE: BHMA code in *italics*

Kwikset

METAL

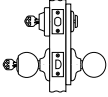
INTERCONNECT

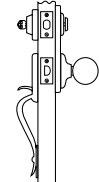
	Function Name	Description	METAL INTERCONNECT Model w/BHMA
	Deadlock Latch	Operated by grip either side except when locked by key outside and thumb turn inside. Deadbolt operated by key outside and thumb turn inside. Inside grip simultaneously retracts dead latch and deadbolt latch.	505/506UL <i>F97</i>
	Plain Latch	Operated by grip either side. Deadbolt operated by key outside and thumb turn inside. Inside grip simultaneously retracts plain latch and deadbolt latch.	508/507UL <i>F96</i>
	Interior Assembly Only	Grip inside simultaneously retracts plain latch and deadbolt latch when matched with handleset on outside.	502

NOTE: BHMA code in *italics*



BOX PACK	Unit					Master Case			
	Quantity	Length (in.)	Width (in.)	Height (in.)	Weight (lbs.)	Quantity	Length (in.)	Width (in.)	Height (in.)
Kwikset Signature Series									
Deadbolts									
780 Single Cylinder	1	4.6730	3.9230	3.0720	2.2500	12	12.8750	12.5000	5.3125
785 Double Cylinder	1	4.6730	3.9230	3.0720	2.7500	12	12.8750	12.5000	5.3125
816 Key Control	1	4.6730	3.9230	3.0720	2.2500	12	12.8750	12.5000	5.3125
980 Single Cylinder	1	4.6730	3.9230	3.0720	2.2500	12	12.8750	12.5000	5.3125
985 Double Cylinder	1	4.6730	3.9230	3.0720	2.7500	12	12.8750	12.5000	5.3125
158 Single Cylinder	1	4.6730	3.9230	3.0720	2.2500	12	12.8750	12.5000	5.3125
159 Single Cylinder	1	4.6730	3.9230	3.0720	2.7500	12	12.8750	12.5000	5.3125
258 Single Cylinder	1	4.81	4.06	3.13	1.76	12	13.37	12.9	6.21
Electronic Deadbolts/Levers									
907 Powerbolt	1	5.51	3.54	9.29	2.93	2	5.75	7.87	10.16
909 SmartCode	1	5.5	3.5	10	2.88	2	7.6	6	10.5
911 SmartCode Lever	1	3.5	6	10	61	2	7	12.5	10.4
913 SmartCode	1	5.5	3.5	10	2.88	2	7.6	6	10.5
915 SmartCode	1	3.5	5.38	9.88	3.14	2	10.50	7.75	5.94
925 Kevo	1	3.63	5.75	10.38	3.5	1	11.63	4	6.25
926 Kevo Fob	4	6	1	3	0.5	4	6	1	3
Handlesets									
553 Single Cylinder	1	15.9380	7.1250	4.0000	6.2500	6	15.0000	12.1250	16.6255
554 Double Cylinder	1	15.9380	7.1250	4.0000	6.7500	6	15.0000	12.1250	16.6255
800 AUH Austin	1	15.9380	7.1250	4.0000	7.0000	6	15.0000	12.1250	16.6255
801 AUH Austin	1	15.9380	7.1250	4.0000	7.5000	6	15.0000	12.1250	16.6255
802 AUH Austin	1	15.9380	7.1250	4.0000	6.5000	6	15.0000	12.1250	16.6255
800ADH Ashfield, 800AVH Avalon	1	15.9380	7.1250	4.0000	7.0000	6	15.0000	12.1250	16.6255
801ADH Ashfield, 801AVH Avalon	1	15.9380	7.1250	4.0000	7.5000	6	15.0000	12.1250	16.6255
802ADH Ashfield, 802AVH Avalon	1	15.9380	7.1250	4.0000	6.5000	6	15.0000	12.1250	16.6255
800AN Arlington	1	15.9380	7.1250	4.0000	7.0000	6	15.0000	12.1250	16.6255
801AN Arlington	1	15.9380	7.1250	4.0000	7.5000	6	15.0000	12.1250	16.6255
802AN Arlington	1	15.9380	7.1250	4.0000	6.5000	6	15.0000	12.1250	16.6255
800AT Amherst	1	19.9380	7.6250	4.0000	8.9000	4	20.5000	16.0000	8.3875
801AT Amherst	1	19.9380	7.6250	4.0000	9.9000	4	20.5000	16.0000	8.3875
802AT Amherst	1	19.9380	7.6250	4.0000	6.9000	4	20.5000	16.0000	8.3875
800CE Chelsea	1	15.9380	7.1250	4.0000	6.0000	6	15.0000	12.1250	16.6255
801CE Chelsea	1	15.9380	7.1250	4.0000	6.5000	6	15.0000	12.1250	16.6255
802CE Chelsea	1	15.9380	7.1250	4.0000	5.5000	6	15.0000	12.1250	16.6255
800HE Hawthorne	1	15.9380	7.1250	4.0000	7.0000	4	16.4380	15.9380	7.8125
801HE Hawthorne	1	15.9380	7.1250	4.0000	8.0000	4	16.4380	15.9380	7.8125
802HE Hawthorne	1	15.9380	7.1250	4.0000	5.0000	4	16.4380	15.9380	7.8125
800SE Shelburne	1	15.9380	7.1250	4.0000	7.9000	4	16.4380	15.9380	7.8125
801SE Shelburne	1	15.9380	7.1250	4.0000	8.9000	4	16.4380	15.9380	7.8125
802SE Shelburne	1	15.9380	7.1250	4.0000	5.9000	4	16.4380	15.9380	7.8125
800 Tavaris	1	15.9380	7.1250	4.0000	8.0000	4	16.4380	16.6200	8.3800
801 Tavaris	1	15.9380	7.1250	4.0000	8.2500	4	16.4380	16.6200	8.3800
802 Tavaris	1	15.9380	7.1250	4.0000	8.0000	4	16.4380	16.6200	8.3800
800WN Wellington	1	19.9380	7.6250	4.0000	7.2000	4	20.5000	16.0000	8.3875
801WN Wellington	1	19.9380	7.6250	4.0000	8.2000	4	20.5000	16.0000	8.3875
802WN Wellington	1	19.9380	7.6250	4.0000	5.2000	4	20.5000	16.0000	8.3875
966 Single Cylinder	1	2.7	3.7	4.30	2.25	12	15.20	12.5	7
967 Double Cylinder	1	2.7	3.7	4.30	2.25	12	15.20	12.5	7
968 Dummy	1	2.7	3.7	4.30	2.25	12	15.20	12.5	7
978 Single Cylinder	1	2.7	3.7	4.30	2.25	12	15.20	12.5	7
979 Double Cylinder	1	2.7	3.7	4.30	2.25	12	15.20	12.5	7



BOX PACK	Unit					Master Case			
	Quantity	Length (in.)	Width (in.)	Height (in.)	Weight (lbs.)	Quantity	Length (in.)	Width (in.)	Height (in.)
Kwikset Signature Series Continued									
Knobs									
720 Passage	1	8.1730	3.9230	2.7840	2.0000	12/30	12.3750	11.5000	8.8125
730 Privacy	1	8.1730	3.9230	2.7840	2.0000	12/30	12.3750	11.5000	8.8125
740 Entry	1	8.1730	3.9230	2.7840	2.3300	12/30	12.3750	11.5000	8.8125
788 Dummy	1	3.2360	2.7980	3.0100	0.3500	20	14.8750	12.5000	3.9375
Levers									
154/720 Passage	1	7.8750	6.1250	3.1875	2.4200	12/20	19.7500	12.8750	8.5625
155/730 Privacy	1	7.8750	6.1250	3.1875	2.4200	12/20	19.7500	12.8750	8.5625
740 Entry	1	7.8750	6.1250	3.1875	2.4200	12/20	19.7500	12.8750	8.5625
157/788 Dummy	1	5.8610	3.1100	2.8220	0.4500	20	15.8750	12.1250	6.6245
720 LL, TNL	1	6.625	5.75	3.0	1.65	20	24	15.50	6.70
730 LL, TNL	1	6.625	5.75	3.0	1.70	20	24	15.50	6.85
740 LL, TNL	1	6.625	5.75	3.0	2.05	20	24	15.50	8.30
788 LL, TNL	1	5.861	3.11	2.822	0.450	20	15.875	12.125	6.6245

Kwikset									
Combo Packs									
690T Tylo Knob and Single Cylinder Deadbolt	1	11.3090	3.4230	2.7840	2.8000	6	8.7500	7.3120	11.9375
Deadbolts									
598 Single Cylinder Gate Latch	1	4.6730	3.9230	3.0720	2.2500	12	12.8750	12.5000	5.3125
599 Double Cylinder Gate Latch	1	4.6730	3.9230	3.0720	2.2500	12	12.8750	12.5000	5.3125
660 Single Cylinder	1	3.9480	3.4230	2.5720	0.5000	12	11.1250	11.0000	4.5625
665 Double Cylinder	1	3.9480	3.4230	2.5720	0.9000	12	11.1250	11.0000	4.5625
663 One-Sided	1	3.9480	3.4230	2.5720	0.5500	12	11.1250	11.0000	4.5625
667 One-Sided	1	3.9480	3.4230	2.5720	0.9000	12	11.1250	11.0000	4.5625
664 Retrofit Kit	1	3.9480	3.4230	2.5720	0.9000	12	11.1250	11.0000	4.5625
677 One-Sided	1	3.9480	3.4230	2.5720	0.2500	12	11.1250	11.0000	4.5625
Handlesets									
604 Single Cylinder	1	5.8000	3.9000	3.7000	2.25	12	15.20	12.5	7
605 Double Cylinder	1	5.8000	3.9000	3.7000	2.25	12	15.20	12.5	7
606 Dummy	1	5.8000	3.9000	3.7000	2.25	12	15.20	12.5	7
687 LIP	1	15.9380	7.1250	4.0000	3.6000	6	15.0000	12.1250	16.6255
689 LIP	1	15.9380	7.1250	4.0000	4.0000	6	15.0000	12.1250	16.6255
699 LIP	1	15.9380	7.1250	4.0000	3.6000	6	15.0000	12.1250	16.6255
Knobs									
200 Polo	1	8.1730	3.2980	2.7840	1.3000	30	17.1250	17.0000	8.8125
300 Polo	1	8.1730	3.2980	2.7840	1.3000	30	17.1250	17.0000	8.8125
400 Polo	1	8.1730	3.2980	2.7840	1.3000	30	17.1250	17.0000	8.8125
200 Tylo/Cove	1	7.3610	3.2980	2.7840	1.1500	30	17.1250	17.0000	8.1870
300 Tylo/Cove	1	7.3610	3.2980	2.7840	1.1500	30	17.1250	17.0000	8.1870
400 Tylo/Cove	1	7.3610	3.2980	2.7840	1.1500	30	17.1250	17.0000	8.1870
488 Dummy	1	3.2360	2.7980	3.0100	0.3500	20	14.8750	12.5000	3.9375
Lever									
200 Passage	1	6.7980	5.7660	2.9720	1.3500	20	23.6250	15.3750	7.4995
300 Privacy	1	6.7980	5.7660	2.9720	1.3500	20	23.6250	15.3750	7.4995
405 Keyed Lever	1	6.7980	5.7660	2.9720	1.5800	20	23.6250	15.3750	7.4995
488 Dummy	1	5.8610	3.1100	2.8220	0.4500	20	15.8750	12.1250	6.6245

Miscellaneous									
Pocket Door Hardware									
332 Passage	1	3.2	2.8	1.6	0.52	12	10.1	5.8	3.6
333 Privacy	1	3.1	2.8	1.6	0.42	12	10.2	6.1	3.7
334 Passage	1	4.3750	3.0000	2.0000	.65	12	12.5000	14.3750	2.2500
335 Privacy	1	4.3750	3.0000	2.0000	.8	12	12.5000	14.3750	2.2500

Kwikset

BOX PACK	Unit					Master Case			
	Quantity	Length (in.)	Width (in.)	Height (in.)	Weight (lbs.)	Quantity	Length (in.)	Width (in.)	Height (in.)
Kwikset Multi-Family / Light Commercial									
Carson									
407CNL	1	6.75	5.75	2.75	0.5	1	7.93	6.06	3.12
408CNL	1	6.75	5.75	2.75	0.5	1	7.93	6.06	3.12
438CNL SMT	1	6.75	5.75	2.75	1.0	1	7.93	6.06	3.12
439CNL SMT	1	6.75	5.75	2.75	1.0	1	7.93	6.06	3.12
488CNL	1	5.18	3.00	2.43	0.55	1	15.75	12.00	6.56
Kingston									
721KNL	1	6.75	5.75	2.75	1.5	1	7.93	6.06	3.12
733KNL	1	6.75	5.75	2.75	1.5	1	7.93	6.06	3.12
756KNL SMT	1	6.75	5.75	2.75	2.33	1	7.93	6.06	3.12
781KNL SMT	1	6.75	5.75	2.75	2.33	1	7.93	6.06	3.12
788 LVR	1	5.18	3.00	2.43	0.87	1	15.13	12.75	3.50
SmartKey Padlock									
50MM SmartKey Padlock Std. Shackle	6	2.56	1.46	4.65	1.10	6	5.39	4.80	5.04
50MM SmartKey Padlock Long Shackle	6	2.56	1.46	4.65	1.14	6	5.39	4.80	5.04



Customer Service Toll Free Line:

(800) 422-LOCK (800) 422-4278

FAX (866) 507-8369

email: kworders@spectrumsihi.com

Monday to Friday, 6:00 a.m. to 4:00 p.m. PST

Date: _____ Delivery Address: _____ Contact: _____

PO Number: _____ Phone: _____ Company Name: _____

Job Name: _____ Fax: _____ Address: _____

Notes: _____ Store Number: _____

Line No.	Function		Style		Handling	Rose		Finish		OPTIONS							
	Exterior	Interior	Exterior	Interior		Exterior	Interior	Exterior	Interior	Door Thickness	Latch	Strike	Cylinder	Keying	Quantity	Price	Extended Price
1																	
2																	
3																	
4																	
5																	
6																	
7																	
8																	
9																	
10																	
11																	
12																	
13																	
14																	
15																	
16																	
17																	
18																	
19																	
20																	

To order service parts, provide service part # and quantity.

How to order questions, refer back to page A.3 for General Information.



Customer Service Toll Free Line:
(800) 422-LOCK (800) 422-4278

FAX (866) 507-8369

email: kworders@spectrumsihi.com

Monday to Friday, 6:00 a.m. to 4:00 p.m. PST

Date: _____ Delivery Address: _____ Contact: _____

PO Number: _____ Phone: _____ Company Name: _____

Job Name: _____ Fax: _____ Address: _____

Notes: _____ Store Number: _____

Line No.	Function		Style		Handling	Rose		Finish		OPTIONS							
	Exterior	Interior	Exterior	Interior		Exterior	Interior	Exterior	Interior	Door Thickness	Latch	Strike	Cylinder	Keying	Quantity	Price	Extended Price
1																	
2																	
3																	
4																	
5																	
6																	
7																	
8																	
9																	
10																	
11																	
12																	
13																	
14																	
15																	
16																	
17																	
18																	
19																	
20																	

To order service parts, provide service part # and quantity.

How to order questions, refer back to page A.3 for General Information.



Customer Service Toll Free Line:

(800) 422-LOCK (800) 422-4278

FAX (866) 507-8369

email: kworders@spectrumsihi.com

Monday to Friday, 6:00 a.m. to 4:00 p.m. PST

Date: _____ Delivery Address: _____ Contact: _____

PO Number: _____ Phone: _____ Company Name: _____

Job Name: _____ Fax: _____ Address: _____

Notes: _____ Store Number: _____

Line No.	Function		Style		Handling	Rose		Finish		Door Thickness	OPTIONS				Quantity	Price	Extended Price
	Exterior	Interior	Exterior	Interior		Exterior	Interior	Exterior	Interior		Latch	Strike	Cylinder	Keying			
1																	
2																	
3																	
4																	
5																	
6																	
7																	
8																	
9																	
10																	
11																	
12																	
13																	
14																	
15																	
16																	
17																	
18																	
19																	
20																	

To order service parts, provide service part # and quantity.

How to order questions, refer back to page A.3 for General Information.



Customer Service Toll Free Line:
(800) 422-LOCK (800) 422-4278

FAX (866) 507-8369

email: kworders@spectrumsihi.com

Monday to Friday, 6:00 a.m. to 4:00 p.m. PST

Date: _____ Delivery Address: _____ Contact: _____

PO Number: _____ Phone: _____ Company Name: _____

Job Name: _____ Fax: _____ Address: _____

Notes: _____ Store Number: _____

Line No.	Function		Style		Handling	Rose		Finish		OPTIONS							
	Exterior	Interior	Exterior	Interior		Exterior	Interior	Exterior	Interior	Door Thickness	Latch	Strike	Cylinder	Keying	Quantity	Price	Extended Price
1																	
2																	
3																	
4																	
5																	
6																	
7																	
8																	
9																	
10																	
11																	
12																	
13																	
14																	
15																	
16																	
17																	
18																	
19																	
20																	

To order service parts, provide service part # and quantity.

How to order questions, refer back to page A.3 for General Information.



Customer Service Toll Free Line:

(800) 422-LOCK (800) 422-4278

FAX (866) 507-8369

email: kworders@spectrumsihi.com

Monday to Friday, 6:00 a.m. to 4:00 p.m. PST

Date: _____ Delivery Address: _____ Contact: _____

PO Number: _____ Phone: _____ Company Name: _____

Job Name: _____ Fax: _____ Address: _____

Notes: _____ Store Number: _____

Line No.	Function		Style		Handling	Rose		Finish		OPTIONS							
	Exterior	Interior	Exterior	Interior		Exterior	Interior	Exterior	Interior	Door Thickness	Latch	Strike	Cylinder	Keying	Quantity	Price	Extended Price
1																	
2																	
3																	
4																	
5																	
6																	
7																	
8																	
9																	
10																	
11																	
12																	
13																	
14																	
15																	
16																	
17																	
18																	
19																	
20																	

To order service parts, provide service part # and quantity.

How to order questions, refer back to page A.3 for General Information.



Customer Service Toll Free Line:

(800) 422-LOCK (800) 422-4278

FAX (866) 507-8369

email: kworders@spectrumsihi.com

Monday to Friday, 6:00 a.m. to 4:00 p.m. PST

Date: _____ Delivery Address: _____ Contact: _____

PO Number: _____ Phone: _____ Company Name: _____

Job Name: _____ Fax: _____ Address: _____

Notes: _____ Store Number: _____

Line No.	Function		Style		Handling	Rose		Finish		OPTIONS					Quantity	Price	Extended Price
	Exterior	Interior	Exterior	Interior		Exterior	Interior	Exterior	Interior	Door Thickness	Latch	Strike	Cylinder	Keying			
1																	
2																	
3																	
4																	
5																	
6																	
7																	
8																	
9																	
10																	
11																	
12																	
13																	
14																	
15																	
16																	
17																	
18																	
19																	
20																	

To order service parts, provide service part # and quantity.

How to order questions, refer back to page A.3 for General Information.

Kwikset

kēvo™

THE KEY EVOLVED.

Your Smartphone is Now Your Key

Keep your phone in your pocket or purse. No more fumbling for your keys... just touch the lock to open for the ultimate in convenience.



Touch to Open
Convenience



No Smartphone?
No Problem



Share eKeys
via Smartphone



Compatible with the
iPhone 4S or higher
and Android 5.0
(Lollipop) or higher



Works with Nest

kēvo™

THE KEY EVOLVED.

Features

- Bluetooth enabled deadbolt
- Your smartphone is now your key
- Touch to open convenience
- Share eKeys with your smartphone
- Receive notifications and manage lock and eKeys through the Kevo mobile app

Specifications

Function	Single Cylinder Deadbolt
Door Prep	2 1/8" diameter face hole & 1" diameter latch hole
Backset	Adjustable 2 3/8" or 2 3/4"
Door Thickness	1 3/8" - 1 3/4" automatic adjustment
Cylinder	SmartKey® Re-key Technology
Faceplates	1" x 2 1/4" round corner standard
Strikes	Round corner strike 2 3/4" x 1 1/8"
Latch	Round corner adjustable 2 3/8" x 2 3/4"
Bolt	1" throw, steel deadbolt
Door Handing	Reversible
Batteries	4AA Required

Finishes



Polished Brass L03

Satin Nickel 15

Venetian Bronze 11P

Systems Requirements

- Bluetooth Smart ready with a Bluetooth 4.0 enabled device
- Data connection required to download Kevo mobile app
- **Smartphone compatibility:** Apple iPhone 4S or higher and Android 5.0 (Lollipop) or higher. Check here for an updated compatibility list: www.kwikset.com/Kevo

What's in the Box

- Kevo deadbolt, (2) eKeys, Kevo fob included for touch to open convenience without a smartphone, and 4 AA batteries, (2) standard keys

Dimensions

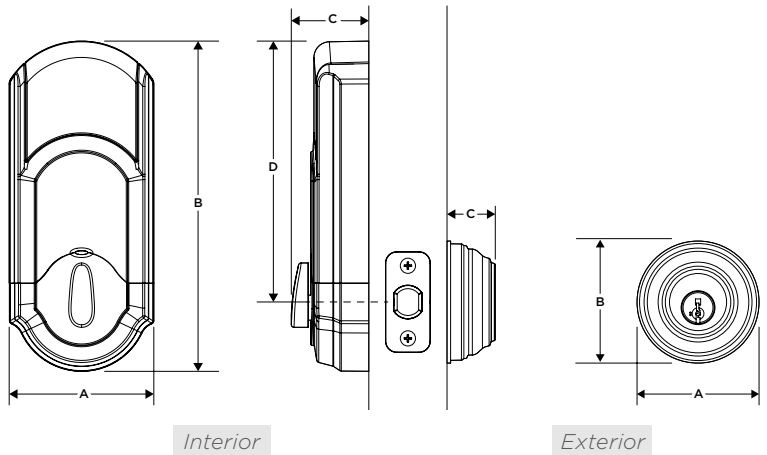

Design	A	B	C	D
Kevo™ Interior	3 1/4" (82.55 mm)	7 13/32" (188.12 mm)	1 3/4" (44.45 mm)	5 27/32" (148.44 mm)
Kevo™ Exterior	2 3/4" (69.85 mm)	2 3/4" (69.85 mm)	1 5/32" (29.37 mm)	---

Kwikset®

19701 DaVinci • Lake Forest, CA 92610 • www.kwikset.com/kevo • 1-800-327-LOCK

Kwikset is a trademark of Spectrum Brands, Inc. © 2015 Spectrum Brands, Inc., Lake Forest, CA 92610 • 20589-KW

SMARTCODE 915™

TOUCHSCREEN ELECTRONIC DEADBOLT



Kwikset®, the leader in residential security, introduces the **NEW** SmartCode™ 915 Touchscreen Electronic Deadbolt. Enter your home with your own personal user code. This new sleek design complements a range of Kwikset knobs, levers, and handlesets.

New Features

- Sleek metal design for enhanced quality
- Dramatically reduced interior size
- Tamper resistant interior cover
- Capacitive touchscreen

User Codes

- Up to 16 user access codes for family & guests
- MasterCode feature for improved user access code management

Additional Features

- Patented SecureScreen™—security feature helps to ensure that user codes cannot be identified by examining fingerprints on screen

Finishes



99150-001
Polished Brass



99150-002
Satin Nickel



99150-003
Venetian Bronze

Specifications

Function	Single cylinder deadbolt
Door Prep	2 1/8" diameter face hole & 1" diameter latch hole
Backset	Adjustable 2 3/8" or 2 3/4"
Door Thickness	1 3/8" - 2 1/8" automatic adjustment
Faceplates	1" x 2 1/4" round corner standard
Strikes	Round corner, 4 hole strike, 2 3/4" x 1 1/8"
Latch	Round corner adjustable 2 3/8" x 2 3/4"
Bolt	1" throw, steel deadbolt
Door Handing	Reversible
Cylinder	SmartKey®

Warranty

- Lifetime mechanical and finish warranty
- 1 year electronics warranty

Innovative Security

- BHMA grade 2 certified
- 20 Minute fire rating - UL certified
- Patented SecureScreen™—security feature helps to ensure that user codes cannot be identified by examining fingerprints on screen
- SmartKey® re-key technology with BumpGuard™ protection
- Revolutionary tapered deadbolt design—enables misaligned doors to lock without pulling and pushing your door shut

Easy Integration

- Replaces existing door hardware with just a screwdriver
- No hard wiring needed
- Operates on 4 AA batteries that will last for approximately 1 year

Introducing LADERA™

Featuring  **SMARTKEY**
RE-KEY TECHNOLOGY



Features SmartKey® Re-Key Technology
with BumpGuard™ Protection
ANSI/BHMA Grade 3 Certified Security & Quality
Lifetime Mechanical Warranty

Kwikset

LADERA™

Specifications:

Door Prep	Cross Bore 2 1/8". Edge Bore 1".
Backset	Adjustable to 2 3/8" or 2 3/4"
Door Thickness	1 3/8" - 1 3/4" standard, 2 1/4" doors optional on 200 and 405 functions only
Cylinder	SmartKey® or traditional 5-Pin Pin & Tumbler
Faceplates	1" x 2 1/4". Specify round corner, square corner or drive-in.
Strikes	2 1/4" full lip standard. Specify round corner, square corner. Other options available.
Bolt	1/2" throw.
Door Handing	Reversible for right or left-handed doors. Specify handing only on dummy and handleset interiors.
ANSI/BHMA	A156.2 Grade 3 (all functions except 488).

Finishes:



Venetian Bronze (11P)



Satin Nickel (15)



Polished Chrome (26)



Satin Chrome (26D)

Functions:

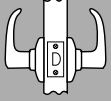
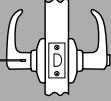
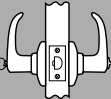
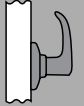
	200 Passage/Hall/Closet: Both levers always free.
	300 Privacy/Bed/Bath: Both levers locked or unlocked by turnbutton inside. Outside lever unlocked by emergency key.
	405 Keyed Entry: Both levers locked or unlocked by key outside or turnbutton inside.
	488 Half Dummy Trim, Surface Mounted: For doors where only a pull is required. Must specify right or left hand.

Dimensions:

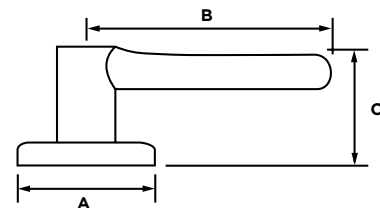

Design	A	B	C	C
Ladera™	2 5/8"	4 3/16"	1 7/8"	2 7/16" (keyed)

Kwikset



NEW
SLIMMER
PROFILE

Powerbolt²

TOUCHPAD KEYLESS ENTRY

- 6 User Access Codes
- Re-designed Sleek Metal Design
- BHMA Grade 3 Certified
- Illuminated Keypad
- Temporary One-time Code
- *NEW* MasterCode feature for improved user access code management

2 IS BETTER THAN 1 INTRODUCING POWERBOLT 2

Sometimes it's hard to say goodbye to someone we love. As Powerbolt rides off into the sunset we are excited to introduce Powerbolt 2.

Eliminate the need for keys - enter your house with your own personal code. No more lockouts or hiding keys under the mat. Store up to 6 unique user codes for family, guests, neighbors, dog walker etc. Easy to install. Easy to program. Easy to use. Easy to love.

■ Specifications

Function	Single cylinder deadbolt
Door Prep	2 1/8" diameter face hole & 1" diameter latch hole
Backset	Adjustable 2 3/8" or 2 3/4"
Door Thickness	1 3/8" - 2" automatic adjustment
Faceplates	1" x 2 1/4" square corner standard
Strikes	Square corner strike 2 3/4" x 1 1/8"
Latch	Square & drive-in adjustable 2 3/8" x 2 3/4"
Bolt	1" throw, steel deadbolt
Door Handing	Reversible
Cylinder	SmartKey® (KW1 Keyway)

■ Dimensions

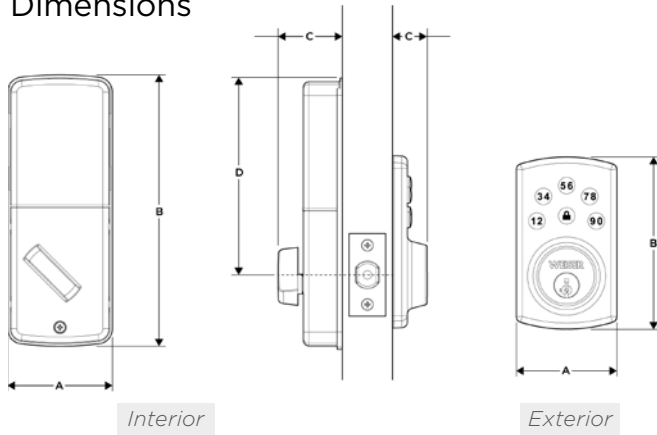

Design	A	B	C	D
Powerbolt® 2 Interior	2 7/8" (73 mm)	7 7/16" (189 mm)	1 3/4" (44.8 mm)	5 5/16" (134.5 mm)
Powerbolt® 2 Exterior	2 3/4" (70 mm)	4 3/4" (120 mm)	1 15/16" (24 mm)	---

■ Innovative Security

- 6 user access codes and master code for improved user access code management
- Alarm sounds after 5 consecutive incorrect entries and the keypad is deactivated for 45 seconds
- One-time use temporary code for single entry for a contractor / dog walker etc.
- BHMA Grade 3 certified
- Features Kwikset SmartKey® with BumpGuard™ protection that allows you to re-key the lock in 3 easy steps
- Easy configure auto door locking feature

■ Easy Integration

- Replaces existing door hardware with just a screwdriver
- No hard wiring needed
- Operates on 4 AA batteries that will last for approximately 1 year

■ Warranty

- Lifetime mechanical and finish warranty
- 1 year electronics warranty

■ 3 Designer Finishes



Polished Brass - 03



Satin Nickel - 15



Venetian Bronze - 11P

Kwikset

WELCOME TO THE FAMILY

NOW YOU CAN USE THE
SAME KEY TO UNLOCK YOUR
HOME AND PADLOCK

 **SMARTKEY**
RE-KEY TECHNOLOGY



**WORKS WITH
YOUR KWIKSET®
HOUSE KEY**

Re-key the SmartKey padlock to your current Kwikset house key using SmartKey's 3-step process. Now your house key will unlock your SmartKey padlock.

THE BEST SECURITY IS SMART SECURITY.

19696

Kwikset

PRODUCT FEATURES

- Hardened molybdenum shackle for superior resistance to sawing and cutting
- Dual ball bearing locking for maximum protection from pry and hammer attacks
- Key retaining feature ensures padlock is not left unlocked and prevents accidentally locking the key inside a shed, toolbox, locker, etc.
- Uses KW1 keyway

**SUPERIOR
SECURITY**

**BUMP
PROOF**

**PICK
RESISTANT**



10,000 lb Cut
Resistance



5,000 lb Pry
Resistance

BEST IF USED FOR:

- Residential gates and fences
- Sheds, workshops and garages
- Storage Lockers
- Tool chests and tool boxes
- Trucks and Trailers

50mm padlock
available in two shackle
heights (1 1/8 & 2")



90260-001

90260-002

LIFETIME
WARRANTY

www.kwikset.com

19701 Da Vinci | Lake Forest, CA | 92610 | 1-800-327-LOCK (5625)

Introducing ALISO™

Featuring  **SMARTKEY**
RE-KEY TECHNOLOGY



Features SmartKey® Re-Key Technology
with BumpGuard™ Protection
ANSI/BHMA Grade 3 Certified Security & Quality
Lifetime Mechanical Warranty

Kwikset

#1 SELLING U.S. LOCK BRAND

ALISO™

Specifications:

Door Prep	Cross Bore 2 1/8". Edge Bore 1". Latch face 1" x 2 1/4"
Backset	Adjustable to 2 3/8" or 2 3/4"
Door Thickness	1 3/8" - 1 3/4" doors standard
Cylinder	SmartKey™
Faceplates	1" x 2 1/4". Specify 6-way, round corner, square corner, or drive in.
Strikes	2 1/4" full lip standard. Specify round corner, square corner.
Bolt	1/2" throw for all functions.
ANSI/BHMA	A156.2 Grade 3

Functions:

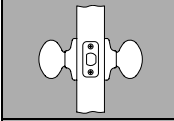
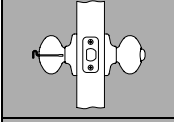
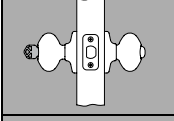
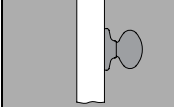
	Passage/Hall/Closet: Both knobs always free.
	Privacy/Bed/Bath: Both knobs locked or unlocked by turnbutton inside. Outside knob unlocked by emergency key.
	Keyed Entry: Both sides locked or unlocked by key outside or turnbutton inside.
	Half Dummy Trim, Surface Mounted: For doors where only a pull is required. No operation.

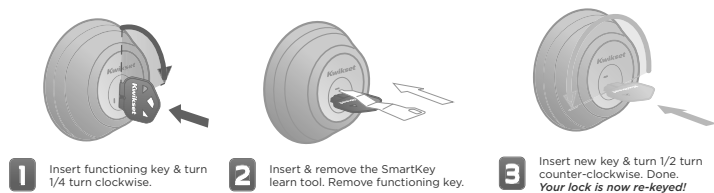

Dimensions:

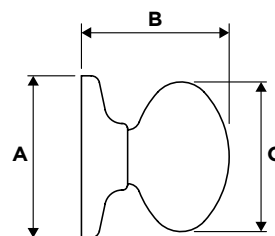

Design	A	B	C
Aliso™	2 5/8"	2 3/4"	2 2/5"

Finishes:



Satin Nickel (15)

Venetian Bronze (11P)

Polished Chrome (26)

Polished Brass (3)

Kwikset®

NEW BURBANK LEVER



- Push Button
- ANSI/BHMA Grade 3 Certified Security
- ADA Compliant
- Lifetime Mechanical Warranty

Introducing the new Burbank lever which features push button locking. Kwikset's Multi-Family & Light Commercial products are created with both heavy duty residential and light commercial applications in mind, including retail, apartment buildings, assisted living facilities, and other multi-family housing.

GREAT FOR:



Office



Multi-Family



Retail

#1 SELLING U.S. LOCK BRAND

NEW BURBANK LEVER

Specifications:

Door Prep	Cross Bore 2 1/8". Edge Bore 1".
Backset	Adjustable to 2 3/8" or 2 3/4"
Door Thickness	1 3/8" - 1 3/4" standard
Cylinder	5-Pin Pin & Tumbler
Latch	RCAL, SCAL, WFAL
Strikes	ASA-1 t-strike, Full Lip SCS UL, Full Lip 1/4" RCS UL, T Strike
Bolt	1/2" throw
Door Handing	Reversible for right or left-handed doors
ANSI/BHMA	A156.2 Grade 3 (all functions except 488)
UL	Meets UL 3 hour fire rating for all functions
ADA	Lever functions satisfy 4.13.9 ADA requirements (except 488 Half Dummy)

Functions:

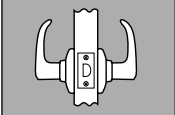
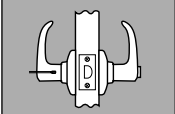
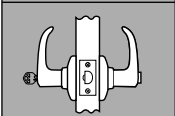
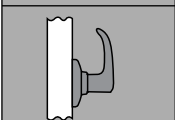
	407 Passage/Hall/Closet: Both levers always free.
	408 Privacy/Bed/Bath: Both levers locked or unlocked by push button inside. Outside lever unlocked by emergency key.
	438 Keyed Entry: Both levers locked or unlocked by key outside or push button inside.
	488 Half Dummy Trim, Surface Mounted: For doors where only a pull is required. Must specify right or left hand.

Dimensions:

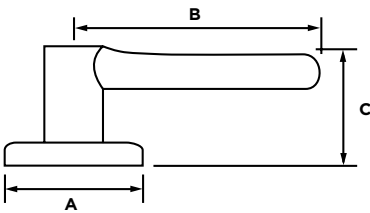

Design	A	B	C
Burbank™	2.56"	3.75"	1.96"

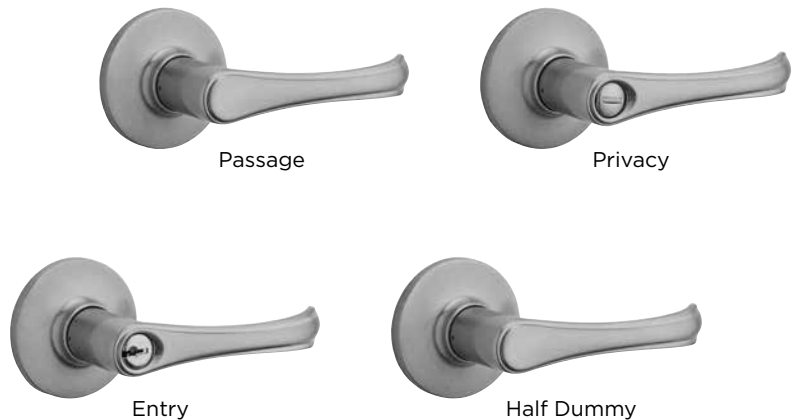

Finishes:



Polished Brass (3)



Venetian Bronze (11P)



Satin Nickel (15)



Polished Chrome (26)

Kwikset

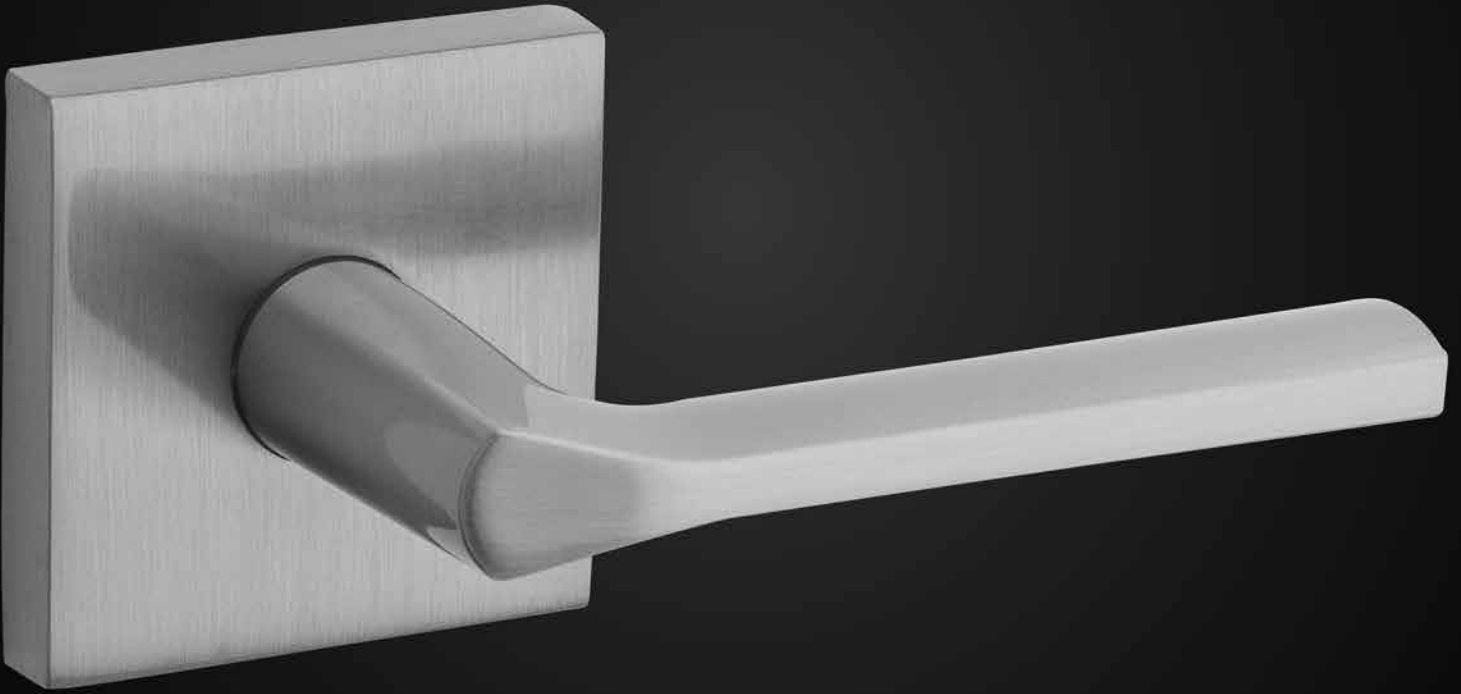

INTRODUCING THE LISBON LEVER

With its unique contour, the Lisbon lever presents a design aesthetic different from the rest. Its geometric shape and thin profile complements any contemporary setting.

- Reversible lever fits both left and right-hand doors.
- Push button feature on privacy and keyed entry.
- ANSI/BHMA Grade 2 Certified



Lisbon Lever in Venetian Bronze

#1 SELLING U.S. LOCK BRAND

Kwikset

Signature Series

Specifications:

Door Prep	Cross Bore 2-1/8". Edge Bore 1". Latch Face 1" x 2-1/4".
Backset	Adjustable to 2-3/8" or 2-3/4".
Door	1-3/8" - 1-3/4" doors standard.
Thickness	2-1/4" doors optional on 720 and 740 models only.
Cylinder	SmartKey®
Faceplates	1" x 2-1/4" Specify round corner, square corner or drive-in.
Strikes	2-1/4" Full lip round corner strike Other options available.
Bolt	1/2" throw.
Door Handing	Reversible for passage, privacy, or entry. Specify handing only with inactive levers.
ANSI/BHMA	Grade 2 Certified.
ADA	Functions 154, 155, 720, 788 satisfy section 4.13.9 ADA requirement.
UL	Optional UL 1/3 hour fire rating for all functions.
Rose	Specify round or square

Functions:



Passage/Hall/Closet: Both levers always free.
- 154 LSL



Privacy/Bed/Bath: Both levers locked or unlocked by turnbutton inside. Outside lever unlocked by emergency key.
- 155 LSL



Keyed Entry Lever: Both sides locked or unlocked by key outside or turnbutton inside.
- 156 LSL SMT



Half Dummy Trim, Surface Mounted: For doors where only a pull is required. No operation.
- 157 LSL



Interior Pack: Outside handleset. Inside lever.
- 966 LSL

Dimensions:

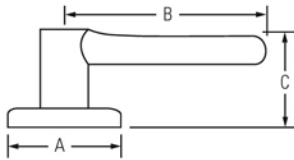

Design	A	B	C	C (Keyed)
Lisbon™	2-10/16"	4-4/16"	2-5/16"	2-13/16"



Lisbon Lever in Venetian Bronze



Finish Availability:



514
Iron
Black

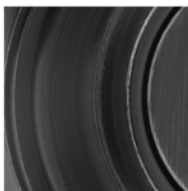

11P
Venetian
Bronze

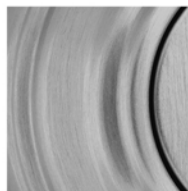

15
Satin
Nickel



26
Polished
Chrome



26D
Brushed
Chrome

Kwikset



UPTOWN™ & DOWNTOWN™

The latest in contemporary design, these deadbolts are the first of their kind, featuring a half-inch projection off the door and the latest version of Kwikset patented SmartKey security.

- 50% Less Protrusion than Standard Deadbolts
- Highest Residential Security Rating: Grade 1
- New Advanced SmartKey Technology
- Perfectly match Kwikset's contemporary product portfolio



Uptown™ in
Venetian Bronze



Downtown™ in
Venetian Bronze

Kwikset

Signature Series

Specifications:

Door Prep	Cross Bore 2-1/8". Edge Bore 1".
Backset	Adjustable to 2-3/8" or 2-3/4" standard.
Door Thickness	1-3/8" - 1-3/4" doors standard. Thick door service part available for up to 2 1/4".
Cylinder	SmartKey™
Faceplates	1" x 2 1/4". Specify round corner, square corner or drive-in.

Strikes	1" x 2 1/4" square or round corner.
Bolt	1" throw.
Door Handing	Reversible for right or left-hand doors.
ANSI/BHMA	Grade 1
UL	20 Minute Fire Rating available upon request.
Warranty	Lifetime Mechanical and Lifetime Finish

Functions:



258 Single Cylinder:

Deadbolt operated by key outside and thumb turn inside.

Dimensions:

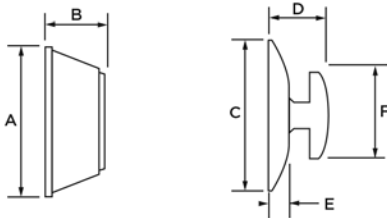

Design	A	B	C	D	E	F
258 SQT	2-5/8"	1/2"	2-5/8"	1-3/8"	7/16"	1-8/13"
258 RDT	2-5/8"	1/2"	2-5/8"	1-7/16"	7/16"	1-11/17"



Uptown™ in Satin Nickel



Downtown™ in Satin Nickel

Finish Availability:



514 Iron Black

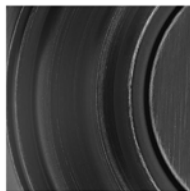

11P Venetian Bronze

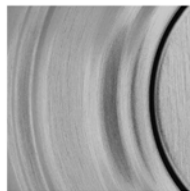

15 Satin Nickel



26 Polished Chrome



26D Satin Chrome

Kwikset

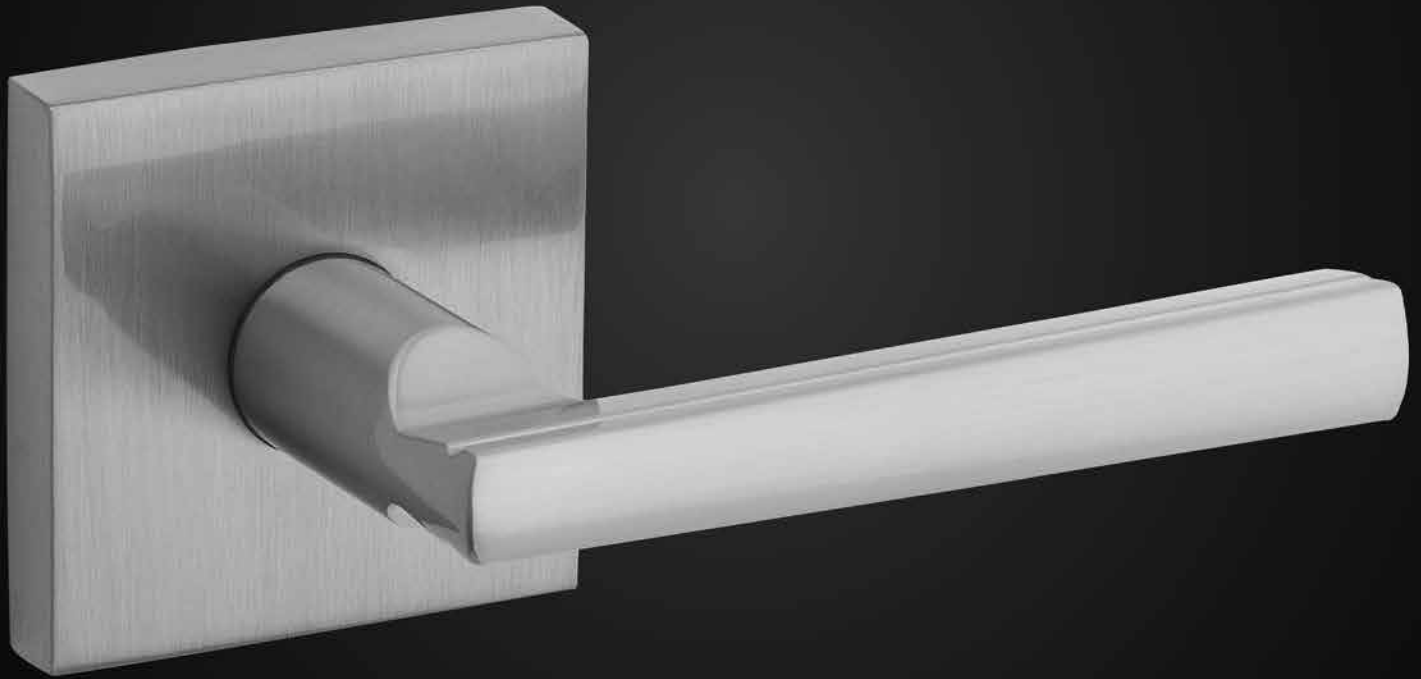

INTRODUCING THE MONTREAL LEVER

The Montreal lever brings a clean style and simple sophistication with its gradual taper and textured linear element. This precision-designed lever complements any modern design theme.

- Reversible lever fits both left and right-hand doors.
- Available with a round or square rose.
- ANSI/BHMA Grade 2 Certified



Montreal Lever in Venetian Bronze

#1 SELLING U.S. LOCK BRAND

Kwikset

Signature Series

Specifications:

Door Prep	Cross Bore 2-1/8". Edge Bore 1". Latch Face 1" x 2-1/4".
Backset	Adjustable to 2-3/8" or 2-3/4".
Door Thickness	1-3/8" - 1-3/4" doors standard. Thick door service part available for up to 2-1/4".
Cylinder	SmartKey®
Faceplates	1" x 2-1/4" Specify round corner, square corner or drive-in.
Strikes	2-1/4" Full lip square or round corner.
Bolt	1/2" throw.
Door Handing	Reversible for right or left handed doors.
ANSI/BHMA	Grade 2 Certified.
ADA	Functions 154, 155, 156 satisfy section 4.13.9 ADA requirement.
UL	20 Min UL fire rating available upon request; passage, privacy and entry functions.
Rose	Specify round or square
Warranty	Lifetime mechanical and lifetime finish

Functions:



Passage/Hall/Closet: Both levers always free.
- 154 MRL



Privacy/Bed/Bath: Both levers locked or unlocked by turnbutton inside. Outside lever unlocked by emergency key.
- 155 MRL



Keyed Entry Lever: Both sides locked or unlocked by key outside or turnbutton inside.
- 156 MRL SMT



Half Dummy Trim, Surface Mounted: For doors where only a pull is required. No operation.
- 157 MRL



Interior Pack: Outside handleset. Inside lever.
- 966 MRL

Dimensions:

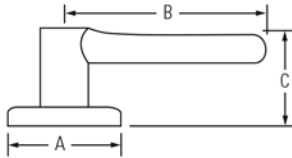

Design	A	B	C	C (Keyed)
Montreal™ Round Rose	2-5/8"	4-1/4"	2-5/8"	2-11/16"
Montreal™ Square Rose	2-5/8"	4-1/4"	2-5/8"	2-11/16"



Montreal Lever in Venetian Bronze



Finish Availability:



514
Iron
Black

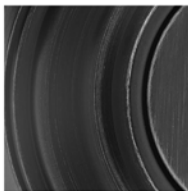

11P
Venetian
Bronze

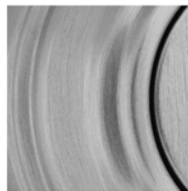

15
Satin
Nickel



26
Polished
Chrome

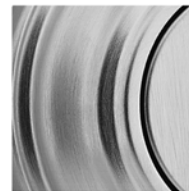

26D
Chrome

Kwikset

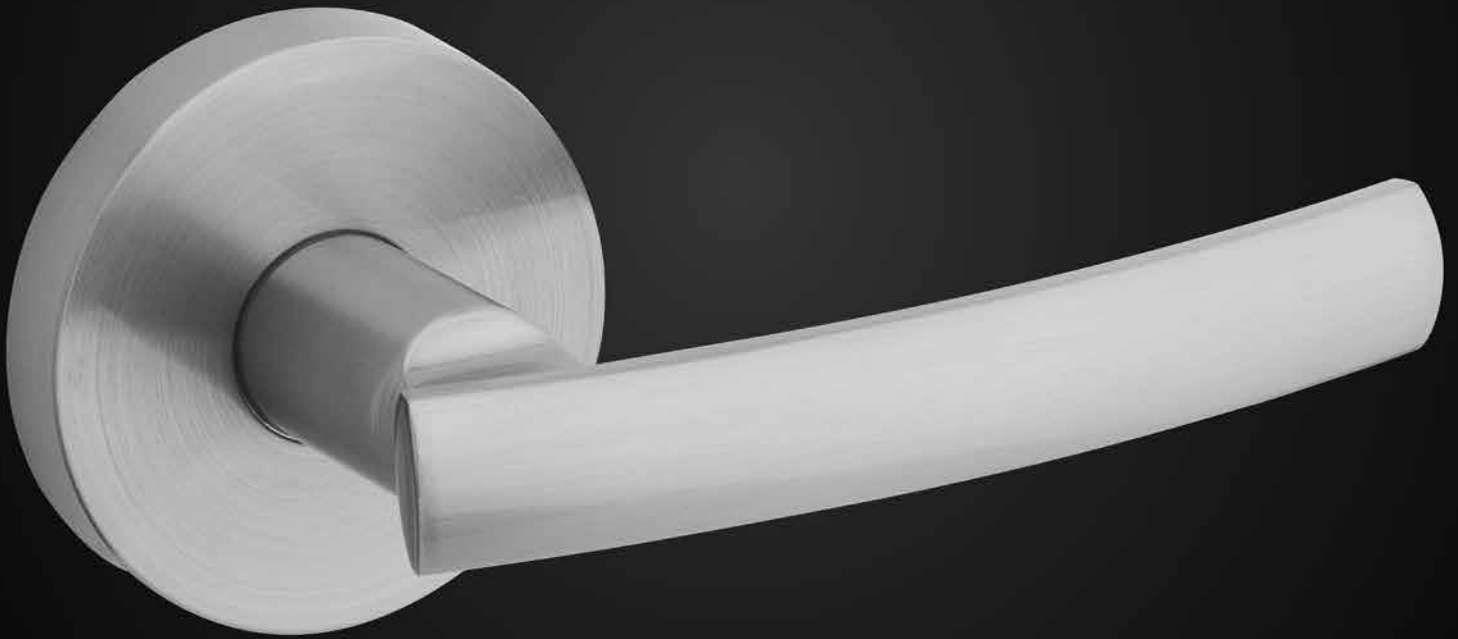

INTRODUCING THE SYDNEY LEVER

The Sydney lever with its soft arch was purposefully-designed for ergonomic comfort without sacrificing style. Its dynamic arched design from cylinder to lever complements both linear and round environments. The graceful curve of the Sydney lever blends well with transitional and contemporary design styles.

- Reversible lever fits both left and right-hand doors.
- Push button feature on privacy and keyed entry.
- ANSI/BHMA Grade 2 Certified



Sydney Lever in Venetian Bronze

#1 SELLING U.S. LOCK BRAND

Kwikset

Signature Series

Specifications:

Door Prep	Cross Bore 2-1/8". Edge Bore 1". Latch Face 1" x 2-1/4".
Backset	Adjustable to 2-3/8" or 2-3/4".
Door Thickness	1-3/8" - 1-3/4" doors standard. Thick door service part available for up to 2-1/4".
Cylinder	SmartKey®
Faceplates	1" x 2-1/4" Specify round corner, square corner or drive-in.
Strikes	2-1/4" Full lip square or round corner.
Bolt	1/2" throw.
Door Handing	Reversible for right or left handed doors.
ANSI/BHMA	Grade 2 Certified.
ADA	Functions 154, 155, 156 satisfy section 4.13.9 ADA requirement.
UL	20 Min UL fire rating available upon request; passage, privacy and entry functions.
Rose	Specify round or square
Warranty	Lifetime mechanical and lifetime finish

Functions:



Passage/Hall/Closet: Both levers always free.
- 154 SYL



Privacy/Bed/Bath: Both levers locked or unlocked by turnbutton inside. Outside lever unlocked by emergency key.
- 155 SYL



Keyed Entry Lever: Both sides locked or unlocked by key outside or turnbutton inside.
- 156 SYL SMT



Half Dummy Trim, Surface Mounted: For doors where only a pull is required. No operation.
- 157 SYL



Interior Pack: Outside handle set. Inside lever.
- 966 SYL

Dimensions:

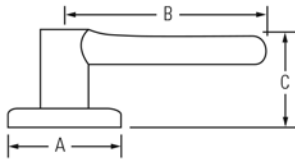

Design	A	B	C	C (Keyed)
Sydney™ Round Rose	2-5/8"	4-1/4"	2-3/4"	2-3/8"
Sydney™ Square Rose	2-5/8"	4-1/4"	2-3/4"	2-3/8"



Sydney Lever in Venetian Bronze



Finish Availability:



514
Iron
Black

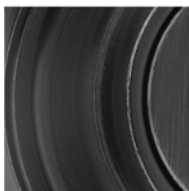

11P
Venetian
Bronze

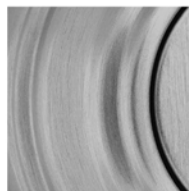

15
Satin
Nickel



26
Polished
Chrome



26D
Satin
Chrome

Kwikset

Signature Series



SUPERIOR SECURITY FEATURES

- ANSI/BHMA Grade 1 Certified 980/985 Deadbolt
- SmartKey® Re-Key Technology with BumpGuard™ Technology to Protect Against Lock Bumping*

ELEGANT STYLES AND FINISHES

- Unique Rustic Finishes
- Traditional to Contemporary Styles

WARRANTY

- Lifetime Mechanical
- Lifetime Finish

*Lock Bumping - an attack technique using specially cut keys that can defeat conventional pin & tumbler locks.

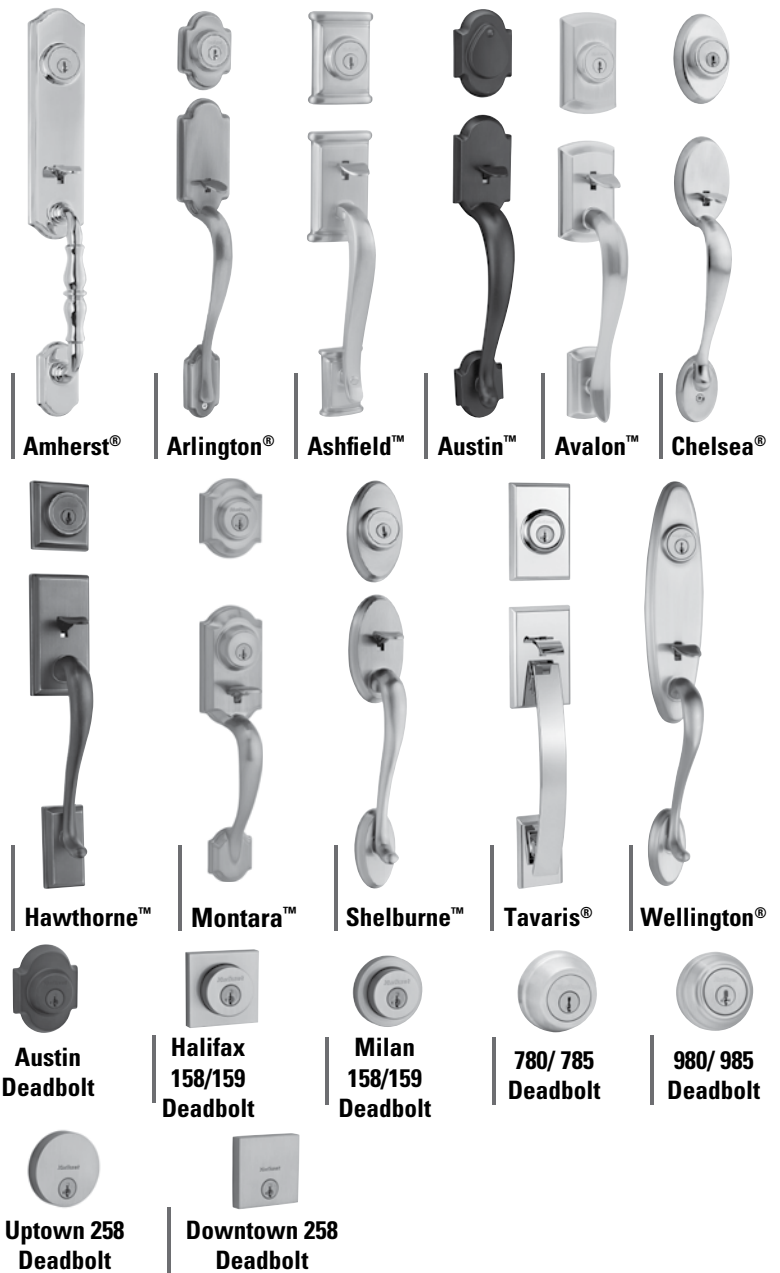

Kwikset

Signature Series

Amherst®



Montara™



Wellington®



Amherst®	Model	Function	Finish								Case		
			3	L03	5	11P	15	15A	26	26D	514	Qty	
800AT	Single Cylinder					\$273.00	\$273.00						4
800AT SMT	Single Cylinder					\$273.00	\$273.00						4
801AT	Double Cylinder					\$278.00	\$278.00						4
801AT SMT	Double Cylinder					\$278.00	\$278.00						4
802AT	Dummy					\$246.00	\$246.00						4

Montara™	Model	Function	Finish								Case		
			3	L03	5	11P	15	15A	26	26D	514	Qty	
553MNH SMT	Single Cylinder		\$253.00			\$273.00	\$273.00						4
554MNH SMT	Double Cylinder		\$258.00			\$278.00	\$278.00						4

Wellington®	Model	Function	Finish								Case		
			3	L03	5	11P	15	15A	26	26D	514	Qty	
800WN	Single Cylinder					\$273.00	\$273.00						4
800WN SMT	Single Cylinder					\$273.00	\$273.00						4
801WN	Double Cylinder					\$278.00	\$278.00						4
801WN SMT	Double Cylinder					\$278.00	\$278.00						4
802WN	Dummy					\$246.00	\$246.00						4

NOTE: Handlesets ordered LIP only

Kwikset

Signature Series

Ashfield™



Austin™



Avalon™



Tavaris®



Ashfield™

Model	Function	Finish									Case
		3	L03	5	11P	15	15A	26	26D	514	Qty
800ADH SMT	Single Cylinder		\$254.00	\$254.00	\$254.00	\$254.00		\$254.00		\$264.00	4
801ADH SMT	Double Cylinder		\$259.00	\$259.00	\$259.00	\$259.00		\$259.00		\$269.00	4
802ADH	Dummy		\$227.00	\$227.00	\$227.00	\$227.00		\$227.00		\$237.00	4

Austin™

Model	Function	Finish									Case
		3	L03	5	11P	15	15A	26	26D	514	Qty
800AUH SMT	Single Cylinder				\$254.00	\$254.00					4
801AUH SMT	Double Cylinder				\$259.00	\$259.00					4
802AUH	Dummy				\$227.00	\$227.00					4

Avalon™

Model	Function	Finish									Case
		3	L03	5	11P	15	15A	26	26D	514	Qty
800AVH SMT	Single Cylinder				\$254.00	\$254.00		\$254.00		\$264.00	4
801AVH SMT	Double Cylinder				\$259.00	\$259.00		\$259.00		\$269.00	4
802AVH	Dummy				\$227.00	\$227.00		\$227.00		\$237.00	4

Tavaris®

Model	Function	Finish									Case
		3	L03	5	11P	15	15A	26	26D	514	Qty
800TVH SMT	Single Cylinder				\$254.00	\$254.00		\$254.00	\$254.00		4
801TVH SMT	Double Cylinder				\$259.00	\$259.00		\$259.00	\$259.00		4
802TVH	Dummy				\$227.00	\$227.00		\$227.00	\$227.00		4
815TVH	Handleset* with Verdani Lever				\$277.00	\$277.00		\$277.00	\$277.00		4
815TVH	Handleset* with Katara Lever				\$277.00	\$277.00		\$277.00	\$277.00		4

*Denotes handleset without deadbolt

Kwikset

Signature Series

Hawthorne™



Shelburne™



Hawthorne™	Model	Function	Finish							Case		
			3	L03	5	11P	15	15A	26	26D	514	Qty
	800HE	Single Cylinder				\$230.00	\$230.00	\$230.00			\$240.00	4
	800HR SMT	Single Cylinder				\$230.00	\$230.00	\$230.00			\$240.00	4
	801HE	Double Cylinder				\$235.00	\$235.00	\$235.00			\$245.00	4
	801HE SMT	Double Cylinder				\$235.00	\$235.00	\$235.00			\$245.00	4
	802HE	Dummy				\$203.00	\$203.00	\$203.00			\$213.00	4

Shelburne™	Model	Function	Finish							Case		
			3	L03	5	11P	15	15A	26	26D	514	Qty
	800SE	Single Cylinder		\$230.00		\$230.00	\$230.00					4
	800SE SMT	Single Cylinder		\$230.00		\$230.00	\$230.00					4
	801SE	Double Cylinder		\$235.00		\$235.00	\$235.00					4
	801SE SMT	Double Cylinder		\$235.00		\$235.00	\$235.00					4
	802SE	Dummy		\$203.00		\$203.00	\$203.00					4

NOTE: Handlesets ordered LIP only

Kwikset

Signature Series

Arlington®



Chelsea®



Arlington®	Model	Function	Finish								Case		
			3	L03	5	11P	15	15A	26	26D	514	Qty	
	800AN	Single Cylinder	\$171.00	\$191.00	\$191.00	\$191.00	\$191.00	\$191.00					6
	800AN SMT	Single Cylinder	\$171.00	\$191.00	\$191.00	\$191.00	\$191.00	\$191.00					6
	801AN	Double Cylinder	\$176.00	\$196.00	\$196.00	\$196.00	\$196.00	\$196.00					6
	801AN SMT	Double Cylinder	\$176.00	\$196.00	\$196.00	\$196.00	\$196.00	\$196.00					6
	802AN	Dummy	\$144.00	\$164.00	\$164.00	\$164.00	\$164.00	\$164.00					6
	815AN	Handleset* with Tustin		\$214.00		\$214.00	\$214.00						6
	815AN	Handleset* with Hancock		\$209.00		\$209.00	\$209.00						6

Chelsea®	Model	Function	Finish								Case		
			3	L03	5	11P	15	15A	26	26D	514	Qty	
	800CE	Single Cylinder	\$171.00	\$191.00	\$191.00	\$191.00	\$191.00	\$191.00	\$191.00	\$191.00			6
	800CE SMT	Single Cylinder	\$171.00	\$191.00	\$191.00	\$191.00	\$191.00	\$191.00	\$191.00	\$191.00			6
	801CE	Double Cylinder	\$176.00	\$196.00	\$196.00	\$196.00	\$196.00	\$196.00	\$196.00	\$196.00			6
	801CE SMT	Double Cylinder	\$176.00	\$196.00	\$196.00	\$196.00	\$196.00	\$196.00	\$196.00	\$196.00			6
	802CE	Dummy	\$144.00	\$164.00	\$164.00	\$164.00	\$164.00	\$164.00	\$164.00	\$164.00			6
	815CE	Handleset* with Tustin		\$214.00		\$214.00	\$214.00						6
	815CE	Handleset* with Hancock		\$209.00		\$209.00	\$209.00						6

INTERIOR PACKS FOR TRADITIONAL 800/801/802 HANDLESETS

Model	Function	Series			
		Signature Lever & Laurel	Signature Knob	Kwikset Lever	Kwikset Knob
966	Single Cylinder	\$62.00	\$51.00	\$56.00	\$45.00
967	Double Cylinder	\$84.00	\$73.00	\$73.00	\$62.00
967 SMT	Double Cylinder	\$84.00	\$73.00	\$73.00	\$62.00
968	Dummy	\$51.00	\$40.00	\$46.00	\$35.00

Handleset Interior Pack Finish Options		3	L03	5	11P	15	15A	26	26D	514	Qty
Kwikset <i>Signature Series</i>	Abbey Knob	•		•					•		4
	Ashfield Lever				•	•		•		•	12
	Avalon Lever				•	•		•		•	12
	Brooklane Lever				•	•	•				4
	Cameron Knob	•			•	•					4
	Circa Knob	•			•	•	•	•	•		4
	Commonwealth Lever	•		•	•	•	•	•	•	•	4
	Hancock Knob	•		•	•	•	•	•	•	•	4
	Halifax Lever				•	•		•	•	•	12
	Laurel Knob				•	•	•	•		•	4
	Lido Lever	•		•	•	•	•		•		4
	Libson Lever				•	•		•	•	•	12
	Milan Lever				•	•		•	•	•	12
	Montreal Lever				•	•		•	•	•	12
	Pembroke Lever	•		•	•	•	•	•		•	12
	Phoenix Knob	•		•	•	•					4
	Sydney Lever				•	•		•	•	•	12
Tustin Lever	•		•	•	•	•	•	•	•	12	
Kwikset	Aliso Knob	•			•	•		•			12
	Balboa Lever	•		•	•	•		•	•		4
	Cove Knob	•		•	•	•		•	•		4
	Delta Lever	•		•			•	•	•		12
	Dorian Lever	•		•	•	•	•	•	•		12
	Polo Knob	•		•	•	•	•	•	•		4
	Tylo Knob	•		•		•		•	•		12

AUSTIN INTERIOR PACKS

Model	Function	Finish									
		3	L03	5	11P	15	15A	26	26D	514	Qty
Interior Packs - All Keyed handlesets below have SmartKey only											
966AUL	Single Cylinder Interior Pack				\$65.00	\$65.00					12
967AUL SMT	Double Cylinder Interior Pack				\$87.00	\$87.00					12
968AUL	Dummy Interior Pack				\$54.00	\$54.00					12

CONTEMPORARY INTERIOR PACKS

Model	Function	Series			
		Signature Lever	Signature Knob	Kwikset Lever	Kwikset Knob
974	Single Cylinder	\$62.00			
976 SMT	Double Cylinder	\$84.00			
977	Dummy	\$51.00			

Handleset Interior Pack Finish Options	3	L03	5	11P	15	15A	26	26D	514	Qty
Kwikset Katara Lever				•	•		•	•		12
<i>Signature Series</i> Verdani Lever				•	•		•	•		12

NOTE: 966, 968, 974 and 977 are not impacted by SmartKey cylinder.

MONTARA INTERIOR PACKS

Model	Function	Series			
		Signature Lever & Laurel	Signature Knob	Kwikset Lever	Kwikset Knob
978	Single Cylinder	\$65.00	\$54.00		\$47.00
979 SMT	Double Cylinder	\$87.00	\$76.00		\$64.00

Montara Handleset Interior Pack Finish Options	3	L03	5	11P	15	15A	26	26D	514	Qty
Kwikset Cameron Knob				•	•					4
<i>Signature Series</i> Circa Knob				•	•					4
June Knob				•	•					4
Lido Lever				•	•					4
Tustin Lever				•	•					12
Kwikset Cove Knob				•	•					4
Polo Knob				•	•					4
Tylo Knob				•	•					12

Kwikset

Signature Series

Ashfield™



Model	Function	Finish										Case Qty
		3	L03	5	11P	15	15A	26	26D	514		
720ADL	Hall/Closet				\$60.00	\$60.00		\$60.00		\$63.00	12	
725ADL	Hall/Closet UL				\$66.00	\$66.00		\$66.00		\$69.00	12	
730ADL	Bed/Bath				\$63.00	\$63.00		\$63.00		\$66.00	12	
735ADL	Bed/Bath UL				\$69.00	\$69.00		\$69.00		\$72.00	12	
740ADL SMT	Entry				\$104.00	\$104.00		\$104.00		\$107.00	12	
745ADL SMT	Entry UL				\$110.00	\$110.00		\$110.00		\$113.00	12	
788ADL	Half Dummy				\$30.00	\$30.00		\$30.00		\$31.50	20	

Austin



Model	Function	Finish										Case Qty
		3	L03	5	11P	15	15A	26	26D	514		
730AUL	Passage				\$60.00	\$60.00					12	
730AUL	Privacy				\$63.00	\$63.00					12	
740AUL SMT	Entry				\$104.00	\$104.00					12	
788AUL	Dummy				\$30.00	\$30.00					12	

Avalon™



Model	Function	Finish										Case Qty
		3	L03	5	11P	15	15A	26	26D	514		
720AVL	Hall/Closet				\$60.00	\$60.00		\$60.00		\$63.00	12	
725AVL	Hall/Closet UL				\$66.00	\$66.00		\$66.00		\$69.00	12	
730AVL	Bed/Bath				\$63.00	\$63.00		\$63.00		\$66.00	12	
735AVL	Bed/Bath UL				\$69.00	\$69.00		\$69.00		\$72.00	12	
740AVL SMT	Entry				\$104.00	\$104.00		\$104.00		\$107.00	12	
745AVL SMT	Entry UL				\$110.00	\$110.00		\$110.00		\$113.00	12	
788AVL	Half Dummy				\$30.00	\$30.00		\$30.00		\$31.50	20	

Brooklane®



Model	Function	Finish										Case Qty
		3	L03	5	11P	15	15A	26	26D	514		
720BRL	Hall/Closet				\$60.00	\$60.00	\$60.00				12	
725BRL	Hall/Closet UL				\$66.00	\$66.00	\$66.00				12	
730BRL	Bed/Bath				\$63.00	\$63.00	\$63.00				12	
735BRL	Bed/Bath UL				\$69.00	\$69.00	\$69.00				12	
740BRL SMT	Entry				\$104.00	\$104.00	\$104.00				12	
745BRL SMT	Entry UL				\$110.00	\$110.00	\$110.00				12	
788BRL	Half Dummy				\$30.00	\$30.00	\$30.00				20	

Pembroke™





Model	Function	Finish										Case Qty
		3	L03	5	11P	15	15A	26	26D	514		
720PML	Hall/Closet	\$55.00	\$60.00	\$60.00	\$60.00	\$60.00	\$60.00	\$60.00		\$63.00	12	
725PML	Hall/Closet UL	\$61.00	\$66.00	\$66.00	\$66.00	\$66.00	\$66.00	\$66.00		\$69.00	12	
730PML	Bed/Bath	\$58.00	\$63.00	\$63.00	\$63.00	\$63.00	\$63.00	\$63.00		\$66.00	12	
735PML	Bed/Bath UL	\$64.00	\$69.00	\$69.00	\$69.00	\$69.00	\$69.00	\$69.00		\$72.00	12	
740PML SMT	Entry	\$99.00	\$104.00	\$104.00	\$104.00	\$104.00	\$104.00	\$104.00		\$107.00	12	
745PML SMT	Entry UL	\$105.00	\$110.00	\$110.00	\$110.00	\$110.00	\$110.00	\$110.00		\$113.00	12	
788PML	Half Dummy	\$27.50		\$30.00	\$30.00	\$30.00	\$30.00	\$30.00		\$31.50	20	

Kwikset

Signature Series

Commonwealth®	Model	Function	Finish								Case	
			3	L03	5	11P	15	15A	26	26D	514	Qty
	720CHL	Hall/Closet	\$49.00	\$54.00	\$54.00	\$54.00	\$54.00	\$54.00	\$54.00	\$54.00	\$57.00	12
	720CHL	Hall/Closet UL	\$55.00	\$60.00	\$60.00	\$60.00	\$60.00	\$60.00	\$60.00	\$60.00	\$63.00	12
	730CHL	Bed/Bath	\$52.00		\$57.00	\$57.00	\$57.00	\$57.00	\$57.00	\$57.00	\$60.00	12
	735CHL	Bed/Bath UL	\$58.00		\$63.00	\$63.00	\$63.00	\$63.00	\$63.00	\$63.00	\$66.00	12
	740CHL	Entry	\$93.00	\$98.00	\$98.00	\$98.00	\$98.00	\$98.00	\$98.00	\$98.00	\$101.00	12
	740CHL SMT	Entry	\$93.00	\$98.00	\$98.00	\$98.00	\$98.00	\$98.00	\$98.00	\$98.00	\$101.00	12
	745CHL	Entry UL	\$99.00	\$104.00	\$104.00	\$104.00	\$104.00	\$104.00	\$104.00	\$104.00	\$107.00	12
	745CHL SMT	Entry UL	\$99.00	\$104.00	\$104.00	\$104.00	\$104.00	\$104.00	\$104.00	\$104.00	\$107.00	12
	788CHL	Half Dummy	\$24.50		\$27.00	\$27.00	\$27.00	\$27.00	\$27.00	\$27.00	\$28.50	20

Katara®	Model	Function	Finish								Case	
			3	L03	5	11P	15	15A	26	26D	514	Qty
	720KTL	Hall/Closet				\$54.00	\$57.00		\$57.00	\$57.00		12
	730KTL	Bed/Bath				\$57.00	\$57.00		\$57.00	\$57.00		12
	740KTL SMT	Entry				\$98.00	\$98.00		\$98.00	\$98.00		12
	745KTL SMT	Entry UL				\$104.00	\$104.00		\$104.00	\$104.00		12
	788KTL	Half Dummy				\$27.00	\$27.00		\$27.00	\$27.00		20

Verdani®	Model	Function	Finish								Case	
			3	L03	5	11P	15	15A	26	26D	514	Qty
	720VDL	Hall/Closet				\$54.00	\$54.00		\$54.00	\$54.00		12
	730VDL	Bed/Bath				\$57.00	\$57.00		\$57.00	\$57.00		12
	740VDL SMT	Entry				\$98.00	\$98.00		\$98.00	\$98.00		12
	745VDL SMT	Entry UL				\$104.00	\$104.00		\$104.00	\$104.00		12
	788VDL	Half Dummy				\$27.00	\$27.00		\$27.00	\$27.00		12

Halifax™	Model	Function	Finish								NEW!	Case
			3	L03	5	11P	15	15A	26	26D	514	Qty
	154HFL	Hall/Closet				\$50.00	\$50.00		\$50.00	\$50.00	\$53.00	12
	155HFL	Bed/Bath				\$53.00	\$53.00		\$53.00	\$53.00	\$56.00	12
	156HFL SMT	Entry				\$94.00	\$94.00		\$94.00	\$94.00	\$97.00	12
	157HFL	Half Dummy				\$25.00	\$25.00		\$25.00	\$25.00	\$26.50	20

NOTE: Can be ordered with (RDT) Round Rose or (SQT) Square Rose option. Example - 154HFL RDT 11P

Libson	Model	Function	Finish								Case	
			3	L03	5	11P	15	15A	26	26D	514	Qty
 NEW!	154LSL	Half/Closet				\$50.00	\$50.00		\$50.00	\$50.00	\$53.00	12
	155LSL	Bed/Bath				\$53.00	\$53.00		\$53.00	\$53.00	\$56.00	12
	156LSL SMT	Entry				\$94.00	\$94.00		\$94.00	\$94.00	\$97.00	12
	157LSL	Half Dummy				\$25.00	\$25.00		\$25.00	\$25.00	\$26.50	20

NOTE: Can be ordered with (RDT) Round Rose or (SQT) Square Rose option. Example - 154LSL RDT 11P

Milan™	Model	Function	Finish								NEW!	Case
			3	L03	5	11P	15	15A	26	26D	514	Qty
	154MIL	Half/Closet				\$50.00	\$50.00		\$50.00	\$50.00	\$53.00	12
	155MIL	Bed/Bath				\$53.00	\$53.00		\$53.00	\$53.00	\$56.00	12
	156MIL SMT	Entry				\$94.00	\$94.00		\$94.00	\$94.00	\$97.00	12
	157MIL	Half Dummy				\$25.00	\$25.00		\$25.00	\$25.00	\$26.50	20

NOTE: Can be ordered with (RDT) Round Rose or (SQT) Square Rose option. Example - 154MIL SQT 11P

Montreal	Model	Function	Finish								Case	
			3	L03	5	11P	15	15A	26	26D	514	Qty
 NEW!	154MRL	Hall/Closet				\$50.00	\$50.00		\$50.00	\$50.00	\$53.00	12
	155MRL	Bed/Bath				\$53.00	\$53.00		\$53.00	\$53.00	\$56.00	12
	156MRL SMT	Entry				\$94.00	\$94.00		\$94.00	\$94.00	\$97.00	12
	157MRL	Half Dummy				\$25.00	\$25.00		\$25.00	\$25.00	\$26.50	20

NOTE: Can be ordered with (RDT) Round Rose or (SQT) Square Rose option. Example - 154MRL RDT 11P

Kwikset

Signature Series

Sydney®



NEW!

Model	Function	Finish									Case
		3	L03	5	11P	15	15A	26	26D	514	Qty
154SYL	Half/Closet				\$50.00	\$50.00		\$50.00	\$50.00	\$53.00	12
155SYL	Bed/Bath				\$53.00	\$53.00		\$53.00	\$53.00	\$56.00	12
156SYL SMT	Entry				\$94.00	\$94.00		\$94.00	\$94.00	\$97.00	12
157SYL	Half Dummy				\$25.00	\$25.00		\$25.00	\$25.00	\$26.50	20

NOTE: Can be ordered with (RDT) Round Rose or (SQT) Square Rose option. Example - 154SYL RDT 11P

Lido®



Model	Function	Finish									Case
		3	L03	5	11P	15	15A	26	26D	514	Qty
720LL	Half/Closet	\$39.00		\$44.00	\$44.00	\$44.00	\$44.00		\$44.00		20
725LL	Half/Closet UL	\$45.00		\$50.00	\$50.00	\$50.00	\$50.00		\$50.00		20
730LL	Bed/Bath	\$42.00		\$47.00	\$47.00	\$47.00	\$47.00		\$47.00		20
735LL	Bed/Bath UL	\$48.00		\$53.00	\$53.00	\$53.00	\$53.00		\$53.00		20
740LL	Entry	\$63.00		\$68.00	\$68.00	\$68.00	\$68.00		\$68.00		20
740LL SMT	Entry	\$63.00		\$68.00	\$68.00	\$68.00	\$68.00		\$68.00		20
741LL	Entry, Free Interior	\$68.00		\$73.00	\$73.00	\$73.00	\$73.00		\$73.00		20
741LL SMT	Entry, Free Interior	\$68.00		\$73.00	\$73.00	\$73.00	\$73.00		\$73.00		20
745LL	Entry UL	\$69.00		\$74.00	\$74.00	\$74.00	\$74.00		\$74.00		20
745LL SMT	Entry UL	\$69.00		\$74.00	\$74.00	\$74.00	\$74.00		\$74.00		20
746LL	Entry, Free Interior UL	\$74.00		\$79.00	\$79.00	\$79.00	\$79.00		\$79.00		20
746LL SMT	Entry, Free Interior UL	\$74.00		\$79.00	\$79.00	\$79.00	\$79.00		\$79.00		20
750LL	Vestibule	\$68.00		\$73.00	\$73.00	\$73.00	\$73.00		\$73.00		20
750LL SMT	Vestibule	\$68.00		\$73.00	\$73.00	\$73.00	\$73.00		\$73.00		20
755LL	Vestibule UL	\$74.00		\$79.00	\$79.00	\$79.00	\$79.00		\$79.00		20
755LL SMT	Vestibule UL	\$74.00		\$79.00	\$79.00	\$79.00	\$79.00		\$79.00		20
788LL	Half Dummy	\$19.50		\$22.00	\$22.00	\$22.00	\$22.00		\$22.00		20

Tustin™



Model	Function	Finish									Case
		3	L03	5	11P	15	15A	26	26D	514	Qty
720TNL	Half/Closet	\$39.00		\$44.00	\$44.00	\$44.00	\$44.00	\$44.00	\$44.00	\$47.00	20
725TNL	Half/Closet UL	\$45.00		\$50.00	\$50.00	\$50.00	\$50.00	\$50.00	\$50.00	\$53.00	20
730TNL	Bed/Bath	\$42.00		\$47.00	\$47.00	\$47.00	\$47.00	\$47.00	\$47.00	\$50.00	20
735TNL	Bed/Bath UL	\$48.00		\$53.00	\$53.00	\$53.00	\$53.00	\$53.00	\$53.00	\$56.00	20
740TNL	Entry			\$68.00	\$68.00	\$68.00	\$68.00	\$68.00	\$68.00		20
740TNL SMT	Entry	\$63.00		\$68.00	\$68.00	\$68.00	\$68.00	\$68.00	\$68.00	\$71.00	20
741TNL	Entry, Free Interior	\$68.00		\$73.00	\$73.00	\$73.00	\$73.00	\$73.00	\$73.00		20
741TNL SMT	Entry, Free Interior	\$68.00		\$73.00	\$73.00	\$73.00	\$73.00	\$73.00	\$73.00	\$76.00	20
745TNL	Entry UL	\$69.00		\$74.00	\$74.00	\$74.00	\$74.00	\$74.00	\$74.00		20
745TNL SMT	Entry UL	\$69.00		\$74.00	\$74.00	\$74.00	\$74.00	\$74.00	\$74.00	\$77.00	20
746TNL	Entry, Free Interior UL	\$74.00		\$79.00	\$79.00	\$79.00	\$79.00	\$79.00	\$79.00		20
746TNL SMT	Entry, Free Interior UL	\$74.00		\$79.00	\$79.00	\$79.00	\$79.00	\$79.00	\$79.00	\$82.00	20
750TNL	Vestibule	\$68.00		\$73.00	\$73.00	\$73.00	\$73.00	\$73.00	\$73.00		20
750TNL SMT	Vestibule	\$68.00		\$73.00	\$73.00	\$73.00	\$73.00	\$73.00	\$73.00		20
755TNL	Vestibule UL	\$74.00		\$79.00	\$79.00	\$79.00	\$79.00	\$79.00	\$79.00		20
755TNL SMT	Vestibule UL	\$74.00		\$79.00	\$79.00	\$79.00	\$79.00	\$79.00	\$79.00		20
788TNL	Half Dummy	\$19.50		\$22.00	\$22.00	\$22.00	\$22.00	\$22.00	\$22.00	\$27.50	20
490TNL	Fully, Dummy, Keyed Profile Lever	\$37.00		\$42.00	\$42.00	\$42.00	\$42.00	\$42.00	\$42.00		20

Kwikset

Signature Series

Laurel®



Model	Function	Finish									Case
		3	L03	5	11P	15	15A	26	26D	514	Qty
720L	Hall/Closet				\$51.00	\$51.00	\$51.00	\$51.00		\$54.00	12
730L	Bed/Bath				\$54.00	\$54.00	\$54.00	\$54.00		\$57.00	12
740L SMT	Entry				\$76.00	\$76.00	\$76.00	\$76.00		\$79.00	12
788L	Half Dummy				\$25.50	\$25.50	\$25.50	\$25.50		\$27.00	20

Circa®



Model	Function	Finish									Case
		3	L03	5	11P	15	15A	26	26D	514	Qty
720CA	Hall/Closet	\$34.00			\$39.00	\$39.00	\$39.00	\$39.00	\$39.00		12
725CA	Hall/Closet UL	\$40.00			\$45.00	\$45.00	\$45.00	\$45.00	\$45.00		12
730CA	Bed/Bath	\$37.00			\$42.00	\$42.00	\$42.00	\$42.00	\$42.00		12
735CA	Bed/Bath UL	\$43.00			\$48.00	\$48.00	\$48.00	\$48.00	\$48.00		12
740CA SMT	Entry	\$59.00			\$64.00	\$64.00	\$64.00	\$64.00	\$64.00		12
741CA SMT	Entry, Free Interior	\$62.00			\$69.00				\$69.00		12
745CA SMT	Entry UL	\$65.00			\$70.00	\$70.00	\$70.00	\$70.00	\$70.00		12
746CA SMT	Entry, Free Interior UL	\$70.00			\$75.00				\$75.00		12
750CA SMT	Vestibule	\$64.00			\$69.00				\$69.00		12
755CA SMT	Vestibule UL	\$70.00			\$75.00				\$75.00		12
788CA	Half Dummy	\$17.00			\$19.50	\$19.50	\$19.50	\$19.50	\$19.50		20

Hancock®



Model	Function	Finish									Case
		3	L03	5	11P	15	15A	26	26D	514	Qty
720H	Hall/Closet	\$26.00	\$31.00	\$31.00	\$31.00	\$31.00	\$31.00	\$31.00	\$31.00	\$34.00	12
725H	Hall/Closet UL	\$32.00	\$37.00	\$37.00	\$37.00	\$37.00	\$37.00	\$37.00	\$37.00	\$40.00	12
730H	Bed/Bath	\$29.00		\$34.00	\$34.00	\$34.00	\$34.00	\$34.00	\$34.00	\$37.00	12
735H	Bed/Bath UL	\$35.00		\$40.00	\$40.00	\$40.00	\$40.00	\$40.00	\$40.00	\$43.00	12
740H	Entry	\$51.00	\$56.00	\$56.00	\$56.00	\$56.00	\$56.00	\$56.00	\$56.00	\$59.00	12
740H SMT	Entry	\$51.00	\$56.00	\$56.00	\$56.00	\$56.00	\$56.00	\$56.00	\$56.00	\$59.00	12
741H	Entry, Free Interior	\$56.00	\$61.00	\$61.00	\$61.00	\$61.00	\$61.00	\$61.00	\$61.00	\$64.00	12
741H SMT	Entry, Free Interior	\$56.00	\$61.00	\$61.00	\$61.00	\$61.00	\$61.00	\$61.00	\$61.00	\$64.00	12
745H	Entry UL	\$57.00	\$62.00	\$62.00	\$62.00	\$62.00	\$62.00	\$62.00	\$62.00	\$65.00	12
745H SMT	Entry UL	\$57.00	\$62.00	\$62.00	\$62.00	\$62.00	\$62.00	\$62.00	\$62.00	\$65.00	12
746H	Entry, Free Interior UL	\$62.00	\$67.00	\$67.00	\$67.00	\$67.00	\$67.00	\$67.00	\$67.00		12
746H SMT	Entry, Free Interior UL	\$62.00	\$67.00	\$67.00	\$67.00	\$67.00	\$67.00	\$67.00	\$67.00		12
750H	Vestibule	\$56.00	\$61.00	\$61.00	\$61.00	\$61.00	\$61.00	\$61.00	\$61.00	\$64.00	12
750H SMT	Vestibule	\$56.00	\$61.00	\$61.00	\$61.00	\$61.00	\$61.00	\$61.00	\$61.00	\$64.00	12
755H	Vestibule UL	\$62.00	\$67.00	\$67.00	\$67.00	\$67.00	\$67.00	\$67.00	\$67.00	\$70.00	12
755H SMT	Vestibule UL	\$62.00	\$67.00	\$67.00	\$67.00	\$67.00	\$67.00	\$67.00	\$67.00	\$70.00	12
788H	Half Dummy	\$13.00	\$15.50	\$15.50	\$15.50	\$15.50	\$15.50	\$15.50	\$15.50	\$17.00	20

Phoenix®



Model	Function	Finish									Case
		3	L03	5	11P	15	15A	26	26D	514	Qty
720PE	Hall/Closet	\$26.00		\$31.00	\$31.00	\$31.00					12
730PE	Bed/Bath	\$29.00		\$34.00	\$34.00	\$34.00					12
740PE SMT	Entry	\$51.00		\$56.00	\$56.00	\$56.00					12
788PE	Half Dummy	\$13.00		\$15.50	\$15.50	\$15.50					20

Kwikset

Signature Series

Abbey®



Model	Function	Finish									Case Qty
		3	L03	5	11P	15	15A	26	26D	514	
720A	Hall/Closet	\$24.00		\$29.00					\$29.00		12
725A	Hall/Closet UL	\$30.00		\$35.00					\$35.00		12
730A	Bed/Bath	\$27.00		\$32.00					\$32.00		12
735A	Bed/Bath UL	\$33.00		\$38.00					\$38.00		12
740A	Entry	\$49.00		\$54.00					\$54.00		12
740A SMT	Entry	\$49.00		\$54.00					\$54.00		12
741A	Entry, Free Interior	\$54.00		\$59.00					\$59.00		12
741A SMT	Entry, Free Interior	\$54.00		\$59.00					\$59.00		12
745A	Entry UL	\$55.00		\$60.00					\$60.00		12
745A SMT	Entry UL	\$55.00		\$60.00					\$60.00		12
746A	Entry, Free Interior UL	\$60.00		\$65.00					\$65.00		12
746A SMT	Entry, Free Interior UL	\$60.00		\$65.00					\$65.00		12
750A	Vestibule	\$54.00		\$59.00					\$59.00		12
750A SMT	Vestibule	\$54.00		\$59.00					\$59.00		12
755A	Vestibule UL	\$60.00		\$65.00					\$65.00		12
755A SMT	Vestibule UL	\$60.00		\$65.00					\$65.00		12
788A	Half Dummy	\$12.00		\$14.50					\$14.50		20

Cameron®



Model	Function	Finish									Case Qty
		3	L03	5	11P	15	15A	26	26D	514	
720CN	Hall/Closet	\$24.00			\$29.00	\$29.00					30
730CN	Bed/Bath	\$27.00			\$32.00	\$32.00					30
740CN	Entry	\$49.00			\$54.00	\$54.00					30
740CN SMT	Entry	\$49.00			\$54.00	\$54.00					30
741CN	Entry, Free Interior	\$54.00			\$59.00	\$59.00					30
741CN SMT	Entry, Free Interior	\$54.00			\$59.00	\$59.00					30
750CN	Vestibule	\$54.00			\$59.00	\$59.00					30
750CN SMT	Vestibule	\$54.00			\$59.00	\$59.00					30
788CN	Half Dummy	\$12.00			\$14.50	\$14.50					20

980/985

	Model	Function	Finish								Case Qty	
			3	L03	5	11P	15	15A	26	26D		514
	980	Single Cylinder		\$65.00	\$65.00	\$65.00	\$65.00			\$65.00	\$68.00	12
	980 SMT	Single Cylinder	\$57.00	\$65.00	\$65.00	\$65.00	\$65.00			\$65.00	\$68.00	12
	982	Single Cylinder UL		\$71.00	\$71.00	\$71.00	\$71.00			\$71.00	\$74.00	12
	982 SMT	Single Cylinder UL	\$63.00	\$71.00	\$71.00	\$71.00	\$71.00			\$71.00	\$74.00	12
	984	Double Cylinder UL		\$96.00	\$96.00	\$96.00	\$96.00			\$96.00	\$99.00	12
	984 SMT	Double Cylinder UL	\$88.00	\$96.00	\$96.00	\$96.00	\$96.00			\$96.00	\$99.00	12
	985	Double Cylinder		\$90.00	\$90.00	\$90.00	\$90.00			\$90.00	\$93.00	12
	985 SMT	Double Cylinder	\$82.00	\$90.00	\$90.00	\$90.00	\$90.00			\$90.00	\$93.00	12

Uptown Deadbolt

	Model	Function	Finish								Case Qty	
			3	L03	5	11P	15	15A	26	26D		514
 NEW!	258 RDT SMT	Single Cylinder				\$65.00	\$65.00			\$65.00	\$68.00	12

Downtown Deadbolt

	Model	Function	Finish								Case Qty	
			3	L03	5	11P	15	15A	26	26D		514
 NEW!	258 SQT SMT	Single Cylinder				\$65.00	\$65.00			\$65.00	\$68.00	12

Austin Deadbolt

	Model	Function	Finish								Case Qty	
			3	L03	5	11P	15	15A	26	26D		514
	980AUD SMT	Single Cylinder				\$65.00	\$65.00					12
	985AUD SMT	Double Cylinder				\$65.00	\$65.00					12

780/785

	Model	Function	Finish								Case Qty	
			3	L03	5	11P	15	15A	26	26D		514
	780	Single Cylinder	\$48.00	\$56.00	\$56.00	\$56.00	\$56.00	\$56.00	\$56.00	\$56.00		12
	780 SMT	Single Cylinder	\$48.00	\$56.00	\$56.00	\$56.00	\$56.00	\$56.00	\$56.00	\$56.00		12
	782	Single Cylinder UL	\$54.00	\$62.00	\$62.00	\$62.00	\$62.00	\$62.00	\$62.00	\$62.00		12
	782 SMT	Single Cylinder UL	\$54.00	\$62.00	\$62.00	\$62.00	\$62.00	\$62.00	\$62.00	\$62.00		12
	784	Double Cylinder UL	\$79.00	\$87.00	\$87.00	\$87.00	\$87.00	\$87.00	\$87.00	\$87.00		12
	784 SMT	Double Cylinder UL	\$79.00	\$87.00	\$87.00	\$87.00	\$87.00	\$87.00	\$87.00	\$87.00		12
	785	Double Cylinder	\$73.00	\$81.00	\$81.00	\$81.00	\$81.00	\$81.00	\$81.00	\$81.00		12
	785 SMT	Double Cylinder	\$73.00	\$81.00	\$81.00	\$81.00	\$81.00	\$81.00	\$81.00	\$81.00		12

Halifax Deadbolt

	Model	Function	Finish								Case Qty	
			3	L03	5	11P	15	15A	26	26D		514
	158 SQT	Single Cylinder				\$56.00	\$56.00			\$56.00	\$56.00	12
	158 SQT SMT	Single Cylinder				\$56.00	\$56.00			\$56.00	\$56.00	12
	159 SQT	Double Cylinder				\$81.00	\$81.00			\$81.00	\$81.00	12
	159 SQT SMT	Double Cylinder				\$81.00	\$81.00			\$81.00	\$81.00	12

Milan Deadbolt

	Model	Function	Finish								Case Qty	
			3	L03	5	11P	15	15A	26	26D		514
	158 RDT	Single Cylinder				\$56.00	\$56.00			\$56.00	\$56.00	12
	158 RDT SMT	Single Cylinder				\$56.00	\$56.00			\$56.00	\$56.00	12
	159 RDT	Double Cylinder				\$81.00	\$81.00			\$81.00	\$81.00	12
	159 RDT SMT	Double Cylinder				\$81.00	\$81.00			\$81.00	\$81.00	12

Gatelatch

	Model	Function	Finish								Case Qty	
			3	L03	5	11P	15	15A	26	26D		514
	598 SMT	Single Cylinder	\$70.00	\$78.00	\$78.00		\$78.00	\$78.00		\$78.00		12
	599	Double Cylinder	\$95.00				\$103.00			\$103.00		12
	599 SMT	Double Cylinder	\$95.00		\$103.00		\$103.00			\$103.00		12

KWIKSET SIGNATURE SERIES HANDLESETS

Door Prep	Deadbolt: Cross Bore 2-1/8" or 1-1/2". Edge Bore 1". Latch Face 1" x 2-1/4". Handle: Cross Bore 2-1/8". Edge Bore 1". Latch Face 1" x 2-1/4".
Backset	Deadbolt: Adjustable to 2-3/8" or 2-3/4". Handle: Adjustable to 2-3/8" or 2-3/4".
Door Thickness	1-3/4" doors standard. 2-1/4" doors optional.
Cylinder	SmartKey or Pin & Tumbler
Faceplate	1" x 2-1/4". Specify round corner, square corner or drive-in.
Strikes	Deadbolt: 1-1/4" x 3-5/8". Specify round corner or square corner. Others options available. Handle: 2-1/4" full lip. Specify round corner or square corner. Other options available.
Bolt	Deadbolt: 1" throw. Handle: 1/2" throw.
Door Handing	Reversible for right or left-hand doors.
ANSI/BHMA	Deadbolt is Grade 1 Certified. Montara Deadbolt is Grade 2 Certified.
ADA	N/A
UL	Optional 1/3 hour UL fire rating for all functions except 802 and 502

KWIKSET SIGNATURE SERIES LEVERS

Door Prep	Cross Bore 2-1/8" Edge Bore 1" Latch Face 1" x 2-1/4"
Backset	Adjustable to 2-3/8" or 2-3/4".
Door Thickness	1-3/8" – 1-3/4" doors standard.
Faceplate	2-1/4" doors optional on 720 and 740 models.
Cylinder	SmartKey or Pin & Tumbler.
Strikes	1" x 2-1/4". Specify round corner, square corner or drive-in.
Strikes	2-1/4" full lip. Specify round corner or square corner. Other options available.
Bolt	1/2" throw.
Door Handing	Specify handing only with inactive levers
ANSI/BHMA	Grade 2 Certified
ADA	Functions 154, 155, 720, 788 satisfy section 4.13.9. ADA requirement.
UL	Meets UL 3 hour fire rating for 725, 735, 745, 746, 749, 755 Optional UL 1/3 hour fire rating for all functions
Rose	Specify round or square rose - HFL, LSL, MRL, SYL, MIL

KWIKSET SIGNATURE SERIES KNOBS

Door Prep	Cross Bore: 2-1/8" Edge Bore: 1" Latch Face: 1" x 2-1/4".
Backset	Adjustable to 2-3/8" or 2-3/4". UL 2-3/4" standard 2-3/8" optional.
Door Thickness	1-3/8" – 1-3/4" doors standard.
Faceplate	2-1/4" doors optional on 720 and 740 models only.
Cylinder	SmartKey or Pin & Tumbler.
Strikes	1" x 2-1/4". Specify round corner, square corner or drive-in.
Strikes	2-1/4" full lip. Specify round corner or square corner. Other options available.
Bolt	1/2" throw.
Door Handing	Reversible for right- or left-hand doors.
ANSI/BHMA	Grade 2 Certified
ADA	N/A
UL	Meets UL 3 hour fire rating for 725, 735, 745, 746, 749 and 755. Optional UL 1/3 hour fire rating for all functions

* Optional UL 1/3 hour list price charge is \$2.50.

KWIKSET SIGNATURE SERIES 780-785 DEADBOLTS

Door Prep	780, 785: Crossbore 2-1/8" or 1-1/2". Edge Bore 1". Latch Face 1" x 2-1/4" 782, 784: Crossbore 2-1/8". Edge Bore 1". Latch Face 1" x 2-1/4"
Backset	Adjustable to 2-3/8" or 2-3/4" standard.
Door Thickness	1-3/8" – 1-3/4" standard. 1-7/8" – 2-1/4" optional.
Cylinder	6-pin removable core or SmartKey.
Faceplate	1" x 2-1/4". Specify round corner, square corner, or drive-in.
Strikes	1-1/4" x 3-5/8". Specify round corner or square corner. Other options available.
Bolt	1" throw.
Door Handing	Reversible for right or left-hand doors.
ANSI/BHMA	Grade 2 Certified
ADA	Interior turn piece meets 4.13.9 ADA requirements.
UL	Meets UL 3 hour fire rating for 782 & 784 Optional UL 1/3 hour fire rating for all functions

KWIKSET SIGNATURE SERIES 980/985 DEADBOLTS

Door Prep	980, 985: Crossbore 2-1/8" or 1-1/2". Edge Bore 1". Latch Face 1" x 2-1/4". 982, 984: Crossbore 2-1/8". Edge Bore 1". Latch Face 1" x 2-1/4".
Backset	Adjustable to 2-3/8" or 2-3/4".
Door Thickness	1-3/8" – 1-3/4" standard. 1-7/8" – 2-1/4" optional.
Cylinder	SmartKey or Pin & Tumbler.
Faceplate	1" x 2-1/4". Specify round corner, square corner or drive-in.
Strikes	Standard: Grade 2, 1-1/4" x 3-5/8" Specify round corner or square corner. For Grade 1 order 5278 Strike option and Ultra Strike Door Jamb Brace. Other options available.
Bolt	1" throw.
Door Handing	Reversible for right or left-hand doors.
ANSI/BHMA	Grade 1 Certified
ADA	Interior turn piece meets 4.13.9 ADA requirements.
UL	Meets UL 3 hour fire rating for 982 and 984 Optional UL 1/3 hour fire rating for all functions

KWIKSET SIGNATURE SERIES 158/159 CONTEMPORARY DEADBOLTS

Door Prep	Cross Bore 2-1/8" or 1-1/2". Edge Bore 1".
Backset	Adjustable to 2-3/8" or 2-3/4".
Door	
Thickness	SMT 1-3/8" – 1-3/4".
Cylinder	SmartKey or Pin & Tumbler (158 and 159)
Rose	Specify round or square rose
Strikes	1-1/4" x 3-5/8" Square or Round Corner.
Bolt	1" Throw Steel.
ANSI/BHMA	A156.36 Grade 2
ADA	Meets 4.13.9 ADA requirements.
UL	20 Minute UL fire rating available.

KWIKSET SIGNATURE SERIES 258 UPTOWN & DOWNTOWN CONTEMPORARY DEADBOLTS

Door Prep	Cross Bore 2-1/8". Edge Bore 1".
Backset	Adjustable to 2-3/8" or 2-3/4".
Door	
Thickness	1-3/8" – 1-3/4" Standard. Thick door service part available for up to 2'1/4".
Faceplate	1" x 2-1/4" Square, round, or drive in.
Rose	Specify round (Uptown) or square (Downtown) rose.
Strikes	2-1/4" full lip square corner.
Bolt	1" Throw Steel.
ANSI/BHMA	A156.36 Grade 1
ADA	Satisfy section 4.13.9 ADA requirements.
UL	20 Minute UL fire rating available.
Warranty	Lifetime Mechanical and Lifetime Finish.

KWIKSET SIGNATURE SERIES HANDLESET

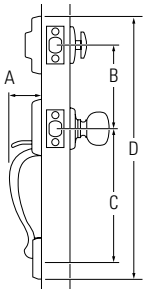

Design	A	B	C	D
Amherst®	3"	5-1/2"	8-13/32"	18-23/32"
Arlington®	2-1/2"	5-1/2"	11"	19-1/16"
Ashfield™	2-31/32"	5-1/2"	8-13/32"	17-3/4"
Austin	3-5/32"	5-1/2"	9-11/16"	18-27/64"
Avalon™	2-7/8"	5-1/2"	8-13/32"	18-5/32"
Chelsea®	2-3/16"	5-1/2"	9-11/16"	18-1/2"
Hawthorne™	2-7/8"	5-1/2"	8-13/32"	17-7/16"
Montara™	2-19/32"	5-1/2"	9-11/16"	17-13/16"
Shelburne™	2-7/8"	5-1/2"	8-13/32"	18-1/4"
Tavaris	2-1/2"	5-1/2"	8-3/7"	18"
Wellington®	2-7/8"	5-1/2"	8-13/32"	18-15/16"

KWIKSET SIGNATURE SERIES KNOBS

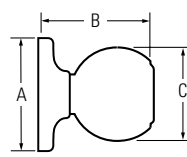

Design	A	B	C
Abbey®	2-5/8"	2-17/16"	2"
Cameron®	2-5/8"	2-13/32"	2-1/8"
Circa®	2-5/8"	2-31/32"	2-1/8"
Hancock®	2-5/8"	2-1/2"	2-3/8"
Laurel®	2-5/8"	2-7/16"	2-7/16"
Phoenix®	2-5/8"	2-1/2"	2-3/16"

KWIKSET SIGNATURE SERIES LEVERS

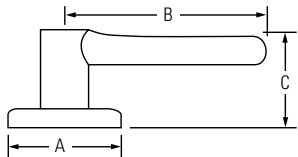

Design	A	B	C	C (Keyed)
Ashfield™	2-5/8"	4-3/16"	2-9/16"	2-9/16"
Austin	2-13/16"	4-1/8"	2-2/3"	2-3/4"
Avalon™	2-5/8"	4-1/4"	2-17/32"	2-7/16"
Brooklane®	2-5/8"	4-3/16"	2-11/16"	2-11/16"
Commonwealth®	2-5/8"	4-7/32"	2-7/16"	2-7/16"
Halifax	2-5/8"	4-15/32"	2-19/32"	2-3/8"
Katara	4-4/9"	2-4/9"	2-2/3"	2-3/4"
Lido®	2-5/8"	3-3/4"	1-29/32"	2-15/32"
Lisbon	2-5/8"	4-5/32"	2-9/16"	2-3/8"
Milan	2-5/8"	4-5/32"	2-9/16"	2-3/8"
Pembroke™	2-5/8"	4-7/32"	2-23/32"	2-23/32"
Sydney®	2-5/8"	4 1/4"	2 3/4"	2 3/8"
Tustin®	2-5/8"	4-7/32"	2-3/32"	2-19/32"
Vedani	4-5/8"	2-2/3"	2-1/2"	2-3/4"

KWIKSET SIGNATURE SERIES 158-159 DEADBOLT

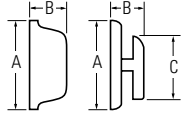

Round Design	A	B	C
158 Interior	2-17/32"	1-13/32"	1-11/16"
158 Exterior	2-17/32"	15/16"	
159 Interior	2-17/32"	1-13/32"	1-11/16"
159 Exterior	2-17/32"	15/16"	

Square Design	A	B	C
158 Interior	2-17/32"	1-13/32"	1-11/16"
158 Exterior	2-19/32"	15/16"	
159 Interior	2-17/32"	1-13/32"	1-11/16"
159 Exterior	2-19/32"	15/16"	

KWIKSET SIGNATURE SERIES 980-985 DEADBOLT

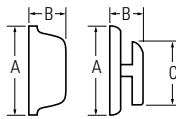

Design	A	B	C
980 Interior	2-19/32"	1-5/32"	1-13/16"
980 Exterior	2-5/8"	1-1/32"	
985 Interior	2-5/8"	1-1/32"	
985 Exterior	2-5/8"	1-1/32"	

KWIKSET SIGNATURE SERIES AUSTIN 980-985 DEADBOLT

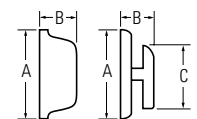

Design	A	B	C
980 Interior	3-13/32"	1-1/2"	1-7/16"
980 Exterior	3-17/32"	1-1/16"	
985 Interior	3-17/32"	1-1/16"	
985 Exterior	3-17/32"	1-1/16"	

KWIKSET SIGNATURE SERIES 780-785 DEADBOLT

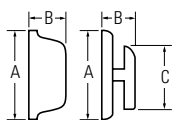

Design	A	B	C
780, 782 Interior	2-1/2"	15/16"	1-25/32"
780, 782 Exterior	2-5/8"	1-1/8"	
784, 785 Interior	2-5/8"	1-1/8"	
784, 785 Exterior	2-5/8"	1-1/8"	

KWIKSET SIGNATURE SERIES AUSTIN 258 UPTOWN & DOWNTOWN DEADBOLT

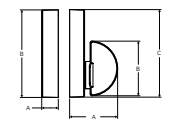

Design	A	B	C
258 Round Interior	2-5/8"	1-3/8"	1-21/32"
258 Round Exterior	2-5/8"	9/16"	

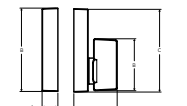

Design	A	B	C
258 Square Interior	2-5/8"	1-7/16"	1-21/32"
258 Square Exterior	2-5/8"	1/2"	

TRUSTED SECURITY



- ANSI/BHMA Grade 3
- Easy Installation
- Available with SmartKey® Re-Key Technology with Bumpguard™ Protection*
- Most Recognized Styles

WARRANTY

- Lifetime Mechanical
- Lifetime Finish

*Lock Bumping - an attack technique using specially cut keys that can defeat conventional pin & tumbler locks.



Bellevue™

Dakota™

Aliso™

Cove™

Polo®

Tylo®

Balboa™

Delta®

Dorian®

Ladera®

660/665 Deadbolt

Bellevue™



Dakota™



Bellevue™	Model	Function	Finish							Case		
			3	L03	5	11P	15	15A	26		26D	Qty
	687BW	Single Cylinder	\$96.00		\$96.00	\$112.00	\$112.00				\$96.00	6
	687BW SMT	Single Cylinder	\$101.00		\$101.00	\$117.00	\$117.00				\$101.00	6
	689BW	Double Cylinder	\$101.00		\$101.00	\$117.00	\$117.00				\$101.00	6
	689BW SMT	Double Cylinder	\$106.00		\$106.00	\$122.00	\$122.00				\$106.00	6
	699BW	Dummy	\$86.00		\$86.00	\$102.00	\$102.00				\$86.00	6

Dakota™

Dakota™	Model	Function	Finish							Case		
			3	L03	5	11P	15	15A	26		26D	Qty
	687DA	Single Cylinder	\$96.00		\$96.00	\$112.00	\$112.00	\$112.00			\$96.00	6
	687DA SMT	Single Cylinder	\$101.00		\$101.00	\$117.00	\$117.00	\$117.00			\$101.00	6
	689DA	Double Cylinder	\$101.00		\$101.00	\$117.00	\$117.00	\$117.00			\$101.00	6
	689DA SMT	Double Cylinder	\$106.00		\$106.00	\$122.00	\$122.00	\$122.00			\$106.00	6
	699DA	Dummy	\$86.00		\$86.00	\$102.00	\$102.00	\$102.00			\$86.00	6

INTERIOR PACK FUNCTION OPTIONS

Model	Function	Series			
		Signature Lever & Laurel	Signature Knob	Kwikset Lever	Kwikset Knob
604	Single Cylinder	\$53.00	\$43.00	\$49.00	\$39.00
605	Double Cylinder	\$72.00	\$62.00	\$61.00	\$51.00
605 SMT	Double Cylinder	\$77.00	\$67.00	\$66.00	\$56.00
606	Dummy	\$44.00	\$35.00	\$40.00	\$29.00

NOTE:604 and 606 interior packs not impacted by SmartKey.

Kwikset Handleset & Interior Pack Finish Options

	L03	3	5	11P	15	15A	26	26D	Qty
Kwikset Abbey Knob		•	•				•	•	4
<i>Signature Series</i> Cameron Knob		•	•	•	•	•	•		4
Circa Knob		•		•	•	•	•	•	4
Hancock Knob		•	•	•	•	•	•	•	4
Laurel Knob				•	•	•	•		4
Lido Lever		•	•		•	•		•	4
Tustin Lever		•	•	•	•	•	•	•	12
Kwikset Aliso Knob		•		•	•		•		4
Balboa Lever		•	•	•	•		•	•	4
Cove Knob		•	•	•	•		•	•	4
Delta Lever		•	•			•	•	•	12
Dorian Lever		•	•	•	•	•	•	•	12
Ladera Lever				•	•		•	•	12
Polo Knob		•	•	•	•	•	•	•	4
Tylo Knob		•	•		•		•	•	12

Kwikset

Balboa™

Model	Function	Finish							NEW!		Case Qty
		3	L03	5	11P	15	15A	26	26D		
200BL	Hall/Closet	\$33.00		\$33.00	\$36.00	\$36.00		\$36.00	\$33.00	20	
300BL	Bed/Bath	\$36.00		\$36.00	\$39.00	\$39.00		\$39.00	\$36.00	20	
405BL	Keyed Lever	\$51.00		\$51.00	\$54.00	\$54.00		\$54.00	\$51.00	20	
405BL SMT	Keyed Lever	\$56.00		\$56.00	\$59.00	\$59.00		\$59.00	\$56.00	20	
488BL	Half Dummy	\$16.50		\$16.50	\$19.50	\$19.50		\$19.50	\$16.50	20	



Delta®

NEW! NEW!

Model	Function	Finish							NEW!		Case Qty
		3	L03	5	11P	15	15A	26	26D		
200DL	Hall/Closet	\$33.00		\$33.00	\$36.00	\$36.00	\$36.00	\$36.00	\$33.00	20	
300DL	Bed/Bath	\$36.00		\$36.00	\$39.00	\$39.00	\$39.00	\$39.00	\$36.00	20	
405DL	Keyed Lever	\$51.00		\$51.00	\$54.00	\$54.00	\$54.00	\$54.00	\$51.00	20	
405DL SMT	Keyed Lever	\$56.00		\$56.00	\$59.00	\$59.00	\$59.00	\$59.00	\$56.00	20	
406DL	Free Interior, Keyed Lever	\$54.00		\$54.00			\$57.00	\$57.00	\$54.00	20	
406DL SMT	Free Interior, Keyed Lever	\$59.00		\$59.00			\$62.00	\$62.00	\$59.00	20	
409DL	Keyed Lever UL	\$57.00		\$57.00	\$60.00	\$60.00	\$60.00	\$60.00	\$57.00	20	
409DL SMT	Keyed Lever UL	\$62.00		\$62.00	\$65.00	\$65.00	\$65.00	\$65.00	\$62.00	20	
412DL	Vestibule Keyed Lever UL	\$60.00		\$60.00			\$63.00	\$63.00	\$60.00	20	
412DL SMT	Vestibule Keyed Lever UL	\$65.00		\$65.00			\$68.00	\$68.00	\$65.00	20	
413DL	Free Interior, Keyed Lever UL	\$60.00		\$60.00			\$63.00	\$63.00	\$60.00	20	
413DL SMT	Free Interior, Keyed Lever UL	\$65.00		\$65.00			\$68.00	\$68.00	\$65.00	20	
420DL	Hall/Closet UL	\$39.00		\$39.00	\$42.00	\$42.00	\$42.00	\$42.00	\$39.00	20	
430DL	Bed/Bath UL	\$42.00		\$42.00			\$45.00	\$45.00	\$42.00	20	
462DL	Vestibule Keyed Lever	\$54.00		\$54.00			\$57.00	\$57.00	\$54.00	20	
462DL SMT	Vestibule Keyed Lever	\$59.00		\$59.00			\$62.00	\$62.00	\$59.00	20	
488DL	Half Dummy	\$16.50		\$16.50	\$19.50	\$19.50	\$19.50	\$19.50	\$16.50	20	



Kwikset

Dorian®



Model	Function	Finish								Case
		3	L03	5	11P	15	15A	26	26D	Qty
200DNL	Hall/Closet	\$33.00		\$33.00	\$36.00	\$36.00	\$36.00	\$36.00	\$33.00	20
300DNL	Bed/Bath	\$36.00		\$36.00	\$39.00	\$39.00	\$39.00	\$39.00	\$36.00	20
405DNL	Keyed Lever	\$51.00		\$51.00	\$54.00	\$54.00	\$54.00	\$54.00	\$51.00	20
405DNL SMT	Keyed Lever	\$56.00		\$56.00	\$59.00	\$59.00	\$59.00	\$59.00	\$56.00	20
406DNL	Free Interior, Keyed Lever	\$54.00		\$54.00	\$57.00	\$57.00	\$57.00	\$57.00	\$54.00	20
406DNL SMT	Free Interior, Keyed Lever	\$59.00		\$59.00			\$62.00	\$62.00	\$59.00	20
409DNL	Keyed Lever UL	\$57.00		\$57.00	\$60.00	\$60.00	\$60.00	\$60.00	\$57.00	20
409DNL SMT	Keyed Lever UL	\$62.00		\$62.00	\$65.00	\$65.00	\$65.00	\$65.00	\$62.00	20
412DNL	Vestibule Keyed Lever UL	\$60.00		\$60.00			\$63.00	\$63.00	\$60.00	20
412DNL SMT	Vestibule Keyed Lever UL	\$65.00		\$65.00	\$68.00	\$68.00	\$68.00	\$68.00	\$65.00	20
413DNL	Free Interior, Keyed Lever UL	\$60.00		\$60.00			\$63.00	\$63.00	\$60.00	20
413DNL SMT	Free Interior, Keyed Lever UL	\$65.00		\$65.00			\$68.00	\$68.00	\$65.00	20
420DNL	Hall/Closet UL	\$39.00		\$39.00	\$42.00	\$42.00	\$42.00	\$42.00	\$39.00	20
430DNL	Bed/Bath UL	\$42.00		\$42.00	\$45.00	\$45.00	\$45.00	\$45.00	\$42.00	20
462DNL	Vestibule Keyed Lever	\$54.00		\$54.00	\$57.00	\$57.00	\$57.00	\$57.00	\$54.00	20
462DNL SMT	Vestibule Keyed Lever	\$59.00		\$59.00	\$62.00	\$62.00	\$62.00	\$62.00	\$59.00	20
488DNL	Half Dummy	\$16.50		\$16.50	\$19.50	\$19.50	\$19.50	\$19.50	\$16.50	20

Ladera®



NEW!

Model	Function	Finish								Case
		3	L03	5	11P	15	15A	26	26D	Qty
200LRL	Hall/Closet				\$36.00	\$36.00		\$36.00	\$33.00	20
300LRL	Bed/Bath				\$39.00	\$39.00		\$39.00	\$36.00	20
405LRL	Keyed Lever				\$54.00	\$54.00		\$54.00	\$51.00	20
405LRL SMT	Keyed Lever				\$59.00	\$59.00		\$59.00	\$56.00	20
488LRL	Half Dummy				\$19.50	\$19.50		\$19.50	\$16.50	20

Kwikset

Aliso™ NEW!



Model	Function	Finish							Case Qty	
		3	L03	5	11P	15	15A	26		26D
200AO	Hall/Closet	\$22.00			\$25.00	\$25.00		\$25.00		30
300AO	Bed/Bath	\$25.00			\$28.00	\$28.00		\$28.00		30
400AO SMT	Entry	\$36.00			\$39.00	\$39.00		\$39.00		30
488AO	Half Dummy	\$11.00			\$14.00	\$14.00		\$14.00		20

Cove™



Model	Function	Finish							Case Qty	
		3	L03	5	11P	15	15A	26		26D
200CV	Hall/Closet	\$22.00		\$22.00	\$25.00	\$25.00		\$25.00	\$22.00	30
300CV	Bed/Bath	\$25.00		\$25.00	\$28.00	\$28.00		\$28.00	\$25.00	30
400CV	Entry (Pin & Tumbler)	\$31.00		\$31.00	\$34.00	\$34.00		\$34.00	\$31.00	30
400CV SMT	Entry	\$36.00		\$36.00	\$39.00	\$39.00		\$39.00	\$36.00	30
488CV	Half Dummy	\$11.00		\$11.00	\$14.00	\$14.00		\$14.00	\$11.00	20

Polo®



Model	Function	Finish							Case Qty	
		3	L03	5	11P	15	15A	26		26D
200P	Hall/Closet	\$19.00		\$19.00	\$22.00	\$22.00	\$22.00	\$22.00	\$19.00	30
300P	Bed/Bath	\$22.00		\$22.00	\$25.00	\$25.00	\$25.00	\$25.00	\$22.00	30
400P	Entry	\$28.00		\$28.00	\$31.00	\$31.00	\$31.00	\$31.00	\$28.00	30
400P SMT	Entry	\$33.00		\$33.00	\$36.00	\$36.00	\$36.00	\$36.00	\$33.00	30
401P	Entry, Free Interior	\$31.00		\$31.00	\$34.00	\$34.00			\$31.00	30
401P SMT	Entry, Free Interior	\$36.00		\$36.00	\$39.00	\$39.00			\$36.00	30
450P	Vestible	\$31.00		\$31.00					\$31.00	30
450P SMT	Vestible	\$36.00		\$36.00					\$36.00	30
488P	Half Dummy	\$9.50		\$9.50	\$12.50	\$12.50	\$12.50	\$12.50	\$9.50	20

Tylo®



Model	Function	Finish							Case Qty	
		3	L03	5	11P	15	15A	26		26D
200T	Hall/Closet	\$17.00		\$17.00		\$20.00		\$20.00	\$17.00	30
300T	Bed/Bath	\$20.00		\$20.00		\$23.00		\$23.00	\$20.00	30
400T	Entry	\$26.00		\$26.00		\$29.00		\$29.00	\$26.00	30
400T SMT	Entry	\$31.00		\$31.00		\$34.00		\$34.00	\$31.00	30
401T	Entry, Free Interior	\$29.00		\$29.00		\$32.00			\$29.00	30
401T SMT	Entry, Free Interior	\$34.00		\$34.00		\$37.00			\$34.00	30
488T	Half Dummy	\$8.50		\$8.50		\$11.50		\$11.50	\$8.50	20



660/665

	Model	Function	Finish							Case Qty	
			3	L03	5	11P	15	15A	26		26D
	660	Single Cylinder	\$27.00		\$27.00	\$30.00	\$30.00	\$30.00	\$30.00	\$27.00	12
	660 SMT	Single Cylinder	\$32.00		\$32.00	\$35.00	\$35.00	\$35.00	\$35.00	\$32.00	12
	665	Double Cylinder	\$35.00		\$35.00	\$38.00	\$38.00	\$38.00	\$38.00	\$35.00	12
	665 SMT	Double Cylinder	\$42.00		\$42.00	\$45.00	\$45.00	\$45.00	\$45.00	\$42.00	12

One-Sided

	Model	Function	Finish							Case Qty	
			3	L03	5	11P	15	15A	26		26D
	663	Thumbturn One Side	\$13.50		\$13.50	\$16.50	\$16.50	\$16.50	\$16.50	\$13.50	12
	667	Thumbturn One Side with Exterior Plate	\$27.00		\$27.00	\$30.00	\$30.00	\$30.00	\$30.00	\$27.00	12
	664	Retrofit Kit for 663	\$9.00		\$9.00	\$12.00				\$9.00	12
	677	Thumbturn One Side with Exterior Plate UL	\$33.00		\$33.00	\$36.00	\$36.00			\$33.00	12

Combo Pack Availability

NEW!

	Model	Function	Finish							Case Qty	
			3	L03	5	11P	15	15A	26		26D
	690T	Keyed Entry Tylo Knob with Single Cylinder Deadbolt	\$47.70		\$47.70		\$47.70			\$47.70	6
	690T SMT	Keyed Entry Tylo Knob with Single Cylinder Deadbolt	\$56.70		\$56.70		\$56.70			\$56.70	6





KWIKSET HANDLESET

Door Prep	Deadbolt: Cross Bore 2-1/8" or 1-1/2". Edge Bore 1". Latch Face 1" x 2-1/4". Handle: Cross Bore 2-1/8". Edge Bore 1". Latch face 1" x 2 1/4"
Backset	Deadbolt: Adjustable to 2-3/8" or 2-3/4". Handle: Adjustable to 2-3/8" or 2-3/4".
Door	1-3/4" doors standard. 2-1/4" doors optional.
Thickness	Not designed for use on 1-3/8" doors.
Cylinder	SmartKey or traditional 5-Pin, Pin & Tumbler.
Faceplate	1" x 2-1/4". Specify round corner, square corner or drive-in
Strikes	Deadbolt: 1" x 2-1/4". Specify round corner or square corner. Other options available. Handle: 2-1/4" full lip. Specify round corner or square corner. Other options available.
Bolt	Deadbolt: 1" throw. Handle: 1/2" throw.
Door Handing	Reversible for right or left-hand doors.
ANSI/BHMA	Deadbolt is Grade 3 Certified
ADA	N/A
UL	Optional UL 1/3 hour fire rating for all functions except 699* & 502.

KWIKSET LEVERS

Door Prep	Cross Bore 2-1/8". Edge Bore 1". Latch Face 1" x 2-1/4".
Backset	Adjustable to 2-3/8" or 2-3/4". UL 2-3/4" standard 2-3/8" optional.
Door	1-3/8" – 1-3/4" doors standard.
Thickness	2-1/4" doors optional on 200 and 400 functions only.
Cylinder	SmartKey or Pin & Tumbler.
Faceplates	1" x 2-1/4". Specify round corner, square corner or drive-in.
Strikes	2-1/4" full lip. Specify round corner or square corner. Other options available.
Bolt	1/2" throw.
Door Handing	Delta and Dorian are non-handed. Balboa is reversible for all functions except 488.
ANSI/BHMA	Grade 3 Certified. (all functions except 488)
ADA	Functions 200 and 420 satisfy section 4.13.9 ADA requirements.
UL	Meets UL 3 hour fire rating for 409, 412, 413, 420, 430 Optional UL 1/3 hour fire rating for all functions*

KWIKSET DEADBOLTS

Door Prep	660, 665: Crossbore 2-1/8". Edge Bore 1". Latch Face 1" x 2-1/4". 663: Crossbore 1-5/8". Edge Bore 1". Latch Face 1" x 2-1/4". 667: Crossbore 2-1/8" or 1-1/2". Edge Bore 1". Latch Face 1" x 2-1/4".
Backset	660, 665, 667: Adjustable latch standard. 663: 2-3/8" standard. 2-3/4" optional.
Door	660, 663, 665, 667: 1-3/8" – 1-3/4" doors standard.
Thickness	
Cylinder	660, 665: SmartKey or Pin & Tumbler.
Faceplates	1" x 2-1/4". Specify round corner, square corner or drive-in.
Strikes	1" x 2-1/4" full. Specify round corner or square corner. Other options available.
Bolt	1" throw.
Door Handing	Reversible for right or left-hand doors.
ANSI/BHMA	Grade 3 Certified
ADA	Interior turn piece meets 4.13.9 ADA requirements.
UL	Meets UL 3 hour fire rating for 677 Optional UL 1/3 hour fire rating for all functions*

KWIKSET KNOBS

Door Prep	Cross Bore 2-1/8". Edge Bore 1".
Backset	Adjustable to 2-3/8" or 2-3/4". 5" available as service part
Door	1-3/8"–1-3/4" standard.
Thickness	2-1/4" doors optional on 200 and 400 models only.
Cylinder	SmartKey or Pin & Tumbler
Faceplates	1" x 2-1/4". Specify round corner or square corner. Also available as drive-in latch.
Strikes	2-1/4" full lip. Specify round corner or square corner. Other options available.
Bolt	1/2" throw.
Door Handing	Reversible for right or left hand doors.
ANSI/BHMA	Grade 3 Certified (all functions except 488)
ADA	N/A
UL	Optional UL 1/3 hour fire rating for all functions*

*Optional UL 1/3 hour list price charge is \$2.50.

KWIKSET HANDLESET

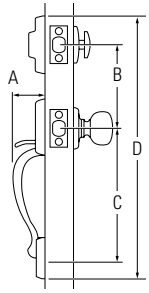

Design	A	B	C	D
Belleview™	2-5/32"	5-1/2"	8-13/32"	18-1/16"
Dakota™	2-5/32"	5-1/2"	8-13/32"	17-3/16"

KWIKSET KNOB

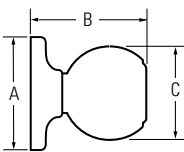

	A	B	C
Aliso™	2-5/8"	2-3/4"	2-2/5"
Cove™	2-5/8"	2-1/2"	2-3/16"
Polo®	2-5/8"	2-23/32"	1-7/8"
Tylo®	2-5/8"	2-1/2"	1-7/8"

KWIKSET LEVER

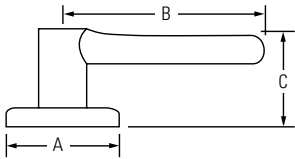

Design	A	B	C	C (Keyed)
Balboa™	2-5/8"	4-7/32"	1-15/16"	2-13/32"
Delta®	2-5/8"	3-5/8"	1-7/8"	2-15/32"
Dorian®	2-5/8"	3-3/4"	2-1/8"	2-11/16"
Ladera®	2-5/8"	4-3/16"	1-7/8"	2-7/16"

KWIKSET DEADBOLT

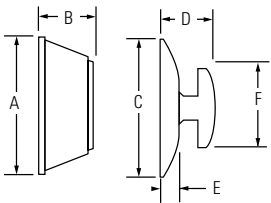

Design	A	B	C	D	E	F
660	2-7/16"	1-1/16"	2-1/2"	27/32"	5/16"	1-3/4"
663			2-1/2"	27/32"	5/16"	1-3/4"
665	2-7/16"	1-1/16"	2-1/2"	1-1/16"		
667	2-17/32"	3/8"	2-1/2"	27/32"	5/16"	1-3/4"
677	2-17/32"	3/8"	2-1/2"	27/32"	5/16"	1-3/4"

Kwikset

FEATURES

- Touch to Open Convenience
- Your Smartphone is Now Your Key
- No Smartphone? Use a Key Fob
- Send eKeys to Other Smartphones

Your Smartphone is Now Your Key

Keep your phone in your pocket or purse. No more fumbling for your keys... just touch the lock to open for the ultimate in convenience.

Share eKeys with your Smartphone

Touch to Open Convenience

PRODUCT	Model	Function	Finish										Case		
			3	L03	5	11P	15	15A	26	26D	501	502	514	Qty	
	925 DB	Kevo Bluetooth Enabled Deadbolt		\$417.00		\$417.00	\$417.00								1

KEVO 925 DEADBOLT

PRODUCT	Model	Function	Finish										Case	
			3	L03	5	11P	15	15A	26	26D	501	502	N/A	Qty
	926	Kevo Key Fob											\$54.00	4

KEVO KEY FOB

kevo™

THE KEY EVOLVED.

Features

- Bluetooth enabled deadbolt
- Your smartphone is now your key
- Touch to open convenience
- Share eKeys with your smartphone
- Receive notifications and manage lock and eKeys through the Kevo mobile app

Specifications

Function	Single Cylinder Deadbolt
Door Prep	2 1/8" diameter face hole & 1" diameter latch hole
Backset	Adjustable 2 3/8" or 2 3/4"
Door Thickness	1 3/8" - 2" automatic adjustment
Cylinder	SmartKey® Re-key Technology
Faceplates	1" x 2 1/4" round corner standard
Strikes	Round corner strike 2 3/4" x 1 1/8"
Latch	Round corner adjustable 2 3/8" x 2 3/4"
Bolt	1" throw, steel deadbolt
Door Handing	Reversible
Batteries	4AA Required

Systems Requirements

- Bluetooth Smart ready with a Bluetooth 4.0 enabled device
- Data connection required to download Kevo mobile app
- **Smartphone compatibility:** Apple iPhone 4s, 5, 5c or 5s, iPad, iPod, etc. Check here for an updated compatibility list: www.kwikset.com/Kevo

What's in the Box

- Kevo deadbolt, (2) eKeys, Kevo fob included for touch to open convenience without a smartphone, and 4 AA batteries, (2) standard keys

Dimensions

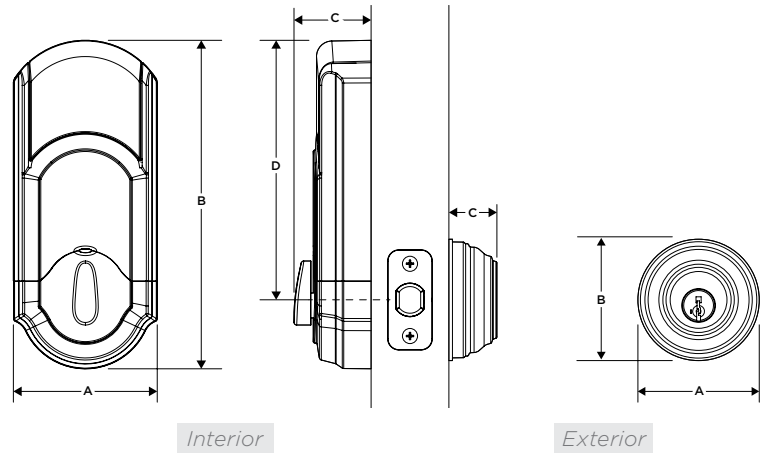

Design	A	B	C	D
Kevo™ Interior	3 1/4" (82.55 mm)	7 13/32" (188.12 mm)	1 3/4" (44.45 mm)	5 27/32" (148.44 mm)
Kevo™ Exterior	2 3/4" (69.85 mm)	2 3/4" (69.85 mm)	1 5/32" (29.37 mm)	---

Finishes



Polished Brass L03

Satin Nickel 15

Venetian Bronze 11P

Kwikset®

19701 DaVinci • Lake Forest, CA 92610 • www.kwikset.com/kevo • 1-800-327-LOCK

Kwikset

SMARTCODE 915

TOUCHSCREEN ELECTRONIC DEADBOLT



New Features

- Sleek metal design for enhanced quality
- Dramatically reduced interior size
- Tamper resistant interior cover
- Capacitive touchscreen

User Codes

- Up to 16 user access codes for family & guests
- MasterCode feature for improved user access code management

Additional Features

- Patented SecureScreen™—security feature helps to ensure that user codes cannot be identified by examining fingerprints on screen

PRODUCT	Model	Function	Finish									Case Qty			
			3	L03	5	11P	15	15A	26	26D	501		502	514	
SmartCode™	915 TRL TSCR	Touchpad Electronic Deadbolt		\$370.00		\$370.00	\$370.00								2



Finishes



99150-001
Polished Brass



99150-002
Satin Nickel



99150-003
Venetian Bronze

Specifications

Function	Single cylinder deadbolt
Door Prep	2 1/8" diameter face hole & 1" diameter latch hole
Backset	Adjustable 2 3/8" or 2 3/4"
Door Thickness	1 3/8" - 2 1/8" automatic adjustment
Faceplates	1" x 2 1/4" round corner standard
Strikes	Round corner, 4 hole strike, 2 3/4" x 1 1/8"
Latch	Round corner adjustable 2 3/8" x 2 3/4"
Bolt	1" throw, steel deadbolt
Door Handing	Reversible
Cylinder	SmartKey®

Warranty

- Lifetime mechanical and finish warranty
- 1 year electronics warranty

Innovative Security

- BHMA grade 2 certified
- 20 Minute fire rating - UL certified
- Patented SecureScreen™—security feature helps to ensure that user codes cannot be identified by examining fingerprints on screen
- SmartKey® re-key technology with BumpGuard™ protection
- Revolutionary tapered deadbolt design—enables misaligned doors to lock without pulling and pushing your door shut

Easy Integration

- Replaces existing door hardware with just a screwdriver
- No hard wiring needed
- Operates on 4 AA batteries that will last for approximately 1 year

Kwikset



FEATURES

- SmartCode™ Deadbolts Replace any Deadbolt for Keyless Entry Convenience
- SmartCode™ Lever Ideal for - Small/Home Office, Utility/Storage Room, Interior Garage/Side Door
- Lock Your Door with the Touch of a Button
- Customizable Access Codes for Increased Security
- Back-Lit Keypad for Increased Visibility
- Customizable Automatic Door Locking After 30 Seconds for Peace Of Mind
- Installs In Minutes with Just a Screwdriver - No Hard Wiring Required
- Fits Standard Doors (1 3/8" - 2") with No Screw Holes Required

WARRANTY

- 1 Year Electronic Warranty
- Lifetime Finish & Mechanical Warranty

SmartCode™



		3	L03	5	11P	15	15A	26	26D	501	502	514	Qty
913 TRL SMT	Touchpad Electronic Deadbolt		\$250.00		\$250.00	\$250.00							2

SmartCode™



		3	L03	5	11P	15	15A	26	26D	501	502	514	Qty
909 CNT SMT	Touchpad Electronic Deadbolt - Contemporary				\$220.00	\$220.00		\$220.00	\$220.00				2

SmartCode™



		3	L03	5	11P	15	15A	26	26D	501	502	514	Qty
909 SMT	Touchpad Electronic Deadbolt		\$210.00		\$210.00	\$210.00							2

SmartCode™



		3	L03	5	11P	15	15A	26	26D	501	502	514	Qty
911 SMT	Touchpad Electronic Lever		\$250.00		\$250.00	\$250.00							2

Powerbolt 2®



		3	L03	5	11P	15	15A	26	26D	501	502	514	Qty
907 SMT	Touchpad Electronic Deadbolt		\$143.00		\$143.00	\$143.00							2

KWIKSET SMARTCODE™ 913

Function	Single cylinder deadbolt
Door Prep	2-1/8" diameter face hole & 1" diameter latch hole
Backset	Adjustable to 2-3/8" or 2-3/4"
Door	1-3/8" to 2" automatic adjustment
Thickness	
Cylinder	SmartKey Re-Key Technology
Faceplate	1" x 2-1/4" round corner standard
Strikes	Round corner strike 1-1/8" x 2-3/4"
Bolt	1" throw, steel deadbolt
Door Handing	Reversible

KWIKSET POWERBOLT® 907, KWIKSET SMARTCODE™ 909 DEADBOLT & 909 CONTEMPORARY DEADBOLT

Door Prep	2-1/8" diameter face hole & 1" diameter latch hole
Backset	Adjustable to 2-3/8" or 2-3/4"
Door	1-3/8" to 2" automatic adjustment
Thickness	
Cylinder	SmartKey Re-Key Technology
Faceplate	1" x 2-1/4". Round corner standard
Strikes	Round corner strike 1-1/8" x 2-3/4"
Bolt	1" throw
Door Handing	Reversible
Batteries	4 AA

KWIKSET SMARTCODE™ 911 LEVER

Door Prep	2-1/8" diameter face hole & 1" diameter latch hole
Backset	Adjustable to 2-3/8" or 2-3/4"
Door	1-3/8" to 2" automatic adjustment
Thickness	
Cylinder	SmartKey Re-Key Technology
Faceplate	1" x 2-1/4". Round corner standard
Strikes	2-1/4" full lip. Round corner
Bolt	1/2" throw
Door Handing	Reversible
Batteries	4 AA

SMARTCODE™ 911 LEVER

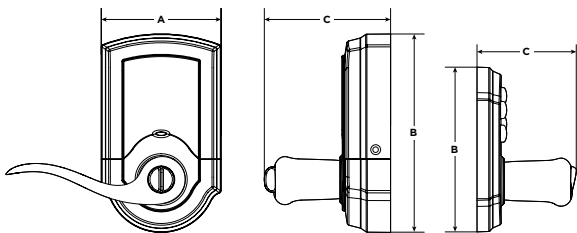

Design	A	B	C
Outer Trim	2-13/16"	4-7/16"	2-11/16"
Inner Trim	3-1/4"	5-3/8"	3-13/32"

NOTE: Lifetime Finish and Mechanical Warranty. One Year Electronic Warranty.

KWIKSET SMARTCODE™ 913

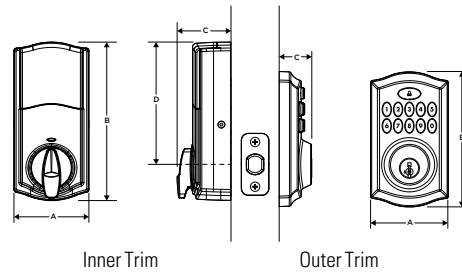

Design	A	B	C	D
Outer Trim	2-7/8"	5"	1-3/16"	
Inner Trim	2-3/4"	5-3/4"	2"	4-7/16"

SMARTCODE™ 909 CONTEMPORARY

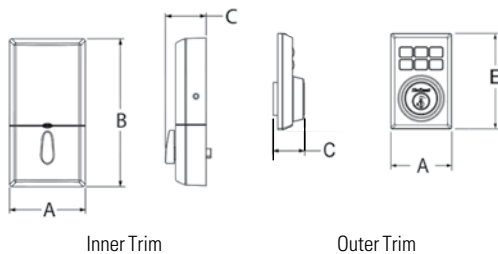

Design	A	B	C
Outer Trim	2-23/32"	4-1/4"	1-3/16"
Inner Trim	3-9/32"	6-13/32"	1-3/4"

SMARTCODE™ 909

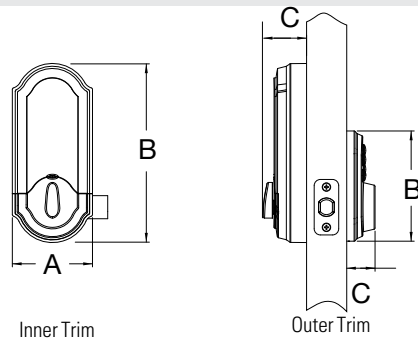

Design	A	B	C
Outer Trim	2-13/16"	4-7/16"	1-3/16"
Inner Trim	3-1/4"	7-1/4"	1-3/4"

POWERBOLT® 907

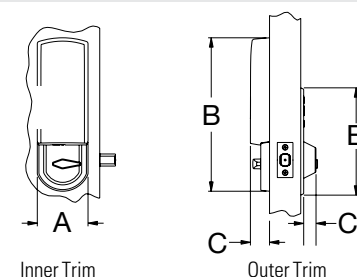

Design	A	B	C
Outer Trim	2-29/32"	6-7/8"	1-1/8"
Inner Trim	3-1/4"	9-27/32"	1-9/32"

Interconnect



Model	Function	Style	Deadbolt	Finish								
				3	L03	5	11P	15	15A	26	26D	
506	Entry	Hancock	780	\$212.00	\$217.00	\$212.00	\$217.00	\$217.00	\$217.00	\$217.00	\$217.00	\$212.00
		Commonwealth	780	\$212.00	\$217.00		\$217.00	\$217.00				
		Tustin	780	\$212.00		\$212.00	\$217.00	\$217.00	\$217.00	\$217.00	\$217.00	\$212.00
		Kingston	780	\$212.00								\$212.00
506 SMT	Entry	Hancock	780	\$212.00	\$217.00	\$212.00	\$217.00	\$217.00	\$217.00	\$217.00	\$217.00	\$212.00
		Commonwealth	780	\$212.00	\$217.00		\$217.00	\$217.00				
		Tustin	780	\$212.00		\$212.00	\$217.00	\$217.00	\$217.00	\$217.00	\$217.00	\$212.00
		Kingston	780	\$212.00								\$212.00
508	Passage	Hancock	780	\$197.00	\$202.00	\$197.00	\$202.00	\$202.00	\$202.00	\$202.00	\$202.00	\$197.00
		Commonwealth	780	\$197.00	\$202.00		\$202.00	\$202.00				
		Tustin	780	\$197.00		\$197.00	\$202.00	\$202.00	\$202.00	\$202.00	\$202.00	\$197.00
		Kingston	780	\$197.00			\$202.00	\$202.00				\$197.00
508 SMT	Passage	Hancock	780	\$197.00	\$202.00	\$197.00	\$202.00	\$202.00	\$202.00	\$202.00	\$202.00	\$197.00
		Commonwealth	780	\$197.00	\$202.00		\$202.00	\$202.00				
		Tustin	780	\$197.00		\$197.00	\$202.00	\$202.00	\$202.00	\$202.00	\$202.00	\$197.00
		Kingston	780	\$197.00			\$202.00	\$202.00				\$197.00

- 506 & 505 interconnect functions utilize turn button locking
- Split finish options available

Interconnect Levers - 660 Deadbolt Options

Model	Function	Style	Deadbolt	Finish								
				3	L03	5	11P	15	15A	26	26D	
505	Entry	Kingston		\$197.00		\$197.00						\$197.00
507	Passage	Kingston		\$182.00		\$182.00						\$182.00

Interconnect Knobs & Levers - Handleset Interior Pack Options

Model	Function	Style	Deadbolt	Finish								
				3	L03	5	11P	15	15A	26	26D	
		Hancock		\$125.00		\$125.00	\$130.00	\$130.00	\$130.00	\$130.00	\$130.00	\$125.00
		Commonwealth		\$125.00		\$125.00	\$130.00	\$130.00	\$130.00	\$130.00	\$130.00	\$125.00
		Tustin		\$125.00		\$125.00	\$130.00	\$130.00	\$130.00	\$130.00	\$130.00	\$125.00
		Laurel		\$125.00		\$125.00	\$130.00	\$130.00	\$130.00	\$130.00	\$130.00	
		Kingston		\$125.00								\$125.00

Key Control Deadbolt



Model	Function	Deadbolt	Finish								Case
			3	L03	5	11P	15	15A	26	26D	
816 SMT	Key Control Deadbolt		\$60.00		\$68.00	\$68.00	\$68.00			\$68.00	12
817 SMT UL	Key Control Deadbolt UL		\$66.00		\$74.00	\$74.00	\$74.00			\$74.00	12

INTERCONNECT

Door Prep	Crossbore 2 1/8" Edge Bore 1" 5-1/2" center-to-center only.
Backset	Complete locksets: 2-3/4" UL or 2 3/8" UL
Door Thickness	1-3/4" and 2-1/4".
Cylinder	506, 508 - utilize 6-pin or SmartKey on 780 deadbolt. 505, 507 - utilize 5-pin on 660 deadbolt. 502 - determined by handleset ordered. SmartKey or Pin & Tumbler.
Faceplate	Complete locksets: No default—must specify faceplate. 1" round corner, 1" square corner, 1-1/8 WFL square. Complete locksets: UL 3028, 3031, (WFL option 3846).
Strikes	Deadbolt Strike: UL 5278, 3223 (WFL 4632 opt.).
Handing	506, 508, 505, 507 - reversible. 502 - specify handing.
ANSI/BHMA	506, 508, 505, 507 - Grade 3 Certified 502 - Determined by handleset ordered.
ADA	All lever options meet 4.13.9 ADA requirements.
UL	Meets UL 3 hour fire rating for all functions except 502.
Interior Locking	Push button (for Kingston & Carson) Turn button (for Interconnect)

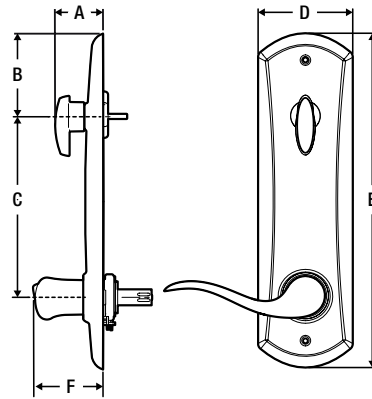

Design	A	B	C	D	E	F
Interconnect	1-7/16"	2-15/32"	5-1/2"	2-53/64"	10"	2-31/32"

KEY CONTROL

SPECIFICATIONS:

Standard Door Prep	Cross Bore 2-1/8". Edge Bore 1" Latch Face 1" x 2-1/4"
Door Thickness	1-3/4" or 1-3/8" (with adaptor kit)
Cylinder	2 SmartKey® cylinders: 1 standard Kwikset for users, 1 unique patented keyway for 1-Key Control
Faceplate	1" x 2-1/4"
Strike	1-1/4" x 3-5/8"
Bolt	1" throw
ANSI/BHMA	Grade 2 Certified
ADA	Interior turn piece meets 4.13.9 ADA
UL	Meets UL 3 hour fire rating for 817 UL Optional 1/3 hour UL fire rating for all functions

FUNCTIONS:

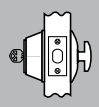

816 Key Control Deadbolt
817 UL Key Control Deadbolt

Deadbolt operated by key outside and thumb turn inside.

DIMENSIONS:

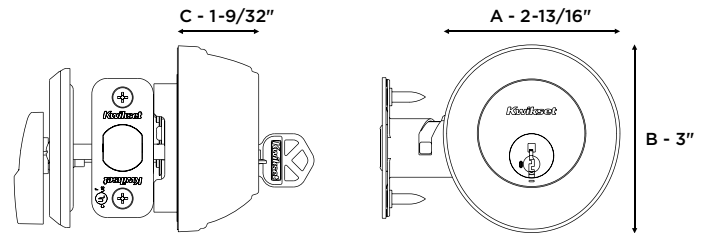

FINISHES:

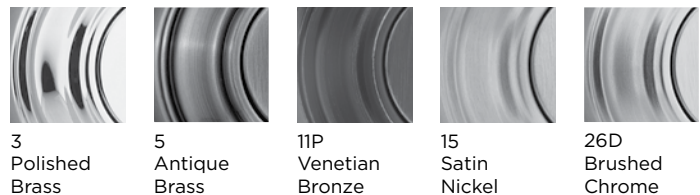

Grade 2 Levers

Model	Function	Finish								Case	
		3	L03	5	11P	15	15A	26	26D	Qty	
 Kingston™	721KNL	Hall/Closet UL	\$45.00			\$50.00	\$50.00			\$45.00	12
	733KNL	Bed/Bath UL	\$48.00			\$53.00	\$53.00			\$48.00	12
	756KNL	Keyed Entry UL	\$72.00			\$77.00	\$77.00			\$72.00	12
	756KNL SMT	Keyed Entry UL	\$72.00			\$77.00	\$77.00			\$72.00	12
	781KNL	Storeroom UL	\$75.50			\$80.50	\$80.50			\$75.50	12
	781KNL SMT	Storeroom UL	\$75.50			\$80.50	\$80.50			\$75.50	12
	788KNL	Half Dummy	\$22.50			\$27.50	\$27.50			\$22.50	20

Grade 3 Levers

Model	Function	Finish								Case	
		3	L03	5	11P	15	15A	26	26D	Qty	
 Carson™	407CNL	Hall/Closet UL	\$32.00			\$37.00	\$37.00			\$32.00	12
	408CNL	Bed/Bath UL	\$35.00			\$40.00	\$40.00			\$35.00	12
	438CNL	Keyed Entry UL	\$59.00			\$64.00	\$64.00			\$59.00	12
	438CNL SMT	Keyed Entry UL	\$59.00			\$64.00	\$64.00			\$59.00	12
	439CNL	Storeroom UL	\$62.50			\$67.50	\$67.50			\$62.50	12
	439CNL SMT	Storeroom UL	\$62.50			\$67.50	\$67.50			\$62.50	12
	488CNL	Half Dummy	\$13.00			\$18.00	\$18.00			\$13.00	20

Model	Function	Finish								Case	
		3	L03	5	11P	15	15A	26	26D	Qty	
 Burbank™	407BBL	Hall/Closet UL	\$32.00			\$37.00	\$37.00		\$37.00		12
	408BBL	Bed/Bath UL	\$35.00			\$40.00	\$40.00		\$40.00		12
	438BBL	Keyed Entry UL	\$59.00			\$64.00	\$64.00		\$64.00		12
	439BBL	Storeroom UL	\$62.50			\$67.50	\$67.50		\$67.50		12
	488BBL	Half Dummy	\$13.00			\$18.00	\$18.00		\$18.00		20

KINGSTON LEVER

ANSI/BHMA	Grade 2 Certified
Door Prep	Crossbore 2-1/8" Edge Bore 1"
Backset	Adjustable to 2-3/8" or 2-3/4"
Door Thickness	1-3/8" – 1-3/4" standard
Cylinder	SmartKey or Pin & Tumbler
Latch	Adjustable to 2-3/8" or 2-3/4" Specify round corner or square corner, WFL.
Strikes	2-1/4" full lip UL. Specify round corner or square corner. Other options include 2-3/4" T-Strike and 4-7/8" ASA.
Bolt	1/2" throw
Door Handling	Reversible for right or left-hand doors.
ADA	Lever functions satisfy 4.13.9 ADA requirements.
UL	Meets UL 3 hour fire rating for all functions
Warranty	Lifetime Mechanical, 5 Year Finish
Interior Locking	Push button (for Kingston & Carson) Turn button (for Interconnect)

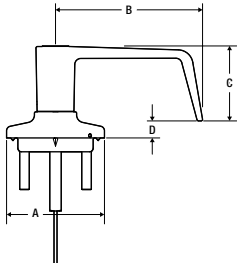

Design	A	B	C	D
Kingston	2.56"	3.84"	1.96"	.44"

CARSON LEVER

ANSI/BHMA	Grade 3 Certified
Door Prep	Crossbore 2-1/8" Edge Bore 1"
Backset	Adjustable to 2-3/8" or 2-3/4"
Door Thickness	1-3/8" – 1-3/4" standard
Cylinder	SmartKey or Pin & Tumbler
Latch	Adjustable to 2-3/8" or 2-3/4" Specify round corner or square corner, WFL.
Strikes	2-1/4" full lip UL. Specify round corner or square corner. Other options include 2-3/4" T-Strike and 4-7/8" ASA.
Bolt	1/2" throw
Door Handling	Reversible for right or left-hand doors.
ADA	Lever functions satisfy 4.13.9 ADA requirements.
UL	Meets UL 3 hour fire rating for all functions.
Warranty	Lifetime Mechanical, 5 Year Finish
Interior Locking	Push button (for Kingston & Carson) Turn button (for Interconnect)

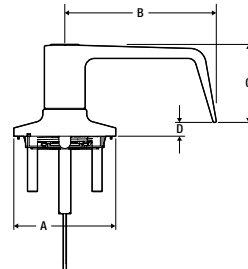

Design	A	B	C	D
Carson	2.56"	3.80"	1.96"	.35"

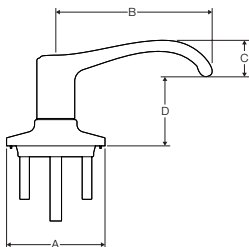

BURBANK LEVER

ANSI/BHMA	Grade 3 Certified
Door Prep	Crossbore 2-1/8" Edge Bore 1"
Backset	Adjustable to 2-3/8" or 2-3/4"
Door Thickness	1-3/8" – 1-3/4" standard
Cylinder	SmartKey or Pin & Tumbler
Latch	RCAL, SCAL, WFAL, NFL
Strikes	ASA-1 t-strike, Full Lip SCS UL, Full Lip 1/4" RCS UL, T Strike
Bolt	1/2" throw
Door Handling	Reversible for right or left-hand doors.
ADA	Lever functions satisfy 4.13.9 ADA requirements.
UL	Meets UL 3 hour fire rating for all functions
Warranty	Lifetime Mechanical, 5 Year Finish





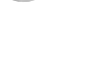

Design	A	B	C	D
Burbank	2.6"	4.07"	0.94"	1.79"





Kwikset

PRODUCT	Model	Function	Finish								Pkg	Case	
			3	L03	5	11P	15	15A	26	26D			514
Redmond™													
	079RDB	24" Towel Bar	\$30.30			\$49.50	\$38.50		\$27.50			BP	6
	080RDB	Towel Ring	\$20.80			\$33.00	\$24.20		\$16.50			BP	6
	081RDB	Tissue Holder	\$22.70			\$34.10	\$27.50		\$22.00			BP	6
	082RDB	Robe Hook	\$8.70			\$12.10	\$12.10		\$8.80			BP	6



PRODUCT	Model	Function	Finish								Pkg	Case	
			3	L03	5	11P	15	15A	26	26D			514
Ashfield™													
	0795ADB	24" Double Towel Bar				\$168.30	\$168.30		\$113.30			CP	4
	079ADB	24" Towel Bar				\$98.20	\$98.20		\$60.50			CP	4
	080ADB	Towel Ring				\$64.90	\$64.90		\$42.90			CP	4
	081ADB	Tissue Holder				\$70.40	\$70.40		\$45.10			CP	4
	082ADB	Robe Hook				\$38.50	\$38.50		\$27.50			CP	4



PRODUCT	Model	Function	Finish								Pkg	Case	
			3	L03	5	11P	15	15A	26	26D			514
Avalon™													
	079AVB	24" Towel Bar				\$73.70	\$73.70		\$49.50			CP	4
	080AVB	Towel Ring				\$52.80	\$52.80		\$35.20			CP	4
	081AVB	Tissue Holder				\$57.20	\$57.20		\$37.40			CP	4
	082AVB	Robe Hook				\$31.90	\$31.90		\$23.10			CP	4



Pocket Door Locks

Round	Model	Function	Finish									Case Qty
			3	L03	5	11P	15	15A	26D	32	3x32	
	334	Passage	\$32.90		\$32.90	\$32.90	\$32.90	\$32.90	\$32.90	\$32.90		12



Round	Model	Function	Finish									Case Qty
			3	L03	5	11P	15	15A	26D	32	3x32	
	335	Privacy	\$36.50		\$36.50	\$36.50	\$36.50	\$36.50	\$36.50	\$36.50	\$36.50	12



Notch	Model	Function	Finish									Case Qty
			3	L03	5	10B	15	15A	26D	32	3x32	
	332	Passage	\$30.15		\$32.25						\$31.55	12



Notch	Model	Function	Finish									Case Qty
			3	L03	5	10B	15	15A	26D	32	3x32	
	333	Privacy	\$33.90		\$36.20						\$35.50	12









SmartKey Padlocks

Part #	Description	List Price	Case Qty
026SMT STD 1-1/8" SHKL PDL 50MM	SmartKey Padlock Standard Shackle	\$24.40	6
026SMT LNG 2" SHKL PDL 50MM	SmartKey Padlock Long Shackle Shackle	\$25.46	6

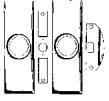
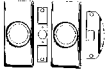

- Keyed alike 6

Kwikset

Trims	Model	Description	Dimensions	Finish				Case	
				3	5	15	26D	Pkg	Qty
	214	Large Modernization Kit	3-1/2" x 10-1/2"	\$68.25				CP	10
	215	Small Modernization Kit	3-3/8" x 7-1/4"	\$47.80				CP	10
	239	Curved Colonial		\$60.90	\$64.50	\$61.70	\$61.70	CP	10
	249	Medium Rectangular Rosette	3-3/8" x 7-1/4"	\$21.45				CP	5
	262	Vertical Combo (CTC 3-5/8")	3-1/2" x 8-1/2"	\$31.95	\$36.50		\$35.60	CP	5
	263	Large Vertical Combo (CTC 5-1/2")	3-1/2" x 10-1/2"	\$31.95				CP	5
	288	Small Rectangular Rosette	3-15/16" x 4-7/32"	\$20.55				CP	5
	293	Round Rosette	3-13/16"	\$15.50	\$17.55	\$16.35	\$16.35	CP	4

138 Installation

Kit	Part #	Description	List Price	Qty per Pack	Master Pk Qty
	91380-001	138 Installation Kit	\$608.85	1	1
	89900-001	Jig with Wood Arm Guide	\$290.20	1	1
	89901-001	Wood Door In-Line Guide Arm	\$64.15	1	1
	89902-001	Metal Door In-Line Guide Arm	\$64.15	1	1

138 Installation

Kit Drill Bits	Part #	Description	List Price	Qty per Pack	Master Pk Qty
	89903-001	1" Spade Bit	\$21.45	1	3
	89904-001	2-1/8" Multi Spur Bit	\$94.40	1	3
	89905-001	1-1/2" Multi Spur Bit	\$78.45	1	3
	89906-001	2-1/8" Hole Saw Bit	\$19.75	1	3
	89907-001	Hole Saw Mandrel	\$19.75	1	1
	89908-001	Snap Rings	\$12.60	6	3

Kwikset

138 Installation

Kit Mortise Tools

Part #	Description	List Price	Qty per Pack	Master Pk Qty
89909-001	Full Lip Strike Mortise Tool	\$35.60	1	3
89910-001	Full Lip Round Corner Strike Blades	\$10.65	3	3
89911-001	Full Lip Square Corner Strike Blades	\$10.65	3	3
89912-001	Latch Mortise Tool	\$37.50	1	3
89913-001	Latch Round Corner Blades	\$12.60	3	3
89914-001	Latch Square Corner Blades	\$12.60	3	3
89915-001	Strike Mortise Tool	\$39.20	1	1
89916-001	Strike Square Corner Blades	\$14.50	3	3
89917-001	Strike Round Corner Blades	\$14.50	3	3

138 Installation

Kit Miscellaneous

Parts

Part #	Description	List Price	Qty per Pack	Master Pk Qty
89918-001	Quick Bit Changer	\$25.10	1	1
89919-001	Strike Locator	\$5.70	1	1
89920-001	Strike Locator Tip	\$7.65	3	1
89921-001	Kit Box	\$32.05	1	1
89922-001	Jig Bushing	\$24.60	3	1
89923-001	1-1/2" Adapter Ring	\$11.30	1	1
89924-001	663 Boring Depth Stop	\$3.65	1	1
89925-001	Boring Template	\$3.30	1	1
89926-001	1/8" Hex Wrench	\$1.00	1	1

Wood Door

Installation Kit

Part #	Description	List Price	Qty per Pack	Master Pk Qty
91300-001	130WD Wood Door Installation Kit	\$31.35	1	3



Kwikset

KEYS & KEY BLANKS

Kwikset Key Blanks

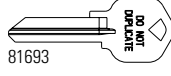
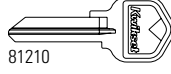
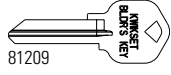
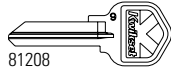
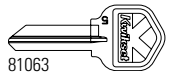

Model	Function	Qty.	List Price
81063-009	K Bow, Nickel Plated, 5 Pin	50	\$1.45/E
81208-001	K Bow, Nickel Plated, 6 Pin	50	\$1.45/E
81209-001	Solid Bow Builders Key - Brass Color	50	\$1.45/E
81210-001	Solid Bow Masters Key	50	\$1.45/E
81693-001	Do Not Duplicate Key	50	\$1.45/E
83559-008	Large Bow, Builder Key, 6 Pin	50	\$1.45/E
81695-001	Large Bow, Builder Key, 5 Pin	50	\$1.45/E
82245-001	Baldwin K-Key	50	\$2.00/E

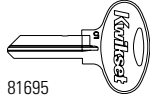
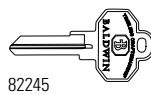
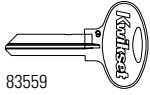

Control Key Blanks (Rekeying Tools)



87615-001	Kwikset 6-Pin Knobs and Deadbolts	50	\$1.45/E
88122-001	Kwikset 6-Pin Knobs and Deadbolts, MK	50	\$1.45/E
88485-005	Kwikset Knobs and Deadbolts, Schlage® C	12	\$1.45/E
81804-001	Kwikset Key-In Lever, Standard "TC"	50	\$1.45/E
89991-001	Kwikset, Schlage® C	50	\$1.45/E

Emergency Key

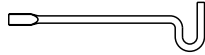

81087-001	For All Privacy Function Locksets	100	\$0.40/E
-----------	-----------------------------------	-----	----------

Depth Key

88596-001	Depth Key Ring (Order in full pack quantities only)	5	\$7.70/E
-----------	---	---	----------

Extra Cut Keys

KWIKSET 6 Pin

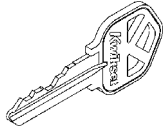

Random Cut	*Specify Cut		
81208-002	90009-074	Regular Key	\$2.80
81389-001		Set of 2 Keys/ Ringed	\$4.40
81211-001		Set of 2 Keys w/ Control Key	\$4.40
81210-002	90009-066	Master Key	\$3.65
81209-002	90009-069	Builder Key - Brass Color	\$2.80
	90009-082	Control Key	\$1.45

Extra Cut Keys

KWIKSET 5 Pin

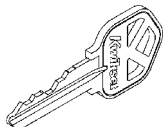

Random Cut	*Specify Cut		
81063-005		Regular Key	\$1.80
81057-002		Set of 2 Keys/ Ringed	\$4.40
85991-001	90009-003	Master Key	\$3.05
82205-001	90009-004	Builder Key	\$2.55

***NOTE:** Must specify desired key cut when placing order.

KEYING CHARGES & SUPPLIES

	Model	Function	Qty.	List Price
Competitive Keying Program - Replacement Parts	8486-75	780/785 Deadbolt, Schlage® keyway less cylinder cover (3, 26)	6	\$13.40/E
	8486-76	780/785 Deadbolt, Weiser keyway less cylinder cover (3, 26)	6	\$13.40/E
	8497-75	Kwikset Signature Series Knob, Schlage® keyway less cylinder cover (3, 26)	6	\$13.40/E
	8497-76	Kwikset Signature Series Knob, Weiser keyway less cylinder cover (3, 26)	6	\$13.40/E
	81354	Kwikset Signature Series Laurel Knob, Weiser cylinder (3, 26D)	6	\$19.05/E
	81355	Kwikset Signature Series Laurel Knob, Schlage® cylinder (3, 26D)	6	\$19.05/E
	81327	780/785 Deadbolt single cylinder cover - exterior (15, 15A, 26, 26D, 3, 5, L03,11P)	12	\$1.10/E
	81328	780/785 Deadbolt double cylinder cover - interior (3, 5, 11P)	12	\$1.10/E
	87748-001	Knob plug - Kwikset 6 pin brass finish	20	\$1.60/E
	87807-001	Deadbolt plug - Kwikset Signature Series 6-pin brass finish	20	\$1.60/E
	87807-002	Deadbolt plug - Kwikset Signature Series 6-pin nickel finish	20	\$1.60/E
	88485-005	Rekeying Tool - Schlage®	12	\$1.10/E

NOTES:

Order in full pack quantities only. Must specify finish in order.
Competitive keying program not compatible with SmartKey product.

Keying Kits

92360-001	236 Builder Pin Kit - small	1	\$134.55
92720-001	272 Pin Kit	1	\$237.75

Specialty Keying Charges

Master Keying	MK	\$2.55
Builder Keying (Protecto)	PK	\$2.55
Grand Master Keying	GMK	\$7.15
Builder Master Keying	PMK	\$4.40
Cross Keying / Maison Keying	MAIS	\$5.30
Sequential Construction Master Keying	SEQ	\$8.70

**KEYING CHARGES
& SUPPLIES**

	Model	Function	Bottom Pin Size	Qty.	List Price
Competitive Replacement Pins	88550-023		0.156	50	\$0.15/E
	88550-024		0.165	50	\$0.15/E
	88550-025		0.168	50	\$0.15/E
	88550-026		0.172	50	\$0.15/E
	88550-027		0.180	50	\$0.15/E
	88550-028		0.187	50	\$0.15/E
	88550-029		0.195	50	\$0.15/E
	88550-030		0.204	50	\$0.15/E
	88550-031		0.210	50	\$0.15/E
	88550-032		0.218	50	\$0.15/E
	88550-033		0.220	50	\$0.15/E
	88550-034		0.225	50	\$0.15/E
	88550-035		0.234	50	\$0.15/E
	88550-036		0.240	50	\$0.15/E
	88550-037		0.250	50	\$0.15/E
	88550-038		0.255	50	\$0.15/E
	88550-039		0.258	50	\$0.15/E
	88550-040		0.265	50	\$0.15/E
	88550-041		0.270	50	\$0.15/E
	88550-042		0.276	50	\$0.15/E
88550-043		0.287	50	\$0.15/E	
88550-044		0.294	50	\$0.15/E	
88550-045		0.300	50	\$0.15/E	



NOTE: Competitive replacement pins are not compatible with SmartKey product.

**Kwikset Keying
Parts**

80049-001	Key Gauge			1	\$6.55
80152-001	Plug Follower			1	\$7.05
80369-001	PK Anti-Pick Top Pin .160"			100	\$0.35/E
80370-001	Regular Anti-Pick Top Pin .180"			100	\$0.35/E
80371-001	Low Profile Deadbolt Spring Cover			10	\$1.10/E
81467-003	Cylinder Removal Tool			1	\$1.70
81777-001	Tumbler Spring			100	\$0.15/E
81858-001	Regular Top Pin .180"			100	\$0.15/E
82208-001	PK Balls			100	\$0.15/E
83100-001	#1 Bottom Pin .172"			100	\$0.15/E
83101-001	#2 Bottom Pin .195"			100	\$0.15/E
83103-001	#3 Bottom Pin .218"			100	\$0.15/E
83105-001	#4 Bottom Pin .241"			100	\$0.15/E
83106-001	#5 Bottom Pin .264"			100	\$0.15/E
83107-001	#6 Bottom Pin .287"			100	\$0.15/E
83108-001	#1 Master Pin .023"			100	\$0.15/E
83110-001	#2 Master Pin .046"			100	\$0.15/E
83112-001	#3 Master Pin .069"			100	\$0.15/E
83113-001	#4 Master Pin .092"			100	\$0.15/E
83114-001	#5 Master Pin .115"			100	\$0.15/E
83117-001	PK Top Pin .160"			100	\$0.15/E
83125-001	#6 Master Pin .138"			100	\$0.15/E
83561-001	Spring Cover (6-Pin)			50	\$1.00/E
84345-001	Knob Plug Retainer			100	\$0.15/E
84215-001	Deadlock Plug Retainer			100	\$0.15/E
85757-001	Spring Cover (5-Pin)			50	\$1.00/E
87619-001	Knob Control Lug (Locking Bar)			100	\$0.35/E
87632-001	Spring			100	\$0.50/E
87809-001	Deadlock Control Lug (Locking Bar)			100	\$0.60/E

Kwikset

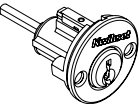
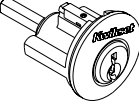
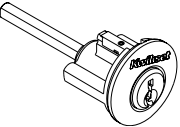
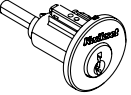
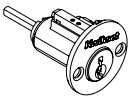
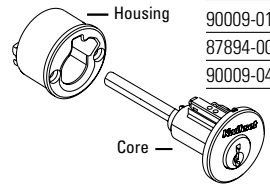
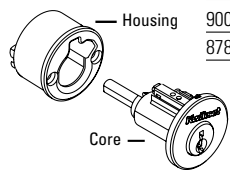
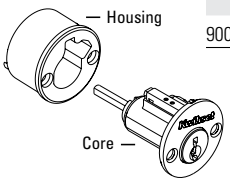
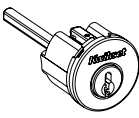
DEADBOLT CYLINDERS

	Model	Function	List Price
	90009-016	2776 - 665 Interior (5 PIN)	\$13.80
	90009-017	2777 - 665 Exterior (5 PIN)	\$13.80
	90009-041	15843 - 660 Exterior (5 PIN)	\$13.80
	90009-045	785 Exterior without Housing (6 PIN)	\$15.60
	NOTE: Must specify finish when ordering cylinders		
	90009-046	785 Interior without Housing (6 PIN)	\$15.60
	90009-010	87765 - 780 with Housing, Complete Assembly	\$20.10
	87894-001	07894-01 Housing Only, Outside	\$4.50
	90009-044	8325 - 780 Core without Housing	\$15.60
	90009-019	7766 - 785 Exterior with Housing, Complete Assembly	\$20.10
	87894-001	07894-01 Housing Only, Outside	\$4.50
	90009-020	7767 - 785 Interior with Housing, Complete Assembly	\$20.10
	90009-065	13443 980/993 CYL G1 (6 PIN)	\$40.80
	81227	13423 CVR BDY EXT G1	\$1.10
	90009-078	13448 985/994 CYL Interior (6 PIN)	\$41.75
	90009-079	13450 985/994 CYL Exterior (6 PIN)	\$40.80
	NOTE: Must specify finish when ordering cylinders		

Kwikset

KNOB CYLINDERS

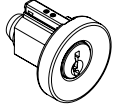
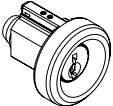
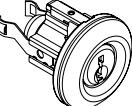
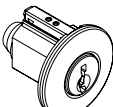
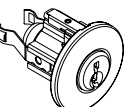
	Model	Function	List Price
	90009-011	7750A - Abbey (6 PIN)	\$12.60
	90009-012	13754 - Circa (6 PIN)	\$12.60
	90009-042	15860 - Polo (5 PIN)	\$16.95
	90009-043	13752 - Hancock (6 PIN)	\$12.60
	90009-013	1850 - All Other Kwikset & Kwikset Signature Knobs	\$16.95

LEVER CYLINDERS

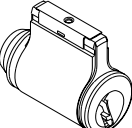
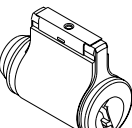
	Model	Function	List Price
	90009-077	24042 - 405 Lever/Gibson Handleset (5 PIN)	\$14.40
	90009-076	21664 Kwikset Signatures Lever Cylinder (6 PIN)	\$14.40

LIGHT COMMERCIAL LEVER CYLINDERS

Model	Function	Finish											List Price	
		3	L03	5	15	15A	26	26D	690/11P	501	502	514		NA
83525	14831 Light Commercial Grade 2 P&T Entry Cylinder	•			•			•	•					\$13.10
83011	14845 Light Commercial Grade 3 P&T Entry Cylinder	•			•			•	•					\$13.10
83526	19496 Light Commercial Grade 2 P&T Storeroom Cylinder	•			•			•	•					\$13.10
83528	19497 Light Commercial Grade 3 P&T Storeroom Cylinder	•			•			•	•					\$13.10

SMARTKEY CYLINDERS

Model	Function	Finish												List Price
		3	L03	5	15	15A	26	26D	690/11P	501	502	514	NA	
83279	SMT Knob/Lever Cylinder Only	Gold			Silver				Bronze			Black		\$18.55
83373	SMT Deadbolt Cylinder Only (SGL CYL)	Gold			Silver				Bronze			Black		\$18.55
83025	SMT Deadbolt Cylinder Only for 258 Model	Gold			Silver							Black		\$18.55
83280	SMT CN, C, H, T, CV Cylinder with Housing	•		•	•	•	•	•	•	•	•	•		\$20.70
83320	SMT CA, A with Housing	•	•	•	•	•	•	•	•					\$20.70
83281	SMT SGL CYL DB with Housing 780/980/993		•	•	•	•	•	•	•	•	•	•		\$41.35
83343	SMT SGL CYL DB with Housing 660	•		•	•	•	•	•	•					\$19.85
83344	SMT DBL CYL DB with Housing 665 Interior & Exterior	•		•	•	•	•	•	•					\$39.70

SMARTKEY RE-KEY KITS

Model	Function	Finish												List Price
		3	L03	5	15	15A	26	26D	690/11P	501	502	514	NA	
83262	Carded CP Re-key Kit (4 silver/2 brass)												•	\$13.70
83335	4 cut keys with re-key tool												•	\$4.85
83336	6 cut keys with re-key tool												•	\$5.45

SMARTKEY CONVERSION KITS

Model	Function	Finish												List Price
		3	L03	5	15	15A	26	26D	690/11P	501	502	514	NA	
83325	Abbey & Circa	•	•	•	•	•	•	•	•					\$24.20
83328	Cameron, Copa, Hancock, Tylo & Cove	•	•	•	•	•	•	•	•	•	•	•		\$24.20
83377	Polo	•		•	•	•	•	•	•					\$24.20
83326	780/800/980/993	•	•	•	•	•	•	•	•	•	•	•		\$43.55
83327	785	•	•	•	•	•	•	•	•	•	•	•		\$60.50
83340	801/985/994		•	•	•	•	•	•	•	•	•	•		\$60.50

RE-KEYING TOOLS

Model	Function	Finish												List Price
		3	L03	5	15	15A	26	26D	690/11P	501	502	514	NA	
83282	Steel Learn Tool												•	\$0.10
83283	Red Plastic KW Learn Tool												•	\$2.75
83260	Reset Cradle												•	\$41.15
83338	Large Knob/Lever C-Clip (Pack of 50)												•	\$30.25
83337	Large Deadbolt C-Clip (Pack of 50)												•	\$30.25
83374	SmartKey Round Spindle (Knob)												•	\$0.90

KEY CONTROL DEADBOLT PARTS

	Model	Function	Finish					Qty	List Price	
			3	5	11P	15	26D			N/A
	83382	Key Control Deadbolt Key Blanks						•	10	\$3.05/E
	83383	Key Control Deadbolt Cut Keys						•	10	\$3.65/E
	83389	Key Control Deadbolt Cylinder Cover	•	•	•	•	•		1	\$2.40
	83390	Key Control Deadbolt Mounting Screws	Gold		Bronze	Silver			1	\$5.45
	83388	Key Control Deadbolt Torque Blade						•	10	\$1.60/E
	83386	Key Control Deadbolt Gear Assembly						•	1	\$6.05
	83387	Key Control Deadbolt Screws for Gear Assembly						•	1	\$1.20
	83392	Key Control Deadbolt Tool						•	1	\$3.65
	83393	Key Control Deadbolt Security Mounting Screws	Gold	Gold	Bronze	Silver	Silver		1	\$3.65
	83394 83395	Key Control Deadbolt Screw Torx Wrench						•	1	\$4.85
	83397	Key Control Deadbolt Thin Door Kit	•			•	•		1	\$12.00

Kwikset

DEADBOLT ADJUSTABLE LATCHES

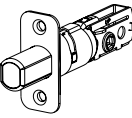
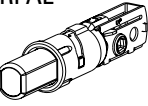
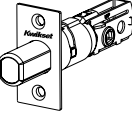
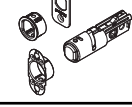
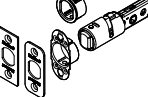
	Model	Function	Finish							List Price	
			3	5	15	15A	26/26D	690/11P	514		NA
	81305	660 Series Deadbolt Standard	•	•	•	•	•	•	•	•	\$9.15
	81258	816/980 Series Deadbolt Standard UL	•		•		•	•			\$23.65
	83347	780/816/980/993 Series Deadbolt Standard	•	•	•	•	•	•	•		\$14.30
	80391	Tapered Bolt Deadbolt*	•		•			•			\$23.65
	*Replacement Only										
	81306	660 Series Deadbolt Standard								•	\$9.15
	83371	780 /816/980/993 Series Deadbolt Standard								•	\$14.30
	80393	Tapered Bolt Deadbolt*	•		•			•			\$23.65
	*Replacement Only										
	81308	660 Series Deadbolt Standard	•	•	•	•	•	•			\$9.15
	84513	780 Series Deadbolt Standard UL	•	•	•	•	•	•			\$17.15
	81257	816/980 Series Deadbolt Standard UL	•		•		•	•			\$23.65
	83370	780/816/980/993 Series Deadbolt Standard	•	•	•	•	•	•	•		\$14.30
	80392	Tapered Bolt Deadbolt*	•		•			•			\$23.65
	*Replacement Only										
	83002	4-WAL HFL, MIL, LSL, MRL, SYL				•		•	•		\$18.00
	83023	6AL 258 Series Deadbolt			•		•	•			\$20.00

DEADBOLT SPECIALTY LATCHES

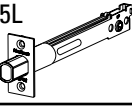
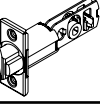
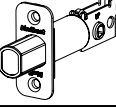
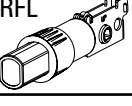
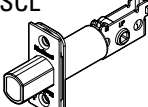
	Model	Function	Finish							List Price	
			3	5	15	15A	26/26D	690/11P	514		NA
	82730	5" Kwikset (replacement part only)	•	•			•				\$13.80
	83277	Gatelatch Standard	•	•			•				\$22.65
	82731	2-3/8" Backset	•	•			•	•			\$10.05
	82732	2-3/4" Backset	•	•			•	•			\$10.05
	82734	2-3/8" Backset								•	\$10.05
	82735	2-3/4" Backset								•	\$10.05
	82728	2-3/8" Backset	•	•			•	•			\$10.05
	82729	2-3/4" Backset	•	•			•	•			\$10.05

Kwikset

ADJUSTABLE LATCHES (SQUARE DRIVE)

KNL, CNL, HFL, MIL

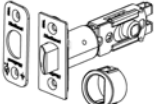
6WAL	Model	Function	Finish							List Price	
			3/L03	5	15	15A	26/26D	690/11P	514		NA
	83480	6WAL Plain Latch HFL, MIL, LSL, MRL, SYL			•		•	•	•		\$12.00
	83000	6WAL Deadlatch KNL, CNL, HFL, MIL, LSL, MRL, SYL			•		•	•	•		\$13.00

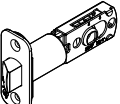
RCAL	Model	Function	Finish							List Price	
			3	5	15	15A	26/26D	690/11P	514		NA
	83521	RCAL Plain Latch UL KNL, CNL	•		•		•	•			\$10.30
	83518	RCAL Deadlatch UL KNL, CNL, HFL, MIL, LSL, MRL, SYL	•		•		•	•			\$11.90

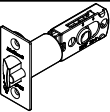
WFAL	Model	Function	Finish							List Price	
			3	5	15	15A	26/26D	690/11P	514		NA
	83522	WFAL SCL Plain Latch UL KNL, CNL	•		•		•	•			\$10.30
	83010	WFAL SCL Deadlatch UL KNL, CNL, HFL, MIL, LSL, MRL, SYL	•		•		•	•			\$11.90

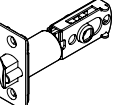
SCAL	Model	Function	Finish							List Price	
			3	5	15	15A	26/26D	690/11P	514		NA
	83520	SCAL Plain Latch UL KNL, CNL	•		•		•	•			\$10.30
	83517	SCAL Deadlatch UL KNL, CNL, HFL, MIL, LSL	•		•		•	•			\$11.90

ADJUSTABLE LATCHES (HALF-ROUND DRIVE)

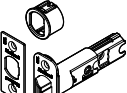
6WAL	Model	Function	Finish							List Price	
			3/L03	5	15	15A	26/26D	690/11P	514		NA
	81825	6WAL Deadlatch	•	•			•				\$11.90
	81826	6WAL Plain Latch	•	•			•				\$10.30

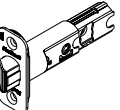
RCAL	Model	Function	Finish							List Price	
			3/L03	5	15	15A	26/26D	690/11P	514		NA
	82246	RCAL RC Plain Latch	•	•	•	•	•	•	•		\$10.30
	82247	RCAL RC Deadlatch	•	•	•	•	•	•	•		\$11.90

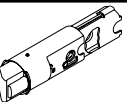
CORE LATCH	Model	Function	Finish							List Price	
			3/L03	5	15	15A	26/26D	690/11P	514		NA
	81846	6-Way Core Deadlatch								•	\$8.70
	81847	6-Way Core Plain Latch								•	\$6.15

<p>Key: 5L - 5" Latch RCL - Round Corner Latch RFL - Round Face Latch (Drive-In Collar attached) SCL - Square Corner Latch RCAL - Round Corner Adjustable Latch</p>	<p>RFAL - Round Face Adjustable Latch SCAL - Square Corner Adjustable Latch WFAL - Wide Face Adjustable Latch NFAL - Narrow Face Adjustable Latch FD - Latch</p>
---	--

NOTES:

For KNL, CNL, HFL, and MIL products use square drive plain and deadlatches.
 All other Kwikset & Kwikset Signature knob and lever products use half-round plain and deadlatches.
 Plainlatches are used with passage and privacy functions. Deadlatches are used with entry functions.
 All fronts are 2-1/4" high.
 For fire rating, UL latches must be used with UL listed locksets and applicable strikes. UL Kwikset and Kwikset Signatures are rated for 3 hours, unless otherwise specified.
 Optional UL 1/3 hour fire rating is available for all functions (FD).

Kwikset

LATCH PARTS

Model	Function	Finish								Price	
		3/L03	5	15	15A	26/26D	690/11P	514	NA		
81827	6-Way Back Plate									•	\$0.20

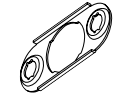

Drive in Collar

Model	Function	Finish								Price	
		3/L03	5	15	15A	26/26D	690/11P	514	NA		
81828	6-Way Deadlatch Collar									•	\$1.70
81829	6-Way Plain Latch Collar									•	\$1.70



Service Kits

Model	Function	Finish								Price	
		3/L03	5	15	15A	26/26D	690/11P	514	NA		
81844	6-Way Deadlatch Service Kit	•	•	•	•	•	•	•	•		\$4.35
81845	6-Way Plain Latch Service Kit	•	•	•	•	•	•	•	•		\$3.40

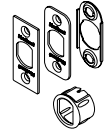

SPECIALTY DEADLATCHES

Model	Function	Finish								List Price	
		3/L03	5	15	15A	26/26D	690/11P	514	NA		
84292	2-3/4" Backset - UL	•	•	•	•	•	•				\$22.65
84297	2-3/8" Backset - UL	•	•	•	•	•	•				\$22.65



WFDL

Model	Function	Finish								List Price	
		3/L03	5	15	15A	26/26D	690/11P	514	NA		
84255	2-3/4" Backset - UL	•	•	•	•	•	•				\$22.65
84295	2-3/8" Backset - UL	•	•	•	•	•	•				\$22.65

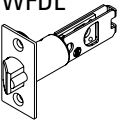

5L SCDL

Model	Function	Finish								List Price	
		3/L03	5	15	15A	26/26D	690/11P	514	NA		
83014	5" Latch (replacement part only)	•	•			•					\$16.45

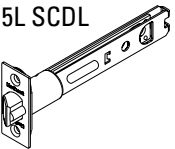

SPECIALTY PLAINLATCHES

Model	Function	Finish								List Price	
		3/L03	5	15	15A	26/26D	690/11P	514	NA		
84290	2-3/4" Backset - UL	•	•	•	•	•	•				\$17.15
84296	2-3/8" Backset - UL	•	•	•	•	•	•				\$17.15

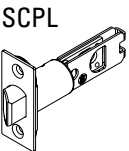

WFPL



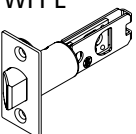

Model	Function	Finish								List Price	
		3/L03	5	15	15A	26/26D	690/11P	514	NA		
84254	2-3/4" Backset - UL	•	•	•	•	•	•				\$17.15
84294	2-3/8" Backset - UL	•	•	•	•	•	•				\$17.15

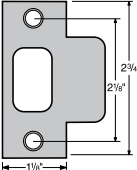
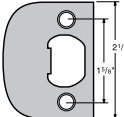
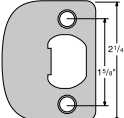
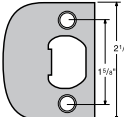
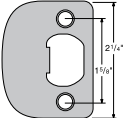
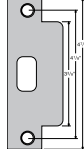

KEY:

- 5L - 5" Latch
- DL - Deadlatch
- RC - Round Corner
- SC - Square Corner
- RCL - Round Corner Latch
- RFL - Round Face Latch (Drive In Collar attached)
- SCL - Square Corner Latch
- RCAL - Round Corner Adjustable Latch
- RFAL - Round Face Adjustable Latch
- SCAL - Square Corner Adjustable Latch
- SCDL - Square Corner Deadlatch
- SCPL - Square Corner Plainlatch
- WFAL - Wide Face Adjustable Latch
- WFDL - Wide Face Deadlatch
- WFPL - Wide Face Plainlatch
- FD - Latch

PLAINLATCH AND DEADLATCH

	Model	Function	Finish							List Price
			3	5	15	15A	26/26D	690/11P	514	
	80318	Full Round, Adjustable Strike 500 per Box	•	•	•	•	•	•		\$11.60
	83028**	T (30 per carton) Standard on 588, 589 and UL Listed Knob and Lever sets. Add \$0.45 elsewhere.	•	•	•	•	•	•	•	\$3.05
	83030**	Full Lip Square Corner Strike, UL UL Option	•	•	•	•	•	•	•	\$4.05
	83031**	Full Lip 1/4" Round Corner Strike, UL UL Option	•	•	•	•	•	•	•	\$4.05
	83437*	Full Lip Square Corner Standard on Non-UL Locksets	•	•	•	•	•	•	•	\$3.05
	83796*	Full Lip 1/4" Round Corner (RCS4)	•	•	•	•	•	•	•	\$3.05
	83846**	ASA-1 (30 per carton) Add \$3.75 to Knob and Lever sets and specify 81967 strike box.	•	•	•	•	•	•	•	\$9.70
	83929	Full Round 1- 3/4"	•	•	•	•	•	•	•	\$3.05
	83536	Round Corner Extended Lip Strike 2-1/4" Qty. 10	•	•	•		•	•		\$3.05
	83537	Square Corner Extended Lip Strike 2-1/4" Qty. 10	•	•	•		•	•		\$3.05
	83534	Round Corner Adjustable Strike 1.75" to 1.94" Qty. 10	•	•	•		•	•		\$3.05

NOTES:

*20-minute fire rating with UL locks and latchbolts.

** 3-hour fire rating with UL Kwikset Signatures and 1.5 hour fire rating with UL Kwikset locks and latchbolts.

Kwikset

DEADBOLT	Model	Function	Finish							Price	
			3	5	15	15A	26/26D	690/11P	514		NA
	83222**	Deadbolt Strike Standard on 780, 785, 980, 985, 993, 994 Deadbolts. Add \$1.45 to 660 Series Deadbolts	•	•	•	•	•	•	•	•	\$3.65
	83223**	Deadbolt Round Corner Strike Standard on 780, 785, 980, 985, 993, 994 Deadbolts. Add \$1.45 to 660 Series Deadbolts	•	•	•	•	•	•	•	•	•
	820049**	Square Deadbolt Strike for 258 Series	•	•	•	•	•	•	•	•	\$3.65
	820050**	Round Deadbolt Strike for 258 Series	•	•	•	•	•	•	•	•	•
	84632**	Deadbolt T-Strike (60 per carton)	•	•	•	•	•	•	•	•	\$3.05
	84638**	Deadbolt, Full Lip	•	•	•	•	•	•	•	•	•
	85063**	Deadbolt 1" x 2-1/4" Round Corner (RCS4) Standard on 660, 665 Deadbolts.	•	•	•	•	•	•	•	•	\$3.05
	85072**	Deadbolt 1" x 2-1/4" Standard on 660, 665 Deadbolts.	•	•	•	•	•	•	•	•	•
	85278**	Deadbolt, 1-1/8" x 2-3/4" Standard on 782, 784 Deadbolts.	•	•	•	•	•	•	•	•	\$3.05
	85279**	Deadbolt, 1-1/8" x 2-3/4" Round Corner Standard on 782, 784 Deadbolts.	•	•	•	•	•	•	•	•	•
	85303**	Deadbolt, Full lip Round Corner	•	•	•	•	•	•	•	•	\$3.05

NOTES:

*20-minute fire rating with UL locks and latchbolts.

** 3-hour fire rating with UL Kwikset Signatures and 1.5 hour fire rating with UL Kwikset locks and latchbolts.

STRIKE BOXES

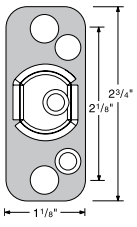
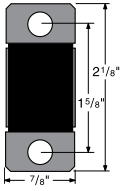
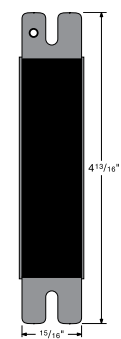
Model	Function	Finish								List Price	
		3	5	15	15A	26/26D	690/11P	514	NA		
	81255	Box for 5278/5279 Strike								•	\$3.30
	81231	Box for 83028 T Strike								•	\$0.90
	83288	Box for Full Lip Strikes Add \$0.45 to locksets using full lip strike.								•	\$1.30
	81640	Box for all Deadbolt Strikes								•	\$0.90
	81967	Box for 83846 ASA-1 Strike								•	\$4.35

Kwikset

KNOBS AND LEVERS

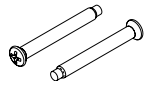

Model	Function	Finish								List Price	
		3	5	15/15A	26/26D	690/11P	501/502	514	NA		
81834	Signature Lever Screw Pack Styles: A, CA, H, L									•	\$0.90
81835	Signature Lever Screw Pack Styles: ADL, AVL, BRL, CHL, LL, PML, TNL / Kwikset Screw Pack Styles: BL, DL, DNL	•		•	•		•		•		\$0.50
83369	Signature Lever Screw Pack Styles: C, CN, PE / Kwikset Screw Pack Styles: CV, P, T	•		•			•				\$0.50



Model	Function	Finish								List Price	
		3	5	15/15A	26/26D	690/11P	501/502	514	NA		
83001	Signatures Entry Lever Screw Pack Styles: HFL, MIL			•	•	•				•	\$4.40



Model	Function	Finish								List Price	
		3	5	15/15A	26/26D	690/11P	501/502	514	NA		
820284	Signatures Passage & Privacy Lever Screw Pack Styles: HFL, MIL			•	•	•					\$3.00



Model	Function	Finish								List Price	
		3	5	15/15A	26/26D	690/11P	501/502	514	NA		
83523	Light Commercial Screw Pack Style: Kingston	•		•	•	•				•	\$3.30
83524	Light Commercial Screw Pack Style: Carson	•		•	•	•				•	\$3.30



Model	Function	Finish								List Price	
		3	5	15/15A	26/26D	690/11P	501/502	514	NA		
83258	New Reversible Lever Hex Wrench (3/32")									•	\$0.60



Model	Function	Finish								List Price	
		3	5	15/15A	26/26D	690/11P	501/502	514	NA		
83398	Lever Set Screw with Hex Wrench for MRL, LSL, SYL, HFL MIL									•	\$5.00

REVERSIBLE LEVERSET SCREWS



Model	Function	Finish								List Price	
		3	5	15/15A	26/26D	690/11P	501/502	514	NA		
83254	Passage/Privacy/Interior Entry SMT			•							\$0.20
83255	Interior Pin & Tumbler Entry			•							\$0.20
83256	Exterior Entry Pin & Tumbler			•							\$0.20
83257	Exterior Entry SMT			•							\$0.20

HANDLESETS

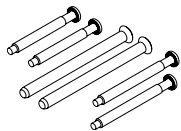

Model	Function	Finish								List Price	
		3	5	15/15A	26/26D	690/11P	501/502	514	NA		
86151	Kwikset Handleset Screw Pack Styles: A, CA, H, L, ADL, AVL, BRL, CHL, PML, CE, AVH, ADH, SE, HE, WN	•	•	•	•	•					\$1.20





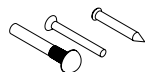

Model	Function	Finish								List Price	
		3	5	15/15A	26/26D	690/11P	501/502	514	NA		
82215	Signatures Handleset Decorative Interior Screw Cap Cover Styles: ADH, AVH, AT, HE, SE, WN, TVH, AVH, MNH	•	•	•	•	•	•	•	•		\$1.95
82213	Screw & Washer			•							\$0.70



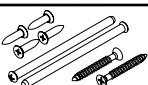
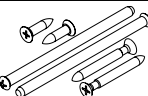
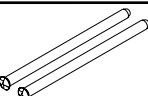
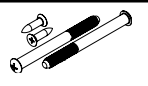
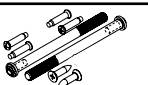
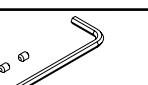

Model	Function	Finish								List Price	
		3	5	15/15A	26/26D	690/11P	501/502	514	NA		
88322	Sex Nut Set & Wood Screw	•	•	•	•	•					\$5.25

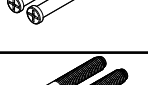
Kwikset

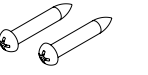
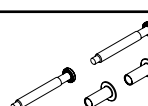
DEADBOLTS		Model	Function	Finish						List Price		
				3	5	15/15A	26/26D	690/11P	501/502	514	NA	
	86171	660 Deadbolt Screw Pack		•	•	•	•	•				\$1.20
	86099	665 Deadbolt Screw Pack		•	•	•	•	•				\$1.95
	86073	One-Way Screws, 665 Deadbolt		•	•	•	•	•				\$1.10
	81247	P&T and SMT 780/782/980/982/993 Deadbolt Screw Pack		•		•	•	•				\$4.05
	81261	P&T and SMT 784, 785, 984, 985, 994 Deadbolt Screw Pack		•	•	•	•	•				\$8.70
	81251	980 Series Deadbolt, Turnpiece Screw & Wrench									•	\$4.05
	820285	P&T and SMT158 Deadbolt Screw Pack				•	•	•				\$4.05
	820286	P&T and SMT 159 Deadbolt Screw Pack				•	•	•				\$8.70
	83015	Standard Screw Pack for 258 Series Deadbolt				•	•			•		\$5.00
	83017	Thin Door Screw Pack for 258 Series Deadbolt				•	•			•		\$5.00

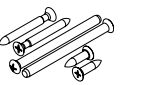
DUMMY/ IN-ACTIVE		Model	Function	Finish						List Price	
				3	5	15/15A	26/26D	690/11P	NA		
	81708	488 & 788 Dummy Mounting Screws		•	•	•	•	•			\$1.00
	81892	488 Dummy Adapter		•	•	•	•	•			\$5.15

LATCH		Model	Function	Finish						List Price	
				3	5	15/15A	26/26D	690/11P	NA		
	81711	Latch & Strike Screws		•	•	•	•	•			\$0.65
	82893	3846 Strike Screw Pack		•	•	•	•	•			\$2.65

Kwikset

ADJUSTABLE INTERCONNECT

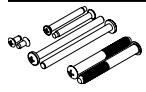

Model	Function	Finish							List Price
		3	5	15/15A	26/26D	690/11P	NA		
83269	Adjustable Interconnect Screw Pack	•	•	•	•	•			\$2.55

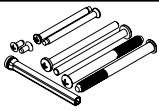

Model	Function	Finish							List Price
		3	5	15/15A	26/26D	690/11P	NA		
83270	Adjustable interconnect Screw Pack (Thick Door Pack)	•	•	•	•	•			\$2.55

STRIKES

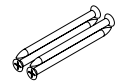

Model	Function	Finish							List Price
		3	5	15/15A	26/26D	690/11P	NA		
86356	3" Strike Screws	•	•	•	•	•			\$4.15

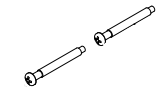

Model	Function	Finish							List Price
		3	5	15/15A	26/26D	690/11P	NA		
88604	Full Round Strike Screws				•				\$1.20

THICK DOOR CONVERSION

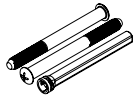

Model	Function	Finish							List Price
		3	5	15/15A	26/26D	690/11P	NA		
81691	P&T and SMT 780/782/980/982/993 Deadbolt Thick Door Pack	•	•	•	•	•			\$5.25

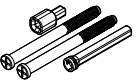

Model	Function	Finish							List Price	
		3	5	15/15A	26/26D	690/11P	501/502	514		NA
83022	258 Series Deadbolt Thick Door Pack			•	•			•		\$6.00



Model	Function	Finish							List Price
		3	5	15/15A	26/26D	690/11P	NA		
820289	P&T and SMT 158 Deadbolt Thick Door Pack			•	•	•			\$6.00



Model	Function	Finish							List Price
		3	5	15/15A	26/26D	690/11P	NA		
820290	P&T and SMT 159 Deadbolt Thick Door Pack			•	•	•			\$6.00



Model	Function	Finish							List Price
		3	5	15/15A	26/26D	690/11P	NA		
81249	P&T and SMT 784/785/984/985/994 Deadbolt Thick Door Kit							•	\$5.25

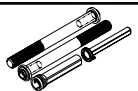





Model	Function	Finish							List Price
		3	5	15/15A	26/26D	690/11P	NA		
84221	P&T 784/785 Thick Door Pack			•	•	•		•	\$4.75

Kwikset

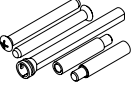
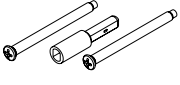
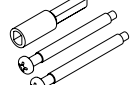
THICK DOOR

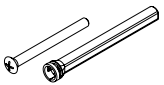
CONVERSION (cont.)

	Model	Function	Finish						List
			3	5	15/15A	26/26D	690/11P	NA	Price
	86129	660 Thick Door Pack	•	•	•	•	•		\$5.25
	86130	665 Thick Door Pack	•	•	•	•	•		\$5.25
	81714	Thick Door Pack, Signature Series Knobs Concealed Screws Styles						•	\$5.25
	81706	Thick Door Pack, Kwikset and Signatures Knob & Lever Styles: A, CA, CN, PE, H, AO, CV, P, T, BL, DL, DNL, LRL, ADL, AUL, AVL, BRL, CHL, L, LL, TNL, PML, KTL, VDL	•	•	•	•	•		\$5.25
	820291	Thick Door Pack, Kwikset and Signatures Series Lever Styles: HFL, MIL, LSL, MRL, SYL			•	•	•		\$6.00
	81838	Thick Door Pack, Handleset Adapter	•	•	•	•	•		\$2.80
	81781	Thick Door Pack, All Active & Dummy Handlesets	•	•	•	•	•		\$5.25

NOTES:

To install handlesets on thick doors, please order the following service parts:

For Kwikset Amherst, Ashfield, Avalon, Hawthorne, Shelburne, Wellington -

- 81402 - Handleset Thick Door Spindle (H18)
- 81781 - Thick Door Pack for all Handlesets (H17)
- 81248 - 980 Deadbolt Thick Door Pack (H16)

For Kwikset Arlington, Austin, Chelsea -











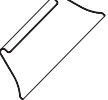

- 81402 - Handleset Thick Door Spindle (H18)
- 81781 - Thick Door Pack for all Handlesets (H17)
- 81248 - 980 Deadbolt Thick Door Pack (H16)
- 81838 - Thick Door Pack Handleset Adapter (H17)

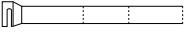
For Belleview and Dakota -





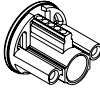







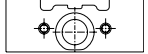

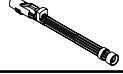
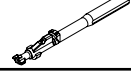
- 81402 - Handleset Thick Door Spindle (H18)
- 81781 - Thick Door Pack for all Handlesets (H17)
- 86129 - 660 Deadbolt Thick Door Pack (H17)

Must specify finish in order.

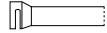
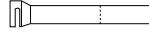
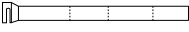
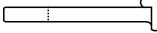
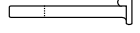
Kwikset

MISC. PARTS	Model	Function	Finish								List Price	
			3	5	15	15A	26	26D	11P	NA		
	82768	660/665 Cylinder Guard									•	\$3.30
	87760	780 Cylinder Guard									•	\$3.40
	82746	660/665 Cylinder Guard Cover	•	•	•	•	•	•	•	•		\$4.15
	87759	780 Cylinder Guard Cover	•	•	•	•	•	•	•	•		\$7.75
	82216	980 Cylinder Guard Cover	•	•	•	•	•	•	•	•		\$7.75
	84991	660 Torque Blade									•	\$1.70
	83273	660/663/667/677/588 Thumb Turn	•	•	•	•	•	•	•	•		\$6.75
	81692	780 Thumb Turn	•	•	•	•	•	•	•	•		\$19.25
	82217	980 Thumb Turn Exposed Screws	•	•	•	•	•	•	•	•		\$19.25
	88381	665, 667, 677 Exterior Plate	•	•				•	•	•		\$15.60
	81295	Kwik-Install Mounting Plate									•	\$2.65
	87789	Reinforcing Plate									•	\$1.30
	82778	699 Function Dummy Cylinder	•	•	•	•	•	•	•	•		\$4.35
	81402	800 Handleset Thick Door Spindle									•	\$1.60
	83024	258 Series Mounting Plate									•	\$3.00

Kwikset

MISC. PARTS	Model	Function	Finish								List Price	
			3	5	15	15A	26	26D	11P	NA		
	81239	Grade 1 Body Dummy Cylinder									•	\$10.05
	81226	Dummy Cylinder Cover	•	•	•	•	•	•	•	•		\$2.90
	84990	663/667/677/664 Tailpiece									•	\$1.70
	84568	663 Block, Bolt Mounting									•	\$1.00
	81404	Non-Handed Levers Dummy Adapter									•	\$10.40
	88841	300 Knobs Interior Round Spindle									•	\$0.60
	87628	740 Interior Round Spindle									•	\$0.90
	85624	3-1/2" Screw Driver Bit									•	\$4.40
	88448	U.L. Shield Knobs									•	\$4.85
	81857	U.L. Shield Deadbolts									•	\$4.85
	81822	DB 2-1/B" Adapter or 780/970/980									•	\$2.65
	84987	.835" Torque Blade									•	\$1.60
	84988	1.37" Torque Blade Double Cylinder Thick Door									•	\$1.60
	84992	2.491" Torque Blade Single Cylinder Thick Door									•	\$1.60
	84994	1.40" Torque Blade, Thick Door									•	\$1.10
	84993	1.097" Torque Blade, Standard Door									•	\$1.60
	83621	Finish Sample Ring									•	\$13.90
	83396	Vedani Lever Support Insert									•	\$3.15
	85333	Half Round & Round Spindle Assembly									•	\$3.65
	85570	5570-01 Screw #8-32 x 1-1/2	•									\$0.10
	820314	Levers and Knobs Frost Insert									•	\$6.00

**ELECTRONIC
SERVICE PARTS**

Model	Function	Finish								List Price
		L03	5	15	15A	26	26D	11P	N/A	
83306	909 Top Interior Cover	•		•				•		\$11.00
83307	909 & 911 Top Battery Holder								•	\$1.65