

Model 4200A-SCS Setup and Maintenance

User's Manual

4200A-908-01 Rev. E April 2024



4200A-908-01E

Model 4200A-SCS
Setup and Maintenance
User's Manual

© 2024, Keithley Instruments

Cleveland, Ohio, U.S.A.

All rights reserved.

Any unauthorized reproduction, photocopy, or use of the information herein, in whole or in part, without the prior written approval of Keithley Instruments is strictly prohibited.

All Keithley Instruments product names are trademarks or registered trademarks of Keithley Instruments, LLC. Other brand names are trademarks or registered trademarks of their respective holders.

Actuate®

Copyright © 1993-2003 Actuate Corporation.

All Rights Reserved.

Microsoft, Visual C++, Excel, and Windows are either registered trademarks or trademarks of Microsoft Corporation in the United States and/or other countries.

Document number: 4200A-908-01 Rev. E April 2024

The following safety precautions should be observed before using this product and any associated instrumentation. Although some instruments and accessories would normally be used with nonhazardous voltages, there are situations where hazardous conditions may be present.

This product is intended for use by personnel who recognize shock hazards and are familiar with the safety precautions required to avoid possible injury. Read and follow all installation, operation, and maintenance information carefully before using the product. Refer to the user documentation for complete product specifications.

If the product is used in a manner not specified, the protection provided by the product warranty may be impaired.

The types of product users are:

Responsible body is the individual or group responsible for the use and maintenance of equipment, for ensuring that the equipment is operated within its specifications and operating limits, and for ensuring that operators are adequately trained.

Operators use the product for its intended function. They must be trained in electrical safety procedures and proper use of the instrument. They must be protected from electric shock and contact with hazardous live circuits.

Maintenance personnel perform routine procedures on the product to keep it operating properly, for example, setting the line voltage or replacing consumable materials. Maintenance procedures are described in the user documentation. The procedures explicitly state if the operator may perform them. Otherwise, they should be performed only by service personnel.

Service personnel are trained to work on live circuits, perform safe installations, and repair products. Only properly trained service personnel may perform installation and service procedures.

Keithley products are designed for use with electrical signals that are measurement, control, and data I/O connections, with low transient overvoltages, and must not be directly connected to mains voltage or to voltage sources with high transient overvoltages. Measurement Category II (as referenced in IEC 60664) connections require protection for high transient overvoltages often associated with local AC mains connections. Certain Keithley measuring instruments may be connected to mains. These instruments will be marked as category II or higher.

Unless explicitly allowed in the specifications, operating manual, and instrument labels, do not connect any instrument to mains.

Exercise extreme caution when a shock hazard is present. Lethal voltage may be present on cable connector jacks or test fixtures. The American National Standards Institute (ANSI) states that a shock hazard exists when voltage levels greater than 30 V RMS, 42.4 V peak, or 60 VDC are present. A good safety practice is to expect that hazardous voltage is present in any unknown circuit before measuring.

Operators of this product must be protected from electric shock at all times. The responsible body must ensure that operators are prevented access and/or insulated from every connection point. In some cases, connections must be exposed to potential human contact. Product operators in these circumstances must be trained to protect themselves from the risk of electric shock. If the circuit is capable of operating at or above 1000 V, no conductive part of the circuit may be exposed.

Do not connect switching cards directly to unlimited power circuits. They are intended to be used with impedance-limited sources. NEVER connect switching cards directly to AC mains. When connecting sources to switching cards, install protective devices to limit fault current and voltage to the card.

Before operating an instrument, ensure that the line cord is connected to a properly-grounded power receptacle. Inspect the connecting cables, test leads, and jumpers for possible wear, cracks, or breaks before each use.

When installing equipment where access to the main power cord is restricted, such as rack mounting, a separate main input power disconnect device must be provided in close proximity to the equipment and within easy reach of the operator.

For maximum safety, do not touch the product, test cables, or any other instruments while power is applied to the circuit under test. ALWAYS remove power from the entire test system and discharge any capacitors before connecting or disconnecting cables or jumpers, installing or removing switching cards, or making internal changes, such as installing or removing jumpers.

Do not touch any object that could provide a current path to the common side of the circuit under test or power line (earth) ground. Always make measurements with dry hands while standing on a dry, insulated surface capable of withstanding the voltage being measured.

For safety, instruments and accessories must be used in accordance with the operating instructions. If the instruments or accessories are used in a manner not specified in the operating instructions, the protection provided by the equipment may be impaired.

Do not exceed the maximum signal levels of the instruments and accessories. Maximum signal levels are defined in the specifications and operating information and shown on the instrument panels, test fixture panels, and switching cards.

When fuses are used in a product, replace with the same type and rating for continued protection against fire hazard.

Chassis connections must only be used as shield connections for measuring circuits, NOT as protective earth (safety ground) connections.

If you are using a test fixture, keep the lid closed while power is applied to the device under test. Safe operation requires the use of a lid interlock.

If a  screw is present, connect it to protective earth (safety ground) using the wire recommended in the user documentation.

The  symbol on an instrument means caution, risk of hazard. The user must refer to the operating instructions located in the user documentation in all cases where the symbol is marked on the instrument.

The  symbol on an instrument means warning, risk of electric shock. Use standard safety precautions to avoid personal contact with these voltages.

The  symbol on an instrument shows that the surface may be hot. Avoid personal contact to prevent burns.

The  symbol indicates a connection terminal to the equipment frame.

If this  symbol is on a product, it indicates that mercury is present in the display lamp. Please note that the lamp must be properly disposed of according to federal, state, and local laws.

The **WARNING** heading in the user documentation explains hazards that might result in personal injury or death. Always read the associated information very carefully before performing the indicated procedure.

The **CAUTION** heading in the user documentation explains hazards that could damage the instrument. Such damage may invalidate the warranty.

The **CAUTION** heading with the  symbol in the user documentation explains hazards that could result in moderate or minor injury or damage the instrument. Always read the associated information very carefully before performing the indicated procedure. Damage to the instrument may invalidate the warranty.

Instrumentation and accessories shall not be connected to humans.

Before performing any maintenance, disconnect the line cord and all test cables.

To maintain protection from electric shock and fire, replacement components in mains circuits — including the power transformer, test leads, and input jacks — must be purchased from Keithley. Standard fuses with applicable national safety approvals may be used if the rating and type are the same. The detachable mains power cord provided with the instrument may only be replaced with a similarly rated power cord. Other components that are not safety-related may be purchased from other suppliers as long as they are equivalent to the original component (note that selected parts should be purchased only through Keithley to maintain accuracy and functionality of the product). If you are unsure about the applicability of a replacement component, call a Keithley office for information.

Unless otherwise noted in product-specific literature, Keithley instruments are designed to operate indoors only, in the following environment: Altitude at or below 2,000 m (6,562 ft); temperature 0 °C to 50 °C (32 °F to 122 °F); and pollution degree 1 or 2.

To clean an instrument, use a cloth dampened with deionized water or mild, water-based cleaner. Clean the exterior of the instrument only. Do not apply cleaner directly to the instrument or allow liquids to enter or spill on the instrument. Products that consist of a circuit board with no case or chassis (e.g., a data acquisition board for installation into a computer) should never require cleaning if handled according to instructions. If the board becomes contaminated and operation is affected, the board should be returned to the factory for proper cleaning/servicing.

Safety precaution revision as of June 2018.

Table of contents

Introduction.....	1-1
Introduction	1-1
4200A-SCS system overview	1-2
Source-measure unit (SMU).....	1-3
Preamplifier	1-3
Ground unit (GNDU)	1-4
Capacitance-Voltage Unit (CVU).....	1-4
Pulse source-measure hardware	1-4
Software features	1-5
Front-panel overview.....	1-6
Touchscreen basics	1-7
Connect a keyboard and mouse	1-7
Rear-panel overview	1-8
Connect an external monitor	1-9
Extended warranty	1-9
Contact information	1-9
Embedded computer policy	1-9
General ratings.....	1-10
Installation.....	2-1
Introduction	2-1
Network security.....	2-2
Locating the system	2-2
Basic system connections	2-3
Connecting to protective earth	2-3
Connecting GPIB instruments.....	2-4
Connecting a LAN cable	2-5
Connecting the interlock.....	2-6
Configuring safety interlock operation	2-7
Prober connections	2-8
GPIB connections	2-8
Configuring IEEE-488 controller operation	2-8
Configuring IEEE-488 subordinate operation	2-9
Preamplifier mounting	2-9
Mounting a preamplifier in a remote location.....	2-10
Mounting a preamplifier to the rear panel.....	2-11
Connections to the device under test.....	2-11
Powering the 4200A-SCS	2-12
Powering off the 4200A-SCS	2-13
Configuring the system	2-14
Learning Center	2-14
Installing Clarius+ software on a personal computer	2-15
Personal computer requirements	2-15

Installing Clarius+ software	2-16
Add or remove virtual instruments in KCon	2-16
Uninstalling the Clarius+ software	2-16
Keithley Configuration Utility (KCon)	3-1
Keithley Configuration Utility (KCon)	3-1
KCon main window	3-2
System Configuration	3-3
Add an external instrument	3-4
Supported external equipment	3-6
Add a driver for unsupported equipment	3-9
Use KCon to add equipment to the 4200A-SCS	3-10
Remove an external instrument	3-12
Validate	3-13
Update the configuration	3-13
Update the preamplifier configuration	3-13
Update the RPM configuration	3-14
Update the 4200A-CVIV configuration	3-14
Adding AFG31000s to the 4200A-SCS configuration	3-15
Save	3-15
Summary	3-16
System Configuration properties	3-16
KI 4200A SCS Properties	3-16
Instrument properties and connections	3-18
KXCI Settings	3-21
Set up KXCI for GPIB control	3-21
Set up KXCI for ethernet control	3-23
Setting up KXCI as a 4145B emulator	3-24
Command Set	3-26
Tools	3-26
Formulator Constants	3-27
Generate Technical Support Files	3-28
About KCon	3-28
Maintenance	4-1
Introduction	4-1
Line fuses	4-1
Front-panel display	4-2
Cleaning the front-panel display	4-2
Screen brightness	4-2
Fan operation	4-3
Air intake ventilation screens	4-4
Solid-state hard drive maintenance	4-4
Run Self Test	4-5
Connections for RPM Self Test	4-6

Returning the 4200A-SCS for repair or calibration 4-6

Check calibration status 4-8

Reset the hardware 4-8

Lithium battery 4-9

Autocalibrate the SMUs 4-9

System administration 5-1

 System Administration introduction 5-1

 Embedded computer policy 5-1

 Upgrading the Clarius software 5-2

 Default user accounts 5-3

 Windows 10 compatibility 5-3

 Create new user accounts 5-3

 System directories and files 5-4

 Change the touch mode of Adobe Acrobat Reader 5-5

 Disable the touchscreen 5-5

 System-level backup and restore software 5-7

 Restore the drive image to factory condition 5-8

 Choose the files to be backed up 5-8

 Protect user files and system software 5-9

 Protect software integrity 5-10

 Read and write permission access to USB ports 5-10

 Add Clarius+ applications to the Windows startup menu 5-11

Next steps 6-1

 Additional information 6-1

Introduction

In this section:

Introduction	1-1
4200A-SCS system overview.....	1-2
Front-panel overview.....	1-6
Rear-panel overview	1-8
Extended warranty	1-9
Contact information	1-9
Embedded computer policy.....	1-9
General ratings.....	1-10

Introduction

The Keithley Instruments Model 4200A-SCS Setup and Maintenance is a customizable and fully-integrated parameter analyzer that provides synchronized insight into current-voltage (I-V), capacitance-voltage (C-V), and ultra-fast pulsed I-V characterization. The highest performance parameter analyzer, the 4200A-SCS accelerates semiconductor, materials, and process development.

The 4200A-SCS Clarius™ GUI-based software provides clear, uncompromised measurement and analysis capability. Furnished with embedded measurement expertise and hundreds of ready-to-use application tests, Clarius enables you to dig deeper into your research with speed and confidence.

The 4200A-SCS offers the most advanced capabilities available in a fully integrated characterization system, including a complete, embedded computer with Microsoft® Windows® operating system and mass storage. Its touchscreen interface accelerates and simplifies the process of taking data, so users can begin analyzing their results sooner.

The following topics introduce you to the 4200A-SCS, as follows:

- 4200A-SCS system overview:
 - An overall block diagram and summary of the system.
 - Basic configurations and capabilities of the source-measure units (SMUs), preamplifiers, pulse generator and measure units, and capacitance-voltage units (CVUs) that source and measure the electrical signals that are connected to your devices under test (DUTs).
- Embedded PC policy: Explains Keithley Instruments' policy concerning the use of third-party software and its no-tamper policy for the Microsoft® Windows® operating system.
- An overview of the features of the front panel and rear panel of the 4200A-SCS.

4200A-SCS system overview

The 4200A-SCS is an automated system that provides I-V, pulsed I-V, and C-V characterization of semiconductor devices and test structures. Its advanced digital sweep parameter analyzer combines speed and accuracy for deep sub-micron characterization.

Tests are easily and quickly configured and executed from Clarius. Clarius is an application designed and developed specifically for characterizing semiconductor devices and materials. Source and measurement functions for a test are provided by up to eight source-measure units (SMUs). Test capabilities are extended by support of a variety of external components.

Pulse source and measure tests can be provided by the 4225-PMU Ultra-fast I-V pulse-measure card. Tests requiring pulse source with no corresponding pulse measurement can use the 4220-PGU pulse-only card. A typical configuration with pulse source-measure capability is a 4200A-SCS system that consists of four SMUs, two 4225-PMUs and four 4225-RPMs. This system would have four SMUs and four pulsed I-V channels (pulse source and measure), with the RPMs allowing for switching between pulse and SMU test resources. The primary 4200A-SCS components and typical supported external components are illustrated in the following figure.

Figure 1: 4200A-SCS summary

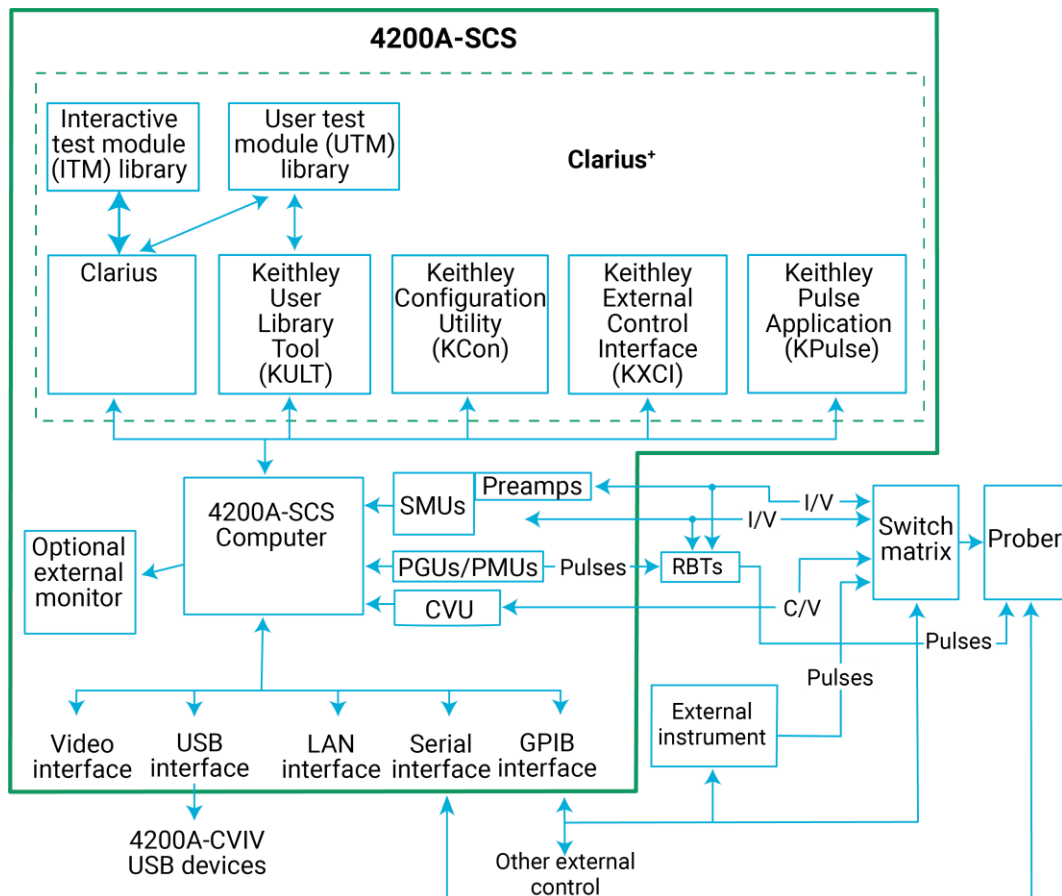

Source-measure unit (SMU)

The fundamental instrument module used by the 4200A-SCS is the source-measure unit (SMU). The basic function of a SMU is to perform one of the following source-measure operations:

- Source voltage and measure current or voltage
- Source current and measure voltage or current

The source of the SMU can be configured to sweep or step voltages or currents, or to output a constant bias voltage or current.

There are medium-power and high-power source-measure units available. The 2 W medium-power SMUs are models 4200-SMU and 4201-SMU. The 20 W high-power SMUs are models 4210-SMU and 4211-SMU. The following table lists the maximum limits of the SMUs.

Source-measure units

Model	Maximum voltage	Maximum current	Maximum power
4200-SMU 4201-SMU	210 V	105 mA	2.2 W
4210-SMU 4211-SMU	210 V	1.05 A	22 W

Preampifier

A 4200-PA preampifier adds five low-current source-measure ranges to a SMU. Without a preampifier, the 100 nA range (100 fA resolution) is the lowest current source-measure range for a SMU. With a preampifier installed, the 10 nA, 1 nA, 100 pA, 10 pA, and 1 pA source-measure ranges are added.

If preampifiers are ordered, the 4200A-SCS is shipped from the factory with the preampifiers installed on the rear panel of the mainframe. The preampifiers can be removed from the rear panel and mounted remotely to reduce the effects of long cables on measurement quality (long cables can add noise to low current measurements and can cause oscillation with some devices).

An installed preampifier is matched to the SMU to which it is connected. Therefore, if you disconnect the preampifiers to mount them at a remote location, you must ensure that you reconnect each one to its matching SMU.

Ground unit (GNDU)

The ground unit on the rear panel of the 4200A-SCS provides a convenient method of making ground connections. This eliminates the need to use a SMU for this purpose.

Capacitance-Voltage Unit (CVU)

The 4210-CVU and 4215-CVU Multi-Frequency Capacitance-Voltage Units are impedance measurement modules that can be installed in the 4200A-SCS.

Capacitance-voltage (C-V) measurements are often used to characterize the gate oxide thickness, oxide defect density, and doping profile of MOSFETs. In these measurements, as the gate voltage varies, the capacitance of the gate to the drain and source changes. Capacitance measurements are typically made using an AC technique. The CVUs measure AC impedance by applying a DC bias voltage and sourcing an AC voltage across the device under test (DUT) and then measuring the resultant AC current and phase angle.

The 4210-CVU operates from 1 kHz to 10 MHz. The AC test signal (10 mV_{RMS} to 100 mV_{RMS}) can be DC voltage biased from –30 V to +30 V.

The 4215-CVU operates from 1 kHz to 10 MHz at 1 kHz resolution. The AC test signal (10 mV to 1 V_{RMS}) can be DC voltage biased from –30 V to +30 V.

Pulse source-measure hardware

The 4220-PGU High Voltage Pulse Generator Unit and 4225-PMU Ultra-Fast Pulse Measure Unit are high-speed pulse-generator cards for the 4200A-SCS. The 4220-PGU provides pulse output only. The 4225-PMU provides both pulse output and pulse measurement. The PGU and PMU have similar pulse output characteristics.

The 4225-PMU can be paired with one or two 4225-RPM Remote Preamplifier/Switch Modules. The RPM is a remote amplifier and automatic switch. When the RPM is used as a preamplifier for the PMU, it provides additional low-current measurement ranges. When the RPM is used as a switch, it switches between the PMU, SMUs, and CVUs.

Software features

CAUTION

When you start one of the Clarius+ applications for the first time, you must agree to the license agreement before continuing. If you do not respond with "Yes", your system will not function until you reinstall the software.

You can use the following applications to operate and maintain the 4200A-SCS.

- **Clarius:** This is the main 4200A-SCS parameter analysis application. You use Clarius to organize tests into individual projects. You then use Clarius to manage, execute, and review test results from the projects.
- **Keithley Configuration Utility (KCon):** KCon allows you to configure external GPIB instruments, switch matrices, and analytical probers connected to the 4200A-SCS. KCon also provides basic diagnostic and troubleshooting functions.
- **Keithley User Library Tool (KULT):** KULT allows you to create algorithms (user modules) in the C programming language and to integrate these modules into Clarius. The modules can control internal 4200A-SCS instrumentation and external instrumentation. You also use KULT to create and manage libraries of user modules.
- **Keithley External Control Interface (KXCI):** KXCI allows you to use an external computer to remotely control 4200A-SCS SMUs and CVUs directly. KXCI also allows indirect control of the Ultra-Fast Pulse Measure Unit, using user test modules (UTMs).
- **Keithley Pulse Application (KPulse):** A nonprogramming alternative to configure and control installed 4225-PMU or 4220-PGU pulse units. You can use it for quick tests that require minimal interaction with other 4200A-SCS test resources.

Front-panel overview

Many controls and interfaces are on the front panel of the 4200A-SCS Parameter Analyzer. The following figure shows the front panel of the 4200A-SCS. The components are summarized following the figure.

Figure 2: 4200A-SCS front panel

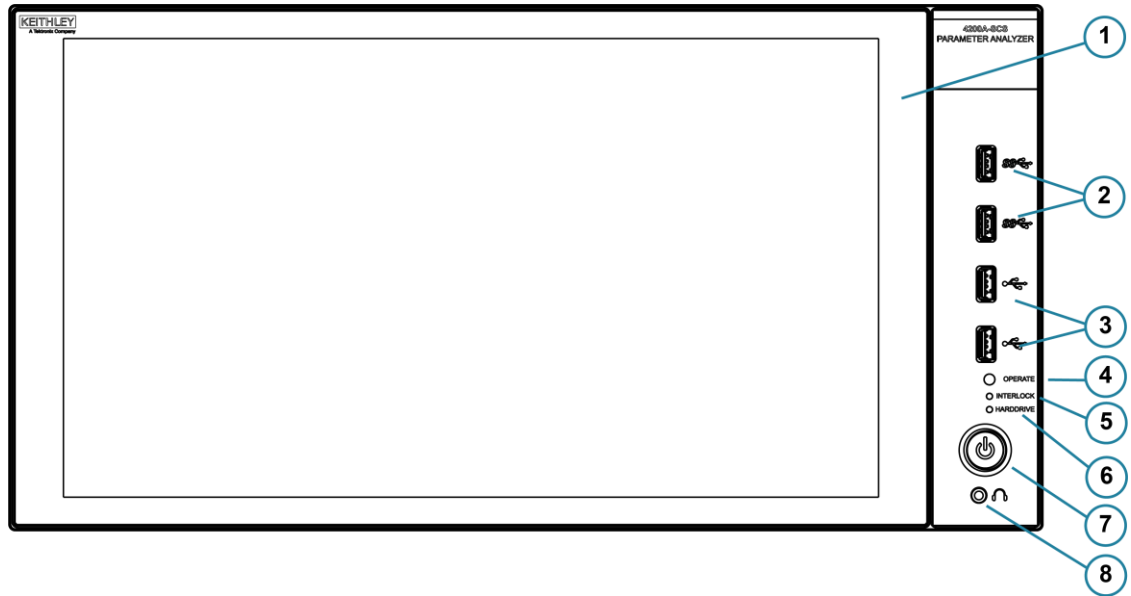

1	Display	A 1920 x 1080 full HD resolution touchscreen display.
2	Two v3.0 USB ports	Allows you to connect to peripherals such as flash drives, pointing devices, scanners, and external hard drives that are compatible with the USB v3.2 Gen 1x1.
3	Two v2.0 USB ports	Allows you to connect to peripherals that are compatible with the USB v2.0.
4	Operate indicator	Illuminates when any internal cards are energized.
5	Interlock indicator	Illuminates when the 12 V DC interlock circuit is closed.
6	Hard drive indicator	Illuminates when the hard drive is being accessed.
7	Power switch	Turns the main system power on or off. Illuminated when the power is on.
8	Headphone connector	Allows you to connect a 1/8" stereo output connection.

NOTE

4200A-SCS-ND has no display and requires an external monitor.

Touchscreen basics

You can operate the 4200A-SCS using the touchscreen. You can use your fingers, clean room gloves, or any stylus manufactured for capacitive touchscreens.

To select and move on the screen:

- To scroll, swipe up or down on the screen.
- To select an item, touch it on the screen.
- To double-click an item, touch it twice.
- To right-click an item, touch and hold, then release to see the options.

To enter information, you can use the on-screen keyboard. Swipe from the left side of the display to open the keyboard.

The touchscreen uses standard Microsoft® Windows® touch actions. For additional information on the actions, refer to the Microsoft help information, available from the on-screen keyboard window menu option **Tool > Help Topics**.

You can also adjust the touch settings using the Pen and Touch options in the Windows Control Panel.

Connect a keyboard and mouse

Connect the keyboard to the 4200A-SCS with a USB cable. You can plug it into any of the USB ports or the PS/2 port. To ensure proper operation, be sure that the keyboard is connected before power-up.

Figure 3: Keyboard and mouse connections

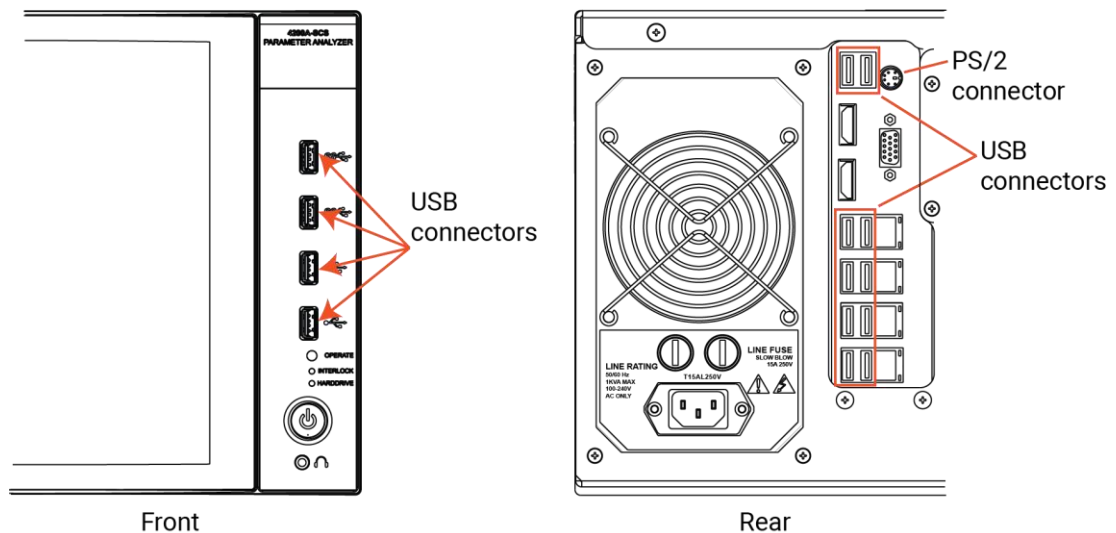

To use a mouse, connect a USB mouse to any of the 4200A-SCS USB ports or a PS/2 mouse to the PS/2 port.

Rear-panel overview

The following figure shows the rear panel of the 4200A-SCS. The connectors and components are summarized following the figure.

Figure 4: 4200A-SCS rear panel

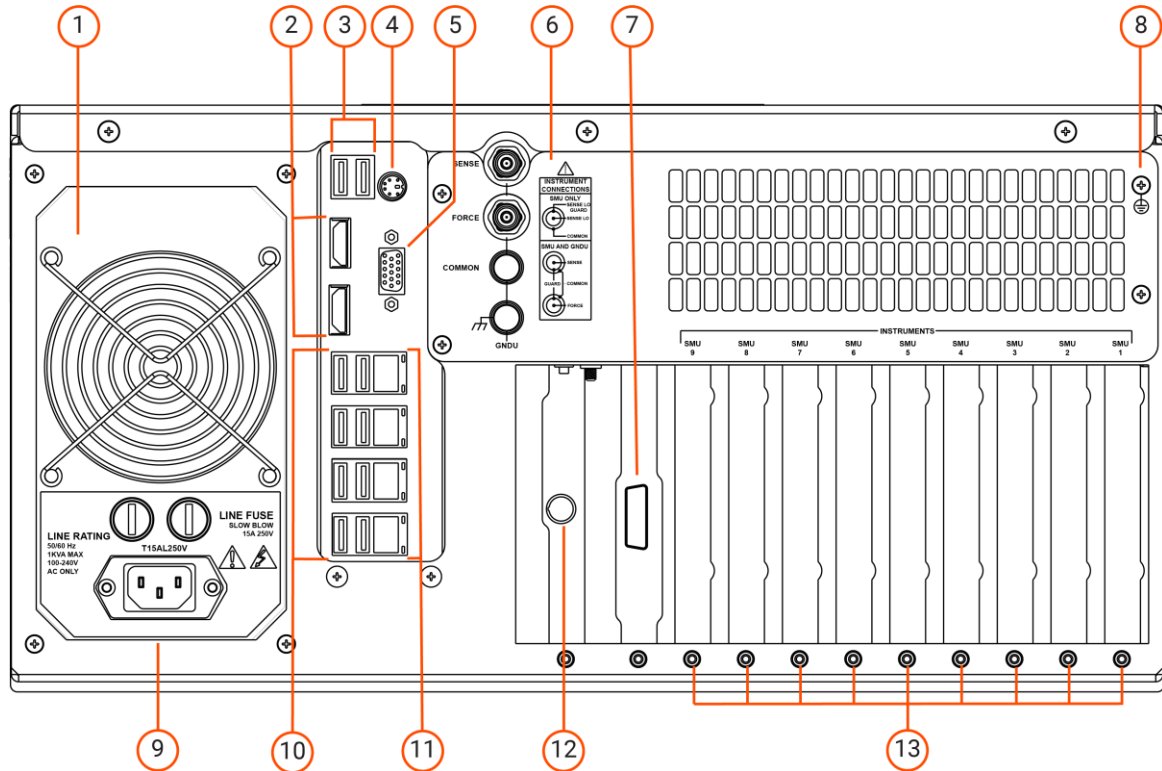

1	Fan	Cools the system.
2	HDMI ports	Connects to a standard High Definition Multimedia Interface (HDMI®) device.
3	Two USB connectors	Connects to USB-compatible peripherals.
4	Keyboard or mouse connector	Connects to PS/2-compatible peripheral.
5	Serial port	Connects to an RS-232 peripheral.
6	Ground unit	Provides system-level SENSE, FORCE, and COMMON connections.
7	IEEE-488 connector	Connects to peripherals with a GPIB interface.
8	Grounding screw	Connects to protective earth (safety ground).
9	Power receptacle and line fuses	Connects to line power through supplied line cord. Two line fuses protect the instrument.
10	Eight USB connectors	Connects to SuperSpeed USB 3.0-compatible peripherals.
11	Four LAN connectors	Connects to LAN to interface the unit to local ethernet networks.
12	12 VDC interlock connector	Connects the instrument to a test fixture or prober interlock circuit.
13	Nine instrument slots	Support the factory-installed SMU, CVU, PMU, and PGU cards.

Connect an external monitor

You can connect an external monitor to the 4200A-SCS. For best results, use a 1920×1080p HD monitor to maintain the correct resolution when using the Clarius application.

The HDMI port on your 4200A-SCS supports up to v1.3. The DisplayPort (DP) supports up to v1.2.

Extended warranty

Additional years of warranty coverage are available on many products. These valuable contracts protect you from unbudgeted service expenses and provide additional years of protection at a fraction of the price of a repair. Extended warranties are available on new and existing products. Contact your local Keithley Instruments office, sales partner, or distributor for details.

Contact information

If you have any questions after you review the information in this documentation, please contact your local Keithley Instruments office, sales partner, or distributor. You can also call the Tektronix corporate headquarters (toll-free inside the U.S. and Canada only) at 1-800-833-9200. For worldwide contact numbers, visit tek.com/contact-tek.

Embedded computer policy

CAUTION

If you install software that is not part of the standard application software for the 4200A-SCS, the nonstandard software may be removed if the instrument is sent in for service. Back up the applications and any data related to them before sending the instrument in for service.

CAUTION

Do not reinstall or upgrade the Microsoft® Windows® operating system (OS) on any 4200A-SCS unless the installation is performed as part of authorized service by Keithley Instruments. Violation of this precaution will void the 4200A-SCS warranty and may render the 4200A-SCS unusable. Any attempt to reinstall or upgrade the operating system (other than a Windows service pack update) will require a return-to-factory repair and will be treated as an out-of-warranty service, including time and material charges.

Although you must not attempt to reinstall or upgrade the operating system, you can restore the hard drive image (complete with the operating system) using the Acronis True Image OEM software tool, described in [System-level backup and restore software](#) (on page 5-7).

You can install Windows quality updates. The version of Windows installed on 4200A-SCS systems only supports installation of quality updates. Feature updates are not supported.

As shipped, the 4200A-SCS automatically runs Windows quality updates when the 4200A-SCS is restarted. They are prevented from occurring during operation.

General ratings

The general ratings and connections of the 4200A-SCS instrument are listed in the following table.

Category	Specification
Supply voltage range	100 V _{RMS} to 240 V _{RMS} , 50 Hz or 60 Hz
Current rating	1000 VA
Input and output connections	See Front-panel overview (on page 1-6) and Rear-panel overview (on page 1-8).
Environmental conditions	<p>For indoor use only</p> <p>Temperature range: Operating: 10 °C to 40 °C (50 °F to 104 °F) Storage: –15 °C to 60 °C (5 °F to 140 °F)</p> <p>Humidity range: Operating: 5% to 80% relative humidity, noncondensing Storage: 5% to 90% relative humidity, noncondensing</p> <p>Altitude Operating: 0 to 2,000 m (0 to 6,562 ft) Storage: 0 to 4,600 m (0 to 15,092 ft)</p> <p>Pollution degree: 1 or 2</p>

Installation

In this section:

Introduction	2-1
Network security.....	2-2
Locating the system	2-2
Basic system connections.....	2-3
GPIB connections	2-8
Preamplifier mounting	2-9
Connections to the device under test.....	2-11
Powering the 4200A-SCS	2-12
Powering off the 4200A-SCS	2-13
Configuring the system	2-14
Learning Center	2-14
Installing Clarius+ software on a personal computer.....	2-15

Introduction

This section contains information about handling and installing the 4200A-SCS:

- **Locating the system:** Describes how to select the best operating environment location for your 4200A-SCS.
- **Basic system connections:** Explains how to connect the grounding cable, LAN cable, GPIB-compatible instruments, and the safety interlock to the 4200A-SCS.
- **GPIB connections:** Describes recommended cables and configuring controller and subordinate operation.
- **Preamplifier mounting:** Describes how to mount preamplifiers remotely or on the rear panel.
- **Powering the 4200A-SCS:** Describes line power requirements for the 4200A-SCS and shows how to connect the power-line cord.

CAUTION

When you start one of the Clarius+ applications for the first time, you must agree to the license agreement before continuing. If you do not respond with "Yes", your system will not function until you reinstall the software.

Network security

If you choose to connect this product or service to a network, it is critical that you provide and continuously ensure a secure connection to that network. You must establish and maintain appropriate measures (for example, firewalls, authentication measures, encryption, antivirus applications, user accounts, passwords, and so on) to protect the product or service and any associated data against security breaches, including unauthorized access, destruction, use, modification, or disclosure.

You are responsible for using this product or service in a secure environment, ideally isolated from the production network. You must ensure that you maintain a secure environment where this product or service is used.

Notwithstanding the foregoing, you should never use any products in a network with other products or services that are incompatible, insecure, or noncompliant with applicable laws or regulations.

CAUTION

For optimum security, change each account password from the default setting to a unique and secure password. Check with your information technology (IT) department for best practices on setting passwords to ensure compliance with the security measures of your organization.

Locating the system

Locate the 4200A-SCS so that it operates within the following ambient temperature and humidity limits:

- Temperature: +10 °C to +40 °C
- Relative humidity: 5% to 80%, noncondensing

NOTE

SMU and preamplifier accuracy specifications are based on operation at 23 °C ±5 °C and between 5% and 60% relative humidity. See the 4200A-SCS datasheet at tek.com/keithley for derating factors outside these ranges.

CAUTION

To avoid overheating, operate the instrument only in an area with proper ventilation. Allow at least eight inches of clearance at the back of the mainframe to assure sufficient airflow and comply with the following guidelines.

Guidelines to prevent overheating:

- Operate the instrument in a clean, dust-free environment.
- Keep the fan vents and cooling vents from becoming blocked (sides and rear of the instrument).
- Do not position any devices adjacent to the instrument that force air (heated or unheated) into cooling vents. This additional airflow could compromise accuracy performance.
- When rack mounting the instrument, ensure adequate airflow around the sides, bottom, and back.
- Do not rack mount high-power dissipation equipment adjacent to the 4200A-SCS.
- To ensure proper cooling in rack environments with only convection cooling, place the hottest equipment (for example, power supply) at the top of the rack. Place precision equipment, such as the 4200A-SCS, as low as possible in the rack, where temperatures are the coolest. Adding spacer panels below the instrument helps to ensure adequate airflow.

Basic system connections

This section provides basic system connections to get your 4200A-SCS set up and running.

Connecting to protective earth

WARNING

The 4200A-SCS must be connected to protective earth (safety ground) using the supplied green-yellow ground cable. Failure to attach the ground wires to a known protective earth may result in electric shock.

Connect one lugged end of the supplied grounding cable to the protective earth (safety ground) screw on the rear of your 4200A-SCS. See the following figure.

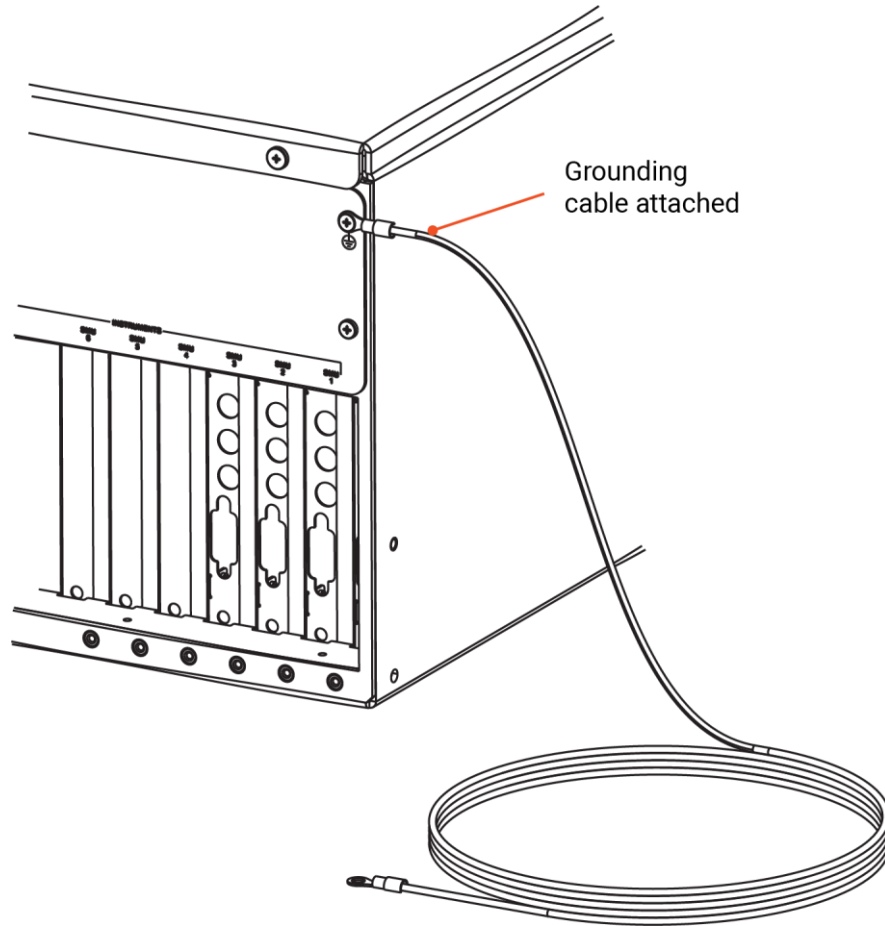
Figure 5: Grounding cable connected to the rear of the 4200A-SCS

Connecting GPIB instruments

You can use the 4200A-SCS to control one or more external instruments using the IEEE-488 general purpose instrument bus (GPIB). An example of typical instruments used in a test system with the 4200A-SCS are a switching system and an external C-V meter.

To avoid electrical interference, use only shielded IEEE-488 connecting cables. The following figure shows how to connect GPIB instruments to the 4200A-SCS.

Figure 6: 4200A-SCS GPIB instrument connections

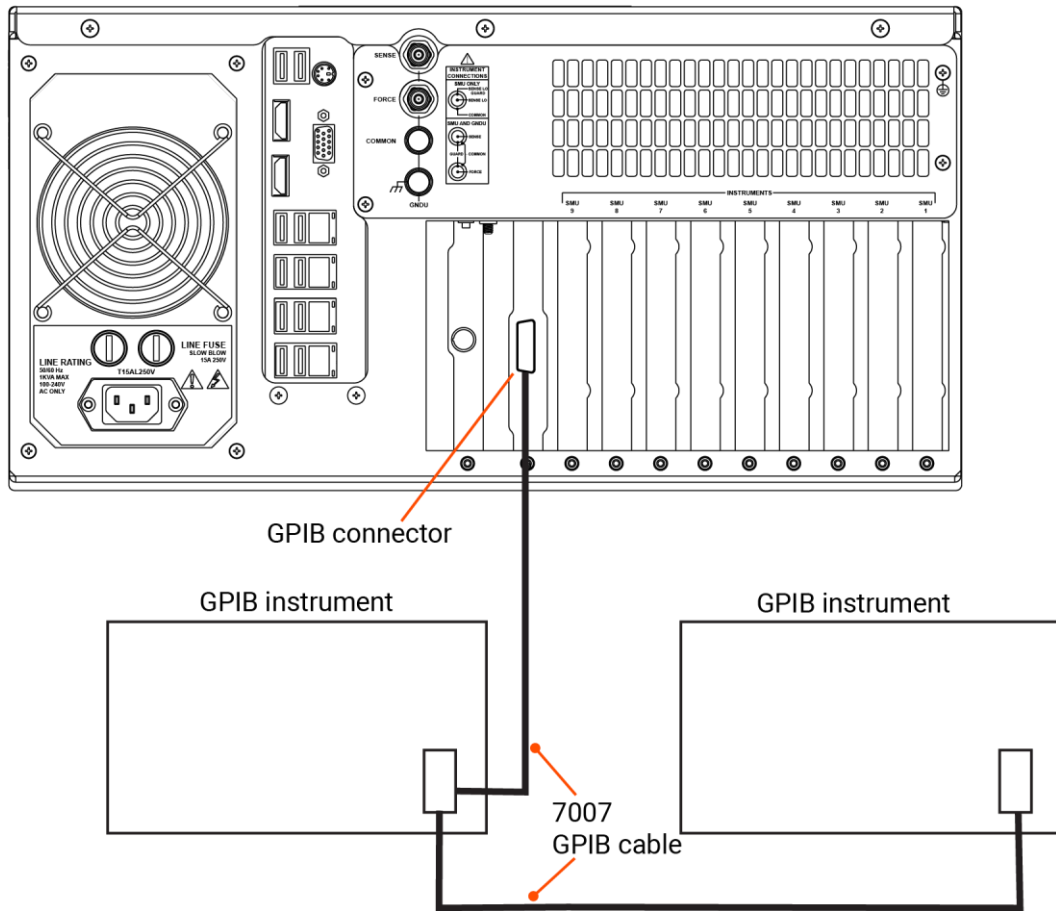

Connecting a LAN cable

The LAN connectors on the 4200A-SCS are standard RJ-45 connectors intended for use with unshielded twisted pair (UTP) cable. For best results, use only CAT 5 UTP cables equipped with RJ-45 connectors to connect LANs. The LAN connector locations are shown in the following figure.

Figure 7: LAN connections

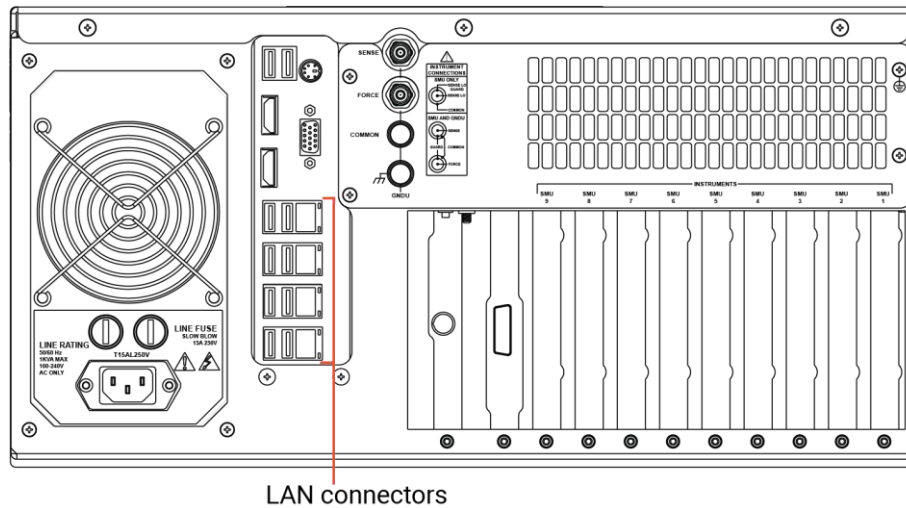

If IP addresses are statically assigned, you need to assign a different IP address to each LAN port.

Connecting the interlock

The following figure shows the location of the interlock connector on the rear panel of the 4200A-SCS.

To connect the interlock:

1. Connect one end of the supplied 236-326A interlock cable to the interlock connector on the rear panel of the 4200A-SCS, shown in the following figure.

Figure 8: Interlock connector on the rear panel of the 4200A-SCS

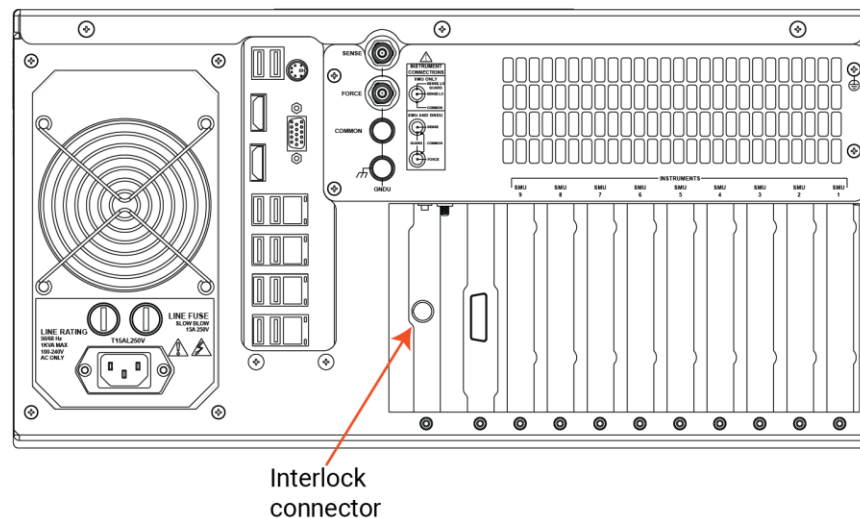

2. Connect the other end of the interlock cable to a compatible test fixture.

Configuring safety interlock operation

The following figure shows typical interlock connector wiring. A normally open switch should be used so that an open interlock condition occurs when the switch is open.

Many test fixtures have a safety interlock connected to the instrument lid. When the lid is closed, the interlock circuit is closed (asserted), and SMU ± 200 V ranges are enabled. Conversely, the interlock circuit is open (deasserted) when the lid is open, and SMU ± 200 V ranges are disabled.

Figure 9: Interlock connector wiring

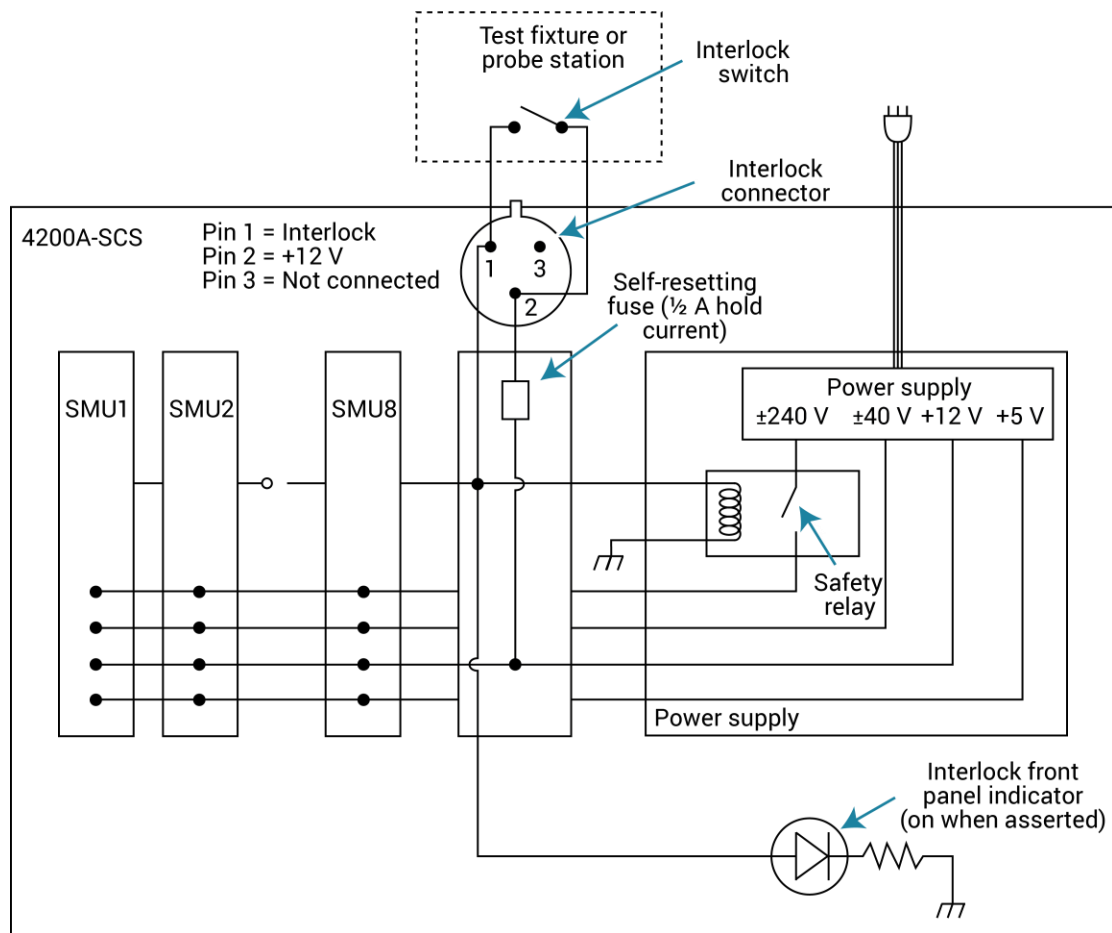

⚠ WARNING

Turning the 4200A-SCS output off does not place the instrument in a safe state (an interlock is provided for this function). Hazardous voltages may be present on all output and guard terminals. To prevent electrical shock that could cause injury or death, never make or break connections to the 4200A-SCS while the instrument is powered on. Turn off the equipment from the front panel or disconnect the main power cord from the rear of the 4200A-SCS before handling cables. Putting the equipment into an output-off state does not guarantee that the outputs are powered off if a hardware or software fault occurs. Precautions must be taken to prevent a shock hazard by surrounding the test device and any unprotected leads (wiring) with double insulation rated for 250 V, Category O.

Prober connections

Refer to *Model 4200A-SCS Prober and External Instrument Control* for details on how to enable and configure prober control for supported probes.

GPIB connections

The built-in IEEE-488 connector allows you to interface the 4200A-SCS to a variety of GPIB-equipped devices, such as a CV meter or switching system. The unit can also be configured as a GPIB subordinate and be controlled by an external host computer.

Configuring IEEE-488 controller operation

You can configure the 4200A-SCS to operate either as a GPIB controller or GPIB subordinate. The 4200A-SCS acts as a GPIB controller when Clarius is running. When operating as a controller, the 4200A-SCS reserves primary address 0, making that address unavailable to GPIB subordinate devices such as GPIB switch matrices, CV meters, and probe stations. Drivers for these and other instruments, typically integrated into semiconductor test systems, are included with the 4200A-SCS. These drivers, called user libraries, permit Clarius and the 4200A-SCS to control GPIB subordinate devices directly.

For instrumentation and equipment that is not supported by the standard user libraries, the open architecture of the 4200A-SCS allows you to create your own user libraries using the Keithley User Library Tool (KULT). Refer to *Model 4200A-SCS KULT and KULT Extension Programming* (4200A-KULT-907-01) for more information regarding the standard user libraries, KULT, and controlling external instrumentation.

Configuring IEEE-488 subordinate operation

The 4200A-SCS acts as a GPIB subordinate when the Keithley External Control Interface (KXCI) software is running. When KXCI is running, the 4200A-SCS can be controlled by an external computer using the KXCI command set. For detailed information regarding KXCI, refer to *Model 4200A-SCS KXCI Remote Control Programming*.

Preamplifier mounting

⚠ WARNING

Exposure to electrical shock could result in personal injury or death. Precautions must be taken to prevent a shock hazard by surrounding the test device and any unprotected leads (wiring) with double insulation that is rated for 250 V, Category O. See IEC 61010-1 safety standards for details. When connecting to the 4200A-SCS SMU outputs, make sure to use devices and cables that have ratings for the sourced voltages. Cables with incorrect ratings will not properly insulate the external connections to the instrument and may pose a shock hazard. SMU and preamplifier terminals should be considered hazardous even if the outputs are programmed to be low voltage.

CAUTION

Turn off the system and disconnect the power cord before connecting or disconnecting the preamplifier. Failure to do so may result in SMU or preamplifier damage, possibly voiding the warranty.

Any 4200-PA units that are ordered with the 4200A-SCS are factory-mounted on the rear panel. The preamplifiers can be removed from the rear panel and mounted remotely to reduce the effects of long cables on measurement quality (long cables can add noise to low current measurements and can cause oscillation with some devices).

An installed preamplifier is matched to the SMU to which it is connected. Therefore, if you disconnect the preamplifiers to mount them at a remote location, you must make sure that you reconnect each one to its matching SMU.

The preamplifier must be connected to the SMU before use. The connection method used depends on the mounting method (rear panel or remote).

Mounting a preamplifier in a remote location

The 4200-PA can be mounted remotely using an optional mounting kit. Follow the steps below to remotely mount and connect the preamplifier. Refer to the instructions provided with the mounting kit for detailed information on physically mounting the preamplifier module.

If you remove the preamplifiers to mount them at a remote site, install the screws in the chassis and retain the bracket for future use.

NOTE

The preamplifiers are matched to the SMUs that they were originally connected to. Ensure that each preamplifier is connected to its original SMU.

To mount the 4200-PA in a remote location:

1. Ensure system power is turned off.
2. Disconnect the line cord.
3. Mount the preamplifier at the remote location using the appropriate mounting kit.
4. Connect the control cable between the preamplifier control connector on the preamplifier and the PA CNTRL connector on the SMU as shown in the following figure.

Figure 10: Typical preamplifier remote mounting

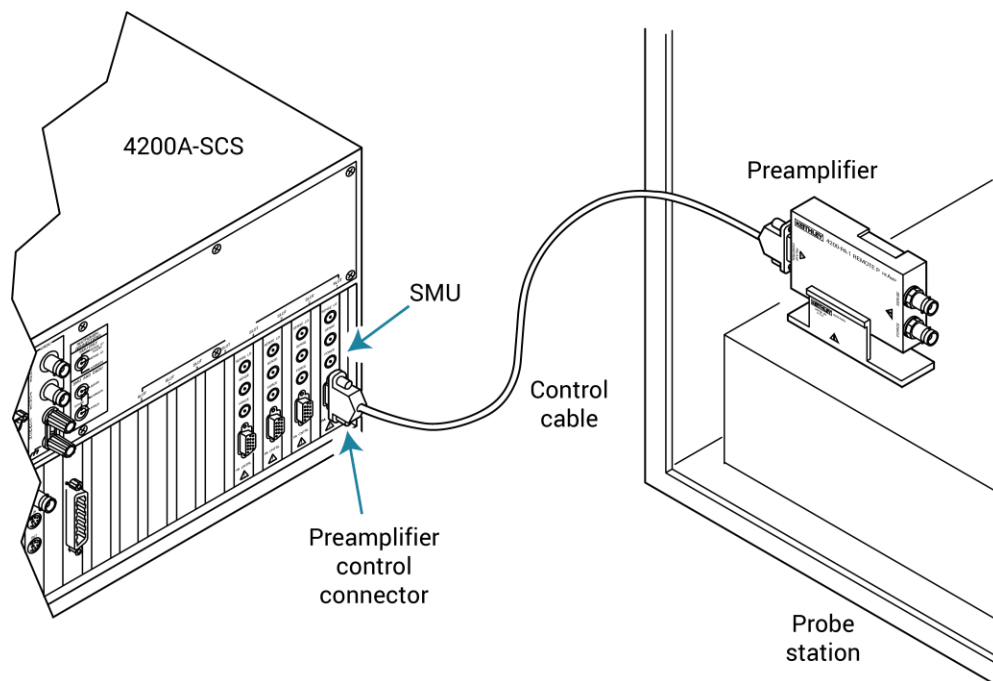

5. Make sure that the connecting cable is secure at both ends.
6. In KCon, run **Update**. For more information, see [Keithley Configuration Utility \(KCon\)](#) (on page 3-1).

Mounting a preamplifier to the rear panel

A mounting foot secures the preamplifier to the rear panel. Extra support for all the preamplifiers is provided by a mounting bracket, as shown in the following figure.

NOTE

The preamplifiers are matched to the SMUs to which they were originally connected. Ensure that each preamplifier is connected to its original SMU.

After mounting the preamplifier, in KCon, run **Update**. For more information, see [Keithley Configuration Utility \(KCon\)](#) (on page 3-1).

Figure 11: Preamplifier rear-panel mounting

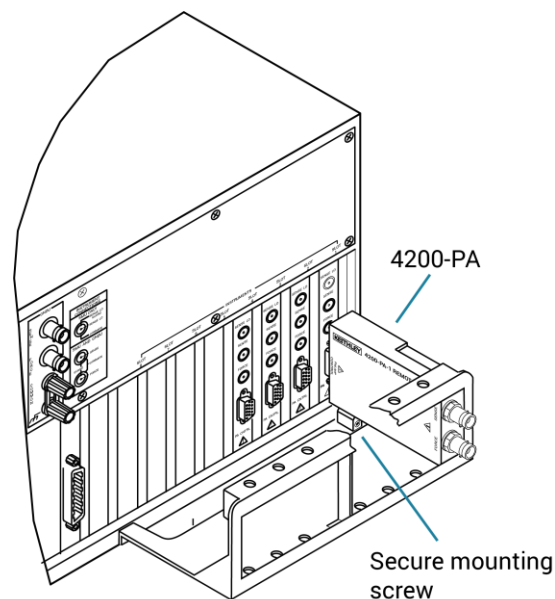

Connections to the device under test

To make the connections to the device under test (DUT), refer to the manual for the instrument you are connecting to:

- *Model 4200A-SCS Source-Measure Unit (SMU) User's Manual*
- *Model 4200A-SCS Capacitance-Voltage Unit (CVU) User's Manual*
- *Model 4200A-SCS Pulse Card (PGU and PMU) User's Manual*

Powering the 4200A-SCS

CAUTION

Operating the instrument on an incorrect line voltage may cause damage to the instrument, possibly voiding the warranty.

WARNING

The power cord supplied with the 4200A-SCS contains a separate protective earth (safety ground) wire for use with grounded outlets. When proper connections are made, the instrument chassis is connected to power-line ground through the ground wire in the power cord. In the event of a failure, not using a properly grounded protective earth and grounded outlet may result in personal injury or death due to electric shock.

Do not replace detachable mains supply cords with inadequately rated cords. Failure to use properly rated cords may result in personal injury or death due to electric shock.

The 4200A-SCS operates from a line voltage in the range of 100 V AC to 240 V AC at a frequency of 50 Hz or 60 Hz. Line voltage is automatically sensed, but line frequency is not.

NOTE

Although the instrument does not sense power line frequency at power-up, Keithley ships your 4200A-SCS with line frequency settings that match the line frequency that was specified on the order, either 50 Hz or 60 Hz. However, if necessary, you can change the line frequency setting using the KCon utility. Refer to [Keithley Configuration Utility \(KCon\)](#) (on page 3-1).

NOTE

Operating the 4200A-SCS with the wrong line frequency setting may result in noisy readings because the line frequency setting affects SMU line frequency noise rejection.

To connect and power the unit:

1. Check to be sure that the operating voltage in your area is compatible.
2. Connect the socket end of the supplied power cord to the AC receptacle on the rear panel.

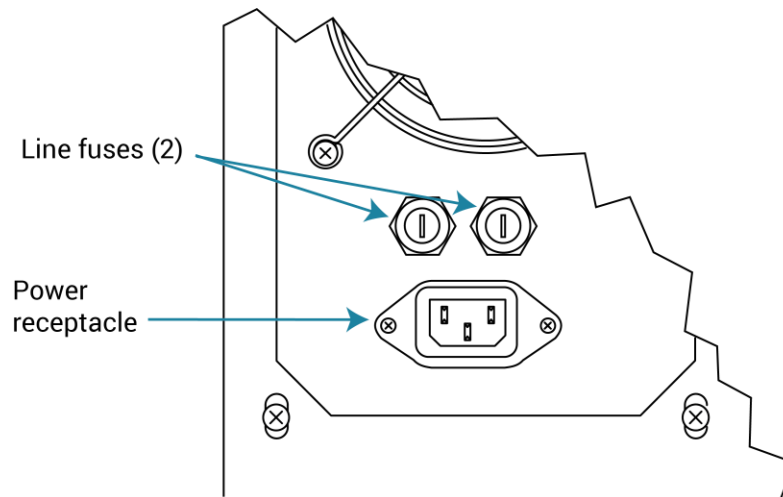
Figure 12: Line power receptacle and line fuse locations

3. Connect the other end of the supplied line cord to a grounded AC line power receptacle.
4. Turn the power on using the front-panel power switch.
5. Allow the instrument to warm up for at least 30 minutes to achieve rated measurement accuracy.

Powering off the 4200A-SCS

The recommended method to power off the 4200A-SCS is to press the power switch briefly. This allows Microsoft Windows to complete its standard shut down process.

If you need to power off the instrument and modules immediately, you can hold the power button down for a few seconds. This shuts down the instrument, modules, and computer immediately.

When the instrument is shut down, the power switch is no longer illuminated.

Configuring the system

You do not need to perform system configuration operations if you use only internal instruments, such as factory-installed SMUs, preamplifiers, and the ground unit (GNDU). The 4200A-SCS detects internal instruments and configures the system appropriately for local operation.

However, if you add supported external instruments such as switch matrices, the 4200A-CVIV Multi-Switch, external GPIB instruments, or probe stations, you must configure the system so that the Clarius software and KXCI software can use these resources. Also, if you need remote operation of the 4200A-SCS through KXCI, you must further configure the system.

Perform these configurations using the Keithley Configuration Utility (KCon). Start the tool by selecting the KCon icon on your desktop.

Figure 13: KCon desktop icon



See [Keithley Configuration Utility \(KCon\)](#) (on page 3-1) for details on using KCon.

NOTE

If KCon is running, you cannot start Clarius or KXCI. If Clarius or KXCI is already running, you can start KCon but cannot save any system configuration changes that you may make.

Learning Center

The Learning Center provides access to all 4200A-SCS information, such as:

- Instructions in .pdf files and videos.
- The 4200A-SCS Technical Data Sheet.
- Application notes that show examples of how to use the 4200A-SCS for application-specific tasks.
- Documentation for all 4200A-SCS instruments and software.

The Learning Center is optimized and tested on the latest versions of the following browsers:

- Google Chrome
- Microsoft Edge Chromium
- Firefox

NOTE

The search results in the Learning Center can cover the content in the center pane. To avoid this, you can increase the size of the right pane. Drag the border between the center and right panes to a location that allows you to see the center pane when the search results are displayed.

Installing Clarius+ software on a personal computer

You can install Clarius+ software on a personal computer (PC). With a PC installation, you can:

- Develop projects and tests that can be transferred to the 4200A-SCS.
- Import and manipulate data that was collected on a 4200A-SCS.
- Mimic your 4200A-SCS hardware configuration in KCon.
- Create SegArb and FullArb definitions in KPulse.
- Review content in the Learning Center.

When operated on a PC, you cannot make measurements and you cannot run tests. The following Clarius+ software is not supported on a PC: KXCI, Firmware Upgrade, Initialize New User, and KULT.

CAUTION

If you are installing Clarius+ on a PC, you cannot have any components of 4200 KTEI installed on the PC. You must remove them before installation. You cannot run KTEI and Clarius+ on the same computer.

Personal computer requirements

The PC must meet the following minimum requirements:

- Memory: 8 GB RAM
- Display resolution: 1920 × 1080 (recommended) or one of the following:
 - 1680 × 1050
 - 1600 × 900
 - 1440 × 900
 - 1366 × 768

- Free hard drive space: 10 GB (solid-state drive recommended)
- Windows Office language pack: English (United States)
- Operating system: Windows 10 (64 bit) with latest updates applied

Installing Clarius+ software

To install Clarius+ software, you must be logged in as an administrator.

The installation files are available at tek.com/keithley.

To install the Clarius+ software on a personal computer:

1. Unzip the downloaded files to a folder on the C:\ drive.
2. Close all programs.
3. Double-click the `setup.exe` file to start the installation.
4. Follow the on-screen installation instructions.

Add or remove virtual instruments in KCon

To use the Clarius+ software, you need to adjust the virtual instruments using the Keithley Configuration application (KCon). You can set the instruments match your 4200A-SCS system or to experiment with other system configurations.

To add instruments using KCon:

1. Open KCon. The Keithley Configuration Utility PC Edition opens.
2. To remove an instrument, right-click the instrument and select the remove option.
3. To add an instrument, right-click 4200A-SCS and select the instrument you want to add.
4. Select **Save**.

Uninstalling the Clarius+ software

You can use Windows Add or Remove function to uninstall the Clarius+ software.

The installation includes the Clarius Server web server to support the Learning Center and Clarius help pane. If you uninstall Clarius+, you must uninstall Clarius Server separately.

To uninstall Clarius Server:

1. In Windows Search, search for **Internet Information Services**.
2. In the Connections list, right-click Clarius Server and select **Remove**.

Keithley Configuration Utility (KCon)

In this section:

Keithley Configuration Utility (KCon)	3-1
KCon main window	3-2
System Configuration	3-3
Add an external instrument	3-4
Remove an external instrument	3-12
Validate	3-13
Update the configuration	3-13
Save	3-15
Summary	3-16
System Configuration properties	3-16
KXCI Settings	3-21
Tools	3-26

Keithley Configuration Utility (KCon)

You use the Keithley Configuration Utility (KCon) to manage the configuration of the Keithley Instruments 4200A-SCS and all external system components supported by the Clarius+ applications. You can add, configure, and remove supported switching matrices, external GPIB instruments, and probe stations from the system configuration using KCon. KCon also provides diagnostic and troubleshooting functions.

If you add an instrument to the system or change connections between the measurement instrumentation and the switching matrix, you must run KCon to update the system configuration.

NOTE

Before starting KCon, ensure that Clarius is not running. You cannot modify the system configuration while Clarius is running.

KCon main window

When KCon starts, the KCon main window shown in the following figure opens.

The System Configuration list provides a tree view of all instruments and equipment in the 4200A-SCS system configuration. To expand or minimize the tree, select the arrows to the left of each system component.

The Properties area displays information about the selected instrument. Each instrument in the System Configuration list has properties.

You may need to use the scroll bar to view the entire system configuration.

Figure 14: KCon main window

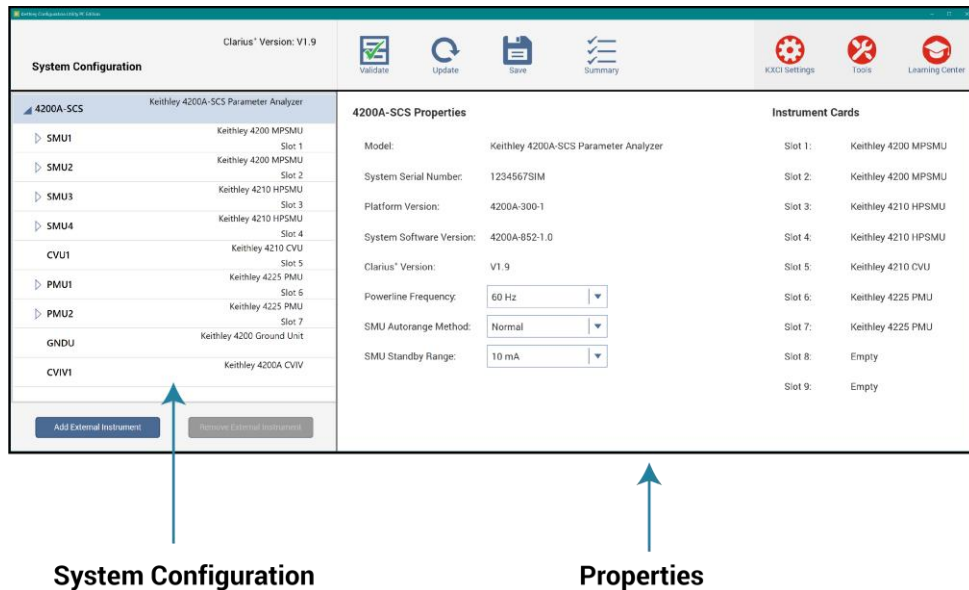

System Configuration

The System Configuration list displays each component in the system. Selecting a component in the list displays the properties for the selected component. The figure below shows a typical system configuration with some of the System Configuration list items expanded.

Figure 15: System Configuration

Internal instruments, such as SMUs, preamplifiers, and ground units

System Configuration	
▲ 4200A-SCS	Keithley 4200A-SCS Parameter Analyzer
▲ SMU1	Keithley 4200 MPSMU Slot 1
PA1	Keithley 4200 Preamp
▷ SMU2	Keithley 4200 MPSMU Slot 2
▷ SMU3	Keithley 4210 HPSMU Slot 3
▷ SMU4	Keithley 4210 HPSMU Slot 4
CVU1	Keithley 4210 CVU Slot 5
▷ PMU1	Keithley 4225 PMU Slot 6
▷ PMU2	Keithley 4225 PMU Slot 7
GNDU	Keithley 4200 Ground Unit
CVIV1	Keithley 4200A CVIV
▲ MTRX1	Keithley 708/708A/708B Switching System GPIB 19
CARD1	Keithley 7174 Low Current Matrix Card Slot 1

External instruments, such as user-installed switch matrixes, probe stations, test fixtures, and general purpose test instruments

Add External Instrument Remove External Instrument

Add an external instrument

To add a supported external instrument to the system configuration, select **Add External Instrument**. The supported instrument categories are:

- Switch Matrix
- Capacitance Meter
- Pulse Generator
- Probe Station
- Test Fixture
- General Purpose Test Instrument

Supported external instrumentation and equipment are controlled by Clarius user test modules (UTMs). Keithley Instruments provides libraries of user modules for each supported external instrument (refer to [Supported external equipment](#) (on page 3-6)).

You can modify these libraries or create your own using the Keithley User Library Tool (KULT). For additional information, refer to *Model 4200A-SCS KULT and KULT Extension Programming* (4200A-KULT-907-01).

The following figure shows the relationship between internal and external instrumentation and illustrates each instrument category.

Figure 16: Example system connections

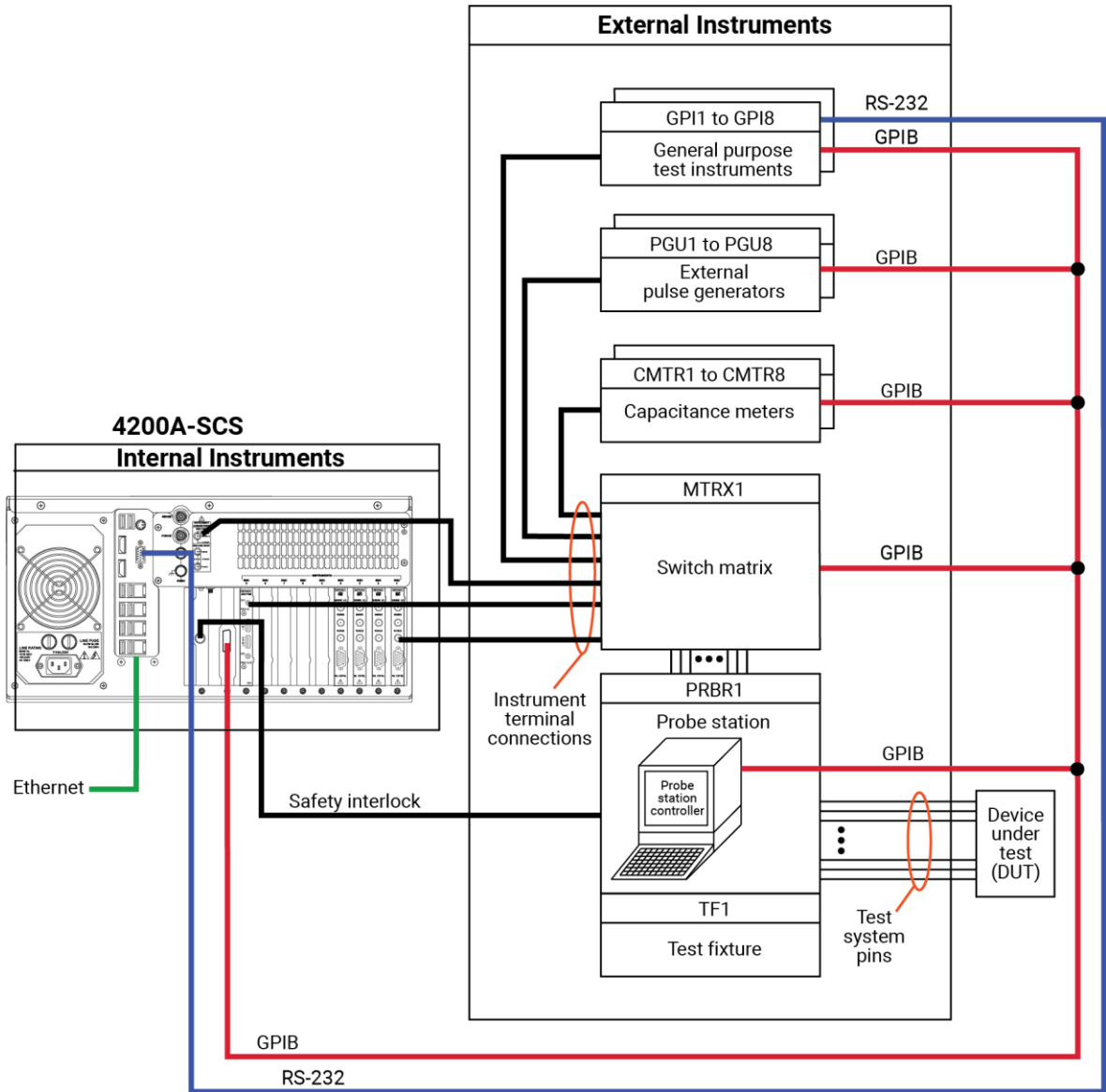

To add an external instrument:

1. Select **Add External Instrument**.
2. Select the instrument. You can only make one selection at a time.
3. Select **OK**. The instrument is added to the System Configuration list.

Supported external equipment

Keithley Instruments supports the following external equipment:

- [Switching matrix](#) (on page 3-6)
- [Capacitance meters](#) (on page 3-6)
- [Pulse generators](#) (on page 3-7)
- [Probe stations](#) (on page 3-8)
- [Test fixtures](#) (on page 3-8)
- [Arbitrary function generators](#) (on page 3-9)
- [General purpose test instruments](#) (on page 3-9)

Keithley provides a number of standard user libraries to control external equipment that is typically used in semiconductor characterization applications.

NOTE

Contact Keithley Instruments for the most recent list of supported external equipment.

Switching matrix

You can use the Keithley Instrument Series 700 Switching System with the 4200A-SCS. Only one switching matrix can be in the system configuration at a time.

The `Matrixulib` standard user library is provided for use with switching matrices.

For detail on using the switching matrix with the 4200A-SCS, refer to “Using Switching Matrices” in *Model 4200A-SCS Prober and External Instrument Control*.

Capacitance meters

The 4200A-SCS supports the following capacitance meters:

- Keithley Instruments Model 590 CV Analyzer
- Keithley Instruments Model 595 Quasistatic C-V Meter
- Keithley Instruments Model 82 Simultaneous C-V System
- Keysight Technologies 4284 or 4980 LCR Meter
- Keysight Model 4294 LCZ Meter

You can add up to eight supported capacitance meters to the system configuration.

For the Model 590, the standard user library `KI590u1ib` is available. For more information on the Model 590, refer to “Using a Model 590 CV Analyzer” in *Model 4200A-SCS Prober and External Instrument Control*.

For the Model 595, the standard user library `KI595u1ib` is available. For more information on the Model 595, refer to *Model 595 Quasistatic C-V Meter Instruction Manual* (document number 595-901-01), available at tek.com/keithley.

For the Model 82, the standard user library `ki82u1ib` is available. For more information on the Model 82, refer to “Using a Keithley Model 82 C-V System” in *Model 4200A-SCS Prober and External Instrument Control*.

For the 4284 or 4980, the standard user library `HP4284u1ib` is available. For more information on the 4284 or 4980, refer to “Using a Keysight 4284/4980A LCR Meter” in *Model 4200A-SCS Prober and External Instrument Control*.

For the Model 4294, the standard user library `HP4294u1ib` is available. For more information on the Model 4294 user library, refer to “HP4294u1ib user library reference” in the *Model 4200A-SCS Clarius User's Manual*.

Pulse generators

The 4200A-SCS supports the following pulse generators:

- Keithley Instruments Model 3402 Pulse Generator
- Keysight Model 8110A Pulse Generator

The 4200A-SCS supports a maximum of 16 pulse-generator unit (PGU) channels. You can combine single-channel and dual-channel pulse generators. For example, if three dual-channel and five single-channel pulse generators are used, the total number of PGUs is 11. For limits on maximum number of internal pulse generators in a test, see “4200A-SCS power supply limitations” in the *Model 4200A-SCS Pulse Card (PGU and PMU) User's Manual*.

For the Model 3402, the standard user library `ki340xu1ib` is available. For more information on Model 3402, refer to *Series 3400 Pulse Pattern Generators User's Manual* (document number 3400S-900-01), available at tek.com/keithley.

For the Model 8110A, the standard user library `HP8110u1ib` is available. For more information on the Model 8110A, refer to “Using a Keysight 8110A/81111A Pulse Generator” in *Model 4200A-SCS Prober and External Instrument Control*.

Probe stations

You can control the following probe stations with the 4200A-SCS:

- Suss MicroTec Model PA-200 semiautomatic probe station
- Micromanipulator Model 8860 semiautomatic probe station
- Manual probe station and fake probe station
- Cascade Summit-12000 probe station
- Signatone CM500 Prober
- MPI Probers TS2000, TS2000-DP, TS2000-HP, TS2000-SE, TS3000, and TS3000-SE

The `PRBGEN` standard user library is provided for use with probe stations.

For detail on using the Model PA-200 probe stations with the 4200A-SCS, refer to “Suss MicroTec PA-200 Prober” in *Model 4200A-SCS Prober and External Instrument Control*.

For the Model 8860, refer to “Micromanipulator 8860 Prober” in *Model 4200A-SCS Prober and External Instrument Control*.

For manual and fake probe stations, refer to “Using a Manual or Fake Prober” in *Model 4200A-SCS Prober and External Instrument Control*.

For the Summit-12000, refer to “Cascade Summit-12000 Prober” in *Model 4200A-SCS Prober and External Instrument Control*.

For the CM500, refer to “Signatone CM500 Prober” in *Model 4200A-SCS Prober and External Instrument Control*.

For the MPI probers, refer to “Using an MPI Probe Station” in *Model 4200A-SCS Prober and External Instrument Control*.

For general information about using a probe station, refer to “Using a Probe Station” in *Model 4200A-SCS Prober and External Instrument Control*.

Test fixtures

You can use the following test fixtures with the 4200A-SCS:

- Keithley Instruments Model LR:8028 Component Test Fixture
- Keithley Instruments Model 8007 Semiconductor Test Fixture
- Keithley Instruments Model 8101-PIV Test Fixture
- Generic test fixture

For more information, refer to “Connections and configuration” in the *Model 4200A-SCS Source-Measure Unit (SMU) User's Manual*.

There are no standard user libraries provided for general-purpose instruments.

Arbitrary function generators

You can control AFG31000 Series Arbitrary Function Generators (AFGs) with the 4200A-SCS through USB communications. The 4200A-SCS supports up to four AFGs.

The `AFG31000_examples_ulib` standard user library is provided for AFGs.

For detail on using AFGs with the 4200A-SCS, refer to *Application note: USB Control of the AFG31000 Arbitrary Function Generator Using the 4200A-SCS Parameter Analyzer* (1KW-73917-0).

To connect and set up an AFG31000 for use with the 4200A-SCS, refer to [Adding AFG31000s to the 4200A-SCS configuration](#) (on page 3-15).

General purpose test instruments

You can use any GPIB controlled or RS-232 controlled instrument with the 4200A-SCS. The 4200A-SCS supports up to eight general-purpose instruments. Two-terminal and four-terminal types may be present in the system configuration simultaneously, but the total number of general-purpose instruments must be less than eight.

There are no standard user libraries provided for general-purpose instruments.

Add a driver for unsupported equipment

If you need to control an instrument that is not supported by a standard Keithley Instruments driver library, you can create an external instrument driver.

To learn more about creating external instrument drivers for the 4200A-SCS, refer to Keithley Instruments *Technical note 2661: Creating External Instrument Drivers for the Model 4200-SCS*.

Use KCon to add equipment to the 4200A-SCS

To use the 4200A-SCS to control an external instrument, you must add that instrument to the system configuration.

The following topics describe general settings for adding equipment. Matrices and probers, however, require additional steps.

For detail if you are adding a switching matrix, refer to “Using Switching Matrices” in *Model 4200A-SCS Prober and External Instrument Control*.

For detail if you are adding a prober, refer to the information for your prober in *Model 4200A-SCS Parameter Analyzer Prober and External Instrument Control*.

NOTE

If you are adding a USB device that is controlled through a USB port, such as the AFG31000 or 4200A-CVIV, you do not need to add the equipment manually. You do need to use the Update option in KCon to automatically add the device to the configuration. Refer to [Update the configuration](#) (on page 3-13).

Step 1. Exit Clarius and open KCon

To exit Clarius and open KCon:

1. Exit Clarius.
2. On the Windows desktop, select the **KCon** icon.

Step 2. Add the equipment

To add equipment to the system configuration:

1. At the bottom left of KCon, select **Add External Instrument**.
2. Select the specific instrument.
3. Select **OK** to add the instrument to the System Configuration list.

Figure 17: Add external instrument

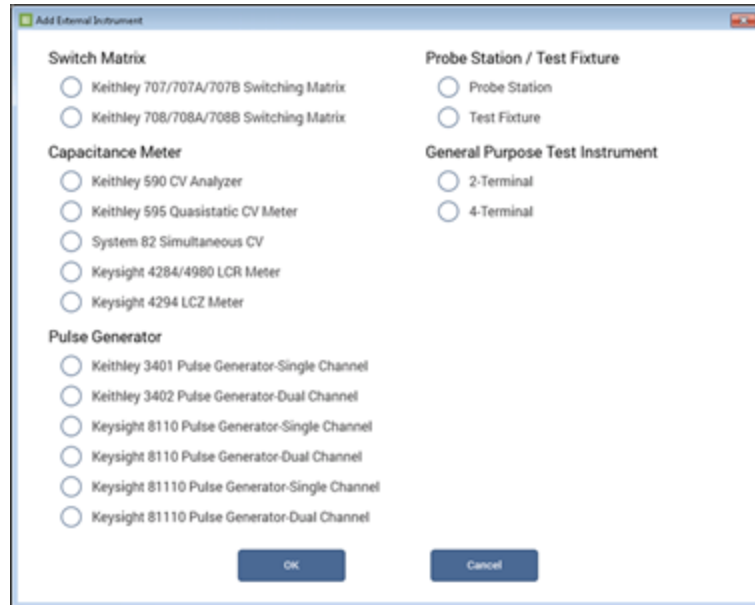

For descriptions of the options for your equipment, refer to [Instrument properties and connections](#) (on page 3-18).

Step 3. Set GPIB addresses

The GPIB address setting in KCon must match the actual GPIB address of the instruments in the system. See the documentation for the instruments to determine the GPIB Address.

The address for some instruments is briefly displayed during the power-on sequence.

To set the GPIB address for an instrument:

1. In the System Configuration list, select the instrument.
2. Select **GPIB Address** from the Properties. Addresses that are in use have an asterisk (*) next to them. The range of addresses is 0 to 30 (GPIB address 31 is reserved as the 4200A-SCS controller address). If the selected GPIB address conflicts with the GPIB address of another system component, a red exclamation-point symbol (!) is displayed next to the selected address.

NOTE

You can programmatically read the GPIB address and other instrument properties from the system configuration using the LPT library `getinstattr` function. Proper use of `getinstattr` allows you to develop user libraries that are independent of the configuration. For more information, refer to *Model 4200A-SCS KULT and KULT Extension Programming* (4200A-KULT-907-01).

Step 4. Save configuration

To save the KCon configuration:

Select **Save**.

Step 5. Validate configuration

This step checks communications between the 4200A-SCS and the attached equipment.

To validate configuration:

Select **Validate**.

The verification report is displayed in KCon.

Remove an external instrument

To remove an external component from the system configuration:

1. Select the component.
2. Select **Remove External Instrument**. A confirmation dialog is displayed.
3. Select **OK**.

NOTE

You cannot remove internal instruments.

Validate

The Validate option tests the system configuration to determine if there are configuration conflicts or communications problems between the instrumentation and the 4200A-SCS. This test can validate most of the supported internal and external instruments. However, the following instruments are not automatically verified when the configuration is validated:

- Probe stations
- Test fixtures
- General purpose test instruments

When you run Validate, KCon communicates with the instruments to verify that the physical configuration matches the configuration defined in KCon. The report is displayed, including "Verify Passed" messages if the configurations match and error messages if there are conflicts.

NOTE

Clarius automatically validates the configuration when it starts up. If Clarius detects conflicts, it displays an error message that instructs you to resolve the conflicts using KCon.

Update the configuration

After adding or removing a preamplifier, RPM, or 4200A-CVIV, you must update the system by selecting **Update**.

Update the preamplifier configuration

For more information on adding or removing preamplifiers, refer to "Connections and configuration" in the *Model 4200A-SCS Source-Measure Unit (SMU) User's Manual*.

To update the preamplifier configuration:

1. Remove or reconnect a preamplifier to the SMU.
2. Select **Update**.
3. Select **Save**.

Update the RPM configuration

KCon Update must be run:

- Whenever an RPM is connected or disconnected from the 4200A-SCS
- Whenever RPM input connections for a SMU, CVU, or PMU are changed

When using interactive test modules (ITMs) for DUT testing, you can configure RPM switching in KCon. After you connect the PMU, SMUs, and CVU to the RPM, update the RPM configuration in KCon. When you then open Clarius, the system detects the instrument connections to the RPM. When an ITM is run, Clarius automatically closes the appropriate switches to connect the PMU, SMU, or CVU to the output of the RPM. Use the following procedure to configure RPM switching.

For more information on adding or removing RPM connections, refer to the *Model 4200A-SCS Pulse Card (PGU and PMU) User's Manual*.

To update RPM configuration:

1. Turn off system power.
2. Disconnect line power.
3. Connect the correct RPM to the correct PMU channel.
4. If the system contains SMUs: Connect any SMU to any RPM using either one or two triaxial cables. Repeat for all RPMs in the system.
5. If the system contains a CVU: Connect CVU High to one RPM, and CVU Low to the other RPM.
6. Turn on the system power.
7. Start KCon.
8. Select **Update**.
9. Select **Save**.
10. Exit from KCon.

Update the 4200A-CVIV configuration

For more information on adding or removing 4200A-CVIV connections, refer to “Install and configure the 4200A-CVIV” in the *Model 4200A-CVIV User's Manual*.

To update CVIV configuration:

1. Turn off system power.
2. Disconnect the 4200A-CVIV from the 4200A-SCS.
3. Make connections to the 4200A-CVIV.
4. Turn on system power.
5. Start KCon.
6. Select **Update**.
7. Select **Save**.

Adding AFG31000s to the 4200A-SCS configuration

You can control AFG31000 Series Arbitrary Function Generators (AFGs) with the 4200A-SCS through USB communications using a USB Type A to USB Type B cable. The 4200A-SCS supports up to four AFGs.

To add the AFG31000 to the system configuration, you need to run KCon Update. When you run update, the 4200A-SCS automatically detects the connected AFG31000s.

To connect an AFG31000 and add it to the 4200A-SCS configuration:

1. Turn off the power to the 4200A-SCS and AFG31000.
2. Connect the USB B end of the cable to the USB connection port on the rear panel of the AFG31000.
3. Connect the USB A end of the cable to any of the USB A ports on the 4200A-SCS.
4. Turn on the power to both instruments.
5. On the 4200A-SCS, start the KCon application.
6. Select **Update**.
7. Select **Save**.

For detail on using AFGs with the 4200A-SCS, refer to *Application note: USB Control of the AFG31000 Arbitrary Function Generator Using the 4200A-SCS Parameter Analyzer* (1KW-73917-0).

Save

Saves changes to the system configuration. If you do not save the configuration changes, KCon returns to the last saved configuration when you exit.

Summary

The Summary displays the system configuration. From this display, you can save the configuration or print it.

The sections of the system configuration are:

- **System Information:** Provides a table containing the 4200A-SCS serial number, the network or system name, and pertinent software and platform version information.
- **Instrumentation:** Provides a table of properties and settings for each instrument in the system configuration.
- **Connections:** Provides a table of system connections. The connection table provides guidance when making connections between the instrumentation and an optional switching matrix and test fixture or probe station.

To save the files in `html` format, select **Save Configuration As**. You can view the `html` file in a web browser.

To print the configuration, select **Print Configuration**.

System Configuration properties

Each instrument that is included in the system is displayed in the System Configuration list. When you select an item from the list, the corresponding properties are displayed in the Properties area. The following topics describe the properties for each supported instrument.

KI 4200A SCS Properties

When you select **4200A-SCS** in the System Configuration list, the Properties of the 4200A-SCS are displayed, as shown in the following figure.

Figure 18: 4200A-SCS Properties

4200A-SCS	Keithley 4200A-SCS Parameter Analyzer	4200A-SCS Properties	Instrument Cards
▶ MTRX1	Keithley 708/708A/708B Switching System GPB 19	Model: Keithley 4200A-SCS Parameter Analyzer	Slot 1: Keithley 4200 MPSMU
CMTR1	Keithley 590 CV Analyzer GPB 15	System Serial Number: 1234567SIM	Slot 2: Keithley 4200 MPSMU
		Platform Version: 4200A-300-1	Slot 3: Keithley 4210 HPSMU
		System Software Version: 4200A-852-1.0	Slot 4: Keithley 4210 HPSMU
		Clarius' Version: V1.9	Slot 5: Keithley 4210 CVU
		Powerline Frequency: 60 Hz	Slot 6: Keithley 4225 PMU
		SMU Autorange Method: Normal	Slot 7: Keithley 4225 PMU
		SMU Standby Range: 10 mA	Slot 8: Empty
			Slot 9: Empty

System Properties area

The System Properties area of the Properties displays the 4200A-SCS serial number and other software and platform information. You can change the [Powerline frequency](#) (on page 3-17), [SMU autorange method](#) (on page 3-17), and [SMU standby range](#) (on page 3-18).

Powerline frequency

Set **Powerline Frequency** to **60 Hz** or **50 Hz**. Make sure you set the powerline frequency correctly. If the setting is wrong, the 4200A-SCS cannot properly reject powerline measurement noise.

SMU autorange method

The source measure units (SMUs) in the 4200A-SCS can make smart decisions when changing range. There are many factors the SMUs calculate when they change the range. The SMU autorange method allows you to determine which range change algorithm meets your needs. The available SMU autorange methods are normal, high-speed, or high-resolution.

For the normal autorange method, the SMU makes a range decision at 50 percent of range. This allows for a relatively high-precision measurement with a minimum of range disruptions to the measurement. This mode works reliably in most conditions, and should be used unless there is a precision, speed, or glitch condition that you are attempting to correct.

For the high-speed autorange method, the SMU ranges at 10 percent of range. This approximately doubles the speed of the measurement. The SMU can provide 6-digit precision, but a digit of precision is lost when using the high-speed autorange method. However, 5-digit precision is enough for most applications. The high-speed autorange method is also the best choice if the device or test configuration tends to exhibit unstable characteristics, such as oscillations or unstable device readings.

For the high-resolution autorange method, the SMU ranges at 100 percent of range. This is the slowest autorange method, but allows full precision of the SMU. This is also the lowest noise autorange method. Occasionally, this method causes a small measurement glitch on a complete sweep. In that case, changing to the high-speed autorange method often resolves the problem.

Select the autorange method from the **SMU AutoRange Method** list.

SMU standby range

When the SMU is not performing a test, it is in standby mode. When in standby, the SMU is programmed to output 0 V, with current compliance set to the maximum on the standby current range you selected. This allows the SMU to look like a virtual short circuit, and to prevent static charges from building up. The default standby range for the SMU is 10 mA.

You may need to select a different standby range to tune or correct a test condition or result that is less than optimal. For example, if the test condition always starts the measurement on the 100 μ A range, selecting the 100 μ A standby range speeds up the measurement. This may also correct the occasional data glitch that is seen on the first point of a sweep.

Set standby range by selecting the **SMU Standby Range** from the list.

Instrument Cards area

The Instrument Cards area shows which internal instrument card is installed in each slot.

Instrument properties and connections

Each instrument in KCon has a Properties screen. Properties may include the vendor name, model number, slot number, firmware and hardware versions, serial number, and calibration information for the instrument.

Some instruments include a Run Self Test option. The Self Test button starts the Self Test utility, which runs several internal performance checks to determine if the instrument is operating correctly. When the Self Test process finishes, a pass or fail message is displayed. For more information on Self Test, see [Run Self Test](#) (on page 4-5).

If you added external instruments, you can also set the GPIB address from this screen.

If your system configuration includes a matrix, the matrix connections to the measurement terminals are also displayed.

If you added a test fixture, you can select a type of test fixture and define the number of test fixture pins (2 to 72).

NOTE

The number of pins defined in the properties for the test fixture or probe station determines the pins that are available to assign to a switching matrix card column. Make sure the number of pins assigned is appropriate for your system.

NOTE

For supported external instruments, the 4200A-SCS provides user libraries that contain preconfigured data acquisition and control user modules. Refer to [Supported external equipment](#) (on page 3-6) for a list of supported equipment and additional information.

The following topics describe general settings for equipment. Matrices and probers, however, require additional steps. For detail if you are adding a switching matrix, refer to “Using Switching Matrices” in *Model 4200A-SCS Prober and External Instrument Control*.

For detail if you are adding a prober, refer to the information for your prober in *Model 4200A-SCS Parameter Analyzer Prober and External Instrument Control*.

Set GPIB addresses

If you added an external instrument, you can set the GPIB address.

In the GPIB Address list, addresses that are in use are displayed with asterisks (*) next to them. You can set addresses from 0 to 30 (GPIB address 31 is reserved as the 4200A-SCS controller address). If the selected GPIB address conflicts with the GPIB address of another system component, a red exclamation-point symbol (!) is displayed next to the selected address.

NOTE

You can programmatically read the GPIB address and other instrument properties from the system configuration using the LPT library `getinstattr` function. Proper use of `getinstattr` allows you to develop user libraries that are independent of the configuration. For more information, refer to *Model 4200A-SCS KULT and KULT Extension Programming* (4200A-KULT-907-01).

To set the GPIB address:

1. Select the instrument in the System Configuration. An example of the Keithley 590 C-V Analyzer information is shown in the figure below.
2. From the **GPIB Address** list, select the address.
3. Select **Save**.

Figure 19: Keithley 590 CV Analyzer Properties and Connections

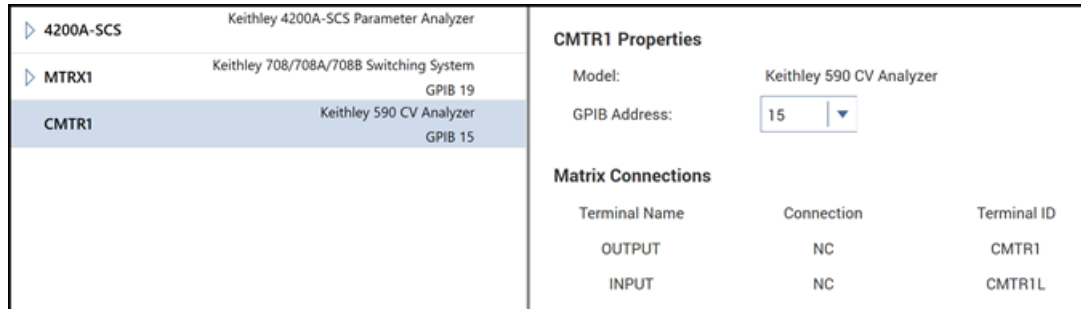

Add a general-purpose instrument

You can add a general-purpose instrument to your system configuration if your application requires an unsupported external instrument. See [Supported external equipment](#) (on page 3-6) for a list of supported instruments.

When you select a General Purpose Test Instrument in the System Configuration list, its properties and connections are displayed. The properties for a 2-terminal general-purpose instrument are shown in the following figure.

Figure 20: General Purpose Instrument 2-Terminal Properties and Connections

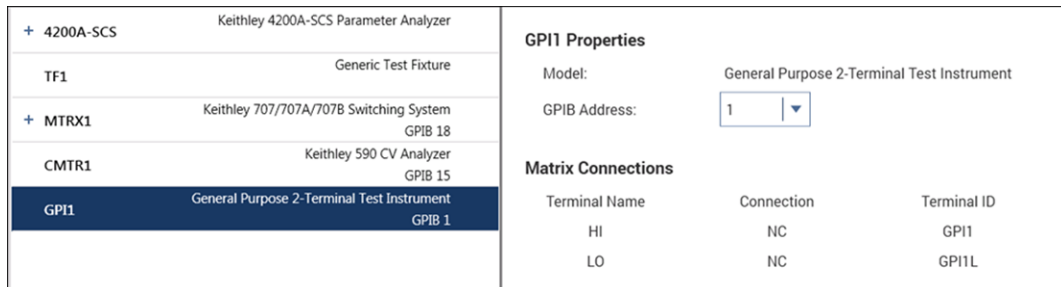

A two-terminal general-purpose instrument is an unsupported external instrument with two terminals (HI and LO), such as a current source. Generally, the instrument HI and LO terminals transmit or receive the instrument stimulus signals.

A four-terminal general-purpose instrument is an unsupported external instrument with four terminals (HI, SENSE HI, LO, and SENSE LO), such as a digital multimeter. Generally, the instrument HI and LO terminals transmit or receive the instrument stimulus signals. The instrument SENSE HI and SENSE LO terminals typically measure the device under test (DUT) response to the instrument stimulus.

NOTE

The SENSE HI and SENSE LO signals are automatically routed through separate (parallel) switching matrix pathways when making connections between the general purpose instrument HI/LO terminals and the test-system pins.

To control the operation of a GPIB or RS-232 general-purpose instrument in a Clarius project, create a user library with KULT and use the LPT library I/O functions (`kib*` and `ksp*`) to communicate with the general-purpose instrument. For more information, refer to *Model 4200A-SCS KULT and KULT Extension Programming (4200A-KULT-907-01)*.

As with any other instrument in the system configuration, general-purpose instrument terminals can be automatically routed to test system pins using the `ConnectPins` user module in the `Matrixulib` user library. For information, refer to “Using Switching Matrices” in *Model 4200A-SCS Prober and External Instrument Control*.

To set the GPIB address, refer to [Set GPIB addresses](#) (on page 3-19).

KXCI Settings

If you need to set up the 4200A-SCS as a subordinate on a GPIB or ethernet system, you do the initial setup through the KCon KXCI Settings. This allows you to use an external computer to remotely control the 4200A-SCS over GPIB or ethernet.

You can also use KXCI to set up emulation for Keysight 4145B Semiconductor Parameter Analyzers. In many cases, test programs developed for use with a Keysight 4145B run without modification when they are used with a 4200A-SCS running KXCI.

Refer to *Model 4200A-SCS KXCI Remote Control Programming* for detailed information regarding KXCI.

Set up KXCI for GPIB control

To set up GPIB control:

1. Open KCon.
2. Select **KXCI Settings**. The **KXCI Settings** dialog is displayed, as shown in the following figure.

Figure 21: KXCI Settings dialog

Instrument	Function	Number
SMU1:	SMU	1
SMU2:	SMU	2
Empty		
Empty		
Empty		
Empty		
Empty		
CVU1:		
Empty		

Communications

GPIB Ethernet

GPIB Address: 17 Port Number: 1225

Reading Delimiter

String Terminator EOI On EOI Off

Comma Character: CR/LF

Command Set

4200A (Normal) 4145 Emulation

OK Cancel

3. Set Communications to **GPIB**.
4. Set the **GPIB Address**. This is the primary address of the 4200A-SCS when operating under KXCI control. If the selected GPIB address conflicts with the GPIB address of another system component, a red exclamation-point symbol (!) is displayed next to the selected address.
5. Set the **Reading Delimiter** to determine the output data delimiter characters that are added to the end of each KXCI output message:
 - Select **String Terminator** to use a character.
 - Select **Comma** to terminate output data with a comma (,).
6. If you selected String Terminator, select the type of **Character**:
 - **None** to use no character.
 - **CR** to use a carriage return.
 - **LF** to use a line feed.
 - **CR/LF** to use a carriage return and line feed character sequence.
7. If **String Terminator** is selected, select **EOI ON** or **EOI OFF**. The EOI setting determines if the 4200A-SCS asserts the GPIB End Or Identify (EOI) signal with the last byte of each output data message.
8. Select **OK**.

When KXCI starts, the status messages look similar to the following figure when GPIB is set up.

Figure 22: KXCI status when GPIB selected

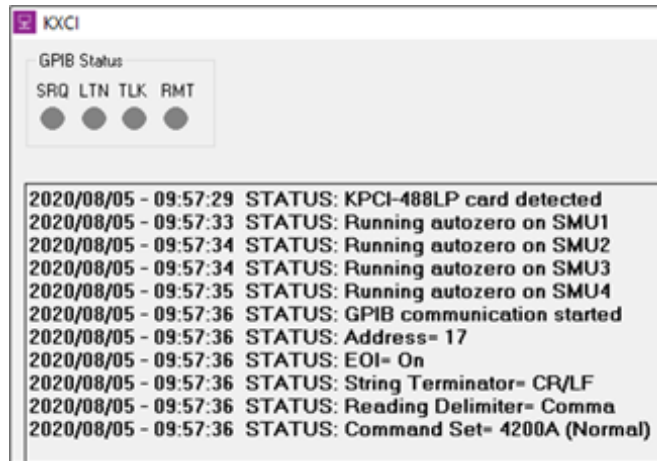

Set up KXCI for ethernet control

To set up ethernet control:

1. Open KCon.
2. Select **KXCI Settings**. The KXCI Settings dialog is displayed.
3. Set Communications to **Ethernet**.
4. Set the **Port Number** (the default is 1225, which is acceptable for most installations). Make note of the port number for use in the code.
5. Select a **Reading Delimiter**. The delimiter determines if the delimiter for output data is a string terminator or a comma.
6. If you selected String Terminator, select the **Character**. The options are:
 - **None** to use no character. Recommended to avoid extra termination characters. The 4200A-SCS automatically adds a null character as a terminator.
 - **CR** to use a carriage return.
 - **LF** to use a line feed.
 - **CR/LF** to use a carriage return and line feed character sequence.
7. Select **OK**.

When KXCI starts, the status messages look similar to the following figure when ethernet is set up.

Figure 23: KXCI status when ethernet is selected

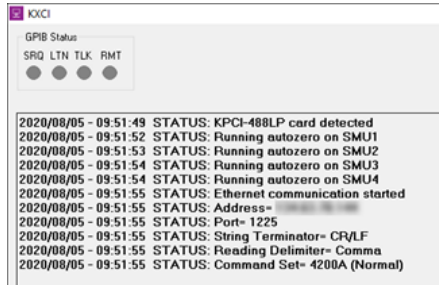

Setting up KXCI as a 4145B emulator

Although the KXCI command set is similar to the Keysight 4145B command set, the 4200A-SCS and Keysight 4145B hardware are different. To use existing 4145B code with the 4200A-SCS, you need to set up the 4200A-SCS SMUs to map to the 4145B instrument numbers. In many cases, test programs developed for use with a Keysight 4145B run without modification when they are used with a 4200A-SCS running KXCI. When a mode is selected, KXCI always starts in that mode.

The following table summarizes some differences and similarities between the modes.

Mode comparison

Characteristic	Mode	
	4200A (Normal)	4145 Emulation
String reported in response to ID query	KI4200A Vx.x.x (where x.x.x is the version number)	ID HP4145B 1.1,1.0
GPIB data resolution	7 digits	5 digits
Maximum number of sweep points	4096	1024
Possible instrument configurations	8 source-measure units (SMU), voltmeters (VM), or voltage-sources (VS)	
Configuration query	*OPT? command	Not supported
Instrument self test	SMUs only	Not supported
Custom A/D control	IT4 command options	Not supported
200 V, 1 A capability	Supported	
1.0 pA source/measure-range capability (with preamplifier on SMU)	Supported	

The main difference between the two instruments is that the 4200A-SCS hardware is modular and the Keysight 4145B hardware is fixed, as shown in the following table.

Hardware comparisons

Instrument type	Keithley Instruments 4200A-SCS	Keysight 4145B
Source measure units (SMUs)	2 to 9	4 (fixed)
Voltage meter (VM)	You can configure up to nine SMUs to function as voltage meters.	2 (fixed)
Voltage source (VS)	You can configure up to nine SMUs to function as voltage sources.	2 (fixed)

KCon manages these hardware differences by allowing you to assign source-measure unit (SMU), voltage meter, or voltage source functions to any 4200A-SCS SMU, as shown in the following table.

KXCI SMU function assignment

Function selection	Description
SMU	Instructs the 4200-SMU, 4201-SMU, 4210-SMU, or 4211-SMU to emulate a Keysight 4145B Source Measure Unit.
VM1...VM8 (voltage meter)	Instructs the 4200-SMU, 4201-SMU, 4210-SMU, or 4211-SMU to emulate a Keysight 4145B VM1 or VM2 and additional voltage meters (VMs). You can map up to eight VMs to SMUs. You can assign a VM any number from 1 to 8, regardless of the number of SMUs in the system. Each VM number must be unique.
VS1...VS8 (voltage source)	Instructs the 4200-SMU, 4201-SMU, 4210-SMU, or 4211-SMU to emulate the capabilities of a Keysight 4145B VS1 or VS2 and additional voltage sources (VSs). You can map up to eight VSs to SMUs. You can assign a VS any number from 1 to 8, regardless of the number of SMUs in the system. Each VS number must be unique.

To set up 4145B emulation:

1. Open **KCon**.
2. Select **KXCI Settings**. The **KXCI Settings** dialog is displayed, as shown in the following figure.
3. In the **Function** column, select the 4145 function that the SMU will emulate.
4. In the **Number** column, select the number that is used for the device in your 4145B program.

Figure 24: KXCI Settings for 4145B emulation

Instrument	Function	Number
SMU1:	SMU	1
SMU2:	VS	2
Empty		
Empty		
Empty		
Empty		
Empty		
CVU1:		
PMU1:		

Communication: GPIB Ethernet

GPIB Address: 17 Port Number: 1225

Reading Delimiter: String Terminator Comma

String Terminator: EOI On EOI Off Character: CR/LF

Command Set: 4200A (Normal) 4145 Emulation

Buttons: OK, Cancel

Command Set

The Command Set option chooses the control mode through which KXCI runs the 4200A-SCS: 4200A (Normal) or 4145 Emulation.

4200A (Normal) selects the 4200A command set. This command set includes all the 4145 Emulation commands plus an additional 4200A-only command.

In 4145 Emulation mode, the KXCI GPIB command set, status model, and output data are similar in function and format to those supported by the Keysight 4145B Semiconductor Parameter Analyzer.

Refer to [Setting up KXCI as a 4145B emulator](#) (on page 3-24) for information on differences and similarities between the two modes.

KXCI always starts in the selected mode.

Tools

The options in the Tools dialog allows you to change Formulator constants, generate technical support files, and get KCon version and copyright information.

Formulator Constants

The Formulator Constants option allows you to access the default Formulator constants that are automatically assigned to new Clarius test modules when they are created. You can edit the default Formulator constants.

Figure 25: Default Formulator constants

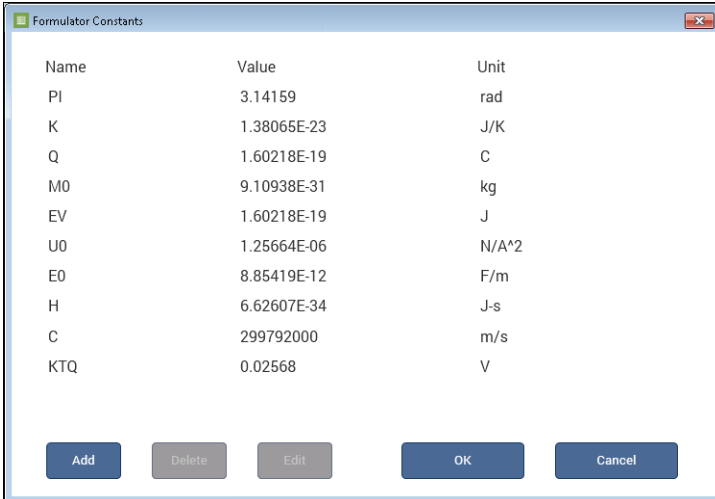

Name	Value	Unit
PI	3.14159	rad
K	1.38065E-23	J/K
Q	1.60218E-19	C
M0	9.10938E-31	kg
EV	1.60218E-19	J
U0	1.25664E-06	N/A ²
E0	8.85419E-12	F/m
H	6.62607E-34	J-s
C	299792000	m/s
KTQ	0.02568	V

Buttons: Add, Delete, Edit, OK, Cancel

The constants include:

- PI: π is the ratio of the circumference to the diameter of a circle
- K: Boltzmann constant
- Q: The charge of an electron
- M0: Electron mass
- EV: Electron volt
- U0: Permeability
- E0: Permittivity of a vacuum
- H: Planck's constant
- C: Speed of light
- KTQ: The thermal voltage

For additional information, see "The Formulator" in the *Model 4200A-SCS Clarius User's Manual*.

To change the constants:

1. Select **Tools**.
2. Next to Formulator Constants, select **Open**.
3. To add a constant, select **Add** and complete the fields.
4. To remove a constant, select the constant and select **Delete**.
5. To change a constant, select the constant and select **Edit**.

Generate Technical Support Files

The Technical Support Files option analyzes your 4200A-SCS. KCon stores the analysis results to a USB flash drive. You can then send the results to Keithley for review.

To generate a technical support file:

1. Insert a USB flash drive into one of the front-panel USB ports.
2. Select **Tools**.
3. Next to Technical Support Files, select **Generate**.
4. Select **Yes**.
5. After the System Audit window appears and indicates a successful analysis, select **OK**. The System Audit window closes.
6. Contact your local Keithley office, sales partner, or distributor for details on how to send the files.

Technical support personnel at Keithley will review the analysis information and assess the state of your 4200A-SCS.

About KCon

About KCon displays a dialog that contains version and copyright information.

Maintenance

In this section:

Introduction	4-1
Line fuses.....	4-1
Front-panel display.....	4-2
Fan operation.....	4-3
Air intake ventilation screens.....	4-4
Solid-state hard drive maintenance.....	4-4
Run Self Test	4-5
Connections for RPM Self Test.....	4-6
Returning the 4200A-SCS for repair or calibration	4-6
Check calibration status	4-8
Reset the hardware.....	4-8
Lithium battery.....	4-9
Autocalibrate the SMUs	4-9

Introduction

The information in this section describes routine maintenance of the instrument that the operator can perform.

Line fuses

Rear-panel fuses protect the power line input of the unit.

WARNING

Turn off the power and disconnect the line cord before replacing the fuses. Failure to turn off the power and disconnect the line cord before replacing the fuses may result in personal injury or death due to electric shock.

To replace the line fuses:

1. Locate the fuses. The fuses are in two fuse holders above the AC receptacle.
2. Use a small slotted screwdriver to remove each fuse holder.
3. Push the fuses in and rotate them counterclockwise to remove the fuses from the fuse holders.
4. Replace the fuses with the correct type according to your line voltage:
 - **100 V AC to 125 V AC:** 250 V, 15 A, 5 × 20 mm, slow-blow
 - **220 V AC to 240 V AC:** 250 V, 8 A, 5 × 20 mm, slow-blow

CAUTION

For continued protection against fire or instrument damage, replace the fuses only with the type and rating shown above. If the instrument repeatedly blows fuses, correct the cause of the problem before replacing the fuses.

Front-panel display

Do not use sharp metal objects, such as tweezers or screwdrivers, or pointed objects, such as pens or pencils, to touch the touchscreen. It is strongly recommended that you use only fingers to operate the instrument. Use of clean-room gloves to operate the touchscreen is supported.

Cleaning the front-panel display

If you need to clean the front-panel LCD touchscreen display, use a soft dry cloth. If necessary, use a microfiber cloth dampened with an ammonia-free glass cleaner. Do not spray cleaning fluids onto the display. You can also use a mixture of 70% isopropyl alcohol and 30% water.

Screen brightness

NOTE

This screen brightness control only applies to 4200A-SCS platform versions prior to 4200A-300-3. For versions 4200A-300-4 and later, use the Microsoft® Windows® brightness controls. For additional display controls, you can use the Intel® HD Graphics Control Panel.

To check the platform version, see the 4200A-SCS Properties in KCon. See [Keithley Configuration Utility](#) (on page 3-1) for more information.

You can adjust the screen brightness of the 4200A-SCS display.

To change the screen brightness:

1. In the lower right corner, open the notification area.

Figure 26: Front Panel Control in the notification area

2. Select **Front Panel Control**.
3. Move the slider to change the brightness.

Fan operation

If the 4200A-SCS fan stops or is running too slowly, a warning message is displayed on the instrument. If the fan does not return to normal within five minutes of the initial warning, the 4200A-SCS is shut down to prevent system damage from overheating.

If the system was powered down because of a fan problem and is then powered up, another warning message is displayed to indicate the reason for the shutdown.

If you see this message repeatedly, contact Keithley Instruments. See tek.com/service for contact information.

For detail on fan operation, you can open the 4200A-SCS System Monitor. This is available in the Windows system tray.

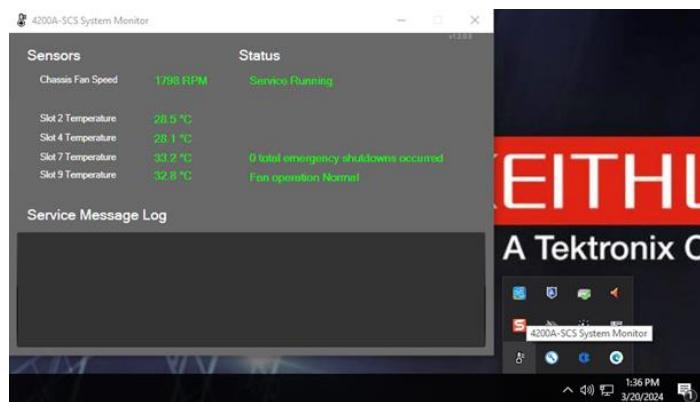
Figure 27: 4200A-SCS System Monitor

Air intake ventilation screens

Your 4200A-SCS comes equipped with an internal axial fan for active cooling of the instrument cards. Your instrument must be properly cooled to maintain optimum operating specifications.

There are three air inlets on your instrument: One on each side and one on the bottom.

Every six months or when a screen appears to be clogged, use a vacuum cleaner with a soft brush attachment to carefully remove the accumulated particulates. The screens must remain unrestricted to provide sufficient cooling airflow.

CAUTION

Never use compressed air to blow debris from the screens. Doing so can force particulates through the screen and into the instrument.

Solid-state hard drive maintenance

Your 4200A-SCS is shipped with a solid-state hard drive (SSD). SSDs offer several advantages over traditional hard drives, such as:

- Superior data access time
- Increased reliability
- Lower power usage
- Less heat generation

The SSD installed in your instrument does not require conventional hard drive maintenance, such as defragmentation.

CAUTION

Do not perform or schedule defragment operations on your SSD. Defragmentation can cause premature wear on the SSD and reduce its usable capacity more quickly compared to normal use. Programs or operations that result in excessive write operations to the SSD will also reduce the capacity more quickly.

Run Self Test

Some instruments include a Self Test option. When you run Self Test, the instrument runs a number of internal performance checks to determine if the instrument is operating correctly. You do not need external equipment to run Self Test.

NOTE

Calibration status does not affect the results of Self Test.

To run Self Test:

1. Allow the instrument to warm up for at least 30 minutes.
2. Select **Run Self Test**.
3. Follow the prompts. If you are testing an RPM, refer to [Connections for RPM Self Test](#) (on page 4-6).
4. When the test is complete, a pass or fail message is displayed.
5. If the test passed, this procedure is complete. If the test failed:
 - If the test required cables, check the cables to verify the connections.
 - If the cable connections are secure, replace the cables to make sure the existing cables are not faulty.
 - If you are testing a CVU, make sure all DUTs and cables are disconnected from the CVU.
6. Run Self Test again.

If the Self Test fails again:

- If the instrument that failed is a SMU, you can replace it with a field installable SMU. Refer to the 4200A-SCS datasheet for information on the available field-installable SMUs.
- For other instruments or when a field installable SMU is not appropriate, return the 4200A-SCS for repair. Failure of one instrument requires a return of the 4200A-SCS, since it can indicate a systemic failure. Refer to [Returning the 4200A-SCS for repair or calibration](#) (on page 4-6).

Connections for RPM Self Test

The following drawing shows the connections between the 4200A-SCS and the RPM for Self Test.

Make sure the correct RPM is attached. The label on top of the RPM indicates the PMU and RPM. For example, if the RPM has the label 1-2, the RPM was calibrated for PMU 1, RPM channel 2.

Figure 28: RPM connections for Self Test

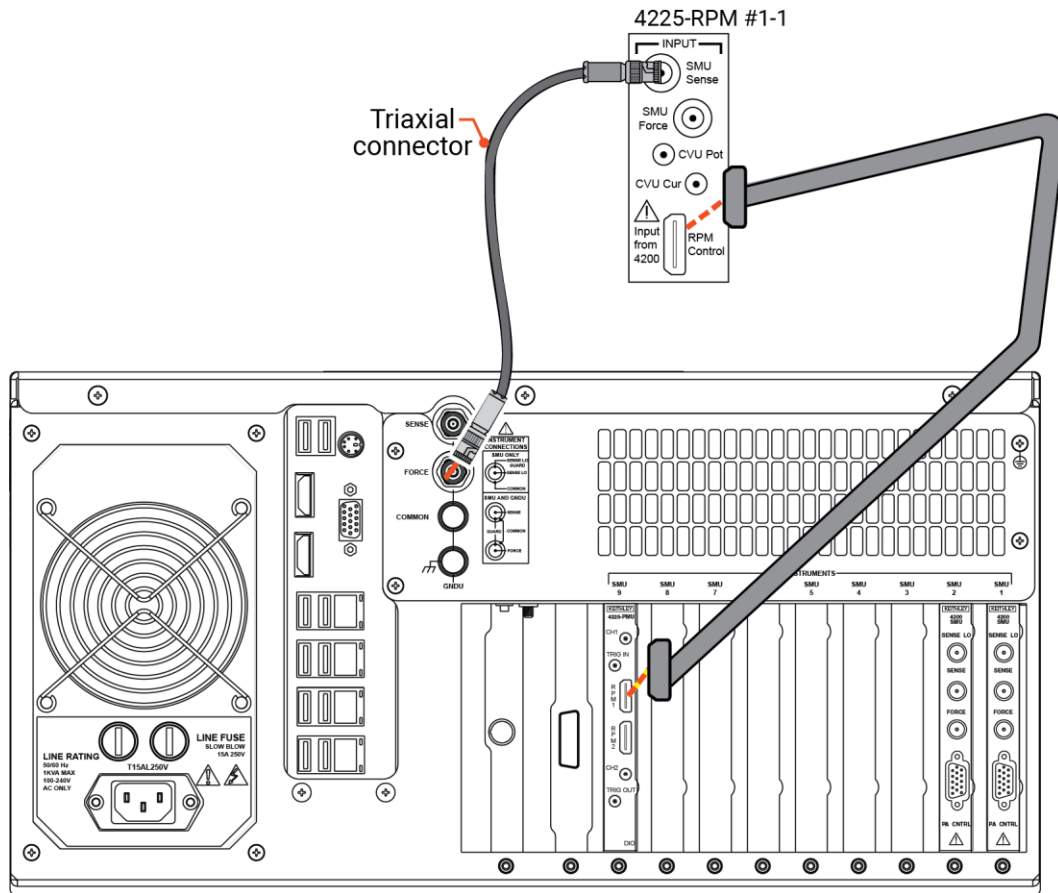

Returning the 4200A-SCS for repair or calibration

When repacking the instrument for shipment, use the original packaging. If the packaging is not available or unfit for use, contact your local Tektronix representative to obtain new packaging.

To return your 4200A-SCS for repair or calibration, call 1-800-438-8165 or complete the form at tek.com/services/repair/rma-request. When you request service, you need the serial number and firmware or software version of the instrument.

To see the service status of your instrument or to create an on-demand price estimate, go to tek.com/service-quote.

When you return the instrument, attach the KCon configuration file or the System Profile to the Return Material Authorization (RMA) request. See the following instructions to generate the KCon configuration file or find the System Profile at `C:\kimfg\SystemProfile_xxxxxxx.html`, where `xxxxxxx` is the serial number of the chassis. If the configuration file or System Profile is not provided with the RMA request, the instrument configuration will be reviewed when the instrument arrives.

If you are returning the instrument for repair, also include:

- A description of the problem and a screenshot, if possible.
- A screenshot or list of the error codes from the KCon message area.
- The `K4200A_systemlog` file from `C:\s4200\sys\log`.
- If you ran Self Test and a module failed, indicate which module failed.
- The Technical Support Files. Refer to [Generate Technical Support Files](#) (on page 3-28).
- The password for the instrument if it was changed from the default.

Contact Keithley for options for shipping the 4200A-SCS.

CAUTION

If you installed software that is not part of the standard application software for the 4200A-SCS, the nonstandard software may be removed when the instrument is sent in for service. Back up the applications and any data related to them before sending the instrument in for service.

CAUTION

Remove any USB blocker or lockdown software. Keithley needs to use the USB ports to run calibration.

To retrieve the configuration file:

1. Start **KCon**.
2. Select **Summary**.
3. Select **Save Configuration As**.
4. Select a location (do not select `C:\`).
5. Select **Save**. The configuration is saved to an `html` file.

For additional information about repacking, shipping, and storing a 4200A-SCS, refer to “Model 4200A-SCS Parameter Analyzer Repacking and Shipping Instructions” (document number 0771827).

Check calibration status

KCon provides the last calibrated date and calibration due date for each instrument in the 4200A-SCS.

To review the calibration information:

1. Close Clarius.
2. Open **KCon**.
3. Select an instrument in the **System Configuration** pane.
4. Review the Calibrated On and Calibration Due Date for the instrument.
5. To review all of the instruments in one page, select **Summary**. Refer to [Summary](#) (on page 3-16) for more information on saving or printing the summary.

NOTE

For calibration frequency, refer to the *4200A-SCS Parameter Analyzer Datasheet*.

Reset the hardware

If you suspect a problem with any 4200A-SCS hardware, use the `resethw` command as described in the following procedure. Do not use Windows Task Manager to close any open applications. Both hardware and software issues may occur if Windows Task Manager is used.

To reset the hardware:

1. Select **Start**.
2. Type `resethw`.
3. Select the instruments that need to be reset.
4. Select **Reset**.

Lithium battery

The 4200A-SCS contains a CR2032 cell (LiMnO₂) battery. Perchlorate material may require special handling. See [Hazardous waste - perchlorate \(dtsc.ca.gov/hazardouswaste/perchlorate\)](https://dtsc.ca.gov/hazardouswaste/perchlorate).

This battery is not replaceable by the user.

Autocalibrate the SMUs

To maintain SMU performance specifications, you must autocalibrate the 4200A-SCS every 24 hours or any time after the ambient temperature has changed more than ± 1 °C.

The autocalibration routine recalibrates the current and voltage offsets for all source and measurement functions of all SMUs in the system.

NOTE

Before initiating a calibration, allow the system to warm up for at least 30 minutes. Clarius prevents autocalibration if the system is not sufficiently warmed up.

To autocalibrate:

1. Allow the system to warm up for at least 30 minutes.
2. Remove connections to all SMUs in the 4200A-SCS.
3. Open Clarius.
4. Select **Tools**.
5. Select **Instrument Tools**.

Figure 29: Clarius Tools dialog

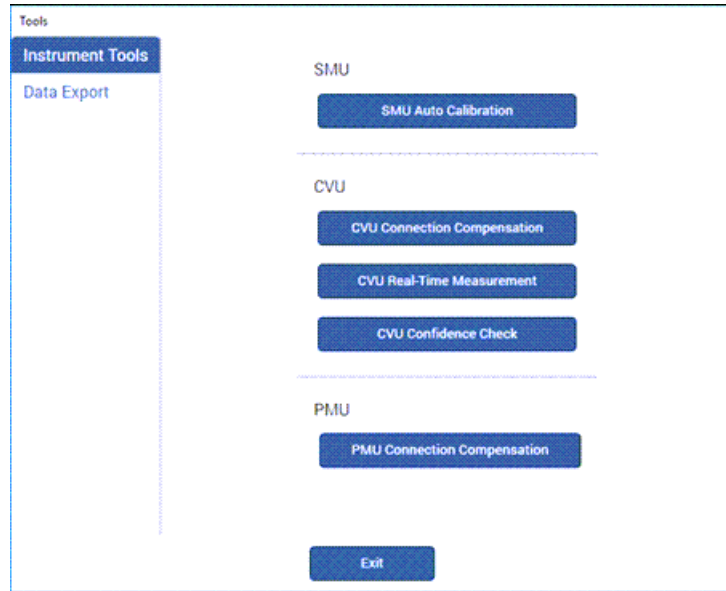

- 6. Select **SMU Auto Calibration**. A warning is displayed.
- 7. Select **OK**. The SMU Auto Calibration dialog opens, as shown in the following figure.

Figure 30: SMU Auto Calibration dialog

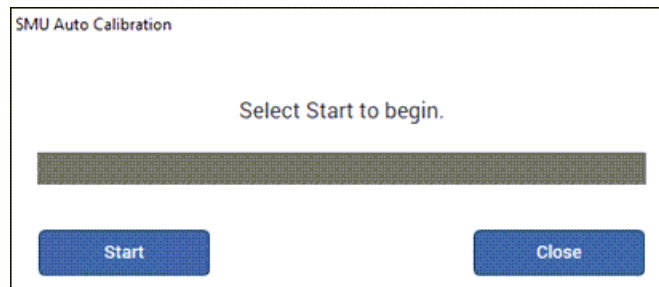

- 8. Select **Start**. A progress bar is displayed. When autocalibration is complete, the message "Auto calibration successfully completed" is displayed.
- 9. Select **Close**. Autocalibration is complete.

System administration

In this section:

System Administration introduction	5-1
Embedded computer policy	5-1
Upgrading the Clarius software	5-2
Default user accounts	5-3
Windows 10 compatibility	5-3
Create new user accounts.....	5-3
System directories and files	5-4
Change the touch mode of Adobe Acrobat Reader.....	5-5
Disable the touchscreen.....	5-5
System-level backup and restore software	5-7
Protect user files and system software.....	5-9

System Administration introduction

This section provides information on system maintenance tasks for the 4200A-SCS computer.

NOTE

Most of the procedures discussed in this section should be done by a knowledgeable Microsoft® Windows® system administrator.

Embedded computer policy

CAUTION

If you install software that is not part of the standard application software for the 4200A-SCS, the nonstandard software may be removed if the instrument is sent in for service. Back up the applications and any data related to them before sending the instrument in for service.

CAUTION

Do not reinstall or upgrade the Microsoft® Windows® operating system (OS) on any 4200A-SCS unless the installation is performed as part of authorized service by Keithley Instruments. Violation of this precaution will void the 4200A-SCS warranty and may render the 4200A-SCS unusable. Any attempt to reinstall or upgrade the operating system (other than a Windows service pack update) will require a return-to-factory repair and will be treated as an out-of-warranty service, including time and material charges.

Although you must not attempt to reinstall or upgrade the operating system, you can restore the hard drive image (complete with the operating system) using the Acronis True Image OEM software tool, described in [System-level backup and restore software](#) (on page 5-7).

You can install Windows quality updates. The version of Windows installed on 4200A-SCS systems only supports installation of quality updates. Feature updates are not supported.

As shipped, the 4200A-SCS automatically runs Windows quality updates when the 4200A-SCS is restarted. They are prevented from occurring during operation.

Upgrading the Clarius software

Keithley Instruments regularly updates the Clarius+ Software Suite. The updates are available at tek.com/support.

To locate the updates:

1. Go to tek.com.
2. Search for **4200A-SCS**.
3. From Filter By Type, select **Software**.
4. Select **4200A-SCS Clarius+ Software Suite**.

Refer to the release notes for instructions on how to install the latest version.

Default user accounts

There are two preconfigured Windows® user accounts on the 4200A-SCS. You can also create a unique user account.

You can use any user account to access all Clarius+ applications and applicable non-Keithley software tools.

The `kiuser` account is the default account. The logon password is `kiuser1`. You do not need a password by default. However, if you log out of the `kiuser` account and log in again, you are prompted for the password.

The `kiadmin` account logon password is `kiadmin1`.

NOTE

You need to use the `kiadmin` account to install software and additional application tools.

CAUTION

For optimum security, change each account password from the default setting to a unique and secure password. Check with your information technology (IT) department for best practices on setting passwords to ensure compliance with the security measures or your organization. You can change the passwords using the Microsoft Windows Settings utility.

Windows 10 compatibility

Clarius+ versions 1.4 and newer require Microsoft Windows 10 for full compatibility.

Create new user accounts

You can create unique Windows® user accounts for each 4200A-SCS user. This enables you to customize the behavior of a 4200A-SCS without affecting its behavior for other users. It also provides additional data protection and privacy, because each user can log onto the 4200A-SCS using a unique logon name and password.

CAUTION

Setting up multiple Windows® user accounts is an advanced system administration procedure that should be performed only by a knowledgeable Windows system administrator.

For optimum security, set an account password for each user account to a unique and secure password. Check with your information technology (IT) department for best practices on setting passwords to ensure compliance with your organization's security measures.

To set up a new user account:

1. Make sure that you are logged into the Microsoft® Windows® administrative account. The default administrative account is `kiadmin`.
2. From the Windows start menu, type `settings` in the search box. The results display the Windows **Settings** utility.
3. Press <Enter> to open the application.
4. Select **Accounts**.
5. Select **Family & other people**, then **Add someone else to this PC**.
6. Select **I don't have this person's sign-in information**.
7. Complete the account information.
8. Select **Next**.
9. Log on using the new account and set up the desktop and other elements of the new profile.
10. Select **Start > All Programs > Keithley Instruments > Initialize New User** to configure Clarius+ for the new user.

NOTE

Initialize New User must be run each time a new user account is created.

System directories and files

All Clarius+ files are stored in the `C:\s4200` folder.

User files and the sample projects and standard libraries that are included with Clarius+ are stored in the directory `C:\s4200\kiuser`. All 4200A-SCS users can access these libraries.

The subdirectories in the user folder include:

- `Projects`: Default Clarius project library.
- `usrlib`: Default collection of KULT user libraries.

The system directory stores all of the binary and executable files that Clarius+ needs to control the 4200A-SCS. Clarius+ system files are stored in `C:\s4200\sys`.

CAUTION

The files stored in the `C:\s4200\sys` and `C:\4200A-SCS` folders must not be modified by 4200A-SCS users or by system administrators. This folder (directory) must reside on the 4200A-SCS hard disk.

Change the touch mode of Adobe Acrobat Reader

You can change the touch mode of Adobe® Acrobat® Reader®. The setting of Touch Mode shifts toolbar buttons, panels, and menus. The Touch reading mode optimizes viewing and supports most common gestures.

To change the Touch Mode of Acrobat Reader:

1. In Acrobat, select **Edit**.
2. Select **Preferences**.
3. Under Categories, select **General**.
4. Under Basic Tools, set **Touch Mode** as needed.
5. Select **OK**.

Disable the touchscreen

You can disable the touchscreen display of the 4200A-SCS.

To disable the touchscreen:

1. Select the <Windows> + X keys on your keyboard.
2. Select **Device Manager**.

Figure 31: Selecting Device Manager

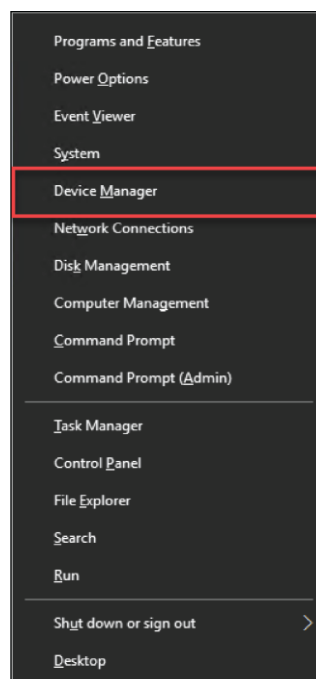

3. Select the arrow next to **Human Interface Devices (HID)** to display a list of available devices.
4. Right-click **HID-compliant touch screen**.
5. Select **Disable**.

Figure 32: Disabling the touchscreen

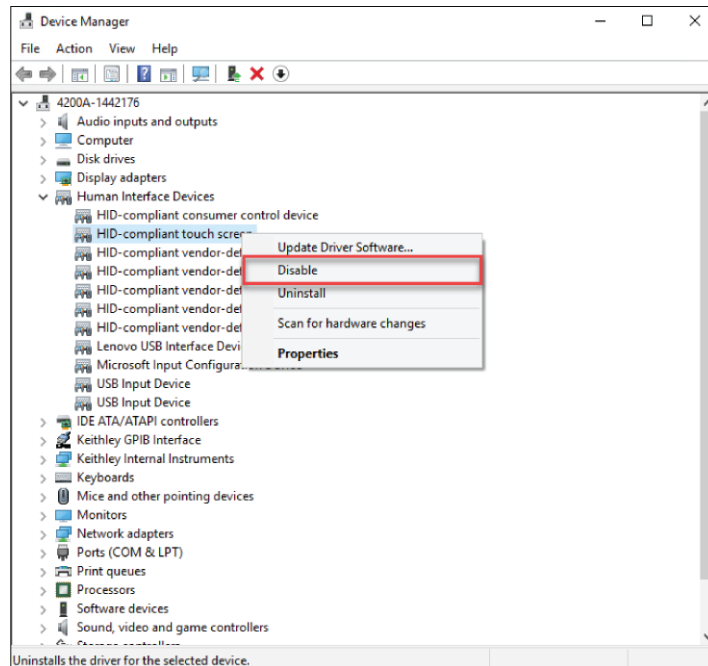

6. Select **Yes** to confirm. The HID-compliant touchscreen option displays an indicator that the device is disabled.

Figure 33: Touchscreen device disabled indicator



To enable the touchscreen:

Right-click the HD compliant touchscreen option, then select **Enable**.

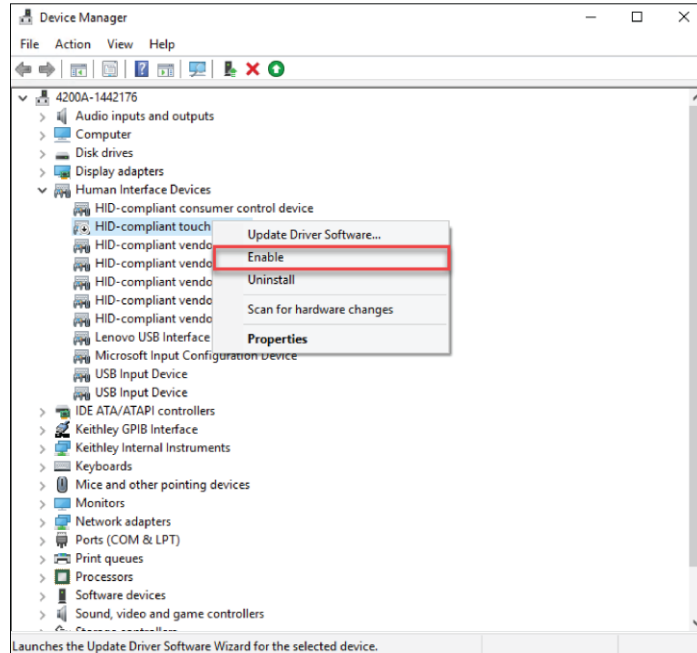
Figure 34: Enabling the touchscreen

System-level backup and restore software

Acronis True Image (OEM) is a software tool that allows 4200A-SCS users to create hard-disk images, including user data, environment settings, and operating system files. This software is preinstalled on every 4200A-SCS system by Keithley Instruments. Keithley recommends backup as the best way to preserve user application files and measurement data.

You can use the Acronis software tool to:

- [Restore the drive image to factory condition](#) (on page 5-8)
- [Choose the files to be backed up](#) (on page 5-8)

For additional information, refer to the *Acronis True Image OEM User's Guide*, available in The Learning Center.

NOTE

Acronis is not provided if the NOACRONIS option was selected when the 4200A-SCS was purchased.

Restore the drive image to factory condition

In addition to allowing you to create your own backups, the 4200A-SCS hard drive image is archived before shipment. This allows you to restore the contents of the 4200A-SCS hard drive to the condition it was in before shipment from Keithley Instruments.

The restore process takes about ten minutes.

CAUTION

Restoring the 4200A-SCS hard drive to factory condition deletes all files written to the hard drive after shipment. Ensure you back up all data and files before you restore the hard drive to factory condition.

To restore the 4200A-SCS hard drive to factory condition:

1. Reboot the 4200A-SCS. As the system boots up, there is a splash screen that contains the Keithley logo.
2. In the upper-left corner, either a prompt or menu with options is displayed depending on your 4200A-SCS version.
 - a. If you see `Press F11 to run Acronis Startup Recovery Manager...`, press the **F11** key to begin the recovery process.
 - b. If you see `Select an item by using the keyboard: followed by multiple options`, press the **1** key to begin the recovery process.

NOTE

You have approximately five seconds to press a key. Otherwise, Windows® will begin to boot.

3. Follow the instructions to restore the factory hard drive image.

For additional detail about the Acronis True Image HD software, please refer to the *Acronis True Image OEM User Guide*, available from The Learning Center.

Choose the files to be backed up

Keithley recommends backing up the following files and directories, where applicable:

- The default user directory
When a 4200A-SCS is received from the factory, the `C:\s4200\kiuser` directory contains all installed test results and user application files. Clarius+ stores all user-created projects and tests in this location.

NOTE

Avoid selective backups of C:\...\data subfolders, such as C:\s4200\kiuser\Projects\default\tests\data. Such backups do not preserve the additional application files that are needed to restore the associated test setups and conditions.

- Special data files and directories
Back up any additional, specialized data files or directories, such as the following:
 - A file into which a User Test Module (UTM) automatically places test results. For example, a UTM could be set to put results into C:\TestData\test001.dat.
 - A file that results from manual processing of data using Microsoft® Excel®.

NOTE

It is possible to back up the whole hard drive. However, the 4200A-SCS system files and application program files occupy a large portion of the storage and may not be properly recoverable unless backed up using special software. Such backups may be justifiable only if the user directory structure is too complex for selective backup and when storage space is plentiful.

You cannot back up files that are normally in use, such as some system files, without special backup software. Before considering use of such software, review the precautions in [Protecting software integrity](#) (on page 5-10).

Protect user files and system software

This section describes recommendations for software and data preservation. The recommendations apply to any 4200A-SCS that meets the following criteria:

- Was produced during or after 2016.
- Runs Windows 10 Enterprise.
- Runs Clarius+ applications version 1.0 or later.

Protect software integrity

The 4200A-SCS has been designed and tested for maximum system stability, reliability, and performance in the factory-standard configuration. To protect the system software, observe the following tips:

- Do not defragment the solid-state drive (SSD) that is preinstalled on the 4200A-SCS. Defragmenting an SSD quickly reduces the life of the drive.
- Refer to the [Embedded computer policy](#) (on page 1-9) for information about upgrading Microsoft® Windows® software and installing third party software.
- Protect the system from viruses, which can reach the system through a facility network or a contaminated USB flash drive. The 4200A-SCS does not contain preinstalled protection against viruses, spyware, or malware. You are responsible for installing software protection packages.
- Do not attempt to format the system hard drive or reinstall the operating system. Attempting to do so will make the system inoperative and require factory repair.

CAUTION

Do not reinstall or upgrade the Microsoft Windows operating system (OS) on any 4200A-SCS. This action should only be done at an authorized Keithley service facility. Violation of this precaution will void the 4200A-SCS warranty. Any attempt to reinstall or upgrade the Microsoft Windows operating system requires a return-to-factory repair and is treated as an out-of-warranty service, including time and material charges.

Read and write permission access to USB ports

For enhanced system security and data integrity, you can use the Microsoft® Management Console (MMC) to enable, disable, or deny all access to removable storage devices used with the USB ports of the 4200A-SCS.

CAUTION

These steps are recommended only for advanced users.

To change access to USB ports:

1. Make sure that you are logged in to the Microsoft® Windows® administrative account. The default administrative account is `kiadmin`.
2. From the Windows start menu, type **gpedit.msc** in the search box. The results display the Windows Group Policy Editor.

3. Press <Enter> to open the application.
4. In the left pane, select **Computer Configuration > Administrative Templates > System > Removable Storage Access**.
5. In the middle pane of the MMC window, double-click a policy setting. In the following figure, the policy settings for all removable storage devices are displayed.
 - a. Select either **Enabled** or **Disabled**.
 - b. Select **Apply**, then **OK**.
 - c. Repeat for any additional policy settings.

Figure 35: Policies for removable storage device access

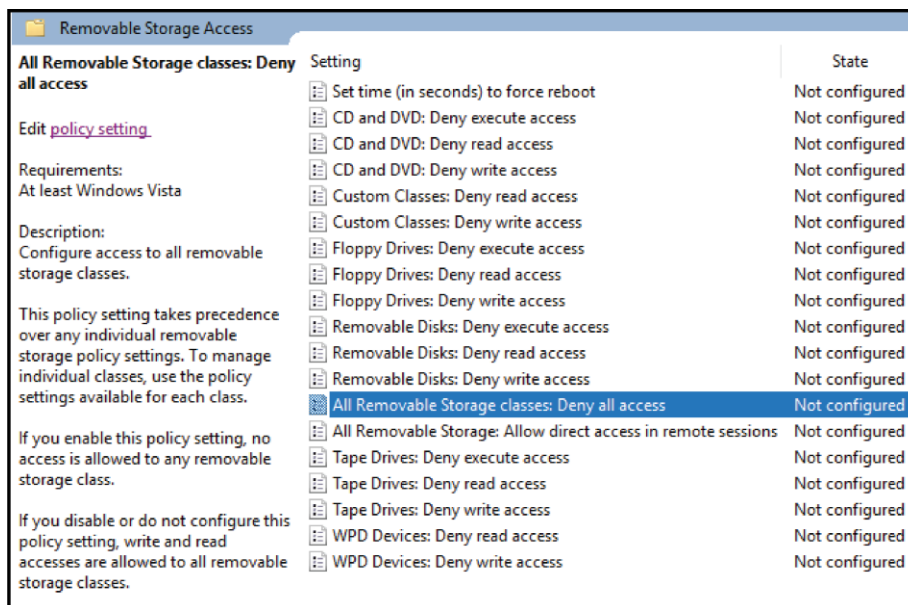

6. Reboot the 4200A-SCS.

Add Clarius+ applications to the Windows startup menu

You can add Clarius+ applications to the Microsoft® Windows® startup menu to have them start automatically when you log into Windows.

NOTE

Add either Clarius or KXCI to the startup menu. If you add both, it will cause conflicts when you start your 4200A-SCS.

To set up an application to start automatically:

1. Make sure that you are logged in to the Microsoft® Windows® administrative account. The default administrative account is `kiadmin`.
2. From the Windows start menu, type `gpedit.msc` in the search box. The results display the Windows Group Policy Editor.
3. Press <Enter> to open the application.
4. In the left pane, under **User Configuration > Windows Settings**, select **Scripts**.

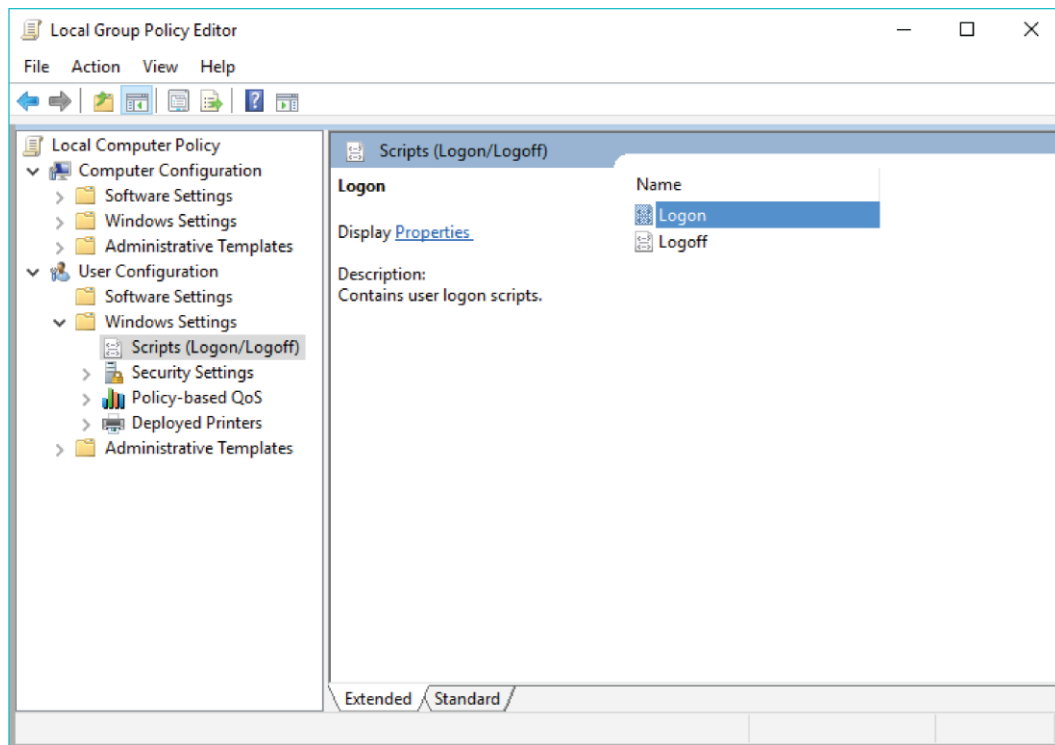
Figure 36: Windows Group Policy Editor

5. Select **Logon**.
6. Select **Add**.
7. Enter one of the following application file paths in the **Script Name** field:
 - For Clarius+: `C:\S4200\sys\bin\Clarius.exe`
 - For KXCI: `C:\S4200\sys\bin\KXCI.exe`
8. Select **OK**.
9. Select **Apply**.
10. Close the Group Policy Editor.

In this section:

[Additional information.....](#) 6-1

Additional information

This manual has prepared you to start using your new 4200A-SCS for your applications. For more detailed information, refer to the Learning Center, which you can access by selecting this icon on your desktop:

Figure 37: 4200A-SCS Learning Center icon



The Learning Center contains content to help you learn how to use your 4200A-SCS, including:

- Manuals for the instruments and software in the system
- Videos
- Application notes
- Release notes
- Test and device descriptions
- The Keithley Instruments *Low-Level Measurements Handbook*

Also see tek.com/keithley for support and additional information about the instrument, including:

- Updated drivers
- Keithley forums
- Information about related products

Your local Field Applications Engineer can help you with product selection, configuration, and usage. Check the website for contact information.

Specifications are subject to change without notice.
All Keithley trademarks and trade names are the property of Keithley Instruments.
All other trademarks and trade names are the property of their respective companies.

Keithley Instruments • 28775 Aurora Road • Cleveland, Ohio 44139 • 1-800-833-9200 • tek.com/keithley

