

5

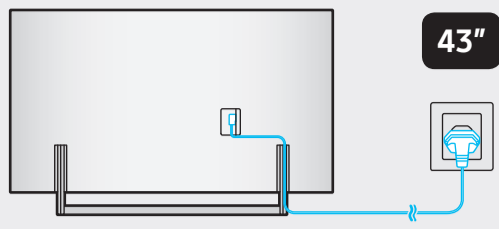

43"

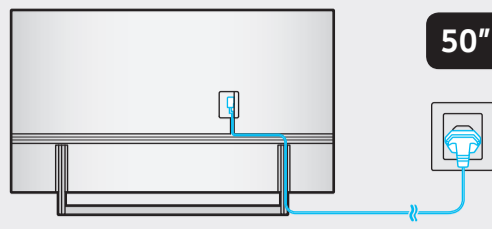

50"

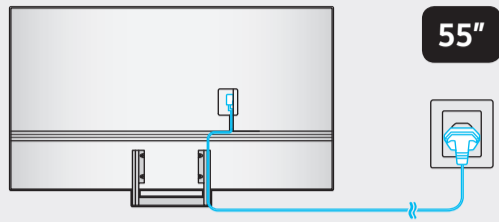

55"

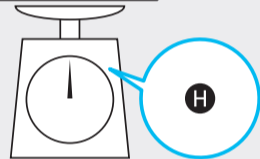
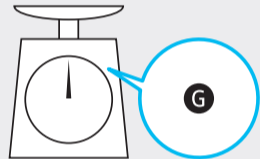
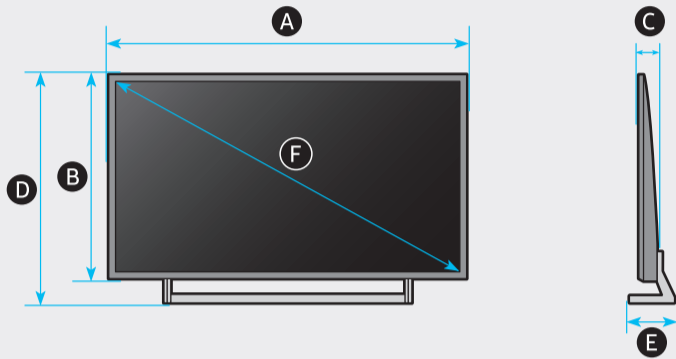

|          | A                        | B                      | C                    | D                      | E                      | F      | G       | H       |
|----------|--------------------------|------------------------|----------------------|------------------------|------------------------|--------|---------|---------|
| 43Q6*A   | 965.5 mm<br>(96.55 cm)   | 559.8 mm<br>(55.98 cm) | 25.7 mm<br>(2.57 cm) | 623.6 mm<br>(62.36 cm) | 187.6 mm<br>(18.76 cm) | 108 cm | 8.4 kg  | 9.0 kg  |
| 50Q6*A   | 1118.3 mm<br>(111.83 cm) | 644.5 mm<br>(64.45 cm) | 25.7 mm<br>(2.57 cm) | 709.4 mm<br>(70.94 cm) | 199.1 mm<br>(19.91 cm) | 125 cm | 11.5 kg | 12.2 kg |
| 43AU9*** | 966.3 mm<br>(96.63 cm)   | 560.2 mm<br>(56.02 cm) | 25.7 mm<br>(2.57 cm) | 624.0 mm<br>(62.40 cm) | 187.6 mm<br>(18.76 cm) | 108 cm | 8.4 kg  | 9.0 kg  |
| 50AU9*** | 1119.1 mm<br>(111.91 cm) | 644.9 mm<br>(64.49 cm) | 25.7 mm<br>(2.57 cm) | 709.8 mm<br>(70.98 cm) | 199.1 mm<br>(19.91 cm) | 125 cm | 11.5 kg | 12.1 kg |
| 55AU9*** | 1232.9 mm<br>(123.29 cm) | 709.2 mm<br>(70.92 cm) | 25.7 mm<br>(2.57 cm) | 774.1 mm<br>(77.41 cm) | 249.1 mm<br>(24.91 cm) | 138 cm | 15.5 kg | 16.2 kg |

\*: 0-9, A-Z

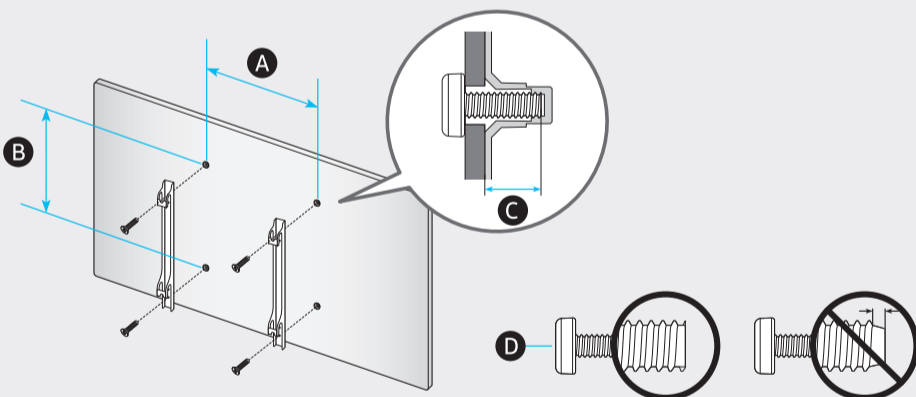

|          | VESA A x B (mm) | C (mm) | D x 4 |
|----------|-----------------|--------|-------|
| 43Q6*A   | 200 x 200       | 11-13  | M8    |
| 50Q6*A   |                 |        |       |
| 43AU9*** |                 |        |       |
| 50AU9*** |                 |        |       |
| 55AU9*** |                 |        |       |

\*: 0-9, A-Z

SAMSUNG

# QUICK SETUP GUIDE



43"  
-  
50"

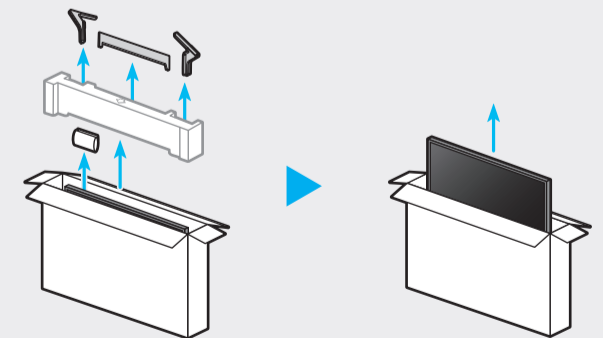

55"

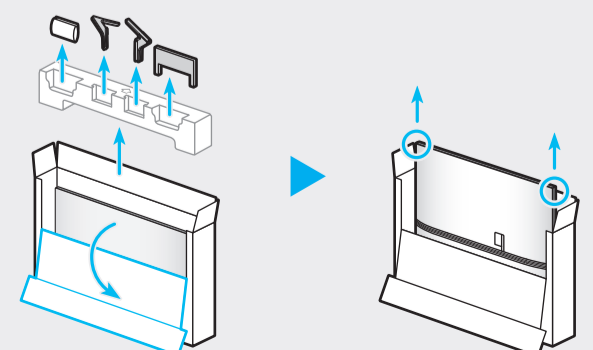



|  |  |             |
|--|--|-------------|
|  |  | USB +G      |
|  |  | OPTICAL     |
|  |  | HDMI (eARC) |
|  |  | HDMI        |
|  |  | LAN         |
|  |  | ANT         |

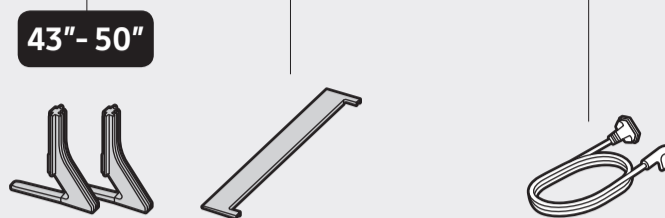
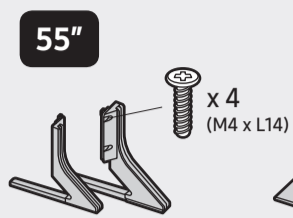

1

**43-50"**

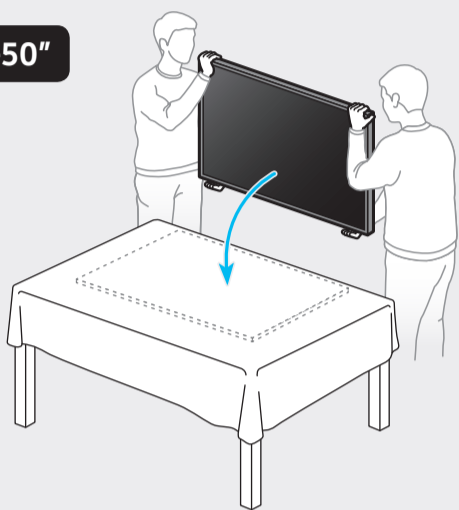

**55"**

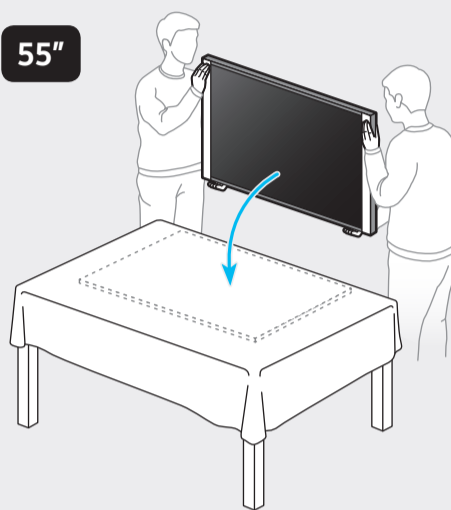

**43" - 50"**

2

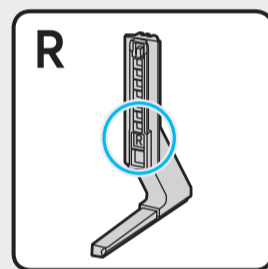
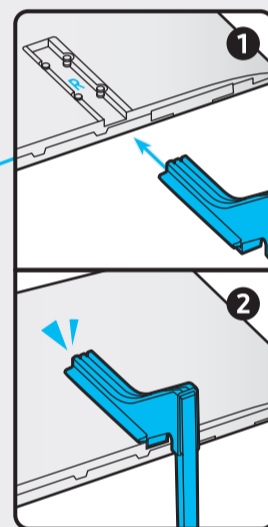
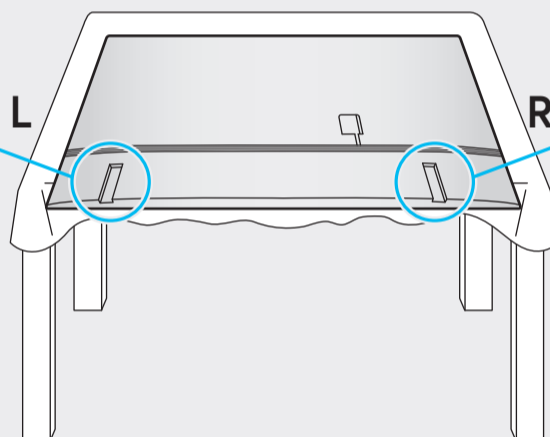
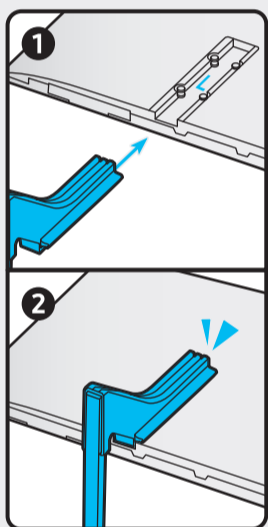
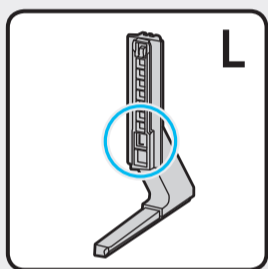

**55"**

2

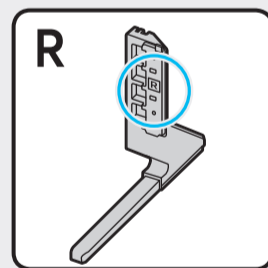
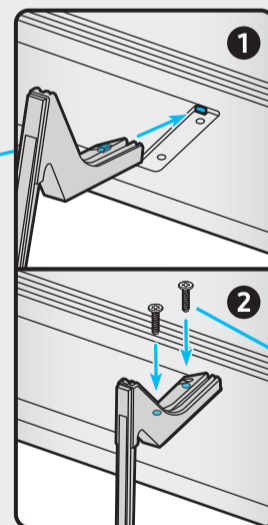
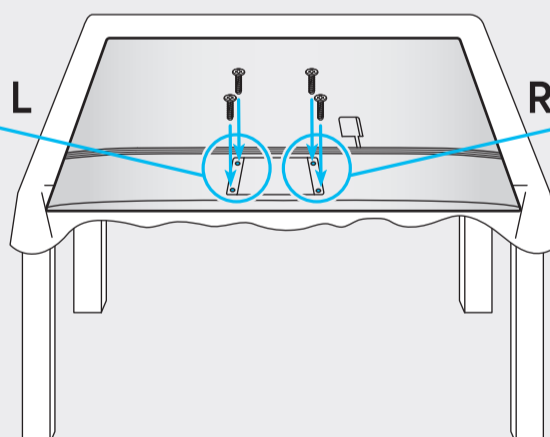
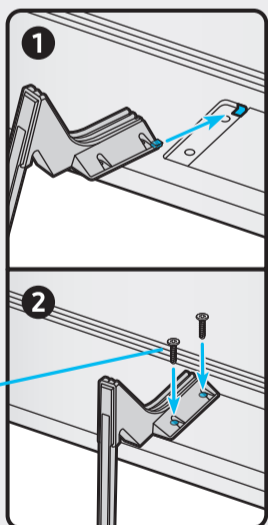
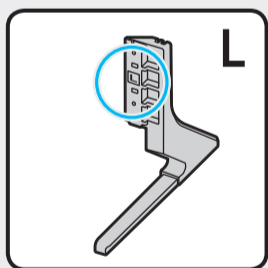

x 2 (M4 x L14)

x 2 (M4 x L14)

3

**43-50"**

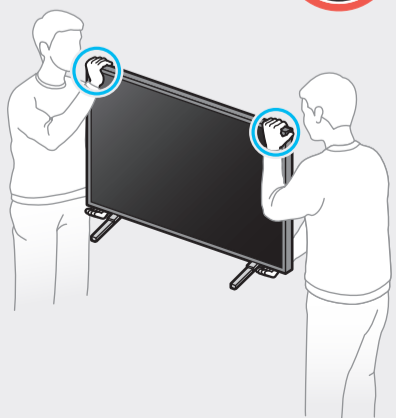

**55"**

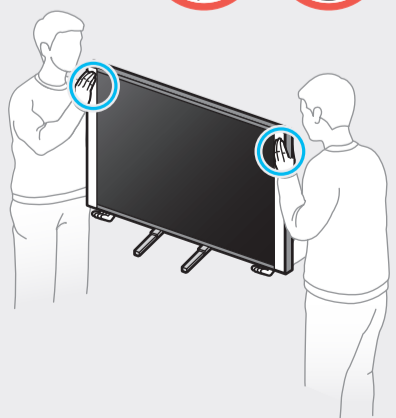

4

**43"-50"**

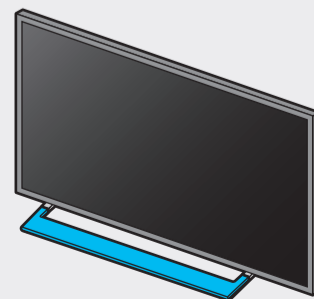
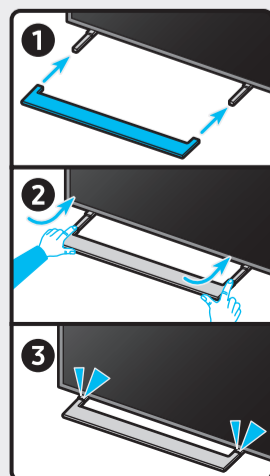

**55"**

