

Android Car Stereo Instruction

For Ford Transit (2014-2019)

(Picture for reference only)

Content

Content.....	1
[Customer].....	2
[Instructions for use].....	2
1. Tips and warnings.....	2
2. Safety Tips.....	3
3. Machine Reset.....	3
[Installation].....	4
[Wiring].....	4
1. Product Dimension.....	4
2. Back interface diagram.....	5
3. Harness.....	7
4. Installation Steps.....	11
5. Schematic diagram of reversing camera wiring.....	12
6. Fixed machine.....	14
7. Suitable models.....	14
8. Parameter.....	15
[Introduction to basic functions].....	16
[Trouble Shooting].....	30
[Carplay and Android Auto Connection].....	31
1. Wired Carplay Connection.....	32
2. Wireless Carplay Connection.....	35
3. If Wireless Carplay Connection Fail.....	38
4. Wired Android Auto Connection.....	43
5. Wireless Android Auto Connection.....	46
6. Video Link (just for reference).....	46

Customer Service Contact:

yanningqiu2021@163.com

[Customer]

Dear Customer:

Thanks for buy our car player, it is our honor and pleasure to server you to using our product. Before using this product, please read this manual very carefully and keep it properly. Your kindly feedback and support will prompt us to do the better. Thank you.

[Instructions for use]

For the sake of your safety, please don't watch the video while driving and operating a machine; Please dispatch the volume to clearly while driving to the voice to the outside world. Before operation, please read this manual and other manual system, understand the use of manual and machine related safety tips and warning signs, after reading in a readily accessible place for ready reference.

1. Pay attention to traffic safety in the first place.
2. If you meet difficulty in operating the system, please again after he parked his car in a safe place.
3. Don't let children operate this machine, lest cause personal injury and damage to the machine.
4. Please follow the traffic rules when using satellite navigation function to drive.
5. Please do not ban the use of electronic equipment or it is forbidden to use open flame such as gas stations, brewery, strong electromagnetic interference region, otherwise may cause danger.
6. Don't maintenance, installation of the machine itself. Under the condition of the plug do not install or repair the machine, by not trained in electronic equipment or vehicles accessories installation personnel or the lack of experience installation and maintenance of this machine is very dangerous.
7. Do not install the machine storage or in direct sunlight place, don't put it in other harmful material environment, especially the LCD screen, if the installation of the LCD screen is in the air conditioner near the air duct, please keep cool and hot air blows directly to the machine, otherwise it may damage the machine, even on the bus or personal injury.
8. Please do not use some sharp objects painted screen, don't use hard objects to press the screen, otherwise will cause damage to display or touch screen.
9. In order to guarantee the normal operation of the machine, and prevent the occurrence of fire or get an electric shock, please don't expose machine in damp air, more can't liquid drying machine.

1. Tips and warnings

In order to emphasize the important information in the user manual, please pay special attention to the label when you see. It indicates some important warning and prompt information.

2. Safety Tips

Please read all instructions before installation, and it is recommended that car audio professionals install the machine.

⚠ This machine is suitable for vehicle-mounted 12V power supply system (there must be a grounding wire), please do not install this machine in a 24V vehicle-mounted, otherwise it will damage the machine.

Do not repair the power fuse without professional guidance. Improper use of the fuse will cause damage to the machine and cause a fire.

⚠ Do not repair the power fuse without professional guidance. Improper use of the fuse will cause damage to the machine and cause a fire.

⊘ In order to avoid violating traffic rules, drivers cannot watch videos while driving and operating machines to avoid unnecessary accidents.

⊘ For safety and to ensure the normal use of the product, please invite professionals to install, disassemble or repair the machine to avoid damage to the machine and accidents. For more information, please contact your local professional car audio store.

⊘ Please avoid putting this product in humid environment and water to avoid fire caused by electric shock or other unnecessary damage.

Note: To prevent short circuit, please remember to turn off the car and disconnect the ACC connected to B+ before installation.

3. Machine Reset

1. The first use of the system before or after the replacement battery, the machine must be reset.
2. When the machine function is not normal, the machine must be reset.
3. Click restore factory settings in system settings interface, make the machine is in the initial state.
4. Use a pointed object, press the RESET button on the panel, or click the system RESET in the system settings, the machine will be RESET to turn it off, back to the factory the initial state.

Note: press the RESET button and the system initialization will lose time and set the value before.

[Installation]

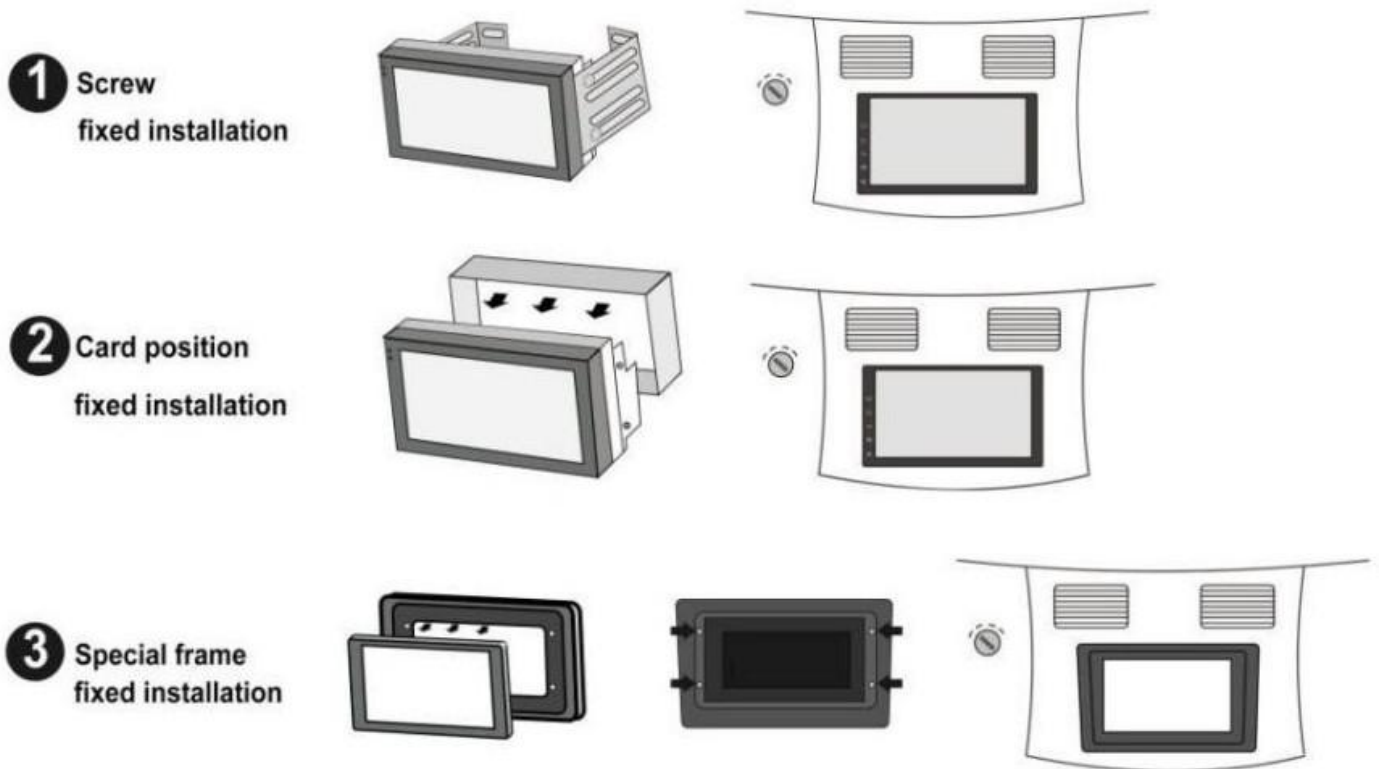

As shown in the figure above, there are three ways to install the machine, please choose one of them according to the actual situation. Of course, you can also re-install the new radio according to the installation method of the original car radio.

[Wiring]

1. Product Dimension



143mm/5.6inch



185mm/7.3inch



91mm/3.6inch

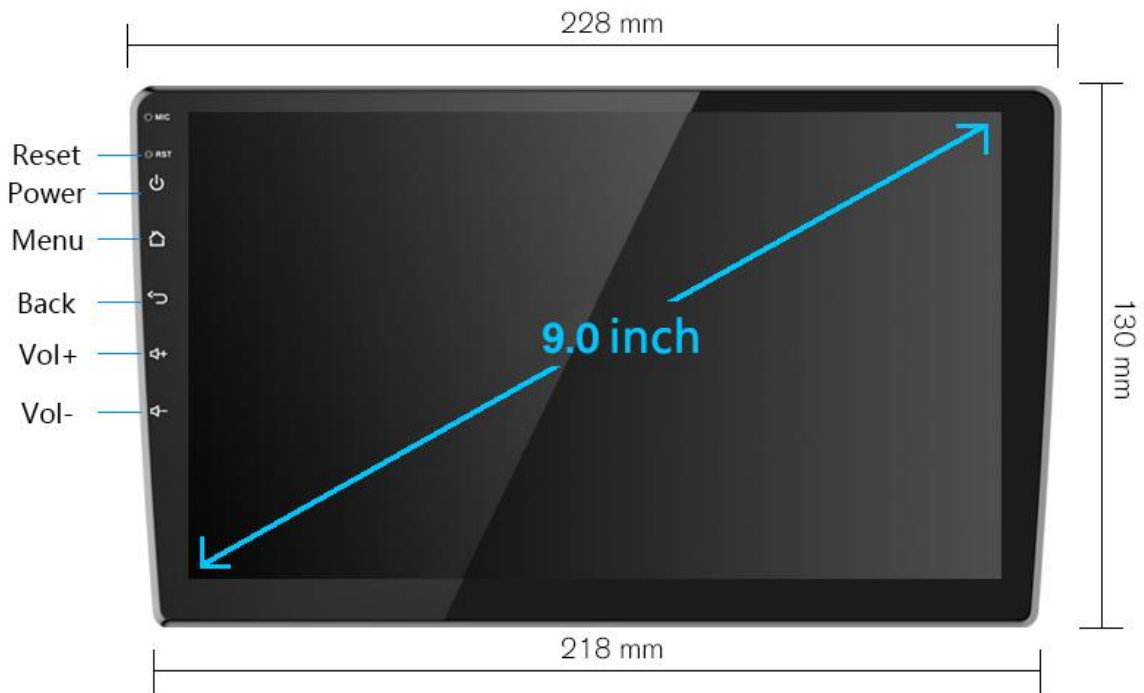

2. Back interface diagram

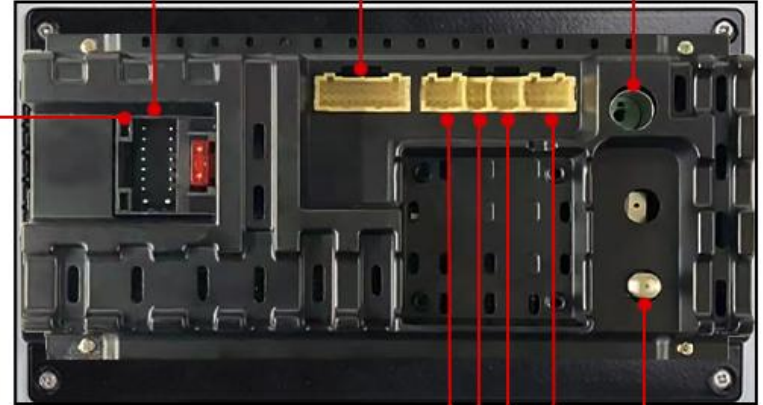
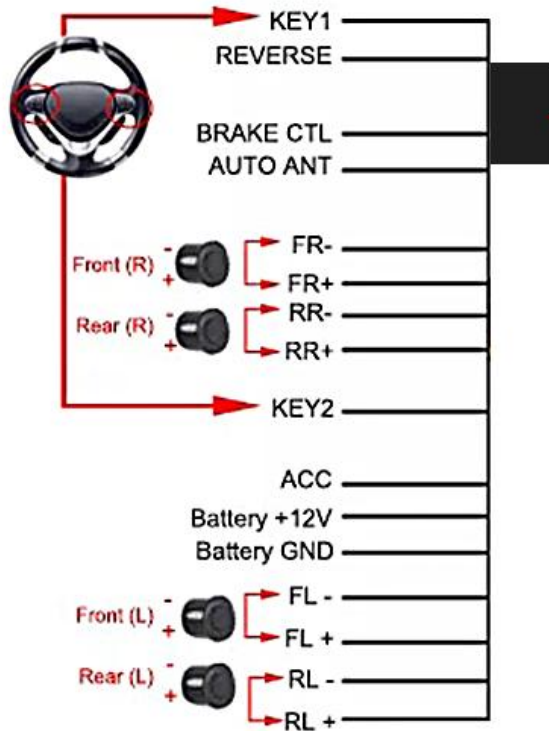
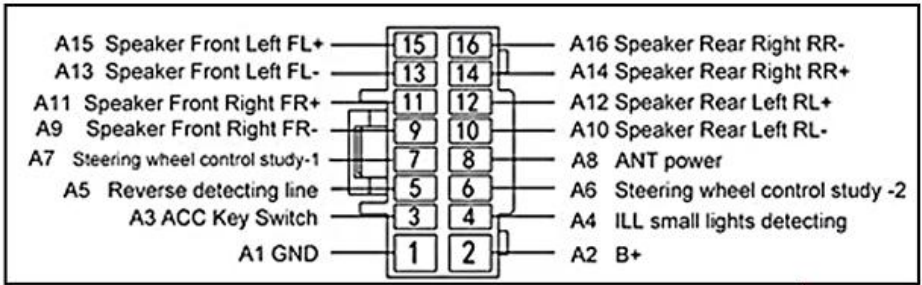

If your car need **canbus**, please need use cable connect this port



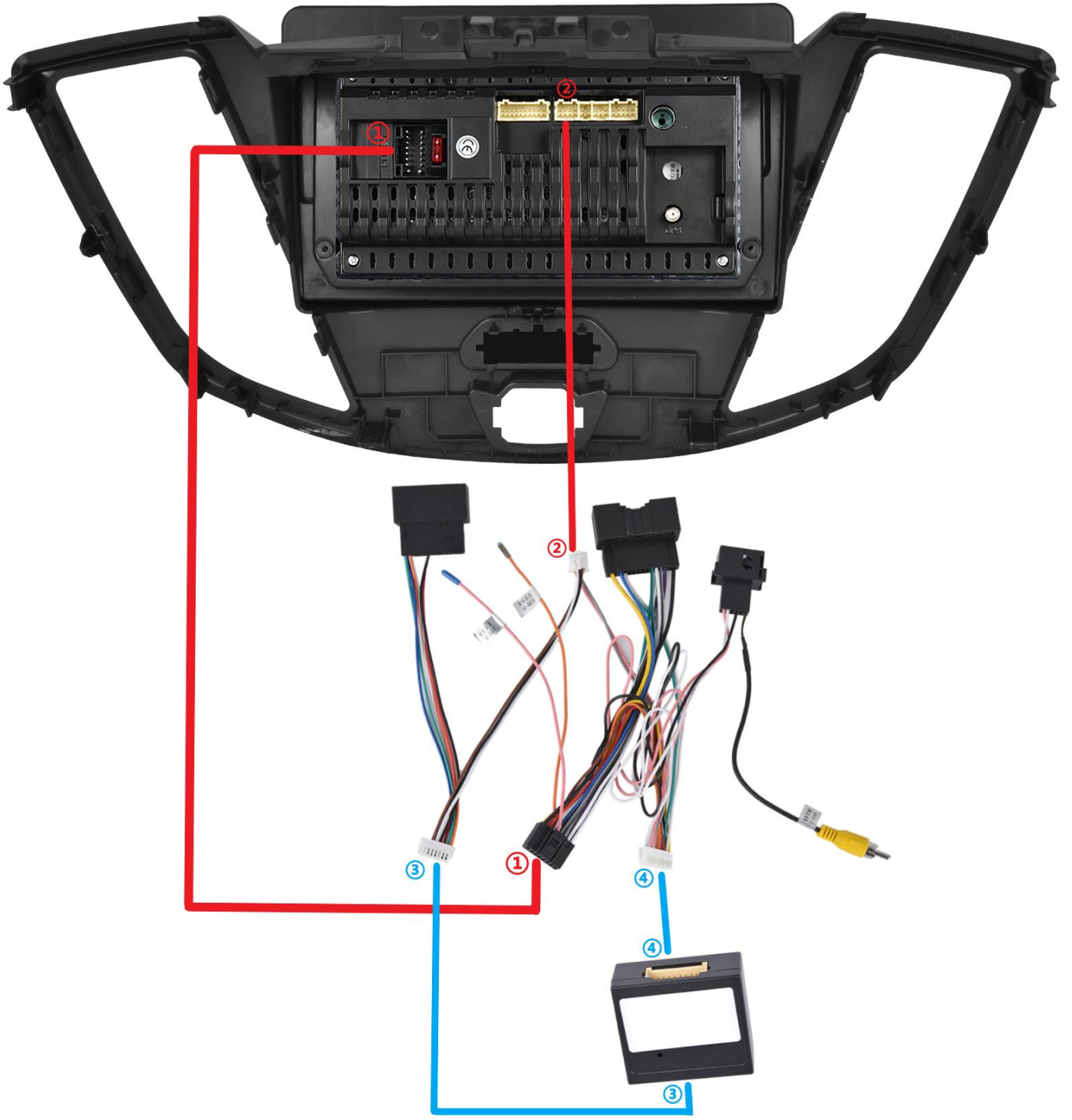

3. Harness

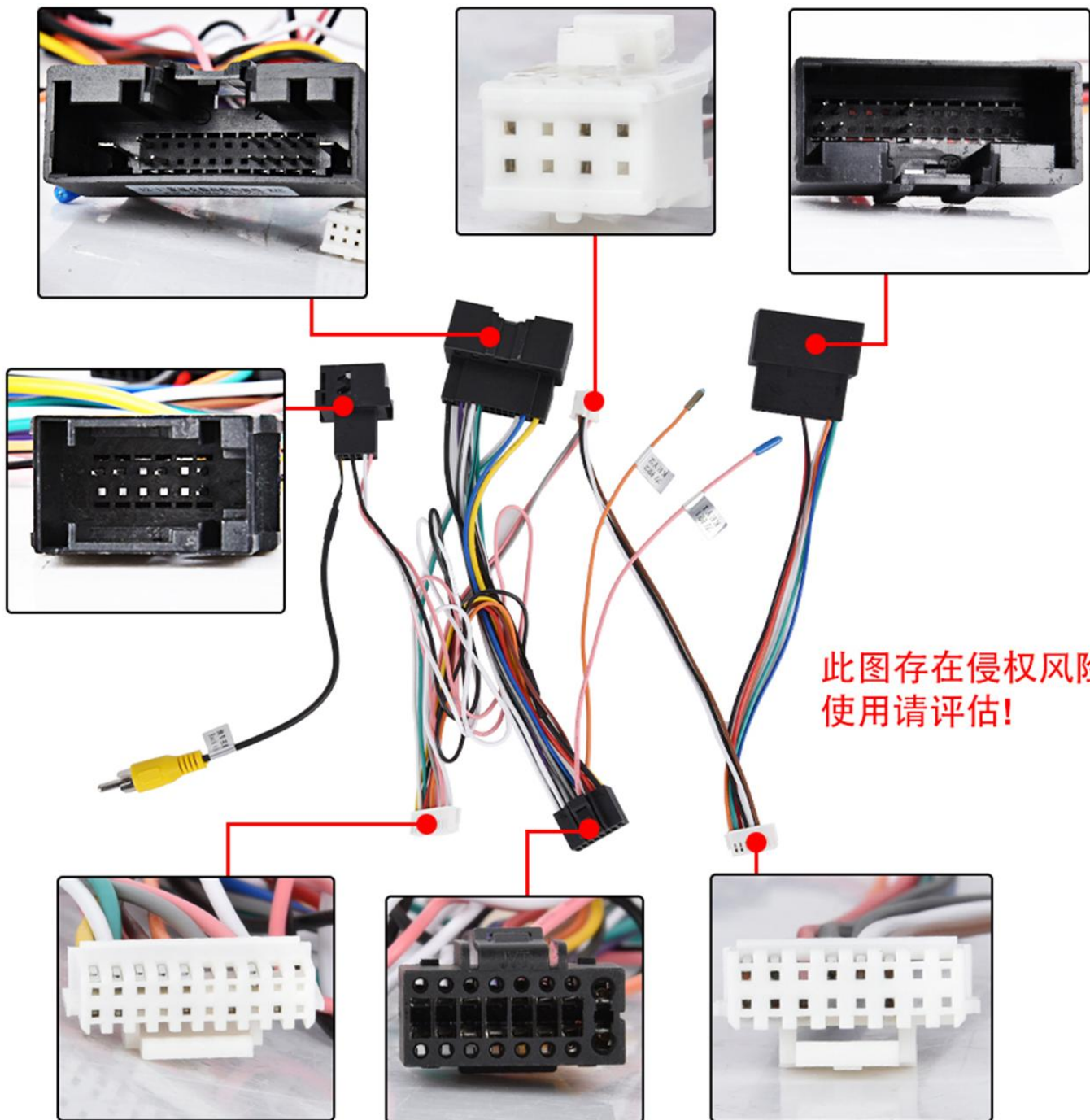

此图存在侵权风险，
使用请评估！

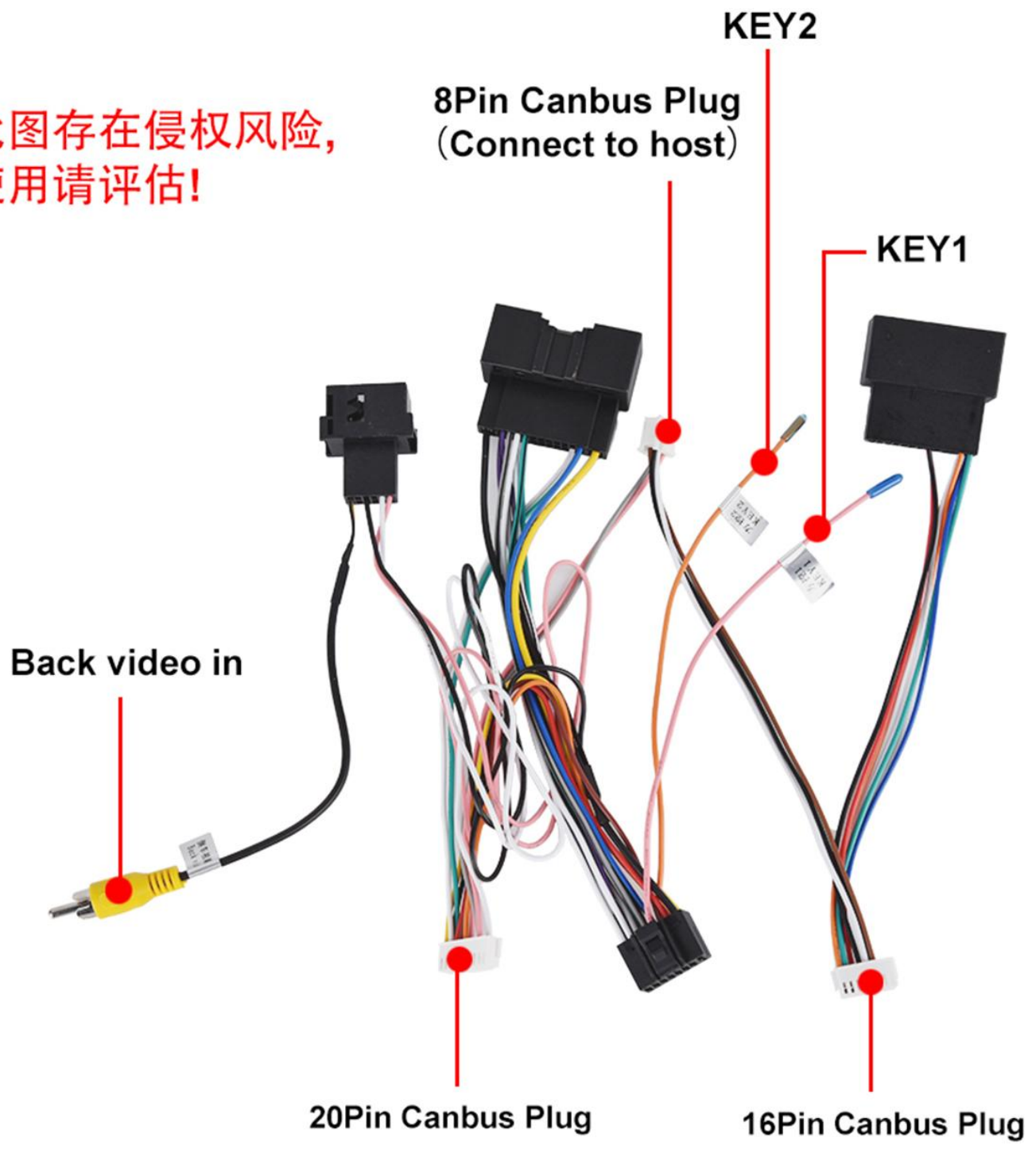



Rear Camera

**Rear View Camera
Signal Input**

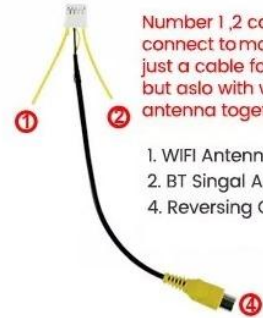

Number 1,2 cable must be connect to model, It's not just a cable for camera but also with wifi antenna together.

- 1. WIFI Antenna
- 2. BT Singal Amplifier
- 4. Reversing Camera

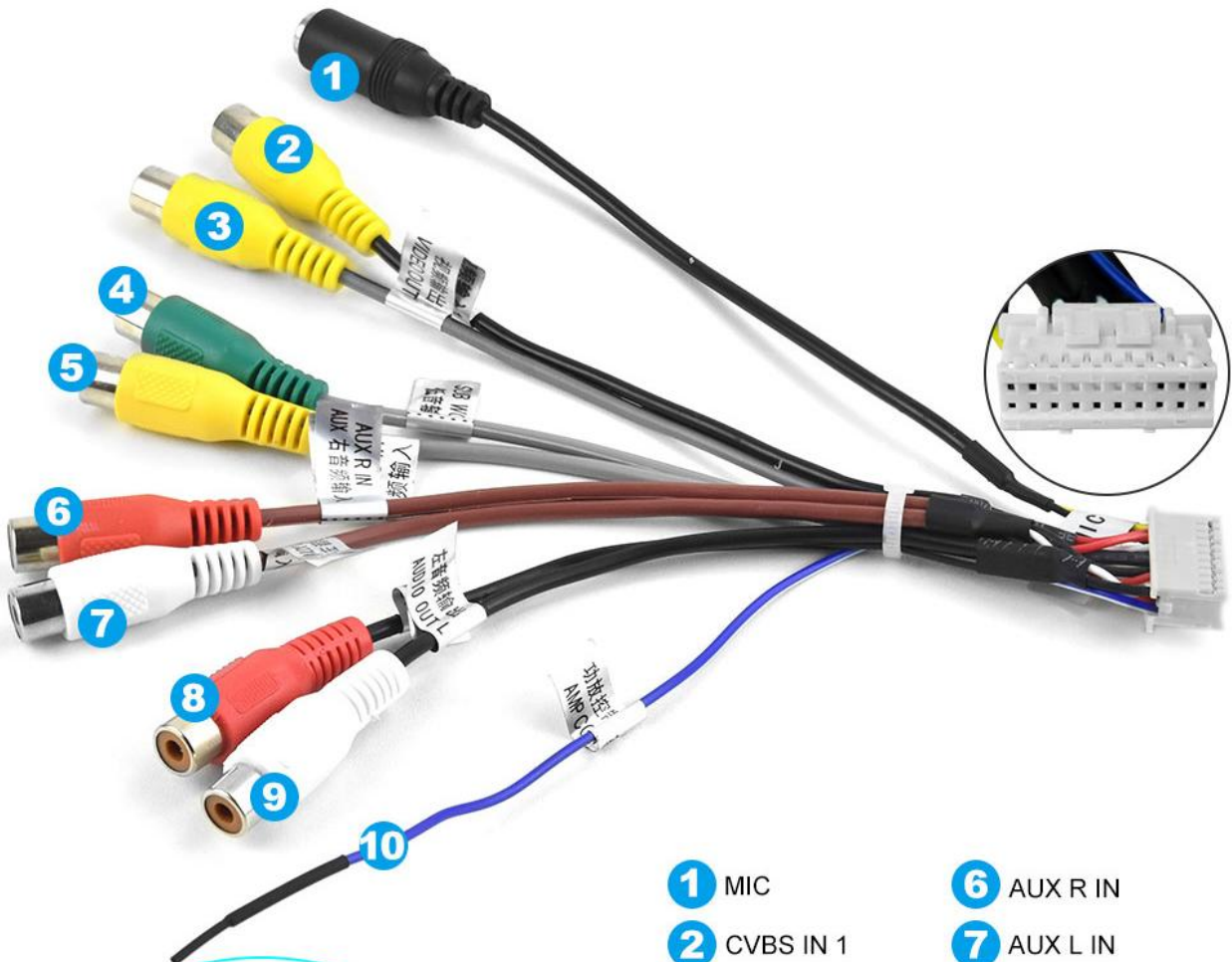

+



- | | |
|---------------------|----------------------|
| 1 MIC | 6 AUX R IN |
| 2 CVBS IN 1 | 7 AUX L IN |
| 3 VIDEO OUT | 8 AUDIO OUT R |
| 4 SUB WOOFER | 9 AUDIO OUT L |
| 5 VIDEO IN | 10 AMP CONT |

4. Installation Steps



Picture 1



Picture 2



Picture 3

1>How to find the power cord of the car?

First turn the car key to the ACC state. Then regulate the Universal Watch to the 20V gear. Connect the black stylus to the power ground (the outer ironclad of the cigar lighter) and use the red stylus to test each wire of the car. Normally a car has two wires about 12V(some cars only have one). That is the positive pole line. How to distinguish the ACC and memory line? Pull out the car key after you find the two positive pole lines. The memory line is the electrically charged one after you nu plug the key. *(Look the Picture 1)

2>How to find the ground wire of the car (negative pole)?

Turn the Universal Watch to the on/off beep gear. Then connect the black stylus to the power ground (the outer ironclad of the cigar lighter) and use the red stylus to test each wire except the two power lines. The energized one is the ground wire(negative pole). Some cars have two ground wires. *(Look the Picture 2)

3>How to find the horn line of the car?

Turn the Universal Watch to the on/off beep gear. Connect the black stylus to any wire except the power cord and ground wire. Then use the red stylus to test each remaining wire. The energized one is the horn wire. Then use the same method to find out the other horn lines. *(Look the Picture 3)

4>How to test whether the unit work properly?

When you get the unit, you'd better test the unit with battery or power supply before installation. Wire connection method: Twist the red wire and yellow wire together and then connect them to the positive pole. Connect the black wire to the negative pole. Then press the switch to turn on the unit and get a horn to connect to the horn wire. (Two wires connected to the horn are of the same color. The white wire is supposed to be connected to the positive pole and the white one with black part connected to the negative pole of the horn. You can make no distinction between the positive and negative poles of the horn.) Then test the function of the unit.

5>How to connect Bluetooth?

Turn on the unit and initiate Bluetooth function of phone, and then search for the user name of the unit. Click the connect button and the phone will show it is connected. If you want to play music with

Bluetooth, press the function transition button to switch to Bluetooth mode and then click songs on your phone. You can also dial numbers on your phone to make a phone call with Bluetooth.

6>How to fix the unit ?

Since each car has a different way of fixing the unit and the location of the screws are different, there is no defined way to fix the unit. You may consult the fixing method of the original unit. If it was fixed by tightening screws with the steel angle, you can unload the steel angle of the original unit to both sides of our unit, then use the electrician tape to tight the steel angle (since screw hole size is probably unmatched). If the original unit was fixed with iron frame, you can fix the iron frame of our unit in the car first, and then push the unit to fasten it. If the size is not fit, you can wrap the unit with electrician tape to increase the volume of the unit, and then put it in and fasten it. Or you can think of a better way to fix it, but anyway, you can fix it.

7>How to install the navigation antenna?

First you should tighten the screws of the navigation antenna and the unit. Then you must fix the navigation antenna module in a place that has sunlight or on the windshield. **(That's very important because poor installation will affect navigation signals.)**

8>The default factory mode password

Factory mode password: 8888. **(Different products, the password may be different)**

9>The default Bluetooth Pin Code

Bluetooth Pin Code : 0000/1234

5. Schematic diagram of reversing camera wiring

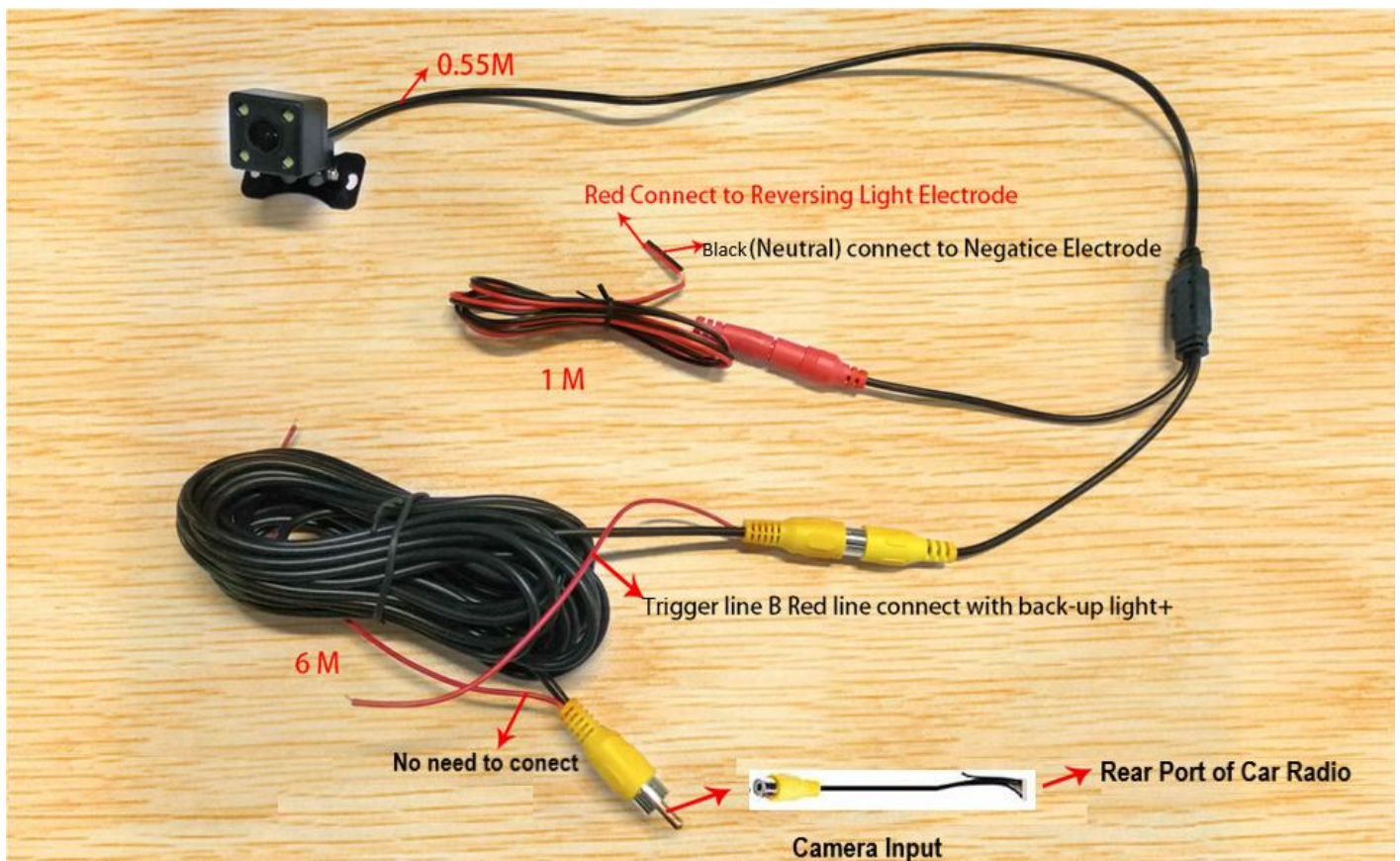

There is a separately Camera Input, please do not connect to RCA cable.

Here's the complete steps of camera wiring.

- 1. Camera power cable: red and black.
--- Red connection to reverse the positive light, black to reverse the negative light.
 - 2. Camera RCA cable: yellow port.
---- Insert it on the radio rear input cable. It's a single cable with yellow port with label "REVERSE/BACK/REAR CAMERA")
 - 3. Trigger Cable
 - 3.1 near the radio: the red wire A -- NO Need to connect
 - 3.2 near the camera: the red wire B -- connects to car's rear light positive.
- When you pull the rear gear, the device will automatically display the rear view image.

- 1. Monitor (Not Induded in the Package)
- 2. Camera Power Source
- 3. Camera (Optional)

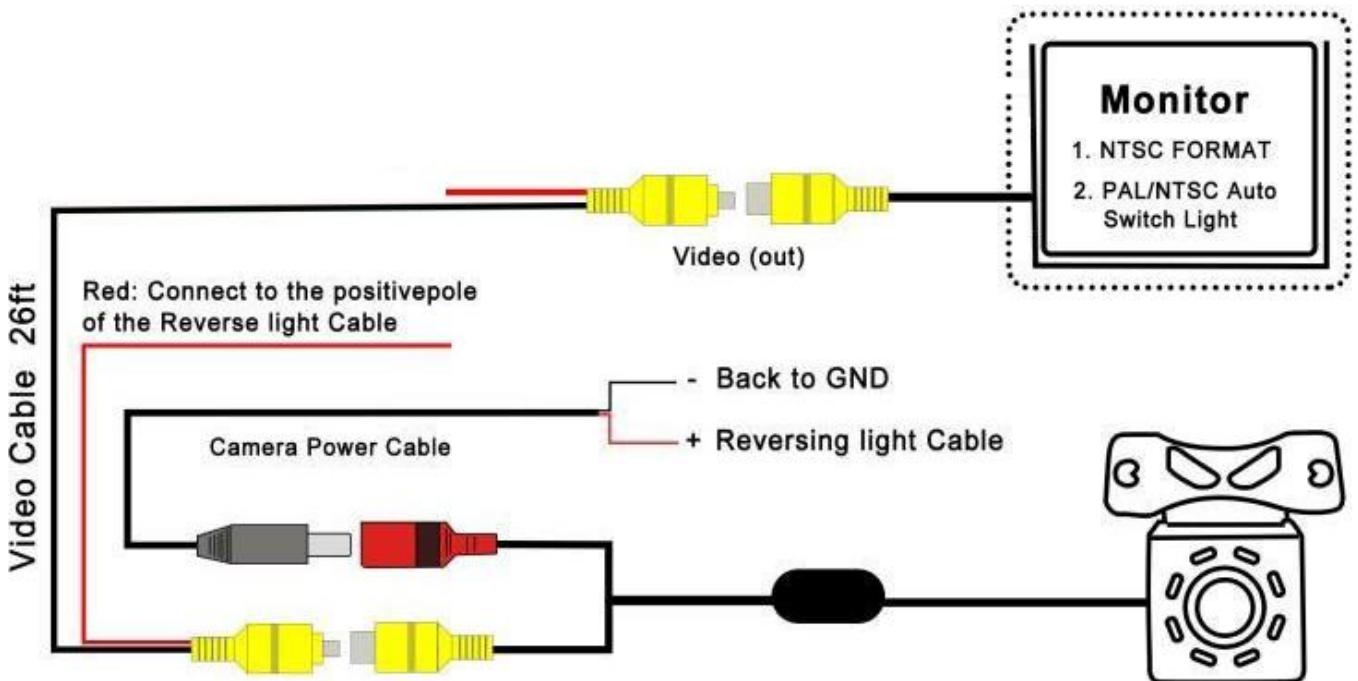
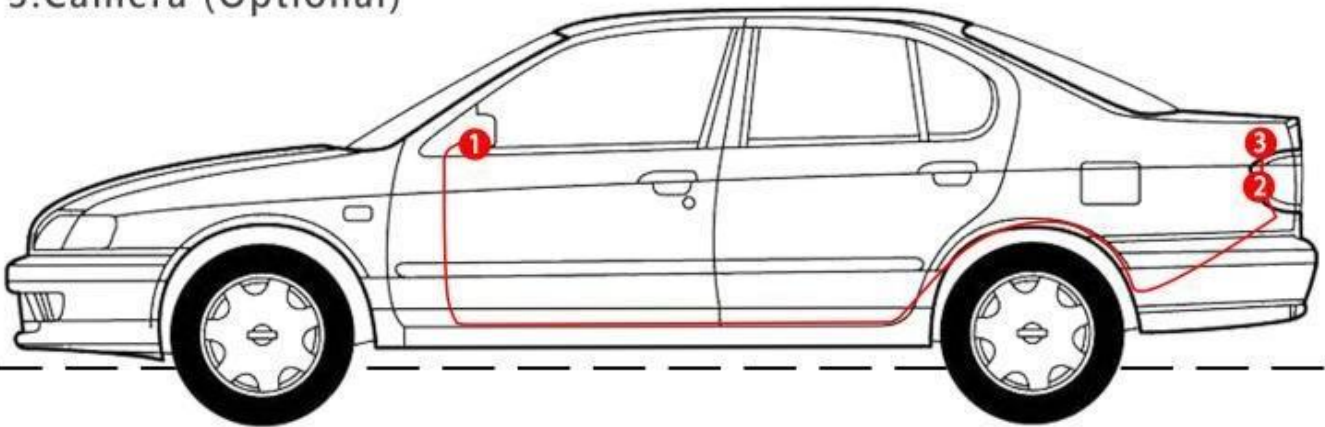

Wiring method:

Preparation tools: tape, screwdriver, wire cutters, plastic prying tool, traction wire .

Step 1: Insert the original accessory camera wire harness into the rear license plate light hole, and then directly snap it in.

Step 2: Step 2: Remove the trunk lining, pull out the waterproof rubber ring, use the tow line to pull the camera cable out of the suitcase, insert the camera wire harness and data connector into the hole of the baffle, and finally rein stall the waterproof rubber ring.

Step 3: Remove the decorative lining board on the left side of the trunk, plug the data power integrated extension cable with the camera harness, and lead out from the rear trim panel along the original car harness.

Step 4: Peel off the sealing strip on the left side door of the rear seat, route the cable into the rear cockpit, and pull out the data power integrated plug and the remaining extension cords.

Step 5: Recover the trunk, and insert the extension cord into the gap of the plastic panel along the rubber strip on the door side, all the way to the cockpit door.

Step 6: Remove the storage box under the headlights, pass through the top of the OBD interface, and then connect the wiring interface to the navigator interface.

NOTE: Whether you are using a rear view camera or not, please connect the rear view wire. Otherwise, your WiFi and Bluetooth signals will suffer !

6. Fixed machine

1. Fix the bracket on the left and right sides of the machine with screws, and adjust the position of the bracket according to the actual installation.

2. Screw the machine in the mounting position of the central console of the car.

7. Suitable models

This car radio is specially used for Ford Transit (w/o Nav) 2014-2019, the size is: 440 (Top Width)*220 (Height)*340 (Bottom Width)mm, please refer to the compatibility table for suitable models. Please measure your car dashboard size before orders.

NOTE: If your car original radio is with Premium Factory Sound System/ Premium BOSE/Amplified Sound Systems/Onstar, the car radio does not fit !

8. Parameters

Category	Parameter
Motherboard	SHA16 / 23
Memory Configuration	1G & 2G
Storage Configuration	16G & 32G
CPU	8227L
Core	4
Main Frequency	1.3GHz
Android Version	11.0
Radio	FM/RDS
Communication	WIFI
Rear Camera Standard	AHD720 & CVBS
Satellite Positioning	GPS
Amplifier	7388
Sound Decoder	ST7729-HiFi
Carplay	Wireless carplay & Wired carplay
Android Auto	Wireless Android auto & Wired Android auto
Bluetooth Version	4.2
Colorful Lights	White light
USB	Dual USB
External Microphone	Support
Video Output	Support
DVR	Support
OBD2	Support
DAB+	Support
Split Screen	Support
Navigation	Offline Maps & Online Maps

[Introduction to basic functions]

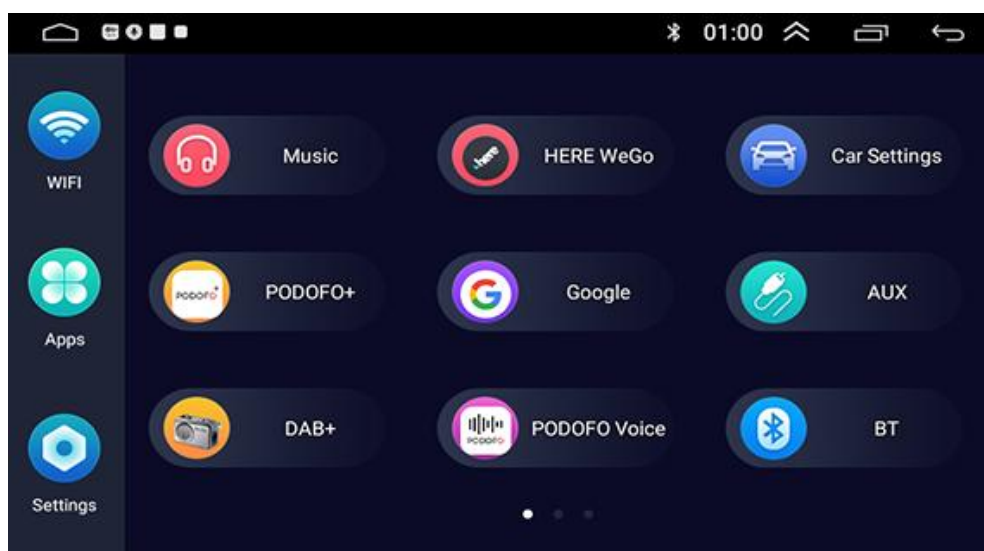
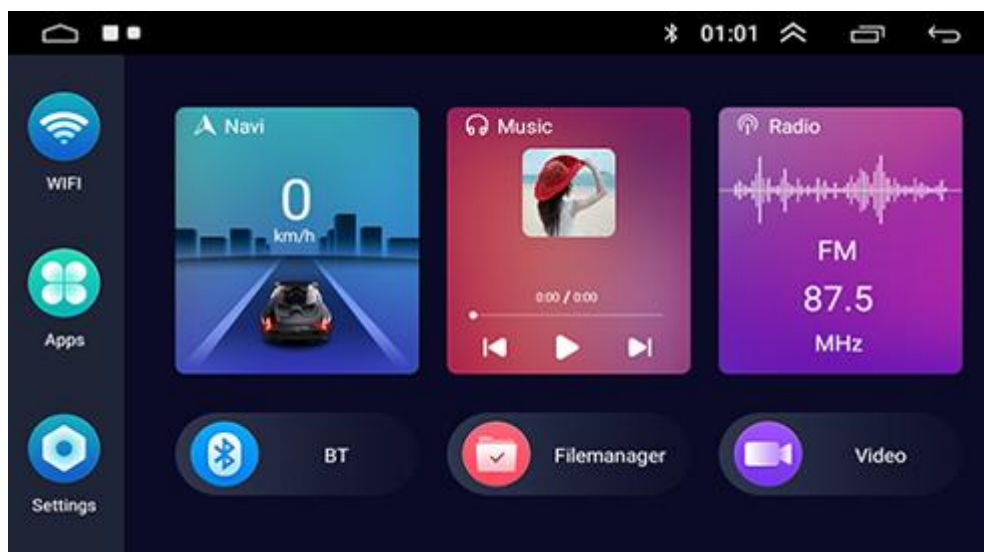

[Main interface]



[Icon Introduction]







1. Machine-Host







Symbol	Operations & Controls
MIC	Built-in microphone hole
RST	Reset (press with a sharp object)
⏻	Power on the device Press and hold for 3 seconds to power off the device Short press repeatedly to mute or unmute
🏠	To main menu
↶	Return to the previous interface

	Press or hold repeatedly to increase volume
	Press or hold repeatedly to decrease volume









2. On Screen - Main Interface

(Note: The main interface is different for different products, please refer to the specific product)









Icon	Name	Operations
	Main menu	Touch to switch screen to main menu
	Hide shortcut menu	Touch to hide the shortcut menu button area
	Backstage	Touch to show all programs running in the background
	Return	Touch to switch screens to return to previous screen
	WiFi	Turn on/off WiFi
	Apps	Touching will take you to the icon desktop of the installed application

	Settings	Touch to enter the Android settings interface
	Navi	Touch to enter the set navigation interface
	Music	Touch to go to local music
	Radio	Touch to enter the radio interface
	BT	Touch to enter the bluetooth interface
	Filemanager	Touch to enter file management
	Video	Touch to enter video playback

3. On screen - Drop-down list

Icon	Name	Operations
	Wi-Fi	Turn on/off Wi-Fi
	Bluetooth	Turn on/off Bluetooth
	Screen off	Open/Close Screen
	Car Amplifier	Turn on/off Car Amplifier
	Screenshot	Touch to take a screenshot
	Car setting	Touch to enterCar setting
	Clean-up	Touch to clean
	Video out	Touch to set Video out

4. On screen - APP Icon

Icon	Name	Operations
	HERE WeGo	Touch to enter offline map
	PODOFO Voice	Touch to enter Smart Voice to set up
	PODOFO+	Touch to enter Smart Voice software
	Google	Touch to go to Google
	★DAB+	Touch to enter DAB+
	Car Settings	Touch to enter settings, enter password 8888 for factory settings
	Maps	Touch to enter google map online
	ZLINK	Touch to enter ZLINK, can connect wired & wireless Carplay/Android Auto
	Sound Effects	Touch Adjustable Settings Sound Effects

[Choose correct Model and Year]

1. Car Settings - Factory Settings (passwords: 8888) - Parameter Settings - Protocol settings
- Raise - Ford
2. Turn off your car and restart
3. You can check the canbus "connect" or "disconnect" through "Car Settings - System info"
4. If this protocol does not work, please try other Kia models or other brands for Kia, because some protocols maybe do not integrate your steering. Need to turn off the radio each time to activate, you can check the connection status on the "Settings".

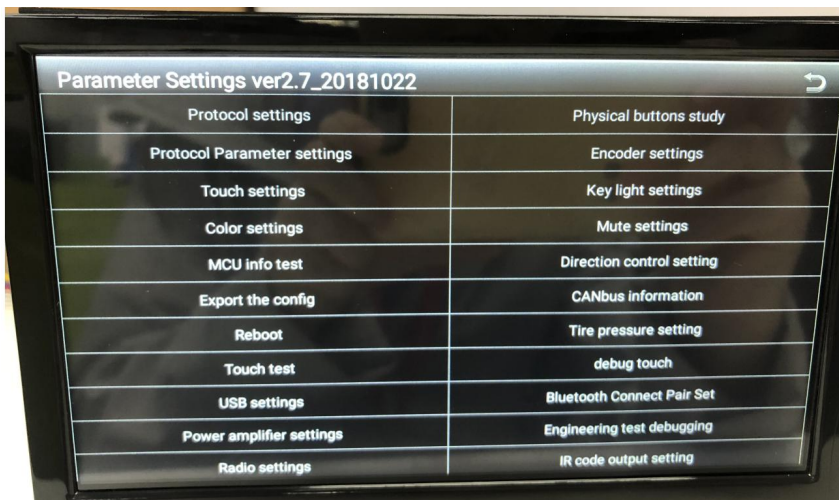

[Main functions and usage]



1. Music player

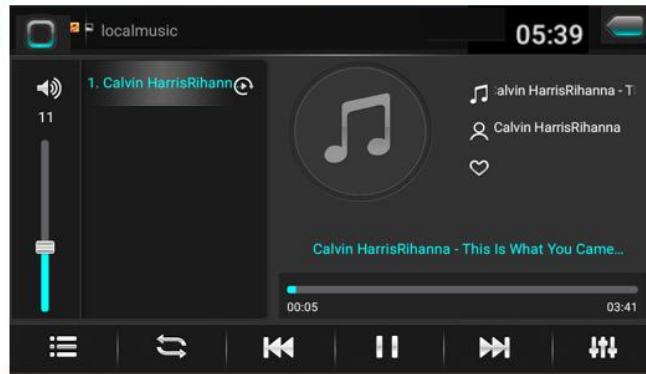

- Intelligent navigation
- Click on the "Intelligent Navigation" icon to enter the navigation state
In the navigation state, only GPS navigation-related functions can be performed on the screen. If you need to do anything else, you need to exit the navigation first.
- Navigation music function
In the network music / super CD/ local music / world broadcast / local radio / Bluetooth music state switch to GPS navigation, can normally enjoy the original state of music, when there is a navigation prompt, the system will automatically switch to navigation voice prompt state.
- Function operation
- This machine has the function of touching handwritten input destination query, please refer to the operation help of navigation interface for the operation of navigation function.
- Local music
- Click the "Local Music" icon to enter the local music playback interface (this machine must have a SD card or USB port and corresponding media files) Touch icon description
- : On the music list, you can play songs that you like to choose from different styles : Loop play mode switch
- : previous / next : Pause / play : Sound effect setting : Return to the previous menu
- : Back to the main interface



2. Video player

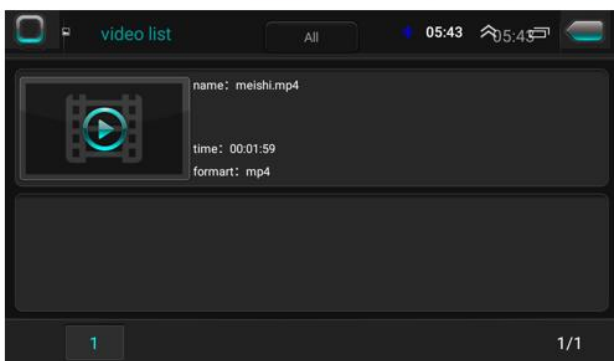

- Click the "Video" icon to enter the video list interface (this machine must have a SD card or USB port and corresponding media files)
- Click on the video and enter the video play interface
- Touch icon description
- : Back to the main interface
- : Return to the previous menu
- : Pause / play : Previous / next
- : Sound effect setting : Video scale



3. Radio



- > Local radio
- > Click the "local radio" icon to enter the local radio interface
- > Touch icon description
- > : Back to the main interface : Return to the previous menu
- > : Up / down search station , any radio station be searched the searching will stop
- > : To the left / to the right : FM switch : Save station

: Press this icon to select ST/LOC options.

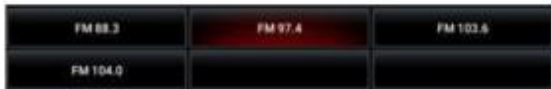





: Users can save his favorite radio frequency here.

Press the relative column for 3 seconds, the current radio frequency is saved in this place.



4. Bluetooth





- >Bluetooth
- > Click on the "Bluetooth" icon to enter the Bluetooth interface
- >Touch icon description
- >  : Bluetooth Settings  : Bluetooth connect  : Bluetooth Music  : Bluetooth call record
- >  : Bluetooth Phonebook  : Bluetooth dial keyboard



5. Bluetooth Music



- > Bluetooth Music
- > Touch icon description
- >  : Previous song  : Next song  : Bluetooth Music play



6. Car audio settings



Hi-Fi function, high-fidelity sound quality, perfect playback of the original sound field, can perfectly reproduce the sound of music or video, without distortion, bringing you the most authentic sound. Hi-Fi function brings you an immersive experience.

Click to enter Sound Effects, you can adjust and set the sound effects, click HiFi, the font turns red, indicating that the HiFi function is being used; click HiFi again, the font turns gray, indicating that the HiFi function is turned off.



7. Steering wheel control studying

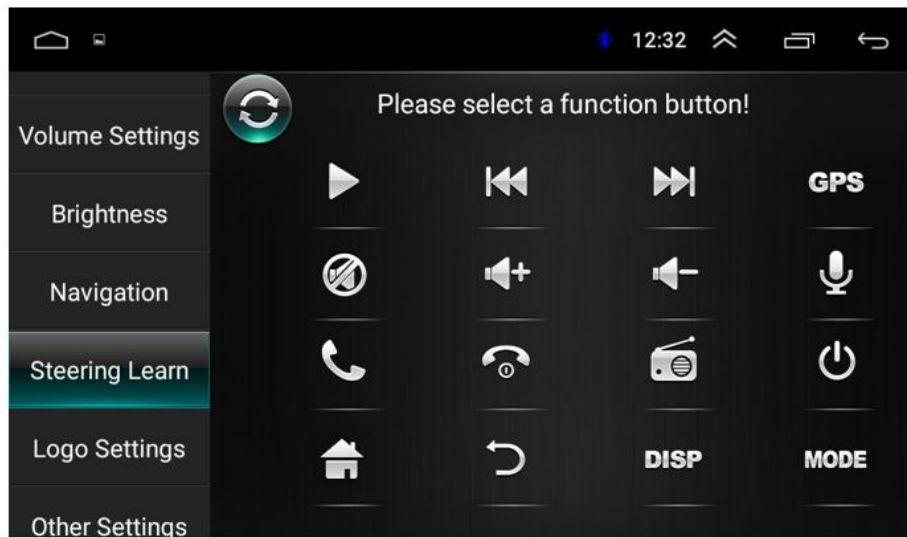

Please press and hold a button of the steering wheel button and click the corresponding icon

Please follow below steps to connect the wires:

1. Find your car steering wheel control button signal wires, it is normally located under your driving wheel.
2. The signals have two, one gives "+" voltage and another gives GND voltage.
3. Check our unit power cable, there is a wire labeled "key1" or "key1"
4. Connect the "+" Voltage wires to the "key1" or "key1" wires.
5. Connect the GND wire to GND wires of our unit.
6. Go to the this option to learn the steering wheel control function.
7. Press the relative function icon on the unit.
8. Press your steering wheel control button and there will be a voltage on our unit to memory.
9. Step by step to finalize all the buttons.

6. Car Setting:

This APP is special designed for Car Android Device

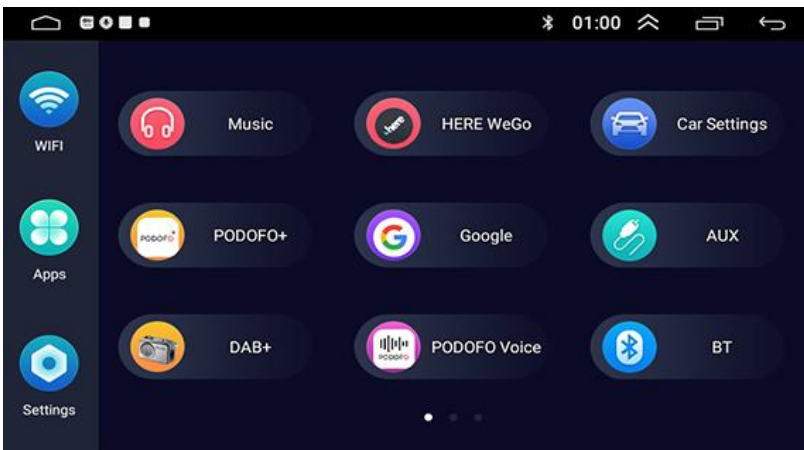

6.2 System Info:



Users can check the unit system information here

(The above information is for reference only and is based on actual configuration).

6.3 Factory Settings



Users can change the unit presets here. We do not recommend users to change any settings here as it may result unrecoverable damages to the unit (Password: 8888)

6.4 Car Settings:

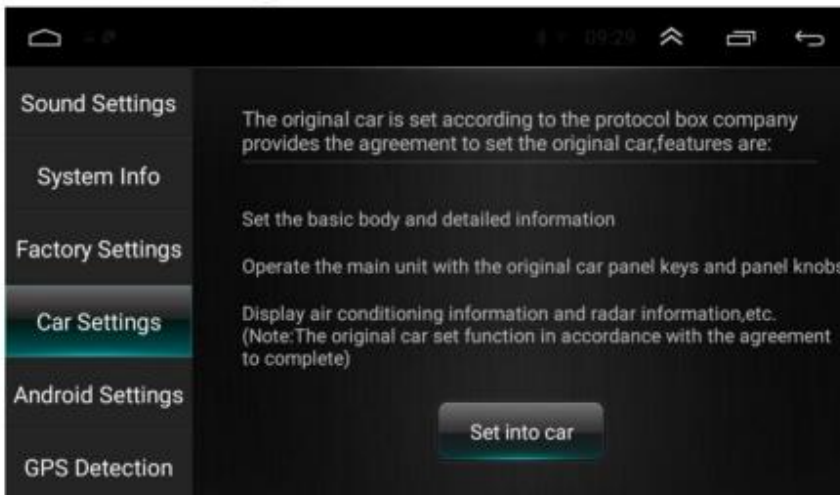

If users want to use the CANBUS to decode the car system do have the original steering wheel control, air conditioner etc, please contact with the sellers to buy the suitable CANBUS Decoding Box and make relative changes.

6.5 Android Settings



Users Press the "Go to settings" here to go to the android setting mode.

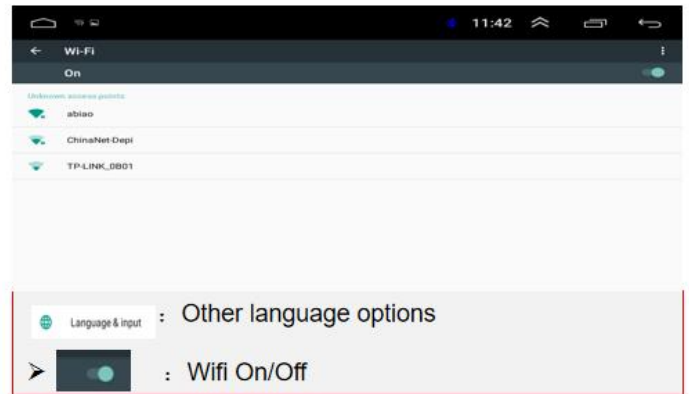
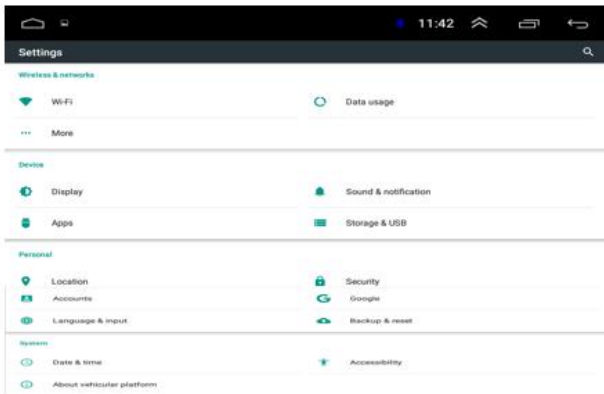

6.6 GPS Detection:

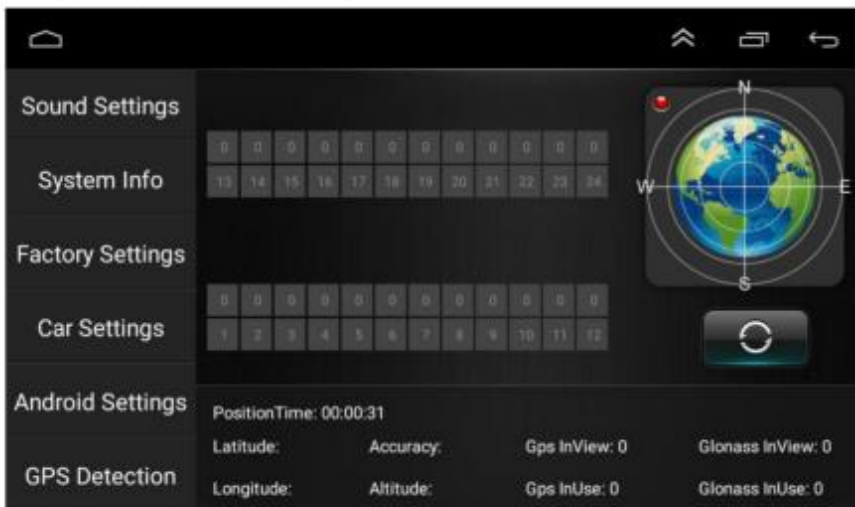

If users can not get the position in the navigation software, users can go here to check the hardware performance. If users can not find the GPS signal, please check if the GPS antenna is placed in the right way, make sure the receiver side is up, the side with stickers is down.

6.7 Volume Settings

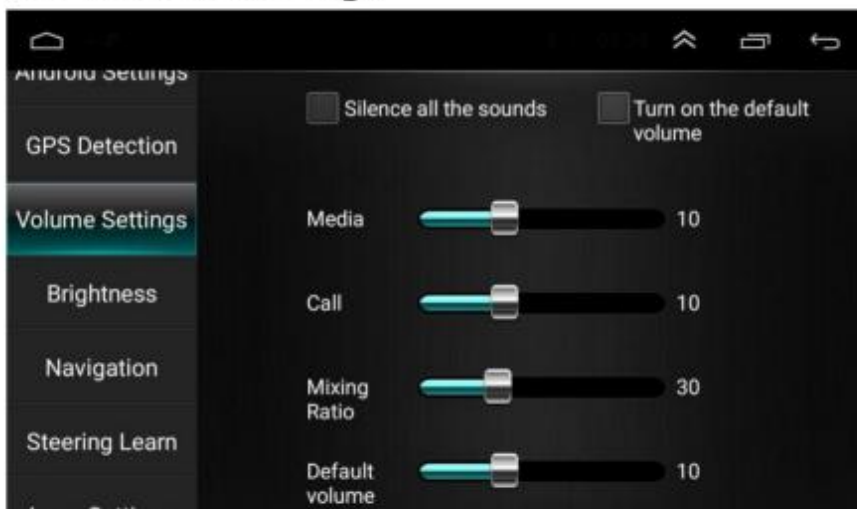

Users can adjust the volume ratio in different mode here.

6.8 Brightness



Users can change the brightness of the screen here.

6.9 Navigation

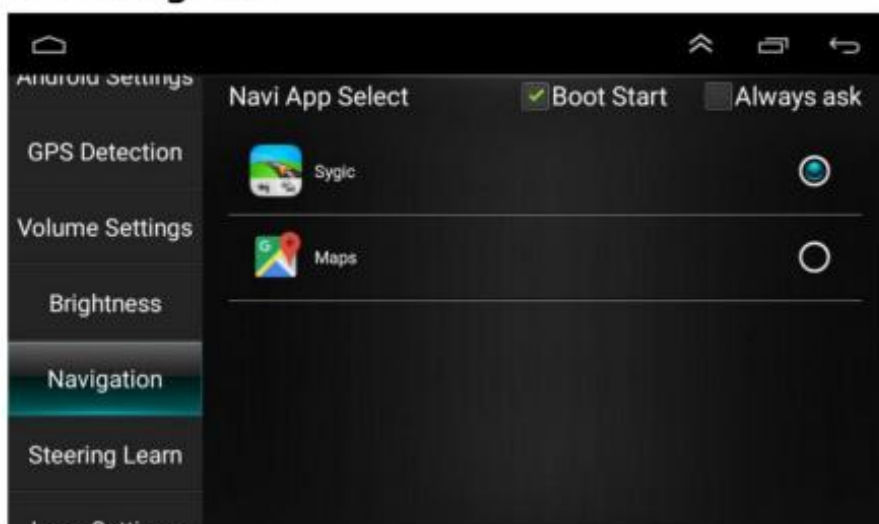

Users can select the relative navigation software as his preset one

6.12 Other Settings

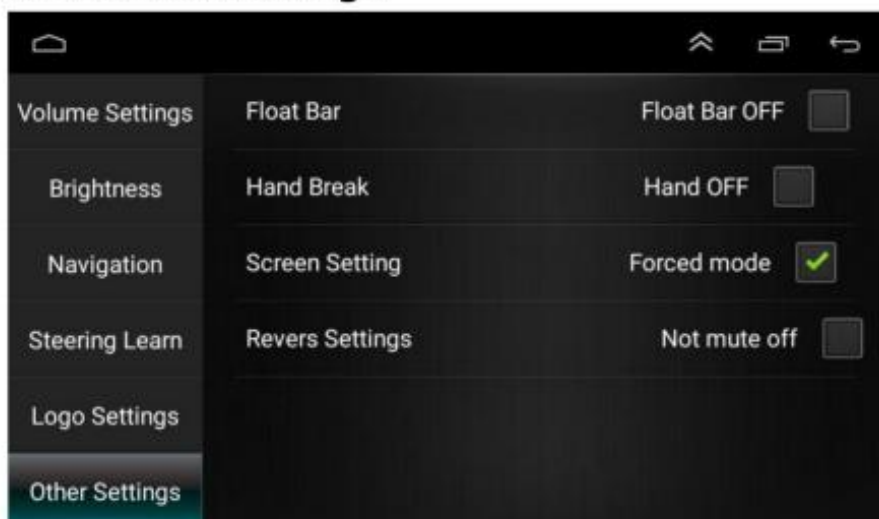

Float Bar: press this feature on to have the assistive touch point display on the screen all the time

Handbrake: press this on, then the device will not allow to watch video during driving due to safety reason

Screen Setting: This setting will force the screen in the Horizontal screen mode

Revers Settings : if you need to have the sound of the unit when you are reversing the car and enter into reverse camera mode, please click it on

6.13 Offline Map—HERE WeGo

(Note: You can also use Google Maps online)

In order to use the offline feature of your device, follow the steps below to set it up.

1. Power on the device and connect the device to the internet via Wifi.
2. Find the APP named HERE WeGo in the main menu.

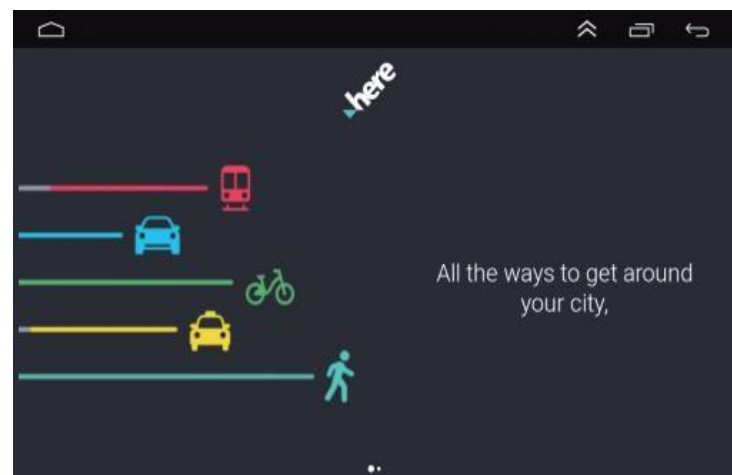
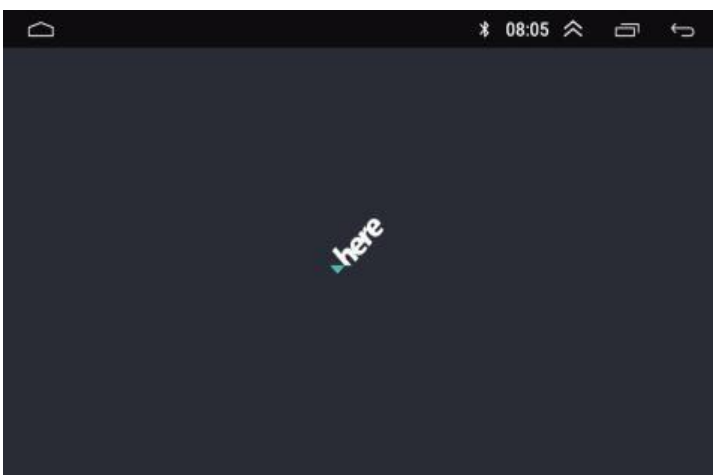

3. Follow the APP prompts to enter the main map page and find the options menu.

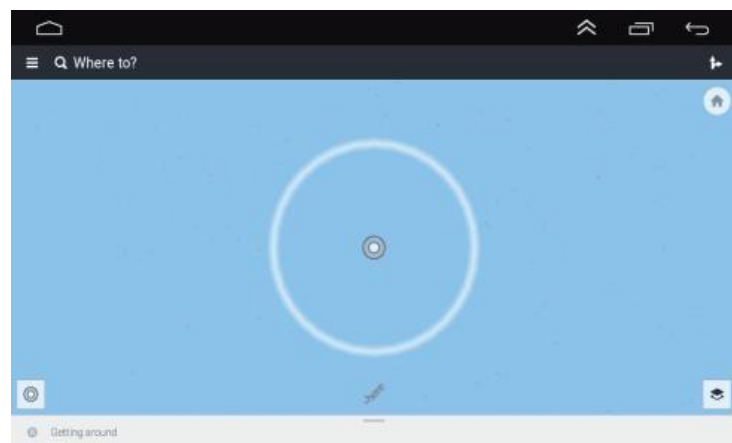

4. Click "Use the app offline" and download your favorite map data in the country list.

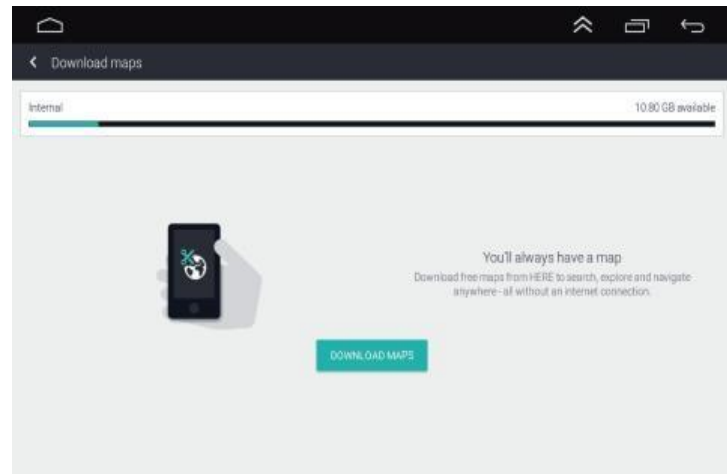
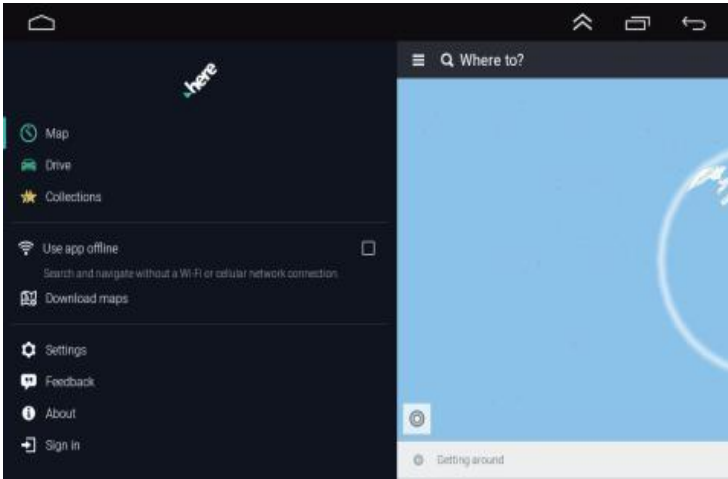

5. Click "Use the app offline" and download your favorite map data in the country list.

6.14 Supported Additional Devices

(Note: Additional devices are not included in the product and accessories, you need to purchase additionally!)

Icon	Name	Connection Way
	External Microphone	RCA MIC Interface
	DAB+	USB
	DVR	USB
	OBD	Bluetooth
	Subwoofer	RCA audio output or subwoofer interface
	Amplifier	RCA audio output interface
	Video Output	USB
	U disk	USB

Thank you again for using our product. If you have further questions, please contact our customer service staff. Product UI interface or functions may be modified and upgraded from time to time without notice. It is normal if the manual has some discrepancies !

7.Common troubleshooting wizard

If you encounter the following problems in use, troubleshooting will help you quickly solve the problem, if the problem is still not resolved, it is recommended to contact our service department to help solve.

Phenomenon	Reason	Handle
Can not boot	The car key is not inserted into the switch and the switch is not open	Insert the vehicle key and open the door
	Power line insertion host	Insert power cord
	May be the fuse of this machine is burned	Replace fuses with the same rated current
Touch screen is not allowed	Please press 5 fingers on the main page of the unit for 20seconds. Users will go to the screen/touch button calibrate page automatically	
Touch screen does not respond	System is dealing with transactions (road search, etc.), a moment,If the system is not working, you can try to reset it ,if still can not be resolved, it is recommended to contact our service department to help solve	
The back light of the button is not working	Please check if the wire labled "ILL" is connected to the front lamp wire. When the front lamp is on, the unit back light will be on automatically. Users can also connect this ILL wire to continues +12V to keep the button light on always.	
Without reversing visual image	No camera installed	Install the camera, insert the CCD plug of the host
	Camera standard is wrong	Replace camera with matching system
The system is not started, rearview image reversing the process, the key is invalid	The driving safety of the emphasis on the principle of product design, the car after the preset priority	Must terminate the reverse action, in order to press the original car power button to start the system boot
GPS cannot locate	GPS antenna not inserted	Insert GPS antenna
	May be in a number of GPS signal shielding area	Test the car out of a distance, to observe whether the recovery of GPS signal, if not restored, please contact the service department
Boot can not locate and navigate	Navigation map blind, some remote mountain or road has not been established in the local area	Please contact the after-sales service department to confirm the updated map
Fuzzy search can not find the place to go	First confirm whether the input is correct, and then try to enter the location of another name, if you can not find, it may not be in our database, It is recommended to connect WiFi to use online maps.	
The navigation system to the selected road detour	Navigation system in the road search will consider various factors, in addition to the distance will consider the level of road, traffic rules, viaduct, trunk, etc., in short, to facilitate the drivers in the shortest possible time to reach the destination.	
A blank on the map	It may be too large or too small for navigation scale. Try to change scale size to see if you can restore the map display. If it is not resolved, Maybe map data is lost, It is recommended to connect WiFi to use online map.	

Thank you for your time.

Carplay&Android Auto Operation Manual



Android Auto



CarPlay



Carplay Connection Considerations

1. The Carplay function only supports iPhone connection
2. The data cable used for Carplay connection must be the original Apple mobile phone data cable

Android Auto Connection Considerations

1. The Android Auto function can only support the connection of Android phones, and the Huawei version of phones does not support connection
2. Your Android phone needs to support Google services and install Android Auto software
3. Before using the Android Auto function, please check whether the Android Auto software in your phone needs to be updated. If you need to update, please update it before using it.

Other matters needing attention

1. Different car players and mobile phones have different connection interfaces. All pictures in this manual are for reference only. Please refer to the actual product pictures.
2. The built-in Carplay APP of different machines are different. Here we take ZLink as an example to introduce. If there is no ZLink App in your machine, please ask our customer service staff.

1. Carplay wired connection method

(please use an iPhone to connect)



(1) Open the car player and enter the main interface



(2) Find the built-in Carplay APP: ZLink in the Android car player, and open ZLink

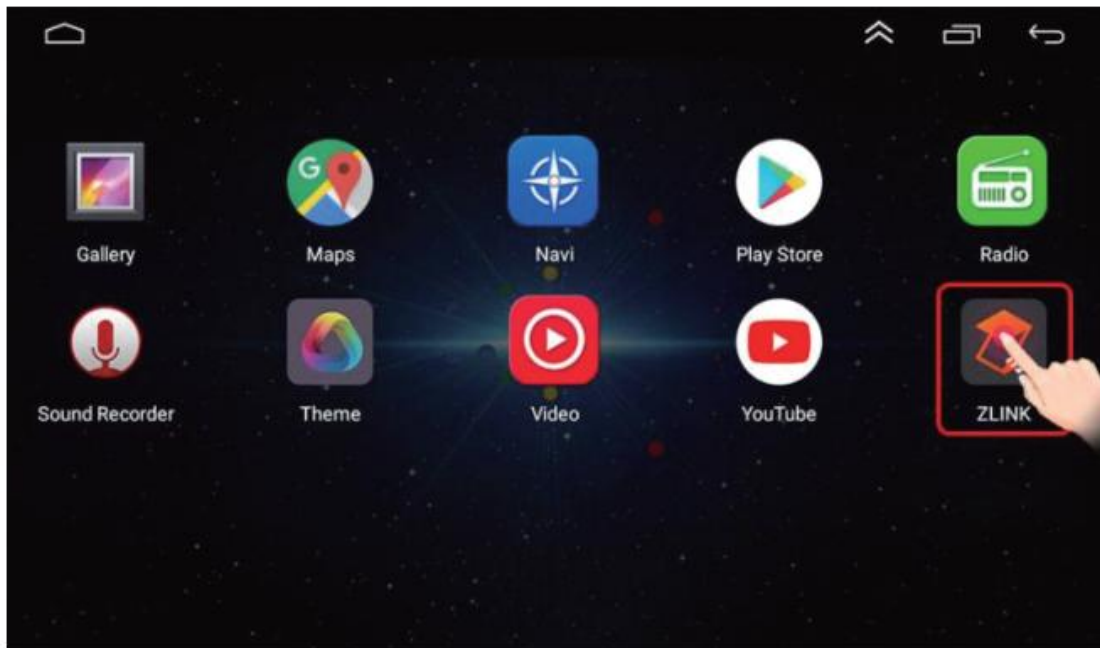

(3) Insert the original data cable of the Apple mobile phone into the car player and the USB port of the mobile phone



(4) Waiting for connection

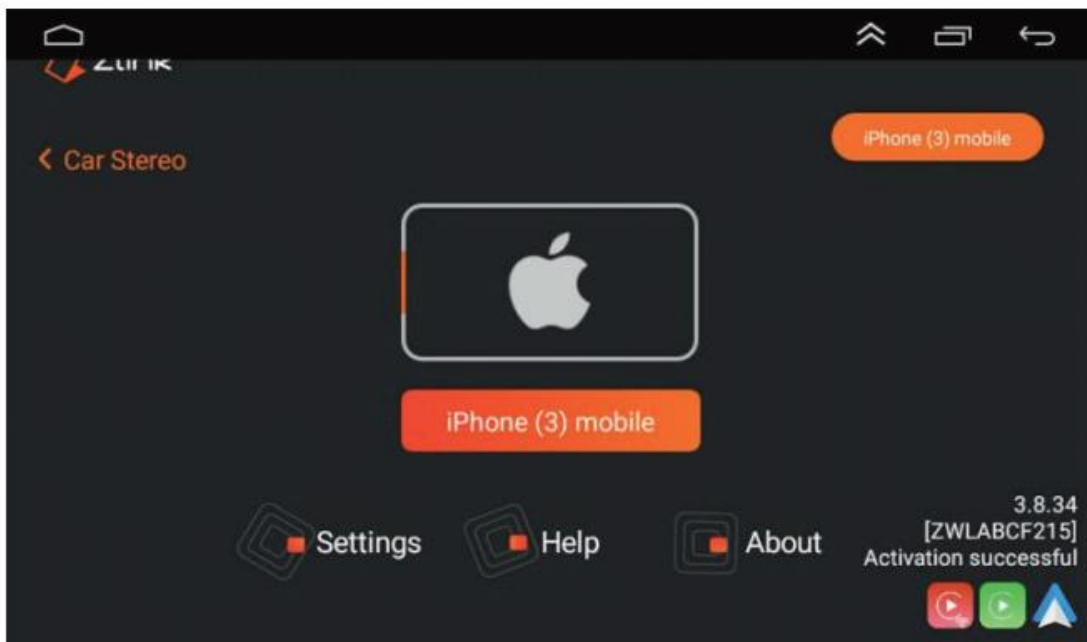

(5) The connection is successful



2、 Carplay wireless connection method

(please use an iPhone to connect)

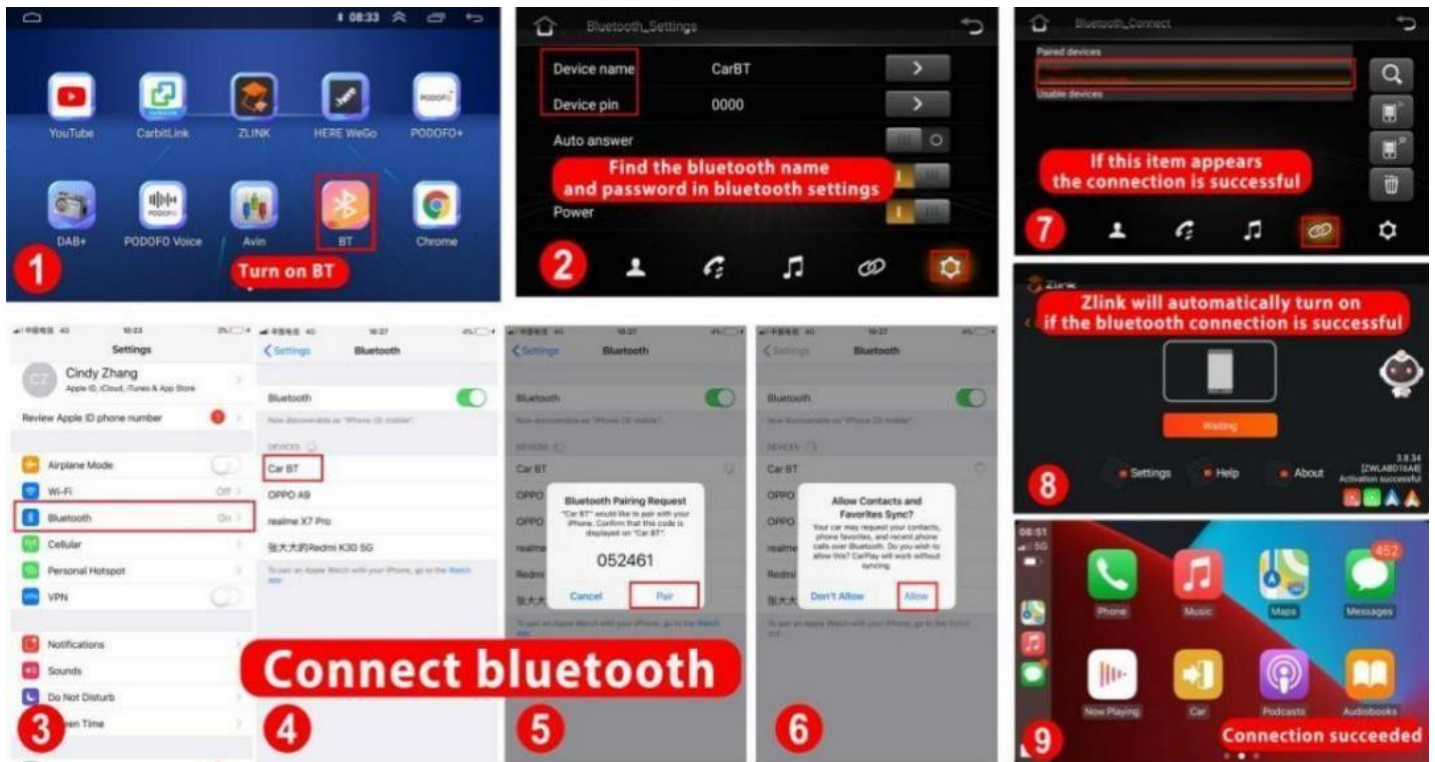

(1) Please turn on the Bluetooth in your car player

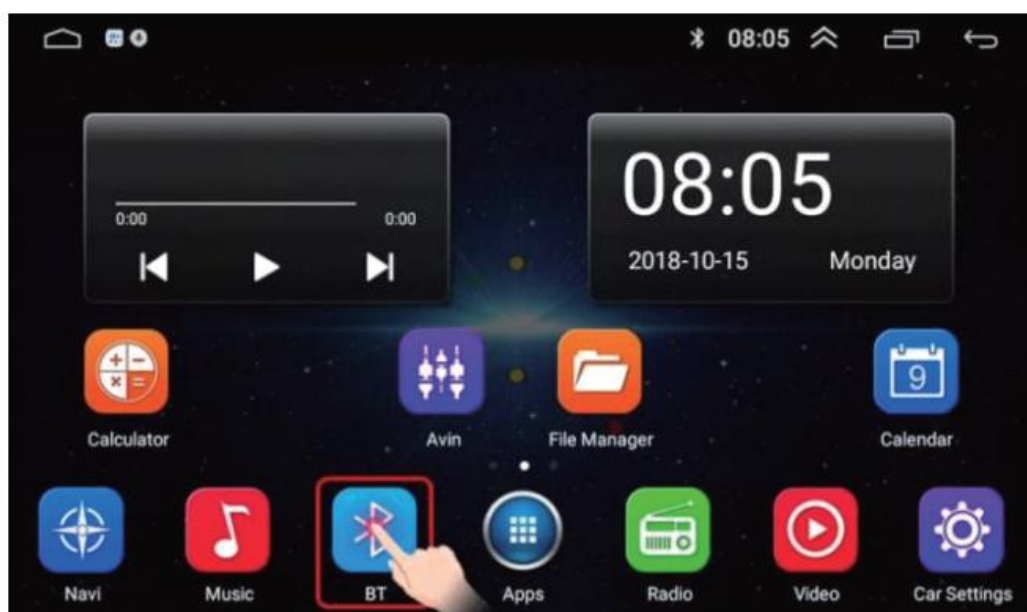

(2) Open the setting option in Bluetooth, you can see the Bluetooth name and password in your car player



(3) Connect your mobile phone to the bluetooth of the car player and match it, and return to the connection interface. There is a prompt "phone audio, music audio" under the bluetooth, which means the Bluetooth connection is successful

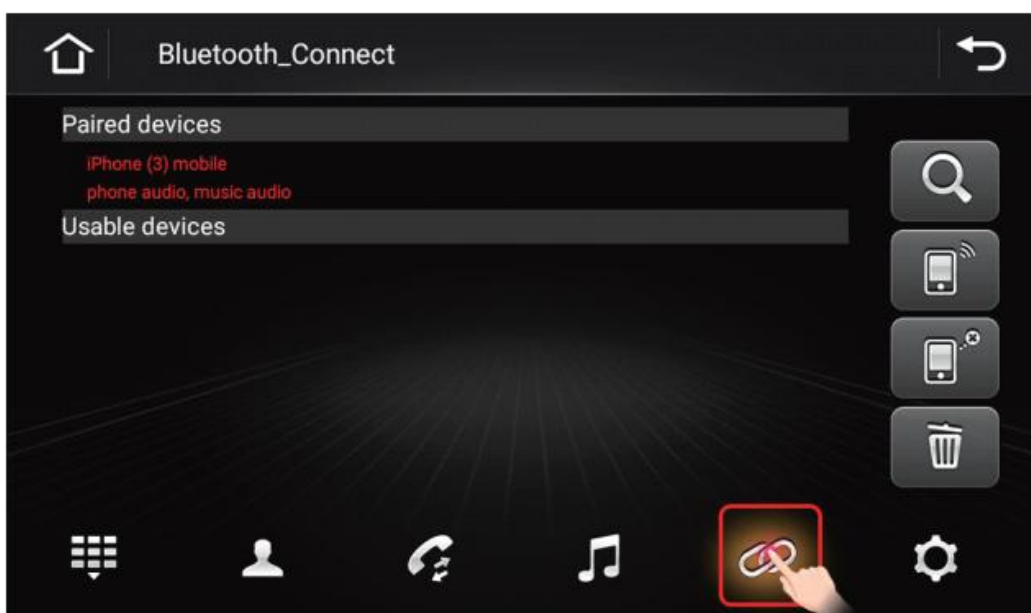

Note: If there is no "phone audio, music audio" prompt under Bluetooth in your car player, please click the Restart Bluetooth power and try to connect again until the "phone audio, music audio" prompt appears, indicating that the Bluetooth connection is successful

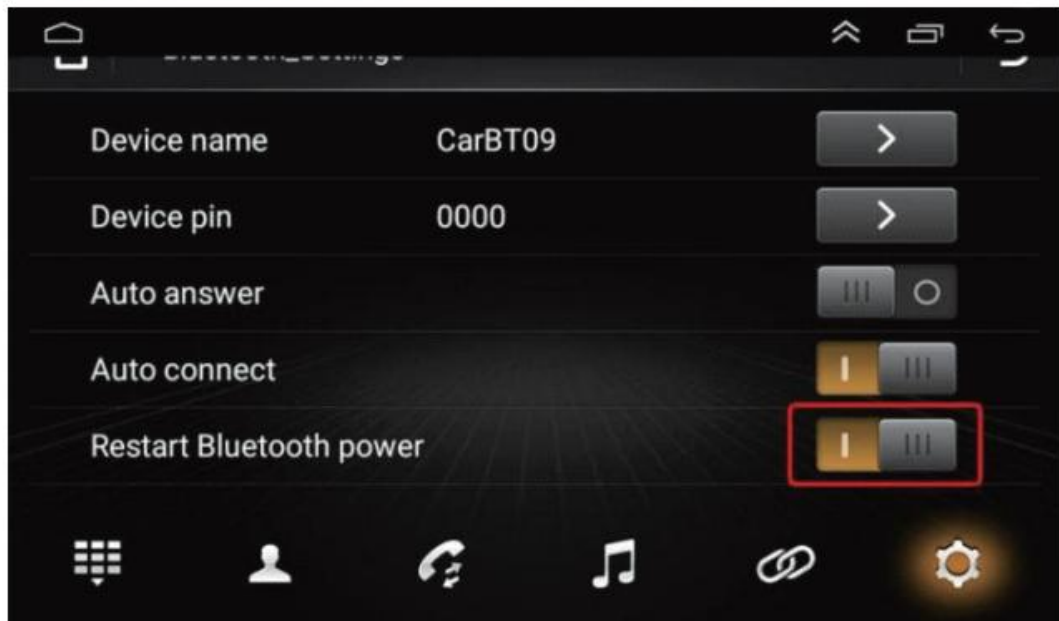

(4) After the Bluetooth connection is successful, the built-in Carplay APP: ZLink in the car player will automatically open, and wait for it to connect successfully (Note: You may need to wait a little longer for the first connection, this is normal)

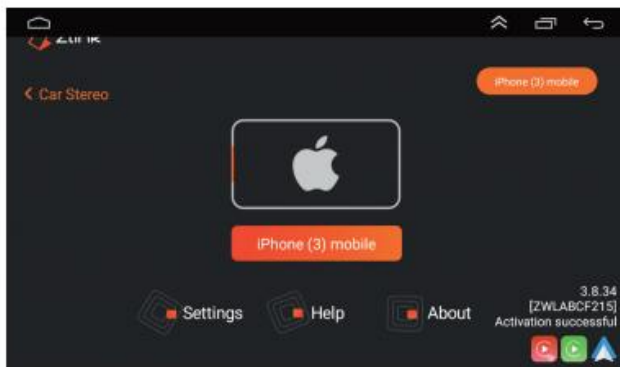

3、 If your Carplay connection fails

please do the following

(1) First of all, please make sure that your Bluetooth connection is successful. If your Bluetooth connection interface displays: "phone audio, music audio", it proves that the Bluetooth connection is successful

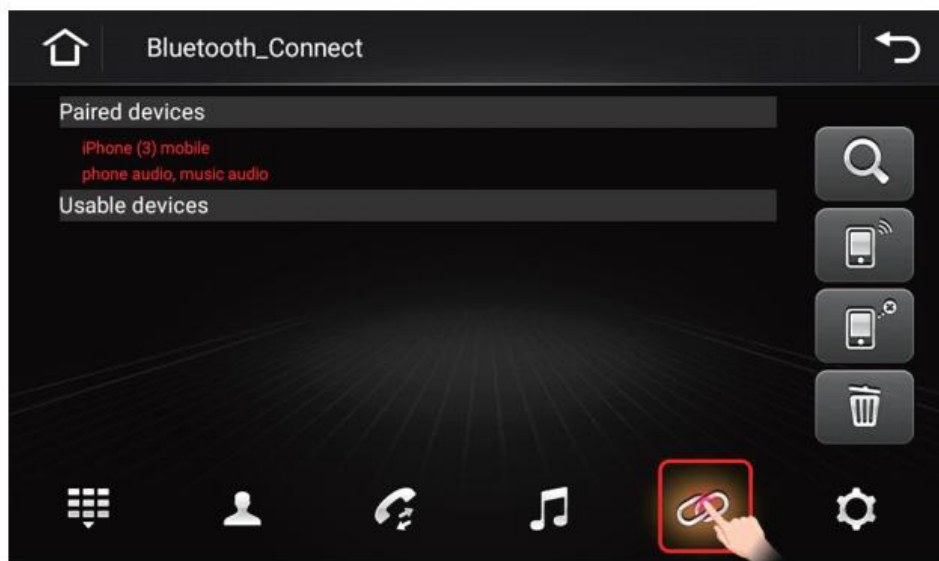

(2) Enter Android settings — Network&Internet — Hotspot&tethering—WIFI hotspot

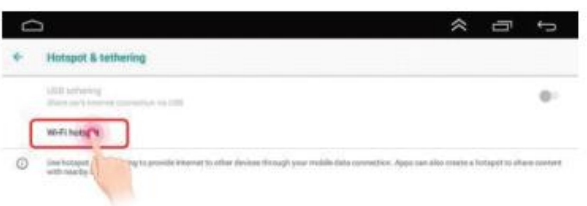

(3) Turn on the WIFI hotspot — click to “set up WiFi hotspot”, you will see the WiFi name and WiFi password of your machine, please connect your mobile phone to the hotspot of the car multimedia player

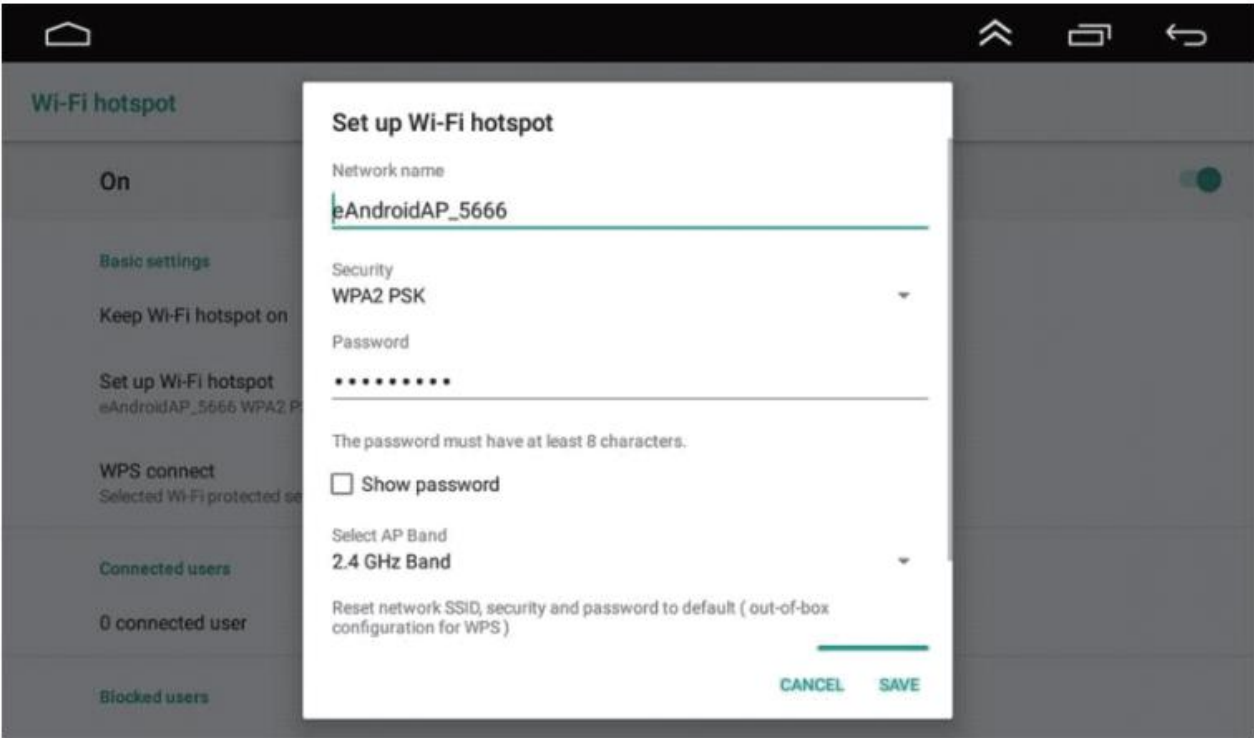
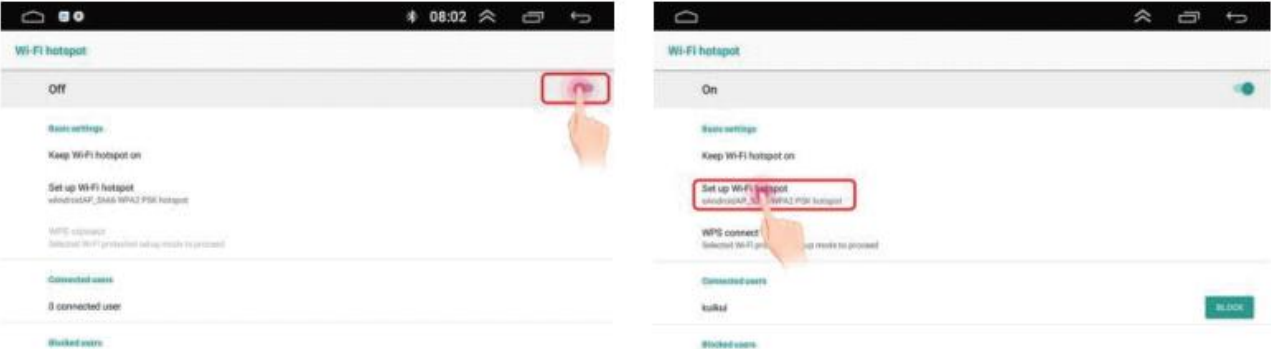

(4) When you see the name of your phone displayed in the connected device, it proves that the hotspot is successfully connected

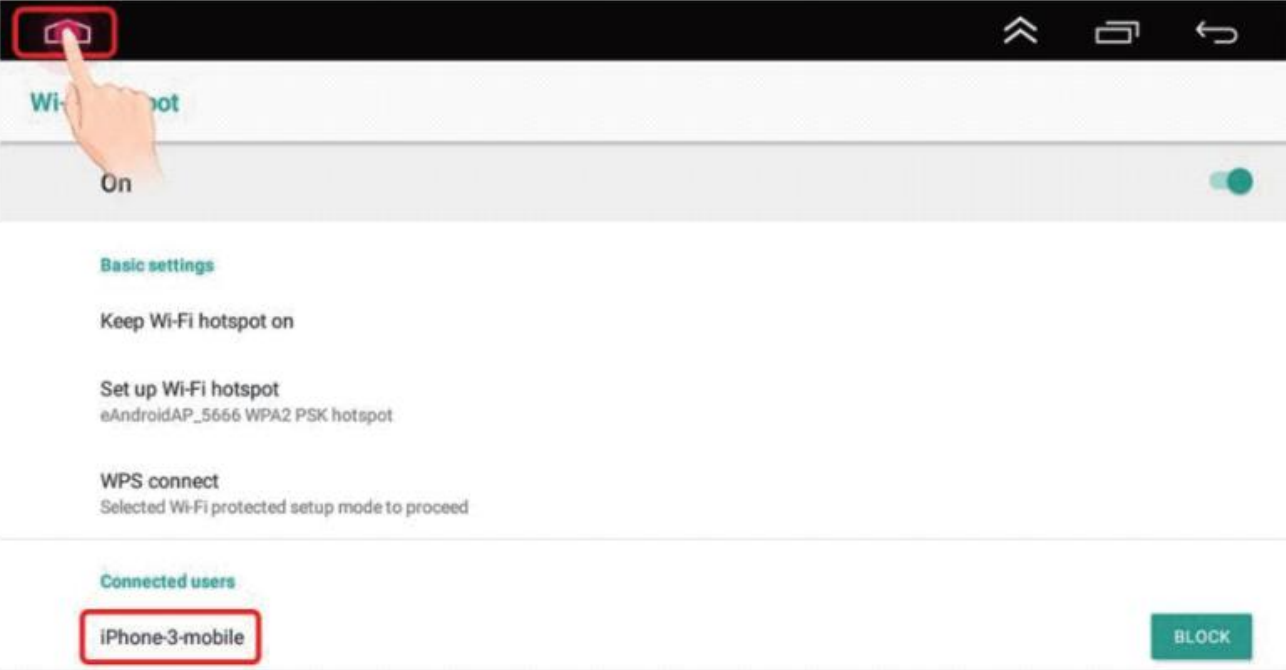
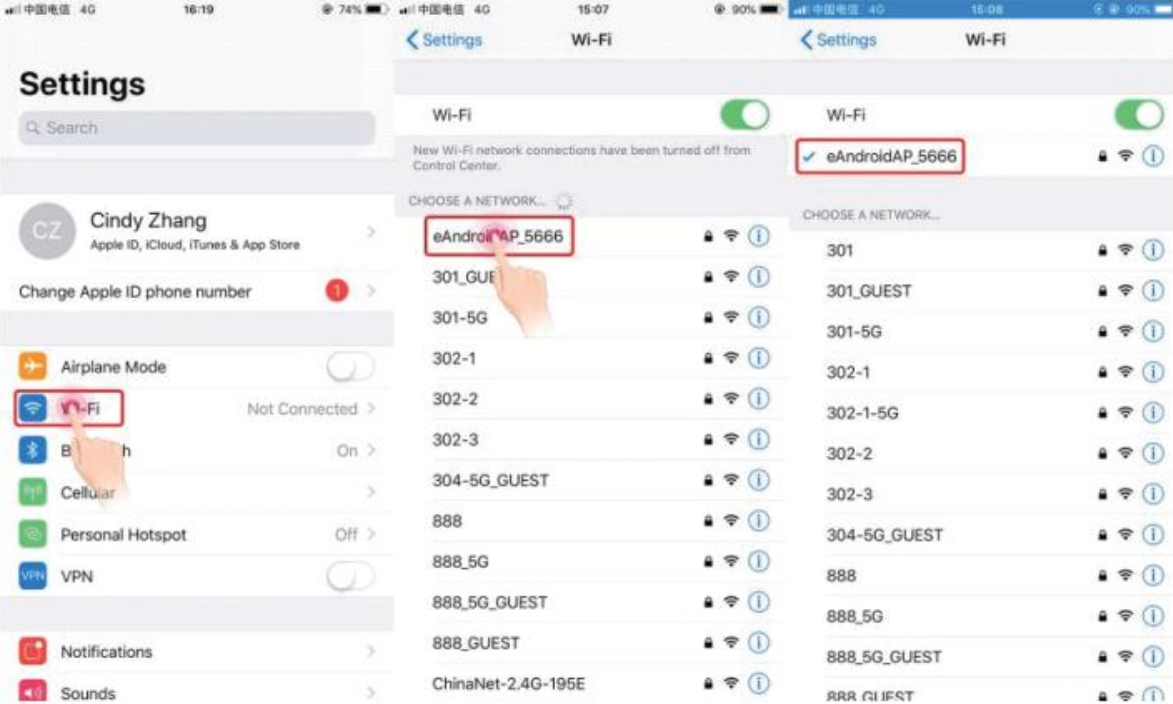

(5) Click the icon in the upper left corner to return to the main interface and clear all the records running in the background

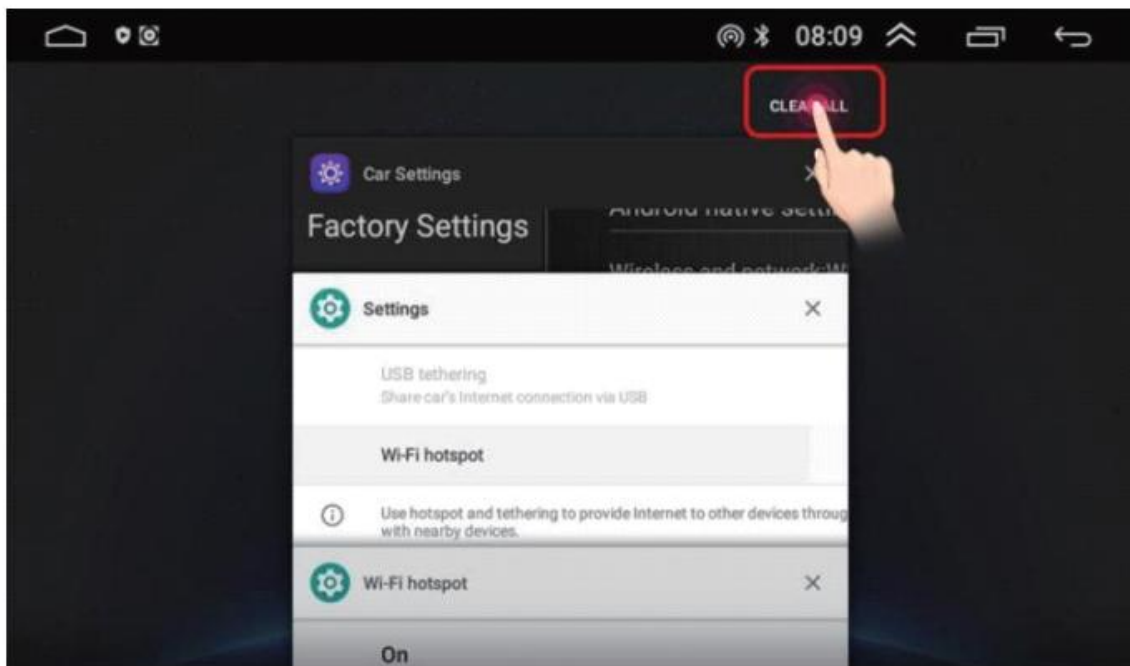

(6) Find ZLink and open it, click connect

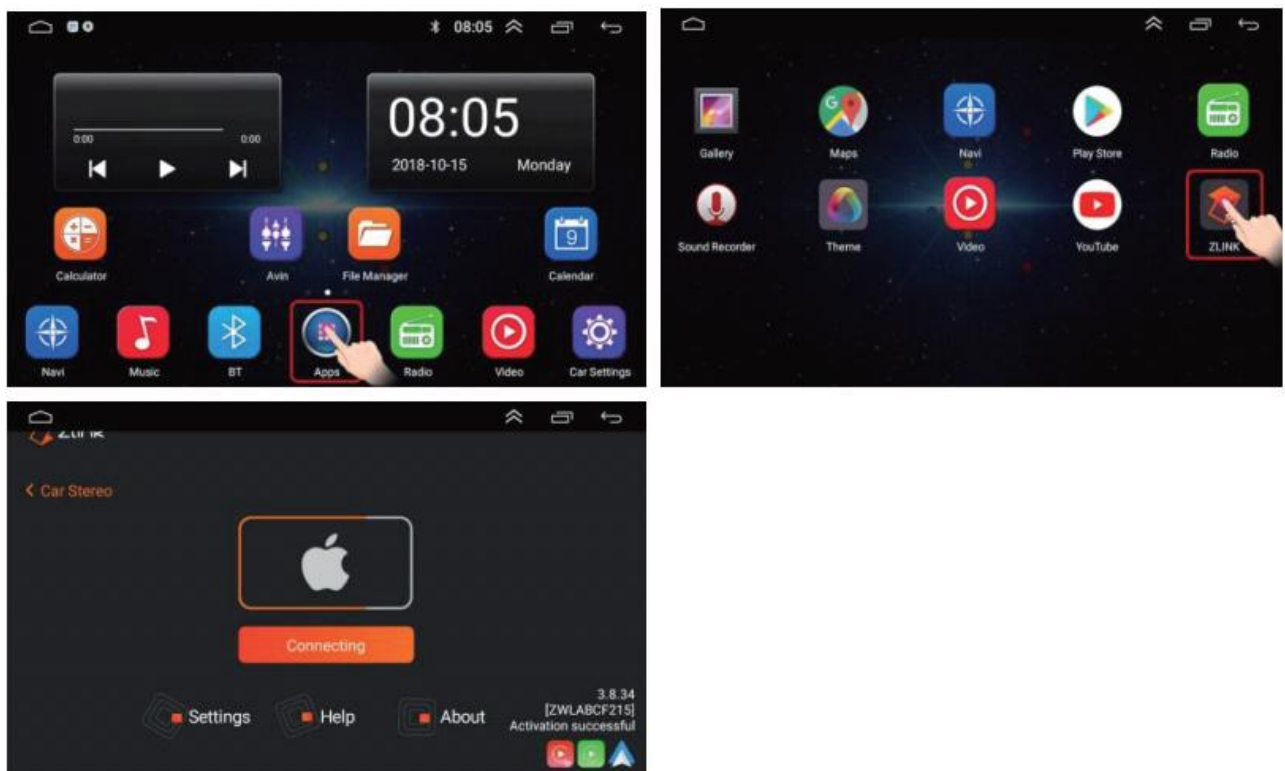

(7) Connecting

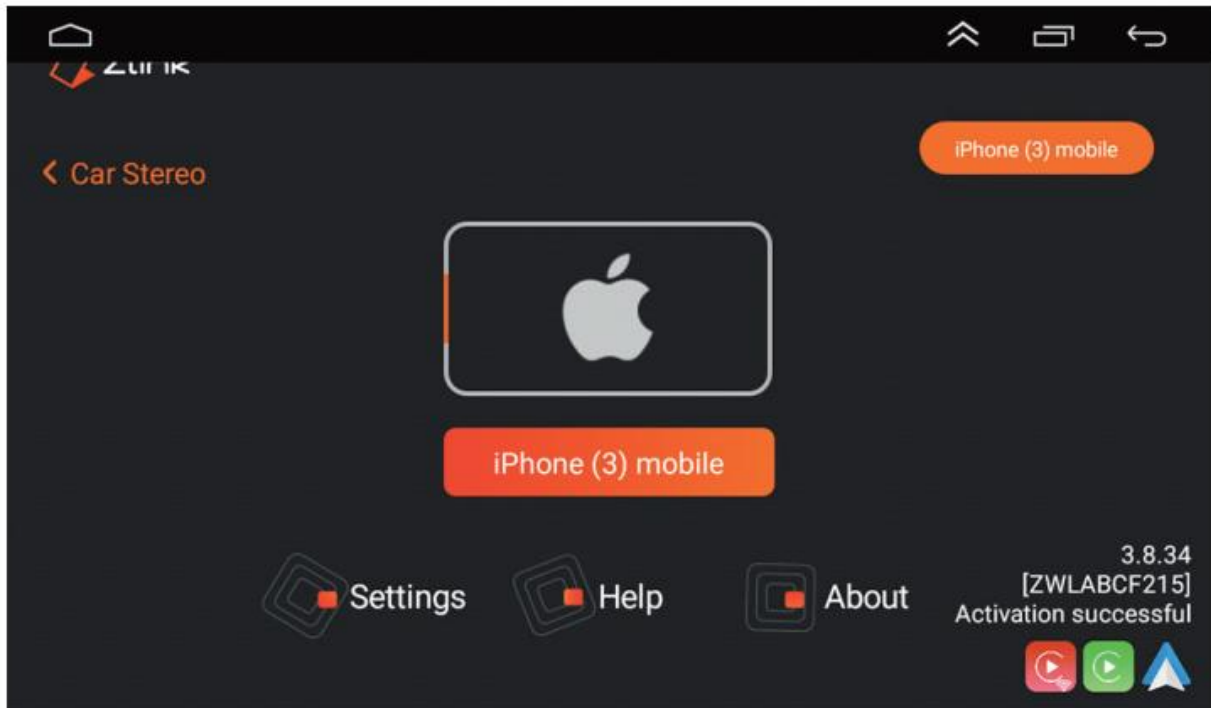

(8) The connection is successful

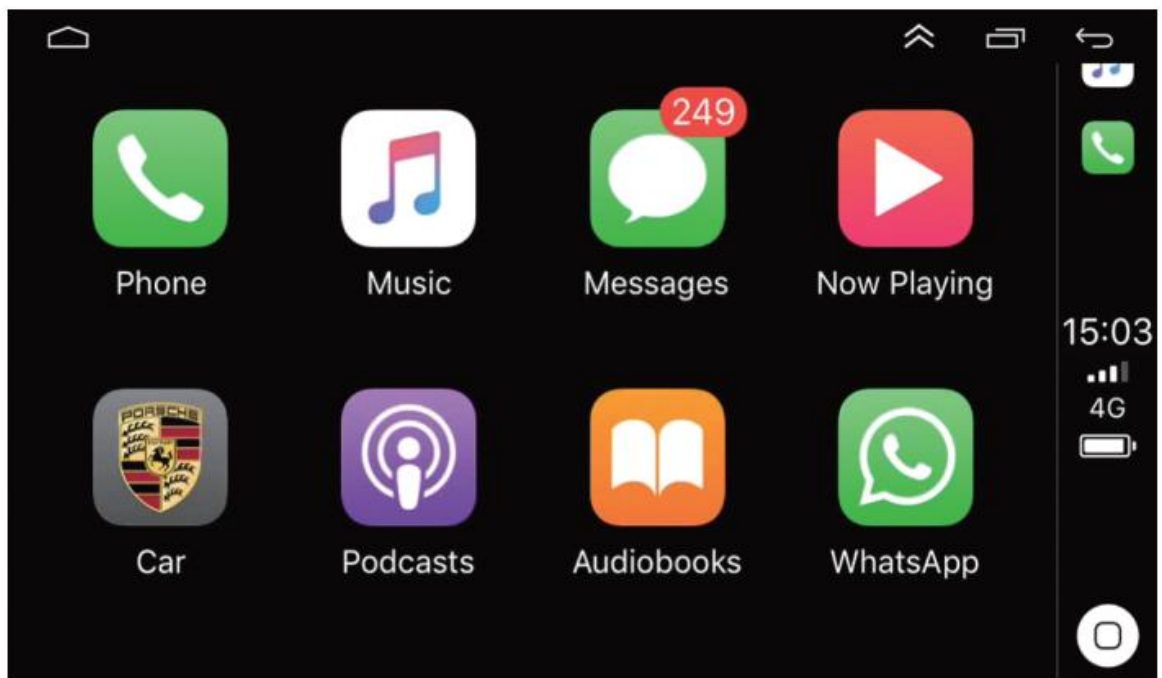

4、Android Auto wired connection method

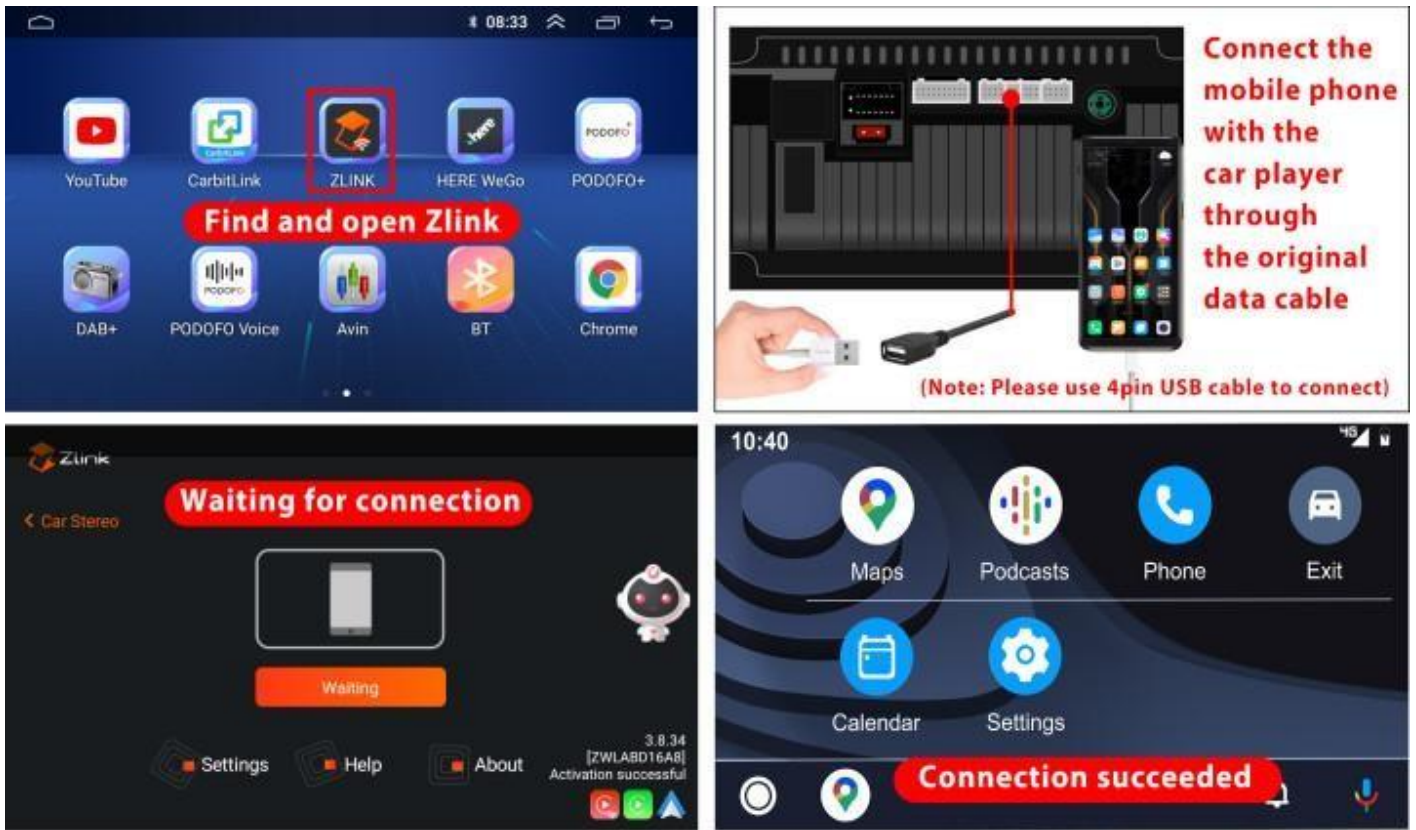

(1) Open the main interface of the car player, find ZLink and click to enter

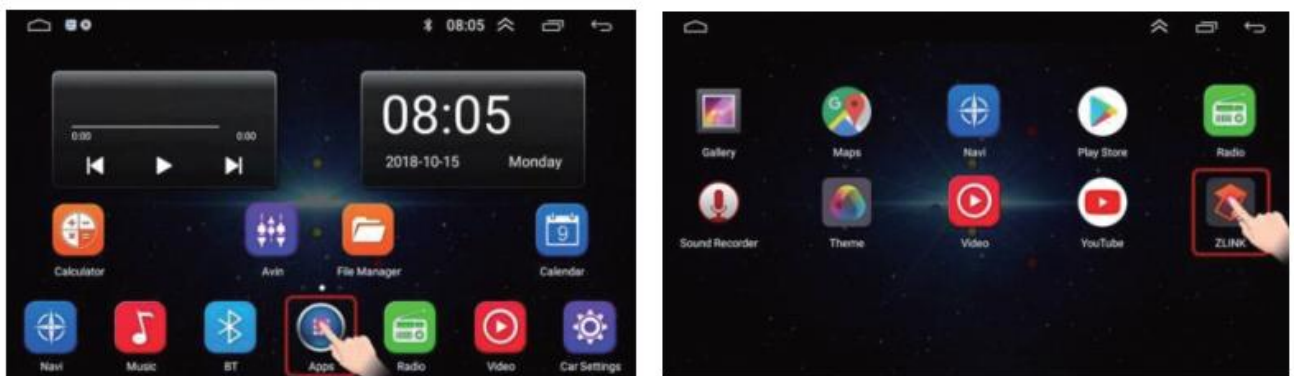

(2) Connect the original data cable of your mobile phone to the mobile phone, and plug the other end into the USB port of the MP5 car player (Note: Please use 4pin USB cable to connect)



Note: When you plug in the USB, the car player may pop up a prompt box, as shown in the figure below, please do not click, otherwise, Android Auto may fail to connect

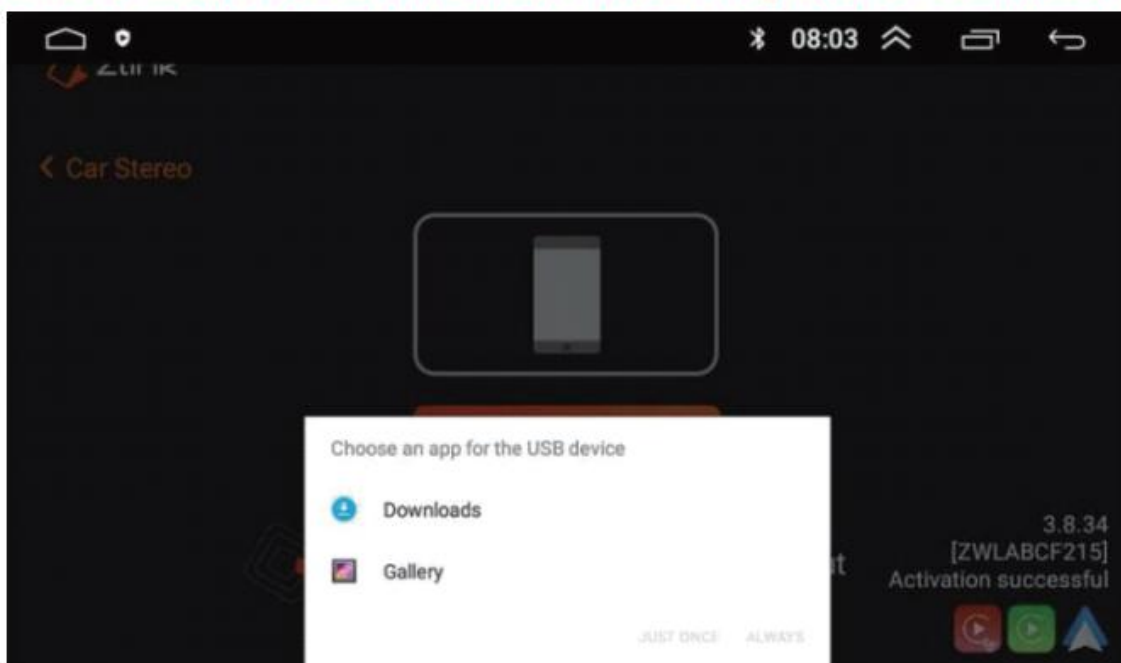

(3) Waiting for connection

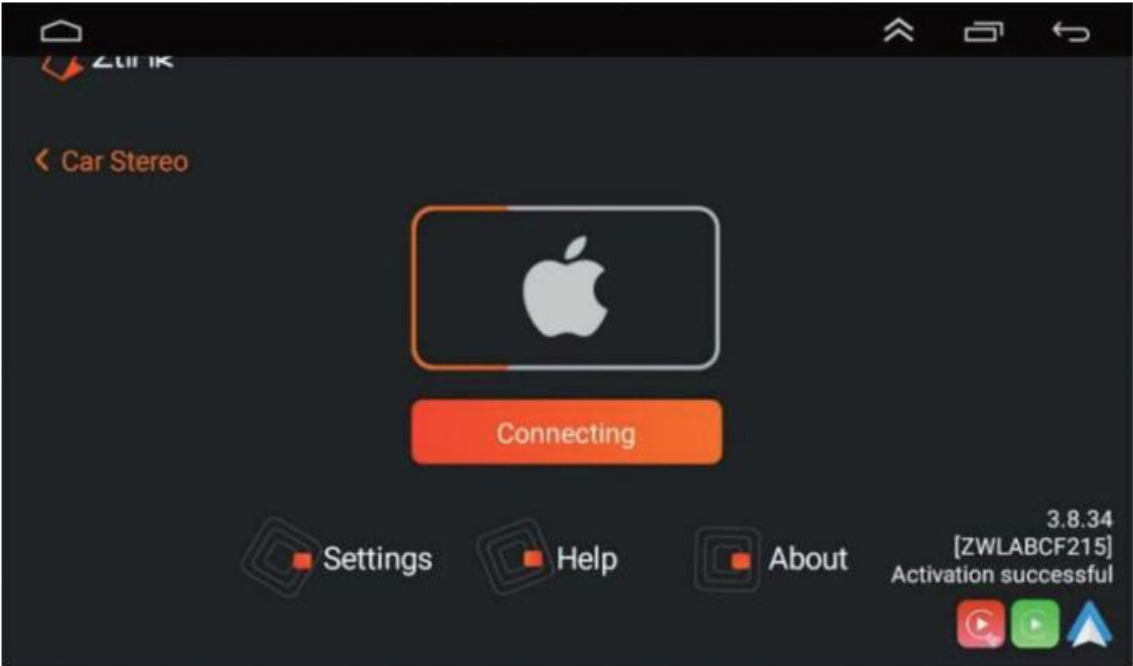

(4) The connection is successful



5. Android auto wireless connection



6. Video Link (just for reference)

- ① Wireless Apple Carplay Connection Video link:
https://v.youku.com/v_show/id_XNTkxODMzMtG4MA==.html
- ② Wireless Android Auto Connection Video link:
https://v.youku.com/v_show/id_XNTkyMDA5NzU5Mg==.html
- ③ Wired Apple Carplay Connection Video link:
https://v.youku.com/v_show/id_XNTkyMDEwNTA0NA==.html
- ④ Wired Android Auto Connection Video link:
https://v.youku.com/v_show/id_XNTkyMDEwMzkWMA==.html