

ZTE中兴



ZXHN H218N

User's Manual

CE0197

LEGAL INFORMATION

Copyright © 2012 ZTE CORPORATION.

The contents of this document are protected by copyright laws and international treaties. Any reproduction or distribution of this document or any portion of this document, in any form by any means, without the prior written consent of ZTE CORPORATION is prohibited. Additionally, the contents of this document are protected by contractual confidentiality obligations.

All company, brand and product names are trade or service marks, or registered trade or service marks, of ZTE CORPORATION or of their respective owners.

This document is provided "as is", and all express, implied, or statutory warranties, representations or conditions are disclaimed, including without limitation any implied warranty of merchantability, fitness for a particular purpose, title or non-infringement. ZTE CORPORATION and its licensors shall not be liable for damages resulting from the use of or reliance on the information contained herein.

ZTE CORPORATION or its licensors may have current or pending intellectual property rights or applications covering the subject matter of this document. Except as expressly provided in any written license between ZTE CORPORATION and its licensee, the user of this document shall not acquire any license to the subject matter herein.

ZTE CORPORATION reserves the right to upgrade or make technical change to this product without further notice.

Users may visit ZTE technical support website <http://ensupport.zte.com.cn> to inquire related information.

The ultimate right to interpret this product resides in ZTE CORPORATION.

Revision History

Revision No.	Revision Date	Revision Reason
R1.0	2012-07-18	First Edition





Serial No. SJ-20120718101334-001

Publishing Date: 2012-07-18 (R1.0)

1 Packing List

After opening the ZXHN H218N packing box, make sure that it contains the following components, as listed in [Table 1](#).

Table 1 Packing List

Component Name	Count	Image
ZXHN H218N host	1	 A white, square-shaped ZTE ZXHN H218N host with a small antenna on top and the ZTE logo on the front.
AC-DC power adapter	1	 A black AC-DC power adapter with a power cord and a connector cable.
RJ-45 network cable	Optional	 A yellow RJ-45 network cable with RJ-45 connectors on both ends.
RJ-11 telephone cable	Optional	 A light blue RJ-11 telephone cable with RJ-11 connectors on both ends.

The *ZXHN H218N Modem Maintenance Management Manual* is delivered with the product.

The actual items included in the package are subject to the telecommunication operator. If any of the components is incorrect or damaged, contact the product agency. If you want to change the product, keep the packing box and components.

2 Indicators

Figure 1 shows the ZXHN H218N indicators.

Figure 1 Indicators



Table 2 describes the indicators on the front panel.

Table 2 Indicators on the Front Panel

Indicator	Color	Status	Description
Power	–	Off	The device is powered off.
	Green	On	The device is powered on .
WAN	–	Off	The link is not activated.
	Green	Flashing	There is data flow.
		On	The link is activated.

Indicator	Color	Status	Description
Internet	–	Off	The following problems may be present: <ul style="list-style-type: none"> ● The system is not powered on. ● The WAN connection is not established. ● The IP or PPP session is broken due to a reason other than Idle Timeout.
	Green	Flashing	There is data flow.
		On	The connection is established and the IP address is allocated.
LAN1-LAN4	–	Off	There is Ethernet fault or the network is disconnected.
	Green	Flashing	The network is in connection. There is data flow.
		On	The network is in connection. There is no data flow.
WLAN	–	Off	<ul style="list-style-type: none"> ● There is a fault. ● WLAN is disabled.
	Green	Flashing	There is data flow.
		On	WLAN module is enabled. There is no data flow.
WPS	–	Off	<ul style="list-style-type: none"> ● WPS button is not used. ● The indication of successful connection is over. ● There is a fault.
	Green	Flashing	WPS function is enabled. The device is implementing the relevant negotiations.
		On	Wireless connection is successful. The indicator is off in five minutes.
Phone	–	Off	The device is not powered on or the device fails to register to the soft switch.
	Green	Flashing	There is data flow.
		On	The device has registered to the soft switch successfully. However, there is no data flow.

Indicator	Color	Status	Description
USB	–	Off	USB port is disabled or USB device is not connected.
	Green	Flashing	Data is transmitted through USB port.
		On	USB device is connected and available.

3 Interfaces and Buttons

Figure 2 shows the ZXHN H218N interfaces and buttons.

Figure 2 Interfaces and Buttons



Table 3 describes the ZXHN H218N interfaces and buttons.

Table 3 Interfaces and Buttons

Interface/Button	Description
ON/OFF	Power button
WPS	WPS access switch, used to enable/disable WPS access
WLAN	WLAN RF switch, used to turn on/off WLAN RF

Interface/Button	Description
Reset	Reset button, used to restore the factory default settings when pressed for more than 5 seconds in power-on state
Power	Power socket, 12 V DC
LAN1–LAN4	RJ-45 port, used to connect to a PC or other network device
Phone	RJ-11 port, connected to the phone through the telephone line
WAN	RJ-45 port, used to connect to the network provided by the ISP
USB	USB Host port, used for the USB storage device connection

4 Product Features

The ZXHN H218N supports the following features:

- Supporting one FE port with RJ-45 connector for Ethernet Uplink
- Supporting 4X10/100 Base-T Ethernet interfaces
- Supporting one USB 2.0 Host
- Supporting one FXS port
- Supporting 802.11b/g/n
- Supporting Bridge and Router mode
- Supporting NAT (Network Address Translation)/NPAT (Network Port Address Translation)
- Supporting ALGs (Application Level Gateways)
- Supporting Port mapping
- Supporting DMZ
- Supporting UPnP IGD (Internet Gateway Device) with NAT traversal capability
- Supporting Static Routing
- Supporting DNS Proxy
- Supporting DHCP Server/Client
- Supporting IGMPv2/v3 snooping in bridge mode
- Supporting SNTP (Simple Network Time Protocol) to get current time from network time server
- Supporting IP QoS for prioritizing the transmission of different traffic classes
- Supporting Interface based marking with 802.1p bit and DSCP bit
- High reliability, simple operation and low power consumption

5 Technical Specifications

Table 4 lists the ZXHN H218N technical specifications.

Table 4 Technical Specifications

Item	Specification
Dimensions (Without the base)	148 mm × 56 mm × 130 mm (Length × Width × Height)
Rated current	1.0 A
Rated voltage	12 V DC
Working temperature	-5°C to 45°C
Working humidity	10% – 95%
Storage temperature	-40°C to 70°C
Storage humidity	5% – 95%

6 Hardware Connection

Figure 3 shows the connections between the ZXHN H218N and other devices.

Figure 3 Entire Connection

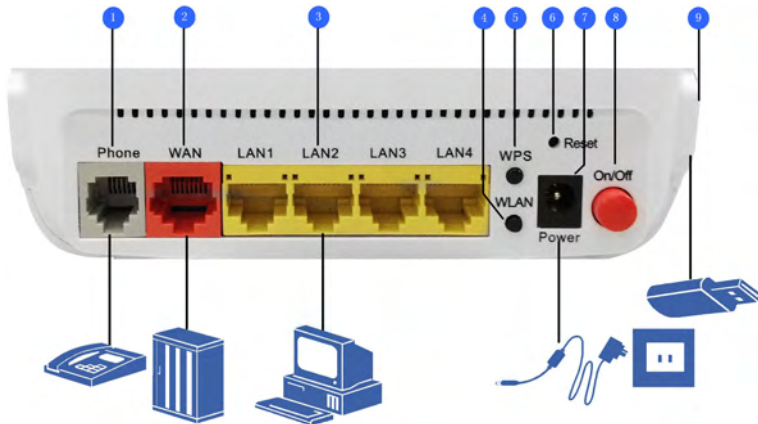

1. VoIP interface
2. WAN interface
3. LAN interface
4. WLAN button
5. WPS button

6. Reset button
7. Power socket
8. On/Off button
9. USB interface

The connections between the ZXHN H218N and other devices are as follows:

- **Figure 4** shows the connection between the ZXHN H218N and the telephone.

Figure 4 Telephone Connection

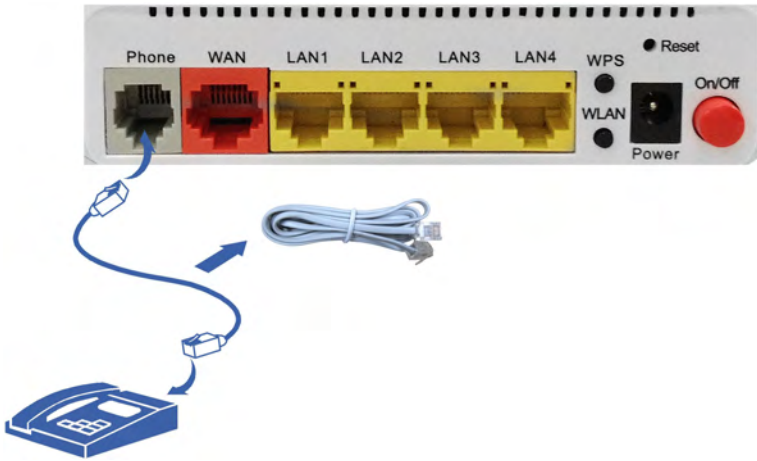

- **Figure 5** shows the connection between the ZXHN H218N and the computer.

Figure 5 Computer Connection

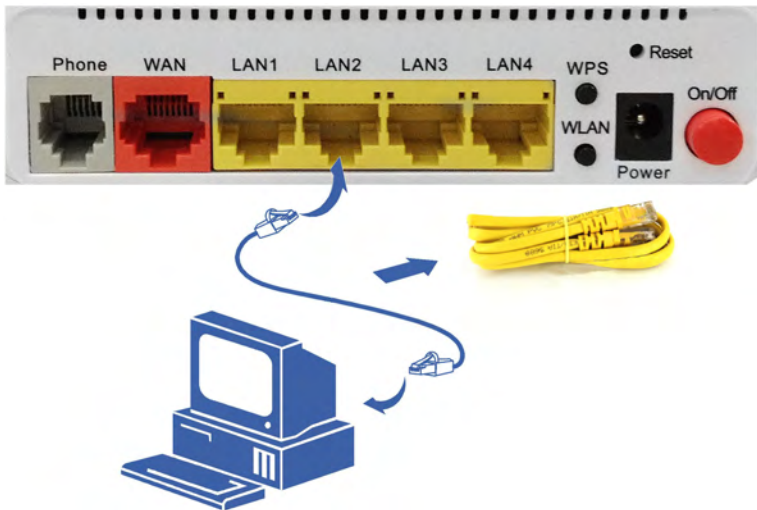

- **Figure 6** shows the connection between the ZXHN H218N and the USB storage device.
Figure 6 USB Storage Device Connection



- **Figure 7** shows the connection between the ZXHN H218N and the power supply.
Figure 7 Power Supply Connection

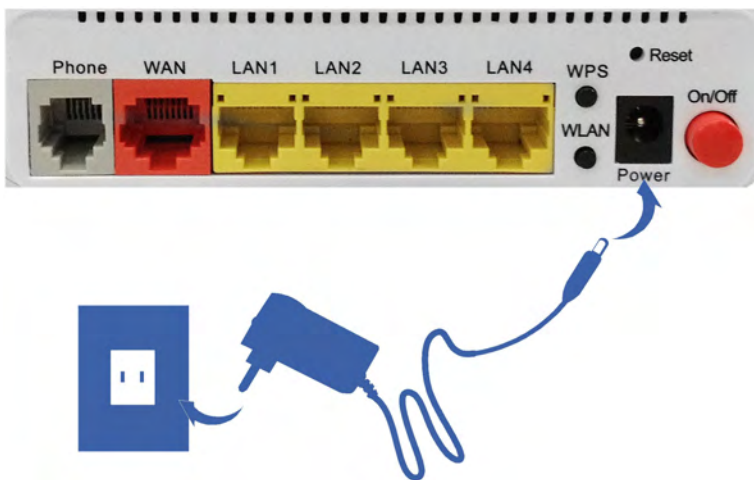

To supply power for the device, press the power button on the back of the device. When WAN indicator of the ZXHN H218N is ON, you can access the Internet.

ZTE Corporation Warranty Card

Dear customer,

Thank you for choosing the ZTE communication product. To obtain our best service, please read the information in this warranty card carefully and keep this card properly. ZTE Corporation warrants that the product will be free of manufacturing defects for a period of one year from the date of purchase. Should there be a manufacturing defect in the product during the limited warranty period, ZTE Corporation shall provide free service and maintenance for the defective product.

Notice for Customers

ZTE Corporation will charge for parts, components, or services under either of the following circumstances:

- After the warranty of the parts and/or the components has expired.
- Damage caused by purchaser in transportation or shipping.
- Damage caused by disassembly, repair or modification of the product by anyone other than warrantor authorized dealers and service providers.
- Damage caused by operation outside the instructions and notices stated in the operation manual (such as damage caused by hot plug of the product).
- Damage caused by irresistible natural disasters.
- Purchaser fails to present the warrant card, or the warranty card does not conform to the product, or the records in the warranty card are incorrect.

Customer Information

Customer Name		Purchase Date	
Contact Person		Customer Phone	
Address			
Dealer		Dealer Phone	
Model Number		Serial Number	

Service and Maintenance Record

Date	Maintenance/service Item	Signature of Maintenance Engineer	Signature of Customer

ZTE Corporation

合格证 CERTIFICATION	
检验员	
CHECKER	
日期	
DATE	ZTE中兴



ZTE CORPORATION
NO. 55, Hi-tech Road South, ShenZhen,
P.R.China
Postcode: 518057
Tel: (86) 755 26771900
Fax: (86) 755 26770801
URL: <http://ensupport.zte.com.cn>
E-mail: support@zte.com.cn