

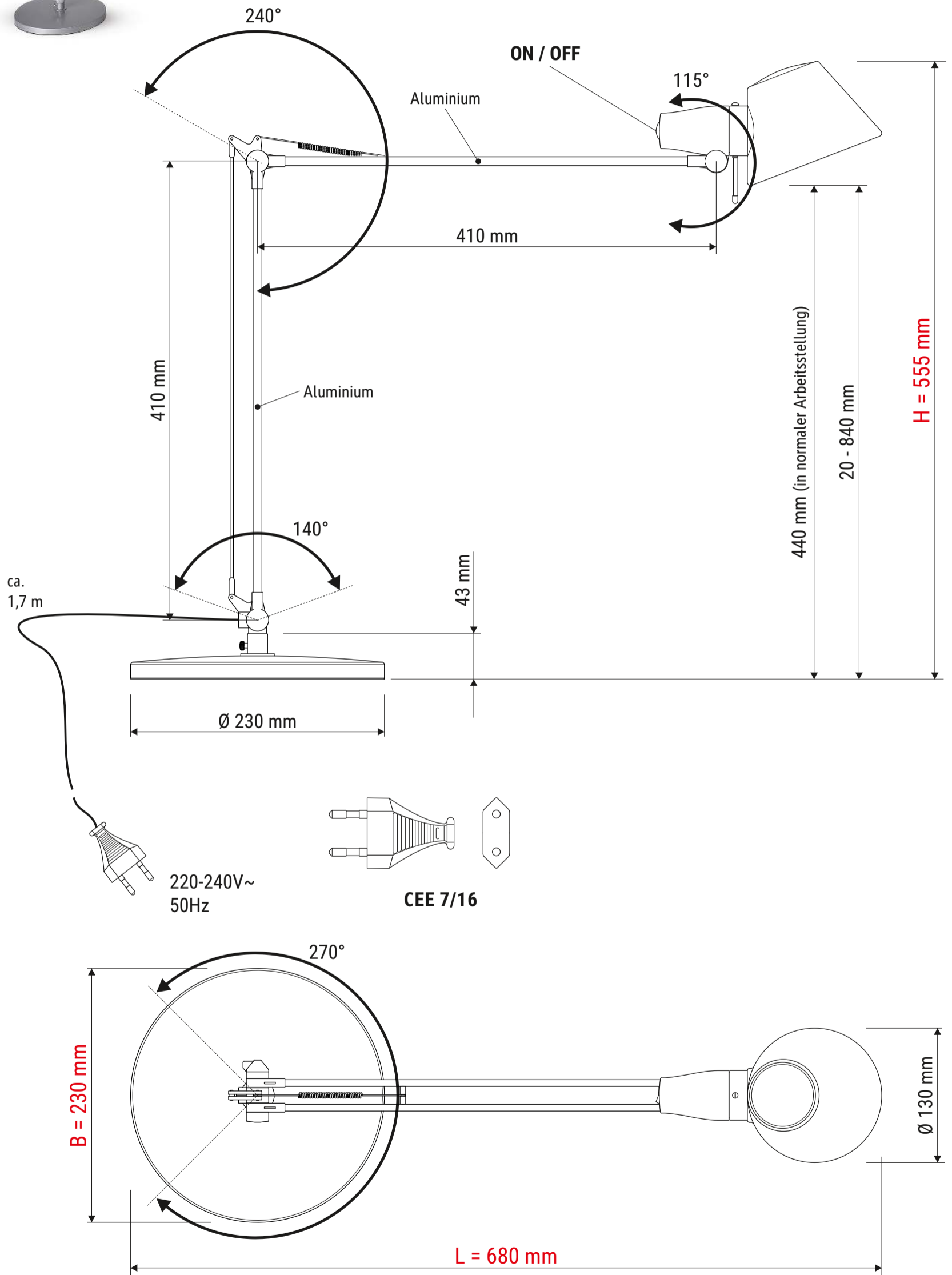

# Technisches Datenblatt / Technical Datasheet

## Art.-No. 82341



Abmaße Produkt: **L x B x H**  
 680 x 230 x 555 mm  
 (Arme senkrecht+waagrecht 90° zueinander)  
 Gewicht: 3,344 kg

Verp. Abmaße : L x B x H  
 505 x 255 x 125 mm  
 Gewicht kompl.: 3,948 kg