

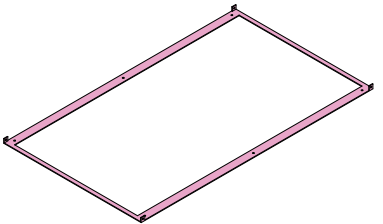

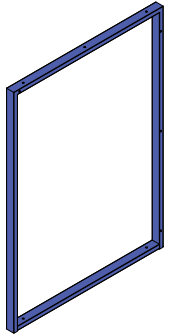

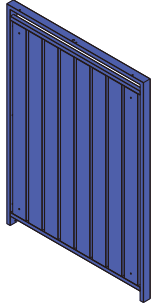
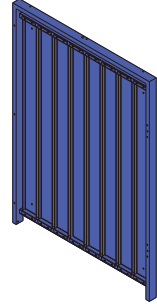
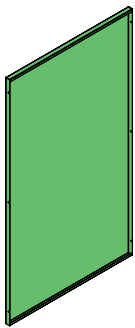
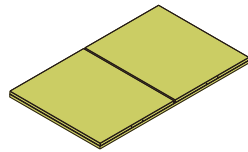

Ax1 	Bx1 	Cx1 	Dx1 	Ex2 		
Fx1 	Gx1 	Hx1 	Ix2 	Jx1 	Kx4 	Lx6 
Mx2 	Nx2 	Ox2 	Px4 	Qx6 	Rx16  M4x10mm	Sx10  M4x20mm
Tx9  M4x30mm	Ux30  M4x14mm	Vx2 	Wx4 	Xx4 	Yx1 	Zx1 

NOTAS: Si desea adquirir el cubo similar, utilice la piezas S,W,X.

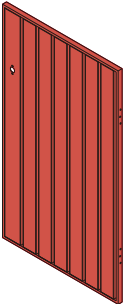
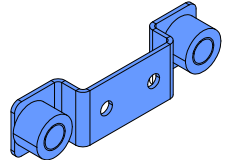
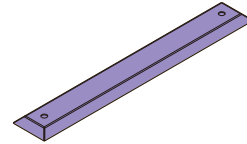
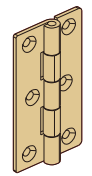
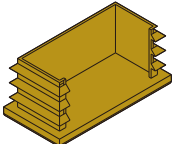
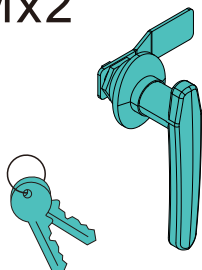
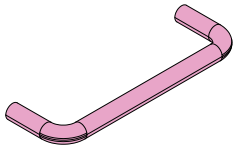
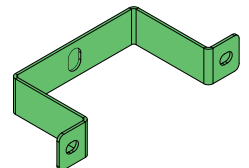
PASO1

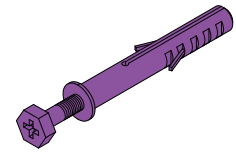
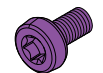
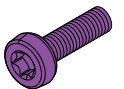
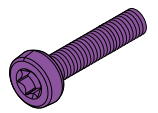
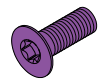
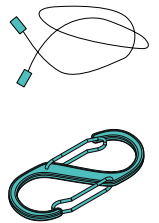

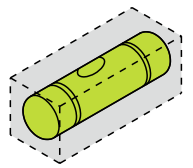
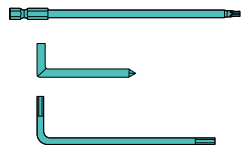
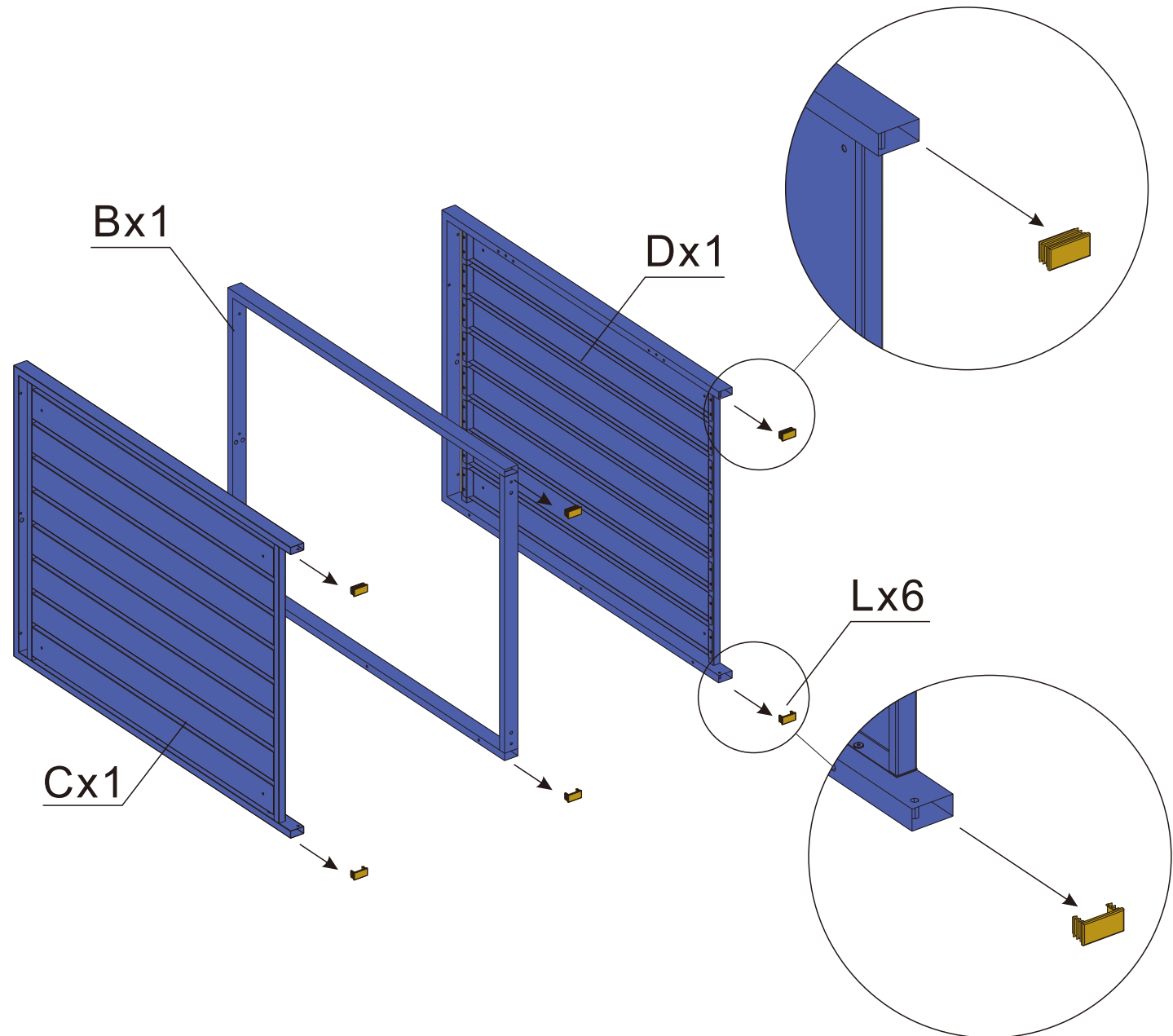
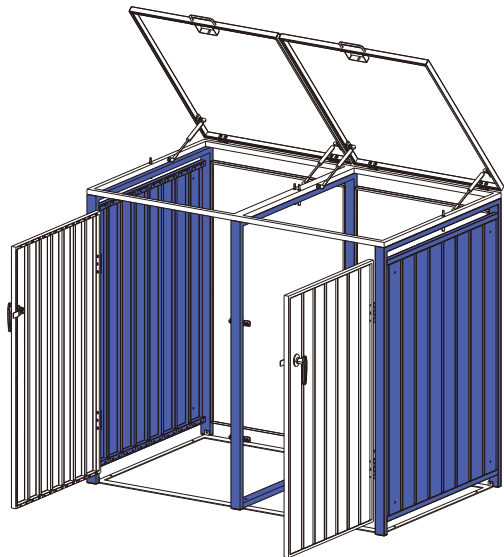
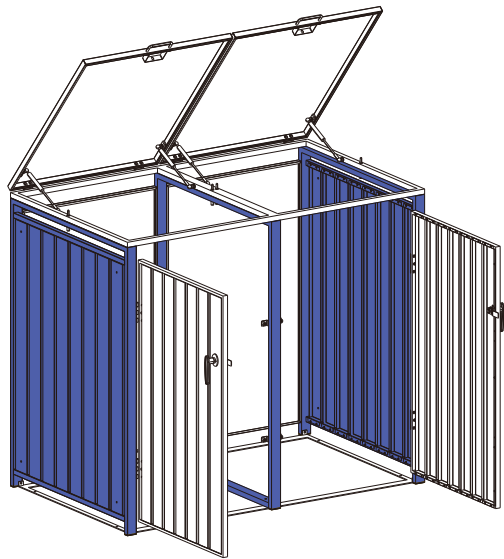
PASO2

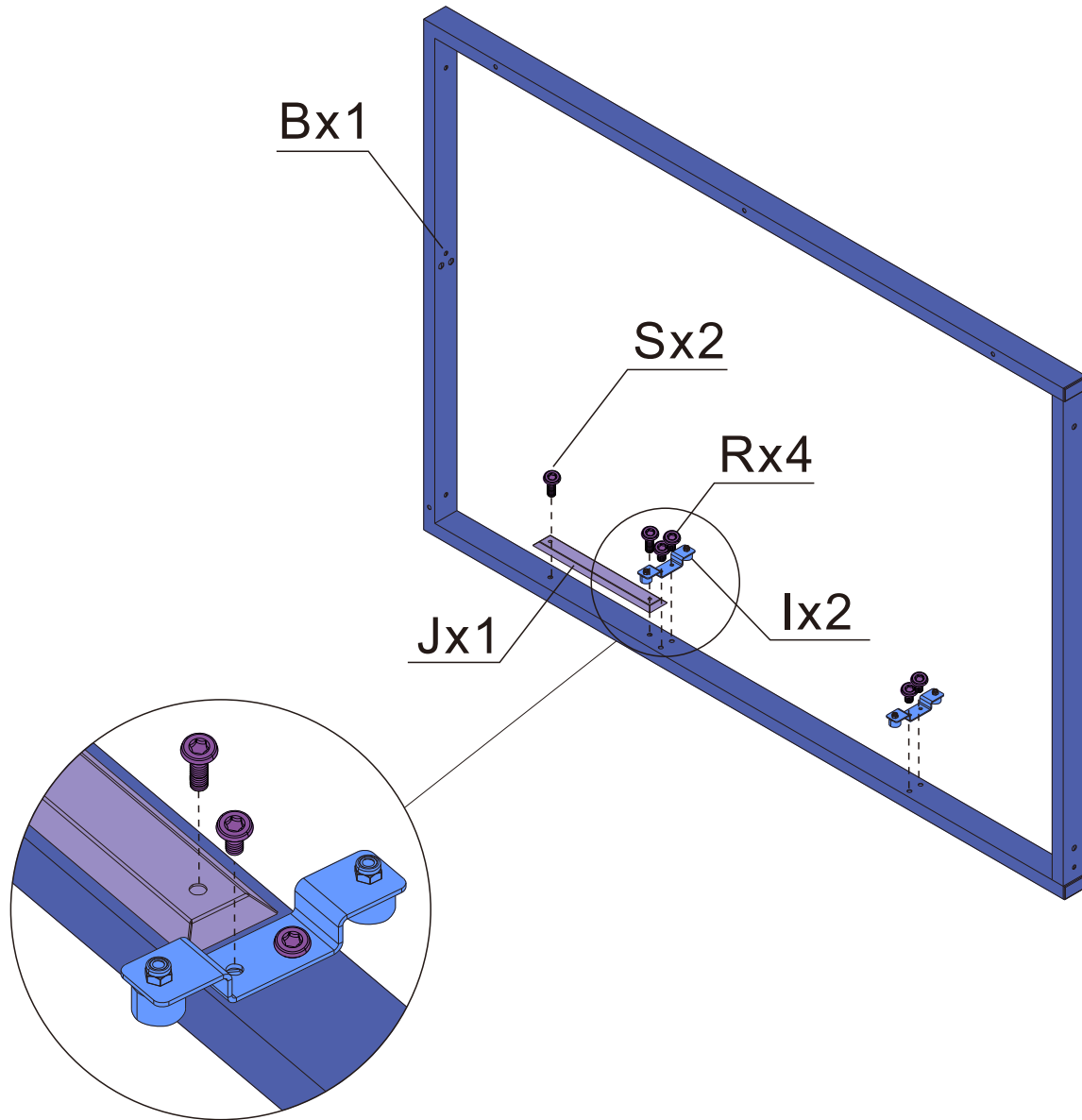
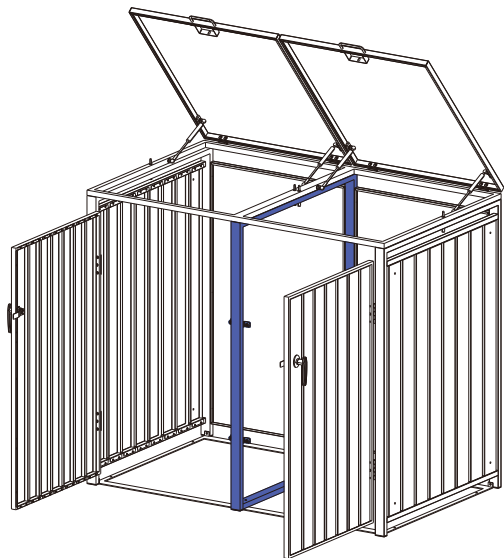
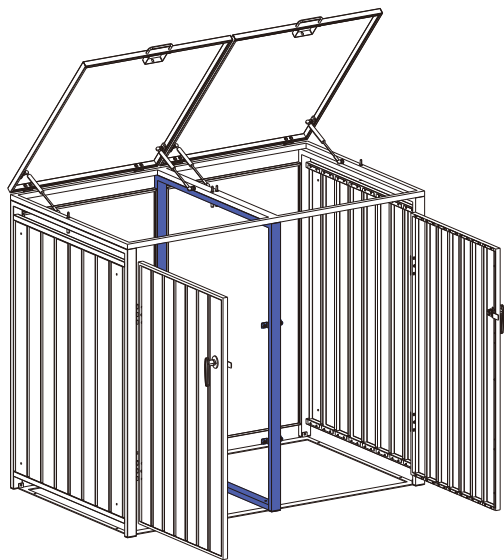

PASO3

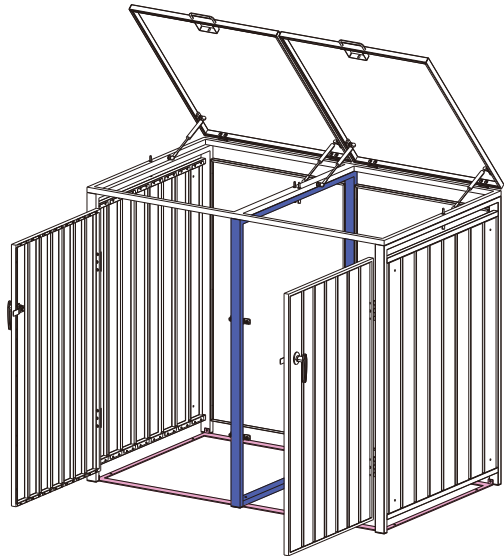
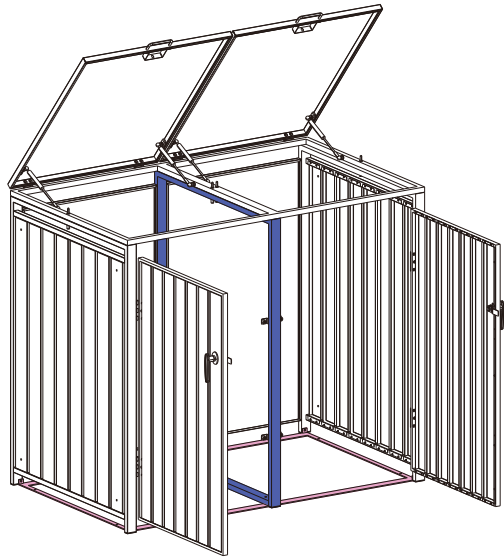

Bx1

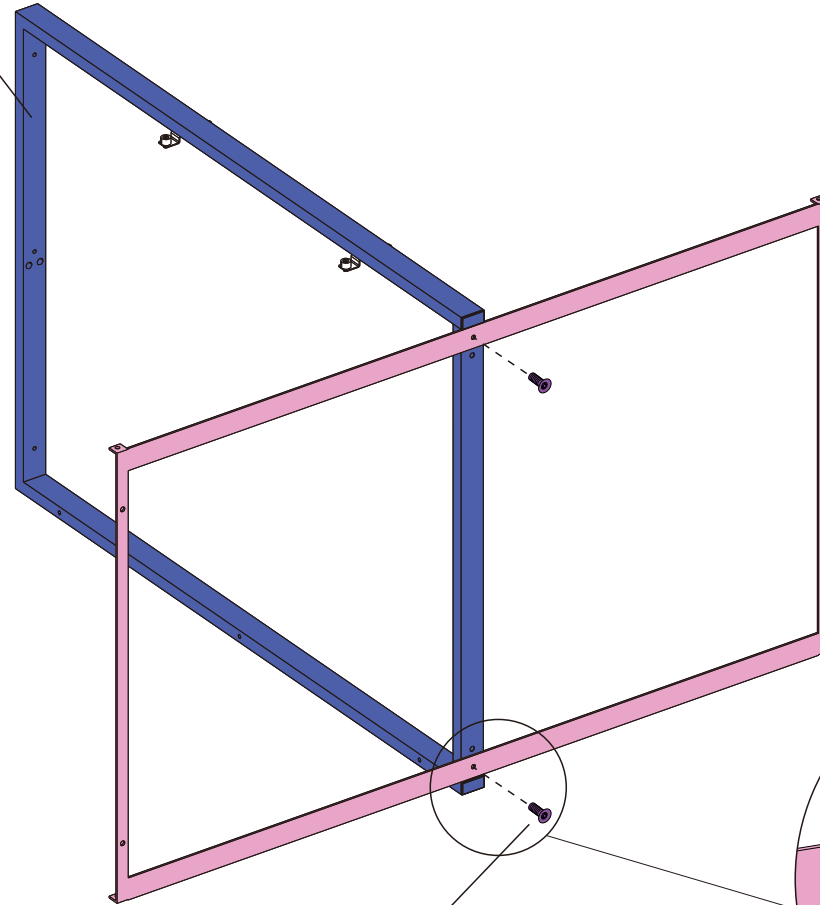

Ax1

Ux2

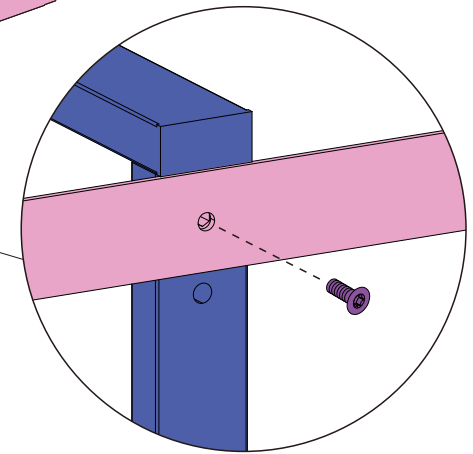

PASO4

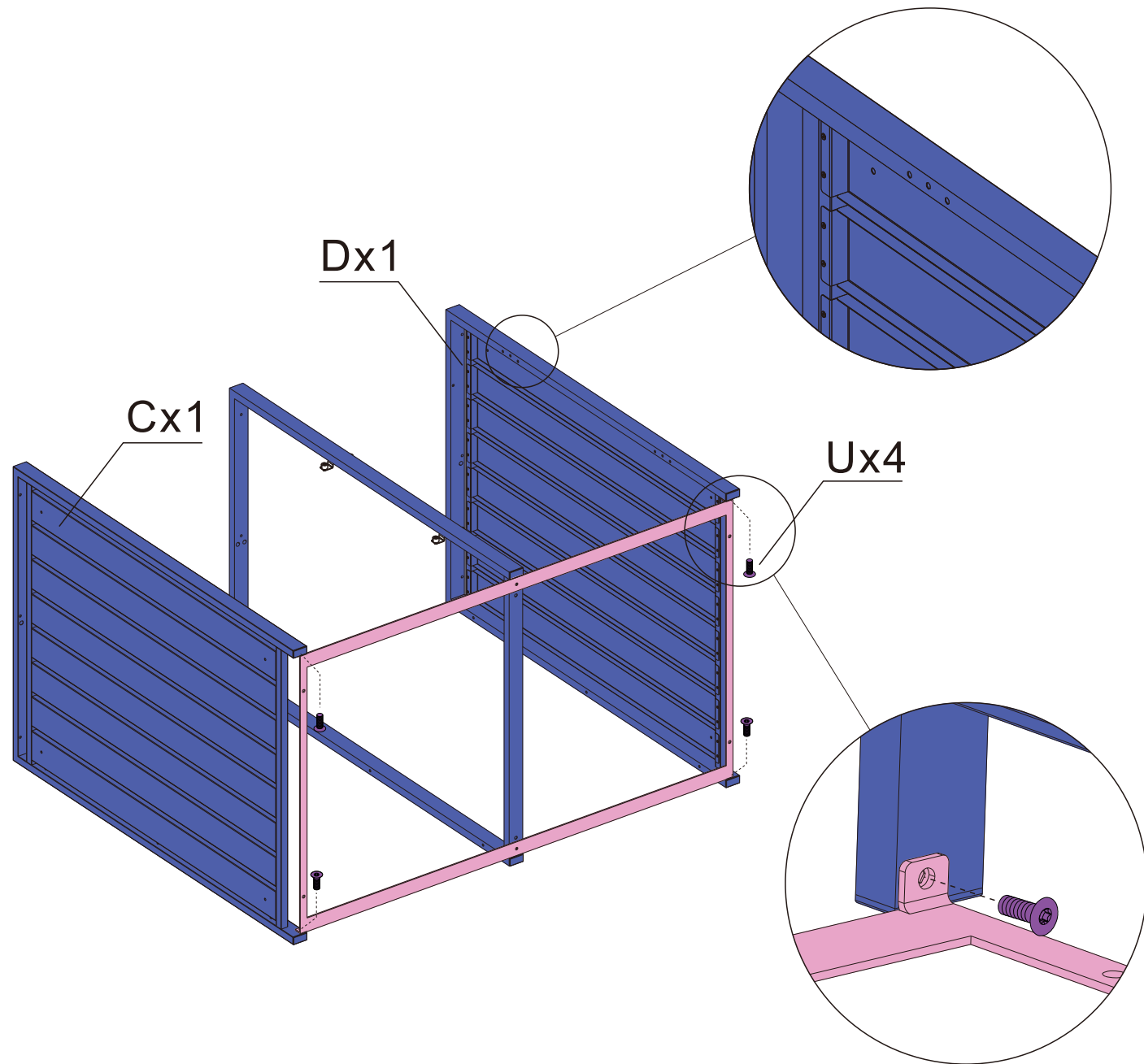
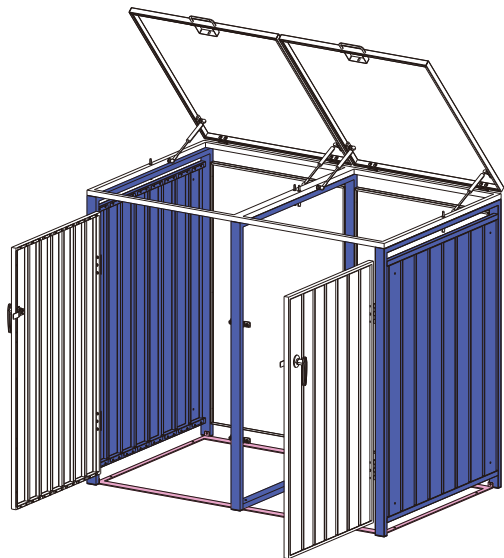
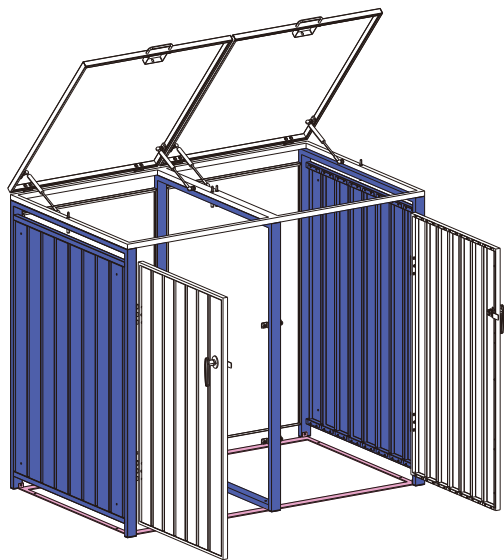

PASO5

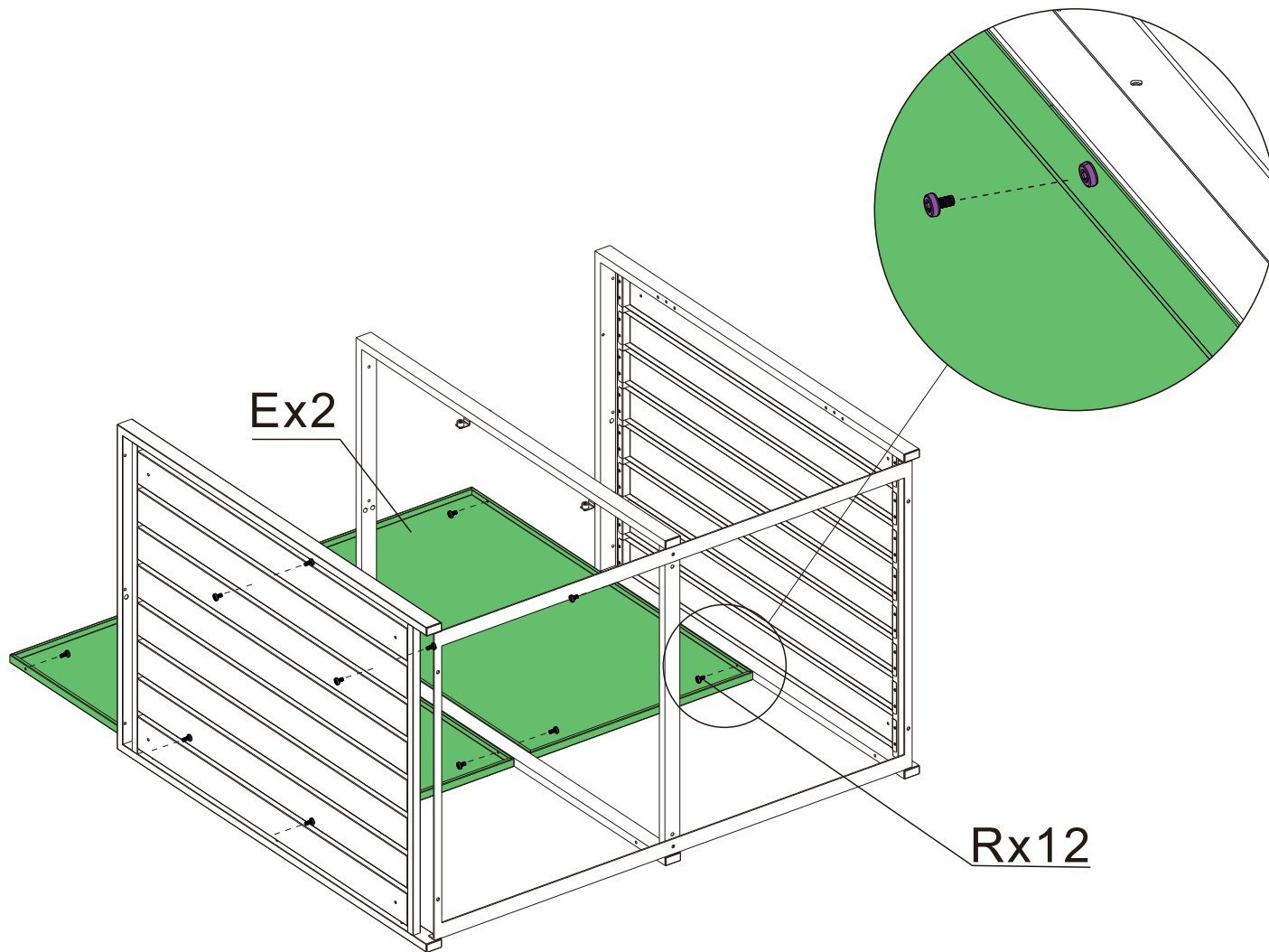
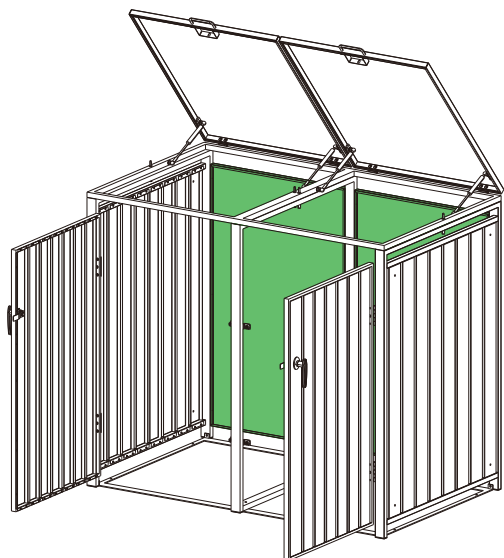
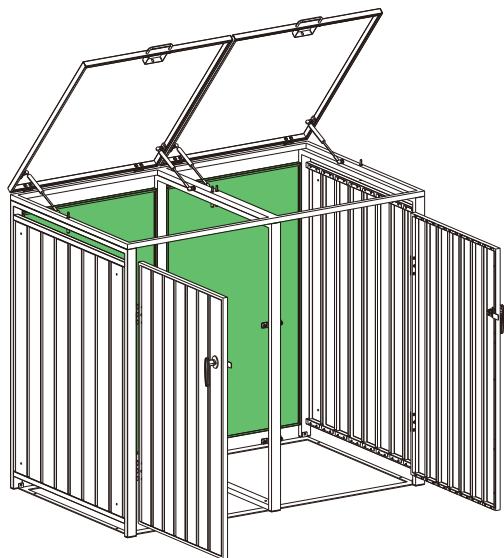

PASO6

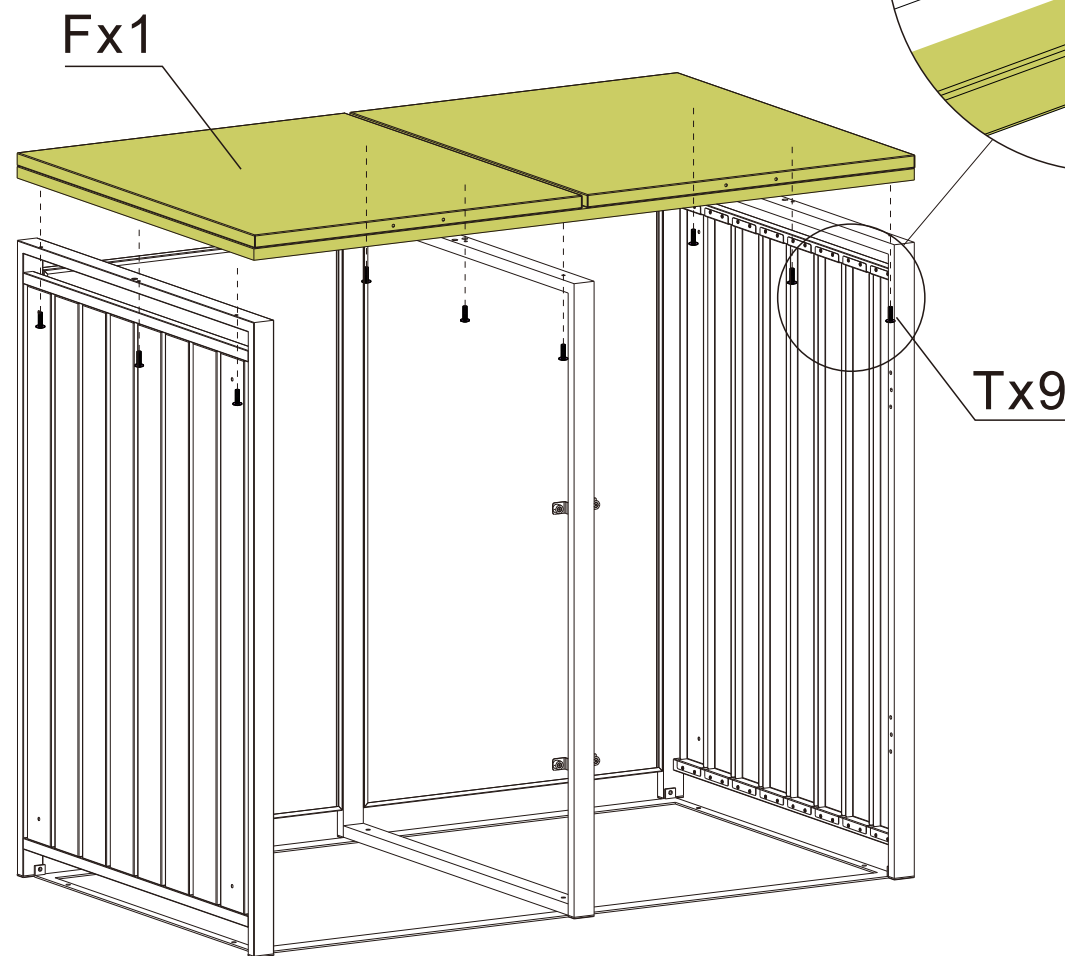
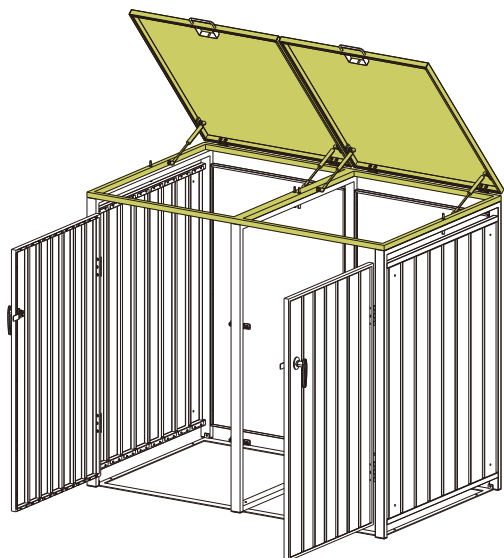

PASO7

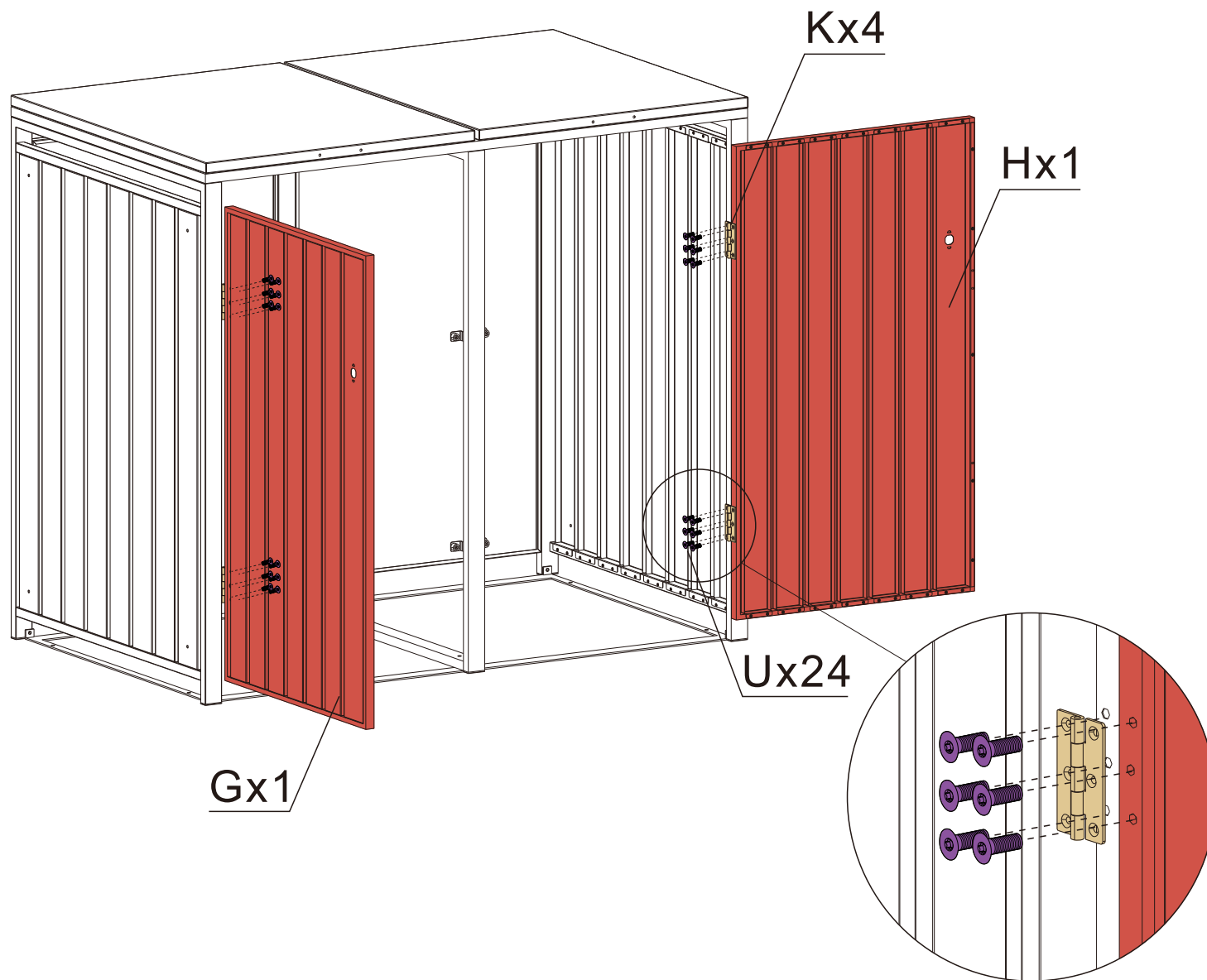
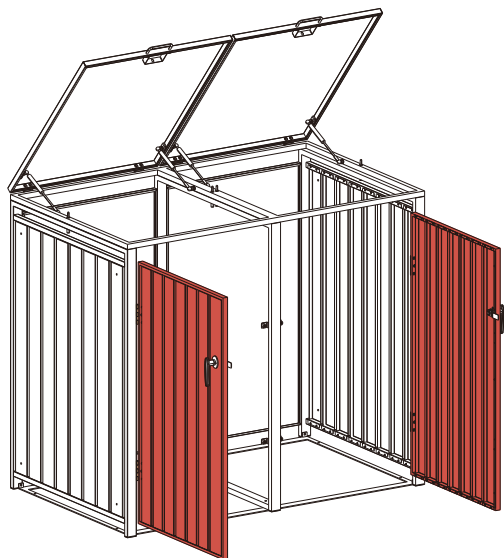

PASO8

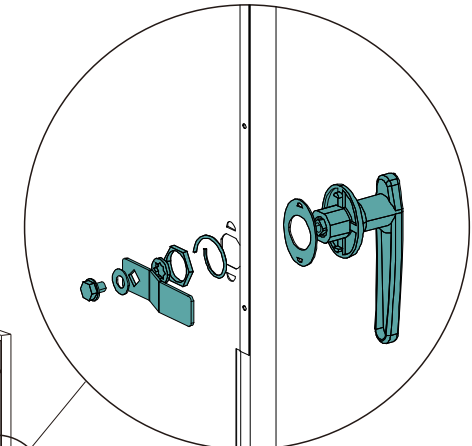
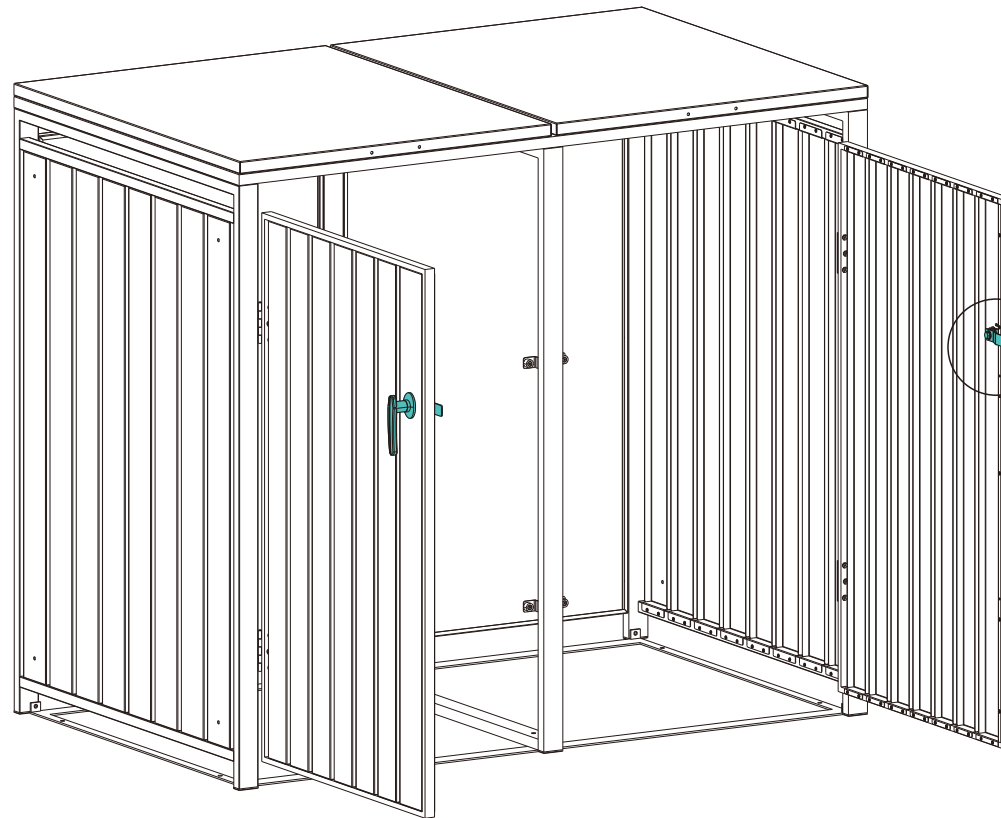
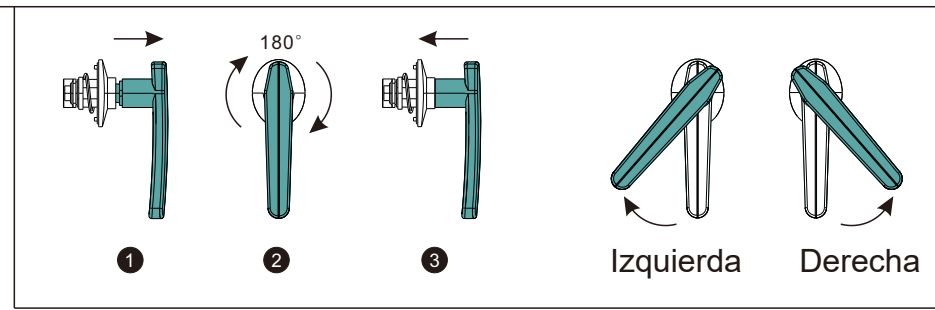
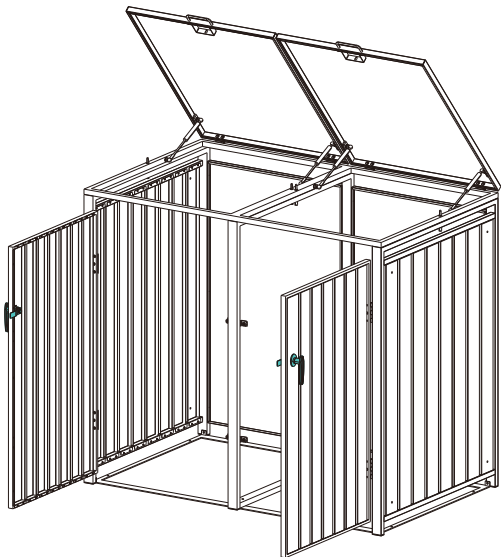
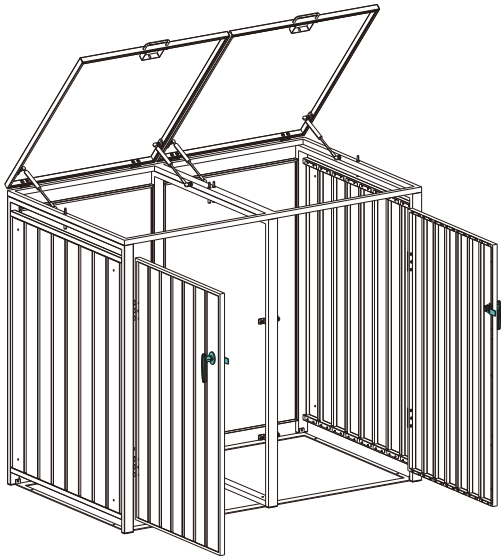

Mx2

PASO9

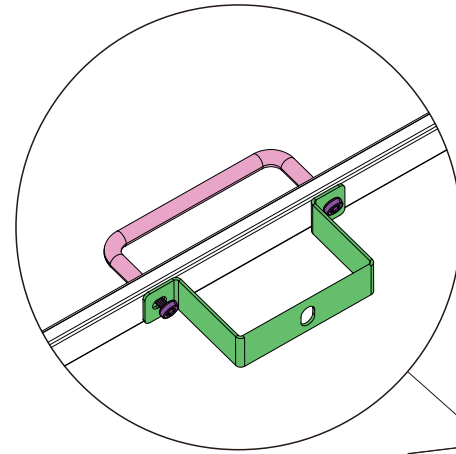
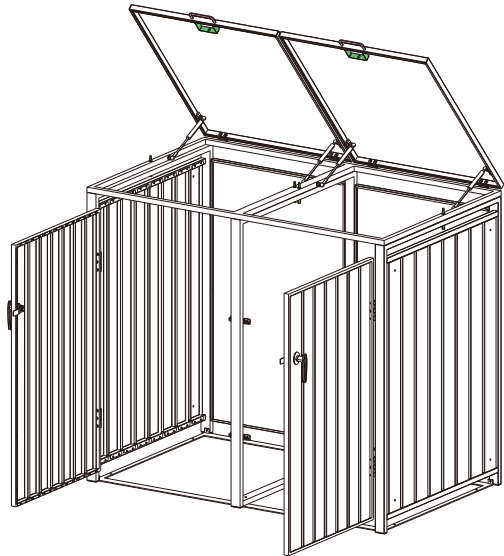

Nx2

Ox2

Px4

Sx4

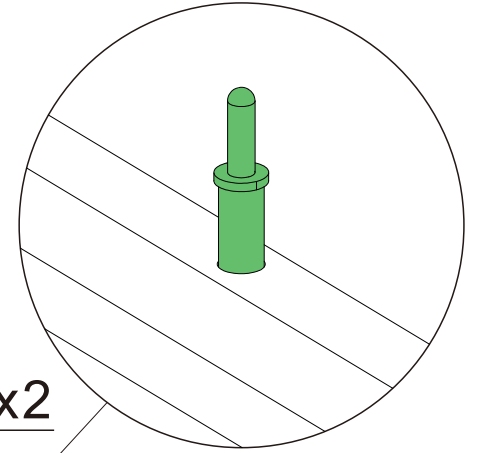
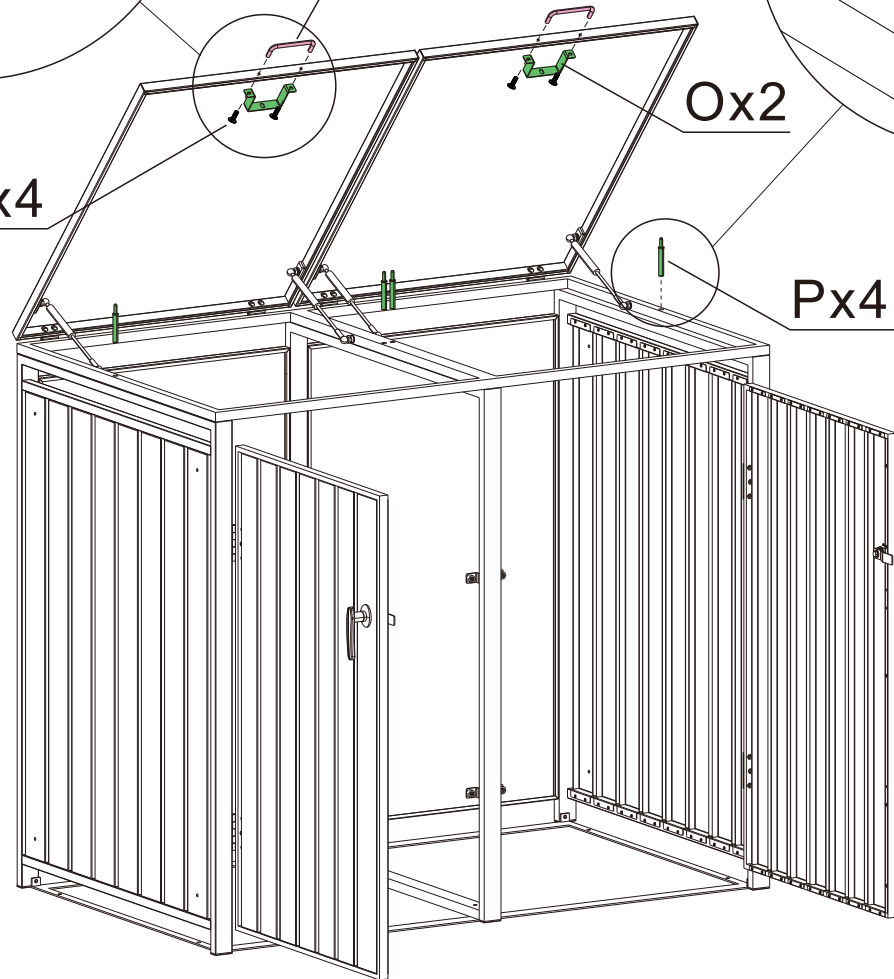

PASO10

