

Product Model

POW-LIO48100-16S

POW-LIO48200-16S

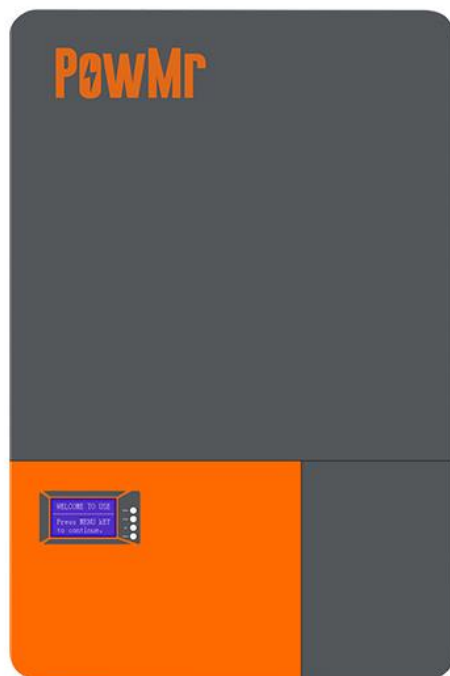

POWMr

Wall-mounted Lithium Iron Phosphate Battery

User Manual

Table of Contents

1 Overview.....	1
1.1 Scope	1
1.2 Intended Audience	1
1.3 Manual Usage.....	1
2 Product Introduction.....	2
2.1 Introduction.....	2
3 Safety Instructions.....	2
3.1 Labeling Explanation.....	2
3.2 Installation Tools	3
3.3 Precautions.....	4
4 Overview of Main Components.....	6
5 Product Introduction.....	7
5.1 Overview	7
5.2 Advantages.....	7
5.3 Product Appearance	8
5.4 Port Panel.....	9
6 Principle and Structure	11
6.1 Operating Principle	11
6.2 Connection Structure	11
7 Battery Installation and Wiring.....	12
7.1 Tool Preparation for Installation.....	12
7.2 Installation Preparation.....	12
7.3 Installation Notes.....	13
7.4 Installation Steps	13
7.5 Electrical Connection.....	16
8 LCD Screen Operation Guide	18
8.1 Button Overview	18
8.2 Screen Overview	18
9 Debugging.....	21
9.1 RS485 & CAN Port Definition	21

9.2 Upper Computer Software Operation Guide	22
9.3 ADS DIP Switch Definitions	25
9.4 Battery Parallel Connection DIP Switch Diagram	27
9.5 Power-On Sequence	29
9.6 Common Issues and Solutions	29
9.7 Inverter Matching Information	30
10 Maintenance	32
11 Technical Specifications	33

1 Overview

1.1 Scope

This user manual provides information, operating instructions, and maintenance guidelines for the POW-LIO48100-16S and POW-LIO48200-16S low-voltage residential energy storage battery series. The POW-LIO48 residential energy storage series is a lithium battery system developed by PowMr, designed to be compatible with various inverter brands available in the market.

1.2 Intended Audience

This manual is intended for professional technical personnel involved in the installation, operation, and maintenance of lithium batteries, as well as end-users seeking technical information.

1.3 Manual Usage

1. Before using the product, carefully review this user manual and keep it in a readily accessible location.
2. All information in this user manual, including images and symbols, is proprietary to PowMr. Unauthorized use of any part or all of the content is strictly prohibited for individuals outside the company.
3. Considering the potential for updates and corrections to the manual content, users are advised to use the provided documentation as a reference. For the latest user manual, please refer to the product documentation provided or contact customer service through the official website.

2 Product Introduction



2.1 Introduction

1. The POW-LIO48 residential energy storage series is a battery module developed by PowMr for low-voltage lithium battery systems, primarily applied in the field of residential energy storage. It can achieve high-precision multi-cell voltage and temperature acquisition.
2. The module adopts a passive balancing method, with a maximum balancing current of up to 300mA, improving the overall lifespan of the battery pack.
3. The module features external communication interfaces using CAN, RS485, and dry contact communication methods, allowing communication in parallel for up to 16 batteries.
4. Embedded BMS system effectively monitors phenomena such as over-temperature, over-voltage, and over-current, reducing the risk of battery damage or even fire, ensuring the safety of life and property.
5. This manual introduces the types, sizes, performance, technical characteristics, warnings, and precautions of lithium battery systems. This specification is only applicable to the battery systems provided by PowMr.

3 Safety Instructions













3.1 Labeling Explanation

To ensure user safety during product use, relevant labeling information with appropriate symbols is provided in this manual. The following lists symbols that may be used in this manual, so please read carefully.

Icon	Description
	Signifies a low-level potential hazard. Failure to avoid may result in minor or moderate injury to personnel.
	Indicates the presence of high voltage inside the battery module. Touching may lead to electric shock hazards.
	This is the ground protection port (PE). It should be securely grounded to ensure the safety of operating personnel.

3.2 Installation Tools

Prior to installation, prepare the following tools:

Category	Tools		
General Tools	Multimeter 	Protective gloves 	Insulated safety shoes 
	Protective clothing 	Safety goggles 	Antistatic wrist strap 
Installation Tools	Electric screwdriver 	Socket wrench 	Wire stripper 
	Phillips screwdriver (M4/M6) 	Electric drill 	Hammer 

3.3 Precautions

3.3.1 Manual Storage

1. This manual covers crucial information for the POW-LIO48 Home Energy Storage Series. Prior to operating the product, carefully read this manual as it provides essential assistance in acquainting you with the product.
2. Store this manual securely for the convenience of relevant installation and maintenance personnel to refer to during operations.
3. Strictly follow the descriptions in this manual when operating the PowMr Home Energy Storage Series to avoid equipment damage, injuries, property loss, and other potential issues.

3.3.2 Label Protection

1. Warning labels on the POW-LIO48 Home Energy Storage Series contain crucial safety operation information. It is strictly prohibited to intentionally tear or damage them!
2. The product has a nameplate on the casing, providing essential parameter information. It is strictly prohibited to intentionally tear or damage it!

3.3.3 Safety Warning Labels

When conducting installation, routine maintenance, inspections, etc., on the POW-LIO48 Home Energy Storage Series, to prevent unauthorized individuals from approaching, engaging in improper operations, or accidents, adhere to the following conventions:

1. Erect clear signage at the switch locations of the PowMr products to prevent accidents caused by accidental closing.
2. Set warning signs or establish safety warning tape near the operating area to prevent unrelated personnel from approaching.
3. After maintenance or inspection, conduct a thorough on-site safety check.

3.3.4 Personnel Requirements

1. Only personnel with relevant professional qualifications are allowed to perform various operations on this product.
2. Operating personnel should be thoroughly familiar with the composition and working principles of the entire POW-LIO48 Home Energy Storage Series system.
3. Operating personnel should be fully acquainted with the "User Manual" for this product.

3.3.5 Power-On Measurement



After the energy storage battery is installed, there is a high voltage present, and accidental contact with the positive and negative terminals may result in electric shock injuries. Therefore, when conducting power-on measurements, attention should be paid to the following:

1. Take necessary insulation protection measures (such as wearing insulated gloves).
2. Accompanying personnel must be present to ensure personal safety.

3.3.6 Measuring Instruments



When performing electrical connections and trial operations on the energy storage backup battery, and to ensure that electrical parameters meet requirements, relevant electrical measuring equipment such as multimeters, power meters, etc., should be used. Note the following:

1. Use measuring equipment with a suitable range that conforms to on-site working conditions.
2. Ensure the correct and standardized electrical connections of the instruments to avoid dangers such as electric arcs.

3.3.7 Maintenance and Inspection













When both the energy storage battery and the inverter are turned off, and electrical connections are confirmed to be disconnected, maintenance or inspection operations can be carried out on the energy storage battery cabinet. Pay attention to the following:

1. Ensure that the energy storage battery will not be accidentally re-energized.
2. Use a multimeter to ensure that the energy storage battery is completely de-energized.
3. For parts near potentially live components during operations, use insulating materials for insulation covering or grounding.
4. It is strictly prohibited to perform maintenance or inspection operations on live equipment!

When performing maintenance or inspection on equipment, it must be ensured that at least two personnel are present at the site. Maintenance operations can only be carried out after the equipment is safely de-energized, fully charged, or discharged.

4 Overview of Main Components

No.	Image	Name	Quantity
1		Battery	1
2		1.5-meter Red-Positive Power Line	1
3		1.5-meter Black-negative Power Line	1
4		1-meter Communication Cable	1
5		Product User Manual	1
6		Certificate of Conformity	1
7		Expansion Bolt	9
8		Wall Mount Bracket (For POW-LIO48100-16S)	1
8		Wall Mount Bracket (For POW-LIO4820-16S)	1
9		Warranty Card	1

5 Product Introduction

5.1 Overview

The POW-LIO48 household energy storage series lithium battery module integrates PowMr's high-capacity, high-safety lithium iron phosphate battery cells. It adopts a stacked design with advantages in footprint and vertical space utilization. The module incorporates a high-precision Battery Management System (BMS) unit, monitoring and collecting real-time data on voltage and temperature inside the module. This enables intelligent temperature control at the cell level and smart cell balancing, enhancing system efficiency and battery cycle life. The module features a shock-resistant structure within a cold-rolled sheet metal shell for high safety and reliability, meeting household standards. Additionally, the module is designed for high stability and disturbance resistance, ensuring the safe and reliable operation of the battery system.

5.2 Advantages

- The positive electrode material of the battery is lithium iron phosphate (LiFePO₄) material, which has good safety performance, has a cycle life of more than 6,000 times.
- The high-performance intelligent management system is adopted to realize comprehensive state control of battery charging, discharging, floating charging and hibernation, and multi-level protection is set for voltage, current, temperature, etc., so that the battery is always in an ideal state.
- It has a comprehensive monitoring system to monitor the voltage, current, temperature, capacity and working status of the battery.
- The system adopts an intelligent design method to meet the four remote control standards of the national standard: telemetry, remote signaling, remote control, and remote adjustment.
- Built-in intelligent balance module to ensure the capacity consistency of the battery pack during long-term use and prolong the service life.
- The control panel includes status display and alarm devices, which can visually see the working status and alarm information of the battery.
- The system has its own intelligent thermal management device, which can work in a wide temperature range.

5.3 Product Appearance

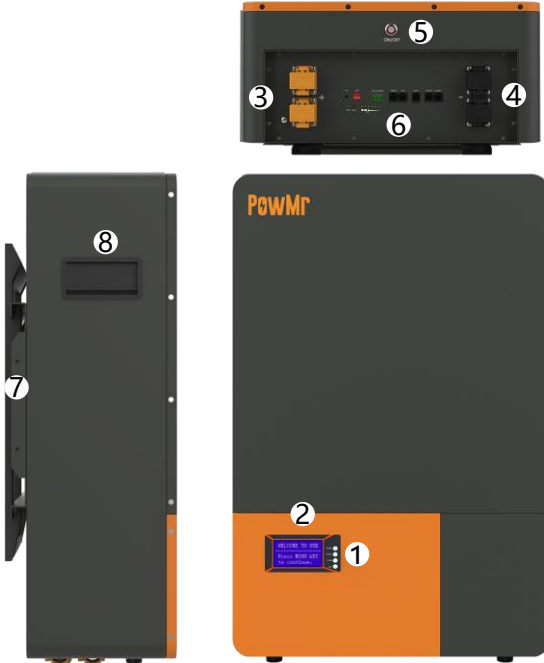

1	Function Keys	5	Power Switch
2	LCD Screen	6	Bottom Port Panel
3	M6 Positive Terminal	7	Installation Backplate
4	M6 Negative Terminal	8	Handle

5.4 Port Panel

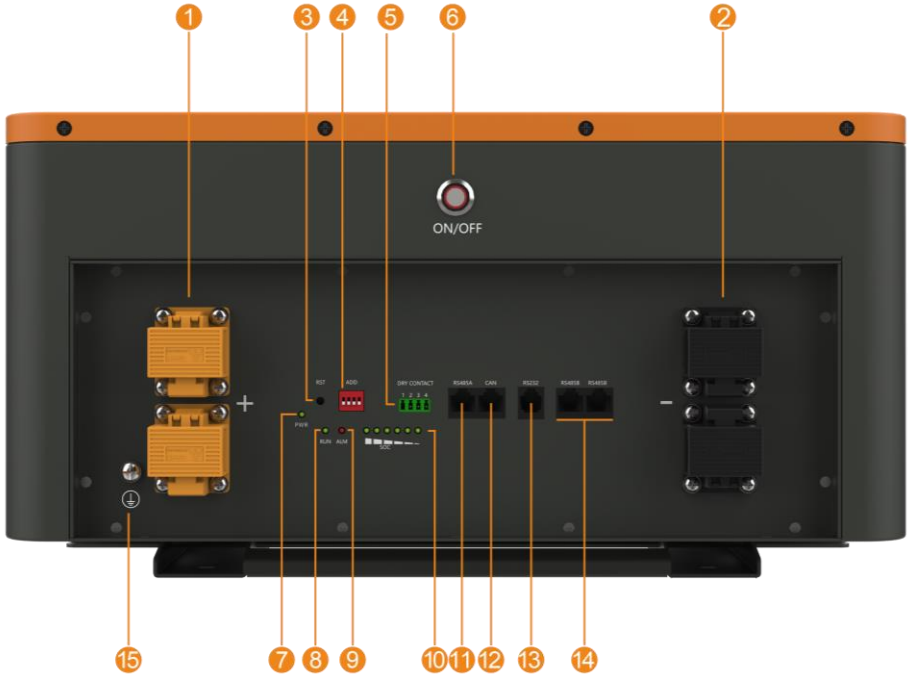

No.	Name	Function	Notes
1	Positive Terminal Port (+)	Battery Positive Output	
2	Negative Terminal Port (-)	Battery Negative Output	
3	Reset Button (RESET)	Battery Reset	Briefly tap and release within 1-3 seconds.
4	DIP Switch (ADS)	Define Battery Communication Code	
5	Dry Contact	Dry Contact Communication	1. Dry Contact 1 - PIN1 to PIN2: Normally open, closed during fault protection;

			2. Dry Contact 2 - PIN3 to PIN4: Normally open, closed during low battery alarm.
6	ON/OFF	Power Switch	Used for powering on or off the battery supply.
7	Power Light (PWR)	Power Indicator Light	The indicator light lights up after powering on.
8	Operation Light (RUN)	Battery Operation Indicator Light	The signal light illuminates once the battery is operating normally.
9	Alarm Light (ALM)	Battery Alarm Indicator Light	
10	Capacity Light (SOC)	Battery Capacity Indicator Light	
11	RS485A	485 Communication Interface	Communication with inverter via RS485
12	CAN	CAN Communication Interface	Communication with inverter via CAN
13	RS232	1. Monitor batteries and modify parameters. 2. Perform software upgrades.	
14	RS485B	Communication between batteries.	Functions are the same, no distinction between left and right.
15	Ground Terminal Port	Battery Ground	

6 Principle and Structure

6.1 Operating Principle

Working principle for Residential Lifepo4 Battery Energy Storage System: Connect battery pack in parallel to the DC output end of the inverter of the energy storage device. When the mains power supply is normal, the inverter module works normally to supply power to the equipment (the load in the figure) and charge the battery pack; when the utility power and photovoltaic power are cut off, the battery pack provides uninterrupted power supply to the inverter to ensure the normal operation of household electricity; When power is turned on again, the battery pack is charged while power is restored to the household loads.

6.2 Connection Structure

The connection diagram of residential lifepo4 battery energy storage system is shown in Figure below:

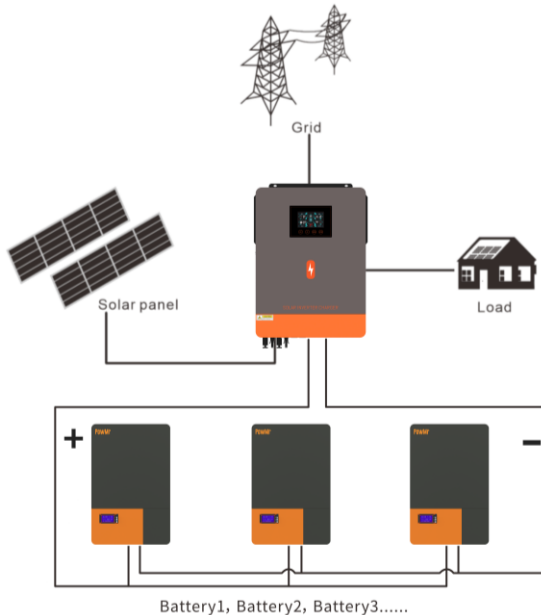

7 Battery Installation and Wiring

The following table outlines the operational procedures:

Step No.	Name	Definition
1	Turn off power supply	The system should be powered off, to ensure that there is no electric in installation process.
2	Mechanical installation	1. Mounting lugs installation
		2. Battery fixed installation
3	Electrical installation	1. Grounding cable
		2. Power cable installation
		3. Connecting equipment installation
		4. Communication cable installation
4	Electrical commissioning	Power system commissioning

7.1 Tool Preparation for Installation

Tools Required: Electric drill, hammer, wrench, M8*60 expansion bolt, Phillips screwdriver, multimeter, insulated gloves, Ethernet cable, power cable.

7.2 Installation Preparation

◇ Safety Regulations

The installation, operation and maintenance of LiFePO₄ Battery Energy Storage System should only be carried out by trained and qualified professionals. Before installation and use, please read the safety precautions and related operating procedures of this product carefully. The installation process must strictly abide by the following safety regulations and local safety regulations, otherwise it may cause personal injury or product damage.

- Please ensure that the inverter connected to the battery is a qualified power system;
- When installing the battery, please ensure that the power system is turned off and the battery pack is turned off;
- All power-saving cables must have corresponding insulation measures, and it is strictly forbidden to expose the power cord;
- Ensure that the battery and the power system are reliably grounded during installation.

7.3 Installation Notes

When begin to install the battery system, you should pay attention to the following matters:

- Installation space and load bearing. Make sure that there are sufficient fixed components to install the battery system, and to ensure that the battery mounting bracket or the cabinet be strong enough to bear the weight.
- Cable specifications. To ensure that the use of the connection of the power supply line can meet the maximum current requirements of equipment operation.
- Project layout. Ensure the whole construction process of power equipment, batteries and other reasonable layout.
- Wiring layout. Ensure that the wiring reasonable, orderly; and consider the moisture-proof, corrosion prevention.
- The whole installation process should wear anti-static wristband.
- The installation site should be at least two or more peoples to operate.
- Please ensure the installation site safe before installation.

7.4 Installation Steps

Below are the steps for quick wall-mounted installation:

- Select a suitable solid wall with a thickness greater than 150mm;
- Leave approximately 200mm clearance around the left, right, top, and bottom of the battery to ensure sufficient airflow around the battery;
- Secure wall bracket A to the battery using 8 dedicated screws;
- Refer to the fixing distance of the wall-mount bracket B bolts, and mark the hole position on the wall;
- Drill 6 holes according to the hole position, the depth is ≥ 80 mm;
- Mount the M8 expansion bolts in the upper holes and screw on the nuts;
- Fix the mounting bracket on the wall with expansion bolts;
- Under the condition of keeping the battery vertical, raise the battery to a position slightly higher than the mounting bracket, and hang the battery on the mounting bracket.

Step 1. Interruption Of Power Supply

Before installation, please ensure the battery is powered off, at the same time, shutdown the equipment which need to connect to the battery.

Step 2. Machinery Installation

1. Installation of the brackets. Mount the wall bracket securely onto the wall, then hang the battery onto the wall bracket. Ensure that the installation surface is solid and reliable, and that the battery is securely mounted.

Note: The POW-LIO48100-16S and POW-LIO48200-16S wall brackets differ in structure, but the wall mounting principle remains consistent.



POW-LIO48100-16S



POW-LIO48200-16S

2. Expansion bolt installation diagram.

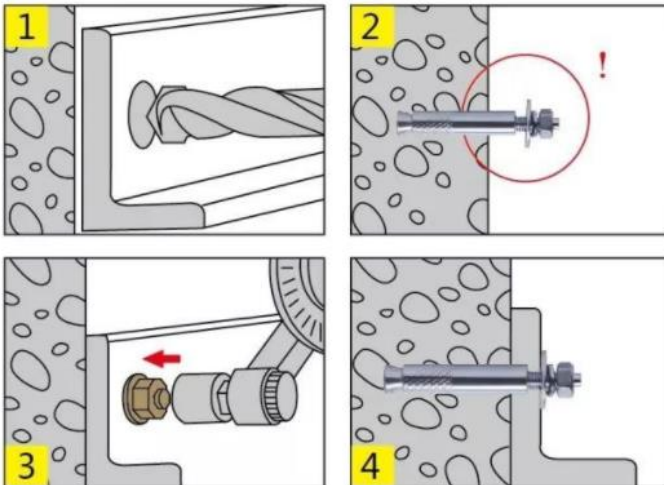

3. Fixed battery installation. Mount the battery on the wall and ensure that the battery is securely and safely installed.

NOTICE:

1. In order to avoid electric shock or other injuries, check whether the existing electronic plumbing installation is compliant before drilling.
2. The battery is heavy, please handle it with care, so as not to damage the product or injure the installer.

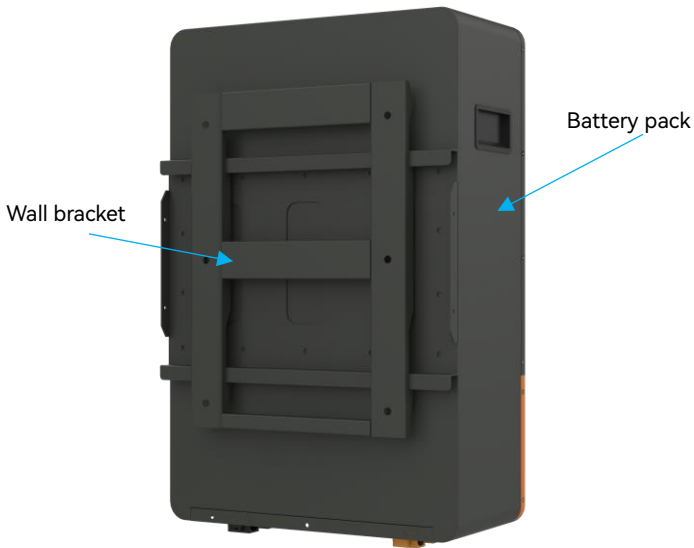

7.5 Electrical Connection

➤ Single Unit Wiring:

- Connect the positive and negative terminals of the battery to the positive and negative terminals of the inverter using the power cable.
- Complete the battery's grounding connection by using the ground wire.
- Connect the RS485A (or CAN) port of the battery to the RS485 (or CAN) communication port of the inverter using the communication cable.
- If used as a single unit, set the ADS dip switch to 1. Refer to section 9.3 for dip switch rules.

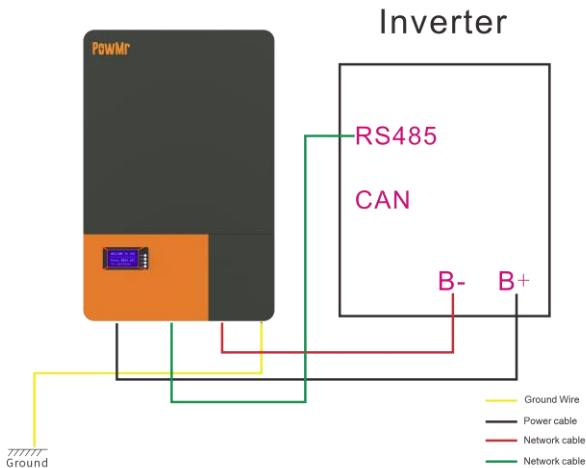

➤ Parallel Wiring:

- Step 1. If multiple batteries are used in parallel, manually press the low-voltage switch (ON/OFF) first. Use a multimeter to check if the voltage of each battery is consistent. If consistent, turn off the batteries and proceed with cable connections, as shown in the schematic diagram (using two batteries in parallel as an example).

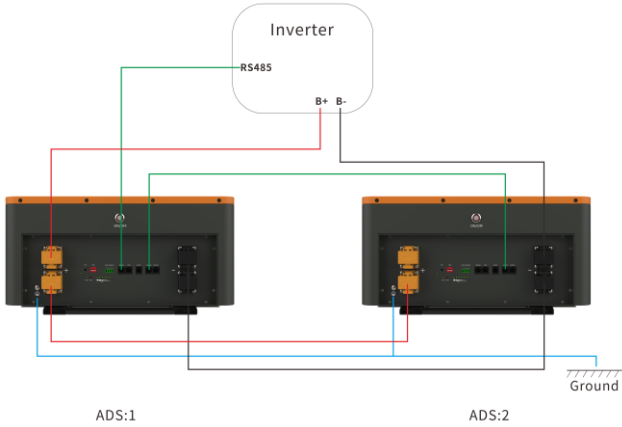

- Step 2. Connect the positive terminal of the battery using the power cable, and then connect the negative terminal of the battery using the power cable.
- Step 3. Connect the RS485B communication interface of adjacent batteries with communication cables (RS485B battery parallel ports have the same functionality and are not distinguished).
- Step 4. Connect the ground wire to the grounding point for all batteries. There is a ground symbol in the lower-left corner of the battery; attach the ground wire terminal to this point.
- Step 5. Use a standard Category 6 cable. Connect one end to the RS485A (or CAN) communication interface of the battery and the other end to the RS485 (or CAN) interface of the inverter (Note: the pin definition of the inverter communication should match that of the battery; refer to section 9.3 for battery-to-inverter pin definitions).
- Step 6. Connect the positive terminal (+) of the first battery to the positive terminal interface of the inverter using the power cable. Then, connect the negative terminal (-) of the last battery to the negative terminal interface of the inverter using the power cable.

Note

- The battery directly connected to the inverter via the communication cable is defined as the host. The host dip switch is set to 1 and needs to be switched before powering on.
- Define dip switches for other batteries sequentially from 2 to 15. Avoid duplicating dip switch settings to 1.

8 LCD Screen Operation Guide

You can scan the QR code on the right to view the LCD display screen operation guide.



8.1 Button Overview



Button	Description
MENU	Enter the settings menu
ENTER	Enter the next-level menu
UP	Switch to the next option
ESC	Return to the previous menu

8.2 Screen Overview

Level 1 Menu	Level 2 Menu	Level 3 Menu	
Battery Basic Information	Battery Pack Voltage	/	
	Charge/Discharge Current	/	
	Cell Temperature >>		1 st group cell temperature
			2 nd group cell temperature
			3 rd group cell temperature
		4 th group cell temperature	

		Protection board temperature	
		Ambient temperature	
	Cell Voltage >>	Displays the voltage of 16 individual cells separately.	
	Cell Capacity >>	SOC: State of Charge	
		FCC: Full Charge Capacity	
		RM: Remaining Capacity	
		CC: Charge Cycles	
	BMS Status	Battery Operating Status (Auto Display)	IDLE: Idle State
			CHG: Charging State
			DCH: Discharging State
Protection Records		SCP: Short Circuit Protection	
		O/UTP: Over/Under Temperature Protection	
		OCP: Overcurrent Protection	
		UVP: Undervoltage Protection	
		OVP: Overvoltage Protection	
Current BMS Status		OT: Over Temperature	
		OTP: Over Temperature Protection	
		OV: Over Voltage	
		OVP: Over Voltage Protection	
		UV: Undervoltage	
		UVP: Undervoltage Protection	
		OC: Overcurrent	
	OCP: Overcurrent Protection		

		SCP: Short Circuit Protection
		Failure: Fault
Parallel Settings	Current Communication Protocol	Current CAN Protocol
		Current 485 Protocol
	CAN Protocol Settings	PACE, PYLON, GROWATT, VICTRON, SE, LUXPOWER, SRD, SMA, GOODWE, STUDER, SOFAR, PV, JINLANG, DIDU, SENERGYINV, TBB_LITHIUM, PYLON_V202, GROWATT_V109, MUST_V202, AFORE, MEGAREVO, SUNSYNK, PYLON_V206
	485 Protocol Settings	PACE_MODBUS, PYLON, GROWATT, VOLTRONIC, SE, LUXPOWER, LUXPOWER_V01, LUXPOWER_V03, WOW, PYLON_F, XIONGTAO
System Settings	Baud Rate	9600
	Version Number	It depends on the batch.

9 Debugging

9.1 RS485 & CAN Port Definition

1. Definition of RS485A port (default baud rate 9600bps) for communication between the battery and the inverter.

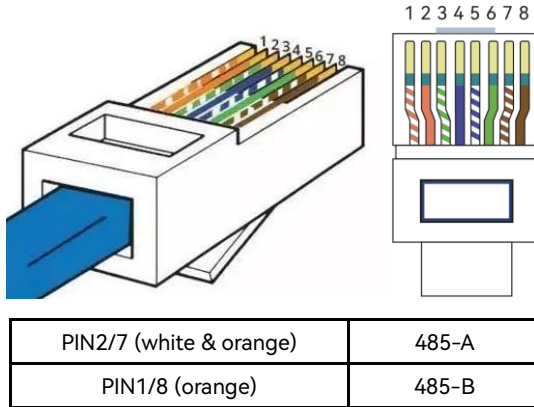

Note:

- The default RS485 protocol for the battery is set to Pylontech RS485 (V3.5) protocol. If compatibility with other inverters is needed, it is necessary to communicate through RS232 with the host computer to change the default protocol.

2. Definition of CAN port (default baud rate is 500K) for communication between the battery and the inverter.

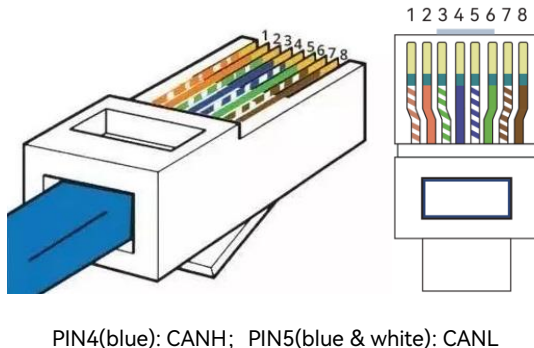

Note:

- The battery is factory-set with the default CAN protocol, defaulting to Pylontech CAN protocol. If compatibility with other inverters is required, it is necessary to communicate through RS232 with the upper computer to change the default protocol.

Tip:

- For battery and inverter communication, choose either RS485 or CAN.

9.2 Upper Computer Software Operation Guide

Modifying Battery Parameters and Selecting Inverter Protocol via RS232 Upper Computer

➤ Tools

- Computer
- USB to RS232 Cable
- Monitoring Software: Pbms Tools HS1.0.9

NOTICE

- This guide applies to Pbms Tools HS1.0.9. For other software versions, please contact your supplier for the appropriate guide.

➤ Operating Steps

1. Connect the computer to the battery using a USB to RS232 cable. Plug the USB end into the computer's USB port and the other end into the battery's RS232 port.
2. Download and unzip the software package on the computer.
3. Open the extracted folder and select the application, as shown below:

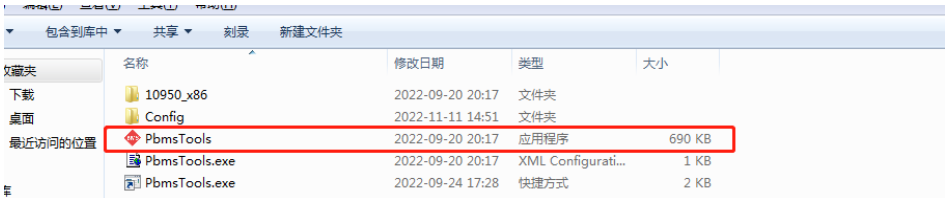

4. Double-click the above icon to enter the monitoring interface, as shown below:

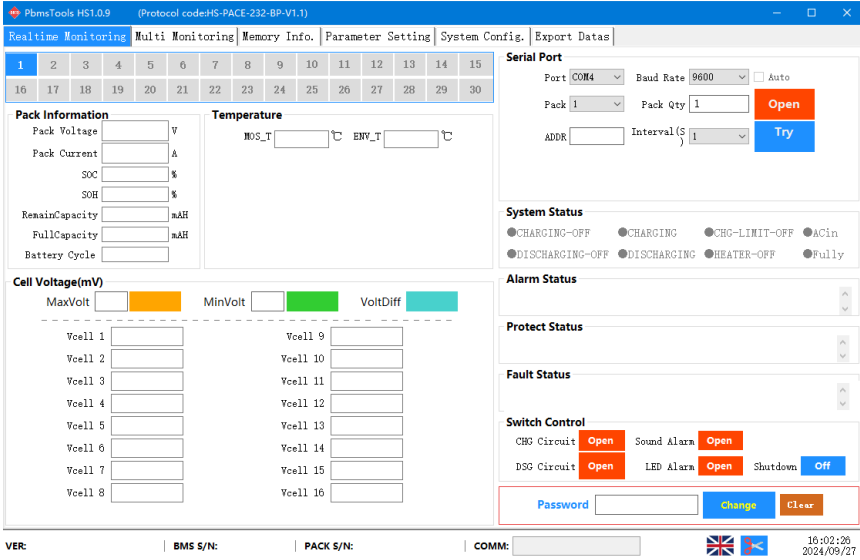

5. After entering the monitoring interface, click on the top right to open the serial port. Once communication with the battery is established, the left side will display real-time battery information, and the status bar in the lower right will turn green.

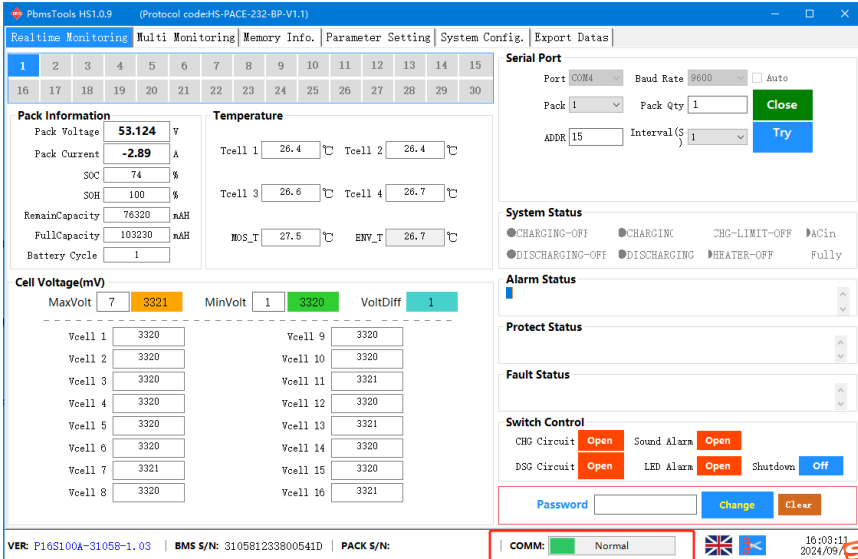

- After successful communication, enter the password "Pz#188178" in the lower right password status bar. Upon correct input, the status bar will turn green.

- Left-click on "System Config", enter the password "Pz#168178" in the inverter protocol section, and then click "Read" to view the current protocol and protocol type.

8. Click “CAN Protocol” or “RS485 Protocol” to select the corresponding inverter communication protocol, then click “Write” to change the battery BMS communication protocol and establish communication with the inverter.

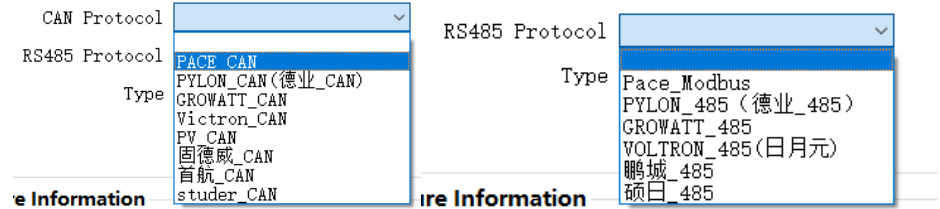

9. If the write fails, it indicates that the BMS does not include this inverter protocol, and a program upgrade is required. If the write is successful, click "Read" again to verify the selected protocol.









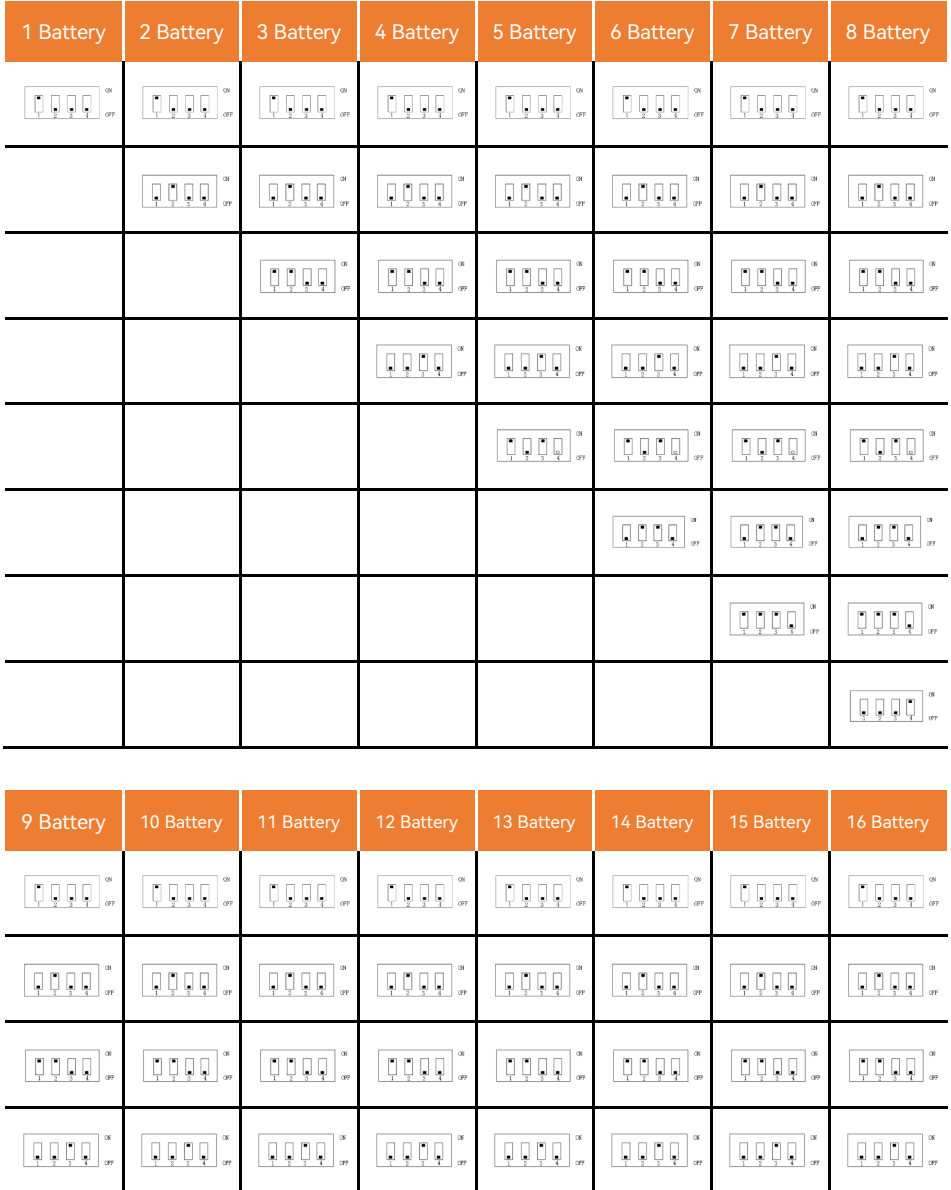



























































9.3 ADS DIP Switch Definitions

Address	DIP Switch Position				Illustration
	#1	#2	#3	#4	
0	OFF	OFF	OFF	OFF	
1	ON	OFF	OFF	OFF	
2	OFF	ON	OFF	OFF	
3	ON	ON	OFF	OFF	
4	OFF	OFF	ON	OFF	
5	ON	OFF	ON	OFF	
6	OFF	ON	ON	OFF	

7	ON	ON	ON	OFF	
8	OFF	OFF	OFF	ON	
9	ON	OFF	OFF	ON	
10	OFF	ON	OFF	ON	
11	ON	ON	OFF	ON	
12	OFF	OFF	ON	ON	
13	ON	OFF	ON	ON	
14	OFF	ON	ON	ON	
15	ON	ON	ON	ON	

9.4 Battery Parallel Connection DIP Switch Diagram







9.5 Power-On Sequence

After the completion of the connections between the inverter, battery, and mains power, start each battery one by one. Then, turn on the inverter. After the battery startup, check if the communication between the inverter and the battery is normal. If the battery data is successfully uploaded to the inverter, it indicates successful communication between the inverter and the battery.

9.6 Common Issues and Solutions

No.	Fault Symptoms	Cause Analysis	Solution
1	No DC Output	Battery Voltage Too Low, Protection Activated	Startup after Charging Activation
2	Short Power Supply Time	Insufficient Battery Capacity or Failure to Reach Full Charge	Confirm Maintenance or Replace Battery
3	Battery Cannot Reach Full Charge	DC Voltage Output from Power System Lower than Minimum Charging Voltage	Adjust Device's DC Output Voltage to Suitable Charging Voltage for Battery
4	Unstable Battery Output Voltage with Significant Fluctuations	Interference with Management System Operation	Restart the System
5	Temperature Monitoring Too Low	Damage to Temperature-Sensing Crystal Head	Replace the Collection Line with a Temperature-Sensing Crystal Head
6	Unable to Charge	Single Cell Protection Activated upon Full Battery Charge	Discharge Protection Removal
7	MOS temperature abnormal	MOS tube damaged	Replace BMS
8	Discharge overcurrent protection	Inverter power exceeds limit	Match the number of batteries according to the inverter power value

9.7 Inverter Matching Information

Inverter Brand	LOGO	Communication Method	Inverter Communication Pin	Battery Communication Pin	Remarks
PowMr		RS485	PIN7:RS485A PIN8:RS485B	PIN2/7:RS485A PIN1/8:RS485B	Default Battery Protocol Matching
SMA		CAN	PIN4:CANH PIN5:CANL	PIN4:CANH PIN5:CANL	Battery Protocol Change
VICTRON		CAN	PIN7:CANH PIN8:CANL	PIN4:CANH PIN5:CANL	1. Battery Protocol Change 2. Customized Network Cable
Growatt		RS485	PIN7:RS485A PIN8:RS485B	PIN2/7:RS485A PIN1/8:RS485B	1. Default Battery Protocol Matching 2. Inverter Protocol Setting Option 2
GOODWE		CAN	PIN4:CANH PIN5:CANL	PIN4:CANH PIN5:CANL	Default Battery Protocol Matching

PYLONTECH		RS485	PIN7:RS485A PIN8:RS485B	PIN2/7:RS485A PIN1/8:RS485B	Default Battery Protocol Matching
LUXPOWER		RS485	PIN2:RS485A PIN1:RS485B	PIN2/7:RS485A PIN1/8:RS485B	<ol style="list-style-type: none"> Battery Protocol Change Customized Network Cable
Voltronic Power		RS485	PIN5:RS485A PIN3:RS485B	PIN2/7:RS485A PIN1/8:RS485B	<ol style="list-style-type: none"> Default Battery Protocol Matching Customized Network Cable
SOFAR		CAN	PIN1:CANH PIN2:CANL	PIN4:CANH PIN5:CANL	<ol style="list-style-type: none"> Battery Protocol Change Customized Network Cable
SRNE		RS485	PIN7:RS485A PIN8:RS485B	PIN2/7:RS485A PIN1/8:RS485B	<ol style="list-style-type: none"> Default Battery Protocol Matching Inverter Protocol Setting Pyl
Deye		RS485 CAN	PIN4:CANH PIN5:CANL	PIN4:CANH PIN5:CANL	Default Battery Protocol Matching
MEGAREVO		CAN	PIN4:CANH PIN5:CANL	PIN4:CANH PIN5:CANL	Default Battery Protocol Matching
MUST		CAN	PIN6:CANH PIN5:CANL	PIN4:CANH PIN5:CANL	<ol style="list-style-type: none"> Battery Protocol Change Customized Network Cable

10 Maintenance

1. Do not immerse the battery in water. When not in use, store it in a cool and dry environment.
2. Do not throw the battery into the fire or heat it externally to avoid explosion or other hazards.
3. Do not invert the positive and negative poles of the battery. Never connect the battery directly to a power outlet, and prohibit short-circuiting the positive and negative poles.
4. Do not mix batteries from different manufacturers, different kinds, types, or different ages.
5. Do not use batteries that show signs of heating, swelling, deformation, or leakage in charging or discharging devices.
6. Prohibit piercing the battery with nails or other sharp objects, as well as throwing, stepping on, hitting, or impacting the battery.
7. Prohibit disassembling or dismantling the battery and its components. Any damage caused by unauthorized disassembly or repair will not be the responsibility of our company.
8. The battery undergoes strict inspection before leaving the factory. If customers find signs of heating, swelling, or unusual odors, do not use it and return it to the factory immediately.
9. For long-term storage, to ensure optimal battery performance, perform a charge-discharge cycle every three months and ensure a storage charge of 40%~60%.
10. Use the battery within the specified temperature range as stated in the specification.
11. Follow the specified power-up sequence for both the battery and the inverter.
12. The recommended load power for the battery should not exceed the maximum continuous discharge current of the battery.
13. If the battery is left unused for more than 3 months, it needs manual charging periodically to prevent complete discharge.

Note: In case of specific technical issues or situations not mentioned above, please contact technical support promptly.

11 Technical Specifications

Battery Model	POW-LIO48100-16S	POW-LIO48200-16S
System Voltage	51.2V	
Capacity	100Ah	200Ah
Nominal Energy	5.12KWh	10.24KWh
Constant Voltage charging Voltage	58.4V	
Max. Discharge Cutoff Voltage	43.2V	
Recommended Discharge Cutoff Voltage	48V	
Max. Charging Current	100A	150A
Recommended Charging Current	40A	40A
Max. Discharge Current	100A	150A
Max. Parallel Connection of Batteries	16	
Communication Interface	RS232/RS485/CAN/Dry Contac	
Cycle Life	≥6000 Times @80%DOD, 25°C	
Operating Temp	Charging: 0~60°C; Discharging: -10°C~65°C	
Nominal Operation Altitude	< 2000m	
Nominal Operation Humidity	<90%RH	
IP Grade	IP21	
Recommended Operation Environment	Indoor	
Battery Dimensions (LxWxH)	510x440x170mm	670x450x207mm
Net Weight	44kg	87kg



POWMr

SHENZHEN HEHEJIN INDUSTRIAL CO.,LTD

Tel/Fax: +86 755-28219903

Email: support@powmr.com

Web: www.powmr.com

Add: Henggang Street, Longgang District, Shenzhen, Guangdong, China