

ENERGY STAR RATED DEHUMIDIFIER

home™
homelabs.com

22, 35 and 50 Pint* Capacity Models

HME020030N
HME020006N
HME020031N
HME020391N

Thank you for purchasing our quality appliance. Please be sure to read the entirety of this user manual carefully prior to use of the product. If you have any questions regarding the use of this product, please call 1-800-898-3002.

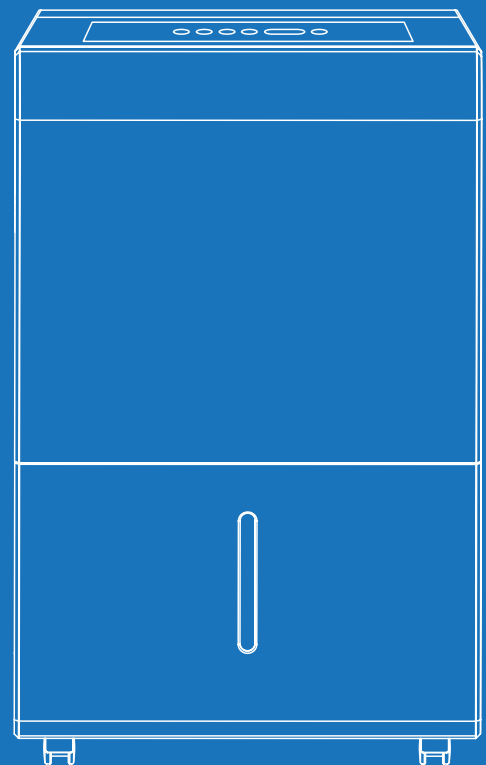

BEFORE FIRST USE:

To prevent any internal damage, it is very important to keep refrigeration units (like this one) upright throughout their journey. Please leave it standing upright and outside the box for **24 HOURS** before plugging it in.

In the event this product malfunctions or customer believes it is defective, the customer should contact Customer Service and retain the defective product pending further instructions. Defective product should be clearly marked or stored where it cannot be used again by mistake. Failure to retain the product may impede hOme™'s ability to correct any legitimate problem and may limit the extent to which hOme™ may provide recourse.

TABLE OF CONTENTS

Important Safety Instructions	6-7
Parts Description	8
Operation	9-13
Care & Cleaning	14
Troubleshooting	15
Warranty	16
Warning	16
Contact Us	16

Congratulations

on bringing home your new appliance!

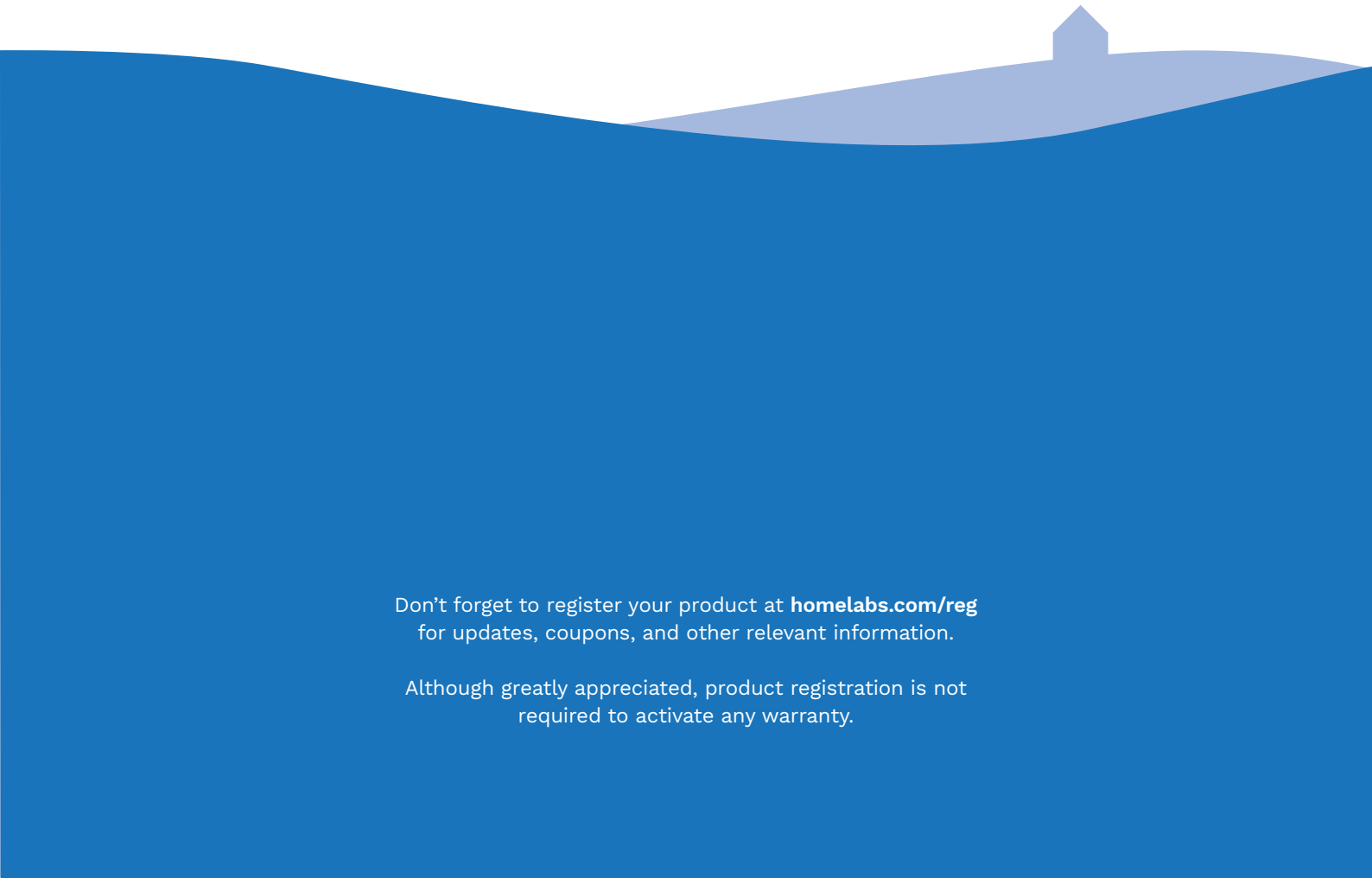

Don't forget to register your product at homelabs.com/reg
for updates, coupons, and other relevant information.

Although greatly appreciated, product registration is not
required to activate any warranty.



IMPORTANT NOTICE FOR FIRST TIME USE

PLEASE NOTE:

This dehumidifier defaults to **CONTINUOUS MODE**, disabling use of the **LEFT/RIGHT** buttons. To regain use of the buttons, confirm **CONTINUOUS MODE** is turned off.

TURN ON
DEHUMIDIFIER



POWER

TURN OFF
CONTINUOUS MODE



CONT.

BEGIN USING
LEFT/RIGHT BUTTONS



SAVE THESE INSTRUCTIONS / FOR HOUSEHOLD USE ONLY

To prevent injury to the user or other people and property damage, the following instructions must be followed when using the dehumidifier. Incorrect operation due to disregard of instructions may cause harm or damage.

1. Do not exceed the rating of the power outlet or connection device.
2. Do not operate or turn off the dehumidifier by plugging in or unplugging the device. Use the control panel instead.
3. Do not use if the power cord is broken or damaged.
4. Do not modify the power cord length or share the outlet with other appliances.
5. Do not touch the plug with wet hands.
6. Do not install the dehumidifier in a location that may be exposed to combustible gas.
7. Do not place the dehumidifier near a heat source.
8. Disconnect the power if strange sounds, smell, or smoke comes from the dehumidifier.
9. You should never try to take apart or repair the dehumidifier by yourself.
10. Make sure to turn off and unplug the dehumidifier before cleaning.
11. Do not use the dehumidifier near flammable gas or combustibles, such as gasoline, benzene, thinner, etc.
12. Do not drink or use the water drained from the dehumidifier.
13. Do not take the water bucket out while the dehumidifier is working.
14. Do not use the dehumidifier in small spaces.
15. Do not place the dehumidifier in places where it may be splashed by water.
16. Place the dehumidifier on a level, sturdy section of the floor.
17. Do not cover the intake or exhaust openings of the dehumidifier with cloths or towels.
18. Do not clean the appliance with any chemicals or organic solvent, e.g. Ethyl acetate, gasoline.
19. This appliance is not intended for locations near to flammable or combustible gas.
20. Care should be taken when using the dehumidifier in a room with the following persons: infants, children and the elderly.
21. For people who are sensitive to humidity, do not set the humidity level too low on the dehumidifier.
22. Never insert your finger or other foreign objects into grills or openings. Take special care to warn children of these dangers.
23. Do not place a heavy object on the power cord and make sure that the cord is not compressed.
24. Do not climb on or sit on the dehumidifier.
25. Always insert the filters securely. Make sure to clean the filter once every month.
26. If water enters the dehumidifier, turn the dehumidifier off and disconnect the power, contact Customer Service in order to avoid a hazard.
27. Do not place flower vases or other water containers on top of the dehumidifier.

ELECTRICAL INFORMATION

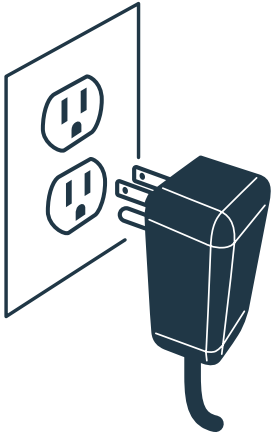

- The hOme™ nameplate is located on the rear panel of the dehumidifier and contains electrical and other technical data specific to this dehumidifier.
- Be sure the dehumidifier is properly grounded. To minimize shock and fire hazards, proper grounding is important. This power cord is equipped with a three-prong grounding plug for protection against shock hazards.
- Your dehumidifier must be used in a properly grounded wall socket. If your wall socket is not adequately grounded or protected by a time delay fuse or circuit breaker, have a qualified electrician install the proper socket.
- Avoid fire hazard or electric shock. Do not use an extension cord or an adapter plug. Do not remove any prong from the/power cord.

CAUTION

- This dehumidifier can only be used by children 8 years or older and person with reduced physical, sensory or mental capabilities or lack of experience and knowledge with supervision or instruction concerning use of the dehumidifier. Cleaning and user maintenance shall not be done by children without supervision.
- If the supply cord is damaged, it must be replaced by qualified personnel. Please contact Customer Service in order to avoid hazard.
- Prior to cleaning or other maintenance, the dehumidifier must be disconnected from the supply mains.
- Do not install the dehumidifier in a location that may be exposed to combustible gas.
- If combustible gas accumulates around the dehumidifier, it may cause fire.
- If the dehumidifier is knocked over during use, turn off the dehumidifier and unplug it from the main power supply immediately. Visually inspect the dehumidifier to ensure there is no damage. If you suspect the dehumidifier has been damaged, contact Customer Service for repair or replacement.
- During a thunderstorm, the power must be cut off to avoid damage to the dehumidifier due to lightning.
- Do not run the cord under carpeting. Do not cover the cord with throw rugs, runners, or similar coverings. Do not route the cord under furniture or appliances. Arrange the cord away from traffic area and where it will not be tripped over.
- To reduce the risk of fire or electric shock, do not use this dehumidifier with any solid-state speed control device.
- The dehumidifier shall be installed in accordance with national wiring regulations.
- Contact Customer Service for repair or maintenance of this dehumidifier.

FRONT

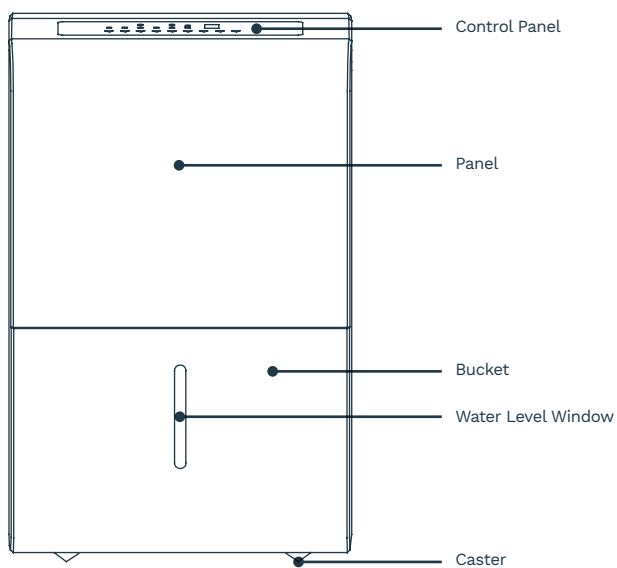

REAR

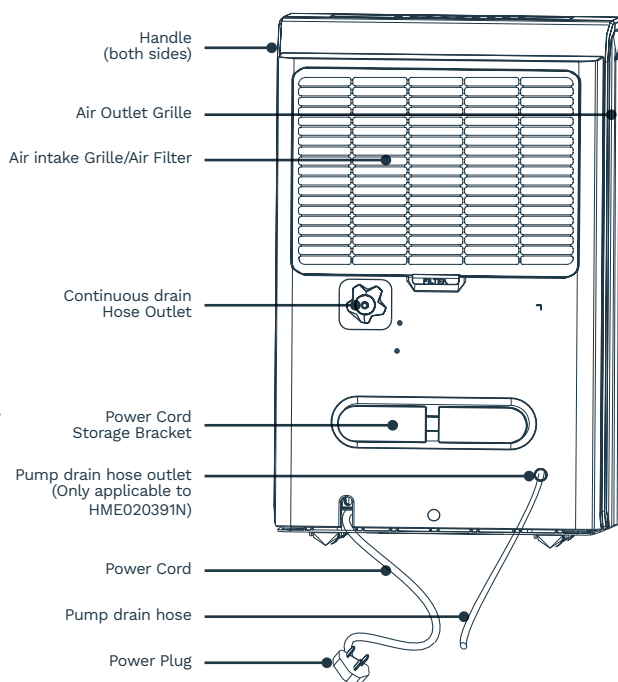

ACCESSORIES

(placed in the bucket of the dehumidifier)



Pump Drain Hose (1pc)
(Only for the dehumidifier with pump feature)

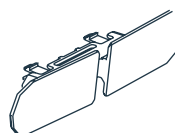

Power Cord Storage Bracket (1pc)

PLACEMENT

- This unit may have been tilted or placed upside down during shipping. To ensure this device works properly, please ensure this unit is upright for at least 24 hours before initial use.
- This dehumidifier is designed to operate with a working environment between 41°F (5°C) and 90°F (32°C).

Casters (Installed at four points on the bottom of the dehumidifier)

- Do not force casters to move over carpet, or move the dehumidifier with water in the bucket.
(The dehumidifier may tip over and spill water.)

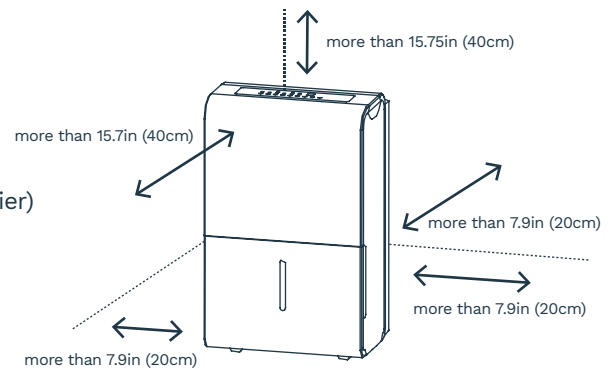

SMART FUNCTIONS

- Auto Shut Off

When the bucket is full and/or the humidity setting is reached, the dehumidifier will automatically shut off.

- Power on Delay

To avoid any damage to the dehumidifier, the dehumidifier will not start operation following a complete cycle until after three (3) minutes. Operation will automatically start after three (3) minutes.

- Bucket Full Indicator Light

The **Full** indicator glows when the bucket is ready to be emptied.

- Auto Defrost

When frost builds up on the evaporator coils, the compressor will cycle off and the fan will continue to run until the frost disappears.

- Auto-Restart

If the dehumidifier shuts off unexpectedly due to power being cut, the dehumidifier will restart with the previous function setting automatically when the power resumes.

NOTE:

All the illustrations in the manual are for explanation purpose only. Your dehumidifier may be slightly different. The actual shape shall prevail. The design and specifications are subject to change without prior notice for product improvement. Consult Customer Service for details.

CONTROL PANEL

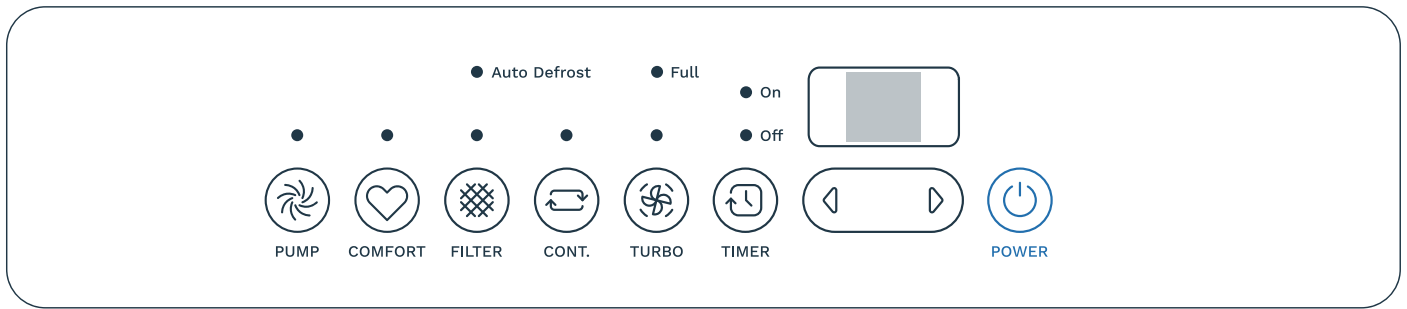

PUMP button (Only applicable to HME020391N)

Press to activate the pump operation.
 Note: Before starting pump, make sure the pump drain hose is attached, the continuous drain hose is removed and the plastic cover of the continuous drain hose outlet is replaced tightly. When the bucket is full, the pump starts to work. Refer to the next pages for removing the collected water.

Note: It needs time before water was pumped at the beginning.



COMFORT button

Press this button to turn the comfort function on/off. Under this mode, the humidity cannot be adjusted manually but will be preset to a recommended comfortable level based on the ambient temperature. The level will be controlled as per below table:

Ambient Temperature	<65 °F	65 -77 °F	>77 °F
Relative Humidity	55 %	50 %	45 %

Note: Press ◀ or ▶ button, the COMFORT mode will be canceled, and the humidity level can be adjusted.



FILTER button

The check filter feature is a reminder to clean the Air Filter for more efficient operation. The Filter light (clean filter light) will flash after 250 hours of operation. To reset after cleaning the filter, press the filter button and the light will go off.



CONTINUOUS button

Press to activate the continuous dehumidifying operation. The appliance will work continuously and will not stop except that the bucket is full. In continuous mode, the ◀ and ▶ buttons are locked.



TURBO button

Controls the fan speed. Press to select either High or Normal fan speed. Set the fan control to High for maximum moisture removal. When the humidity has been reduced and quiet operation is preferred, set the fan control to Normal.



TIMER button

Press to set an Auto on or an Auto off timer (0 - 24 hours) in conjunction with the ◀ and ▶ buttons. The timer runs only one cycle, thus remember to set a timer before next time's use.

- After plugging in the appliance, press **TIMER** button, the **TIMER OFF** indicator will light up, meaning the Auto off timer setting is activated. Use ◀ and ▶ buttons to set the value of time you want to shut down the appliance. The one-off Auto off timer setting is finished.
- Press **TIMER** button again, the **TIMER ON** indicator will light up, meaning the Auto on timer setting is activated. Use ◀ and ▶ buttons to set the value of time you want to turn on the appliance next time. The one-off Auto off timer setting is finished.
- To change the timer settings, repeat the above operations.
- Press or hold ◀ and ▶ buttons to change the Auto time by 0.5 hour increments, up to 10 hours, then at 1 hour increments up to 24 hours. The control will count down the time remaining until start.
- The selected time will register in 5 seconds and the system will automatically revert back to display the previous humidity setting.
- To cancel a timer, adjust the timer value to 0.0. The corresponding timer indicator will light off, meaning the timer is canceled. Another way to cancel a timer is restart the appliance, the one-off timer will also become invalid.
- When the bucket is full, the screen displays "P2" error code, the appliance will then shut down automatically. Both the Auto on/ Auto off timer will be canceled.

CONTROL PANEL (CONT.)



LED display

Shows the set % humidity level from 35% to 85% or auto start/stop time (0~24) while setting, then shows the actual ($\pm 5\%$ accuracy) room % humidity level in a range of 30% RH (Relative Humidity) to 90%RH (Relative Humidity).

Error Codes:

AS - Humidity sensor error

ES - Temperature sensor error

Protection Codes:

P2 - Bucket is full or bucket is not in right position.
Empty the bucket and replace it in the right position.

Eb - Bucket is removed or not in right position.
Replace the bucket in the right position. (Only applicable to the unit with pump feature.)



POWER button

Press to turn the dehumidifier on and off.



LEFT / RIGHT buttons

NOTE: When the dehumidifier is first turned on, it will go on Continuous mode by default. This will disable use of the LEFT/RIGHT buttons. Make sure to turn off Continuous mode to regain function in these buttons.

Humidity Set Control buttons

- The humidity level can be set within a range of 35%RH (Relative Humidity) to 85%RH (Relative Humidity) in 5% increments.
- For drier air, press the ◀ button and set to a lower percent value (%).
For damper air, press the ▶ button and set a higher percent value (%).

Timer Set Control buttons

- Press to initiate the auto start and auto stop feature, in conjunction with the ◀ and ▶ buttons.

Indicator Lights

- ON Timer ON light
- OFF Timer OFF light
- FULL The water tank is full and should be emptied
- DEFROST The appliance is on Defrost mode

Note: When one of the above malfunctions occurs, turn off the dehumidifier, and check for any obstructions. Restart the dehumidifier, if the malfunction is still present, turn off the dehumidifier and unplug the power cord. Contact Customer Service for repair and/or replacement.

REMOVING THE COLLECTED WATER

1. Use the bucket

When the bucket is full, remove the bucket and empty it.

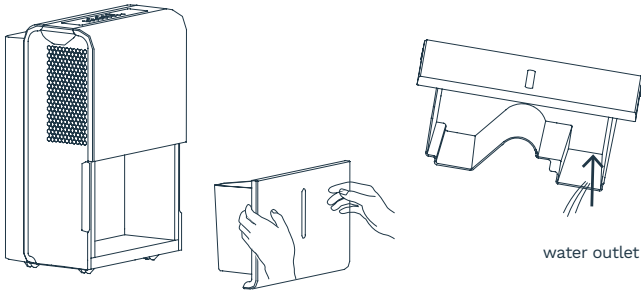

2. Continuous draining

Water can be automatically be emptied into a floor drain by attaching the dehumidifier to a water hose with a female threaded end. (NOTE: On some models, the female threaded end is not included)

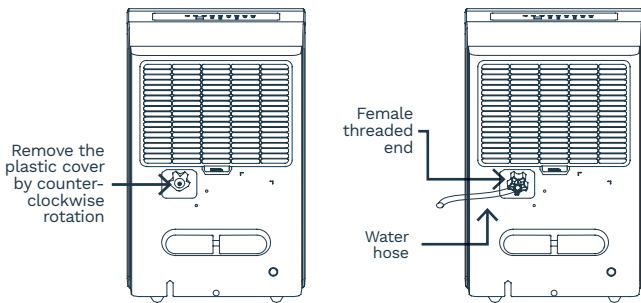

Note: Do not use continuous draining when the outdoor temperature is equal to or less than 32°F (0°C), otherwise the water will freeze, causing the water hose to block up and the dehumidifier may be damaged.

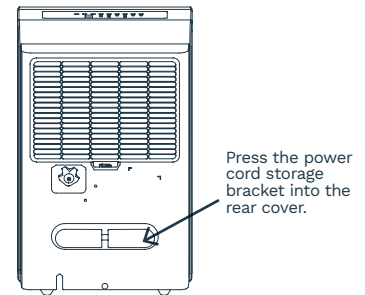

- Note:**
- Make sure the connection is tight and there is no leaking.
 - Lead the water hose to the floor drain or a suitable drainage facility, the drainage facility should be lower than the drain outlet of the dehumidifier.
 - Be sure to run the water hose sloping downward to let the water flow out smoothly.
 - When the continuous drain feature is not being used, remove the drain hose from the outlet and replace the plastic cover of the continuous drain hose outlet tightly.

REMOVING THE COLLECTED WATER (CONT.)

3. Pump draining (Only applicable to HME020391N)

- Remove the continuous drain hose from the unit. Replace the plastic cover of the continuous drain hose outlet tightly.
- Attach the pump drain hose (Outer diameter: 1/4"; length: 16.4 ft) to the pump drain hose outlet. The insert depth should not be less than 0.59 inch. Lead the drain hose to the floor drain or a suitable drainage facility.

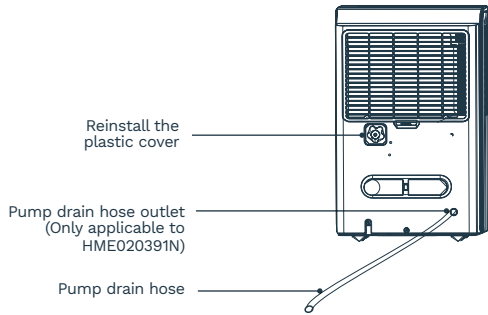

- Press **Pump** button to pump the water. When the bucket is full, the pump will start to work. It is normal that the pump makes loud noises at first 3~5 minutes of work.

Note:

- Make sure the connection is tight and there is no leaking.
- If the pump hose drops when removing the bucket, you must install the pump hose to the unit before replacing the bucket into the unit.
- The maximum pumping elevation is 16.4 ft.

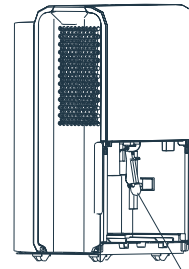

Pump hose drops

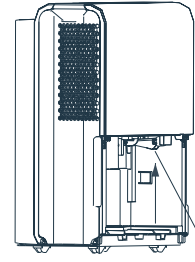

Reinstall pump hose properly

Note: Do not use the pump when the outdoor temperature is equal to or less than 32°F (0°C), otherwise the water will freeze, causing the water hose to block up and the dehumidifier may be damaged.

CARE AND CLEANING OF THE DEHUMIDIFIER

WARNING: Turn the dehumidifier off and remove the plug from the wall outlet before cleaning.

Clean the dehumidifier with water and mild detergent. Do not use bleach or abrasives.

1. Clean the Grille and Case

- Do not splash water directly onto the main unit. Doing so may cause an electrical shock, cause the insulation to deteriorate, or cause the unit to rust.
- The air intake and outlet grilles get soiled easily. Use a vacuum attachment or brush to clean.

2. Clean the bucket

Clean the bucket with water and mild detergent every two weeks.

3. Clean the air filter

Clean the filter with potable water at least once every 30 days.

4. Storing the dehumidifier

Store the dehumidifier when it will not be used for a long time.

- After turning off the dehumidifier, wait one day until all water in the internal of the dehumidifier flows into the bucket, and then empty the bucket.
- Clean the main dehumidifier, bucket and air filter.
- Wrap the cord and bundle it with the band.
- Cover the dehumidifier with a plastic bag.
- Store the dehumidifier upright in a dry, well-ventilated place.

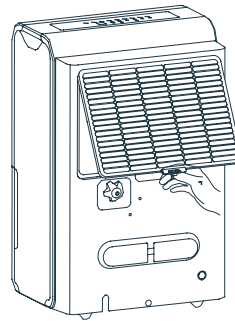

CAUTION: DO NOT operate the dehumidifier without a filter because dirt and lint will clog it and reduce performance.

Troubleshooting

Before contacting customer service, reviewing this list can save time. This list includes the most common occurrences that are not the result of defective workmanship or materials in this dehumidifier.

PROBLEM	CAUSE/SOLUTION
Dehumidifier does not start	<ul style="list-style-type: none"> - Make sure the dehumidifier's plug is inserted completely into the outlet. - Check the house fuse/circuit breaker box. - Dehumidifier has reached its preset level or bucket is full. - Bucket is not in the proper position.
Dehumidifier does not dry the air as it should	<ul style="list-style-type: none"> - Make sure allow enough time to remove the moisture. - Make sure there are no curtains, blinds or furniture blocking the front or back of the dehumidifier. - The humidity level may not be set low enough. - Check that all doors, windows and other openings are securely closed. - Room temperature is too low, below 41°F (5°C). - There is a kerosene heater or something giving off water vapor in the room.
The dehumidifier makes a loud noise when operating	<ul style="list-style-type: none"> - The air filter is clogged. - The dehumidifier is tilted instead of upright as it should be. - The floor surface is not level.
Frost appears on the coils	<ul style="list-style-type: none"> - This is normal. The dehumidifier has Auto defrost feature.
Water on floor	<ul style="list-style-type: none"> - The dehumidifier was placed on uneven floor. - Hose to connector or hose connection may be loose. - Intend to use the bucket to collect water, but the back drain plug is removed.
Water does not drain from the hose	<ul style="list-style-type: none"> - Hoses more than 5 feet long may not drain properly. It is recommended to keep the hose as short as possible for proper draining. The hose must be placed lower than the bottom of the dehumidifier, and be kept flat and smooth without kinks.
The pump indicator blinks. (Only applicable to HME020391N)	<ul style="list-style-type: none"> - The filter is dirty. Refer to the Cleaning and Maintenance section to clean the filter. - The pump drain hose is not attached to the rear of the dehumidifier. - The bucket is not in right position. Place the bucket properly. - The pump hose drops. Reinstall the pump hose. If the error repeats, call customer service.

Contact Customer Service if dehumidifier operates abnormally or does not operate, and the solutions above are not useful.

Warranty

hOme™ offers a limited one-year warranty (“warranty period”) on all of our products purchased new and unused from hOme Technologies, LLC or an authorized reseller, with an original proof of purchase and where a defect has arisen, wholly or substantially, as a result of faulty manufacture, parts or workmanship during the warranty period. The warranty does not apply where damage is caused by other factors, including without limitation: (a) normal wear and tear; (b) abuse, mishandling, accident, or failure to follow operating instructions; (c) exposure to liquid or infiltration of foreign particles; (d) servicing or modifications of the product other than by hOme™; (e) commercial or non-household use.

The hOme™ warranty covers all costs related to restoring the proven defective product through repair or replacement of any defective part and necessary labor so that it conforms to its original specifications. A replacement product may be provided instead of repairing a defective product. hOme™’s exclusive obligation under this warranty is limited to such repair or replacement.

A receipt indicating the purchase date is required for any claim, so please keep all receipts in a safe place. We recommend that you register your product on our website, homelabs.com/reg. Although greatly appreciated, the product registration is not required to activate any warranty and product registration does not eliminate the need for the original proof of purchase.

The warranty becomes void if attempts at repair are made by non-authorized third parties and/or if spare parts, other than those provided by hOme™, are used.

You may also arrange for service after the warranty expires at an additional cost.

These are our general terms for warranty service, but we always urge our customers to reach out to us with any issue, regardless of warranty terms. If you have an issue with a hOme™ product, please contact us at 1-800-898-3002, and we will do our best to resolve it for you.

This warranty gives you specific legal rights, and you may have other legal rights which vary from state to state, country to country or province to province. The customer may assert any such rights at their sole discretion.

Warning

This manual is to be used with all items with the model numbers

HME020030N
HME020006N
HME020031N
HME020391N

WARNING: Keep all plastic bags away from children.

Manufacturer, distributor, importer and seller are not liable for ANY damage caused by improper use, storage, care or failure to follow warnings associated with this product.

Contact Us

 CHAT WITH US

homelabs.com/help

 CALL US

1-(800)-898-3002

 EMAIL US

help@homelabs.com



For Household
Use Only

1-800-898-3002
help@homelabs.com
homelabs.com/help

© 2020 hOmeLabs, LLC
37 East 18 Street, 7th Floor
New York, NY 10003