

M86A

Multi-Room Audio Controller



ELAN®

Preface

Purpose of this Manual

This manual provides step-by-step installation instructions and connection examples, along with basic user information for installation and ongoing use of the M86A Multi-Room Audio Controller. This manual is written for the installer of this equipment.

Please see the software tutorial and Help file for programming information.

These can be found at www.elanhomesystems.com.

Organization

The following information is contained in this manual.

Safety Information	Provides a comprehensive list of safety practices and procedures allowing for the safe installation and operation of ELAN's M86A Multi-Room Audio Controller.
M86A Introduction	Provides an introduction to ELAN's M86A Multi-Room Audio Controller, along with system features to include Front and Rear panel controls, indicators and connections, along with a short description of each.
M86A System Design Overview	Provides a system design application overview of the M86A Multi-Room Audio Controller for use in audio applications.
M86A Connections	Provides a description of the M86A Multi-Room Audio Controller system connections and direct connections from the M86A to other components.
M86A System Expansion	Provides information about integrating the C2 Communications Controller and V8 Composite Video Router.
M86A Operation and Settings	Provides location and function description of DIP switches, LEDs and the B1 Test Mode Button.
Troubleshooting	Provides troubleshooting tables to help fix common problems that may be encountered when installing the M86A Multi-Room Audio Controller.
Programming	Appendix A provides a list of the IR and VIANet commands and their functions.
Rack Mounting	Appendix B provides specifications for rack mounting the M86A Multi-Room Audio Controller.
Specifications	Provides equipment specifications for the M86A Multi-Room Audio Controller.

Safety Information

WARNING

**RISK OF ELECTRIC SHOCK
DO NOT OPEN!**

CAUTION: TO REDUCE THE RISK OF ELECTRIC SHOCK, DO NOT REMOVE COVER (OR BACK). NO USER SERVICEABLE PARTS INSIDE. REFER SERVICING TO QUALIFIED SERVICE PERSONNEL.

CAUTION: RISK OF EXPLOSION IF BATTERY IS REPLACED BY AN INCORRECT TYPE. DISPOSE OF USED BATTERIES ACCORDING TO THE INSTRUCTIONS.



The lightning flash with arrowhead symbol within an equilateral triangle is intended to alert the user to the presence of uninsulated "dangerous voltage" within the product's enclosure that may be of sufficient magnitude to constitute a risk of electric shock to persons.



The exclamation point within an equilateral triangle is intended to alert the user to the presence of important operating and maintenance (servicing) instruction in the literature accompanying the appliance.

WARNING: TO REDUCE THE RISK OF FIRE OR SHOCK, DO NOT EXPOSE THIS APPLIANCE TO RAIN OR MOISTURE.

CAUTION

IMPORTANT SAFETY INFORMATION

Read Information — All the safety and operating information should be read before the appliance is operated.

Follow Information — All operating and use information should be followed.

Retain Information — The safety and operating information should be retained for future reference.

Heed Warnings — All warnings on the appliance and in the operating instructions should be heeded.

Wall Mounting — Mounting of this appliance should be done only by an authorized installer.

Ventilation — The appliances should be situated so that their location or position does not interfere with their proper ventilation. These appliances should never be placed near or over a radiator or heat register. These appliances should not be placed in a built-in installation such as a bookcase or cabinet that may impede the flow of air through the ventilation openings.

Non-Use Periods — Appliances that are left unattended and unused for long periods of time should be de-energized.

Grounding or Polarization — Do not defeat the safety purpose of the polarized or grounding-type plug. A polarized plug has two blades with one blade wider than the other blade. A grounding type plug has two blades and a third grounding prong. The polarized wide blade and the third prong are provided for your safety. If the provided plug does not fit your outlet, consult an electrician for replacement of the obsolete outlet.

Power Cord Protection — Protect the power cord from being walked on or pinched particularly at plugs, convenience receptacles and the point where they exit from the apparatus.

Water—Do not use the apparatus near water.

Cleaning — Unplug the apparatus from the power outlet before cleaning. Use only a dry cloth to clean the apparatus.

Power Lines — An outdoor antenna should be located away from power lines. When installing an outside antenna system, extreme care should be taken to avoid touching power lines or circuits, as contact with them may be fatal.

Object and Liquid Entry — Never insert objects of any kind through the openings of these appliances, as they may touch dangerous voltage points or short-out parts that could result in a fire or electric shock. Care should be taken so that objects do not fall and liquids are not spilled into the appliance through openings in the enclosure.

Servicing — Do not attempt to service these appliances yourself, as opening or removing covers may expose you to dangerous voltage or other hazards. Refer all servicing to qualified service personnel.

Damage Requiring Service — These appliances should be serviced by qualified service personnel when:

- A power supply connection or a plug has been damaged or
- If liquid has been spilled into the appliance or objects have fallen into the appliance or
- The appliance has been exposed to water or moisture or
- The appliance does not appear to operate normally or exhibits a marked change in performance or
- The appliance has been dropped or the enclosure damaged.

Replacement Parts — When replacement parts are required, be sure the service technician has used replacement parts specified by the manufacturer or that have the same characteristics as the original part. Unauthorized substitutions may result in fire, electric shock, or other hazards. The Master Control Unit battery should be replaced only after turning the power off and only by an authorized installer.

Safety Check — Upon completion of any service or repairs to this audio product, ask the service technician to perform safety checks to determine that the audio product is in proper operating condition.

Lightning Storms — Unplug this apparatus during lightning storms or when unused for long periods of time.

Attachments and Accessories — Use only attachments/accessories specified by the manufacturer.

Cart, Stand, Tripod, Bracket or Table — Use only with a cart, stand, tripod, bracket or table specified by the manufacturer, or sold with the apparatus. When a cart is used, use caution when moving the cart/apparatus combination to avoid injury from tip over.

Disconnect Device — Where the mains plug or an appliance coupler is used as the disconnect device, the disconnect device shall remain operable.



NOTE:

This equipment has been tested and found to comply with the limits for a Class B digital device, pursuant to part 15 of the FCC Rules. These limits are designed to provide reasonable protection against harmful interference in a residential installation.

This equipment generates, uses, and can radiate radio frequency energy and, if not installed and used in accordance with the instructions, may cause harmful interference to radio communications. However, there is no guarantee that interference will not occur in a particular installation. If this equipment does cause harmful interference to radio or television reception, which can be determined by turning the equipment off and on, the user is encouraged to try to correct the interference by one or more of the following measures:

- Reorient or relocate the receiving antenna.
- Increase the separation between the equipment and receiver.
- Connect the equipment into an outlet on a circuit different from that to which the receiver is connected.
- Consult the dealer or an experienced radio/TV technician for help.

CAUTION:

Changes or modifications not expressly approved by ELAN could void the user’s authority to operate the equipment.



Table of Contents

- Preface 1**
 - Purpose of this Manual..... 1
 - Organization 1
- Safety Information 2**
- Chapter 1: Introduction 6**
- The ELAN Story 7
- M86A Features 8
- M86A Front Panel Indicators 9
- M86A Rear Panel Connections 10
- Chapter 2: M86A System Design Overview..... 11**
- Introduction 11
- Rack Mounting 11
- Pre-Wire..... 11
- Applications..... 13
 - Zone/Sub-Zone Definitions 13
 - Stereo Zones 14
 - Stereo Zones w/ Stereo Sub-Zone Using Volume Controls 15
 - Stereo Zone w/ Multiple Sub-Zones..... 16
- Chapter 3: M86A Connections 18**
- System Controller Connections 18**
 - VIANet Connection 18
 - IR Expansion Port Connection 19
 - All Zones IR Out Connection..... 19
 - Source Input Connections 19
- M86A Connections 20**
 - TS2 Touchpads 20
 - Source IR Output Connections 21
 - Sense Input Connections..... 22
 - Zone Preamp Audio Outputs..... 23
 - Source Audio Connections 23
 - Speaker Outputs..... 24

Multi-Chassis Connections 25
 Loop Audio Outputs.....25
 IR Loop Connections.....26
 IR Expansion Port Connections27
 VIANet Loop Connections.....28

Chapter 4: System Expansion..... 29
ELAN C2 Communication Controller Integration..... 29
ELAN V8 Composite Video Router Integration 30

Chapter 5: Operation and Settings..... 31
 Unit ID DIP Switch Settings..... 31
 B1 Button Operation 31
 Front Panel LEDs..... 32

Chapter 6: Troubleshooting 33
 General 33
 Audio..... 33
 Video..... 35
 Sense Input 35
 IR/VIANet Control 36
 C2 Communication Control 37
 Appendix A: Programming 38
 Appendix B: Rack Mounting 39
 Specifications 40

Warranty.....Back Page

**Items in Package:**

- M86A Controller
- Power Cord
- DB-15 Male-Female Cable
- 3.5mm Stereo Male-Male Cable
- 4 Position Speaker Connectors (6)
- Quick Install Guide

Chapter 1: Introduction

The M86A is NOT a “stand-alone” unit. It REQUIRES integration with an ELAN HC6 or HC12 System Controller to function.

The M86A Multi-Room Audio Controller combined with the ELAN HC6 or HC12 System Controller is designed to be an affordable, feature rich solution for whole-house audio distribution, combining amplification, audio switching, event triggers, and source control options in a combination found in no other product at this price point. The M86A Controller is an eight source, six zone controller with twelve channels of amplification. Up to four M86A Controllers can be linked for a total of twenty-four zones. The M86A integrates with ELAN TS2 Touchpads, IR receivers and TS7 Touchscreens.

This unit has been designed with flexibility in mind. Multiple control methods combine with expandability to offer the perfect solution for medium and larger whole-house audio and automation control systems, and advanced event trigger options allow flexible automation opportunities.

The M86A Controller includes audio signal sensing and system-status feedback, eight programmable IR ports, an “ALL Zones IR Out” port, six Sense Inputs, IR Expansion ports, and Music-On-Hold output and Page/Doorbell audio input jacks for easy integration with ELAN’s C2 Communications Controller.

The ELAN Story

Located in Lexington, KY, USA, ELAN Home Systems has designed innovative multi-room audio/video systems since 1989. ELAN systems were the first to integrate music, intercom and TV distribution features that used the homeowner's stereos, televisions and telephones to create the whole-house entertainment experience. These Systems allow people to move from room to room, controlling centrally located equipment with ease.

ELAN's product line includes:

- Power Amplifiers
- Multi-Zone Pre-Amps
- Intelligent Keypads
- In-Wall LCD Color Touch Panels
- Wireless LCD Color Touch Panels
- Film Interactive Touchpads
- In-Wall and In-Ceiling Speakers
- Outdoor Speakers
- System Controllers
- A/V Controllers
- Telephone-Based Intercom Controllers
- Video Switchers
- Digital Music & DVD Management Systems
- Satellite Radios
- Accessories for Home Systems Installation
- Volume Controls

M86A Features

- **8 Source, 6 Zone Controller**

System Expansion to 4 M86As for 24 zones
- **30 Watts Per Channel Internal Amplifier**

Produces 30W/Ch into an 8 ohm load
- **Variable or Fixed Preamp Outs**

Connect to external amplifiers when you need extra power, for example, in an outdoor listening area or a large zone with multiple speakers
- **TS2 Inputs (6)**

Accommodates up to two TS2s per zone
- **Buffered Loop Audio Outputs**

Used for system expansion and to share sources with Home Theater Systems
- **Routable IR Outputs**

Makes IR source control connections a breeze
- **Front Panel Status LEDs**

Provide system status and troubleshooting feedback
- **Independent Zone Control for Bass, Treble, Volume**

Programmable Turn-On Settings and “On the Fly” Adjustments
- **USB Port**

Configuration and firmware updates
- **Interfaces with the ELAN C2 Communication Controller**

Enables Paging, Music on Hold and Door Station Features
- **Input Source Leveling**

Optimize the input level of each audio source for smooth source switching. Available for Variable Pre-Amp outputs and speaker outputs (not Fixed-mode Preamp Outputs).
- **Sense Trigger Inputs**

Enables Trigger Activated Event Maps and Conditional Programming

M86A Front Panel Indicators

Figure 1-1: M86A Front Panel Display

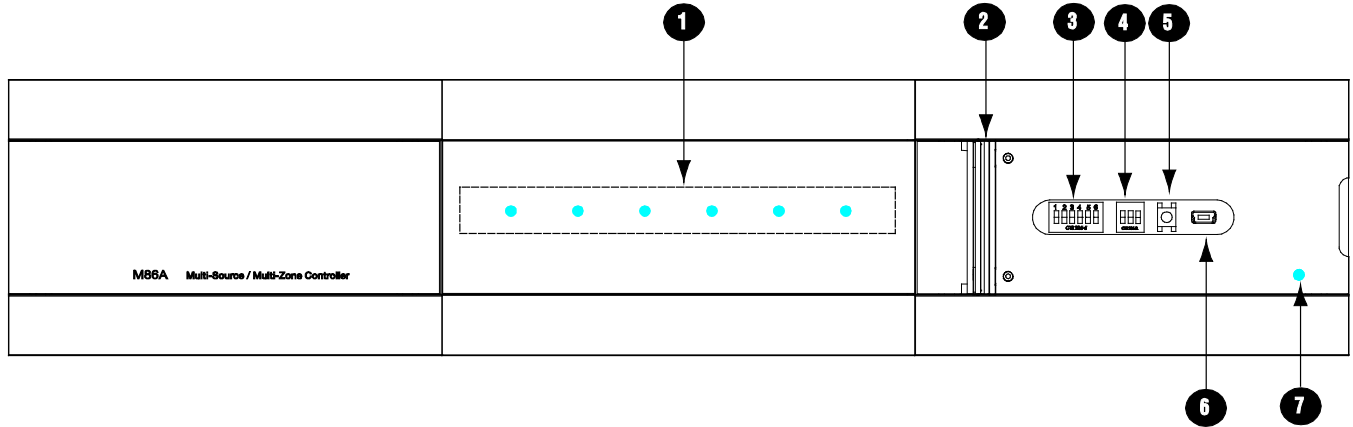

Item	Function
1	Zone Status Indicators Solid blue when the zone is on, Flickers when IR is being received in the zone
2	Front Panel Access Door (Shown Open)
3	Zone Pre-Amp Output Dip Switches Sets Zone pre-amp outputs to fixed or variable
4	Chassis ID Dip Switches Sets unit ID for chassis
5	B1 Button Activates a test sequence to verify operation
6	USB-Mini-B Connection Used to download chassis configuration information and for in-field firmware updates
7	Power LED Solid blue when the M86A has AC power, Slow blink if unit is overheating, Fast blink if unit has shut down due to high temperature

M86A Rear Panel Connections

Figure 1-2 M86A Rear Panel Connections

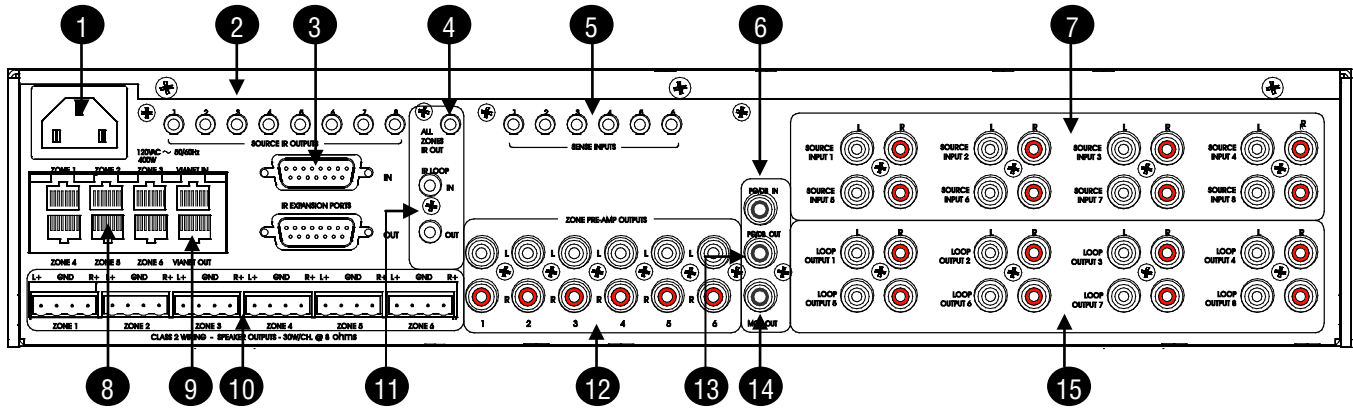

Item	Function	Item	Function
1	AC Power Connector	9	VIANet Connections Links ELAN VIANet Controlled Devices
2	Source Specific IR Outputs Routes IR to specific sources	10	Speaker Outputs 30W per channel, Stereo Audio Output
3	IR Expansion Ports Connects to the IR Link of the System Controller and additional M86A chassis	11	IR Loop Connections Allows IR from auxiliary M86A chassis to loop through the main M86A chassis to the System Controller
4	All Zones IR Out Connects to the External IR Input of the System Controller	12	Zone Preamp Outputs Fixed or Variable Output Level
5	Sense Input Triggers Used for conditional programming and to activate Event Maps	13	Page / Doorbell Audio Out Connect to PG/DB Audio In of auxiliary M86A chassis.
6	Page / Doorbell Audio In Use with the ELAN C2 Communication Controller	14	Music On Hold Output Use with the ELAN C2 Communication Controller
7	Source Audio Inputs	15	Source Audio Loop Outputs Connect to Source Audio Inputs of auxiliary M86A chassis
8	Zone Control Inputs Connect TS2 Touchpads		

Chapter 2: M86A System Design Overview

Introduction

The first step to a good design is to map the system. It is advisable to mark up a copy of the house floor plan with speaker, touchpad, touchscreen, volume control, and equipment locations etc. Make sure that all locations are decided upon before pre-wiring commences so that all necessary wiring and installation hardware is in place. This unit will be interfacing with other components such as amplifiers, source components, communications controllers, serial controllers, and user interfaces, so it is essential that ALL system components are accounted for prior to the pre-wire stage.

Secondly, make a detailed list of all components. Include source equipment, touchpads, touchscreens, volume controls, amplifiers, communications gear and the M86A itself. Be sure to include necessary electrical boxes, structured wiring enclosures, telephone lines, rough-in brackets, patch cords, power supplies, etc.

Rack Mounting

Use the ELAN RMK3 Rack-Mount Kit when installing the M86A in an equipment rack. The RMK3 is designed to facilitate mounting ELAN dual rack-space Multi-Room Audio Controllers into standard 19" equipment racks in order to provide optimum air flow and heat dispersion for these units. The RMK3 will take up three rack spaces when installed.

Pre-Wire

This section explains the specifics of pre-wiring for an M86A system. Care should be taken at this stage to ensure a properly operational system.

Most system wiring is "home-run" from the device being installed (a touchpad, for example) back to the equipment location.

ELAN pre-wiring recommendations for connections to the M86A

Item	Description
ELAN HC6 or HC12 System Controller	Control: Category 5 network cable System IR: 3.5mm Stereo Cable Source IR: DB-15 Male to Female Cable (Included with M86A) Internal Player Audio: RCA Interconnect Cables
TS7 Touchscreens	Control: Category 5 network cable Power: 2 Conductor (16 AWG) Video: RG-6 or RG-59 Coaxial Cable
TS2 Touchpads	Category 5 cable
IR Receivers	Category 5 cable
Volume Controls	Control: Category 5 cable Speaker Wiring: 16-18 AWG 2 or 4 conductor Use stranded, twisted pair speaker wire between amplifiers and volume controls, and between volume controls and speakers. Use Cat-5 to power electronic volume controls and for volume control override when used with an ELAN C2 Communications Controller.
Speakers	16-18 AWG speaker wire Use stranded, 2 or 4 conductor speaker wire between amplifiers and speakers.
Remotely Located Sources	Audio: Category 5 cable Video: RG6 or RG59 coax (if necessary)
ELAN C2 Communications Controller	Category 5 cable When using an ELAN C2 Communications Controller, run Cat-5 for telephones and door stations. See the C2 Installation Manual for details.
Sense Inputs	Category 5 cable (3 conductors used) Use Cat-5 to extend sensor leads, if necessary.
System Audio	RCA Interconnect Cables

Applications

This section describes typical applications using the M86A for audio distribution. These are all basic in nature and should be used for guideline purposes only. Each application can be augmented as needed for individual circumstances. This section is for overall design purposes.

Please see Chapter 3: M86A Connections for specific wiring configurations.

Zone/Sub-Zone Definitions

A zone is defined as an area within a system that has independent source selection ability. A zone may be one room, or several combined areas. A sub-zone is a part of a zone - it shares source selection - but has independent control of volume. Typically, sub-zones use volume controls for volume up/down.

Stereo Zones

To create an independent stereo zone, simply connect the M86A's Speaker Outputs to a pair of speakers. Make sure to take into account the amplifier's 8 Ohm minimum impedance when choosing and configuring speakers. Volume is controlled at preamp level. Any speakers connected to these channels ramp volume up/down together. Use a TS2 touchpad, TS7 touchscreen or hand-held remote to control functions (including volume) in zones with this configuration.

Figure 2-1: Typical stereo zone example.

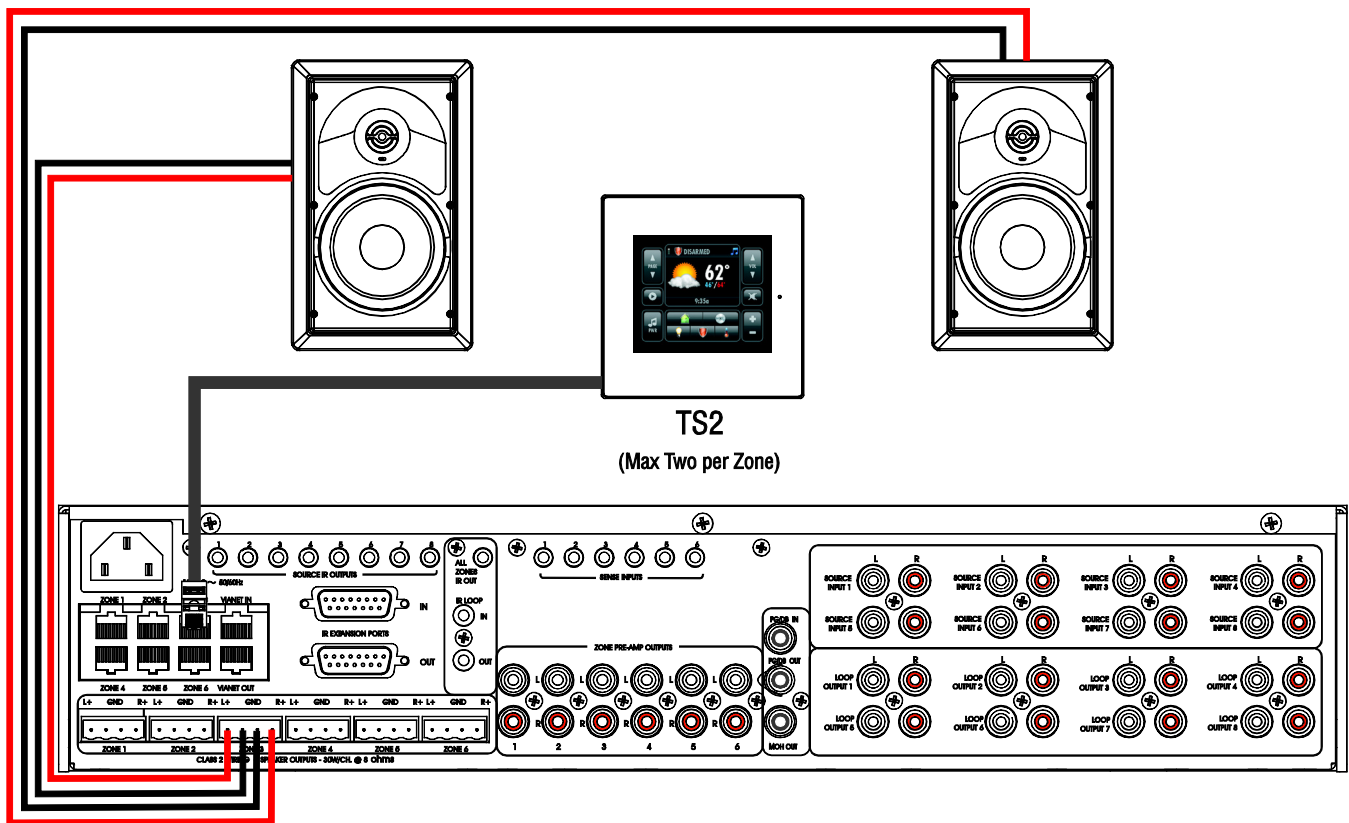

Stereo Zones w/ Stereo Sub-Zone Using Volume Controls

Connect the Zone Preamp Output to a pair of the external amplifier's inputs. Set the DIP switch for the Zone's Preamp Output to FIXED. Use an impedance matching volume control (ELAN VSE2) on the external amplifier's speaker outputs to maintain independent volume control capabilities in each room. The main zone ramps volume up/down at preamp level using commands sent from a TS2 Touchpad, TS7 Touchscreen, or hand held remote, while the sub-zone ramps volume up/down at speaker level using the volume control. This application uses one pair of amplifier channels from the M86A and one pair of amplifier channels from the external amplifier. Many areas of the home are ideal for zone/sub-zone configuration. Examples include Master Bedroom/Master Bath or Kitchen/Dining Area.

Figure 2-2: Stereo zones and a stereo sub-zone.

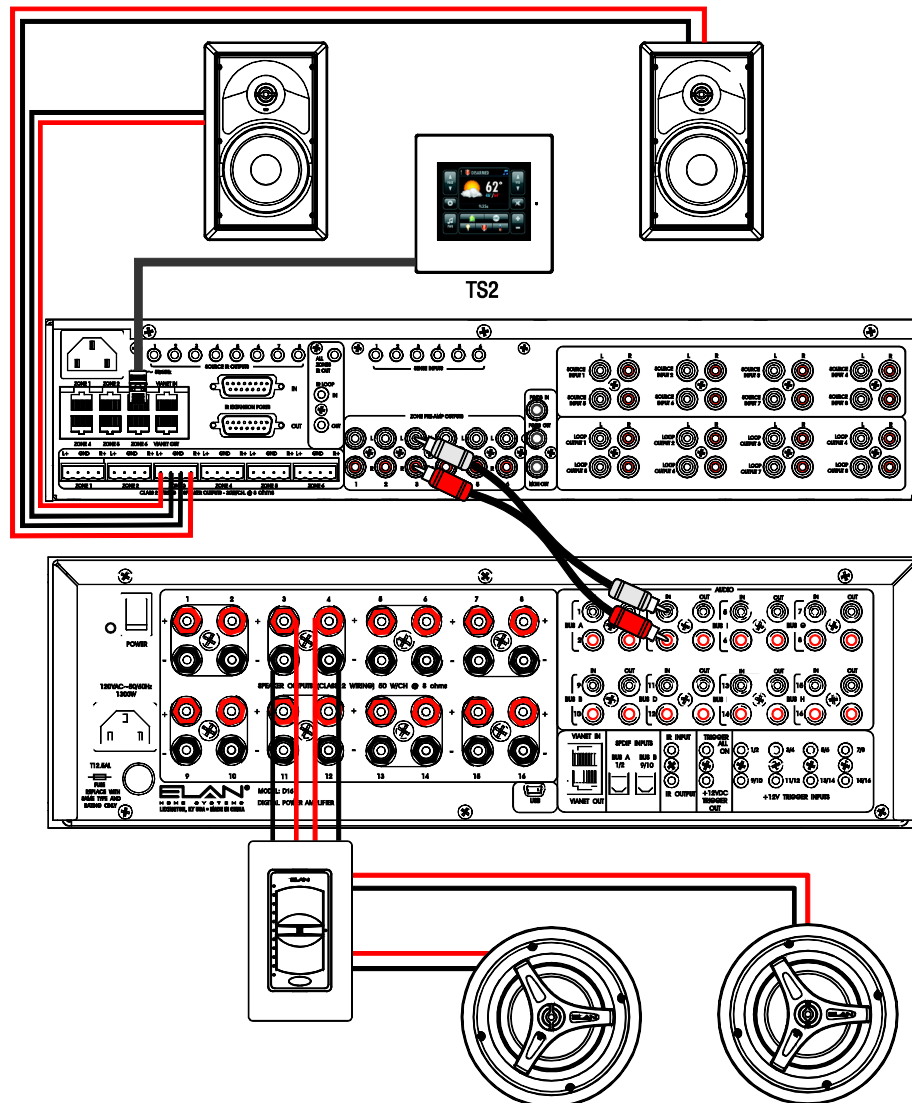

Stereo Zone w/ Multiple Sub-Zones

This application is ideal for large areas where independent volume control is needed in separate locations. Volume is controlled in a variable zone using, TS2 Touchpads, IR sensors, or TS7 Touchscreens. Sources for the entire zone are selected and controlled from this same touchpad, IR sensor, or touchscreen.

Connect the speaker outputs of the M86A to a pair of speakers in the main zone. Volume in this area will ramp up/down at pre-amp level using commands from the zone's touchpad, IR sensor, or touchscreen. Connect the Zone Pre-Amp Outputs of the M86A to the inputs of an external amplifier. Connect the speaker outputs of the external amp to two impedance matching volume controls, then to two pairs of speakers. Set the DIP switch for the zone to FIXED. The volume controls will ramp volume up/down only for the speakers that they are connected to, giving separate volume control in each areas of the zone. The volume up/down commands from the touchpad, IR sensor, or touchscreen will have no effect in the sub-zones. For mono sub-zones, use an RCA "Y" cable from the Loop Output of the amplifier to an additional input of the amplifier.

See **Figure 2-3** on the following page for an example using electronic volume controls and an RCA "Y" cable to set up a Stereo Zone with a Stereo Sub-Zone and a Mono Sub-Zone.

This application provides a stereo zone (connected to the M86As built-in amp), a stereo sub-zone (connected to a pair of external amplifier channels) and a mono sub-zone (connected to an additional channel of the external amplifier). If using electronic volume controls, a hand-held IR remote control can be used for source select and control in the sub-zone areas. If using rotary volume controls, all source selection and control must be done from the touchpad, IR sensor, or touchscreen.

NOTE: Amplifiers such as the ELAN D12 and D16 have advanced setup and control options that can eliminate the need for RCA "Y" cables and volume controls. See the manuals for those devices for information regarding these features.

Figure 2-3: Stereo Zone with a Stereo and a Mono Sub-Zone

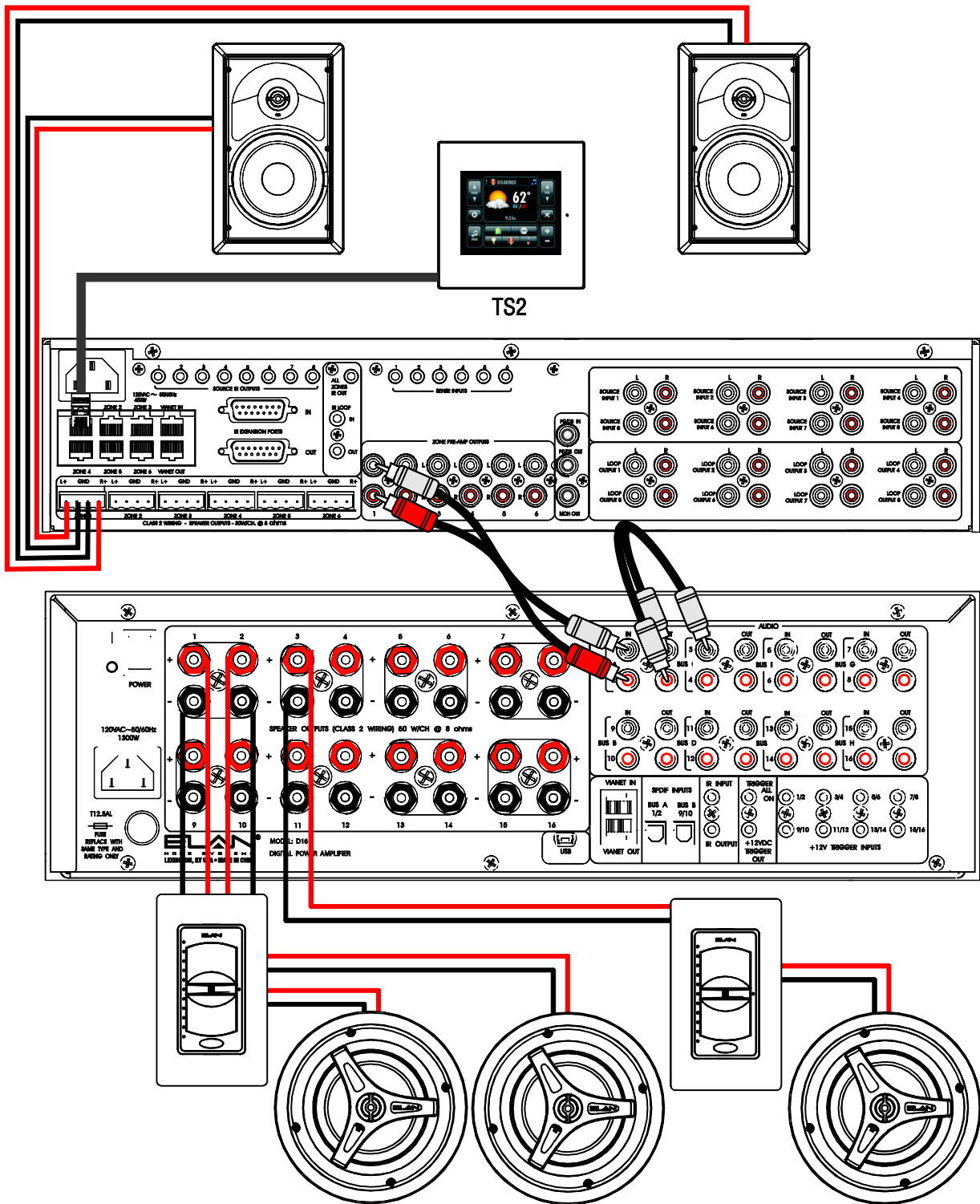

Chapter 3: M86A Connections

System Controller Connections

The M86A must be integrated with an ELAN HC6 or HC12 System Controller to function.

There are only four connections that need to be made between the M86A and the System Controller. Additional System Controller connections (other than from the M86A) are described in the respective manuals for the System Controllers.

Connections to the HC6 and the HC12 from the M86A are identical. The images used here are the HC6. See Figure 3-2 on page 19 for the connections.

VIANet Connection

The VIANet connection allows the System Controller to send commands to the M86A and to receive system status from the M86A. Trigger information (from M86A Sense Inputs or from the C2 Communication Controller, for example) is also transmitted over the VIANet connection from the M86A. Connect the VIANet OUT of the System Controller to the VIANet IN of the M86A.

This connection uses Cat5 terminated with the ELAN standard color code as shown below.

Figure 3-1: ELAN Standard Color Code

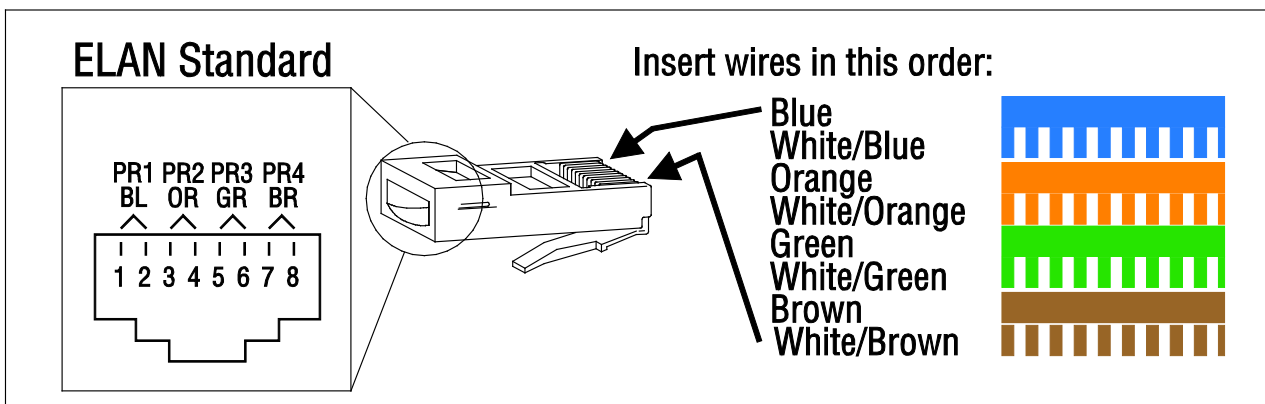

System Controller Connections (Continued)

IR Expansion Port Connection

The IR Expansion Port connection allows the System Controller to send SOURCE IR commands to the M86A to be routed to the SOURCE IR OUTPUTS of the M86A. This connection uses a DB-15 Male to Female cable (included with the M86A) from the **IN** IR Expansion Port of the M86A to the IR LINK connection of the System Controller.

All Zones IR Out Connection

The All Zone IR Out connections allows IR commands received by the M86A (from a TS2's IR receiver, for example) to be routed to the System Controller. These commands can be used to trigger Event Maps that have been set up in the ELAN configuration software and programmed into the System Controller. This connection uses a 3.5mm Stereo cable.

Source Input Connections

The HC6 and the HC12 have RCA line-level audio outputs for their Internal Players. These must be connected to the Source Audio Inputs of the M86A if the Internal Players are going to be used as sources. This connection uses standard RCA cables.

Figure 3-2: Connections to System Controller

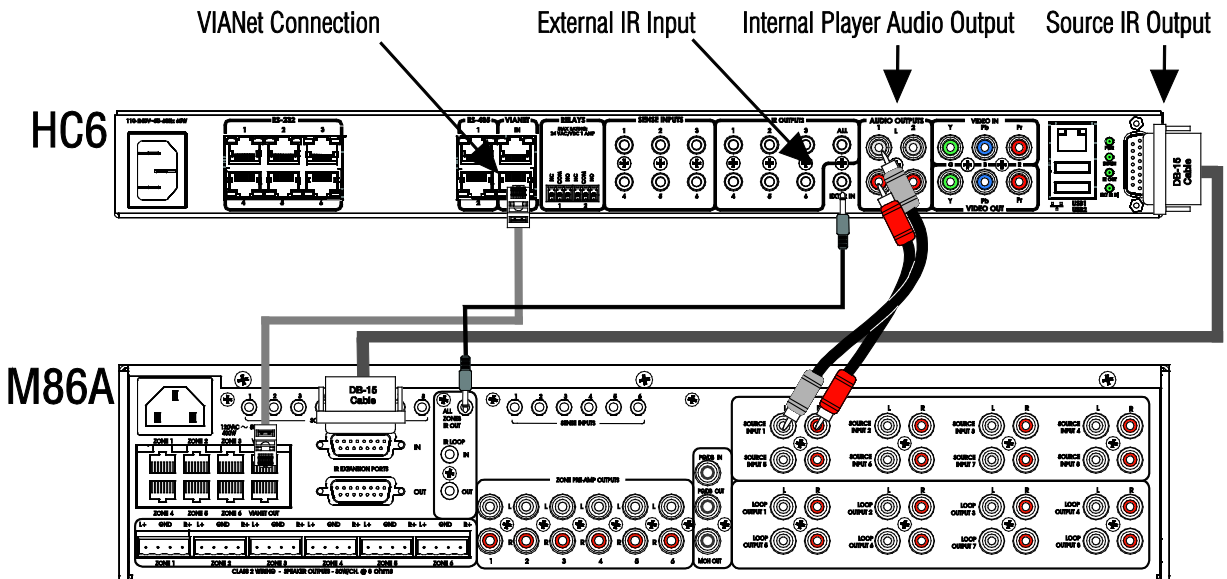

M86A Connections

TS2 Touchpads

TS2 Touchpads connect to the Zone Inputs on the M86A using Cat5 wiring.

Figure 3-3: Zone Inputs

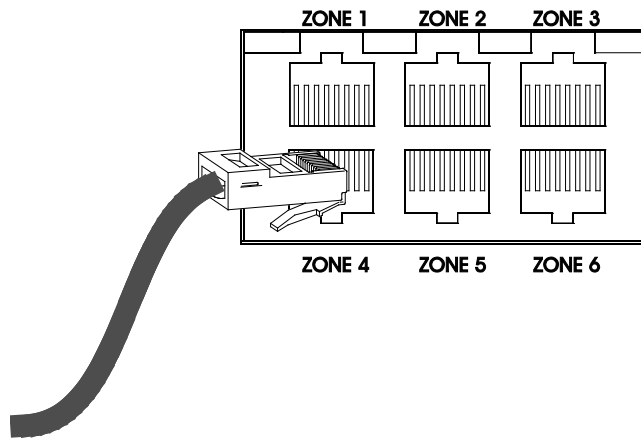

This termination uses the ELAN standard color code as shown below.

Figure 3-4: Wiring Configuration

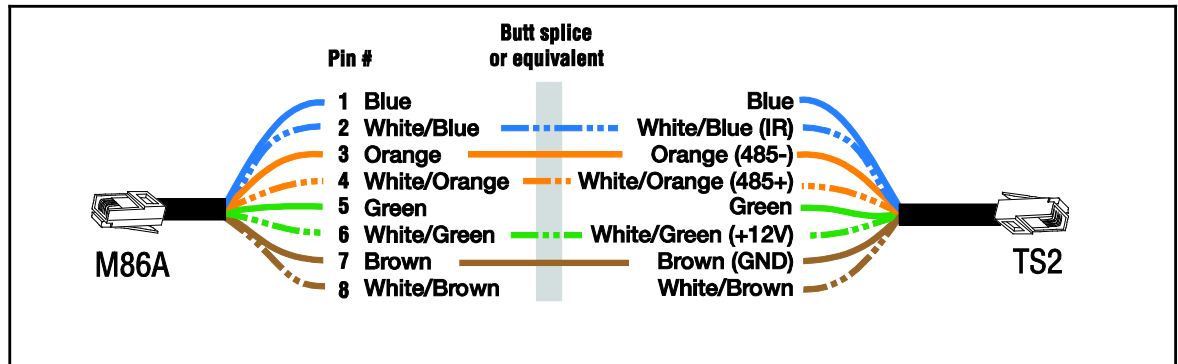

Each Zone Input connection can support TWO TS2s.

Use RJ45 Y-bridges like the L-com® ECS204-1 to facilitate wiring when connecting two TS2s to one zone.

Source IR Output Connections

The M86A features 8 source-specific IR emitter outputs. Each of these outputs is active only when the assigned source is selected. This makes it possible to use identical source components and still have the capability of separate control. For sources such as a multi-output music server, the ELAN configuration software can route IR for either output to the same IR port, eliminating the need to use IR “Y” cables.

When connecting multiple M86A chassis, it is only necessary to connect IR controlled sources to chassis # 1.

Figure 3-5: Source IR Outputs

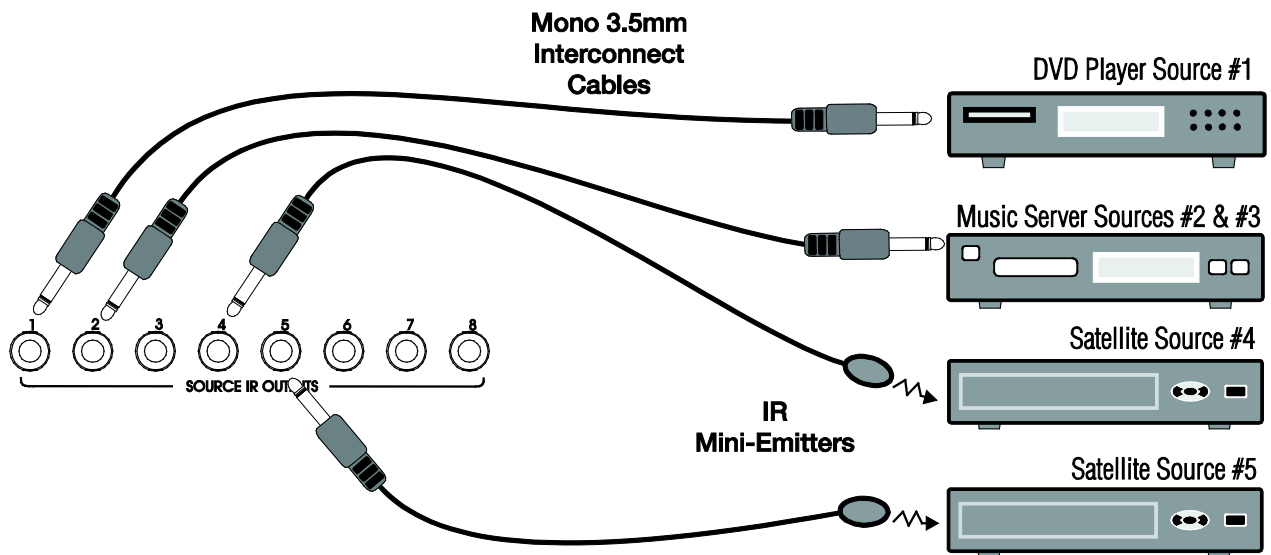

Sense Input Connections

The Sense Inputs of the M86A are used to conditionally execute macros and to trigger Event Maps that have been programmed into the System Controller using the ELAN configuration software.

When used with a conditional macro the sensor is connected to the device being monitored. The ELAN configuration software can be used to create a macro that checks the status of the sensor prior to issuing a command. This “conditional programming” can be used to prevent a TV, for example, from being inadvertently turned on or off when changing sources or turning a zone on or off.

Event Maps can be programmed that execute a command or sequence of commands when a Sense Input is triggered. For example, a driveway sensor can be used to activate an ELAN contact closure sensor to trigger an Event Map that turns on the outside lights. The status of a light sensor can be used to make the triggering of the Event Map conditional. If it is daytime the lights don’t come on. If it is nighttime, they do.

Figure 3-6: Sense Inputs

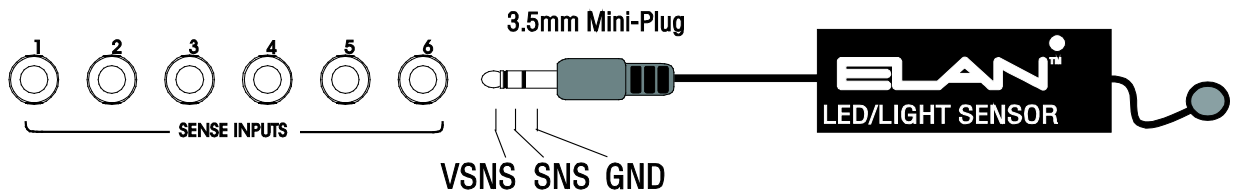

The M86A provides +5 VDC to the TIP (VSNS) connection to power the Sensor. When the Sensor is activated, it shorts the ring (SNS) to the sleeve (GND) thereby triggering the M86A’s Sense Input.

Available ELAN sensors include: AUDIO, VIDEO, CONTACT CLOSURE, VOLTAGE, LED/LIGHT, CURRENT/MAGNETIC FIELD and DOORBELL sensors.

Zone Preamp Audio Outputs

Each zone of the M86A has a corresponding Zone Preamp Output that is used to send signals to auxiliary amplifiers-typically for sub-zone applications. Each zone's audio is sent out of both the Speaker Outputs and the Zone Preamp Outputs simultaneously. Use the M86A's front panel DIP switches to configure the Zone Preamp Outputs to FIXED or VARIABLE.

(Factory Default setting is VARIABLE)

FIXED zone pre-amp outputs are set to full volume at all times. Typically, FIXED subzones have their own volume control in order to have independent volume Up/Down control and will always share the source that the rest of the zone is playing.

VARIABLE zones ramp volume Up and Down using commands sent from a touchpad, touchscreen or hand-held remote. VARIABLE sub-zones share both source selection and volume Up/Down functionality (all speakers ramp volume Up/Down simultaneously).

Figure 3-7: Pre-Amp Audio Outputs

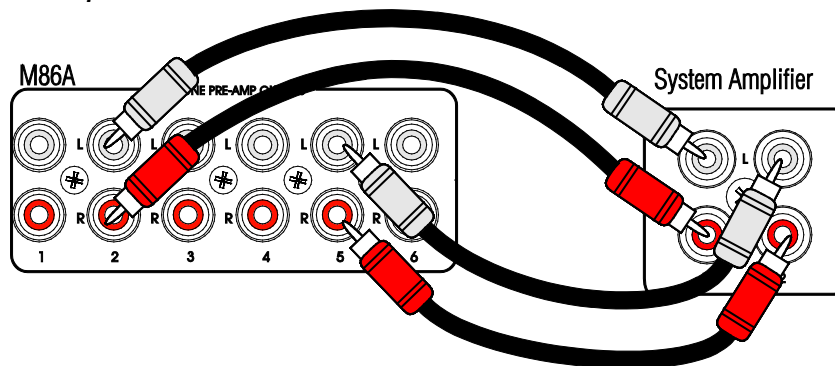

Source Audio Connections

There are 8 Audio SOURCE INPUTs on the M86A. Each system source is connected to a specific SOURCE INPUT, allowing audio distribution to any zone of the M86A.

Figure 3-8: Source Audio Inputs

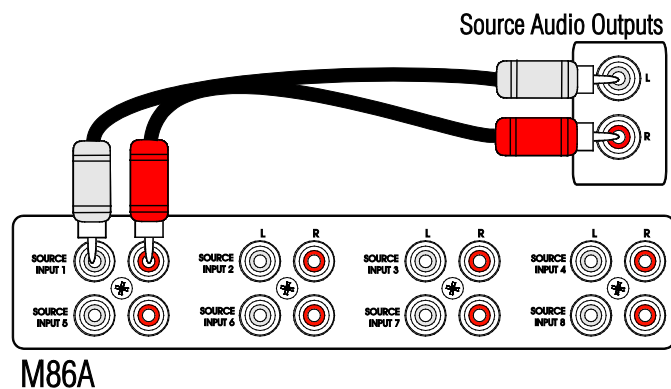

Speaker Outputs

The Quick Lock connectors on the M86A accept 18 to 16 AWG speaker wires. These wires can be directly connected to speakers located throughout the home, or, for a professional appearance, can be connected to speaker wall plates using bare leads or banana plugs.

Note: Because the Speaker Outputs are always VARIABLE, it is NOT RECOMMENDED to use Volume Controls with the M86A’s internal amplifier. *Unanticipated volume functionality may result.* Sub-zones requiring the use of Volume Controls should utilize an external amplifier connected to the M86A’s ZONE PREAMP OUTPUTS. The ZONE PREAMP OUTPUTS should be set for FIXED OUTPUT using the front panel DIP switch.

Figure 3-9: Speaker Connections

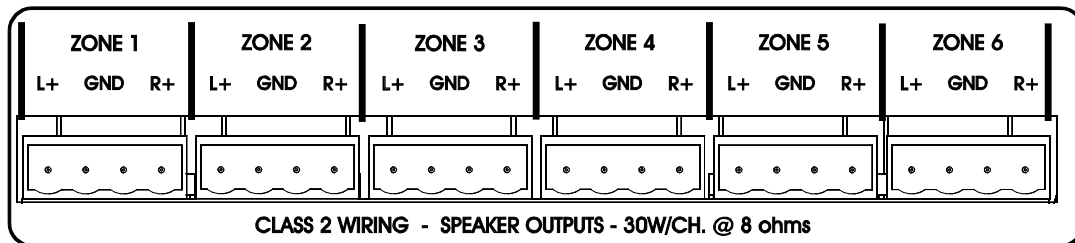

To Connect Speaker leads:

1. Open each Quick Lock connector.
2. Strip approximately 1/4” of the insulation from each speaker lead.
3. Twist the speaker wires to remove any loose strands.
4. Insert the leads into the connectors.
5. Close the connectors. Tug slightly on the speaker leads to ensure connectivity.

Figure 3-10: Quick Lock Connector

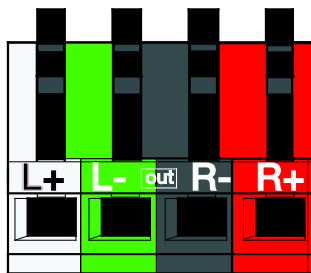

Important Notes:

- Use 18-16 AWG Stranded Copper Speaker Wire
- Do Not Configure Impedance Below 8 Ohms
- Do Not Bridge the Internal Amplifier
- Volume Controls are NOT Recommended
- Do not allow wire strands to short
- Connect speakers with power off

Multi-Chassis Connections

Additional connections are required when using multiple M86As in a system. These connections allow Source Audio IR, VIANet information, and Control to be shared between the chassis. Up to four M86As may be used in one system.

Loop Audio Outputs

In a multi-chassis M86A system, it is necessary to use RCA cables to allow Source Audio to be shared between the chassis. Connect RCA cables from the Audio Loop Outputs of chassis # 1 to the Source Audio Inputs of chassis # 2 and continue this process until source audio has been connected to all M86A chassis in the system.

Be sure that each source connects to the same Source Audio Input on ALL chassis.

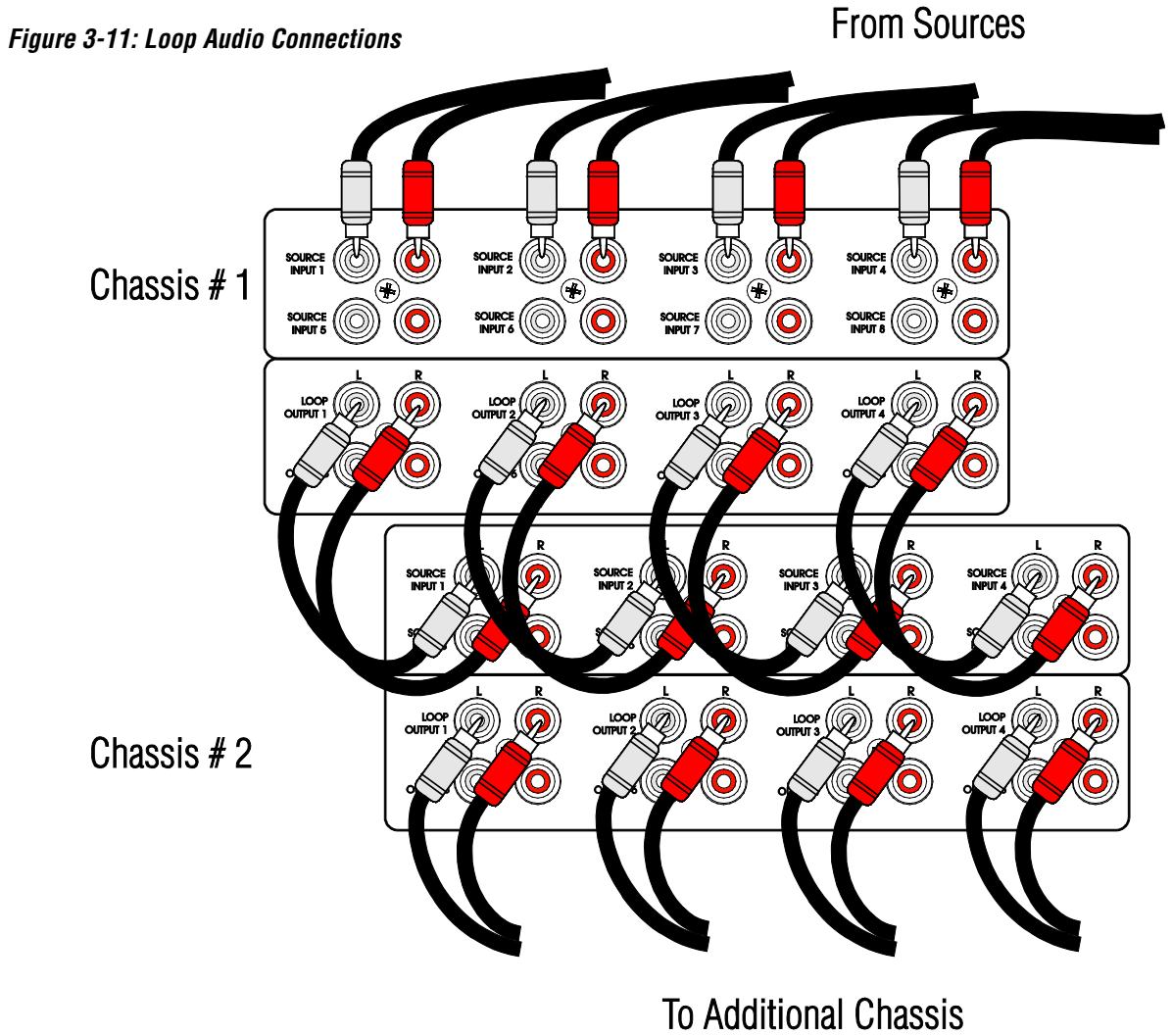

IR Loop Connections

The IR Loop Connection allows IR commands received by auxiliary M86A chassis to be transmitted to the main chassis.

Connect the LOOP OUT of the MAIN chassis to the LOOP IN of the second chassis and continue this process to all chassis.

This connection uses a 3.5mm Mono cable.

Figure 3-12: IR Loop Connection

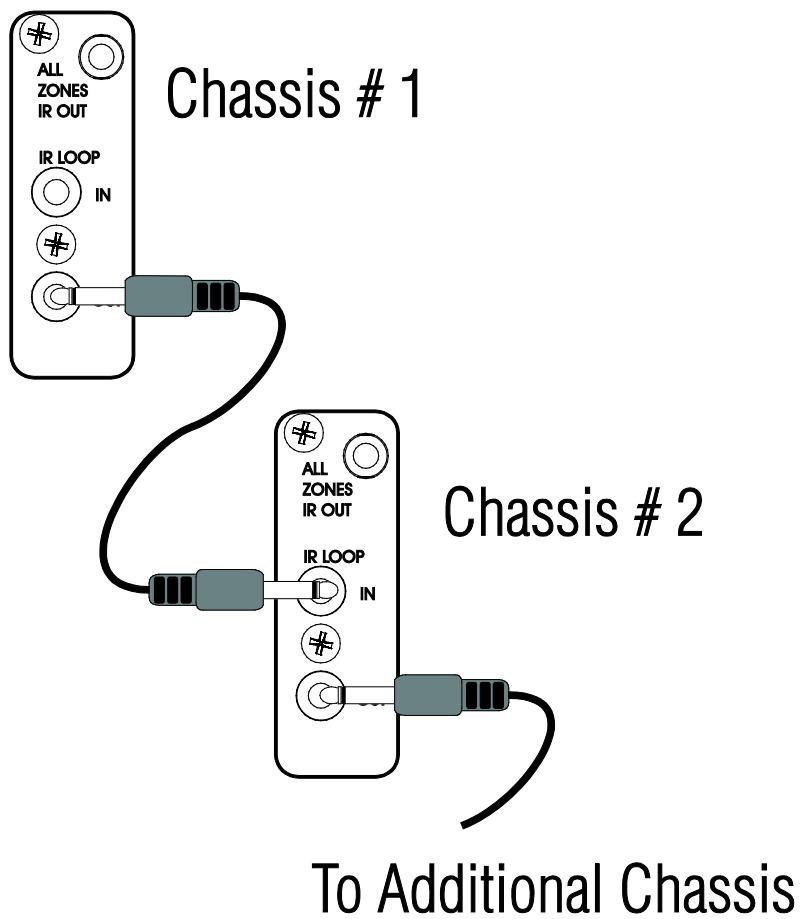

IR Expansion Port Connections

The IR Expansion Port Connections serve three purposes.

First, they allow IR commands from the System Controller to be routed to the SOURCE IR OUTPUTS of the main chassis.

Second, source IR commands from zones on the auxiliary chassis are routed directly to the SOURCE IR OUTPUTS of the main chassis.

Third, IR commands received by auxiliary M86A chassis are transmitted through the main M86A chassis' ALL ZONES IR OUT to the System Controller. These commands can be used to trigger Event Maps that have been set up in the ELAN configuration software and programmed into the System Controller.

Connect the IR EXPANSION PORT OUT of the MAIN chassis to the IR EXPANSION PORT IN of the second chassis and continue this process to all chassis.

This connection uses DB-15 Male to Female cables.

Figure 3-13: IR Expansion Ports

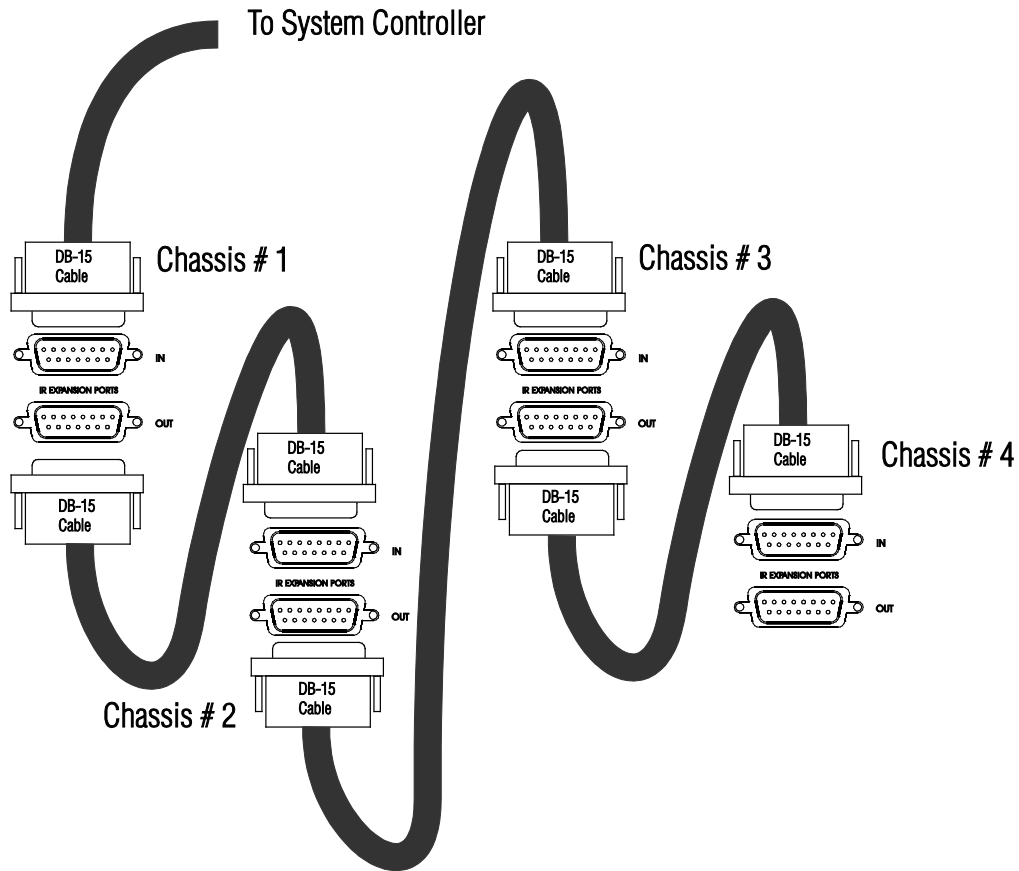

VIANet Loop Connections

The VIANet Loop Connection allows the System Controller to communicate with the M86A and for VIANet information to be shared between chassis. VIANet provides status feedback to TS2 Touchpads and is used to transmit serial data and Sense Input information between M86A chassis. VIANet also allows ELAN's C2 Communication Controller, V85 and V8 Video Routers and D Series amplifiers to interface with the System Controller.

Connect the VIANet **OUT** of the main chassis to the VIANet **IN** of the second chassis and continue this process to all chassis.

If VIANet controlled devices such as the C2 Communications Controller, D Series amplifiers or ELAN video routers are being used, continue the VIANet connection to them as well.

Figure 3-14: VIANet Loop Connections

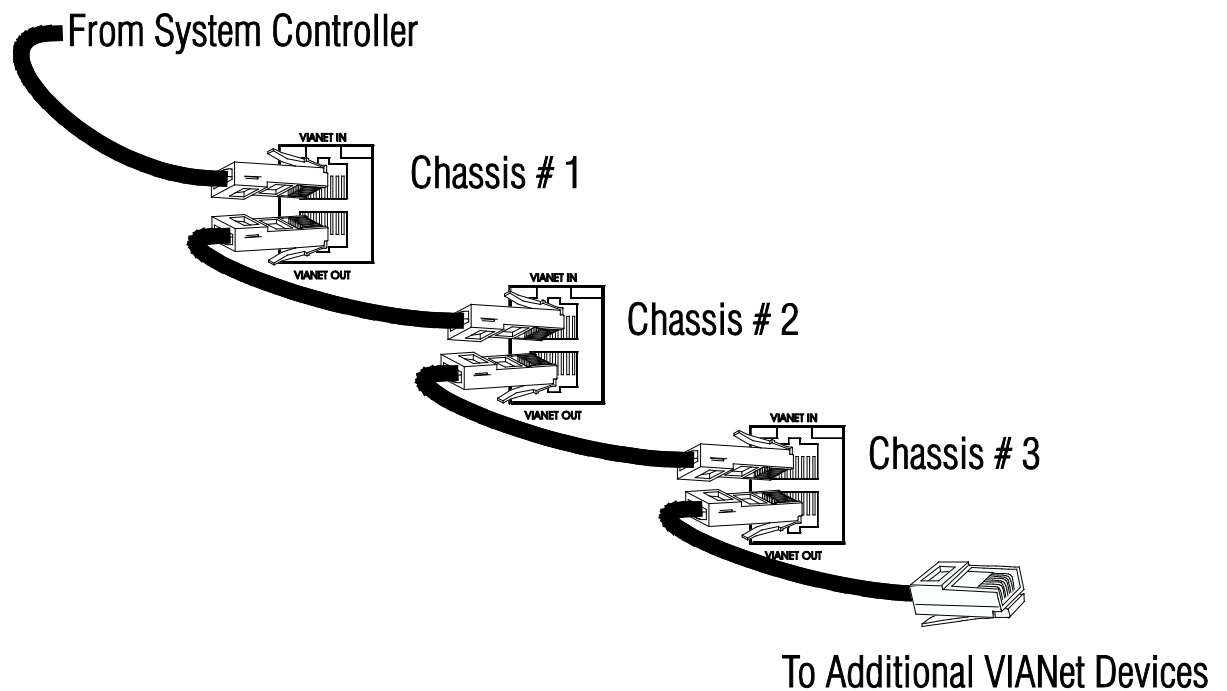

It is important to use the ELAN standard color code for VIANet connections.

VIANet data travels on conductors 3 and 4 and a twisted pair must be maintained for proper functionality. Both the TIA/EIA568A and TIA/EIA568B color codes split this pair.

(See pages 18 and 20 for information.)

Chapter 4: System Expansion

ELAN C2 Communication Controller Integration

The C2 Communication Controller integrates telephone and home automation features with the M86A and provides Music On Hold (MOH), Paging, Door Chime and Relay Activation features.

The audio from SOURCE INPUT # 1 of the M86A is used as the MOH input for the C2. The C2 sends a VIANet message when a Page or Door Chime is initiated that causes the M86A to mute any audio that is playing and pass the Page or Door Chime audio to the M86A's zones. The ELAN configuration software allows Page and Doorbell to be independently enabled or disabled in each zone. Page and Doorbell volume can be set at different levels from zone to zone and within the same zone. The C2's relays are controlled by touchtone telephones.

Make all C2 connections to phone lines, door stations and relay controlled devices as shown in the C2 manual.

Connect the MUSIC ON HOLD OUTPUT of the M86A (MAIN chassis only) to the MUSIC ON HOLD INPUT of the C2. Connect the PG/DB AUDIO OUTPUT of the C2 to the PG/DB INPUT of the main M86A.

If multiple M86As are being integrated, connect an RCA cable from the PG/DB AUDIO OUTPUT of the first M86A to the second M86A's PG/DB AUDIO INPUT. Continue this process to all chassis

Connect the VIANet Loop connections from the M86A to the VIANet connection of the C2.

Figure 4-1: C2 Integration

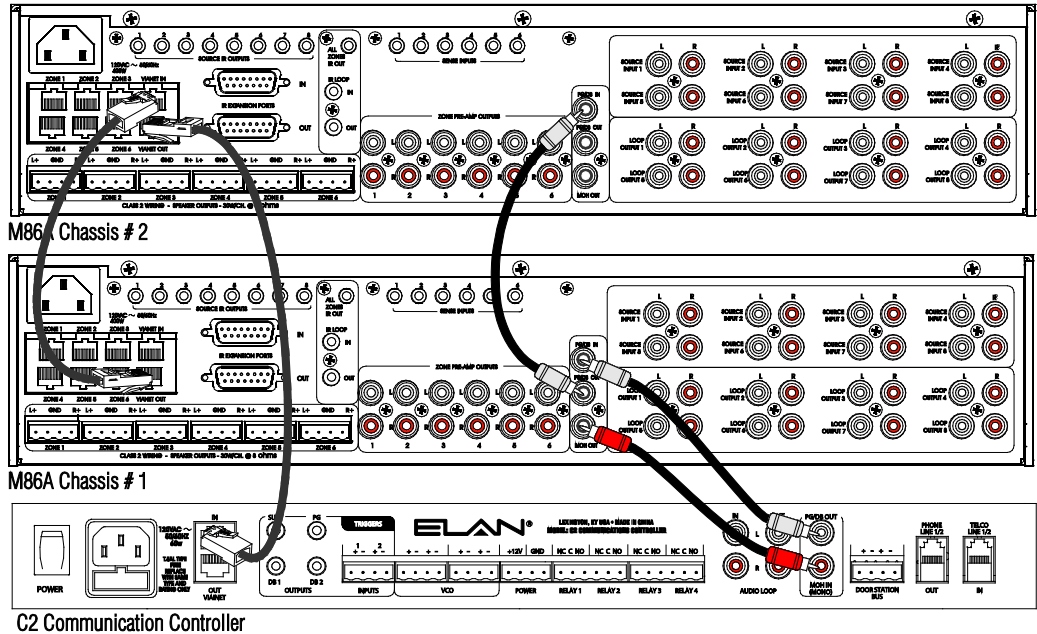

ELAN V8 Composite Video Router Integration

The ELAN V8 is a Composite Video Router that provides the ability to view up to 8 different video sources in 8 separate areas (or 16 areas using an additional V8).

When used with a System Controller, the V8 is controlled by VIANet commands so the VIANet Loop connection must be made. If a C2 Communication Controller is also being installed, be sure to loop the VIANet connection through it as well.

Connect the composite video outputs of the sources to the composite video inputs of the V8. Connect the Zone Outputs of the V8 to the monitor(s) or to TS7 Touchscreens video inputs.

Figure 4-2: V8 Integration

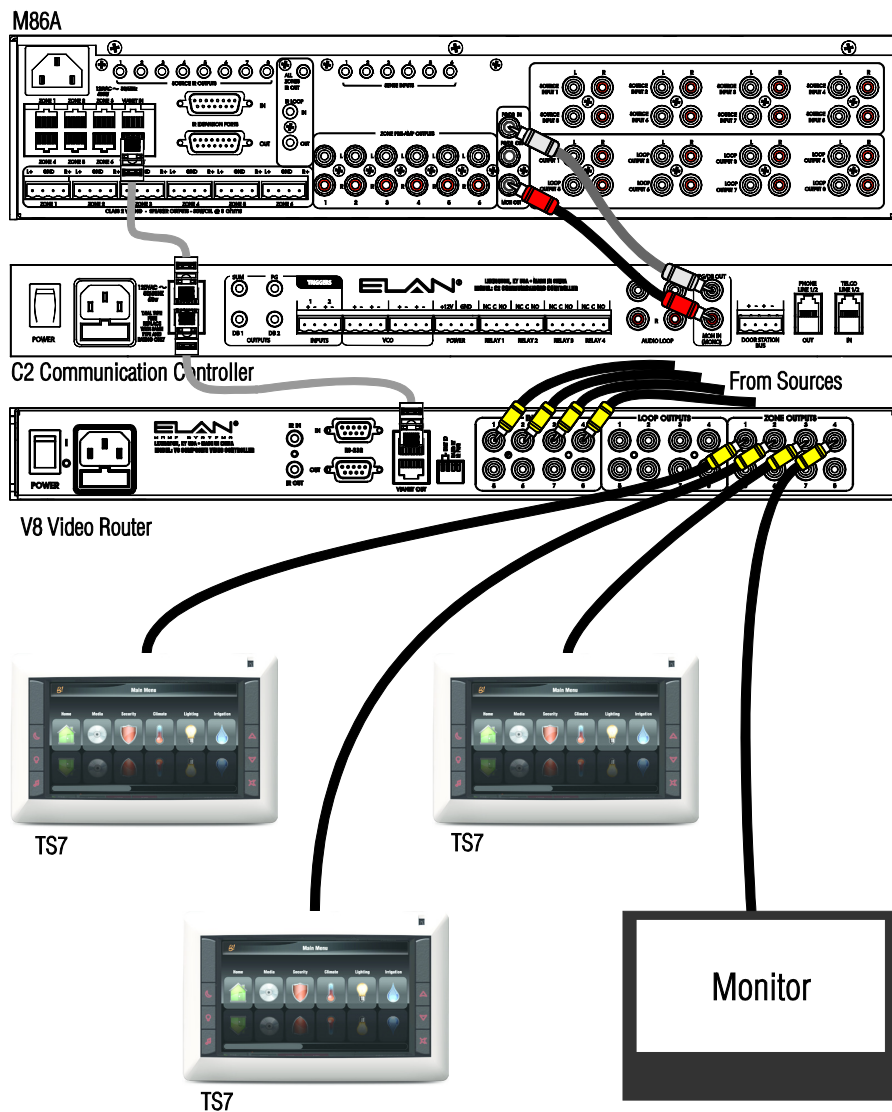

Chapter 5: Operation and Settings

Unit ID DIP Switch Settings

The M86A has Unit ID DIP Switches located behind the front panel access door. The Factory Default setting is Unit ID # 1. In a multi-chassis system, the MAIN chassis must be set to Unit ID# 1.

NOTE: Dipswitch # 1 is not used.

Figure 5-1: Unit ID DIP Switches

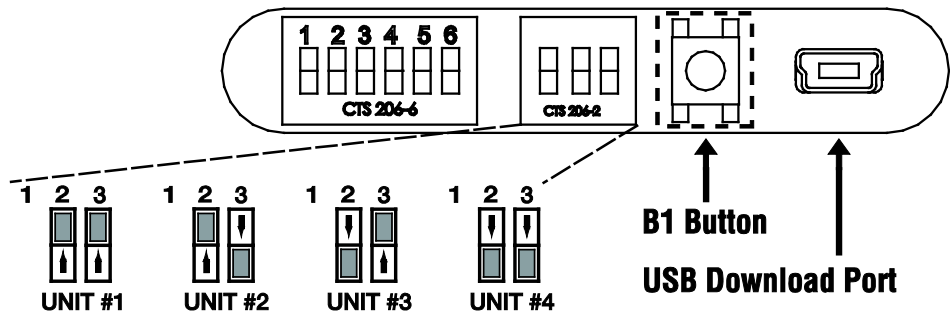

B1 Button Operation

The B1 button is used for basic functionality testing of the M86A. After the installation is completed, pressing the B1 button will initiate a test mode. The first button press will turn all zones on to source # 1. Additional presses will cycle through all eight sources, then turn the cooling fan on, and finally turn all zones and the fan off. Each chassis must be tested independently.

Front Panel LEDs

The M86A has 6 Zone Activity Status LEDs (one per zone), and a Power LED indicator.

Figure 5-2: Front Panel LEDs

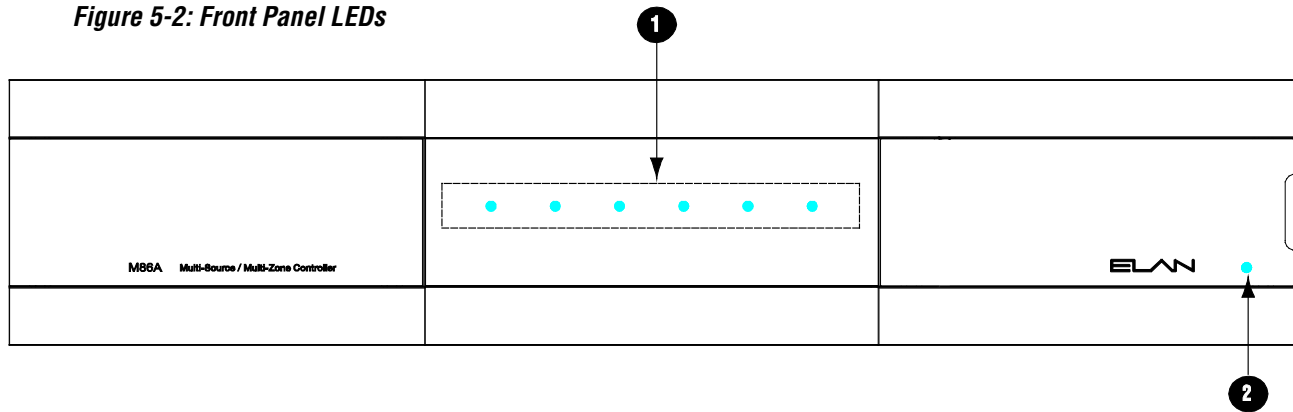

Item	Function
1	Zone Status Indicators Solid blue when the zone is on, Flickers when IR is being received in the zone
2	Power LED Solid blue when the M86A has AC power, Slow blink if unit is overheating, Fast blink if unit has shut down due to high temperature

Chapter 6: Troubleshooting

General

<i>Symptom</i>	<i>Possible Cause</i>	<i>Solution</i>
M86A will not power up.	<ol style="list-style-type: none"> 1. Power cable is disconnected 2. Circuit breaker tripped 	<ol style="list-style-type: none"> 1. Connect power cable 2. Set circuit breaker. The M86A draws 12 amps of AC current. Ensure that combined current draw of all devices on circuit does not exceed the circuit's capacity.

Audio

<i>Symptom</i>	<i>Possible Cause</i>	<i>Solution</i>
No audio in a specific zone.	<ol style="list-style-type: none"> 1. Source not playing 2. No source selected in the zone 3. Source selected in a different zone 4. Variable output turned down 5. Speakers or volume controls miswired 6. Pre-amp audio output connected to incorrect amplifier inputs 	<ol style="list-style-type: none"> 1. Press Play, tune station, turn source on etc. 2. Select a source 3. Use front panel LEDS to verify correct zone selected 4. Adjust volume 5. Correct wiring 6. Correct wiring
No audio in ANY zone	<ol style="list-style-type: none"> 1. See Above 2. Verify M86A is powered 3. Verify External amp is powered 4. Source Audio not connected to M86A 	<ol style="list-style-type: none"> 1. Perform steps above 2. See Above 3. Check power cord and breaker for amplifier 4. Connect Source Audio
Audio quits, zone LEDs turn off, no control over system, blue power LED blinking	M86A overheating or has gone into thermal shutdown	<p>Check ventilation</p> <p>Check fan operation (Use B1 button)</p> <p>Check speaker wiring for miswire causing a short</p> <p>Allow M86A to cool down until the power LED stops blinking and then turn zone(s) on at a low volume. If problem persists, call ELAN Technical Support</p>

Audio (Continued)

<i>Symptom</i>	<i>Possible Cause</i>	<i>Solution</i>
Audio "hum" or buzz through system speakers	<ol style="list-style-type: none"> 1. Ground potential difference between components (ground loop) 2. Source Input level is too high. 3. Faulty / damaged cables or speaker wiring 	<ol style="list-style-type: none"> 1. (a) Test AC outlet using ground tester. (b) Reverse the AC plug of components with non-polarized ends plugged into the same outlet strip as amp. (c) Isolate problem by disconnecting sources one at a time. 2. Reduce Input level settings in the ELAN configuration software. 3. (a) Check source equipment cables for damage or faulty connections (b) Check for shorts in speaker wiring or improperly wired volume controls.
Poor Audio quality. Audio is unclear, Bass response is low.	<ol style="list-style-type: none"> 1. Speakers out of phase 2. Defective / incompatible speaker 3. Incorrect Left/Right assignment of source or zone RCA cables 4. Poor audio cable connection between source and M86A. 	<ol style="list-style-type: none"> 1. Correct polarity of speaker wiring 2. (a) Check for physical damage to speaker. (b) Ensure speakers have appropriate power rating for amplifier. (c) Ensure speakers have at least 8 Ohm impedance. 3. Isolate to source or zone and correct. 4. Verify / correct connections
Audio plays at full volume in a variable zone	Zone pre-amp output Dip switch set to fixed	Correct DIP switch setting to make pre-amp output variable
No audio to one or more speakers	<ol style="list-style-type: none"> 1. Loose / bad speaker wire connections 2. Break or short in speaker wiring 3. Defective speaker(s) 4. Source not sending audio 	<ol style="list-style-type: none"> 1. Check speaker wiring connections. 2. Check speaker wire continuity with a multi-meter 3. Swap with known good speaker 4. Verify source is on and playing
Audio very distorted in areas using volume controls	<ol style="list-style-type: none"> 1. Impedance Match settings incorrect 2. Volume control miswired 	<ol style="list-style-type: none"> 1. Correct impedance match settings on volume control(s) 2. Check for proper in/out connections at volume control

Audio (Continued)

<i>Symptom</i>	<i>Possible Cause</i>	<i>Solution</i>
Incorrect source playing on speakers	<ol style="list-style-type: none"> 1. Source connected to wrong input of M86A. 2. Speakers connected to incorrect speaker outputs. 	<ol style="list-style-type: none"> 1. Verify / correct input connections. 2. Verify / correct speaker connections.

Video

<i>Symptom</i>	<i>Possible Cause</i>	<i>Solution</i>
Video not switching when using V8 Video Router	<ol style="list-style-type: none"> 1. VIANet connection faulty or not connected. 2. Incorrect programming 3. V8 unit ID not set correctly. 	<ol style="list-style-type: none"> 1. Connect Cat5 using VIANet wiring color code. Verify connections. 2. Verify / correct programming. 3. Set unit ID correctly.
Video switches but is incorrect	<ol style="list-style-type: none"> 1. Source video not connected to the correct input. 2. Video Outputs of the switcher connected to the wrong TS7s / monitors. 3. V8 unit ID set incorrectly. 	<ol style="list-style-type: none"> 1. Connect source video correctly. 2. Connect Video Outputs to the correct TS7s / monitors. 3. Set unit ID correctly.

Sense Input

<i>Symptom</i>	<i>Possible Cause</i>	<i>Solution</i>
Conditional commands / Event Maps not working properly	<ol style="list-style-type: none"> 1. Conditional programming / Event Map incorrect 2. Sensor faulty or not connected properly 3. Incorrect Sensor being used 4. VIANet connection not made / faulty 	<ol style="list-style-type: none"> 1. Verify / correct programming in the ELAN configuration software 2. Verify / correct Sensor operation and connection. 3. Use correct sensor 4. Verify / correct VIANet connection

IR/VIANet Control

<i>Symptom</i>	<i>Possible Cause</i>	<i>Solution</i>
Zone IR receive LED does NOT flash when a button is pressed.	<ol style="list-style-type: none"> 1. IR controller not programmed or programmed with a non-ELAN command. 2. IR signal path wiring bad. 	<ol style="list-style-type: none"> 1. Program IR controller or correct programming. 2. Verify IR signal path wiring. Check touchpads, IR sensors, etc.
Intermittent control from IR controller.	IR flooding.	Zone IR receive LED glowing or flickering when no commands are being sent indicates IR flooding. Possible sources: ambient light or plasma / LCD TV flooding.
Source IR commands not working	<ol style="list-style-type: none"> 1. IR Link not connected between System Controller and M86A 2. Incorrect Programming 	<ol style="list-style-type: none"> 1. Connect DB-15 Male to Female Cable 2. Correct Programming
Source IR commands only work from zones on MAIN chassis	IR Expansion ports not connected between M86A chassis	Connect DB-15 cables between M86A chassis
VIANet Commands not working	<ol style="list-style-type: none"> 1. VIANET wiring incorrect. 2. Chassis unit ID set incorrectly. 3. Incorrect commands 	<ol style="list-style-type: none"> 1. Verify / correct wiring. 2. Set chassis unit ID correctly. (See page 31.) 3. Verify / Correct programming

C2 Communication Control

<i>Symptom</i>	<i>Possible Cause</i>	<i>Solution</i>
No Music-On-Hold	<ol style="list-style-type: none"> 1. Source one isn't on / has no audio. 2. MOH Input Level on C2 is turned down. 3. MOH output of M86A not connected to MOH input of C2 	<ol style="list-style-type: none"> 1. Turn source one on, tune station, etc. 2. Adjust MOH Input Level – See C2 Manual 3. Connect MOH out of M86A to MOH in of C2.
No Page or Door Chime audio. Music does not mute when page or doorbell is activated.	<ol style="list-style-type: none"> 1. Zone is in Do-Not-Disturb. 2. VIANet connection faulty or not connected. 3. Programming 	<ol style="list-style-type: none"> 1. De-Activate Do-Not-Disturb setting. 2. Verify / Connect VIANet. See page 18 for color code. 3. Zone set to Do-Not-Disturb in ELAN configuration software.
No Page or Door Chime audio. Music does mute when page or doorbell activated.	<ol style="list-style-type: none"> 1. C2 Page / DB Output level turned all the way down. 2. PG/DB Output from C2 not connected to PG/DB Input of M86A. 3. Zone PG or DB volume set too low. 	<ol style="list-style-type: none"> 1. Adjust PG/DB Output of C2. See C2 manual. 2. Connect PG/DB Output of C2 to M86A. "Loop" connection to all chassis. 3. Adjust volume settings in the ELAN configuration software.

Appendix A: Programming

While the M86A Multi-Room Controller is designed to work right out of the box with the HC6 or HC12 System Controller, ELAN configuration software provides customized functionality for the specific environment for which it is being configured. Variables can be set for:

- IR Routing
- Page Enable / Disable
- Page Volume
- DB Enable / Disable
- DB Volume
- WHM Enable / Disable
- DND Enable / Disable
- Zone Turn-On Volume
- Zone Bass / Treble / Loudness
- Source Input Levels

When the M86A is initially added to the system in the ELAN configuration software, the software will query the M86A for its firmware version. If a newer version of firmware is available, you will be prompted to update the M86A.

In order to update the M86A's firmware, pull out on the Access Door from the right side of the M86A front panel and connect a standard USB A to USB Mini B cable from a computer running Windows XP, Vista or Windows 7 to the USB Download port. Each M86A chassis is updated individually.

Figure A-1: USB Port

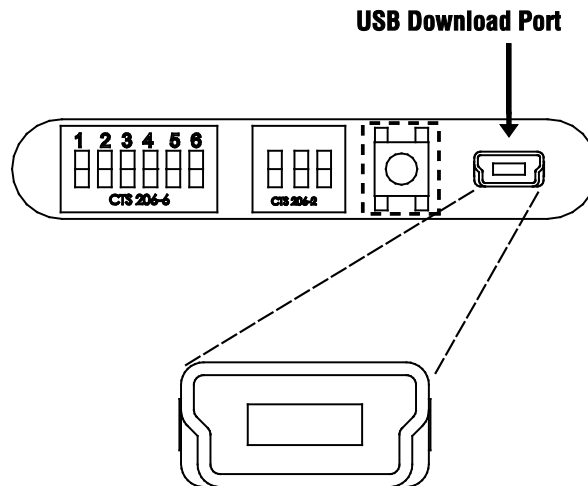

Once firmware has been updated, remove and reapply power to reboot the M86A.

Note: See the ELAN configuration software Reference Guide for specific programming steps.

Appendix B: Rack Mounting

RMK3 Rack-Mount Kit

When mounting the M86A controller in an equipment rack, use the optional RMK3 Rack Mount Kit for secure mounting and proper ventilation. The RMK3 requires three rack spaces. To install the RMK3 into a standard 19" equipment rack:

1. Slide the rack mount kit onto the M86A chassis from the front as shown in Figure B-1.

Figure B-1

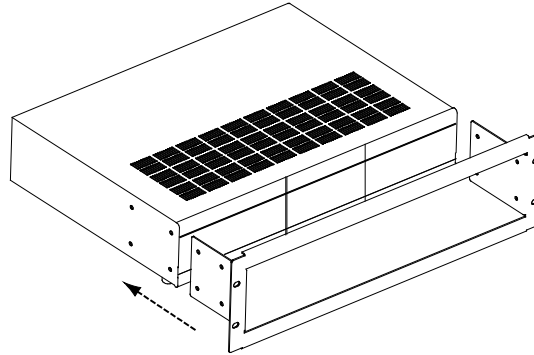

2. Ensure that the unit is flush with the front of the mounting kit. Install each of the eight screws (included) through the side mounting flanges into the holes in the sides of the unit as shown in Figure B-2. Hand tighten screws! Over-tightening could cause damage to the M86A Controller.

Figure B-2

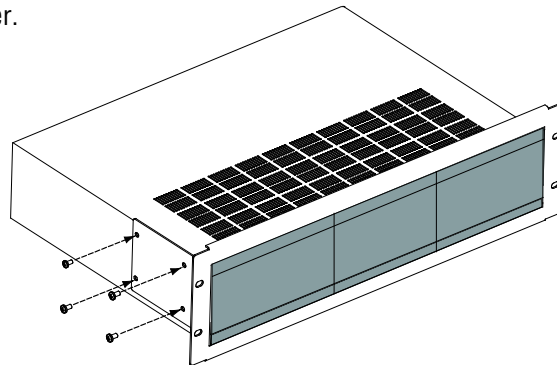

3. Once the unit is securely mounted into the RMK3, install the entire assembly into a standard 19" equipment rack from the front using four rack screws (not included).

Figure B-3

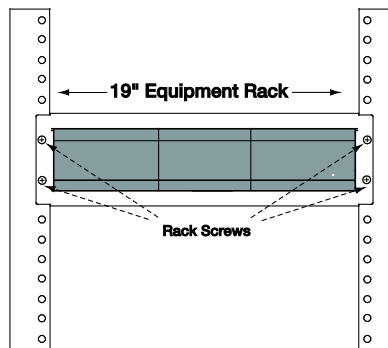

Specifications

Item	Description
System	Multi-Room Audio Controller
Source Inputs Input Sensitivity Input Impedance	0-2V RMS 47K Ohms
Pre-Amplifier Output Max. Output Power Frequency Response THD+Noise(@1KHz) Signal-to-Noise (A Weighted) Output Impedance	6dB 20Hz to 20kHz, +/-0.5dB <0.02% >95dB 600 Ohms
Amplifier Output Max. Output Power Speaker Impedance Frequency Response THD+Noise (@1KHz) Signal to Noise (A Weighted)	30W @ 8 Ohms 8 Ohms 20Hz to 20kHz, +/-0.5dB <0.02% >95dB
Music On Hold Output Output Impedance Max. Output Level	600 Ohms +6dB
Page & Doorbell Input Input Sensitivity Input Impedance	0-2V RMS 47k Ohms

Specifications (Continued)

Item	Description
Connectors AC Power VIA!NET IN/OUT TS2 Inputs (6) Zone Speaker Outputs (6) Source IR Expansion IN/OUT Zone Pre-Amp Outputs (6) Music On-Hold (MOH OUT) Page In/Out (PG IN/OUT) Source Loop Audio Outputs (8) Source Audio Inputs (8) ELAN Sense Inputs (6) Source IR Outputs (8) All Zones IR Output Programming	3-Prong Heavy Duty Cord RJ-45 RJ-45 Removable Quick Lock Connectors 15-Pin Connection RCA Type, Line Level Only RCA Type, Line Level Only RCA Type, Line Level Only RCA Type, Line Level Only RCA Type, Line Level Only 3.5mm Connectors (stereo) 3.5mm Connectors (mono) 3.5mm Connector (stereo) USB-Mini
General TS2 Power (Zone Input Connection) Power Requirements Power Consumption	300mA @ 12VDC per zone 120VAC 50/60 Hz (M86A240) 230-240VAC 50/60Hz 400 W
Dimensions w/Feet 2U w/out feet Weight Unit Weight Carton Weight	17"W x 4 1/8" H x 16 5/8" D (432mm W x 105mm H x 422mm D) 26 lbs (11.8 kg) 29 lbs (13.2 kg)

Limited Warranty

M86A

ELAN Home Systems, L.L.C. ("ELAN") warrants the M86A Multi-Room Audio Controller to be free from defects in materials and workmanship for the period of two years (2 years) from date of purchase. If within the applicable warranty period above purchaser discovers that such item was not as warranted above and promptly notifies ELAN in writing, ELAN shall repair or replace the item at the company's option. This warranty shall not apply (a) to equipment not manufactured by ELAN, (b) to equipment which shall have been installed by other than an ELAN authorized installer, (c) to installed equipment which is not installed to ELAN's specifications, (d) to equipment which shall have been repaired or altered by others than ELAN, (e) to equipment which shall have been subjected to negligence, accident, or damage by circumstances beyond ELAN's control, including, but not limited to, lightning, flood, electrical surge, tornado, earthquake, or other catastrophic events beyond ELAN's control, or to improper operation, maintenance or storage, or to other than normal use of service. With respect to equipment sold by, but not manufactured by ELAN, the warranty obligations of ELAN shall in all respects conform to the warranty actually extended to ELAN by its supplier. The foregoing warranties do not cover reimbursement for labor, transportation, removal, installation or other expenses which may be incurred in connection with repair or replacement. Except as may be expressly provided and authorized in writing by ELAN, ELAN shall not be subject to any other obligations or liabilities whatsoever with respect to equipment manufactured by ELAN or services rendered by ELAN.

THE FOREGOING WARRANTIES ARE EXCLUSIVE AND IN LIEU OF ALL OTHER EXPRESSED AND IMPLIED WARRANTIES EXCEPT WARRANTIES OF TITLE, INCLUDING BUT NOT LIMITED TO IMPLIED WARRANTIES OF MERCHANTABILITY AND FITNESS FOR A PARTICULAR PURPOSE.

ATTENTION: TO OUR VALUED CONSUMERS

To ensure that consumers obtain quality pre-sale and after-sale support and service, ELAN products are sold exclusively through authorized dealers. ELAN products are not sold online. The warranties on ELAN products are NOT VALID if the products have been purchased from an unauthorized dealer or an online E-tailer. To determine if your ELAN reseller is authorized, please contact ELAN at (859) 269-7760.

www.elanhomesystems.com