



TEMPEST DRAGON

15cc ARF

Code : SEA 313

ASSEMBLY MANUAL

“Graphics and specifications may change without notice”.



Specifications:

Wingspan-----	206 cm-----	81 inches.
Length-----	146 cm-----	57.5 inches.
Wing area-----	62.7sq.dm-----	971.2 sq.in.
Weight-----	4.5 kg-----	9.9 lbs.
Engine-----	15cc.	
Motor-----	Motor 90 / 85A / 6S-8S / 1800watt.	
Radio-----	6 channels 7 servos.	



INTRODUCTION

Thank you for choosing the **TEMPEST DRAGON 15cc ARF** ARTF by **SG MODELS**. The **TEMPEST DRAGON 15cc ARF** was designed with the intermediate/advanced sport flyer in mind. It is a semi scale airplane which is easy to fly and quick to assemble. The airframe is conventionally built using balsa, plywood to make it stronger than the average ARTF, yet the design allows the aeroplane to be kept light. You will find that most of the work has been done for you already. The motor mount has been fitted and the hinges are pre-installed. Flying the **TEMPEST DRAGON 15cc ARF** is simply a joy.

This instruction manual is designed to help you build a great flying aeroplane. Please read this manual thoroughly before starting assembly of your **TEMPEST DRAGON 15cc ARF**. Use the parts listing below to identify all parts.

WARNING

Please be aware that this aeroplane is not a toy and if assembled or used incorrectly it is capable of causing injury to people or property. WHEN YOU FLY THIS AEROPLANE YOU ASSUME ALL RISK & RESPONSIBILITY.

If you are inexperienced with basic R/C flight we strongly recommend you contact your R/C supplier and join your local R/C model Flying Club. R/C Model Flying Clubs offer a variety of training procedures designed to help the new pilot on his way to successful R/C flight. They will also be able to advise on any insurance and safety regulations that may apply.

KIT CONTENTS

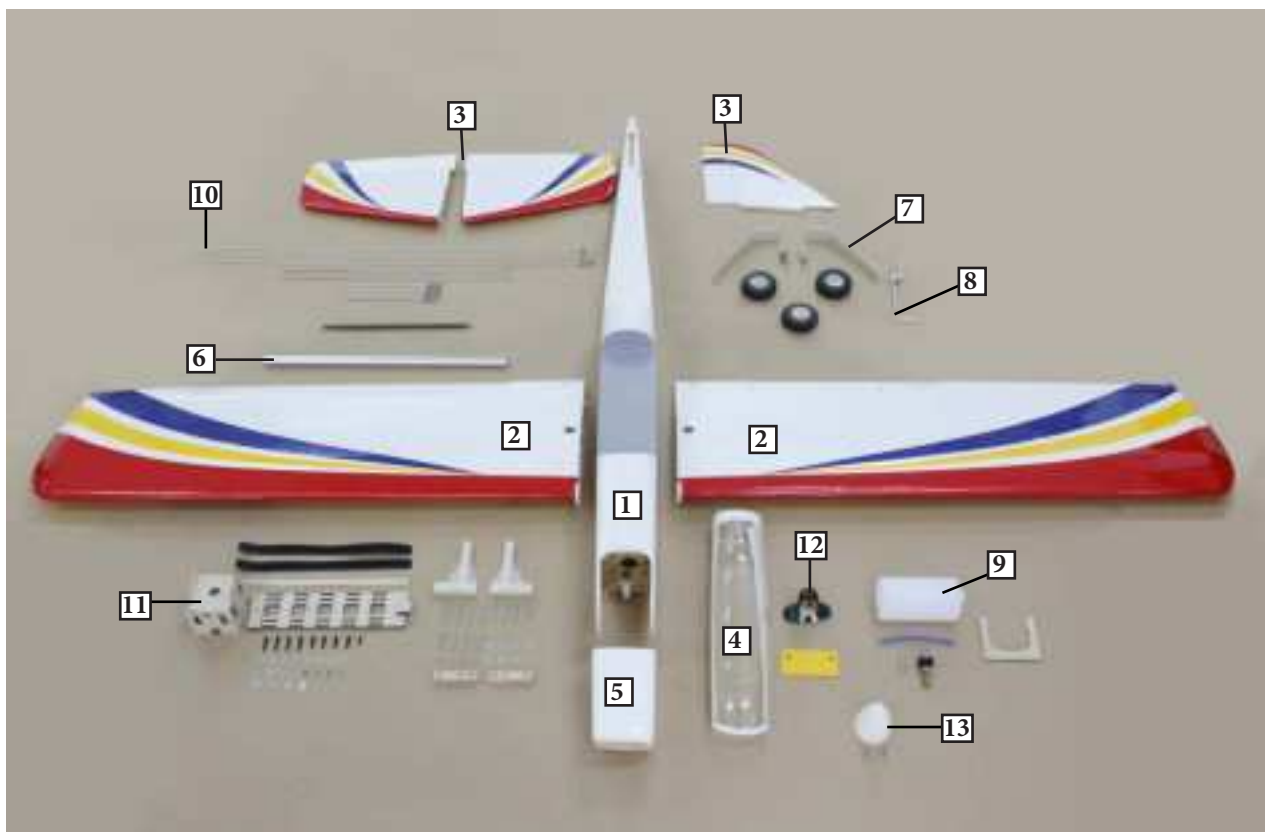

KIT CONTENTS

SEA313 TEMPEST DRAGON 15cc ARF

1. Fuselage
2. Wing set (2)
3. Tail set (2)
4. Canopy
5. Cowling
6. Wing tube
7. Landing gear
8. Nose Landing gear
9. Fuel tank
10. Pushrod set
11. Ep Motor box
12. Pilot
13. Spinner

ADDITIONAL ITEMS REQUIRED

- 15cc gasoline engine.
- Computer radio 6 channel with 7 servos.
- Glow plug to suit engine.
- Propeller to suit engine.
- Protective foam rubber for radio system.

TOOLS & SUPPLIES NEEDED

- Thin cyanoacrylate glue.
- Medium cyanoacrylate glue.
- 30 minute epoxy.
- 5 minute epoxy.
- Hand or electric drill.
- Assorted drill bits.
- Modelling knife.
- Straight edge ruler.
- 2mm ball driver.
- Phillips head screwdriver.
- 220 grit sandpaper.
- 90° square or builder's triangle.
- Wire cutters.
- Masking tape & T-pins.
- Thread-lock.
- Paper towels.

HINGING THE FLAP

Note: *The control surfaces, including the ailerons, elevators, and rudder, are prehinged with hinges installed, but the hinges are not glued in place. It is imperative that you properly adhere the hinges in place per the steps that follow using a high-quality thin C/A glue.*

Carefully remove the aileron from one of the wing panels. Note the position of the hinges.

1.



- Remove each hinge from the wing panel and flap and place a T-pin in the center of each hinge. Slide each hinge into the aileron until the T-pin is snug against the aileron. This will help ensure an equal amount of hinge is on either side of the hinge line when the flap is mounted to the wing panel.

2.

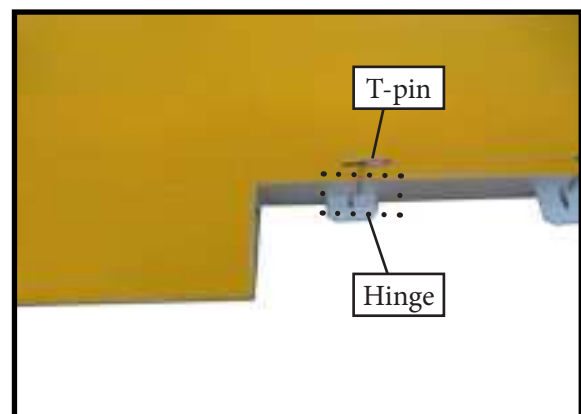

Slide the wing panel on the flap until there is only a slight gap. The hinge is now centered on the wing panel and flap. Remove the Tpins and snug the flap against the wing panel. A gap of 1/64" or less should be maintained between the wing panel and flap.

Deflect the flap and completely saturate each hinge with thin C/A glue. The flap front surface should lightly contact the wing during this procedure. Ideally, when the hinges are glued in place, a 1/64" gap or less will be maintained throughout the length of the flap to the wing panel hinge line.

NOTE : The hinge is constructed of a special material that allows the C/A to wick or penetrate and distribute throughout the hinge, securely bonding it to the wood structure of the wing panel and flap.

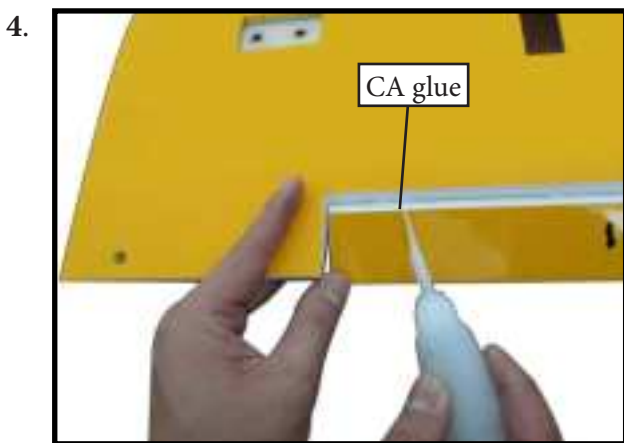
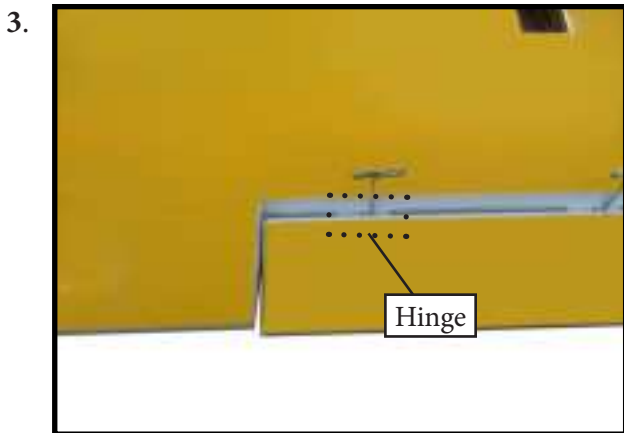

Turn the wing panel over and deflect the flap in the opposite direction from the opposite side. Apply thin C/A glue to each hinge, making sure that the C/A penetrates into both the flap and wing panel.

Using C/A remover/debonder and a paper towel, remove any excess C/A glue that may have accumulated on the wing or in the flap hinge area.

Repeat this process with the other wing panel, securely hinging the flap in place.

After both flap are securely hinged, firmly grasp the wing panel and flap to make sure the hinges are securely glued and cannot be pulled out. Do this by carefully applying medium pressure, trying to separate the flap from the wing panel. Use caution not to crush the wing structure.



Note : Work the aileron up and down several times to “work in” the hinges and check for proper movement.

HINGING THE AILERON

Note : *The control surfaces, including the ailerons, elevators, and rudder, are prehinged with hinges installed, but the hinges are not glued in place. It is imperative that you properly adhere the hinges in place per the steps that follow using a high-quality thin C/A glue.*

Carefully remove the aileron from one of the wing panels. Note the position of the hinges.

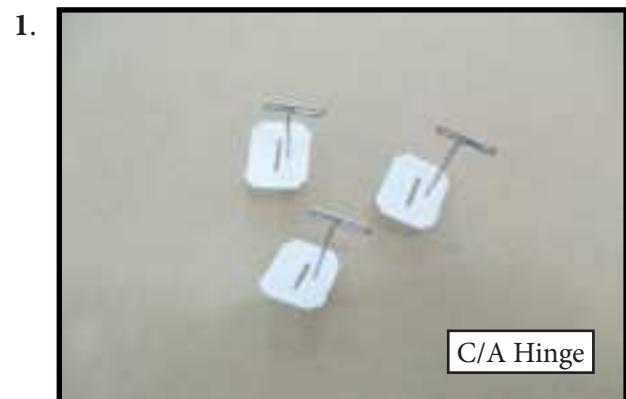

Remove each hinge from the wing panel and aileron and place a T-pin in the center of each hinge. Slide each hinge into the wing panel until the T-pin is snug against the wing panel. This will help ensure an equal amount of hinge is on either side of the hinge line when the aileron is mounted to the aileron.

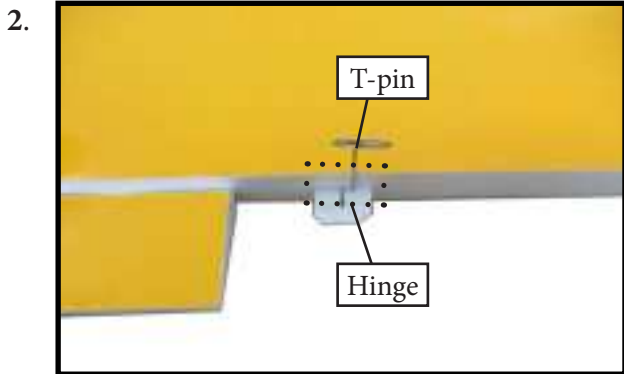

Slide the wing panel on the aileron until there is only a slight gap. The hinge is now centered on the wing panel and aileron. Remove the T-pins and snug the aileron against the wing panel. A gap of 1/64" or less should be maintained between the wing panel and aileron.

Deflect the aileron and completely saturate each hinge with thin C/A glue. The ailerons front surface should lightly contact the wing during this procedure. Ideally, when the hinges are glued in place, a 1/64" gap or less will be maintained throughout the length of the aileron to the wing panel hinge line.

NOTE : The hinge is constructed of a special material that allows the C/A to wick or penetrate and distribute throughout the hinge, securely bonding it to the wood structure of the wing panel and aileron.

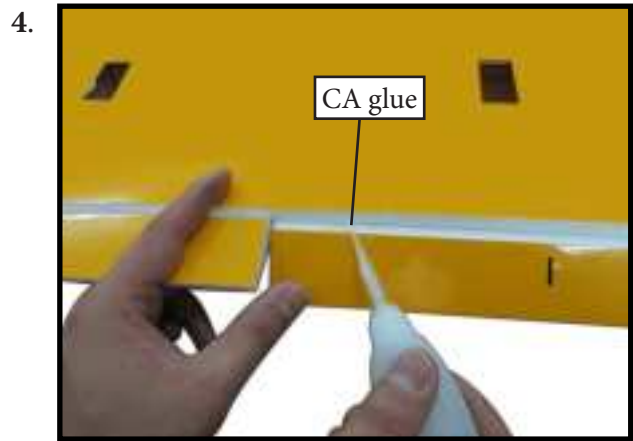
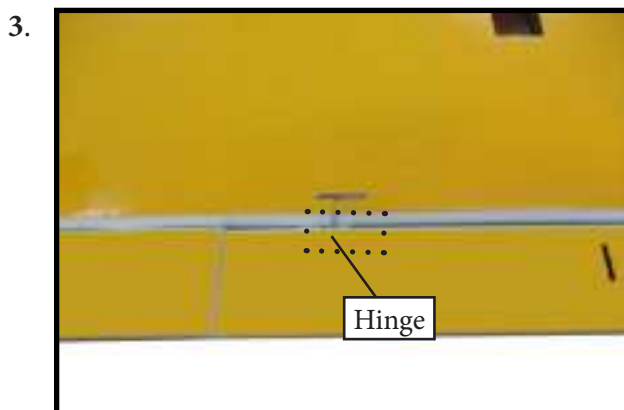

Turn the wing panel over and deflect the aileron in the opposite direction from the opposite side. Apply thin C/A glue to each hinge, making sure that the C/A penetrates into both the aileron and wing panel.

Using C/A remover/debonder and a paper towel, remove any excess C/A glue that may have accumulated on the wing or in the aileron hinge area.

Repeat this process with the other wing panel, securely hinging the aileron in place.

After both ailerons are securely hinged, firmly grasp the wing panel and aileron to make sure the hinges are securely glued and cannot be pulled out. Do this by carefully applying medium pressure, trying to separate the aileron from the wing panel. Use caution not to crush the wing structure.

7.



Note : Work the aileron up and down several times to “work in” the hinges and check for proper movement.

INSTALL THE AILERONS CONTROL HORN

Locate the aileron control horns. The taller control horn is used for the ailerons, and the shorter horn for the flaps.

1.



Use sandpaper to scuff the bottom of the aileron and flap control horns. Use a paper towel and isopropyl alcohol to remove any oils or debris from the control horns.

2.



Check the fit of the control horns to the aileron and flap. They should rest flush against the control surface as shown.

3.



Place low-tack tape 1/32 inch (1mm) from the control horn slot. This will prevent epoxy from getting on the control surface when the control horns are glued in place.

4.

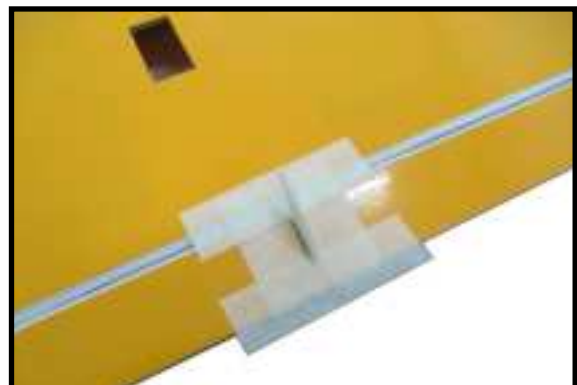

Remove the control horns from the control surfaces. Apply epoxy to the slot in the aileron and flap. Make sure the epoxy gets into the slot for a good bond between the surfaces and control horn.

5.

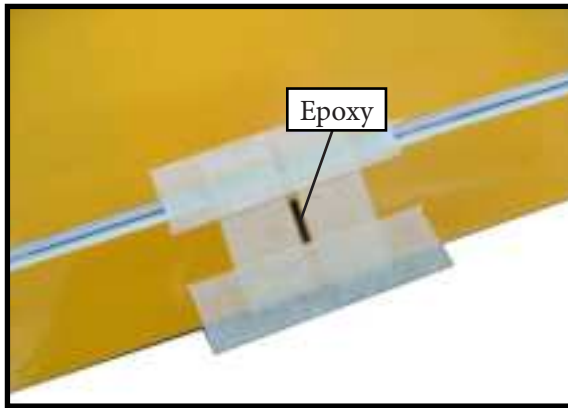

Apply epoxy to the area of the control horns that fist into the slots. Use enough epoxy so the control horns will be fully bonded to the fied surfaces.

6.

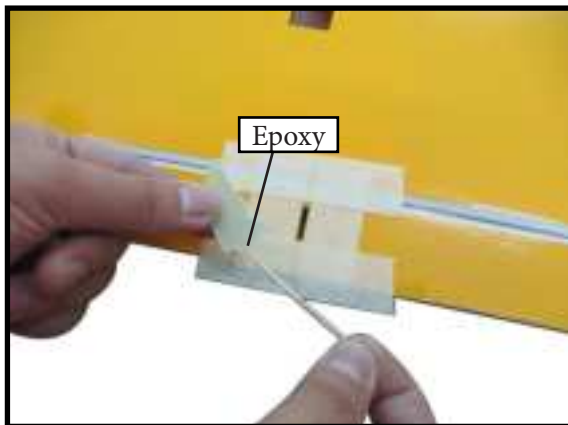

Before the epoxy fully cures, remove the tape from around the control horn. This will allow the epoxy to flow around the control horn, creating a small fillet between the control horn and surface for a fished look and secure bond.

7.



INSTALLING THE AILERON SERVOS

1.

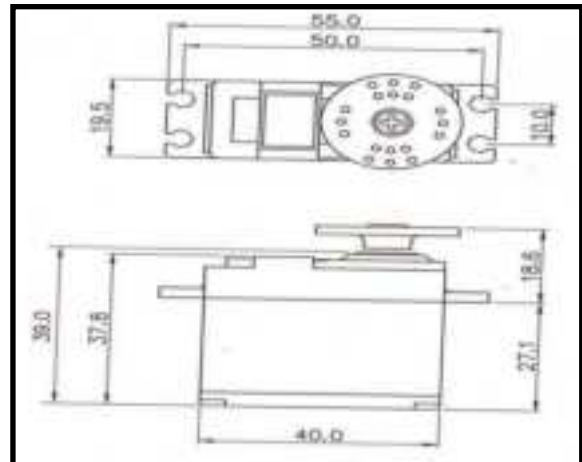

2.



Mininum servo spec.

Torque : 54 oz-in (3.9 kg-cm) @ 4.8V;
67 oz-in (4.8 kg-cm) @ 6.0V

Install the rubber grommets and brass collets onto the aileron servo. Test fit the servo into the aileron servo mount.

⚠ Because the size of servos differ, you may need to adjust the size of the precut opening in the mount. The notch in the sides of the mount allow the servo lead to pass through.

Use dental floss to secure the connection so they cannot become unplugged.

3.



Using a small weight (Weighted fuel pickup works well) and thread, feed the string through the wing as indicated.

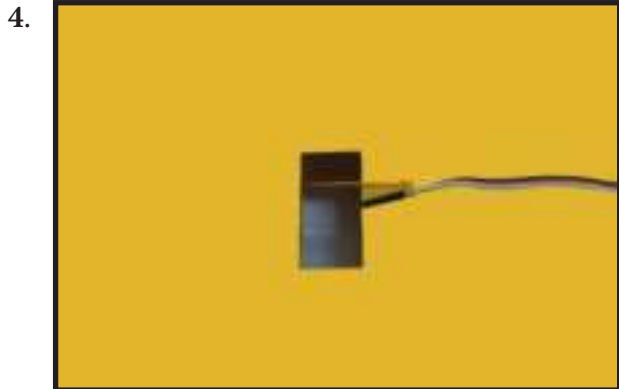

Attach servo lead to the aileron servo. Attach the string to the servo lead and carefully thread it through the wing. Once you have thread the lead through the wing, remove the string so it can use for the other servo lead.



Tape the servo lead to the wing to prevent it from falling back into the wing.

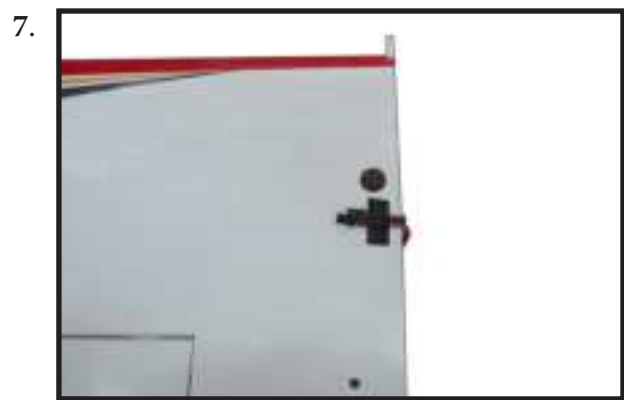

Reinstall the servo into the servo mount and secure the servo in place using the wood screws provided with your radio system.



Repeat the procedure for the other wing half.

AILERON PUSHROD INSTALLATION

Please study images below.

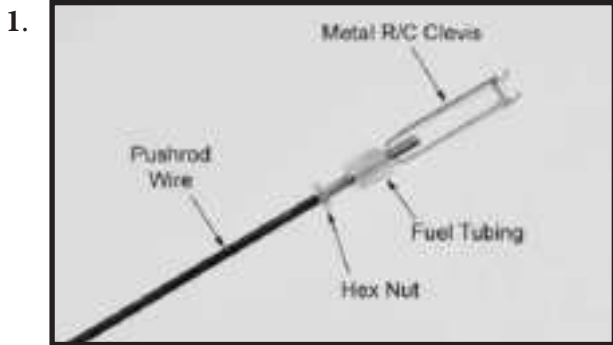

Use a felt tip pen to mark the wire where it crosses the hole. Use a pair of pliers to put a sharp 90-degree bend in the wire at the mark.

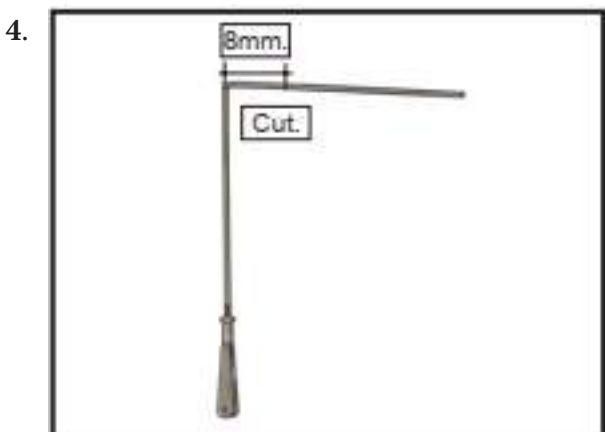
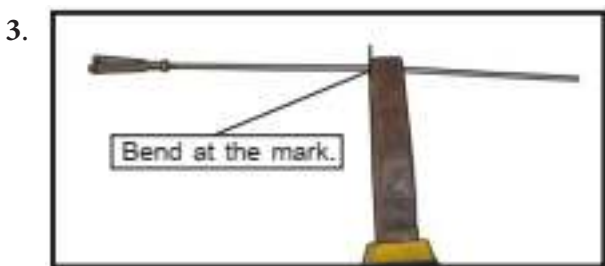

Make a 90-degree bend at the mark and cut off the excess wire leaving 8mm past the bend.

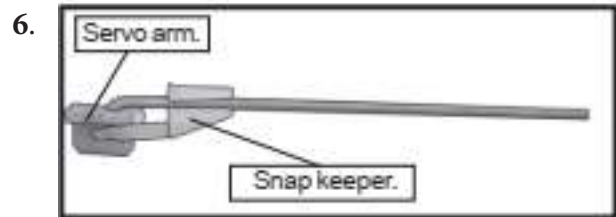
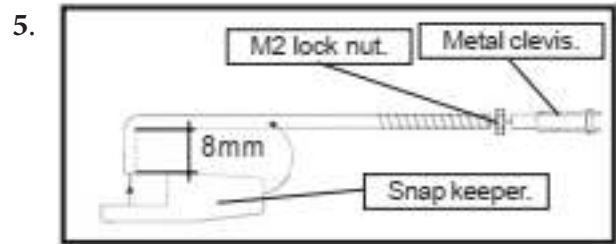

Connect the linkage as shown and secure the control wire with a snap keeper.



INSTALLING THE MAIN LANDING GEAR

NOTE: You must now decide if you will assemble the Classic Ugly Stick with tri-cycle landing gear or as a tail dragger. If you are assembling as a tail dragger, please skip the nose gear installation steps and mount the main gear to the FORWARD mounting location. If you are assembling using the tri-cycle landing gear, please skip the tail wheel installation steps, Install the nose gear, and mount the main gear to the REAR mounting location.

The blind nuts for securing the landing gear are already mounted inside the wing set.

Using the hardware provided, mount the main landing gear to the wing set.

Place the wing set inverted on the work bench in a suitable stand. Set the landing gear in place and use a screwdriver to secure the landing gear to the wing set using bolts M4x20mm and washers. Make sure to use the threadlock on the bolts so they don't vibrate loose.

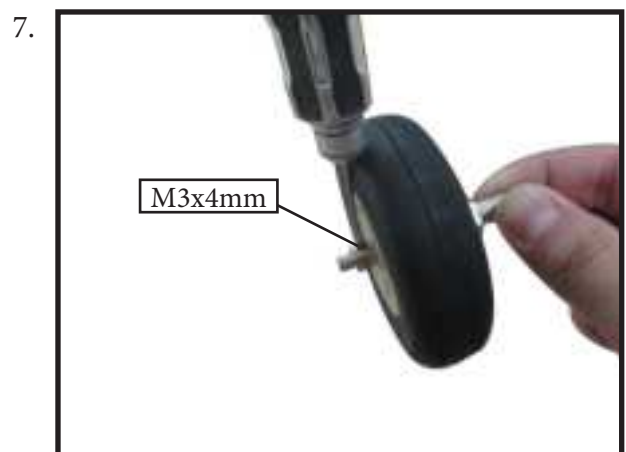



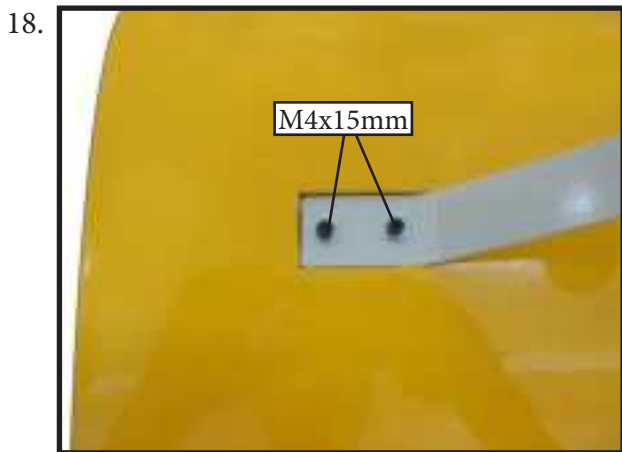

NOSE GEAR INSTALLATION

Please see Images below:

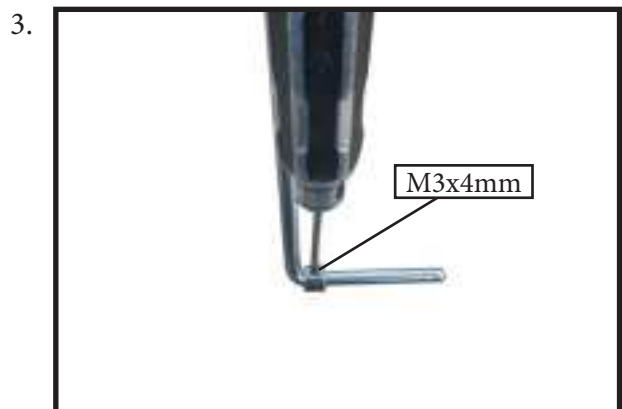

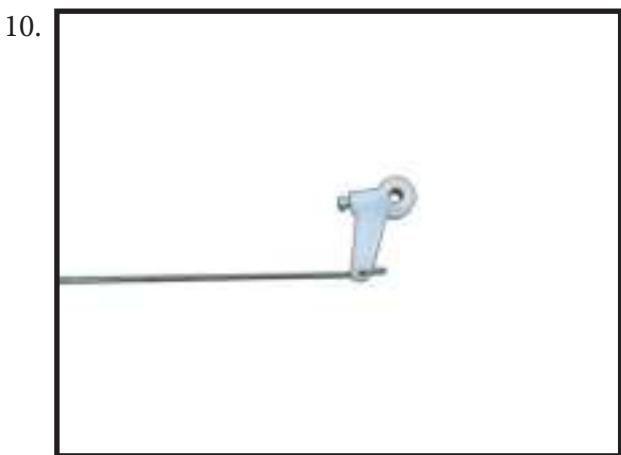

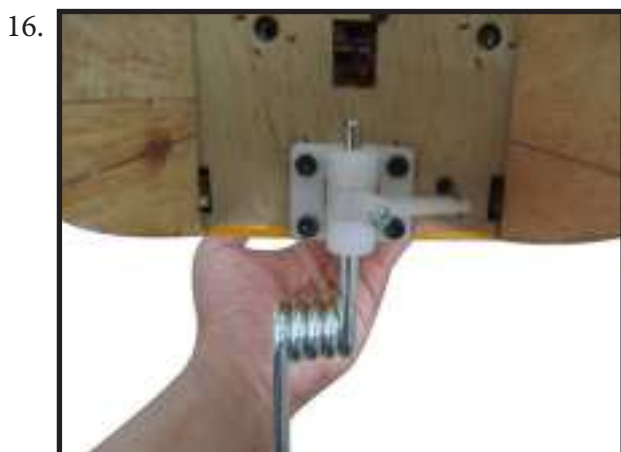
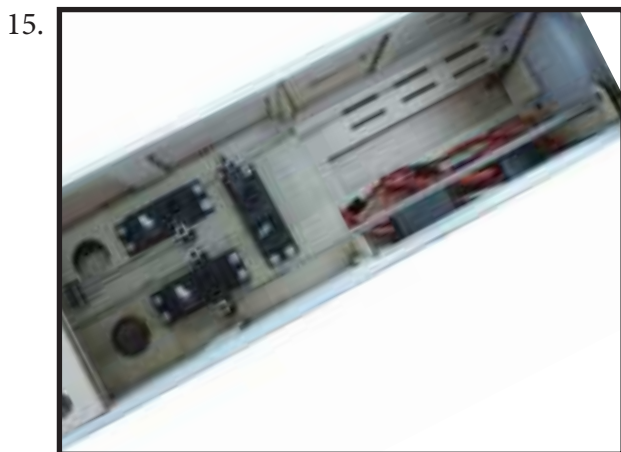

INSTALLING THE FUSELAGE SERVOS

 Because the size of servos differ, you may need to adjust the size of the precut opening in the mount. The notch in the sides of the mount allow the servo lead to pass through.

Install the rubber grommets and brass collets into all servos. Test fit the servos into the fuselage servo mounts.

Secure the servos with the screws provided with your radio system.

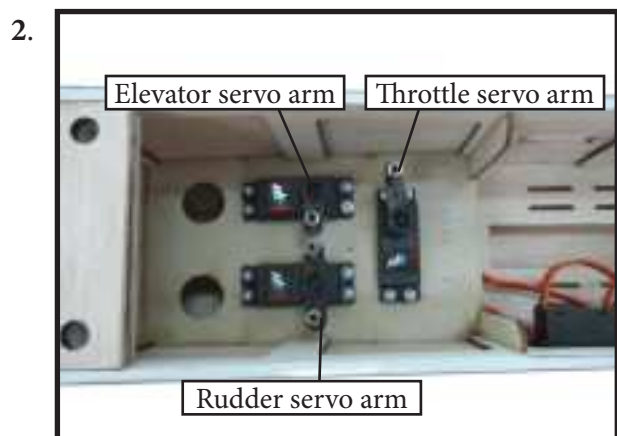
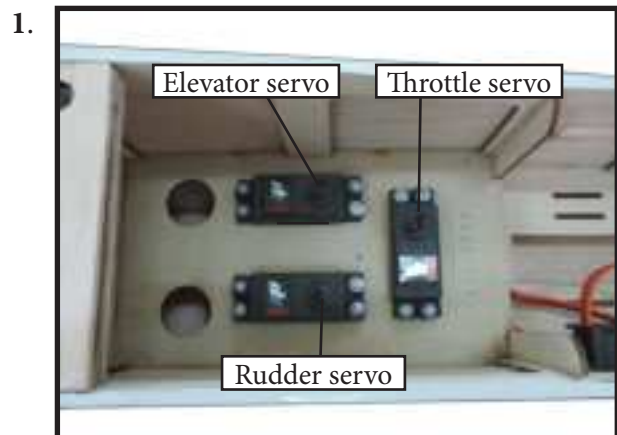

Mininum servo spec.
Torque : 54 oz-in (3.9 kg-cm) @ 4.8V;
 67 oz-in (4.8 kg-cm) @ 6.0V

INSTALLING THE RECEIVER SWITCH

Install the switch into the precut hole in the side, in the fuselage.

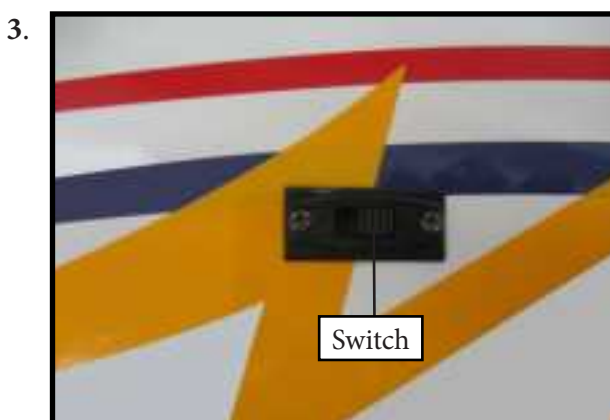
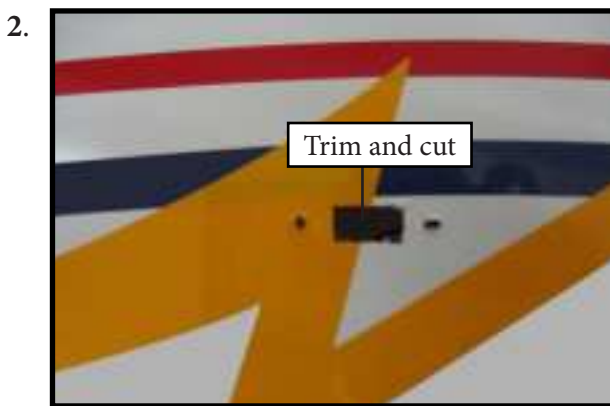
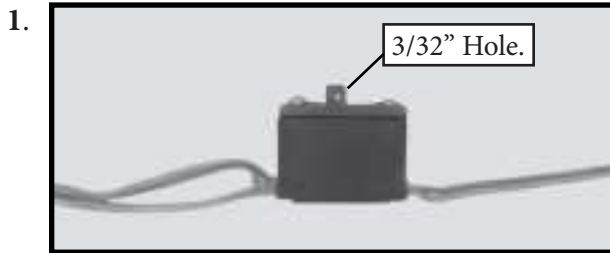

INSTALLING THE ENGINE SWITCH

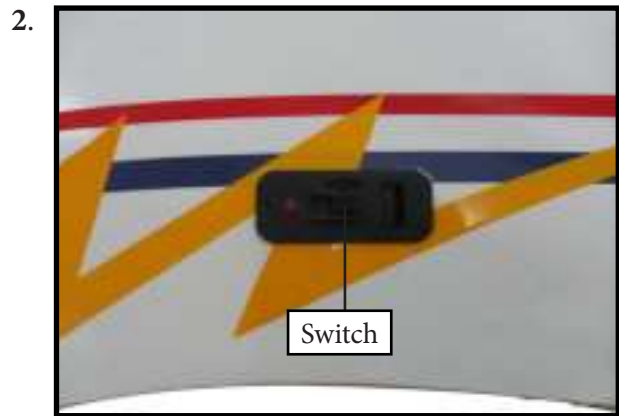
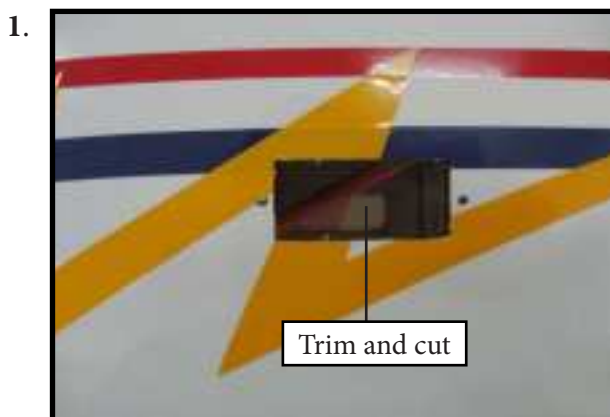

INSTALLING THE STOPPER ASSEMBLY

Using a modeling knife, carefully cut off the rear portion of one of the 3 nylon tubes leaving 1/2" protruding from the rear of the stopper. This will be the fuel pick up tube.

Using a modeling knife, cut one length of silicon fuel line. Connect one end of the line to the weighted fuel pick up and the other end to the nylon pick up tube.

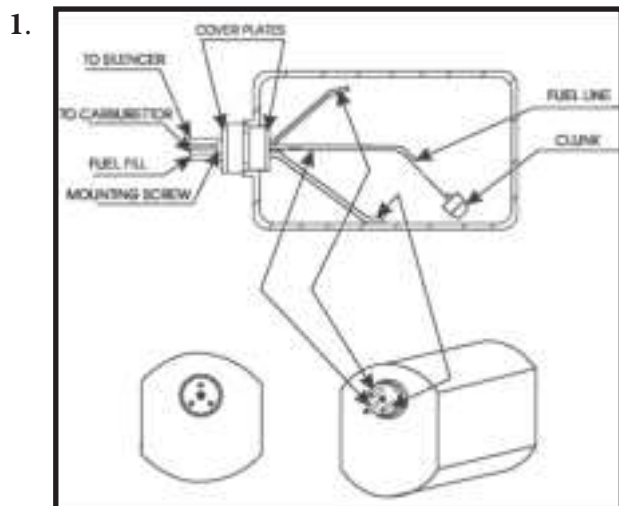

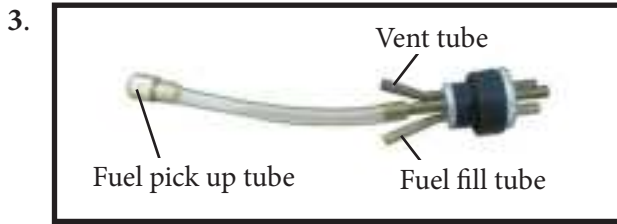

Carefully bend the second nylon tube up at a 45° angle. This tube is the vent tube.

Test fit the stopper assembly into the tank. It may be necessary to remove some of the flashing around the tank opening using a modeling knife. If flashing is present, make sure none falls into the tank.

With the stopper assembly in place, the weighted pick-up should rest away from the rear of the tank and move freely inside the tank. The top of the vent tube should rest just below the top of the tank. It should not touch the top of the tank.

When satisfied with the alignment of the stopper assembly tighten the 3 x 20mm machine screw until the rubber stopper expands and seals the tank opening. Do not over-tighten the assembly as this could cause the tank to split.

FUEL TANK INSTALLATION



! *You should mark which tube is the vent and which is the fuel pickup when you attach fuel tubing to the tubes in the stopper. Once the tank is installed inside the fuselage, it may be difficult to determine which is which.*

Slide the fuel tank into the fuselage. Guide the lines from the tank through the hole in the firewall.

Use plywood template to hold in place the fuel tank with C/A glue to secure the fuel-tank inside the fuselage.

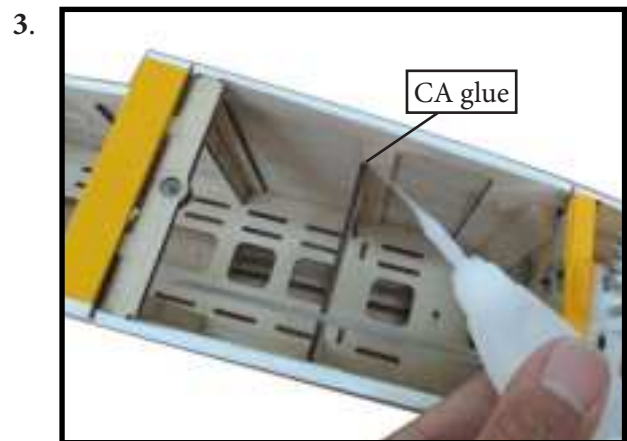
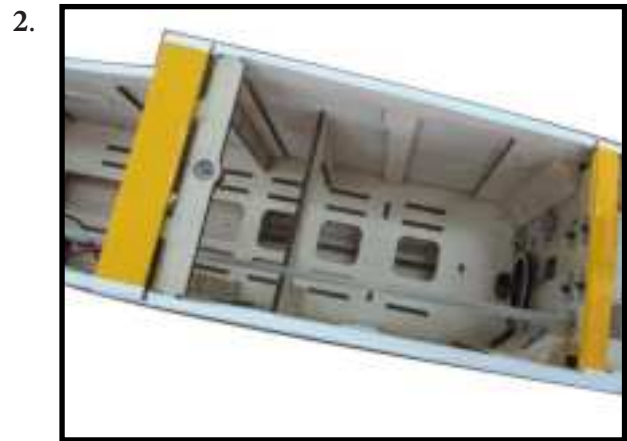

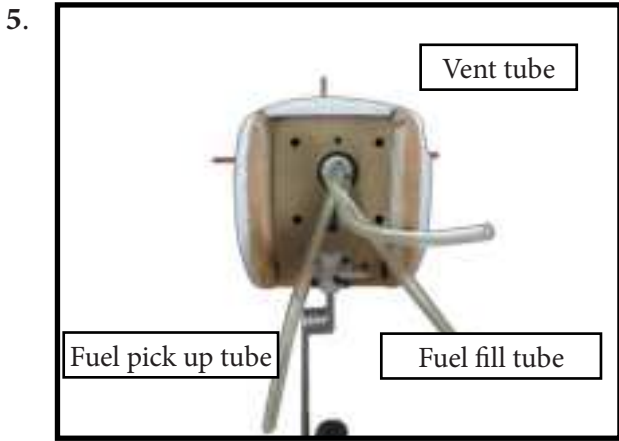

Connect the lines from the tank to the engine and muffler. The vent line will connect to the muffler and the line from the clunk to the carburetor.

 *Blow through one of the lines to ensure the fuel lines have not become kinked inside the fuel tank compartment. Air should flow through easily.*

MOUNTING THE ENGINE

Locate the items necessary to install the engine mount included with your model.

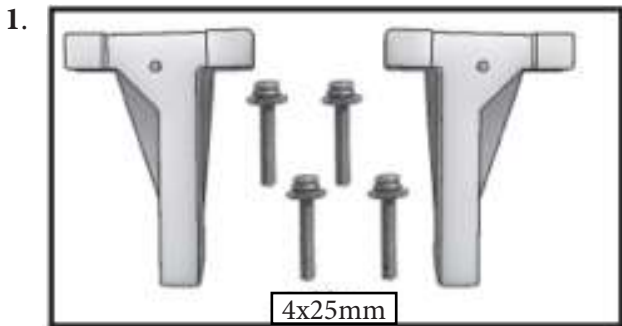

Use four 4x25mm head bolts and four 4mm washers to attach the engine mount rails to the firewall. Tighten the screws. Make sure to use threadlock on the screws to help prevent them from vibrating loose.



Position the engine with the drive washer (135mm) forward of the firewall as shown.

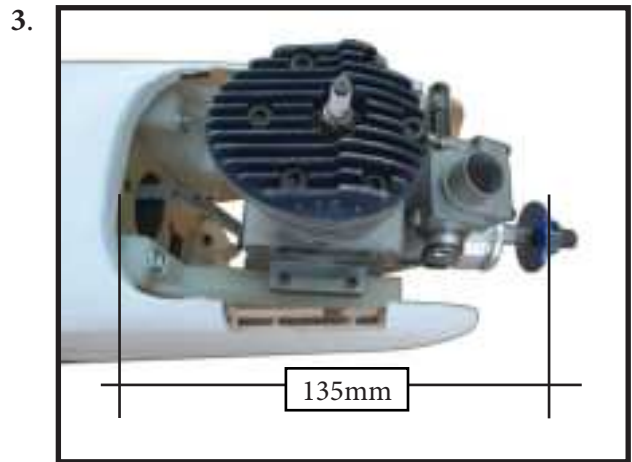

Use a pin drill and 4mm drill bit to drill a small indentation in the mount for the engine mounting screw.

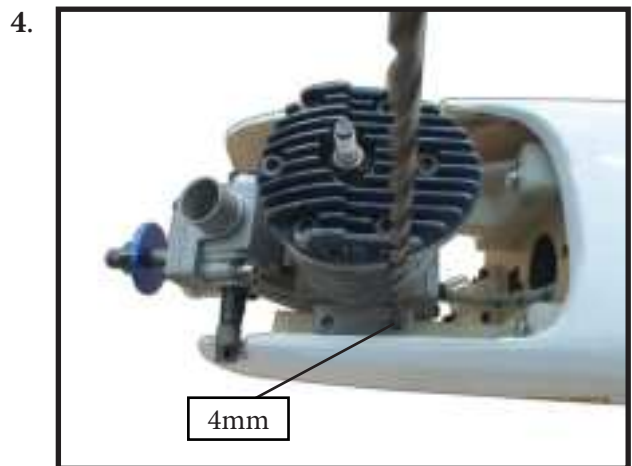

Use a drill to drill the four holes in the engine mount rails.

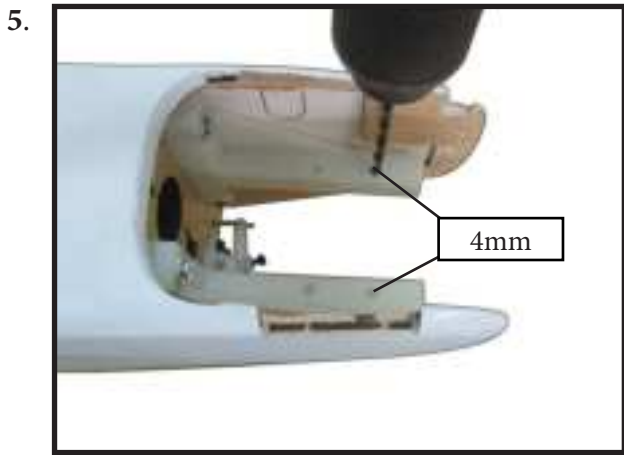

On the firewall has the location for the throttle pushrod tube (pre-drill).

Slide the pushrod tube in the firewall and guide it through the fuel tank mount. Use medium C/A to glue the tube to the firewall and the fuel tank mount.

Connect the Z-bend in the 450mm throttle pushrod to the outer hole of the carburetor arm.

Slide the throttle pushrod wire into the tube. Position the engine between the mounts. Use four M4x30mm machine screws to secure the engine to the mount as shown.

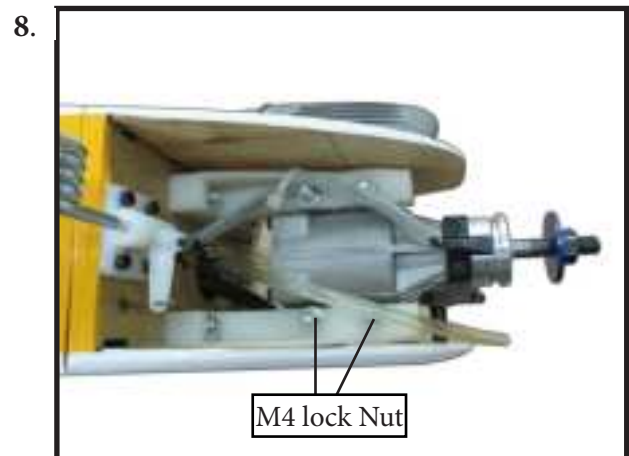
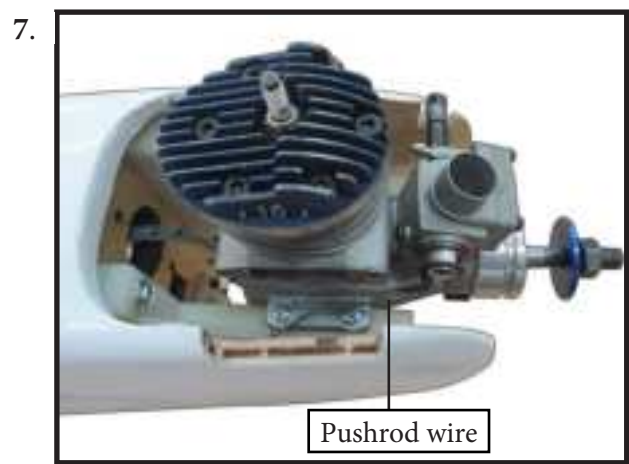

Reinstall the servo horn by sliding the connector over the pushrod wire. Center the throttle stick and trim and install the servo horn perpendicular to the servo center line.



Move the throttle stick to the closed position and move the carburetor to closed. Use a 2.5mm hex wrench to tighten the screw that secures the throttle pushrod wire. Make sure to use threadlock on the screw so it does not vibrate loose.

10.



11.

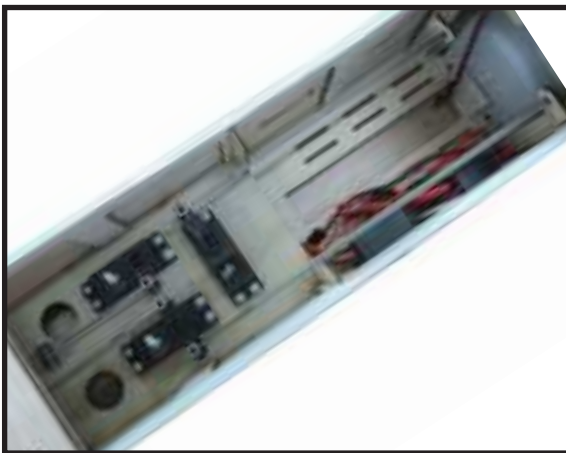

INSTALLING THE SPINNER

Install the spinner backplate, propeller and spinner cone.

⚠ The propeller should not touch any part of the spinner cone. If it does, use a sharp modeling knife and carefully trim away the spinner cone where the propeller comes in contact with it.

1.



ELECTRIC POWER CONVERSION

Locate the items necessary to install the electric power conversion included with your model.

1.



- Model size: .46-.52 size models
- Motor: 35mm 830 rev per volt
- Propeller: 12x6 ~ 13x6
- ESC: 60A
- Lipo Batteries: 4 cell 4200mA

Attach the electric motor box to the firewall suitable with the cross lines drawn on the electric motor box and firewall. Using M4x20mm to secure the motor box to the firewall. Please see pictures below.

2.



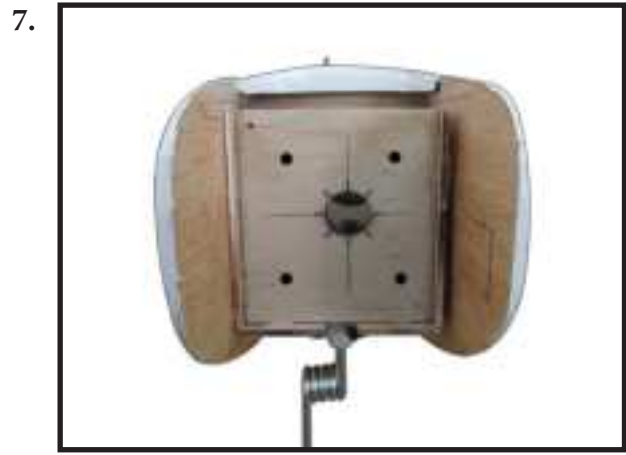

Attach the motor to the front of the electric motor box using four 4mm blind nut, four M4x16mm hex head bolts to secure the motor. Please see picture shown.

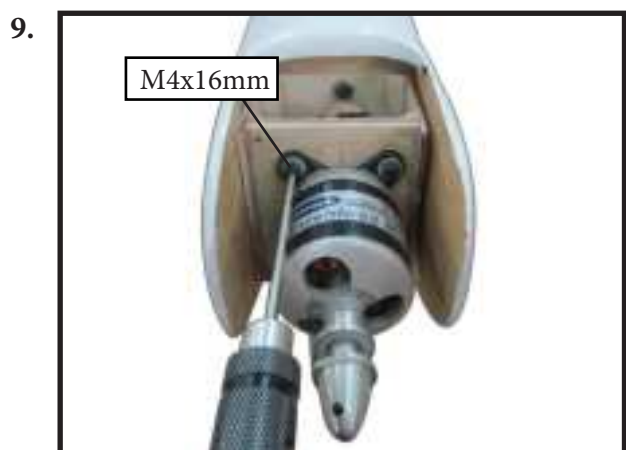
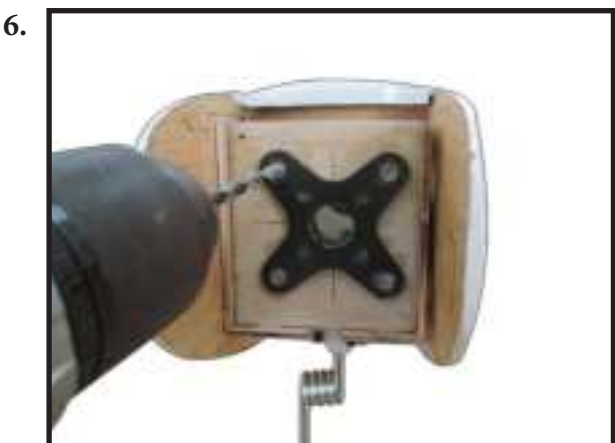
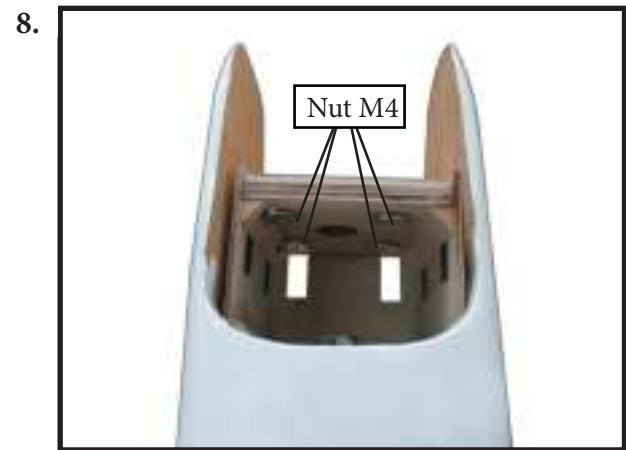

Locate the plywood battery tray to the fuselage. Tighten the screws using machine screws M4x16mm to secure the tray in position.

10.

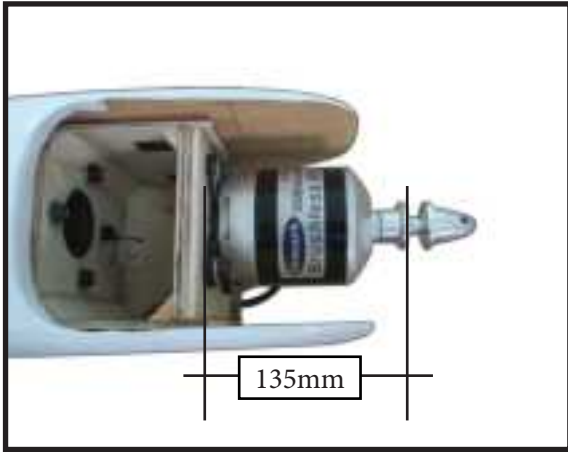

Attach the speed control to the side of the motor box using two-sided tape and tie wraps. Connect the appropriate leads from the speed control to the motor. Make sure the leads will not interfere with the operation of the motor.

11.

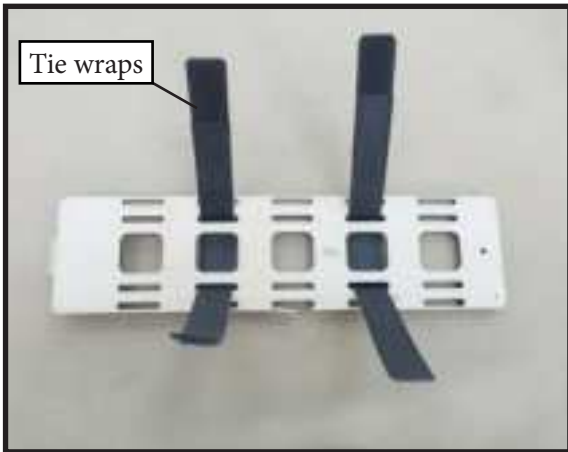

12.



13.

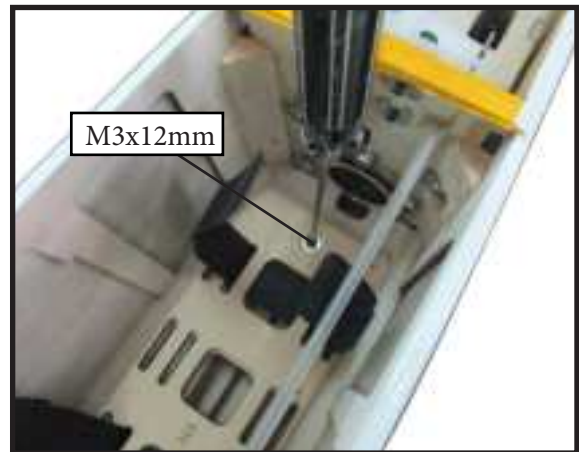

14.

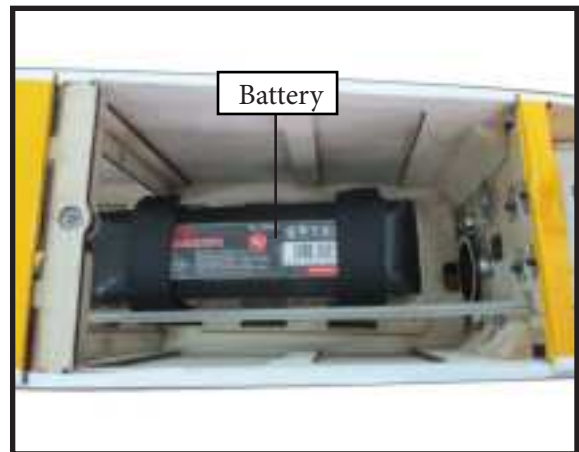

15.

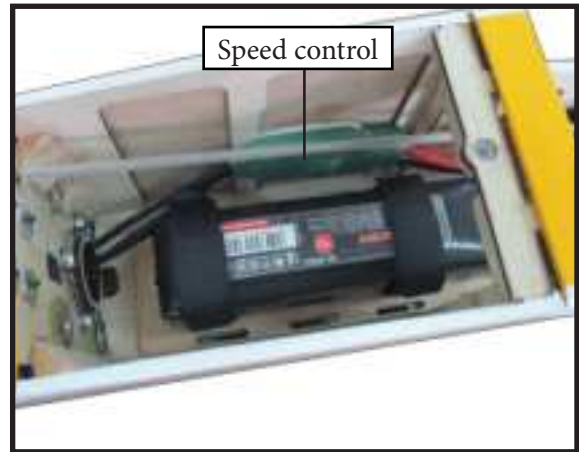

16.

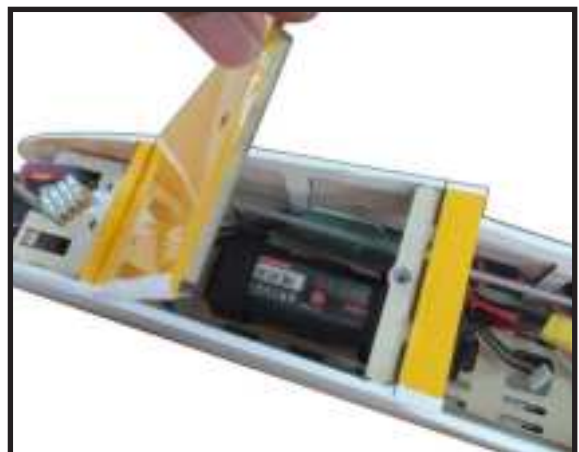

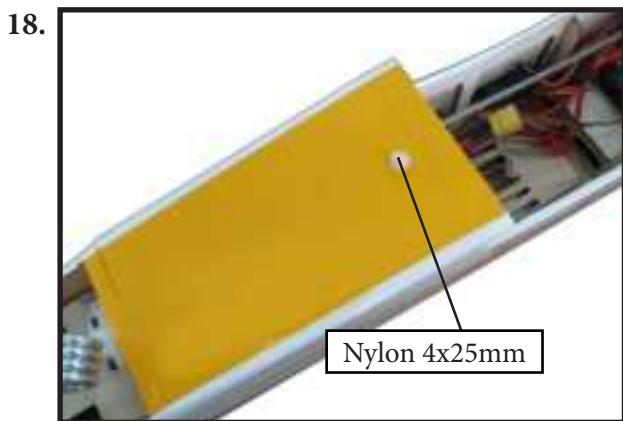
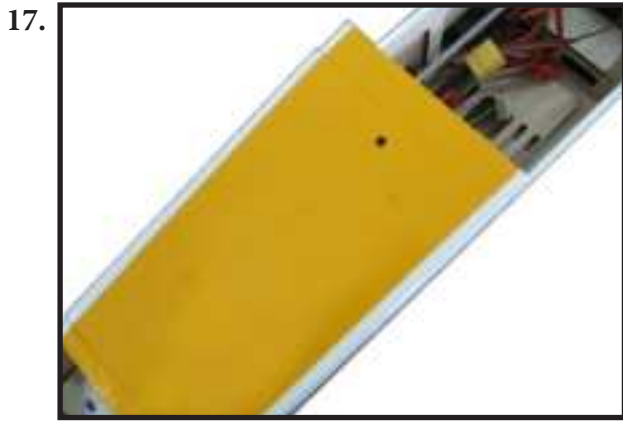

COWLING

Please see below pictures.



Tape the cowl to the fuselage using low-tack tape.



Use a drill and drill bit to drill the holes for the cowl mounting screws. Make sure the cowl position is correct before drilling each hole.

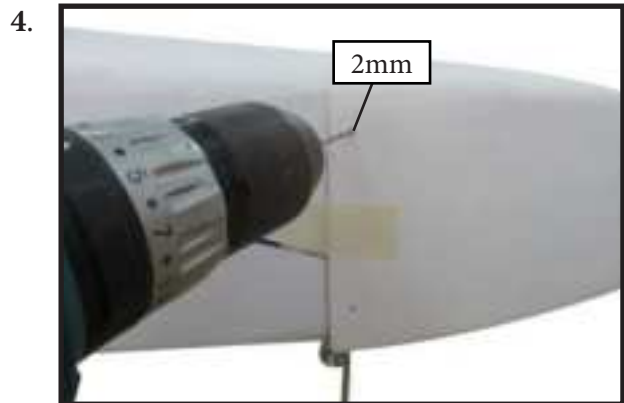

Install the muffler and muffler extension onto the engine and make the cutout in the cowl for muffler clearance. Connect the fuel and pressure lines to the carburetor, muffler and fuel filler valve. Secure the cowl to fuselage using the M3x10mm socket head screws. Putting a small length of silicon fuel tube under the head of the screw helps with vibration.



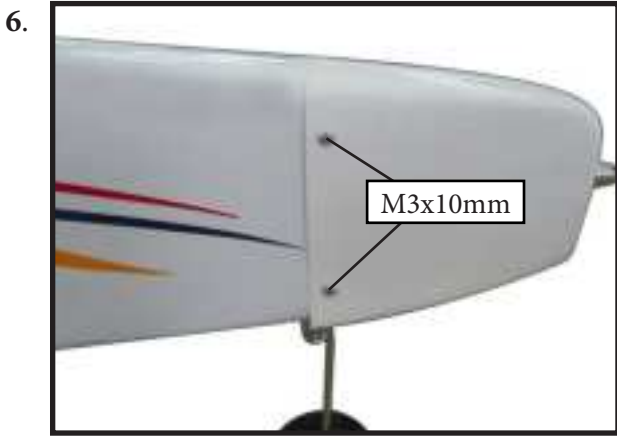

INSTALL HINGE FOR STABILIZER AND ELEVATOR

Please study images below.



INSTALLING THE SPINNER

Install the spinner backplate, propeller and spinner cone.

⚠ The propeller should not touch any part of the spinner cone. If it does, use a sharp modeling knife and carefully trim away the spinner cone where the propeller comes in contact with it.



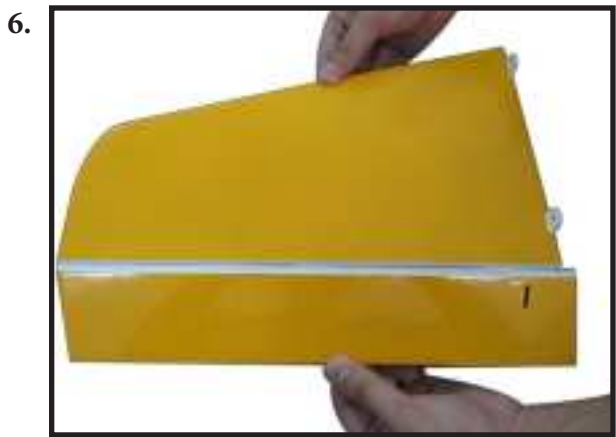
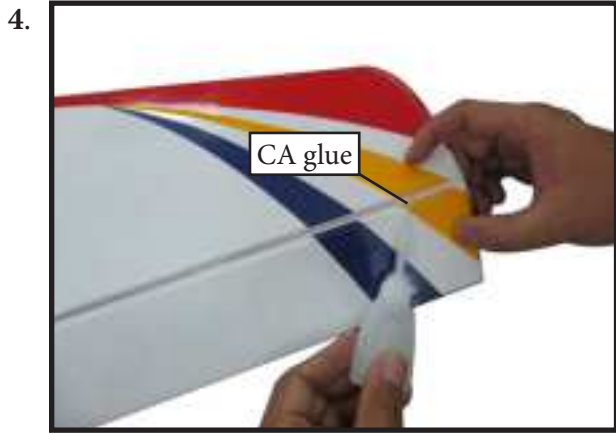

INSTALL ELEVATOR CONTROL HORN

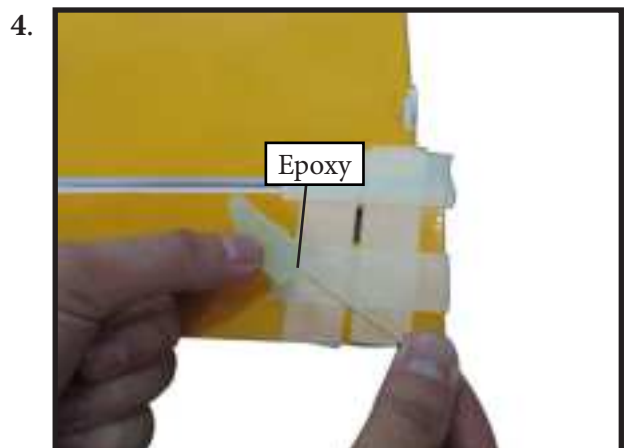
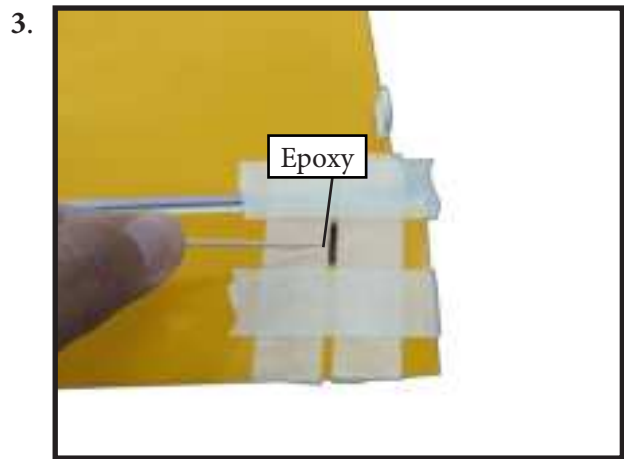
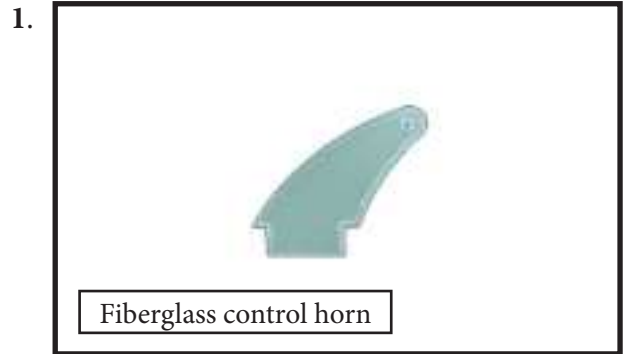



HINGING THE RUDDER

Glue the top two rudder hinges in place using the same techniques used to hinge the ailerons.

The lower hinge will be glued when the fin/rudder assembly is attached to the fuselage.



INSTALL RUDDER CONTROL HORN

Repeat steps to install the rudder control horn as same as steps done for ailerons.

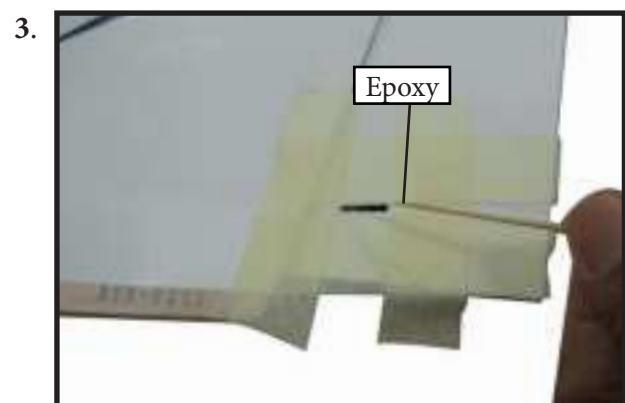
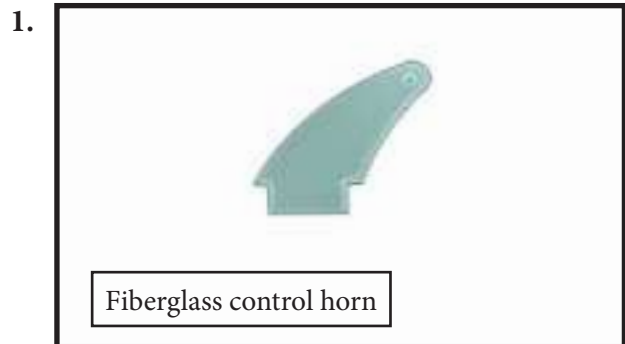

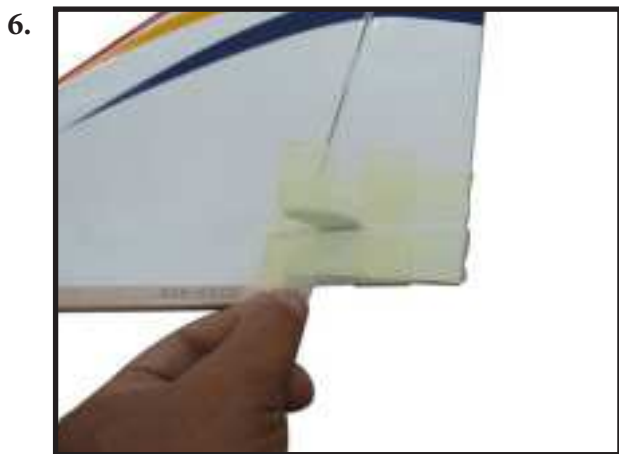
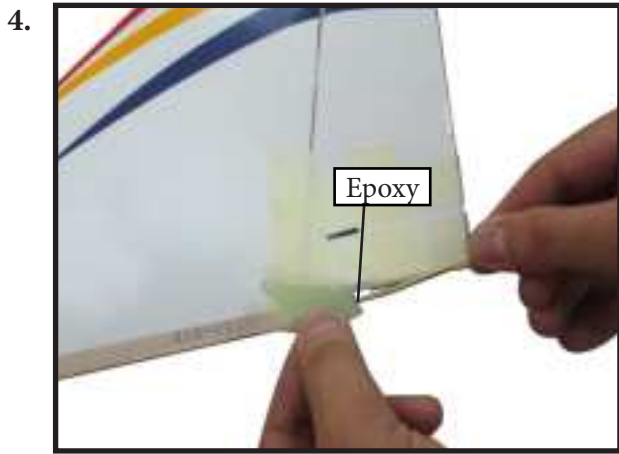

**VERTICAL STABILIZER
INSTALLATION**

Slide the vertical stabilizer into the slot in the top of the fuselage. The rear edge of the stabilizer should be flush with the rear edge of the fuselage and the lower rudder hinge should engage the precut hinge slot in the lower fuselage. The bottom edge of the stabilizer should also be firmly pushed against the top of the horizontal stabilizer.



While holding the vertical stabilizer firmly in place, use a pen and draw a line on each side of the vertical stabilizer where it meets the top of the fuselage.



Remove the stabilizer. Using a modeling knife, remove the covering from below the lines you drew.

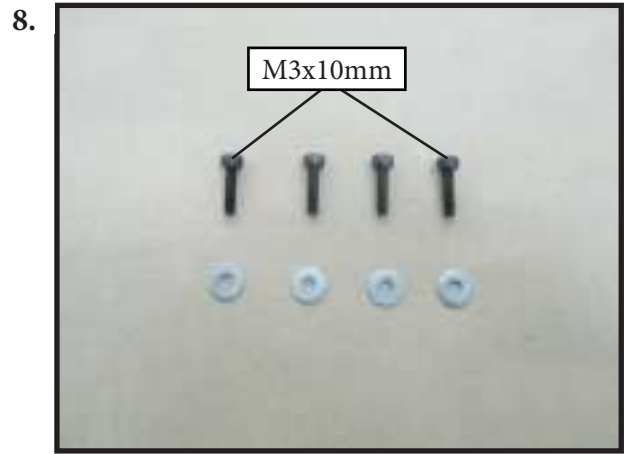
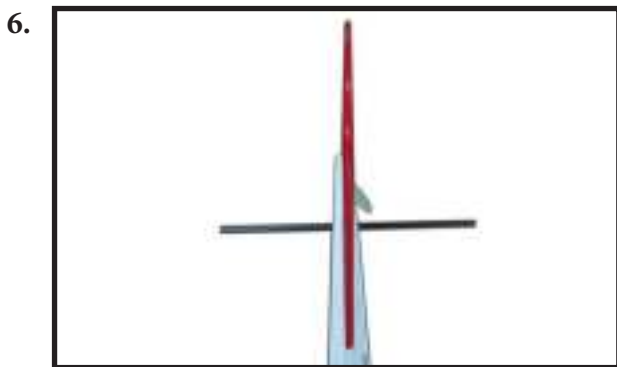
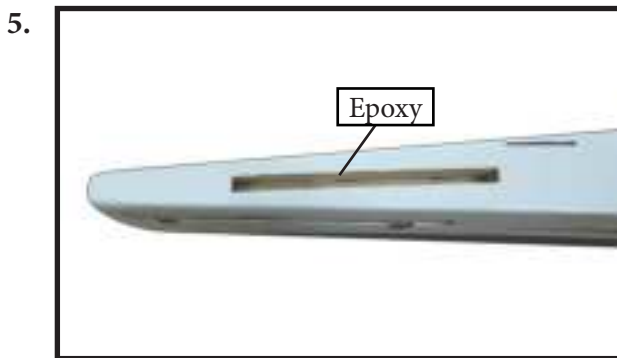
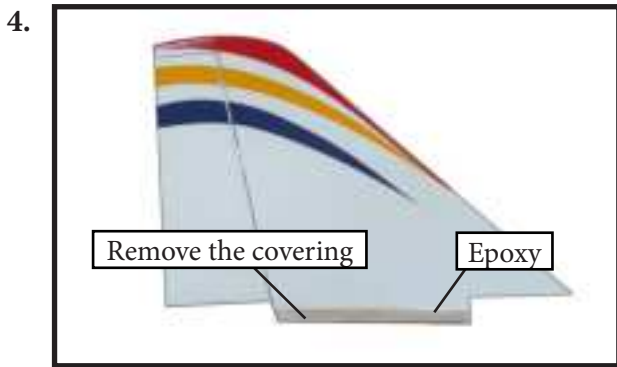
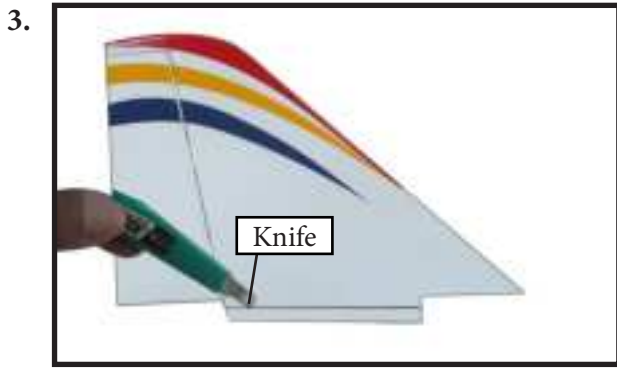

 *When cutting through the covering to remove it, cut with only enough pressure to only cut through the covering itself. Cutting into the balsa structure may weaken it.*

Slide the vertical stabilizer back in place. Using a triangle, check to ensure that the vertical stabilizer is aligned 90° to the horizontal stabilizer.

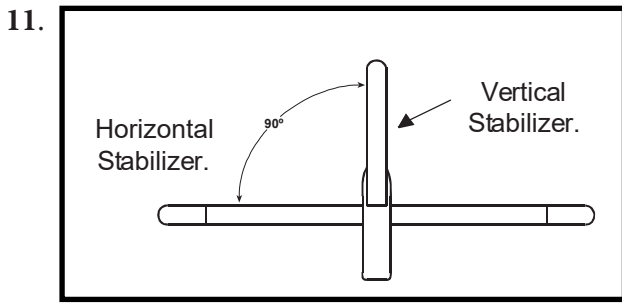

When you are sure that everything is aligned correctly, mix up a generous amount of Flash 30 Minute Epoxy. Apply a thin layer to the mounting slot and to bottom of the vertical stabilizer mounting area. Apply epoxy to the bottom and top edges of the filler block and to the lower hinge also. Set the stabilizer in place and realign. Double check all of your measurements once more before the epoxy cures. Hold the stabilizer in place with T-pins or masking tape and remove any excess epoxy using a paper towel and rubbing alcohol. Allow the epoxy to fully cure before proceeding.



ELEVATOR PUSHROD INSTALLATION

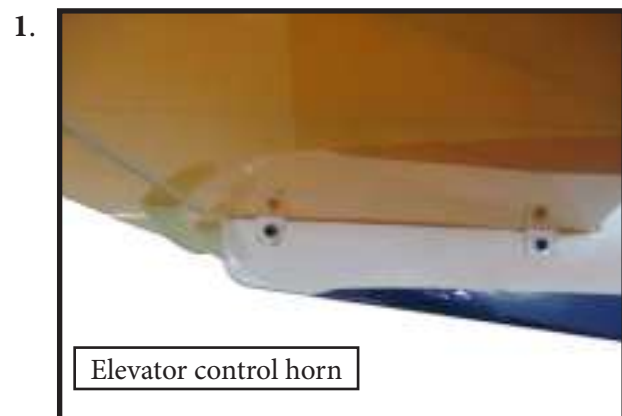

Thread one clevis and M2 lock nut on to each elevator control rod. Thread the horns on until they are flush with the ends of the control rods.

Elevator and rudder pushrods assembly as pictures below.

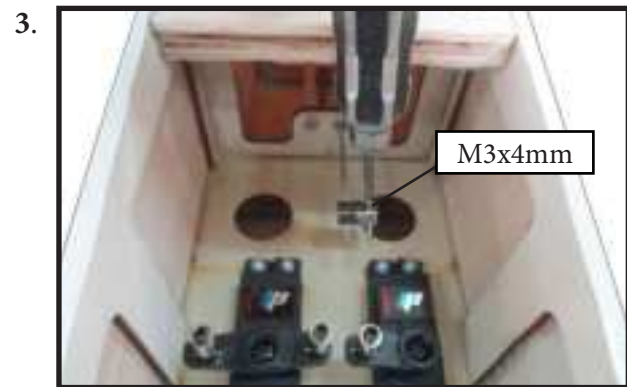
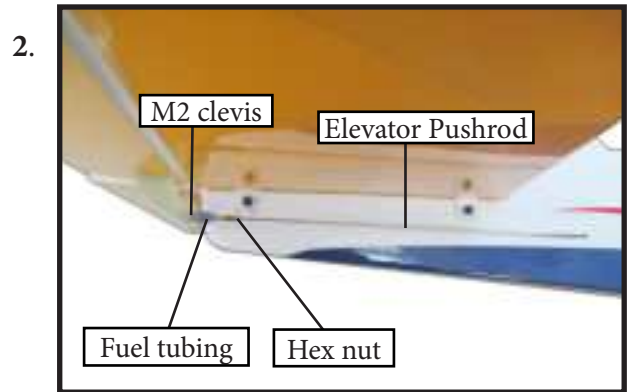

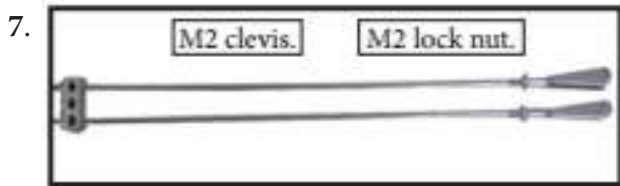
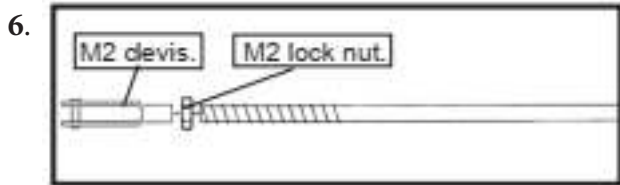

RUDDER PUSHROD INSTALLATION

- Locate items necessary to install rudder pushrod.

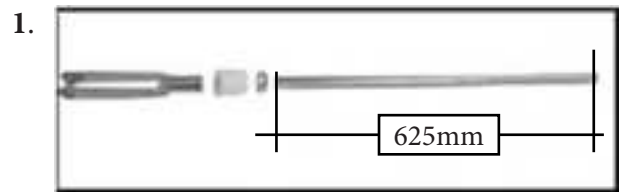



INSTALLATION PILOT AND CANOPY

Locate items necessary to install pilot, seats.

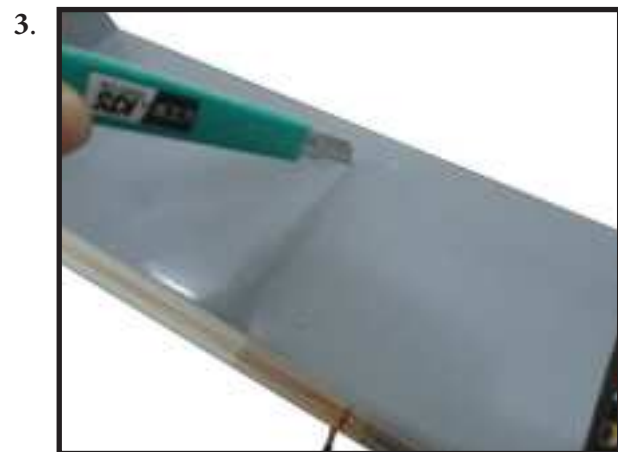

A scale pilot is included with this ARF. The Pilot included fitting well to the cockpit. (or you can order others scale pilot figures made by SG Models. They are available at SG Models distributors.)



If you are going to install a pilot figure, please use a sanding bar to sand the base of the figure so that it is flat.



Position the pilot figure on the canopy floor as shown. Use epoxy to glue the base of the pilot figure to the cockpit floor, please see pictures as shown.

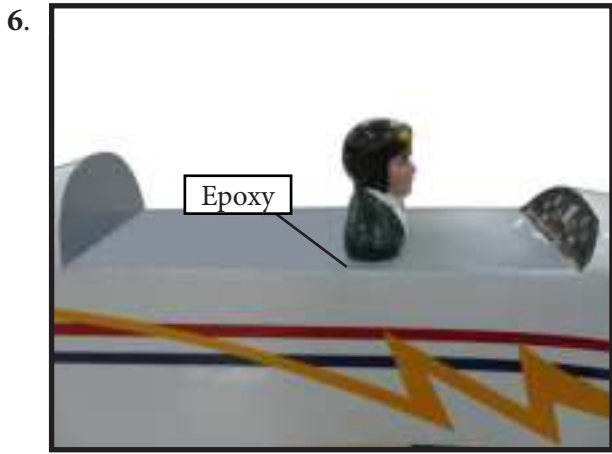

Position the canopy onto the fuselage. Trace around the canopy and onto the fuselage using a felt-tipped pen. Carefully cut and remove covering material from the fuselage where the canopy makes contact, exposing the bare wood. Then permanently glue the canopy in place with epoxy glue or special “canopy glue”.



INSTALLING THE RECEIVER

Plug the five servo leads and the switch lead into the receiver. Plug the battery pack lead into the switch also.

Wrap the receiver and battery pack in the protective foam rubber to protect them from vibration.

Route the antenna in the antenna tube inside the fuselage and secure it to the bottom of fuselage using a plastic tape.

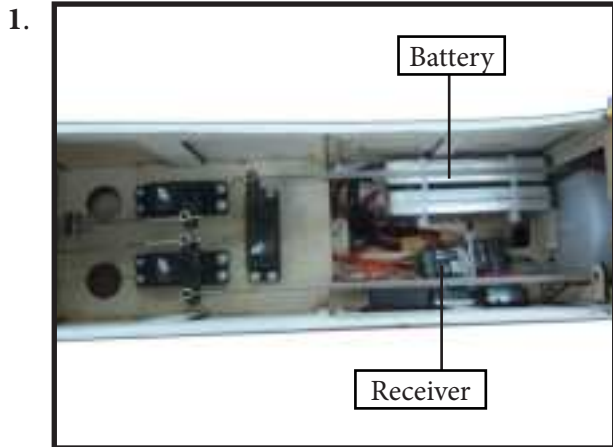

ATTACHMENT WING- FUSELAGE

Attach the aluminium tube into fuselage.

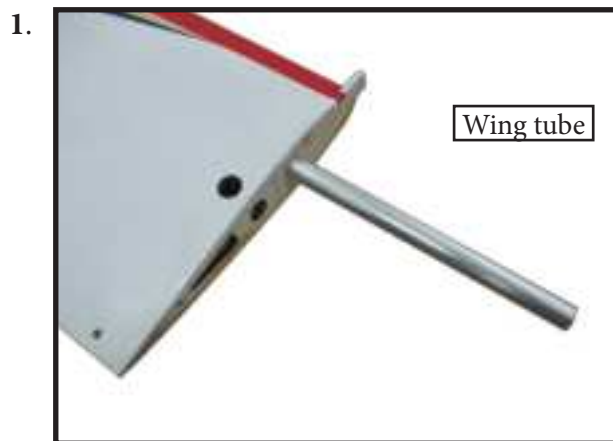

Insert two wing panels as pictures below.

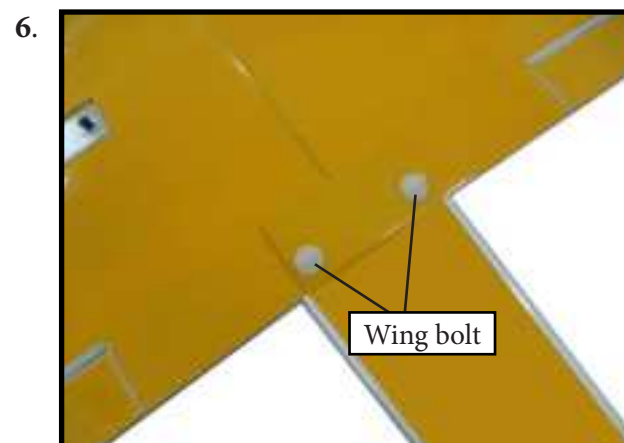
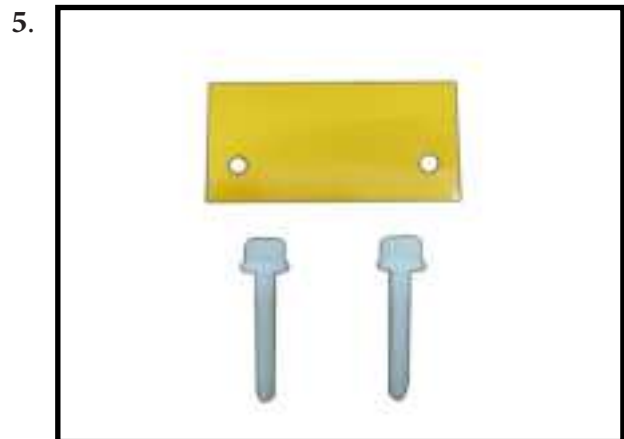
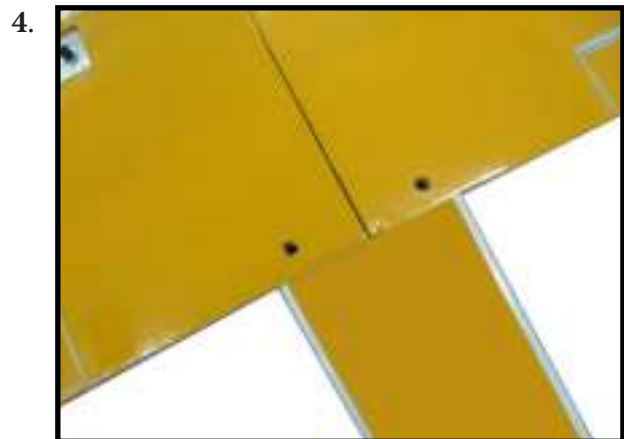
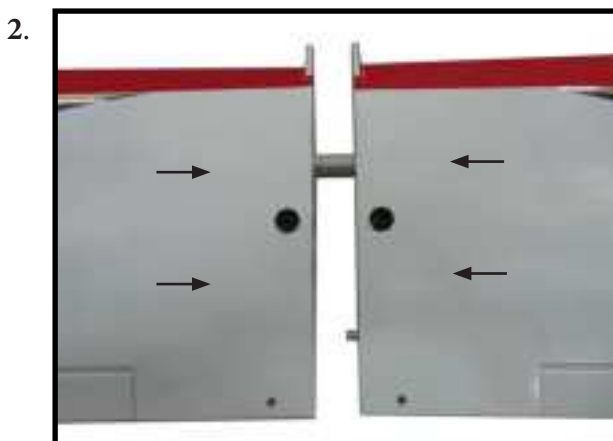

APPLY THE DECALS

1) If all the decals are precut and ready to stick. Please be certain the model is clean and free from oily fingerprints and dust. Position decal on the model where desired, using the photos on the box and aid in their location.

2) If all the decals are not precut, please use scissors or a sharp hobby knife to cut the decals from the sheet. Please be certain the model is clean and free from oily fingerprints and dust. Position decal on the model where desired, using the photos on the box and aid in their location.

BALANCING

1) It is critical that your airplane be balanced correctly. Improper balance will cause your plane to lose control and crash. THE CENTER OF GRAVITY IS LOCATED **90MM** BACK FROM THE LEADING EDGE OF THE WING AT THE WING ROOT.

2) Mount the wing to the fuselage. Place a piece of masking tape on the top of each wing 88mm back from the leading edge at the wing root.

3) With the model inverted, place your fingers on the masking tape and carefully lift the plane. This is the point at which your model should balance for your first flights. Later, you may wish to experiment by shifting the balance up to 70mm forward or back to change the flying characteristics. Moving the balance forward may improve the smoothness and arrow-like tracking, but it may then require more speed for take off and make it more difficult to slow down for landing. Moving the balance aft makes the model more agile with a lighter and snappier "feel". In any case, please start at the location we recommend.

*If possible, first attempt to balance the model by changing the position of the receiver battery and receiver. If you are unable to obtain good balance by doing so, then it will be necessary to add weight to the nose or tail to achieve the proper balance point.

With the wings attached to the fuselage, all parts of the model installed (ready to fly), and empty fuel tanks, hold the model at the marked balance point with the stabilizer level.

Lift the model. If the tail drops when you lift, the model is "tail heavy" and you must add weight* to the nose. If the nose drops, it is "nose heavy" and you must add weight* to the tail to balance.

1.

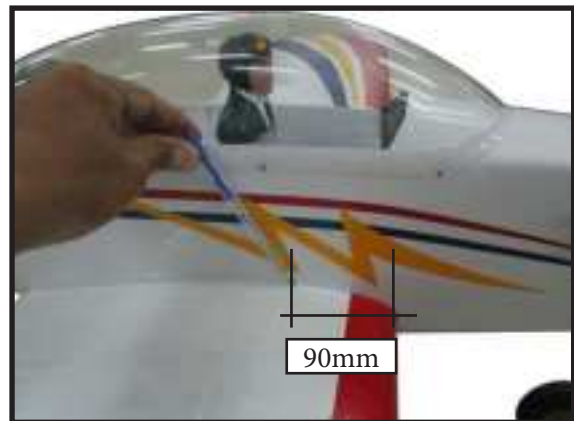

CONTROL THROWS

Ailerons:

High Rate :

Up : 15 mm

Down : 15 mm

Low Rate :

Up : 12 mm

Down : 12 mm

Elevator:

High Rate :

Up : 15 mm

Down : 15 mm

Low Rate :

Up : 12 mm

Down : 12 mm

Rudder:

High Rate :

Right : 25 mm

Left : 25 mm

Low Rate :

Right : 20 mm

Left : 20 mm

Flap:

Mid : 30mm

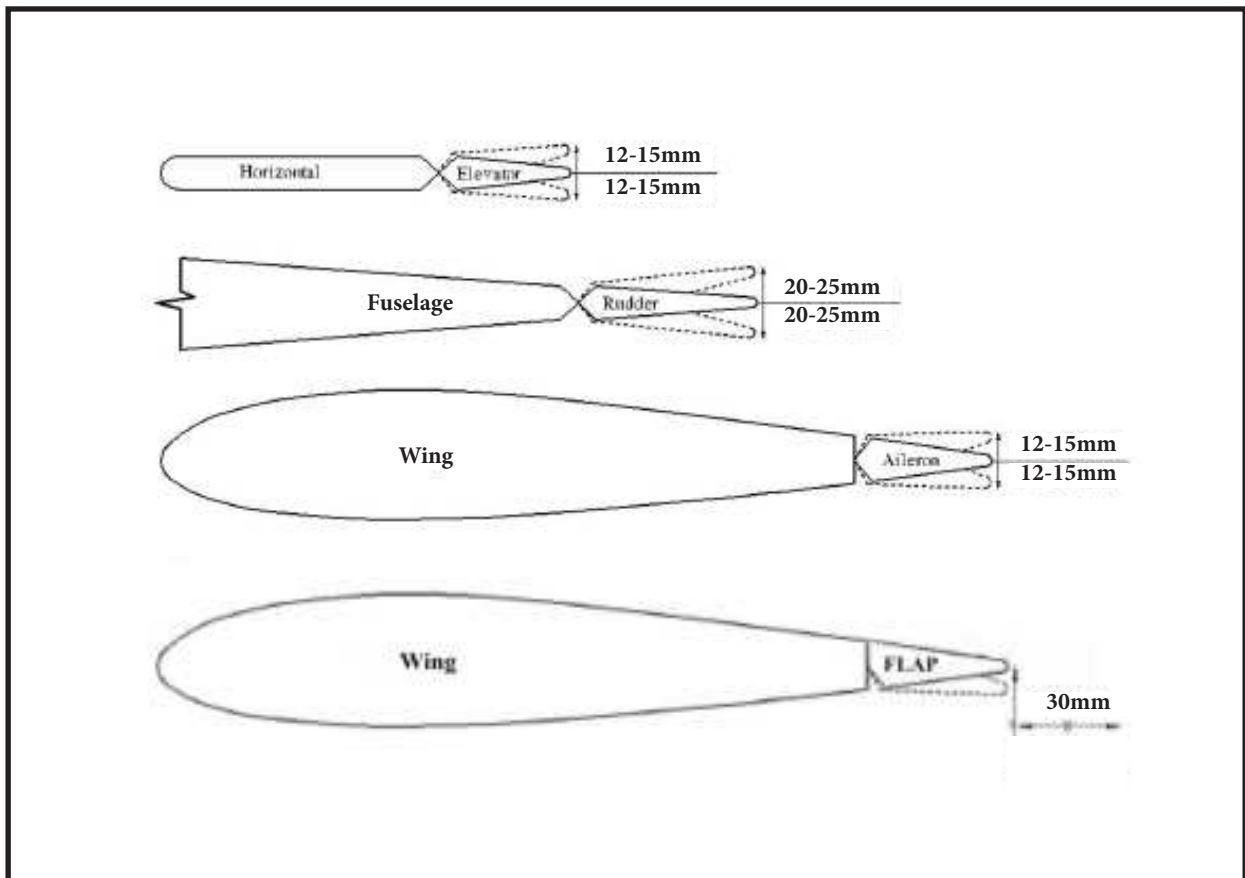

FLIGHT PREPARATION

Check the operation and direction of the elevator, rudder, ailerons and throttle.

☐ A) Plug in your radio system per the manufacturer's instructions and turn everything on.

☐ B) Check the elevator first. Pull back on the elevator stick. The elevator halves should move up. If they do not, flip the servo reversing switch on your transmitter to change the direction.

☐ C) Check the rudder. Looking from behind the airplane, move the rudder stick to the right. The rudder should move to the right. If it does not, flip the servo reversing switch on your transmitter to change the direction.

☐ D) Check the throttle. Moving the throttle stick forward should open the carburetor barrel. If it does not, flip the servo reversing switch on your transmitter to change the direction.

☐ E) From behind the airplane, look at the aileron on the right wing half. Move the aileron stick to the right. The right aileron should move up and the other aileron should move down. If it does not, flip the servo reversing switch on your transmitter to change the direction.

PREFLIGHT CHECK

☐ 1) Completely charge your transmitter and receiver batteries before your first day of flying.

☐ 2) Check every bolt and every glue joint in the **TEMPEST DRAGON 15cc ARF** to ensure that everything is tight and well bonded.

☐ 3) Double check the balance of the airplane. Do this with the fuel tank empty.

☐ 4) Check the control surfaces. All should move in the correct direction and not bind in any way.

☐ 5) If your radio transmitter is equipped with dual rate switches double check that they are on the low rate setting for your first few flights.

☐ 6) Check to ensure the control surfaces are moving the proper amount for both low and high rate settings.

☐ 7) Check the receiver antenna. It should be fully extended and not coiled up inside the fuselage.

☐ 8) Properly balance the propeller. An out of balance propeller will cause excessive vibration which could lead to engine and/or airframe failure.

*We wish you many safe and enjoyable flights
with your TEMPEST DRAGON 15cc ARF.*

*If you have any queries, or are interested in our products,
please feel free to contact us*

Factory : 12/101A - Hamlet 4 - Le Van Khuong Street - Dong Thanh Ward -
Hoc Mon District - Ho Chi Minh City - Viet Nam.

Office : 62/8 Ngo Tat To Street - Ward 19 - Binh Thanh District - Ho Chi Minh
City - Viet Nam

Phone : 848 - 86622289 or 848- 36018777

Website : www.SeagullModels.com

Email : Sales@seagullmodels.com

Facebook : www.facebook.com/SeaGullModels.