



CHCNAV RS10

User Manual



SLAM Solution | Apr. 2024

Make your work more efficient





Table of Content

Table of Content	2
1 Reading Tips	4
1.1 Symbol Description.....	4
1.2 Recommendations.....	4
1.3 Service & Support.....	4
1.4 Disclaimer	4
2 Using Requirements	5
2.1 Using Environment	5
2.2 Tips Before Using.....	5
2.3 Tips During Using.....	5
2.4 Tips After Using	5
3 Product Description.....	6
3.1 Check List	6
3.2 Delivery of Equipment and Materials	7
3.3 Physical Characteristics.....	9
3.3.1 Weight and Size.....	9
3.3.2 Interface Definition	10
3.4 Power Supply and Physical Characteristics	10
4 Product Workflow	11
4.1 Advance Preparation	11
4.2 SmartGo APP Control.....	11
4.2.1 WiFi connection	11
4.2.2 RTK settings	12
4.2.3 Start project.....	13
4.2.4 Select capture scene	13
4.2.5 Device initialization.....	14
4.2.6 Start data acquisition	15
4.2.7 Add control point.....	15
4.2.8 Stop data acquisition.....	16
4.3 One-Key control.....	17
4.4 Hot-swapping battery	17
5 Data preprocessing.....	18
5.1 Data copy	18
5.2 Create Task.....	19
5.3 Coordinate System Setting.....	20
5.4 Real-time Point Cloud	21
5.4.1 Load real-time point cloud	21
5.4.2 Export real-time point cloud.....	21
5.5 SLAM Secondary Accuracy Optimization	22

5.6	Result check	26
5.7	Format conversion.....	27
6	Matters Need Attention.....	28
6.1	Important Notes.....	28
6.2	Product Transportation.....	28
6.3	Using Tips.....	28
6.4	Storage Tips.....	29

1 Reading Tips

1.1 Symbol Description

-  **Forbid**
-  **Warning**
-  **Important note**
-  **Operate & Using tips**

1.2 Recommendations

CHCNAV provides below documents for users:

- RS10 Surveying System user manual
- RS10 Configuration list

It is recommended for users to read above documents before first time using.

If users have any questions regarding the content of this manual, please contact us at +86 21 542 60 273 for professional consultation and assistance.

1.3 Service & Support

CHCNAV website: www.chcnav.com

Email: sales@chcnav.com | support@chcnav.com

Tel: +86 21 542 60 273 | Fax: +86 21 649 50 963

CHCNAV reserves the right to modify product status and user manuals without prior notice.

For the latest product information, please visit CHCNAV's official website (www.chcnav.com).

1.4 Disclaimer

- The customer should use and maintain the equipment in accordance with the requirements of the manual. If the service life of equipment is affected due to improper use or maintenance, even broken, CHCNAV will not bear the relevant responsibility. All repairs and maintenance services resulting from this will be charged at standard prices.
- During the transportation, if the equipment is damaged due to improper logistics operation, CHCNAV will not bear the relevant responsibility.
- During equipment using time, if customer disassembles and assembles the equipment without CHCNAV's suggestions & permission, and resulting in damage, CHCNAV will not bear the relevant responsibility.

- Customer should use default batteries and accessories. The use of non-original accessories is not eligible for warranty; if occur accident, the manufacturer will not bear the corresponding responsibility.

2 Using Requirements

2.1 Using Environment

- It is not recommend to use in rainy, snowy, or foggy weather for safety. Also the point cloud data will have more noise.
- It is not recommend to frequently use in dusty environment, which will affect the service life of equipment.
- It is forbidden to expose the device and accessories under extreme temperature. The environment temperature must not be lower or higher than the specification temperature.

2.2 Tips Before Using

- Check whether the laser glass is normal, if there is dust exist, please use the cleaning kit to clean it.
- Check whether the batteries, LT800 tablet has sufficient power.

2.3 Tips During Using

- After powered on, check whether the connection between LT800 tablet and equipment is normal, and whether the status of tracking satellite and board is normal.
- Before start work, check the remaining capacity of the data memory card. If the remaining capacity is less than 10% or does not meet the current collection capacity requirements, the old data file need to be deleted in advance.

2.4 Tips After Using

- After using, place the equipment into equipment case and accessories into accessory case.
- During transportation, take care the equipment and try to avoid bump.

3 Product Description

The RS10 brings a new approach to geospatial surveying by integrating GNSS RTK, laser scanning and visual SLAM technologies into a single platform designed to improve the efficiency and accuracy of indoor and outdoor 3D scanning and surveying tasks. The RS10 is a versatile solution for surveying, civil engineering and BIM professionals, as well as for applications such as agricultural and forestry surveying, power line inspection, material pile volume calculation and data collection in underground spaces. With the RS10, surveyors are able to overcome the challenges of surveying in areas with poor or no GNSS signals, bringing a new level of flexibility and accuracy to their work. By supporting both traditional GNSS RTK surveying and innovative 3D reality capture, the RS10 simplifies fieldwork and improves data reliability.



3.1 Check List

Note: Please refer to the actual delivery list.

RS10 Surveying System configuration list is shown below:

N	Description	Model	Pcs
1	RS10 unit	RS10	1
2	RS10 handle		1
3	Load-bearing pad		1
4	RS10 transport container		1
5	USB3.0 to TYPE-C adapter cable		1
6	Lens cleaning wipes		10
7	32 GB USB flash disk		1
8	SmartGo software		1
9	RS10 Factory Test Certificate		1
10	Notice Card		1
11	RS10 SLAM permanent license		1
12	LT800 accessories (include tablet & tablet clamp&LS license)		1
13	Chest support bracket		1
14	RS10 Battery (3300mAh)	3300mAh	3
15	Battery charger (C300)	C300	1
16	CoPre Standard version package		1

3.2 Delivery of Equipment and Materials

Note: Please refer to the actual delivery list.



- RS10 with handle:



- RS10 with chest support bracket:



- RS10 with handle, load-bearing pad:



- RS10 with LT800 tablet, LT800 tablet clamp:



- LT800 tablet, LT800 tablet clamp:



- Battery (3300mAh):



- Battery charger (C300):



- Lens cleaning wipes:



3.3 Physical Characteristics

3.3.1 Weight and Size

- Weight: 1.9 kg (including RTK and battery).
- Length, width, and height (213.5×126×178mm) are shown below:

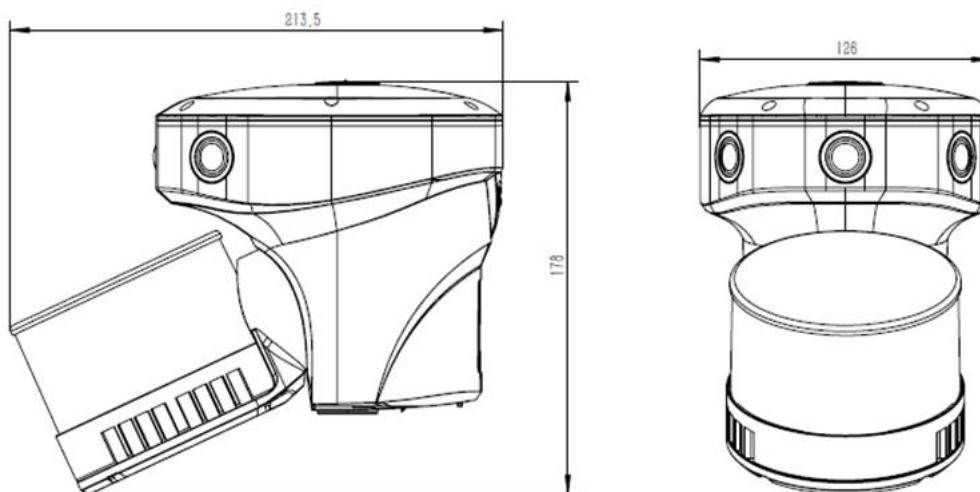

3.3.2 Interface Definition



1. Turn on/off button
2. Type-C port for data copy
3. Battery compartment
4. Handle/ Range pole hole

LED indicator	Device status
red and green lights flash alternately at 1hz frequency	FW Upgrading...
device automatically restarts after green light are steady on	FW Upgraded successfully
the green light flashing rapidly at 2Hz	Device diagnostics
green light is steady on	Device ready
green light blinks at 0.5hz	Collecting...
red light is steady on	Error
red light blinks every 5 seconds	Low battery

3.4 Power Supply and Physical Characteristics

Input voltage	9-20V DC
Power consumption	< 30W
Operating temperature	-20 °C to +50 °C
Storage temperature	-20 °C to +60 °C

4 Product Workflow

For the convenience of users, provide two methods of data collection, SmartGo APP Control and One-Key Control.

4.1 Advance Preparation

- Check the equipment to ensure that the contents and other accessories are not missing.
- Check whether there are any stains on the laser beam exit window and camera. If there are stains, use the cleaning tools provided with the package to gently wipe and clean them.
- Make sure the batteries and LT800 tablet are fully charged.
- Check the device authorization and storage space.

4.2 SmartGo APP Control

4.2.1 WiFi connection

- Click “WiFi name” to search device Wi-Fi (SLAM-XXXXX, XXXXX is the same as the last five characters of the device SN), click “Connect to device” to connect the device to the tablet via Wi-Fi.

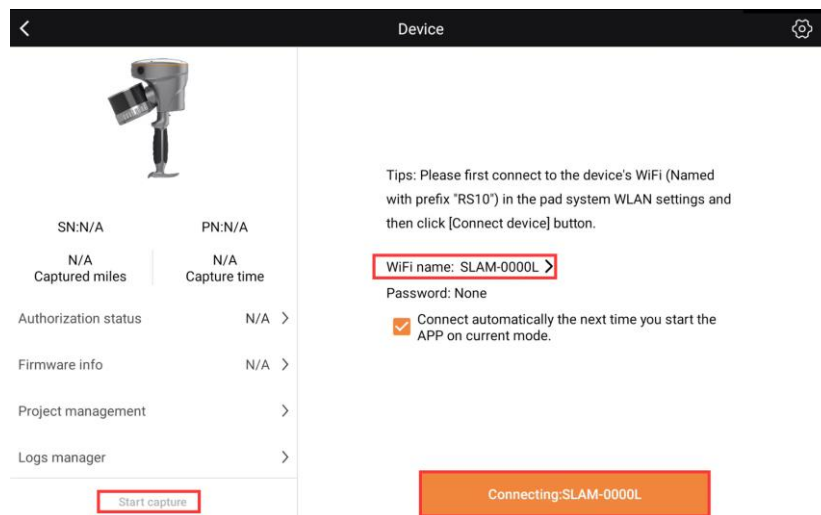

 **Note:** Make sure your tablet's connected to the device's WiFi and that no other apps are stealing that connection.

- Click “Start capture” to enter the data collection interface, shown as below.

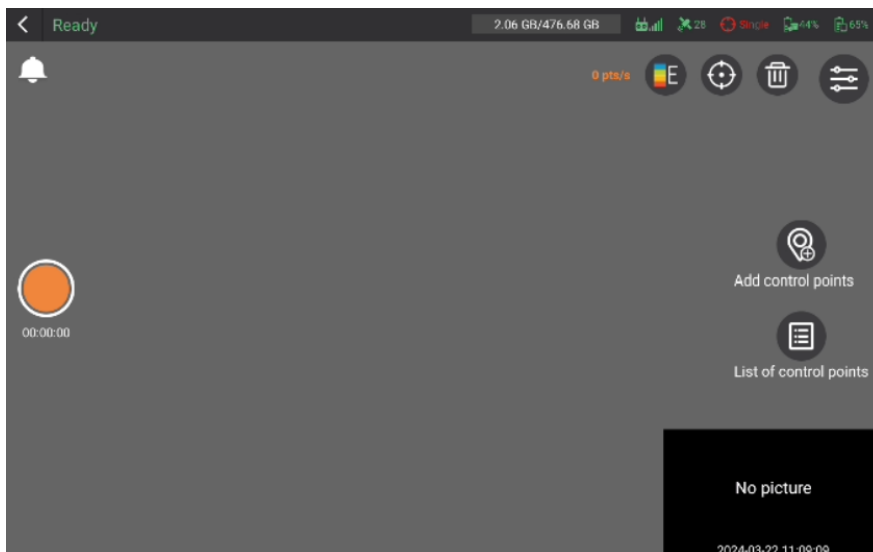

4.2.2 RTK settings

- You can output real-time point cloud data with absolute coordinates either by logging into the CORS account in the RTK settings or through PPK.

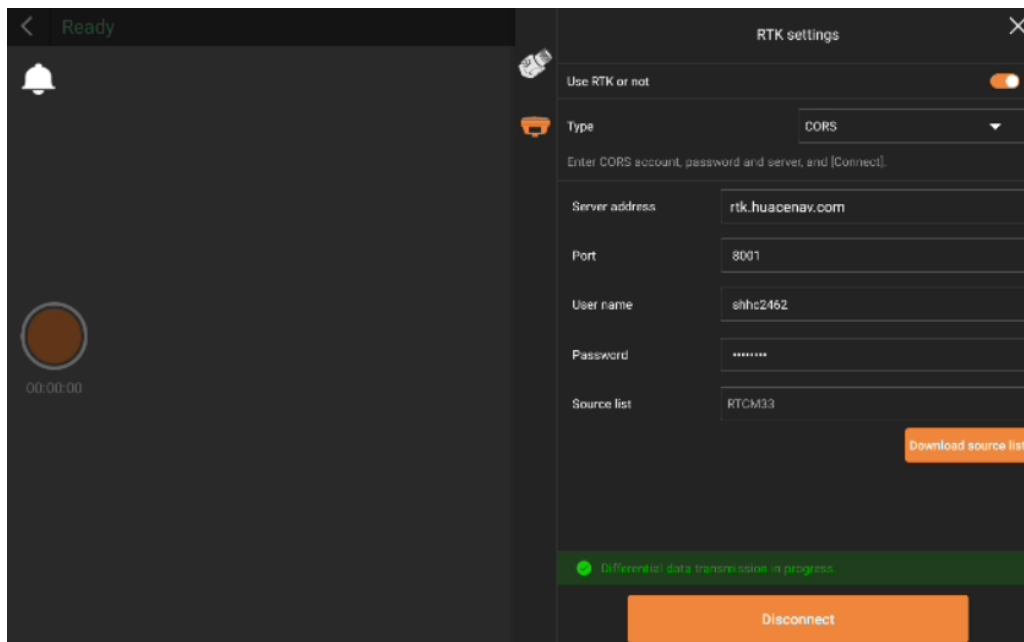

Note:

Alright, when you're logging into CORS, there are a couple of things to keep in mind.

- First, make sure your port settings align with your coordinate system outcomes.
- Second, if you're not logging into CORS, you can still get your absolute coordinate cloud

results through PPK post-processing or trajectory control point optimization in CoPre.

- Third, please avoid logging in with the same account on multiple devices simultaneously. It could hog up the account and cause disconnects.

4.2.3 Start project

- Click on the orange circular button on the left side of the screen to start a project. Remember, project names have to stick to letters or numbers.

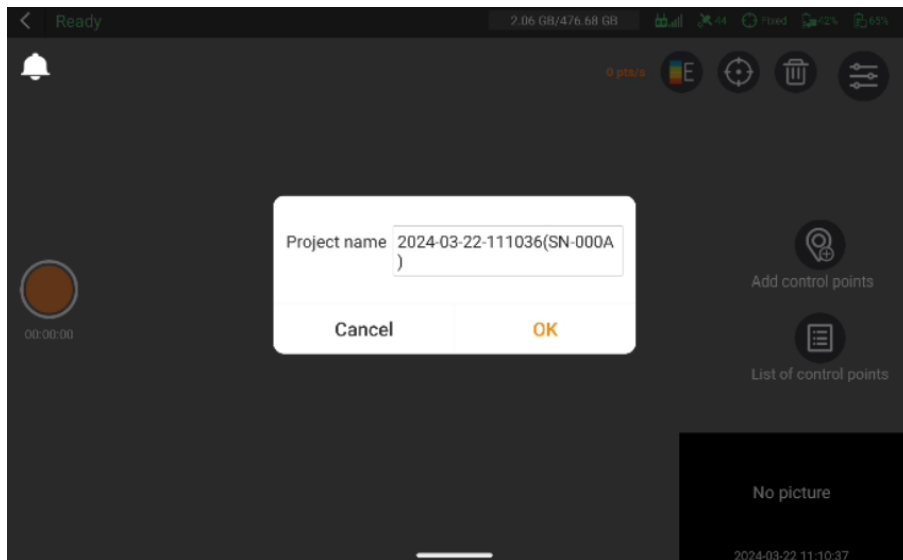

4.2.4 Select capture scene

- After creating the project, select the appropriate capture scene based on the environment, and proceed to data collection within the chosen scene.

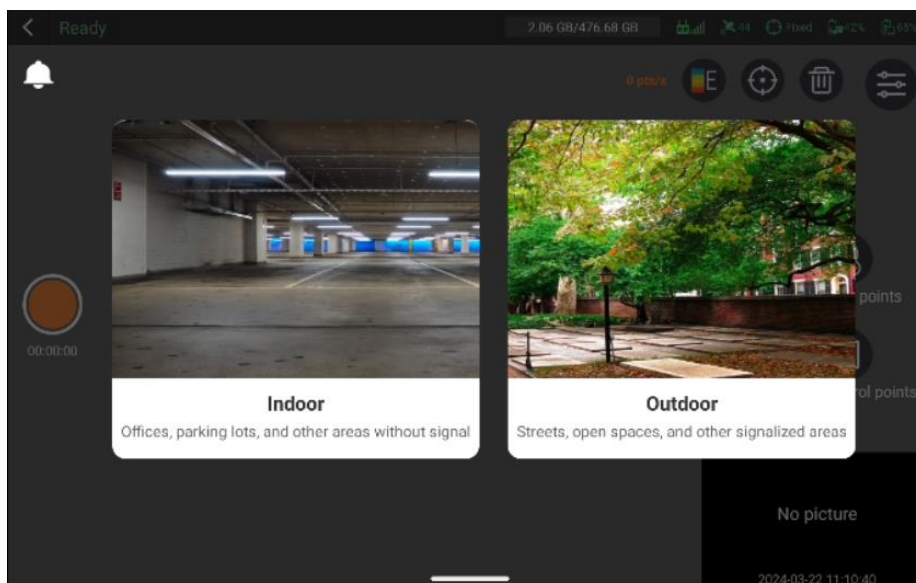

4.2.5 Device initialization

- Initialization starts automatically after selecting capture scene , please keep the device stable and ensure no obstructions around.

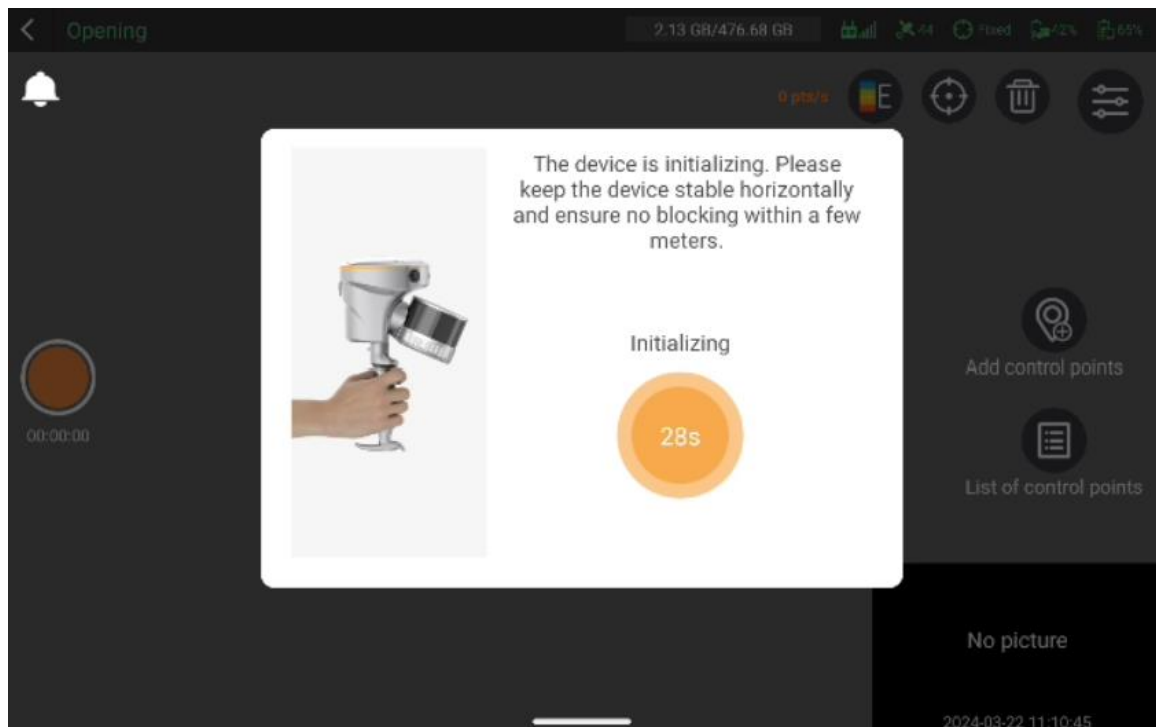

Note:

You'll want to aim it at a scene with lots of features, like buildings or uneven rocks. And watch out for moving objects or obstacles that could block these features. Try to minimize scanning highly reflective surfaces, like glass facades or car windows, to reduce noise in your cloud data.

4.2.6 Start data acquisition

- After the initialization is successful, the device will enter the capture interface, where real-time point cloud and live captured images will appear, which means the device has started data collection automatically.

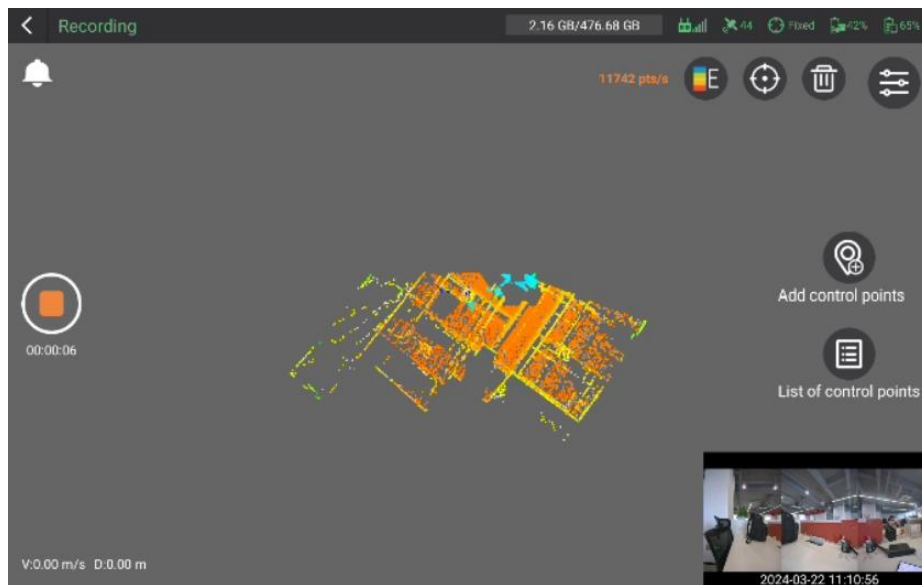

4.2.7 Add control point

- You can add some control points during the data collection. First, align the metal tip of the device's handle with the desired control point. Then click "Add control Points", select the corresponding operation mode, input the control point number, and click "OK" to add the control point.



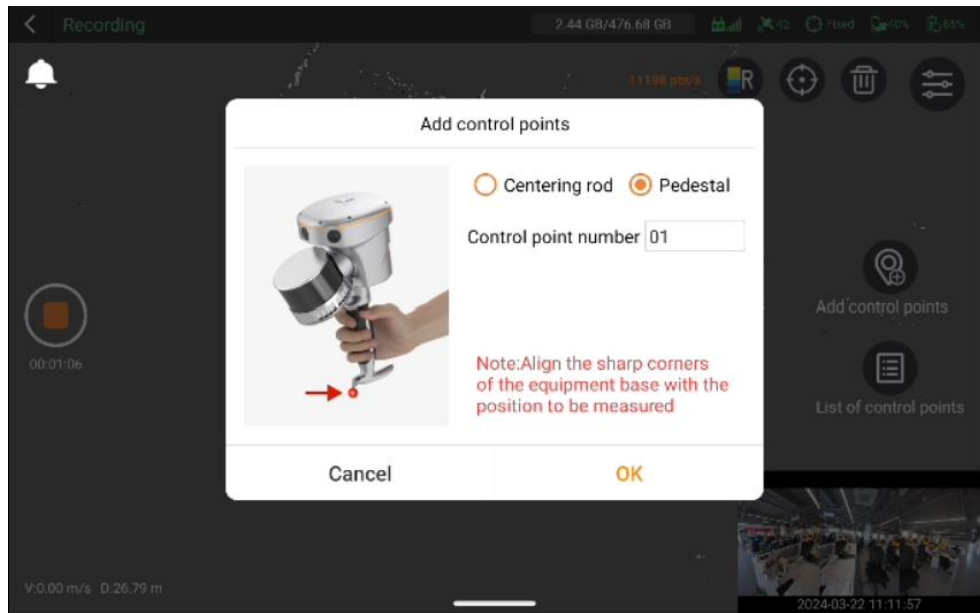

Note:

If you're using the range pole mode, you'll need to input the pole height. That's not necessary for handheld or chest support modes.

Also, try to keep your control point names consistent, and remember, if you're doing coordinate conversions, you'll need at least four control points.

4.2.8 Stop data acquisition

- Click on the orange circular button on the left side of the screen to stop data acquisition.

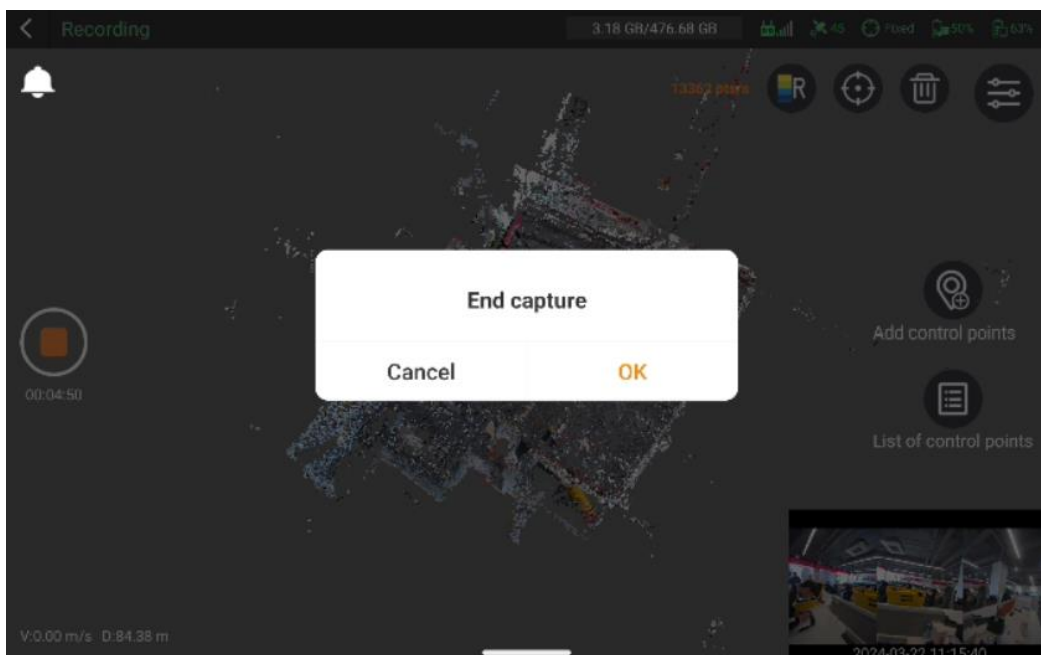

4.3 One-Key control

The RS10 is embedded with one-key acquisition software, equipped with one button (including a LED indicator), the RS10 can be controlled by a single key to complete data collection.

 **Note: In One-Key control mode, you cannot select the capture scene, which defaults to indoor scene. CORS account login is not available.**

- RS10 Power On: Long press the device's "ON/OFF key" for 5s, the indicator light is green, which means the lidar is powered on successfully.
- Device diagnostics: 5s after powering on, the device enters diagnostic mode, with the green light flashing rapidly at 2Hz. If no issue is detected in device diagnostics, the green light will be steady on.
- Start project: Short press the device's "ON/OFF key" to start project, the green light remain steady on.
- Device initialization: Initialization starts automatically , laser rotation indicates that the device is initializing. please keep the device stable and ensure no obstructions around.
- Start data acquisition: After the initialization is successful, the device will start data collection automatically. At this moment, the green light is flashing slowly at 0.5Hz.
- Stop data acquisition: Short press the device's "ON/OFF key" to stop data acquisition.
- RS10 Power Off : Long press ON/OFF Key or 5s to turn off.

4.4 Hot-swapping battery

The RS10 battery compartment can only accommodate one battery at a time, but it is equipped with super capacitors internally, enabling support for hot-swappable battery replacement. During the data collection , when hot-swapping batteries, it is essential to note that after removing the battery, a 60-second battery replacement reminder interface will appear on the tablet.

 **Note: It is necessary to complete the battery replacement within 60 seconds while ensuring that the device's position and orientation remain consistent before and after the battery replacement.**

5 Data preprocessing

5.1 Data copy

You just need connect the RS10 to PC with a TYPE-C adapter cable, then copy the data you need.

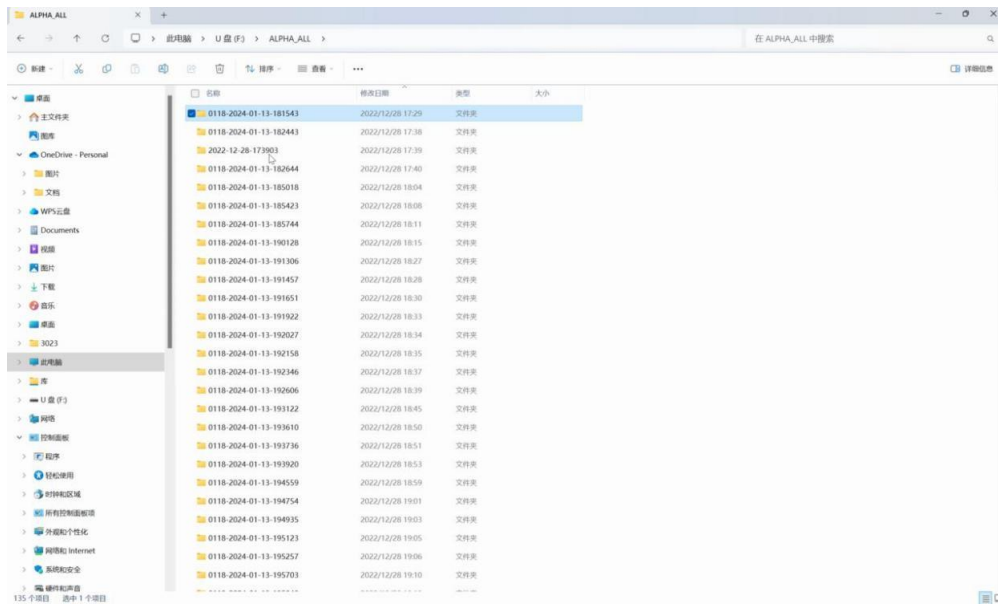

- ☞ When copying data, it is necessary to turn off the device, otherwise the computer won't recognize the device disk.
- ☞ Note: If disk memory is less than 10% or cannot meet storage requirements, user need to empty disk memory in advance.

5.2 Create Task

- Click Home -> Create, pop up the dialog box to create a task.

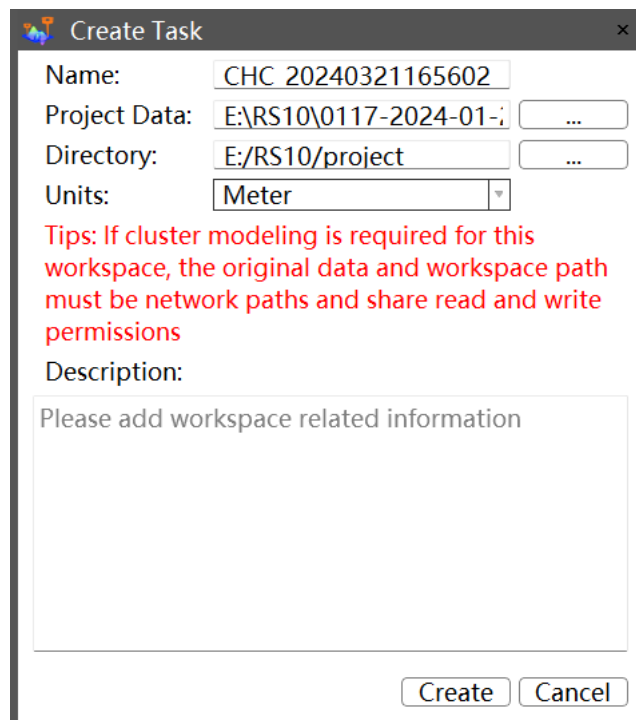
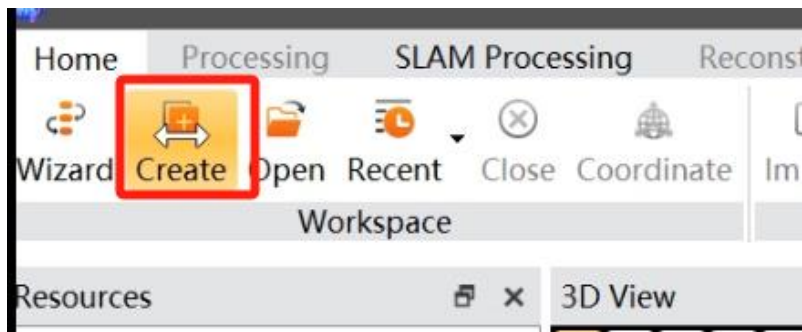

Notes

- Both project data path and output data path not support non-English letters and space. Save the data under English path.
- Configure task name, project data path, output data path, units and task description (option). Finally, click "Create".

5.3 Coordinate System Setting

- After clicking “Create”, a coordinate settings window will pop up, you can choose relative coordinate system or projected coordinate system .

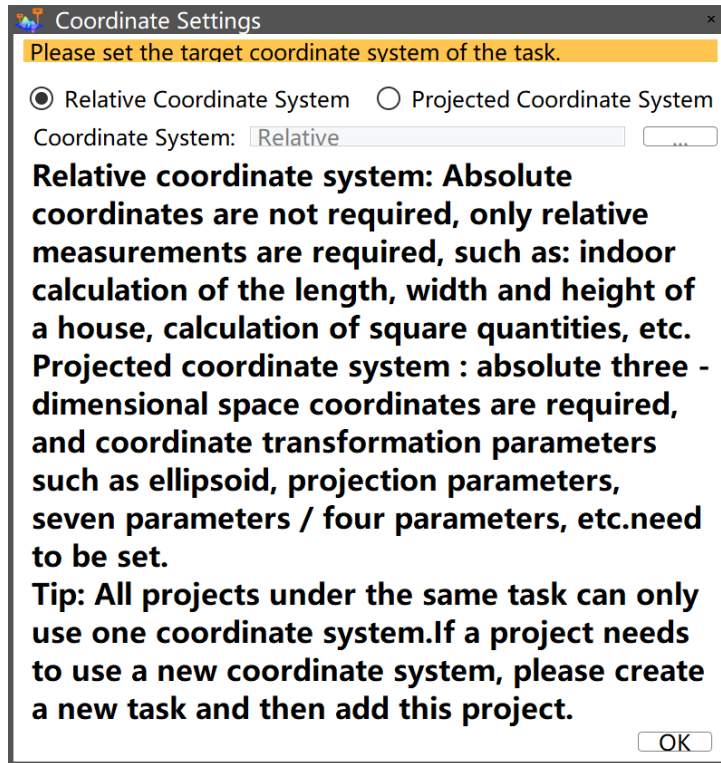

- Click “OK” to complete the new task, the management bar now shows the taskname, :

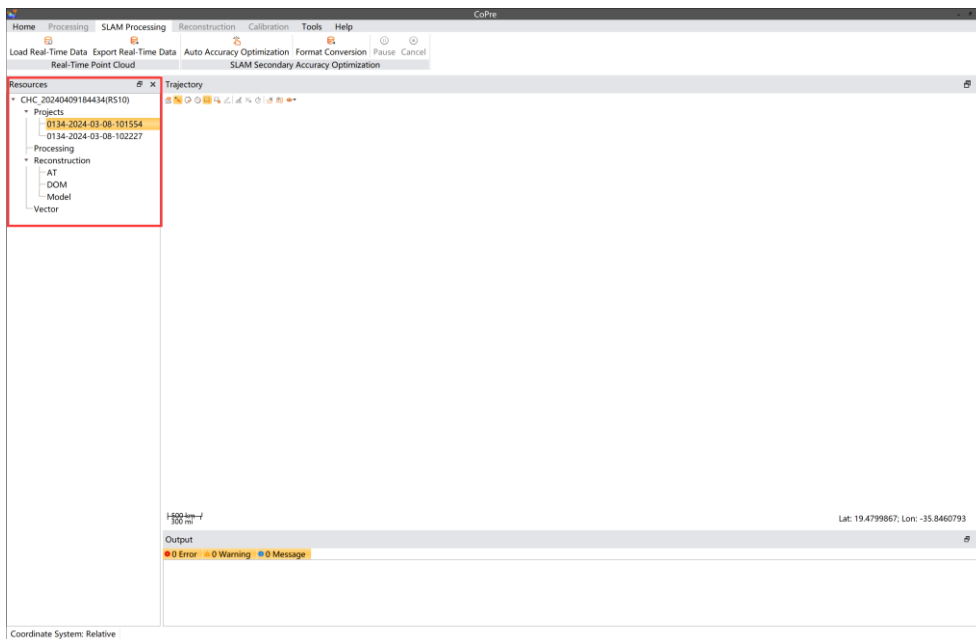

5.4 Real-time Point Cloud

Real-time point cloud data needs to be loaded and generated as 'codata' in the CoPre software after creating a new task. Subsequently, it can be exported in LAS format.

5.4.1 Load real-time point cloud

After creating a new task, in CoPre's SLAM processing module, clicking on 'Load Real-Time Data' will generate and display real-time point cloud results. Real-time point cloud data is stored in the 'SLAM_DATA/RealTime_Codata' folder within the original project directory, in 'codata' format.

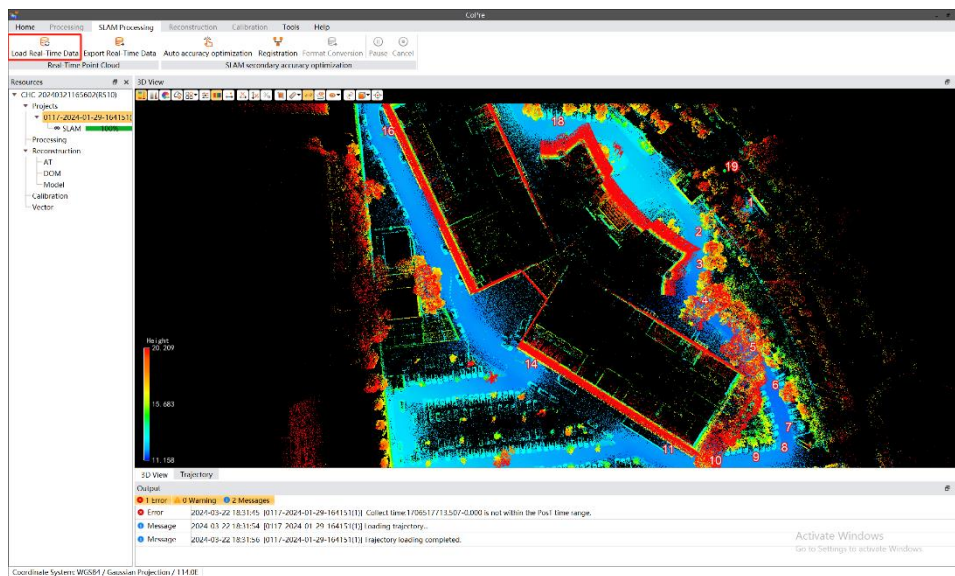

5.4.2 Export real-time point cloud

To export real-time point cloud data in LAS format, click on 'Export Real-Time Data', set the LAS version, segmentation settings, and the output path, then click 'OK' to export. By default, LAS format point cloud results are stored in the 'SLAM_DATA/RealTime_Las' folder within the original project directory.

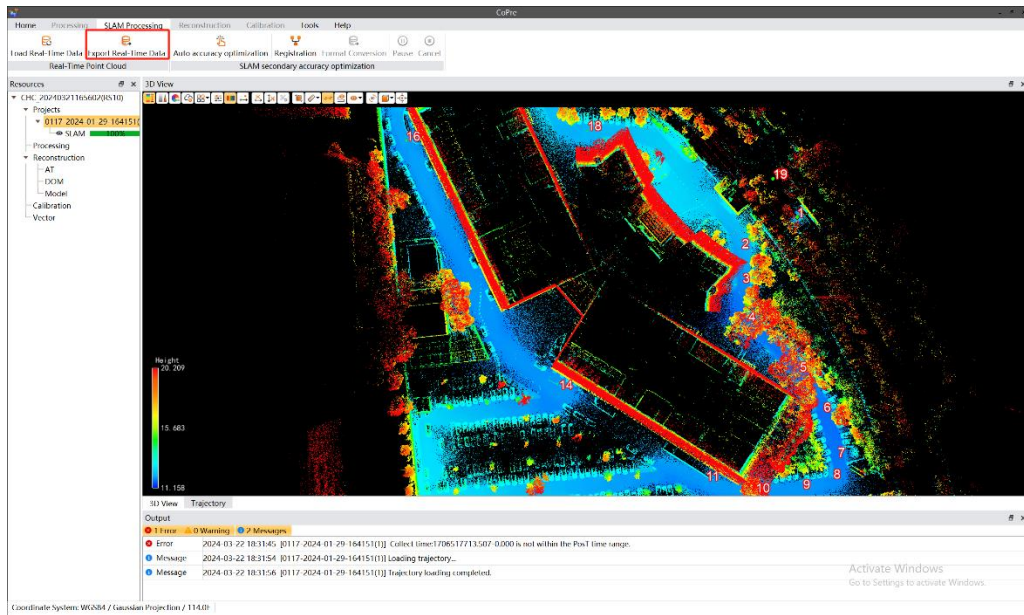

5.5 SLAM Secondary Accuracy Optimization

- Click "Auto Accuracy Optimization", pop up the dialog box to select projects that need to be processed in the list.

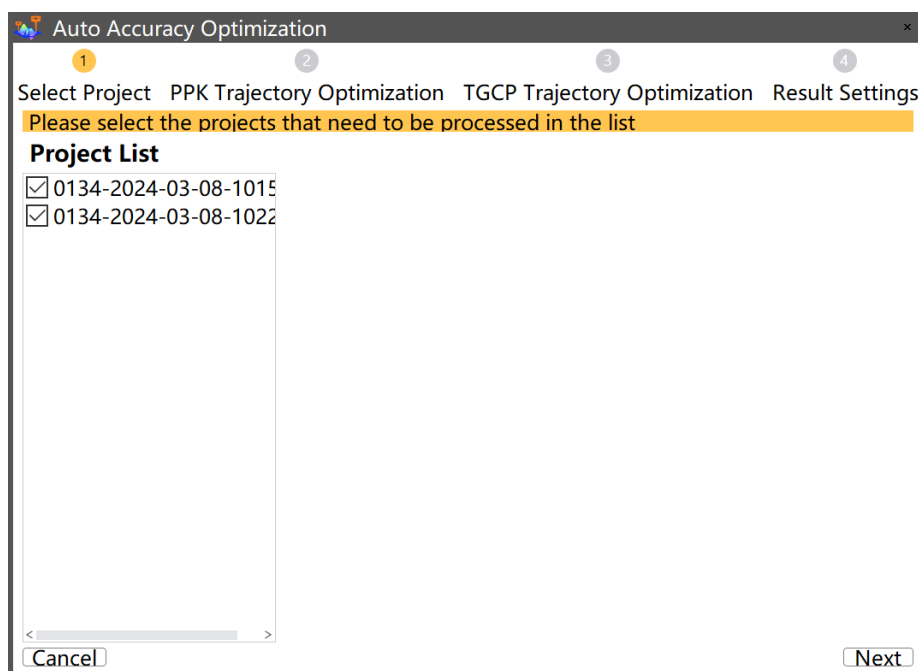
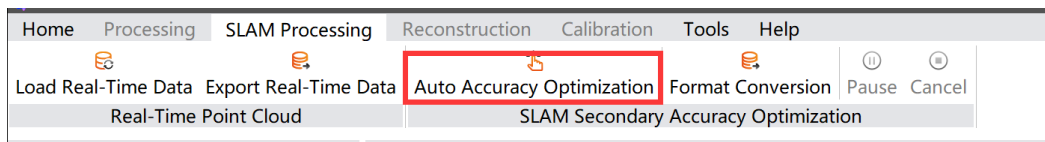

- Click “next” to set PPK trajectory optimization parameters:

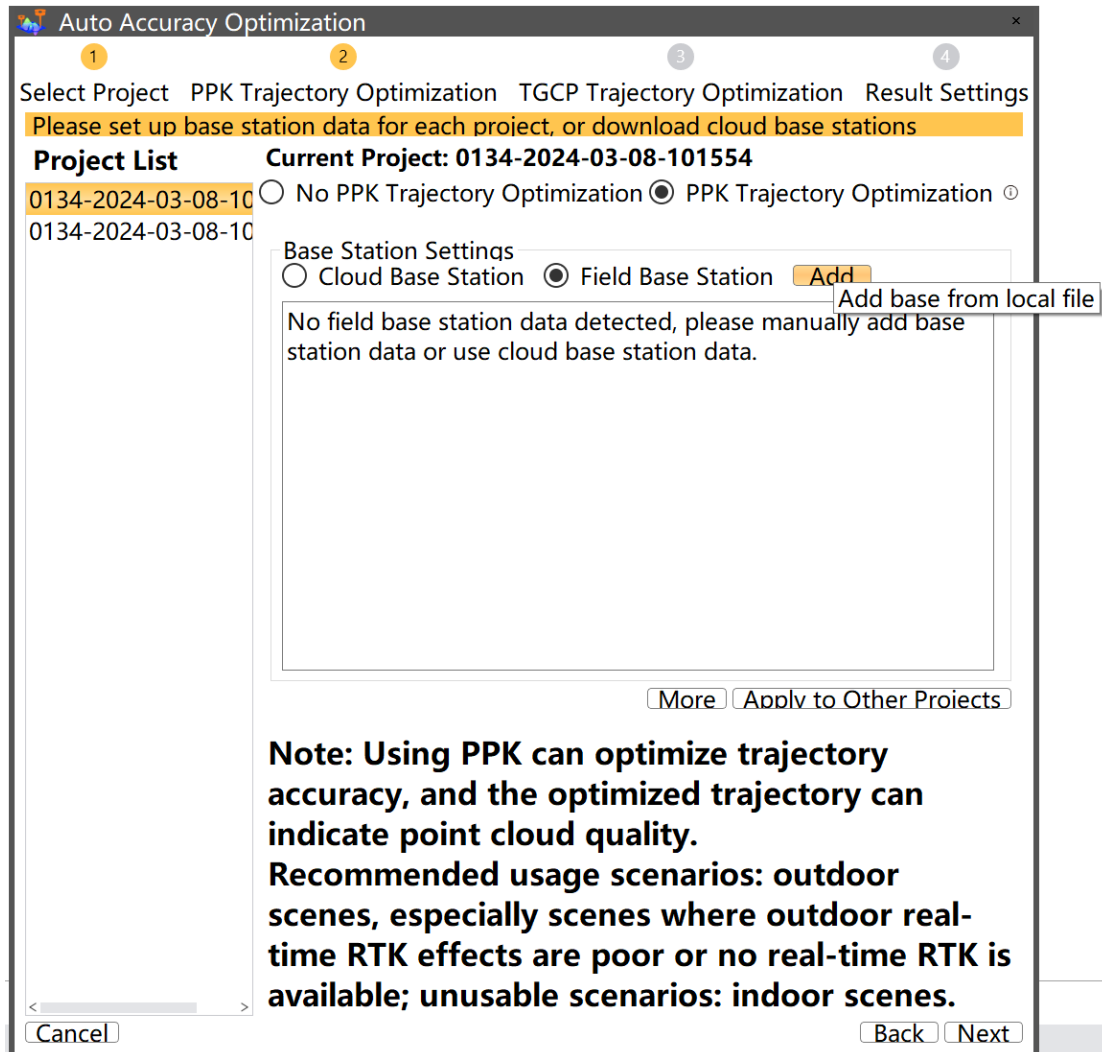

- Click “next” to set TGCP trajectory optimization parameters:
Use trajectory control points to correct the accuracy of SLAM and transform the point cloud from a relative coordinate system to a projected coordinate system. This function can only be used if trajectory control points are collected during data acquisition. Click on "Import" to import the control point file in txt or csv format. The control points will be matched with the trajectory control points collected in the field based on their names.

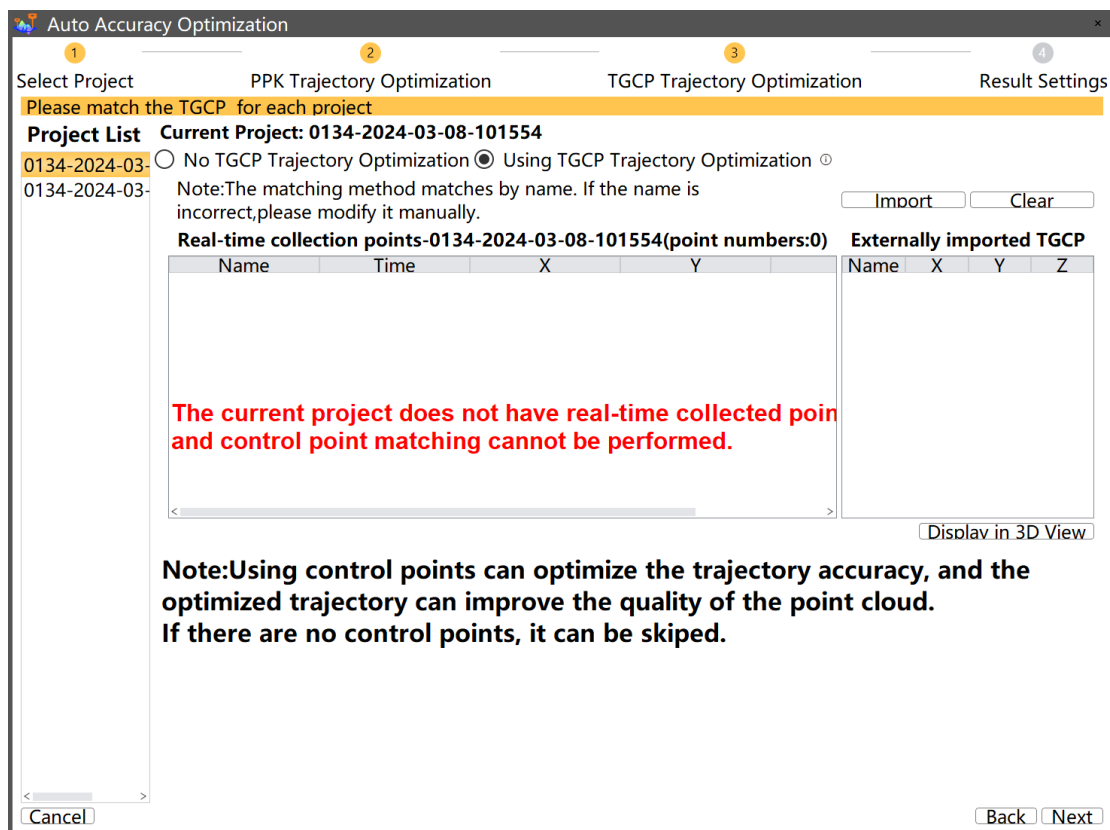

- Click “next” to set result parameters:

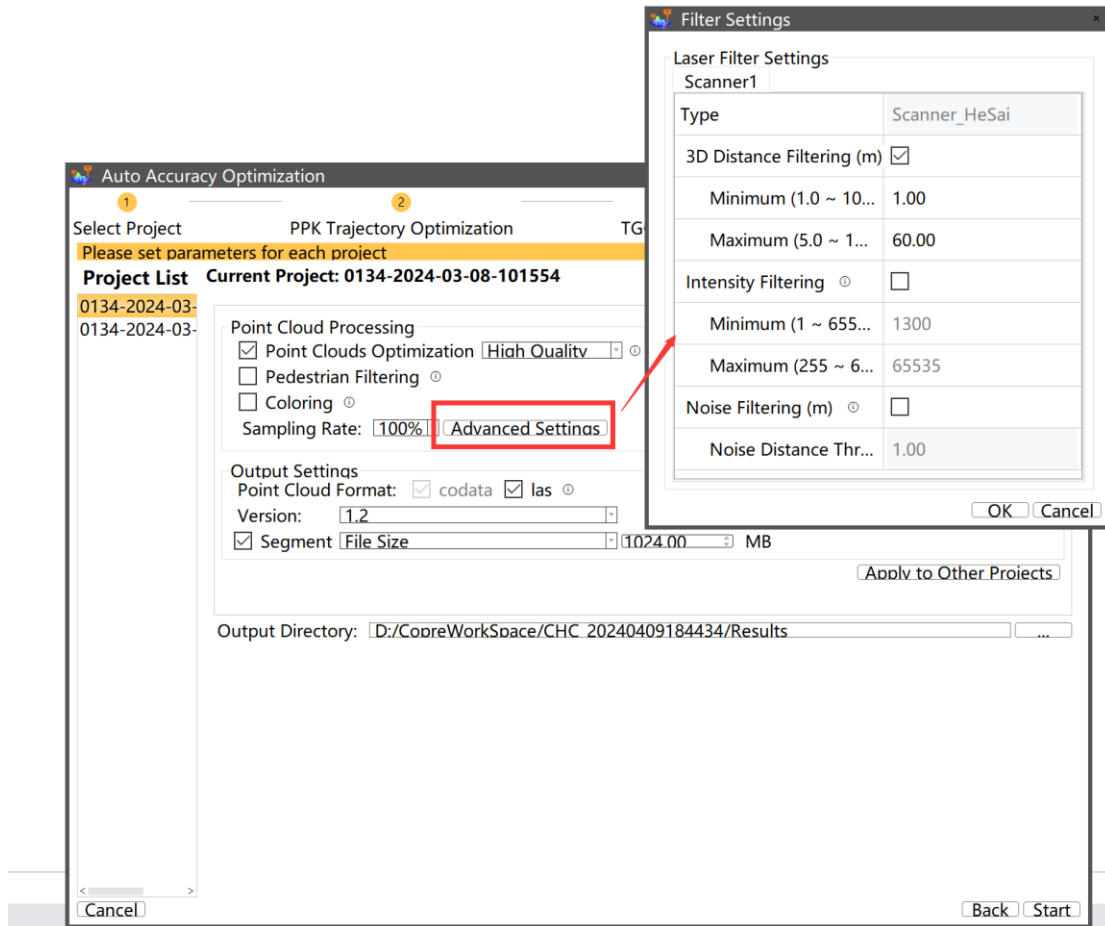

Settings description:

Point Clouds Optimization: Reduce the thickness of the point cloud .

Pedestrian Filtering: Filter moving people and objects.

Coloring: Colorize point cloud use photos.

3D distance filtering: Delete point cloud data that falls outside the specified three-dimensional distance range.

Intensity filtering: Delete point cloud data that falls outside the specified grayscale value range, with the default range being 1300-65535.

Noise filtering: Delete point cloud noise based on the noise distance threshold parameter.

5.6 Result check

Select the project under the "Processing" node, then right-click and choose "Display Trajectory." The resulting trajectory will be loaded into the trajectory view.

Click on two points on the resulting trajectory or drag the mouse left button to select an area. The point cloud corresponding to the selected trajectory will be loaded into the 3D view.

You can perform measurements, check, browsing, and other operations on the point cloud in the 3D view.

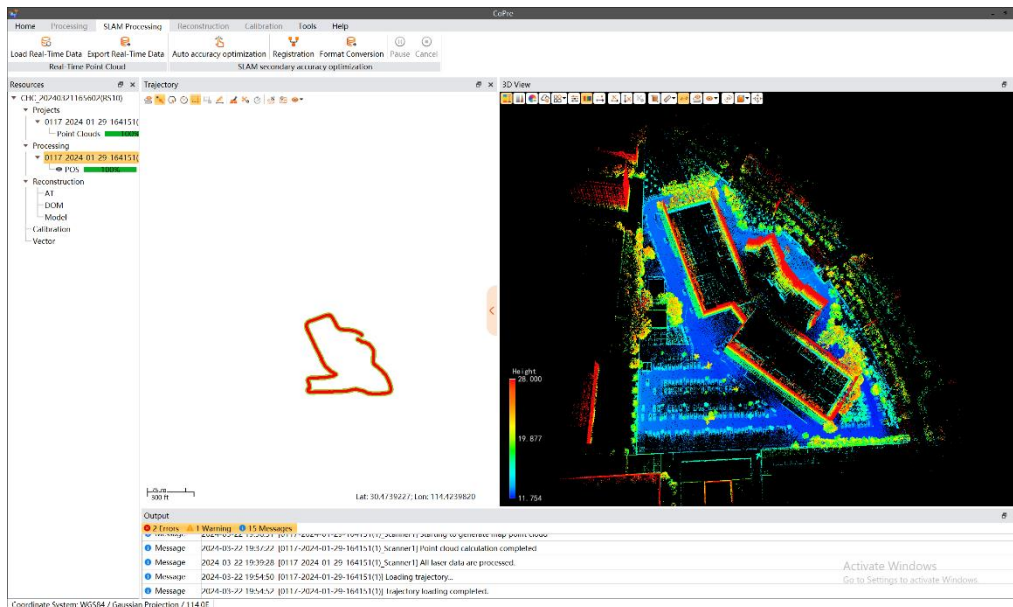
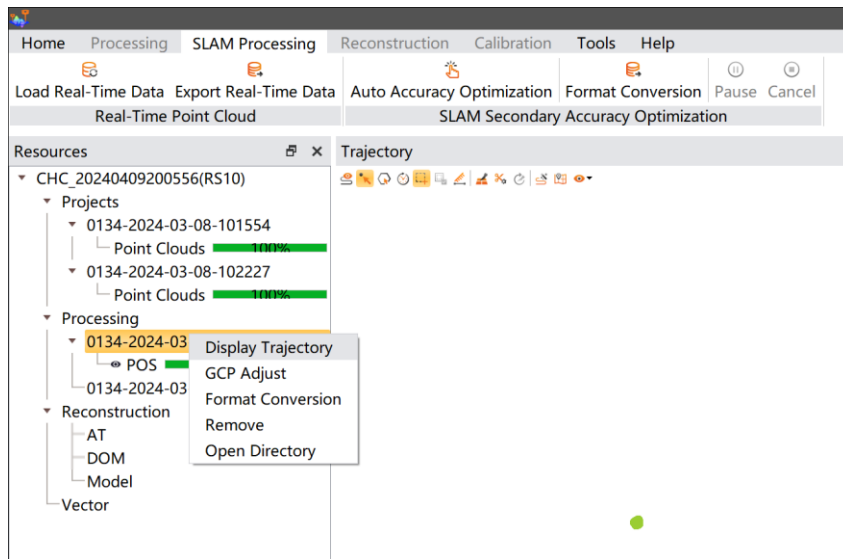

5.7 Format conversion

SLAM solve will generate point cloud of codata and las format, if you need point cloud data in other formats, click on "Format Conversion" to select the desired point cloud format for conversion.

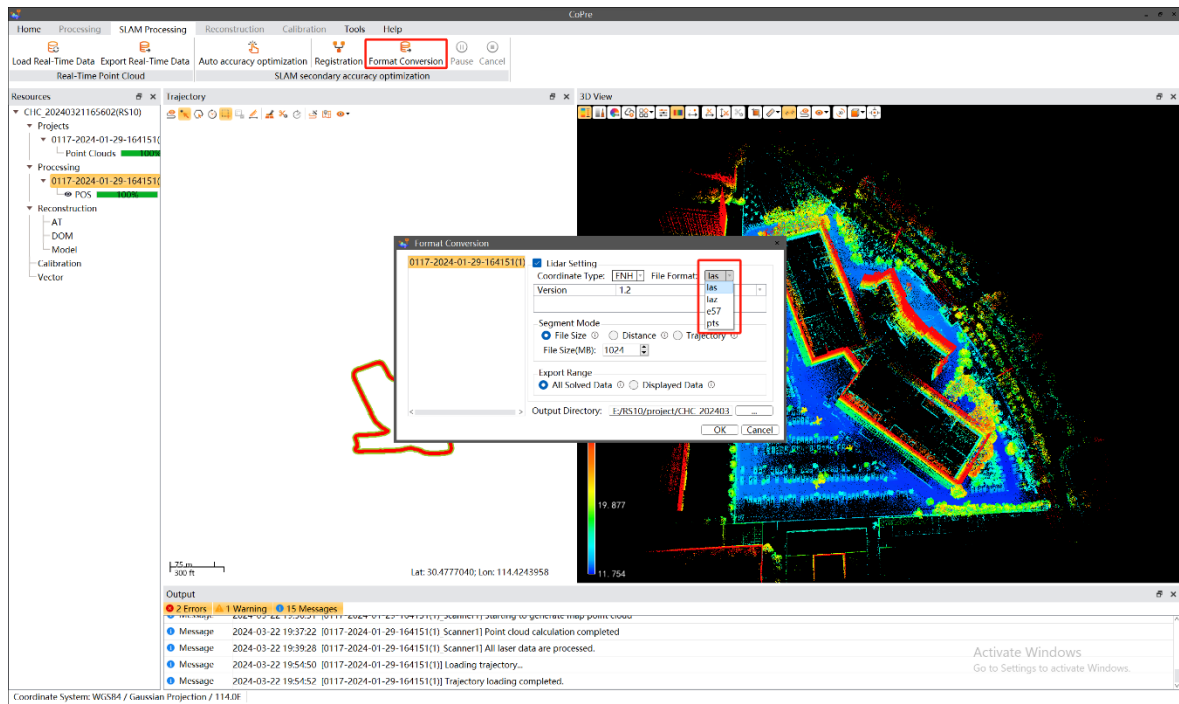

6 Matters Need Attention

6.1 Important Notes

LiDAR measure system is a complex and precise survey system. In daily carrying, using and storing, please operate equipment correctly and maintenance properly. There are some important notes listed below:

- Do not disassemble equipment privately. If equipment has issue, please contact CHCNAV support team.
- Please use the default battery and accessories. Use non-dedicated battery may cause charger exploding or burning. The use of non-original accessories is not eligible for warranty.
- Please use the default battery and accessories. Use non-dedicated battery may cause charger exploding or burning. The use of non-original accessories is not eligible for warranty.
- When using charger for charging, please keep away from fire, flammable or explosive materials to avoid serious consequences such as fire.
- Avoid any strong impact or vibration.
- If need to continue using the instrument for a long period of time or under special conditions such as high humidity environment, please consult the relevant precautions of CHCNAV Support team in advance. Generally, the damaged occurred under a special environment is not covered by the product warranty.

6.2 Product Transportation

- CHCNAV RS10 product equipped special container. During transportation, make sure the container is fixed at a stable location.
- During transportation, please tell relative person that this is precise system container, and it needs to be handled gently. Also, attach fragile label on container.
- If the equipment is sent by express service, the container needs an outer box with foam inside also for safety.
- When transporting or moving batteries, take proper measures to prevent materials from falling or damage.

6.3 Using Tips

- The equipment should be handled gently during use to avoid soiling and scratching its surface, and it is strictly forbidden for surveyors or others sit on the container.
- After long time storage in store, it needs to be taken out regularly (about one month) for

power-on test to check whether the function is normal.

- When it is difficult to rotate any rotating parts of the equipment, please do not forcibly rotate. After the equipment is damaged, please do not continue using, otherwise the damage of the equipment will increase. Do not disassemble equipment in field.
- If faced rain or snow in field during work, please move the equipment into the container quickly.

6.4 Storage Tips

- The room where the equipment is stored should be clean, dry, bright and well ventilated.
- It should be placed flat or upright, and it should not be leaned casually to prevent distortion.



CHC Navigation

Building CHCNAV | Smart Navigation & Geo-Spatial Technology Park

577 Songying Road, 201703, Shanghai, China

Tel: +86 21 542 60 273 | Fax: +86 21 649 50 963

Email: sales@chcnav.com | support@chcnav.com

Skype: chc_support

Website: www.chcnav.com