



# Owner's Manual

## 2018 Q3



## Foreword

Thank you for choosing an Audi - we value your trust in us.

Your new Audi will allow you to experience the best in groundbreaking technology and premium quality equipment a vehicle has to offer. We recommend that you read your Owner's Manual thoroughly so that you quickly become acquainted with your Audi and make use of all of its features.

In addition to explaining how the different features work, we provide many useful tips and information concerning your safety, how to care for your vehicle and how to maintain your vehicle's value. We also give you useful tips and information on how to drive your vehicle more efficiently and in an environmentally friendly manner.

We hope you enjoy driving your Audi and we wish you safe and pleasant motoring.

**AUDI AG**

## Table of contents

---

<b>About this Owner's Manual</b> . . . . .	4	Starting and stopping the engine (vehicles with an ignition lock) . . . . .	60
<b>Cockpit</b> . . . . .	6	Starting and stopping the engine (vehicles with a convenience key) . . . . .	61
<b>Cockpit overview</b> . . . . .	6	Messages . . . . .	63
Controls at a glance . . . . .	6	Electromechanical parking brake . . . . .	63
<b>Instruments and indicator lights</b> . . . . .	8	Starting from a stop . . . . .	65
Instruments . . . . .	8	Driving offroad . . . . .	65
Indicator lights . . . . .	10	Automatic transmission . . . . .	66
On-Board Diagnostic System (OBD) . . . . .	17	<b>Trailer towing</b> . . . . .	73
<b>Driver information system</b> . . . . .	18	Driving with a trailer . . . . .	73
Overview . . . . .	18	<b>Driver assistance</b> . . . . .	76
Operation . . . . .	18	<b>Assistance systems</b> . . . . .	76
On-board computer . . . . .	19	Speed warning system . . . . .	76
Efficiency program . . . . .	20	Cruise control system . . . . .	76
<b>Starting and driving</b> . . . . .	22	Audi side assist . . . . .	78
<b>Opening and closing</b> . . . . .	22	Audi drive select . . . . .	80
Central locking . . . . .	22	<b>Parking systems</b> . . . . .	82
Luggage compartment lid . . . . .	27	General information . . . . .	82
Child safety lock . . . . .	30	Rear parking system . . . . .	83
Power windows . . . . .	30	Parking system plus . . . . .	83
Panorama glass roof . . . . .	31	Rearview camera . . . . .	84
<b>Lights and Vision</b> . . . . .	33	Adjusting the display and the warning tones . . . . .	87
Exterior lighting . . . . .	33	Error messages . . . . .	88
Interior lighting . . . . .	35	Trailer hitch . . . . .	88
Vision . . . . .	36	<b>Intelligent Technology</b> . . . . .	89
Windshield wipers . . . . .	38	Electronic stabilization control (ESC) . . . . .	89
Digital compass . . . . .	40	Brakes . . . . .	91
<b>Seats and storage</b> . . . . .	42	Electromechanical steering . . . . .	93
General information . . . . .	42	All wheel drive (quattro) . . . . .	93
Front seats . . . . .	42	Energy management . . . . .	94
Head restraints . . . . .	43	Notice about data recorded by the Event Data Recorder and vehicle control modules . . . . .	95
Sockets . . . . .	44	<b>Safety first</b> . . . . .	97
Storage . . . . .	45	<b>Driving safety</b> . . . . .	97
Luggage compartment . . . . .	46	Basics . . . . .	97
Roof rack . . . . .	49	Correct passenger seating positions . . . . .	98
<b>Warm and cold</b> . . . . .	51	Pedal area . . . . .	101
Climate control system . . . . .	51	Storing cargo correctly . . . . .	102
<b>Driving</b> . . . . .	57	Reporting Safety Defects . . . . .	104
General information . . . . .	57		
Steering . . . . .	59		

<b>Safety belts</b> .....	106	Replacing wheels .....	191
General information .....	106	Spare tire .....	197
Why use safety belts? .....	107		
Safety belts .....	109	<b>Fuses and bulbs</b> .....	199
Belt tensioners .....	112	Electrical fuses .....	199
		Bulbs .....	201
<b>Airbag system</b> .....	114		
Important information .....	114	<b>Emergency situations</b> .....	203
Front airbags .....	118	General .....	203
Monitoring the Advanced Airbag System .	124	Starting by pushing or towing .....	203
Side airbags .....	128	Starting with jumper cables .....	203
Side curtain airbags .....	131	Use of jumper cables .....	204
		Towing with a tow truck .....	205
<b>Child safety</b> .....	134	Raising the vehicle .....	207
Important information .....	134		
Child safety seats .....	140	<b>Accessories and Technical Data</b> .	209
Securing child safety seats .....	144	<b>Technical data</b> .....	209
LATCH system (lower anchorages and		Vehicle specifications .....	209
tethers for children) .....	147	Notes about technical data .....	209
Additional information .....	151	Weights .....	209
		Dimensions .....	210
<b>Maintenance and Care</b> .....	152	Capacities .....	210
<b>Checking and Filling</b> .....	152	Gasoline engines .....	211
Fuel .....	152		
Refueling .....	153	<b>Consumer Information</b> .....	212
Catalytic converter .....	155	Warranty coverages .....	212
Engine compartment .....	155	Operating your vehicle outside the U.S.A.	
Engine oil .....	158	or Canada .....	212
Cooling system .....	162	Audi Service Repair Manuals and	
Brake fluid .....	163	Literature .....	212
Battery .....	163	Maintenance .....	212
Windshield washer system .....	165	Accessories and technical changes .....	214
Service interval display .....	165	Declaration of compliance for	
		telecommunications equipment and	
<b>Wheels</b> .....	166	electronic systems .....	215
Wheels and Tires .....	166		
Tire pressure monitoring system .....	183	<b>Index</b> .....	216
<b>Care and cleaning</b> .....	185		
General information .....	185		
Car washes .....	185		
Cleaning and care information .....	186		
Placing your vehicle out of service .....	190		
<b>Do It Yourself</b> .....	191		
<b>Emergency assistance</b> .....	191		
General information .....	191		
Equipment .....	191		

## About this Owner's Manual

---

This Owner's Manual applies to all versions of this model. It contains important information, tips, suggestions and warnings for using your vehicle.

Keep this manual in your vehicle at all times. This is especially important if you loan your vehicle to others or sell it.

This owner's manual describes the **equipment range** specified for this model at the time of printing. Individual equipment options described may only be available at a later date or may only be offered in certain countries.

Some sections in this manual do not apply to all vehicles. When this is the case, the beginning of the section indicates the **validity**, for example "Applies to vehicles: with cruise control system". Optional or vehicle-specific equipment is also identified with an asterisk "\*".

The **illustrations** in this manual are a guide, and some of the details in your vehicle may differ from the illustration.

All **directions**, such as "left", "right", "front" and "rear", are based on the vehicle's direction of travel.

\* Optional or vehicle-specific equipment

▶ The section continues on the next page.

⇒ ⚠ Cross reference to a "WARNING" within a section. If a page number is indicated, the WARNING is located outside of the section.

### **WARNING**

Text with this symbol contains information about safety and how to reduce the risk of serious personal injury or death.

### **Note**

Text with this symbol contains information about reducing the risk of damage to your vehicle.

### **For the sake of the environment**

Text with this symbol contains information on protecting the environment.

### **Tips**

Text with this symbol contains additional useful information.



# Cockpit overview

## Controls at a glance

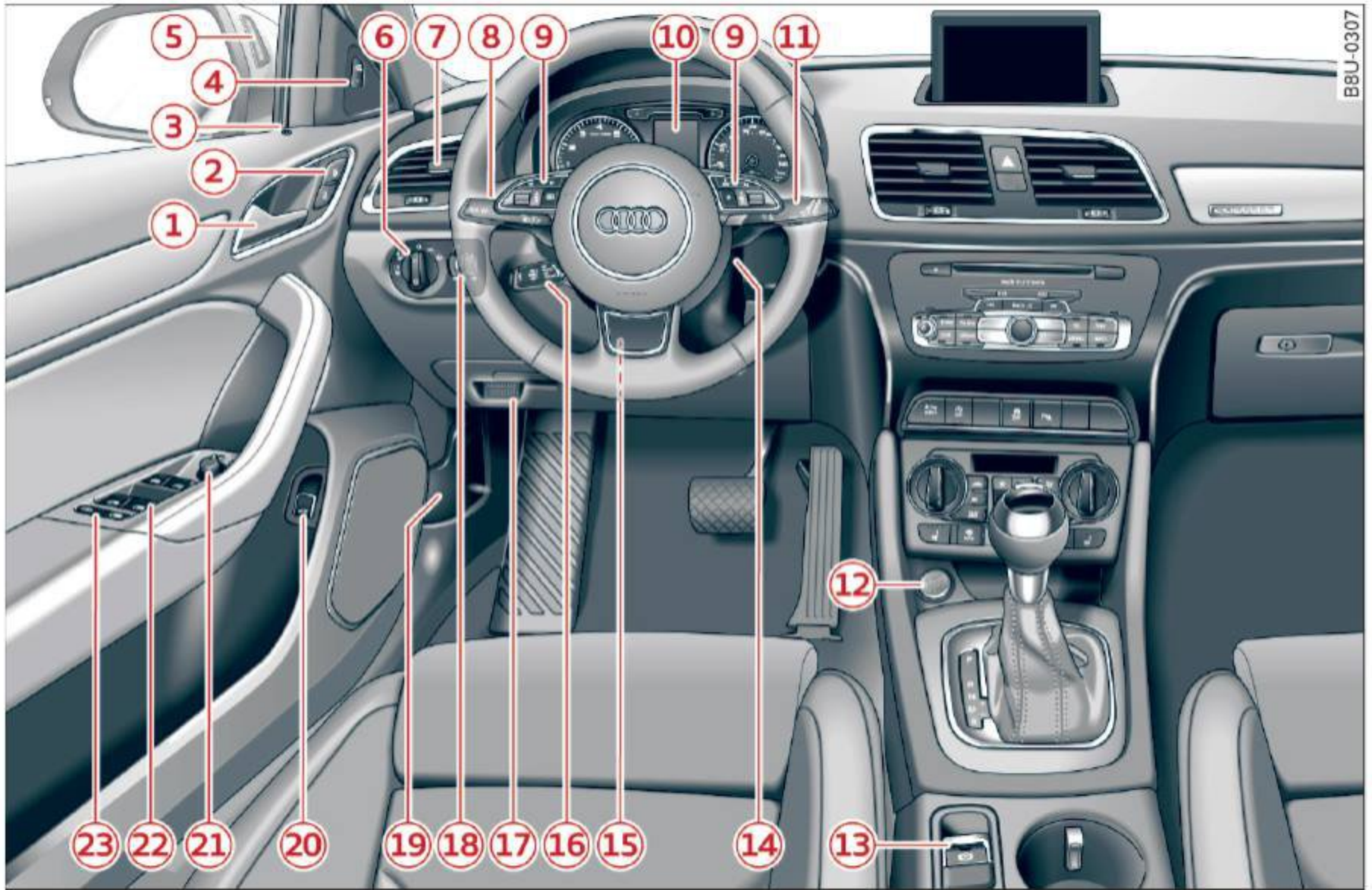

Fig. 1 Cockpit: left section

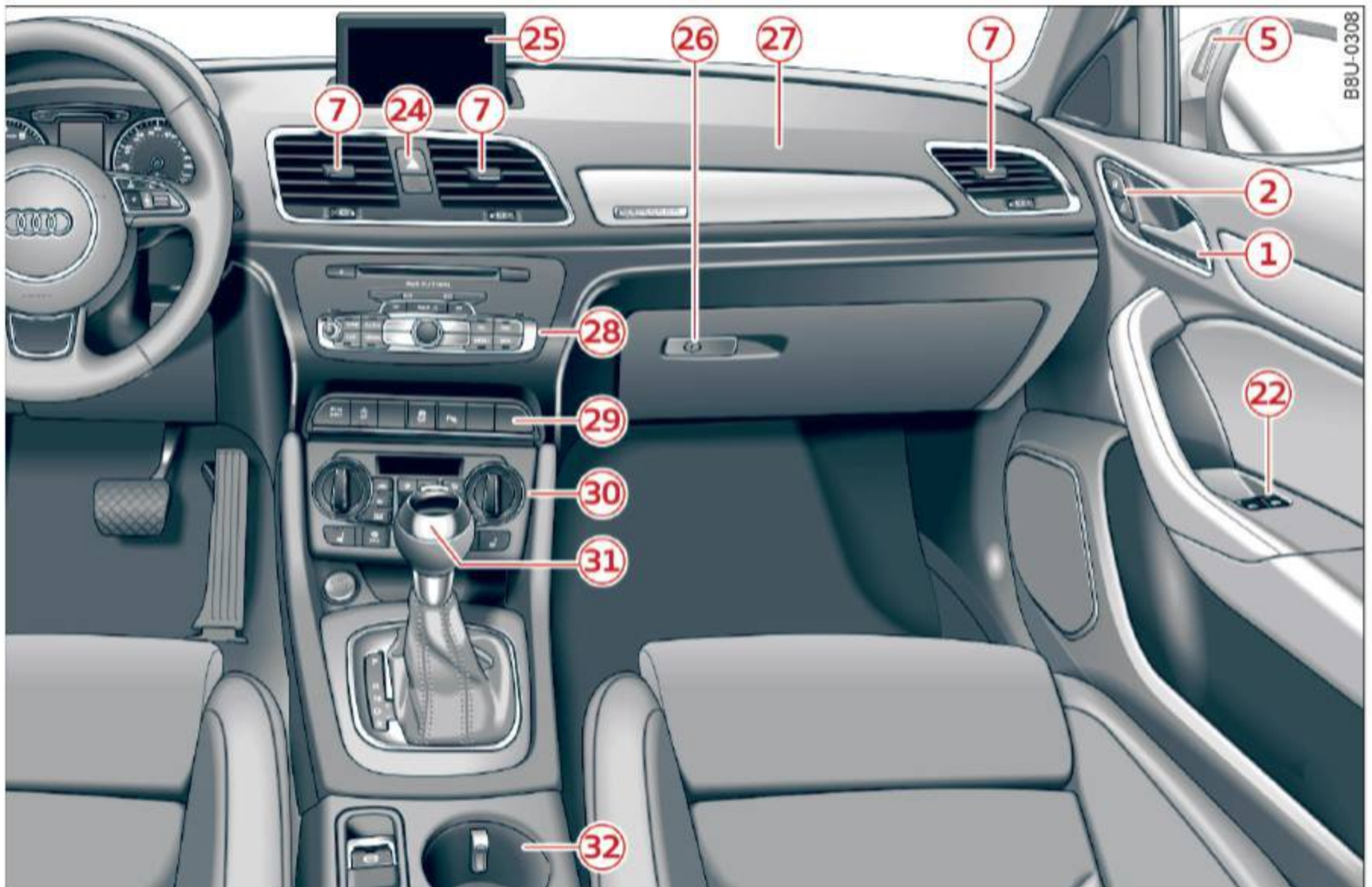

Fig. 2 Cockpit: right section



① Door handle		②② Power windows	30
② Central locking switch	25	②③ Child safety lock	30
③ Central locking LED	22	②④ Buttons/indicator lights for:	
④ Side assist button	78	– Emergency flashers	34
⑤ Side assist display	78	– PASSENGER AIR BAG OFF	125
⑥ Headlight control switch	33	②⑤ Infotainment system display (does not fold away)	
⑦ Air vents with thumbwheel		②⑥ Glove compartment	45
⑧ Lever for turn signal and high beams	34	②⑦ Front passenger's airbag	118
⑨ Multifunction steering wheel with:		②⑧ Infotainment system control panel	
– Horn		②⑨ Buttons/indicator lights for:	
– Driver's airbag	118	– Drive select	80
– Driver information system controls	18	– Electronic Stabilization Control (ESC)	90
– Audio, telephone, navigation and voice recognition controls		– Parking aid	82
– Programmable steering wheel button	19	– Hill hold assist	91
– Rocker switches for tiptronic mode	70	③⑩ Climate control system	54
⑩ Instrument cluster	8	③⑪ Selector lever (automatic transmission)	66
⑪ Windshield washer system lever	38	③⑫ Center console with:	
⑫ <b>START ENGINE STOP</b> button	61	– Cup holder	45
⑬ Parking brake button	63	– Socket	44
⑭ Starting the engine when there is a malfunction or ignition lock	63	– USB charging port	
⑮ Steering wheel adjustment	59		
⑯ Cruise control lever	76		
⑰ Data link connector for On-Board Diagnostic System (OBD II)	17		
⑱ Instrument illumination	35		
⑲ Hood release	155		
⑳ Automatic luggage compartment lid	28		
㉑ Power exterior mirror adjustment	36		

**i Tips**

- Some the equipment listed here is only installed in certain models or is available as an option.
- The image in the instrument cluster display depends on the vehicle equipment. A maximum of two versions will be pictured in this Owner's Manual.
- A separate operating manual describes how to operate the Infotainment system.

# Instruments and indicator lights

## Instruments

### Instrument cluster overview

The instrument cluster is the central information center for the driver.



Fig. 3 Instrument cluster overview

- ① **SET** button ..... 9
- ② Tachometer ..... 9
- ③ Engine coolant temperature gauge .. 8
- ④ Turn signal indicator lights ..... 34
- ⑤ Display with:
  - Indicator lights ..... 10
  - Driver information system ..... 18
- ⑥ Speedometer
- ⑦ Fuel level ..... 9
- ⑧ Trip odometer reset button **O.O** . 9

**i Tips**  
 The instrument illumination for the needles and dials turns on when the ignition is turned on and the lights are turned off. The illumination for the gauges reduces automatically and eventually turns off as brightness outside increases. This function reminds the driver to turn the low beams on at the appropriate time.

### Coolant temperature indicator

The coolant temperature indicator ③ ⇒ page 8, fig. 3 only operates when the ignition is switched

on. To prevent engine damage, please observe the following notes about the temperature ranges.

#### Cold range

If the needle is at the bottom of the gauge, the engine has not reached operating temperature yet. Avoid high engine speeds, full accelerating and heavy engine loads.

#### Normal range

The engine has reached operating temperature when the needle moves into the center of the gauge under normal driving conditions. The needle may move farther to the right on the gauge with heavier engine load at high outside temperatures. If the needle is far over on the right side of the gauge and the  indicator light turns on in the instrument cluster, then the coolant temperature is too high ⇒ page 12.

#### ! Note

- Auxiliary headlights and other accessories in front of the cooling-air intake impair the cooling effect of the coolant. This increases the risk of the engine overheating during

high outside temperatures and heavy engine load.

- The front spoiler also helps to distribute cooling air correctly while driving. If the spoiler is damaged, the cooling effect will be impaired and the risk of the engine overheating will increase. See an authorized Audi dealer or authorized Audi Service Facility for assistance.

### Tachometer

The tachometer displays the engine speed in revolutions per minute (RPM).

You should shift to the next lowest gear when the engine speed is below 1,500 RPM. The beginning of the red zone in the tachometer indicates the maximum permissible engine speed for all gears once the engine has been broken in and when it is warmed up to operating temperature. Before reaching the red zone, you should shift into the next higher gear, choose the D or S selector lever position, or remove your foot from the accelerator pedal.

#### Note

The needle in the tachometer  ⇒ page 8, fig. 3 may only be in the red area of the gauge for a short time or there is a risk of engine damage.

#### For the sake of the environment

Upshifting early helps you to save fuel and reduces operating noise.

### Fuel level

The fuel level indicator only operates when the ignition is switched on.

The  ⇒ page 15 turns on if the reserve quantity of fuel is reached.

The fuel tank capacity of your vehicle is listed in the **Technical Data** section ⇒ page 210.

#### Note

Never drive until the tank is completely empty. The irregular supply of fuel that results

from that can cause engine misfires. Uncombusted fuel will then enter the exhaust system. This can cause overheating and damage to the catalytic converter.



### Odometer



Fig. 4 Instrument cluster: odometer

### Trip odometer and odometer

The trip odometer  shows the distance driven since it was last reset. It can be used to measure short distances.

The trip odometer can be reset to zero by pressing the  reset button  ⇒ page 8, fig. 3.

The odometer  shows the total distance that the vehicle has been driven.

### Malfunction indicator

If there is a malfunction in the instrument cluster, **DEF** will appear in the trip odometer display. Have the malfunction corrected as soon as possible.

### Time/date display

You can switch between the quartz clock or the GPS controlled clock\* depending on the vehicle equipment. For more information, refer to your MMI Operating Manual.

### Outside temperature display

The instrument cluster display shows the outside temperature. At temperatures below 42 °F (+5 °C), a snowflake symbol appears in front of the temperature display.

## Instruments and indicator lights

If your vehicle is stationary or if you are driving at very low speeds, the temperature displayed may be slightly higher than the actual temperature outside due to the heat radiating from the engine.

### WARNING

Do not assume the roads are free of ice based on the outside temperature display. Be aware that there may be ice on roads even when the outside temperature is around 42 °F (+5 °C) and that ice can increase the risk of accidents.

### Tips

You can set the units used for temperature, speed and other measurements in the Infotainment system.

## Indicator lights

### Description

The indicator lights in the instrument cluster blink or turn on. They indicate functions or malfunctions. With some indicator lights, messages may appear and warning signals may sound.

Some indicator lights are shown in multiple colors in the instrument cluster display.

### Display in Driver information system







The indicator lights and messages in the display can be covered by other displays. Displaying driver messages again ⇒ *page 18, Operating using the windshield wiper lever*, ⇒ *page 19, Operating using the multifunction steering wheel*.

### Overview





Some indicator lights turn on briefly as a function check when you switch the ignition on. These systems are marked with a ✓ in the following tables. If one of these indicator lights does not turn on, there is a malfunction in that system.









#### Red indicator lights



<b>BRAKE</b>	<b>USA models:</b> Brake system ✓ ⇒ <i>page 11</i>
--------------	--

	<b>Canada models:</b> Brake system ✓ ⇒ <i>page 11</i>
<b>PARK</b>	<b>USA models:</b> Electromechanical parking brake ⇒ <i>page 12</i>
	<b>Canada models:</b> Electromechanical parking brake ⇒ <i>page 12</i>
	Cooling system ⇒ <i>page 12</i>
	Engine oil pressure ⇒ <i>page 13</i>
	Alternator ⇒ <i>page 13</i>
	Safety belt ⇒ <i>page 13</i>
	Transmission ⇒ <i>page 71</i>
	Electromechanical steering ✓ ⇒ <i>page 93</i>
	Steering lock ⇒ <i>page 13</i>









#### Yellow indicator lights

	Electronic Stabilization Control (ESC) ✓ ⇒ <i>page 14</i>
	Electronic Stabilization Control (ESC) ✓ ⇒ <i>page 14</i>
<b>ESC OFF</b>	Electronic Stabilization Control (ESC) ⇒ <i>page 89</i>
<b>ABS</b>	<b>USA models:</b> Anti-lock braking system (ABS) ✓ ⇒ <i>page 14</i>
	<b>Canada models:</b> Anti-lock braking system (ABS) ✓ ⇒ <i>page 14</i>
	Safety systems ✓ ⇒ <i>page 14</i>
	Brake pads ⇒ <i>page 14</i>

	Electromechanical parking brake ⇒ page 12
	Tire Pressure Monitoring System* ✓ ⇒ page 183
<b>TPMS</b>	Tire pressure monitoring system* ⇒ page 183
<b>EPC</b>	Electronic power control ✓ ⇒ page 14
	Malfunction Indicator Lamp (MIL) ✓ ⇒ page 14
	Engine speed limitation* ⇒ page 15
	Engine oil level ⇒ page 15
	Engine oil sensor ⇒ page 15
	Battery charge ⇒ page 13
	Tank system ⇒ page 15
	Washer fluid level* ⇒ page 15
	Engine start system ⇒ page 15
	Electromechanical steering ✓ ⇒ page 93
	Steering lock ⇒ page 13
	Remote control key* ⇒ page 63
	Battery in remote control key ⇒ page 23
	Bulb failure indicator ⇒ page 16
	Headlight range control system ⇒ page 16
	Adaptive light* ⇒ page 16
	Light/rain sensor* ⇒ page 16

	Suspension control* ⇒ page 16
	<b>USA models:</b> Speed warning system* ⇒ page 76
	<b>Canada models:</b> Speed warning system* ⇒ page 76

Other indicator lights

	Turn signals ⇒ page 16
	Trailer turn signals* ⇒ page 16
<b>CRUISE</b>	<b>USA models:</b> Cruise control system ⇒ page 76
	<b>Canada models:</b> Cruise control system ⇒ page 76
	Hill descent assist* ⇒ page 91
	Remote control key* ⇒ page 63
	High beams ⇒ page 34
	Door open ⇒ page 17
	Hood open ⇒ page 17
	Luggage compartment lid open ⇒ page 17





**BRAKE / (P) Brake system**

If this indicator light turns on, there is a malfunction in the brake system.

**BRAKE** (USA models) / **(P)** (Canada models) **Stop vehicle and check brake fluid level**

Stop the vehicle and check the brake fluid level. See an authorized Audi dealer or authorized Audi Service Facility for assistance if necessary.

**BRAKE** (USA models) / **(P)** (Canada models) **Brake: malfunction! Please park vehicle safely** ▶

If the ABS indicator light **ABS** (USA models) /  (Canada models), the ESC indicator light , and the brake system indicator light **BRAKE** (USA models) /  (Canada models) all turn on and this message appears, then the ABS, ESC and braking distribution are malfunctioning ⇒ .

Do not continue driving. See an authorized Audi dealer or authorized Audi Service Facility for assistance ⇒ .

**BRAKE** (USA models) /  (Canada models) **Parking brake: System fault! See owner's manual**

- If the indicator light and the message appear **when the vehicle is stationary or after switching the ignition on**, check if you can release the parking brake. If you cannot release the parking brake, see an authorized Audi dealer or authorized Audi Service Facility. If you can release the parking brake and the message still appears, see an authorized Audi dealer or authorized Audi Service Facility immediately to have the malfunction corrected.
- If the indicator light and message appear **while driving**, the hill start assist or emergency braking function may be malfunctioning. It may not be possible to set the parking brake or release it once it has been set. Do not park your vehicle on hills. See an authorized Audi dealer or authorized Audi Service Facility for assistance.

Applies to: USA models

If the **BRAKE** and  indicator lights turn on at the same time, the brake pads are worn out ⇒ *page 14*.

### **WARNING**

- Read and follow the warnings in ⇒ *page 155, Working in the engine compartment* before opening the hood and checking the brake fluid level.
- If the brake system indicator light does not turn off or it turns on while driving, the brake fluid level in the reservoir is too low, and this increases the risk of an accident. Stop the vehicle and do not continue driving. See an authorized Audi dealer or authorized Audi Service Facility for assistance.

– If the brake system indicator light turns on together with the ABS and ESC indicator lights, the ABS/ESC regulating function may be malfunctioning. Functions that stabilize the vehicle are no longer available. This could cause the vehicle to swerve, which increases the risk that the vehicle will slide. Do not continue driving. See an authorized Audi dealer or authorized Audi Service Facility for assistance.

### **PARK / Electromechanical parking brake**

If the **PARK** (USA models) /  (Canada models) indicator light turns on, the parking brake was set.

**PARK** (USA models) /  (Canada models) **Press brake pedal to release parking brake**

To release the parking brake, press the brake pedal and press the  button at the same time or start driving with hill start assist ⇒ *page 65, Starting from a stop*.

 **Parking brake: System fault! See owner's manual.**

There is a malfunction in the parking brake. Drive to an authorized Audi dealer or authorized Audi Service Facility immediately to have the malfunction corrected.

### **Tips**

For additional information on the parking brake, see ⇒ *page 63*.

### **Cooling system**

 **Turn off engine and check coolant level.**

The coolant level is too low.

Do not continue driving and switch the engine off. Check the coolant level ⇒ *page 162*.

- If the coolant level is too low, add coolant ⇒ *page 162*. Only continue driving once the indicator light turns off.

 **Coolant temperature! Let engine run with vehicle stationary.**

Let the engine run at idle for a few minutes to cool off, until the indicator light turns off.

- If the indicator light does not turn off, do not continue driving the vehicle. See an authorized Audi dealer or authorized Audi Service Facility for assistance.

 **WARNING**

- Never open the hood if you can see or hear steam or coolant escaping from the engine compartment. This increases the risk of burns. Wait until you no longer see or hear steam or coolant escaping.
- The engine compartment in any vehicle can be a dangerous area. Stop the engine and allow it to cool before working in the engine compartment. Always follow the information found in ⇒ *page 155, Working in the engine compartment.*

 **Note**

Do not continue driving if the  indicator light turns on as this increases the risk of engine damage.

 **Engine oil pressure**

 **Turn off engine! Oil pressure is too low.**

Stop the engine and do not continue driving. Check the engine oil level ⇒ *page 160.*

- If the engine oil level is too low, add engine oil ⇒ *page 160.* Only continue driving once the indicator light turns off.
- If the engine oil level is correct and the indicator light still turns on, turn the engine off and do not continue driving. See an authorized Audi dealer or authorized Audi Service Facility for assistance.

 **Tips**

The oil pressure warning is not an oil level indicator. Always check the oil level regularly.

 **Generator/vehicle battery**

 **Alternator fault: Battery is not being charged.**

There is a malfunction in the alternator or the vehicle electrical system.

Drive to an authorized Audi dealer or authorized Audi Service Facility immediately. Because the vehicle battery is discharging, turn off all unnecessary electrical equipment such as the radio. See an authorized Audi dealer or authorized Audi Service Facility if the battery charge level is too low.

 **Low battery charge: Battery will be charged while driving.**

The starting ability may be impaired.

If this message turns off after a little while, the vehicle battery charged enough while driving.

If the message does not turn off, have an authorized Audi dealer or authorized Audi Service Facility repair the malfunction.

 **Safety belt**

The  indicator light stays on until the driver's and front passenger's safety belts are buckled. Above a certain speed, there will also be a warning tone.

 **Tips**

For additional information on safety belts, see ⇒ *page 106.*

 **Steering lock**

 **Steering fault! Do not drive vehicle!**

There is a malfunction in the electronic steering lock. You cannot turn the ignition on.

Do **not** tow your vehicle because it cannot be steered. See an authorized Audi dealer or authorized Audi Service Facility for assistance.

 **Steering lock: System fault! Please contact dealer.**

There is a malfunction in the electronic steering lock.

Drive to an authorized Audi dealer or authorized Audi Service Facility immediately to have the malfunction corrected.



### **WARNING**

Do not tow your vehicle when there is a malfunction in the electronic steering lock - this increases the risk of an accident.



### **Electronic Stabilization Control (ESC)**

If the  indicator light blinks while driving, the ESC or ASR (Anti-Slip Regulation) is actively regulating.

If the  indicator light turns on, the system has switched the ESC off. In this case, you can switch the ignition off and then on to switch the ESC on again. The indicator light turns off when the system is functioning fully.

If the  indicator light turns on, ESC was switched off using the  OFF button  
⇒ page 89.

### **Stabilization control (ESC/ABS): Fault! See owner's manual**

If the  indicator light and the ABS indicator light **ABS** (USA models)/ (Canada models) turn on and this message appears, there is a malfunction in the ABS system or electronic differential lock. This also causes the ESC to malfunction. The brakes still function with their normal power, but ABS is not active.

Drive to an authorized Audi dealer or authorized Audi Service Facility immediately to have the malfunction corrected.

### **WARNING**

If the **BRAKE** (USA models) /  (Canada models) brake system indicator light turns on together with the ABS and ESC indicator lights, the ABS and ESC regulating function may have malfunctioned. Functions that stabilize the vehicle are no longer available. This could cause the vehicle to swerve, which increases the risk that the vehicle will slide. Drive carefully to the nearest authorized Audi dealer or authorized Audi Service Facility and have the malfunction corrected.

### **Tips**

For additional information on ESC and ABS, refer to ⇒ page 89.

### **Safety systems**

The  indicator light monitors the safety systems.

If the  indicator light turns on or blinks, there is a malfunction in a safety system.

Drive to an authorized Audi dealer or authorized Audi Service Facility immediately to have the malfunction corrected.

### **WARNING**

Have the malfunction in the safety systems inspected immediately. Otherwise, there is a risk that the systems may not activate during a collision, which increases the risk of serious injury or death.

### **Brake pads**

#### **Brake pads!**

The brake pads are worn.

Drive to an authorized Audi dealer or authorized Audi Service Facility immediately to have the brake pads checked.

Applies to: USA models

The  indicator light turns on together with the **BRAKE** indicator light.

### **EPC Engine control (gasoline engine)**

Applies to: vehicles with gasoline engines

If the **EPC** indicator light turns on while driving, there is an engine control malfunction.

Immediately drive slowly to an authorized Audi dealer or authorized Audi Service Facility to have the malfunction corrected.

### **Malfunction indicator lamp (MIL)**

The malfunction indicator lamp (MIL) is part of the On-Board Diagnostic System (OBD II). The



 symbol turns on when the ignition is switched on and turns off again once the engine is started and running at a steady idle speed. This indicates that the MIL is functioning correctly.

The indicator light turns on if there is a malfunction in the engine electronics. See an authorized Audi dealer or authorized Audi Service Facility to have the malfunction corrected. For additional information, see  $\Rightarrow$  page 17.

The indicator light can also turn on if the fuel filler cap is not closed correctly  $\Rightarrow$  page 153.

### Engine speed limitation

Applies to: vehicles with engine speed limitation

 **Don't exceed max. engine speed of XXXX rpm**

The engine speed is automatically limited to the speed displayed in the driver information system. This protects the engine from overheating.

The engine speed limitation deactivates once the engine is no longer in the critical temperature range and you have released the accelerator pedal once.

If the engine speed limitation was activated by an engine control malfunction, the **EPC** indicator light also turns on. Make sure that the speed does not go above the speed displayed. Drive to an authorized Audi dealer or authorized Audi Service Facility immediately to have the malfunction corrected.

### Engine oil level

 **Check oil level.**

Refill engine oil as soon as possible  $\Rightarrow$  page 158.

### Engine oil sensor

 **Oil level sensor: System fault!**

The sensor to check the engine oil level has failed. Drive to an authorized Audi dealer or authorized Audi Service Facility immediately to have the malfunction corrected.

### Tank system

 **Please refuel**

If the indicator light turns on for the first time and the message appears, there are about 1.8-2.2 gallons (7.0-8.5 liters) of fuel left in the tank.

 **Fuel tank system malfunction! Contact dealer**

Drive to an authorized Audi dealer or authorized Audi Service Facility immediately to have the malfunction corrected.

### Tips

For more information on fueling, see  $\Rightarrow$  page 153.

### Washer fluid level

Applies to: vehicles with washer fluid level indicator

 **Please refill washer fluid.**

Fill the washer fluid with the ignition switched off  $\Rightarrow$  page 165.

### Engine start system

 **Engine start system: Malfunction! Please contact dealer.**

Do **not** switch the ignition off because you may not be able to switch it on again.

Drive to an authorized Audi dealer or authorized Audi Service Facility immediately to have the malfunction corrected.

**Engine start system: Malfunction. Please contact dealer.**

There is a malfunction in the engine starting system.

Drive to an authorized Audi dealer or authorized Audi Service Facility immediately to have the malfunction corrected.

### Bulb failure indicator

If the  indicator light turns on, a bulb has failed. The message indicates the location of the bulb.

Replace the bulb immediately.

#### **Vehicle lights: System fault!**

There is a malfunction in the headlights or the light switch.

Drive to an authorized Audi dealer or authorized Audi Service Facility immediately to have the malfunction corrected.

#### **WARNING**

- Light bulbs are under pressure and can explode when bulbs are replaced, which increases the risk of injury.
- With HID headlights (xenon headlights)\*, the high-voltage component must be handled correctly. Otherwise, there is a risk of fatal injury.

### Headlight range control system

#### Headlight range control System fault!

There is a malfunction in the headlight range control system, which may cause glare for other drivers.

Drive to an authorized Audi dealer or authorized Audi Service Facility immediately to have the malfunction corrected.

### Audi adaptive light

Applies to: vehicles with Audi adaptive light

#### Audi adaptive light: System fault!

There is a malfunction in the adaptive lights. The headlights still function.

Drive to an authorized Audi dealer or authorized Audi Service Facility immediately to have the malfunction corrected.

### Light/rain sensor

Applies to: vehicles with light/rain sensor

#### Automatic headlights/wipers: System fault!

The light/rain sensor is malfunctioning.

The low beams remain switched on at all times for safety reasons when the light switch is in the **AUTO** position. You can continue to turn the lights on and off using the light switch. You can still control all functions that are independent of the rain sensor through the windshield wiper lever.

Drive to an authorized Audi dealer or authorized Audi Service Facility immediately to have the malfunction corrected.

### Suspension control



Applies to: vehicles with Audi drive select and suspension control

#### Suspension: System fault!

There is a suspension control malfunction.

Drive to an authorized Audi dealer or authorized Audi Service Facility immediately to have the malfunction corrected.

### Turn signals

If the  or  indicator light blinks, the turn signals are activated. If both indicator lights are blinking, the emergency flashers are activated.

If an indicator light blinks twice as fast as usual, a turn signal bulb has failed. Carefully drive to an authorized Audi dealer or authorized Audi Service Facility immediately to have the malfunction corrected.



### Trailer turn signals

Applies to: vehicles with trailer hitch

When the  indicator light blinks, then the turn signals are activated in trailer mode. The trailer must have been connected correctly for this  
⇒ *page 73*.

If a turn signal on the trailer or on the vehicle fails while in trailer mode, the indicator light will **not** blink twice as fast to indicate this.

### Door, hood or luggage compartment lid is open

-  - If the indicator light turns on, then one of the doors is not closed.
-  - If the indicator light turns on, then the hood is not closed.
-  - If the indicator light turns on, then the luggage compartment lid is not closed.

## On-Board Diagnostic System (OBD)

### Malfunction indicator lamp (MIL)

The malfunction indicator lamp (MIL)  in the instrument cluster is part of the On-Board Diagnostic System (OBD II).

The warning/indicator light turns on when the ignition is switched on and turns off once the engine is started and is running in idle at a stable speed. This indicates that the MIL is functioning correctly.

**If the light does not turn off after starting the engine** or turns on while driving, this may indicate there is a malfunction in the engine. If the indicator turns on, the catalytic converter may be damaged.

Drive **with reduced engine performance** (avoid high speeds for extended periods of time and/or fast acceleration) and have the malfunction corrected. See an authorized Audi dealer or authorized Audi Service Facility.

**The MIL may also turn on if the fuel filler cap is not closed correctly** ⇒ *page 153*.

### On-Board Diagnostics

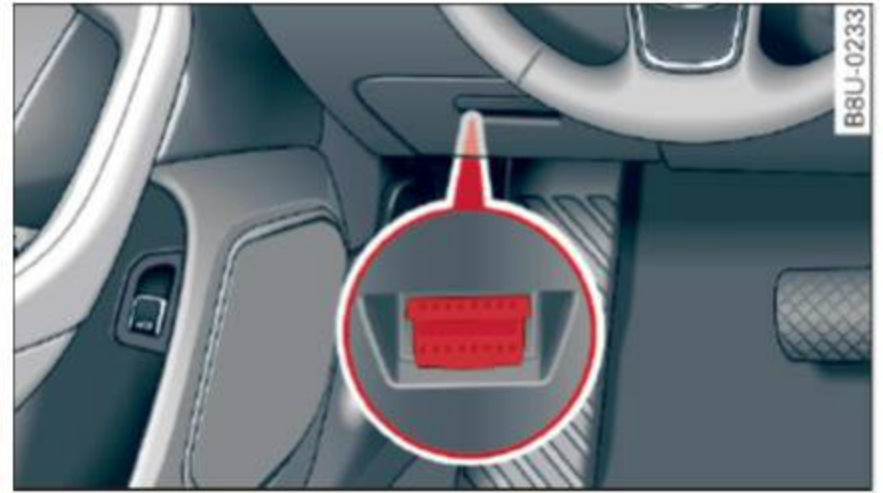

Fig. 5 Location of Data Link Connector (DLC)

On-Board Diagnostics monitors the components of your emission control system. Each monitored component in your engine system has been assigned a code. In case of a malfunction, the component will be identified and the fault stored as a code in the control module memory.

The MIL light may also illuminate if there is a leak in the on-board fuel vapor recovery system. If the light illuminates after a refueling, stop the vehicle and make sure the fuel filler cap is properly closed (only vehicles with gasoline engine) ⇒ *page 153*.

In order to make an accurate diagnosis, the stored data can only be displayed using special diagnostic equipment (generic scan tool for OBD).

In order to connect the special diagnostic equipment, push the plug into the Data Link Connector (DLC). The DLC is located to the right of the hood release ⇒ *fig. 5*.

Your authorized Audi dealer or qualified workshop can interpret the code and perform the necessary repair.

### WARNING

Do not use the diagnostic connector for personal use. Incorrect usage can cause malfunctions, which can increase the risk of a collision!

# Driver information system

## Overview

Applies to: vehicles with driver information system



Fig. 6 Display on vehicles with driver information system and multifunction steering wheel\*

Driving information and vehicle settings are shown in the instrument cluster display. The type of display and the contents depend on the vehicle equipment.

Depending on the vehicle equipment, the driver information system is controlled with either the buttons on the windshield wiper lever\* ⇒ page 18 or with the buttons on the multifunction steering wheel\* ⇒ page 18.

On vehicles with a multifunction steering wheel\*, the information (B) is shown in tabs (A). The tabs are visible as soon as you press a button on the multifunction steering wheel\*.

The instrument cluster display provides information about:

(B)	Time and date ⇒ page 9
	Digital speedometer
	On-board computer ⇒ page 19
	Efficiency program ⇒ page 20
	Reduced display*
	Indicator lights and messages ⇒ page 10
	Service interval display ⇒ page 165
	Cruise control system*
	Parking aid*
	Audio*
	Telephone*
	Navigation*

(C)	Odometer and trip odometer (only in the first tab*) ⇒ page 9
(D)	Outside temperature ⇒ page 9, selector lever position

### i Tips

- You can set the units used for temperature, speed and other measurements in the Infotainment system.
- For information on the audio and navigation\* functions, refer to the separate Infotainment system owner's manual.

## Operation

### Operating using the windshield wiper lever

Applies to: vehicles with driver information system without multifunction steering wheel

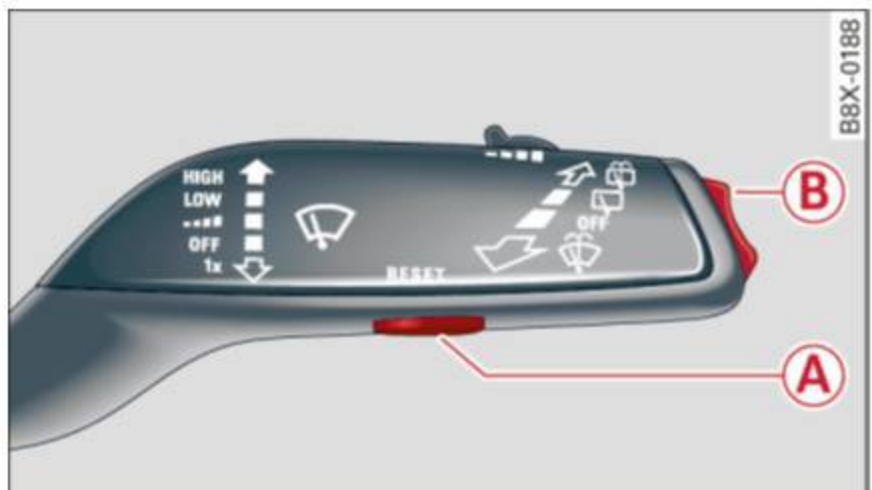

Fig. 7 Windshield wiper lever: operating the driver information system

### Operating

- ▶ Switch the ignition on. The last select function is displayed.
- ▶ To switch between the on-board computer 1, 2, the efficiency program or, for example, the cruise control system\*, press the **RESET** button (A).
- ▶ To access additional information below or above, press the button (B) down or up.

### Recalling indicator lights and messages

- ▶ Press the **RESET** button (A).

### Resetting values to zero

- ▶ Select a value in the desired trip computer or in the efficiency program.

- ▶ Press and hold the **RESET** button **A** for at least one second. All values in the selected on-board computer or in the efficiency program are reset to zero.

### Operating using the multifunction steering wheel

Applies to: vehicles with driver information system and multifunction steering wheel

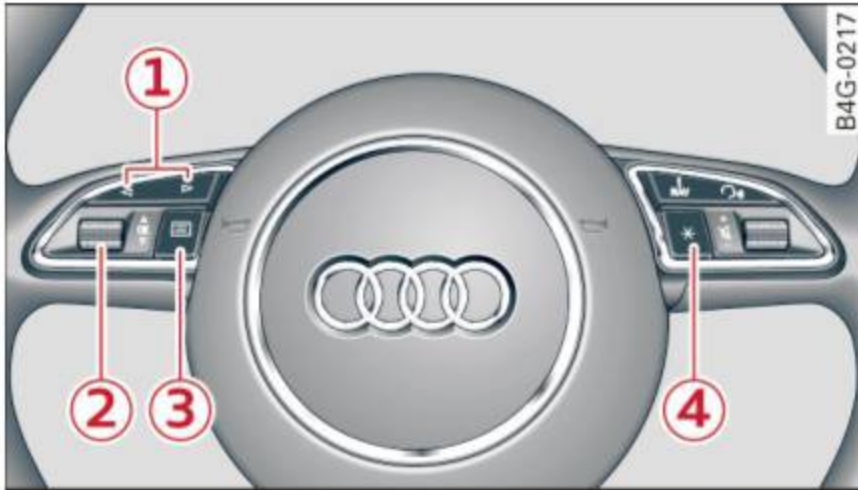

Fig. 8 Multifunction steering wheel: operating the driver information system

The tab **A** ⇒ page 18, fig. 6 appears once you press a button on the multifunction steering wheel.

### Operating

- ▶ Switch the ignition on. The last select function is displayed.
- ▶ To switch between the tabs, press the rocker button **1** to the left or right ⇒ fig. 8.
- ▶ To access additional information below or above, rotate the thumbwheel **2** down or up.
- ▶ To confirm a selection, press the thumbwheel **2**.

### Opening Car functions

- ▶ Select the first tab with the button **1**.
- ▶ Press the button **3**. The **Car functions** menu is displayed.
- ▶ To select a menu item, turn and press the thumbwheel **2**.
- ▶ To select a function programmed to a steering wheel button, press the button **4**.

### Resetting values to zero

- ▶ In the **Car functions** menu, select **On-board computer** or **Efficiency program**.

- ▶ Select a value in the desired trip computer or in the efficiency program.
- ▶ To reset the values in a memory, press and hold the thumbwheel **2** for one second.

### Assigning a function to a programmable steering wheel button

- ▶ Select the **CAR** button > **(Car) Systems\*** control button > **Vehicle settings** > **Steering wheel button**.

### Recalling indicator lights and messages

- ▶ Select the **!** tab.

The **!** tab is only visible when there is at least one indicator light or message displayed. Other folders are only visible if the applicable system is switched on.

### On-board computer

Applies to: vehicles with on-board computer



Fig. 9 Display: on-board computer memory level 1

### Operating with the windshield wiper lever\*

- ▶ Press the **RESET** button **A** ⇒ page 18, fig. 7 repeatedly until the on-board computer appears in the display.
- ▶ To access additional content, press the button **B**.

### Operating with the multifunction steering wheel\*

- ▶ Open **Car functions** and select the **On-board computer** menu item ⇒ page 19.
- ▶ To access additional content, turn the thumbwheel **2** ⇒ page 19, fig. 8.

You can identify which on-board computer is currently being shown in the display based on the small **1** or **2**.

The on-board computer **1** ⇒ *fig. 9* is a short-term memory. It collects driving information from the time the ignition is switched on until it is switched off. If you continue driving within two hours after switching the ignition off, the new values are included when calculating the current trip information.

Unlike the short-term memory, the long-term memory (on-board computer **2**) is not erased automatically. You can select the time period for evaluating trip information yourself.

You can call up the following information consecutively in on-board computer **1** or **2**:

- Date
- Range
- Travel time
- Average consumption
- Average speed
- Distance
- Current fuel consumption

### **i** Tips

Information on the efficiency program  
⇒ *page 20*.

## Efficiency program

### Overview

Applies to: vehicles with efficiency program



Fig. 10 Instrument cluster: efficiency program

### Operating with the windshield wiper lever\*

- ▶ Press the **RESET** button **A** ⇒ *page 18, fig. 7* repeatedly until the efficiency program appears in the display.

### Operating with the multifunction steering wheel\*

- ▶ Open car functions and select the **Efficiency program** menu item ⇒ *page 19*.

The efficiency program can help you to use less fuel. It evaluates driving information in reference to fuel consumption and shows other equipment influencing consumption ⇒ *page 20*. Fuel economy messages ⇒ *page 21* provide tips for efficient driving.

The efficiency program receives data about the distance and fuel consumption from the on-board computer 1. If the data in the efficiency program is deleted ⇒ *page 18*/⇒ *page 19*, the values in the on-board computer 1 are also reset.

### Other equipment

Applies to: vehicles with efficiency program

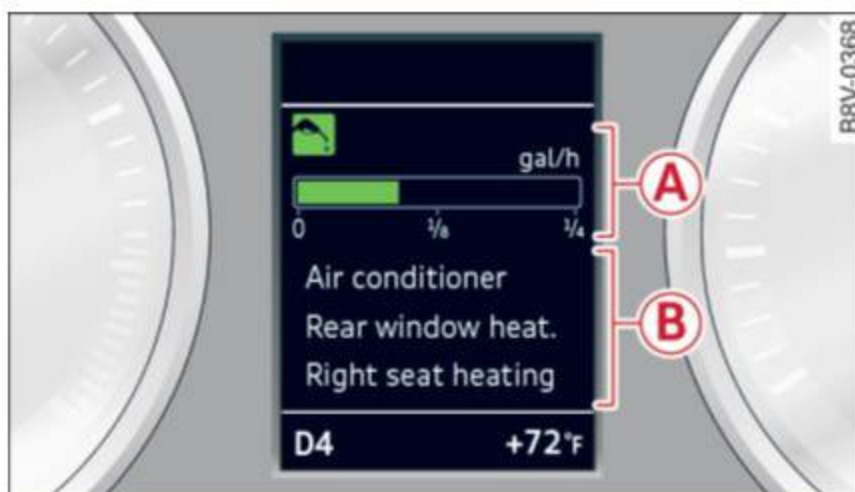



Fig. 11 Instrument cluster: energy consumers

Requirement: the efficiency program  must be open ⇒ *page 20*.

- ▶ Operating with the windshield wiper lever\*: press the button **B** ⇒ *page 18, fig. 7* repeatedly, until the other equipment affecting consumption appears in the instrument cluster display ⇒ *fig. 11*.
- ▶ Operating with the multifunction steering wheel\*: keep turning the thumbwheel **2** ⇒ *page 19, fig. 8* until the other equipment affecting consumption appears in the display. ▶

Other equipment that is currently affecting fuel consumption is listed in the efficiency program. The display shows up to three other items of equipment **(B)**. The equipment using the most power is listed first. If more than three items using power are switched on, the equipment that is currently using the most power is displayed.

A gauge **(A)** also shows the current total consumption of all other consumers.

### Fuel economy messages

Applies to: vehicles with efficiency program



Fig. 12 Instrument cluster: example of economy tip

Fuel economy messages are displayed when fuel consumption is increased by certain conditions. If you follow these economy tips, you can reduce your vehicle's fuel consumption. The messages appear automatically and are only displayed in the efficiency program. The fuel economy messages turn off automatically after a certain period of time.

- ▶ To turn an economy tip off immediately after it appears, press any button on the windshield wiper lever\*/multifunction steering wheel\*.

#### **i** Tips

- Once you have turned an economy tip off, it will only appear again after you turn the ignition on again.
- The economy tips are not displayed in every instance, but rather in intervals over a period of time.

# Opening and closing

## Central locking

### Description

You can lock and unlock the vehicle centrally. You have the following options:

- Remote control key ⇒ *page 24*,
- Sensors in the door handles\* ⇒ *page 24*,
- Inner central locking switch ⇒ *page 25*, or
- Lock cylinder on the driver's door ⇒ *page 26*.

### Turn signals

The turn signals flash twice when you unlock the vehicle and flash once when you lock the vehicle.

If they do not flash, then the ignition may still be switched on, or one of the doors or the luggage compartment lid may be open, for example.

### Automatic locking (Auto Lock)

The Auto Lock function locks all doors and the luggage compartment lid once the speed has exceeded approximately 9 mph (15 km/h).

The vehicle will unlock again if the ignition key\* is removed, the opening function from the central locking switch is activated, or one of the door handles is operated.

In the event of a crash with airbag deployment, the doors will also automatically unlock to allow access to the vehicle.

### Selective door unlocking

The doors and luggage compartment lid will lock when they close. You can set in the Infotainment system if *only* the driver's door or the entire vehicle should unlock when unlocking ⇒ *page 26*, *Setting the central locking system*.

### Unintentionally locking yourself out

Only lock your vehicle when all of the doors and the luggage compartment lid are closed and the remote control key is not in the vehicle. This helps to prevent you from locking yourself out accidentally.

The following conditions prevent you from locking your remote control key in the vehicle:

- If the driver's door is open, the vehicle cannot be locked by pressing the  button on the remote control key or by touching the locking sensor\* on a door.
- If the most recently used convenience key\* is in the luggage compartment, the luggage compartment lid automatically unlocks again after closing it ⇒ *page 27*. The emergency flashers blink four times.
- If the convenience key\* that was last used is detected inside the vehicle, then the vehicle will not be able to lock from the outside.

### WARNING

- Always take the key with you when leaving your vehicle, even if for a short period of time. This applies particularly when children remain in the vehicle. Otherwise, children could start the engine or operate electrical equipment (such as power windows), which increases the risk of an accident.
- No one, especially children, should stay in the vehicle when it is locked from the outside, because the windows can no longer be opened from the inside ⇒ *page 27*. Locked doors make it more difficult for emergency workers to get into the vehicle, which puts lives at risk.

### WARNING

Applies to: vehicles with ignition lock

Do not remove the key from the ignition lock until the vehicle has come to a complete stop. Otherwise, the steering lock could engage suddenly and increase the risk of an accident.

### Tips

- Do not leave valuables unattended in the vehicle. A locked vehicle is not a safe!
- The LED in the driver's door rail blinks when you lock the vehicle. If the LED lights up for approximately 30 seconds after locking, there is a malfunction in the central locking system. Have the problem corrected by an authorized Audi dealer or authorized Audi Service Facility.



## Key set

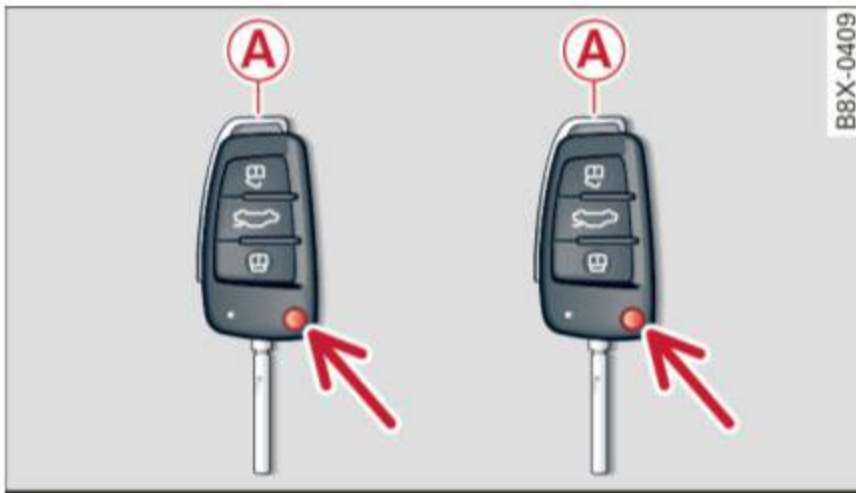

Fig. 13 Your vehicle key set

### A Remote control key or convenience key\*

The convenience key is a remote control key with special functions ⇒ *page 24* and ⇒ *page 61*. With the remote control key, you can lock and unlock the vehicle and start the engine. To fold the key out and back in place, press the release button ⇒ *fig. 13 -arrow-*.

### Replacing a key

If a key is lost, see an authorized Audi dealer or authorized Audi Service Facility. Have *this* key deactivated. It is important to bring all keys with you. If a key is lost, you should report it to your insurance company.

### Number of keys

You can check the number of keys assigned to your vehicle in the instrument cluster display. It will show you this when you adjust the time ⇒ *page 9*. For example, the display **1/2** means you are using vehicle key number one out of two keys total assigned to the vehicle. This way, you can make sure that you have all the keys when purchasing a used vehicle.

### Electronic immobilizer

The immobilizer prevents unauthorized use of the vehicle.

Under certain circumstances, the vehicle may not be able to start if there is a key from a different vehicle manufacturer on the key chain.

### i Tips

- The operation of the remote control key can be temporarily disrupted by interference

from transmitters near the vehicle working in the same frequency range (such as a cell phone or radio equipment). Always check if your vehicle is locked!

- For an explanation on conformity with the FCC regulations in the United States and the Industry Canada regulations, see ⇒ *page 215*.

### LED and batteries in the remote control key



Fig. 14 Remote control key: opening the cover

### LED in the remote control key

The LED informs you of the remote control key function.

- ▶ If you press a button briefly, the LED blinks once.
- ▶ If the LED does not blink, the remote control key battery is dead. The message  **Please change key battery** may also appear in the instrument cluster display. Replace the battery in the remote control key.

### Replacing the remote control key battery

- ▶ Pry the cover ② off of the key ① using a coin ⇒ *fig. 14*.
- ▶ Remove the cover in the direction of the arrow.
- ▶ Insert the new battery with the “+” symbol facing up.
- ▶ Press the cover back onto the key until it clicks into place.



### For the sake of the environment



Discharged batteries must be disposed of using methods that will not harm the environment. Do not dispose of them in household trash.

### **i** Tips

The replacement battery must meet the same specifications as the original battery in the remote control key.

### Remote control key synchronization





If the vehicle cannot be unlocked/locked by the remote control, you can synchronize the remote control key.

- ▶ Press the remote control key button .
- ▶ Insert the key in the driver's door lock within 30 seconds.
- ▶ Press the  button or  button.

### Unlocking/locking by remote control



Fig. 15 Remote control key: button programming

- ▶ To unlock the vehicle, press the  button **1** ⇒ *fig. 15*.
- ▶ To lock the vehicle, press the  button **2** ⇒  **once**.
- ▶ To unlock the luggage compartment lid, press the  button **3** briefly.
- ▶ To open\* the luggage compartment lid, press and hold the  button **3** for at least one second.
- ▶ To trigger the alarm, press the **PANIC** button **4**. The vehicle horn and emergency flashers are activated.
- ▶ To turn off the alarm, press the **PANIC** button **4** again.

If the vehicle is unlocked and a door or the luggage compartment lid are not opened within 30 seconds, the vehicle locks again automatically. This feature prevents the vehicle from being accidentally left unlocked over a long period of time.

This does not apply if you press and hold the  button **3** for at least one second.

You can set in the Infotainment system if *only* the driver's door or the entire vehicle should unlock when unlocking ⇒ *page 26*.

### **WARNING**

Read and following all warnings ⇒  in *Description on page 22*.

### **i** Tips

- Only use the remote control key when you are within view of the vehicle.
- The vehicle can only be locked when the selector lever is in the P position.
- Do not use the remote control when you are inside the vehicle. Otherwise, you could unintentionally lock the vehicle. If you then tried to start the engine or open a door, the alarm would be triggered. If this happens, press the  unlock button.
- Only use the panic function in an emergency.

### Unlocking/locking with the convenience key

Applies to: vehicles with convenience key

*The doors and luggage compartment lid can be unlocked/locked without using the remote control key.*

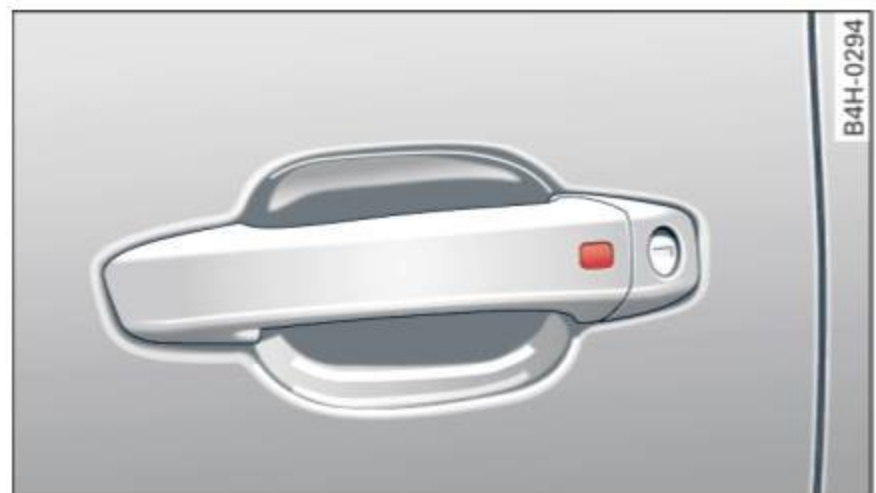



Fig. 16 Door handle: unlocking/locking sensor

### Unlocking the vehicle

- ▶ To unlock the driver's or front passenger's door, grab the door handle of the respective door. The door unlocks automatically.
- ▶ To open the door, pull the door handle. ▶

- ▶ To open the luggage compartment lid, press the grip piece in the luggage compartment lid ⇒ *page 27*.

### Locking the vehicle

- ▶ Place the selector lever in the P position, or else the vehicle will not be able to lock.
- ▶ To lock the vehicle, close the door and touch the sensor on the door handle **once** ⇒ *fig. 16*, ⇒ . Do not hold the door handle while doing this.

Unlocking and locking the vehicle can only be done at the front doors. The remote control key cannot be more than approximately 4 ft (1.5 m) away from the door handle. It makes no difference whether the remote control key is in your jacket pocket, purse or briefcase.

The door cannot be opened for a brief period directly after locking it. This way you have the opportunity to check if the doors locked correctly.

You can set in the Infotainment system if *only* the driver's door or the entire vehicle should unlock when unlocking ⇒ *page 26*.

### WARNING

Read and following all warnings ⇒  in Description on *page 22*.

### Tips

If your vehicle is left standing for a long period of time, note the following:

- The proximity sensor switches off after a few days to save energy. You then have to pull once on the door handle to unlock the vehicle and a second time to open it.
- The energy management system gradually turns off unnecessary convenience functions to prevent the vehicle battery from draining and to maintain the vehicle's ability to start for as long as possible. You then may no longer be able to unlock your vehicle with this convenience function.



### Central locking switch



Fig. 17 Driver's door: central locking switch



Fig. 18 Rear center console: central locking switch



- ▶ To lock the vehicle, press the  button ⇒ .
- ▶ To unlock the vehicle, press the .

You can **lock** and **unlock** your vehicle using the central locking switch in the driver's or front passenger's door ⇒ *fig. 17*. You can only **lock** your vehicle using the central locking switch on the center console ⇒ *fig. 18*.

When locking the vehicle with the central locking switch, the following applies:

- Opening the door and the luggage compartment lid from the *outside* is not possible (for security reasons, such as when stopped at a light).
- The LED in the central locking switch turns on when all doors are closed and locked.
- Front doors: you can open the doors individually from the inside by pulling the door handle.
- Rear doors: to unlock the doors, pull on the door handle *one time*. To open the doors, pull on the door handle *again*.
- In the event of a crash with airbag deployment, the doors unlock automatically to allow access to the vehicle.

### WARNING

- Read and following all warnings ⇒  in Description on page 22.
- The central locking switch also works when the ignition is switched off and automatically locks the entire vehicle when the  button is pressed.
- The central locking switch is inoperative when the vehicle is locked from the outside.
- Locked doors make it more difficult for emergency workers to get into the vehicle, which puts lives at risk. Do not leave anyone behind in the vehicle, especially children.

### Tips

- Your vehicle locks automatically when it reaches a speed of 9 mph (15 km/h) (Auto Lock) ⇒ page 22. You can unlock the vehicle again using the  button in the central locking switch.
- The doors cannot be unlocked with the central locking switch on the rear center console.

## Setting the central locking system

In the Infotainment system, you can set which doors the central locking system will unlock.

- ▶ Select: the  function button > **(Car) Systems\*** control button > **Vehicle settings** > **(Central locking)\***.

**Unlock doors** – you can decide if **All** doors or only the **Driver** door should unlock. The luggage compartment lid also unlocks when **All** is selected. If you select **Driver** in a vehicle with a convenience key\*, only the door whose handle you pull will unlock.

When the **Driver** setting is selected, all doors and the luggage compartment lid will unlock when you press the  button on the remote control key twice or turn the key in the door lock cylinder in the opening direction twice.

**Tone when locking** – if you select **On**, a tone will sound when you lock the vehicle.

## Emergency unlocking/locking doors

If the central locking fails, you must unlock/lock the doors separately.

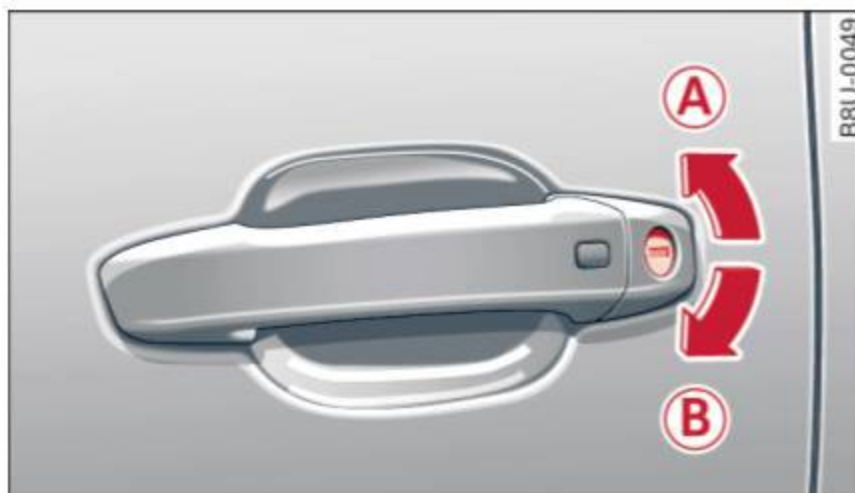





Fig. 19 Driver's door: door lock cylinder



Fig. 20 Front passenger's door/rear doors: emergency lock

## Unlocking/locking the driver's door

- ▶ To unlock the driver's door, turn the key to the open position  ⇒ fig. 19.
- ▶ To lock the driver's door, put the selector lever in the P position and turn the key **once** to the closing position  ⇒ .

## Locking the front passenger's door/rear doors

The emergency lock is located on the rear side of the front passenger's door and the rear doors. It is only visible when the door is open.

- ▶ Remove the cap from the opening ⇒ fig. 20.
- ▶ Insert the key into the slot on the inside and turn it all the way to the right (right door) or left (left door).

Once the front passenger's door/rear doors close, it is no longer possible to open them from the outside. The door can be opened from the inside by pulling the door handle. If the child safety lock is switched on for one of the rear doors, the ▶

door can be opened from the outside after pulling the door handle once from the inside.

### WARNING

Read and following all warnings ⇒  in Description on page 22.

## Anti-theft alarm system

If the anti-theft alarm system detects a vehicle break-in, audio and visual warning signals are triggered. The anti-theft alarm system is activated when the vehicle is locked as usual. It switches off when the vehicle is unlocked.

If the alarm is triggered, it will shut off automatically after a certain amount of time. Switch the ignition on or press the  button on the remote control key to turn off the alarm.

## Luggage compartment lid

### Opening/closing the luggage compartment lid





Fig. 21 Rear lid: handle



Fig. 22 Driver's door: opening the luggage compartment lid

Applies to: vehicles with automatic transmission: the luggage compartment lid can only open when the selector lever is in P.

### Opening the luggage compartment lid

- ▶ Briefly press the  button on the remote control key. The rear lid will unlock.
- ▶ To open the luggage compartment lid, press the  button on the remote control key for at least one second.
- ▶ Briefly pull the  button in the driver's door ⇒ *fig. 22*, or
- ▶ Press the handle in the luggage compartment lid.
- ▶ On vehicles with a convenience key\*, you can press the grip in the luggage compartment lid. The luggage compartment lid is unlocked if an authorized remote control key is detected near the vehicle.

### Closing the luggage compartment lid

- ▶ Use the inside grip to pull the luggage compartment lid down and allow it to close using a gentle push ⇒ .

### WARNING

- After closing the luggage compartment lid, make sure that it is latched. Otherwise, the luggage compartment lid could open suddenly when driving, which increases the risk of an accident.
- Never drive with the luggage compartment lid ajar or open, because poisonous gases can enter the vehicle interior and create the risk of asphyxiation.
- Never leave your vehicle unattended when the luggage compartment lid is open. A child could climb into the vehicle through the luggage compartment. If the luggage compartment lid was then closed, the child would be trapped in the vehicle and unable to escape. To reduce the risk of injury, do not allow children to play in or around the vehicle. Always keep the luggage compartment lid and the doors closed when the vehicle is not in use.

- Always make sure no one is in the luggage compartment lid's range of motion when it is closing, especially near the hinges. Fingers or hands could be pinched.

### **i** Tips

When the vehicle is locked, the luggage compartment lid can be unlocked separately by pressing the  button on the remote control key. The luggage compartment lid locks automatically when it is closed again.

### Automatic luggage compartment lid

Applies to: vehicles with automatic luggage compartment lid

*The luggage compartment lid can be opened and closed electrically.*



**Fig. 23** Driver's door: opening/closing the luggage compartment lid

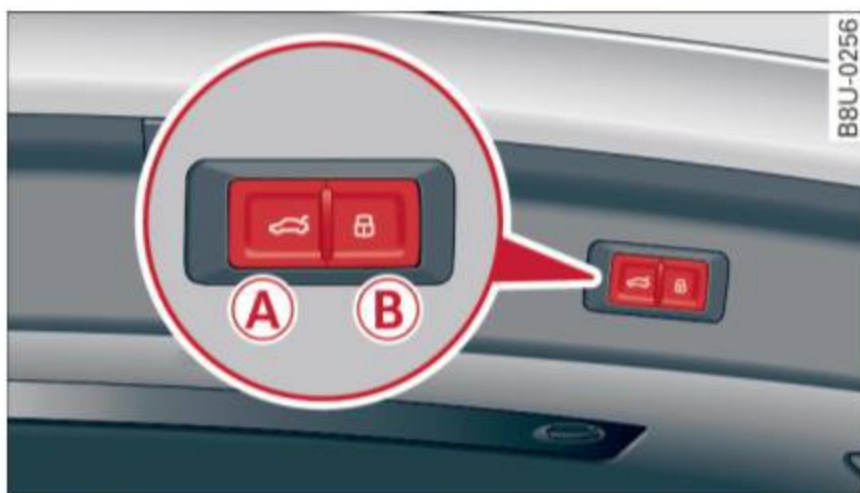



**Fig. 24** Luggage compartment lid: (A) closing button, (B) lock button (vehicles with convenience key\*)









### Opening the luggage compartment lid

- ▶ To unlock the luggage compartment lid, press the  button on the remote control key briefly. Or
- ▶ To unlock the luggage compartment lid, press the handle in the lid (vehicles with convenience key\*). The luggage compartment lid is unlocked







if an authorized remote control key is detected near the vehicle. Or

- ▶ Pull the  switch in the driver's door briefly  $\Rightarrow$  *fig. 23*. Or
- ▶ Press the  button on the remote control key for at least several seconds to open the luggage compartment lid. Or
- ▶ Press the handle in the luggage compartment lid.

### Closing the luggage compartment lid



- ▶ Pull the  button in the driver's door until the luggage compartment lid is closed  $\Rightarrow$  . Or
- ▶ Press the  button in the luggage compartment lid  $\Rightarrow$  *fig. 24*. The luggage compartment lid will automatically lower and close  $\Rightarrow$  . Or
- ▶ Press and hold the  button on the remote control key until the luggage compartment lid begins to close (vehicles with convenience key\*)  $\Rightarrow$  . Make sure there is enough distance between you and the luggage compartment lid. There should be a maximum 4 ft (1.5 m) of distance. Or
- ▶ Press the  button  $\Rightarrow$  *fig. 24* in the luggage compartment lid (vehicles with convenience key\*)  $\Rightarrow$  . The remote control key must not be more than approximately 4 ft (1.5 m) away from the luggage compartment and it must not be inside the vehicle. The luggage compartment lid will automatically lower and close. The vehicle locks.

### Interrupting the opening/closing process

- ▶ Pull/release the  button in the driver's door. Or
- ▶ Press/release the  button on the remote control key (vehicles with convenience key\*). Or
- ▶ Press the  or  button (vehicles with convenience key\*) in the luggage compartment lid. Or
- ▶ Press the handle in the luggage compartment lid. Or
- ▶ Press the luggage compartment lid in the opposite of the direction it is moving.
- ▶ To open/close the luggage compartment lid after the process has been stopped, press the handle or one of the  or  buttons (vehicles with convenience key\*).

If there is difficulty in moving or obstacles that block the operation, the process will stop.

### Storing the open position

- ▶ Bring the luggage compartment lid into the desired open position. The position must be at a certain height or higher to store.
- ▶ Press and hold the  button for at least four seconds to store the new open position. A visual and audio signal will follow.
- ▶ To set a higher open position, wait at least five seconds and then carefully press the luggage compartment lid upward.
- ▶ Press and hold the  button again for at least four seconds to store the new open position.

### WARNING

- Pay careful attention when closing the luggage compartment lid. Otherwise, you could cause serious injury to yourself or others despite the pinch protection.
- To reduce the risk of pinching injuries, always make sure that no one is in the operating area of the luggage compartment lid, including the hinge areas and the upper and lower edge of the luggage compartment lid.
- Never drive with the luggage compartment lid ajar or open, because poisonous gases can enter the vehicle interior and create the risk of asphyxiation.
- Never leave your vehicle unattended when the luggage compartment lid is open. A child could crawl into the luggage compartment. If the luggage compartment lid was then closed, the child would be trapped in the vehicle and unable to escape. To reduce the risk of injury, do not allow children to play in or around the vehicle. Always keep the luggage compartment lid and the doors closed when the vehicle is not in use.
- If there is a luggage rack (such as a bicycle rack) on the luggage compartment lid, the luggage compartment lid may not open completely under certain circumstances or it could close by itself if open due to the extra weight. Therefore, the open luggage compartment lid must be given additional sup-

port or the cargo must first be removed from the luggage rack.

### Tips

- The luggage compartment lid can be operated manually if the vehicle battery is low. It is necessary to use more force when doing this. Move the lid slowly to reduce the amount of force needed.
- When the vehicle is locked, the luggage compartment lid can be unlocked separately by pressing the  button on the remote control key. The luggage compartment lid locks automatically when it is closed again.

### Emergency unlocking the luggage compartment lid

*The luggage compartment lid can be released from inside the luggage compartment in an emergency.*



Fig. 25 Luggage compartment lid emergency release

- ▶ Pry the cover off using the key.
- ▶ Press the lever with the key in the direction of the arrow to release the luggage compartment lid.

## Child safety lock

The child safety lock prevents the rear doors from being opened from the inside and the rear power windows from being operated.

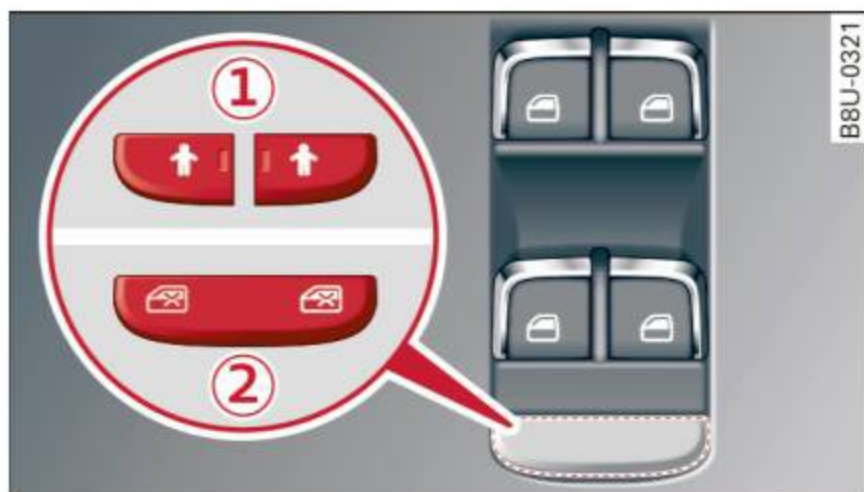



Fig. 26 Section of driver's door: controls



Fig. 27 Rear door: child safety lock

### Vehicles with button

- ▶ To activate/deactivate the inner door handle and the power window switch for the respective rear door, press the left/right  button in the driver's door ① ⇒ fig. 26. The indicator light in the button turns on/blinks.
- ▶ To activate/deactivate the child safety lock on both sides, you must press the  buttons one after the other.

### Vehicles with button

- ▶ To deactivate/activate the power window switch in the rear doors, press the  button in the driver's door ② ⇒ fig. 26. The indicator light in the button turns on/blinks.
- ▶ To also deactivate/activate the inner door handle, open the respective rear door and turn the key switch with the vehicle key in the direction of the arrow or the opposite direction of the arrow ⇒ fig. 27.

### WARNING

Always take the key with you when leaving your vehicle, even if for a short period of time. This applies particularly when children remain in the vehicle. Otherwise children could start the engine or operate electrical equipment (such as power windows), which increases the risk of an accident.

## Power windows

### Controls

The driver can control all power windows.

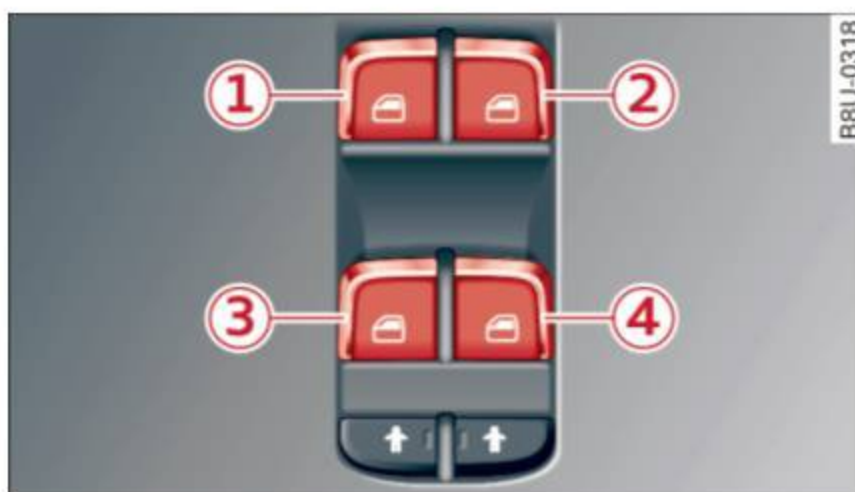

Fig. 28 Section of driver's door: controls

All power window switches are equipped with a two-stage function:

### Opening and closing the windows

- ▶ To open or close the window completely, press the switch down or pull the switch up briefly to the second level. The operation will stop if the switch is pressed/pulled again.
- ▶ To select a position in between opened and closed, press/pull the switch to the first level until the desired window position is reached.

### Power window switches

- ① Left front door
- ② Right front door
- ③ Left rear door
- ④ Right rear door

### WARNING

– Always take the key with you when leaving your vehicle, even if for a short period of time. This applies particularly when children



remain in the vehicle. Otherwise, children could start the engine or operate electrical equipment (such as power windows), which increases the risk of an accident.

- Pay careful attention when closing the windows. Pinching could cause serious injuries.
- When locking the vehicle from outside, the vehicle must be unoccupied since the windows can no longer be opened in an emergency.

### **i** Tips

After switching the ignition off, you can still open and close the windows for approximately 10 minutes. The power windows do not switch off until the driver's door or front passenger's door has been opened.

### Convenience opening/closing

All of the windows and the panorama glass roof can be opened/closed at the same time.

#### Convenience opening feature

- ▶ Hold the key in the open position in the driver's door lock until all of the windows are in the desired position and the panorama glass roof is tilted open.

#### Convenience closing feature

- ▶ Hold the key in the lock position in the driver's door lock until all the windows and the panorama glass roof are closed.

When the panorama glass roof is opened/closed, the electric sunshade also opens/closes.

### **!** WARNING

Never close the windows or panorama glass roof carelessly or in an uncontrolled manner, because this increases the risk of injury.

### Correcting power window malfunctions

You can reactivate the one-touch up/down function if it malfunctions.

- ▶ Pull the power window switch up until the window is completely raised.

- ▶ Release the switch and pull it up again for at least one second.
- ▶ Press the power window switch until the window is completely lowered.
- ▶ Release the switch and press it again for at least one second. Now you can close the window as usual.

## Panorama glass roof

### Description

Applies to: vehicles with panorama glass roof

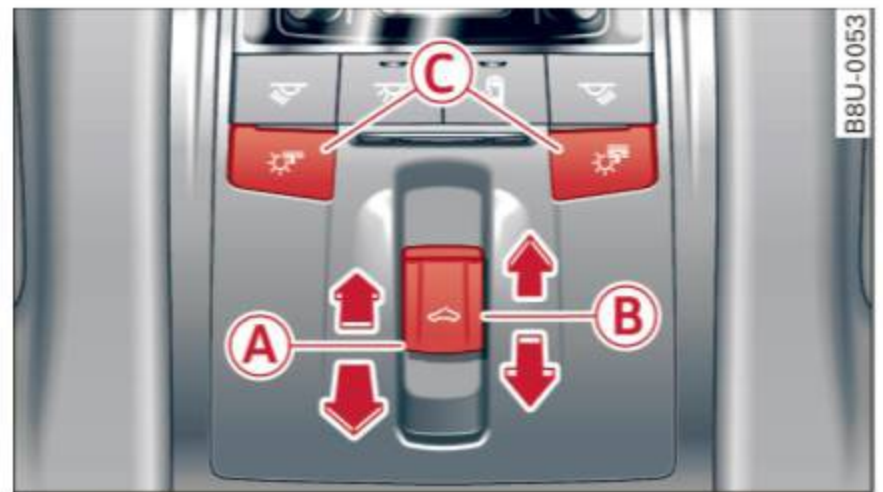

Fig. 29 Front headliner: panorama glass roof buttons

#### **A** Tilting the roof

- ▶ To tilt the sunroof completely open, press the ☁ button up briefly to the second level.
- ▶ To close the sunroof completely, pull the ☁ button down briefly to the second level ⇒ **!**.
- ▶ To set a position between opened and closed, press/pull the ☁ button up to the first level until the roof reaches the desired position.

#### **B** Sliding the roof

- ▶ To open the sunroof completely, push the ☁ button back briefly to the second level.
- ▶ To close the sunroof completely, push the ☁ button forward briefly to the second level ⇒ **!**.
- ▶ To select a partially open position, push the ☁ button forward/back to the first level until the desired position is reached.

#### **C** Opening and closing the sunshade

- ▶ To completely open the sunshade, briefly press the right button.
- ▶ To completely close the sunshade, briefly press the left button.

- ▶ To stop the sunshade, press the corresponding button again.

You can still operate the panorama glass roof for about 10 minutes after the ignition is switched off. The switch is deactivated once the driver's or front passenger's door is opened.

### **WARNING**

To reduce the risk of injury, always pay attention when closing the panorama glass roof. Always take the ignition key with you when leaving the vehicle.

### **Note**

Always close the panorama glass roof when leaving your vehicle. Rain can cause damage to the interior equipment of your vehicle, particularly the electronic equipment.

### **Tips**

- For information about convenience opening/closing, see ⇨ *page 31*.
- The panorama glass roof will only open down to -4°F (-20°).

## **Emergency closing the panorama glass roof**

Applies to: vehicles with panorama glass roof

If an object is detected when closing, the panorama glass roof will open again automatically. In this case, you can then close it with the power emergency closing function.

- ▶ Pull the respective button ⇨ *page 31, fig. 29* within five seconds after the roof opens automatically and hold until the panorama glass roof\* is closed.

If you release the switch early, the panorama glass roof will open again.

# Lights and Vision

## Exterior lighting

### Switching lights on and off



Fig. 30 Instrument panel: light switch

### Light switch ☀

Turn the switch to the corresponding position. When the lights are switched on, the ☀ symbol turns on.

0 - lights off. On some market-specific versions, the daytime running lights\* will switch on when the ignition is switched on in this position.

- **USA models:** the daytime running lights switch on automatically when the ignition is switched on and the light switch is in the **0** position or in the **AUTO** position (only in daylight). The **Daytime running lights** can be switched on and off in the radio or the MMI\* ⇒ page 34, ⇒ ⚠.
- **Canada models:** the daytime running lights switch on automatically when the ignition is switched on and the light switch is set to the **0** position, ☀ or the **AUTO** position (only in daylight) ⇒ ⚠.

AUTO\* - automatic headlights switch on and off depending on brightness, for example in twilight, during rain or in tunnels.

☀ - Parking lights

☞ - Low beam headlights

☞☞ - All weather lights. Turn the switch to parking light ☀ or low beam headlight ☞. Pull the switch up to the first notch ①.

☞☞☞ - Rear fog lights. Turn the switch to parking light ☀ or low beam headlight ☞. Pull the switch up to the second notch ②.

### All-weather lights

The front lights are adjusted automatically so that there is less glare for the driver from his or her own lights, for example when roads are wet.

### Automatic dynamic headlight range control

Your vehicle is equipped with a headlight range control system so that there is less glare for on-coming traffic if the vehicle load changes. The headlight range also adjusts automatically when braking and accelerating.

### Static cornering light\*

The static cornering light may be available depending on vehicle equipment and it only works when the light switch is in the AUTO position. The cornering light switches on automatically at speeds up to approximately 44 mph (70 km) when the steering wheel is at a certain angle. The area to the side of the vehicle is illuminated better when turning.

### ⚠ WARNING

- Automatic headlights\* are only intended to assist the driver. They do not relieve the driver of responsibility to check the headlights and to turn them on manually based on the current light and visibility conditions. For example, fog cannot be detected by the light sensors. So always switch on the low beams under these weather conditions and when driving in the dark ☞.
- The rear fog lights should only be turned on in accordance with traffic regulations, to prevent glare for traffic behind your vehicle.
- Always observe legal regulations when using the lighting systems described.

### i Tips

- The light sensor for the automatic headlights\* is in the rearview mirror mount. Do not place any stickers in this area on the windshield.
- Some exterior lighting functions can be adjusted ⇒ page 34.

- If you turn off the ignition while the exterior lights are on and open the door, a warning tone sounds.
- In cool or damp weather, the inside of the headlights, turn signals and tail lights can fog over due to the temperature difference between the inside and outside. They will clear shortly after switching them on. This does not affect the service life of the lighting.

this reason, only use the high beams or the headlight flasher when they will not create glare for other drivers.

### Adjusting the exterior lighting

The functions are adjusted in the Infotainment system.

- ▶ Select: **CAR** function button > **(Car) Systems\*** control button > **Vehicle settings** > **Exterior lighting**.

### Turn signal and high beam lever

The turn signal lever operates the turn signals, the high beams and the headlight flasher.

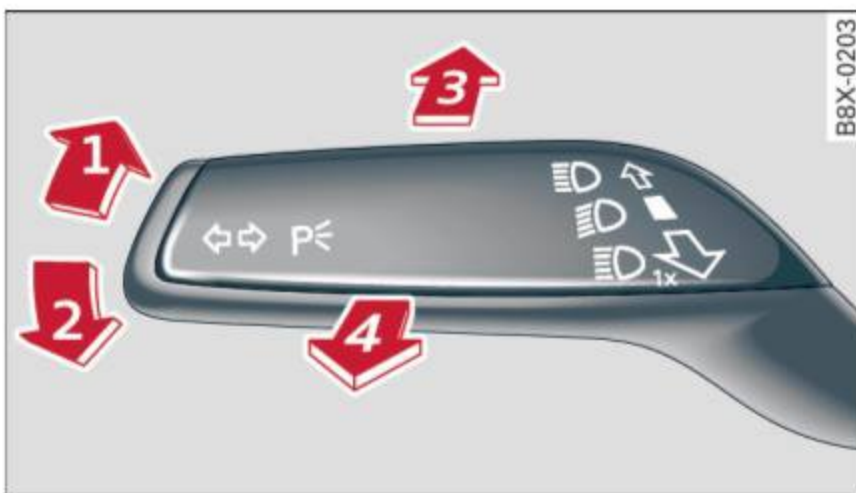

Fig. 31 Turn signal and high beam lever

### Coming home, Leaving home\*

The coming home function illuminates the area outside the vehicle when you turn the ignition off and open the driver's door. To turn the function on, select **Lights when leaving car** > **On**.

The leaving home illuminates the area outside the vehicle when you unlock the vehicle. To turn the function on, select **Lights when unlocking car** > **On**.

The coming home and leaving home functions only operate when it is dark and the light switch is in the **AUTO** position.

### Turn signals ⇐⇒

The turn signals activate when you move the lever into a turn signal position when the ignition is switched on.

- ① - Right turn signal
- ② - Left turn signal

The turn signal blinks three times if you just tap the lever.

### High beams and headlight flasher

Move the lever to the corresponding position.

- ③ - High beams on
- ④ - High beams off or headlight flasher

The  indicator light in the instrument cluster turns on.

### Daytime running lights\*

**USA models:** the daytime running lights can be switched on/off. Select **On** or **Off**.

**Canada models:** this function cannot be switched off. They activate automatically each time the ignition is switched on.

### Emergency flashers



Fig. 32 Center console: emergency flasher button

The emergency flashers makes other drivers aware of your vehicle in dangerous situations. ▶

### WARNING

High beams can cause glare for other drivers, which increases the risk of an accident. For

- ▶ Press the  button to switch the emergency flashers on or off.

You can indicate a lane change or a turn when the emergency flashers are switched on by using the turn signal lever. The emergency flashers stop temporarily.

The emergency flashers also work when the ignition is turned off.

**i Tips**

You should switch the emergency flashers on if:

- you are the last car in a traffic jam so that all other vehicles approaching from behind can see you, or if
- your vehicle has broken down or you are having an emergency, or if
- your vehicle is being towed or if you are towing another vehicle



## Interior lighting

### Front interior lighting



Fig. 33 Headliner: front interior lighting (example)

Press the applicable button:



-  - Interior lighting on/off
-  - Door contact switch on/off. The interior lighting is controlled automatically.
-  - Reading lights\* on/off

### Rear interior lighting

Applies to: vehicles with rear reading lights



Fig. 34 Headliner: rear reading lights (example)

- ▶ To turn a reading light on/off, press the button  .

### Interior lighting

Applies to: vehicles with interior lighting

The Interior lighting can be adjusted in the Infotainment system.

- ▶ In the Infotainment system\*, select: **CAR** function button > **(Car) Systems\*** control button > **Vehicle settings** > **Interior lighting**.

### Instrument illumination

You can adjust the background brightness of the instruments and display illumination\*.



Fig. 35 Instrument illumination

- ▶ To reduce or increase the brightness, turn the thumbwheel down or up.

**i Tips**

The needles and gauges in the instrument cluster illuminate when the headlights are off

and the ignition is switched on. The illumination reduces automatically and eventually turns off as brightness outside decreases. This function reminds the driver to turn the low beams on at the appropriate time.

## Vision

### Adjusting exterior mirrors



Fig. 36 Driver's door: knob for the exterior mirrors

Turn the knob to the desired position:

↔ - Adjusting the left/right exterior mirror. Move the knob in the desired direction.

☀ - Heats\* the mirror glass depending on the outside temperature.

↪ - Folds the exterior mirrors\*.

### Front passenger's exterior mirror tilt function\*

To help you see the curb when backing into a parking space, the surface of the mirror tilts slightly. For this to happen, the knob must be in the position for the front passenger's exterior mirror.

You can adjust the tilted mirror surface by turning the knob in the desired direction.

When you move out of reverse and into another gear, the new mirror position is stored and assigned to the key you are using.

The mirror goes back into its original position once you drive forward faster than 9 mph (15 km/h) or turn the ignition off.

### WARNING

Curved mirror surfaces (for example convex) enlarge the field of vision. However, they make objects in the mirror appear smaller and farther away. You may estimate incorrectly when you use these mirrors to gauge your distance from the vehicles behind you when changing lanes, which increases the risk of an accident.

### Note

- If the mirror housing was moved by force (for example, by running into an object when maneuvering the vehicle), the mirror must be folded all the way in using the power folding function. The mirror housing must not be moved back into place by hand because this would impair the function of the mirror mechanism.
- If you wash the vehicle in an automatic car wash, you must fold the exterior mirrors in to reduce the risk of damage to the mirrors. Never fold power folding exterior mirrors\* by hand. Only fold them in and out using the power controls.

### Tips

If the power adjusting function malfunctions, the glass in both mirrors can be adjusted by pressing on the edge of it by hand.

### Dimming the mirrors

Your vehicle is equipped with a manual or automatic dimming rearview mirror.

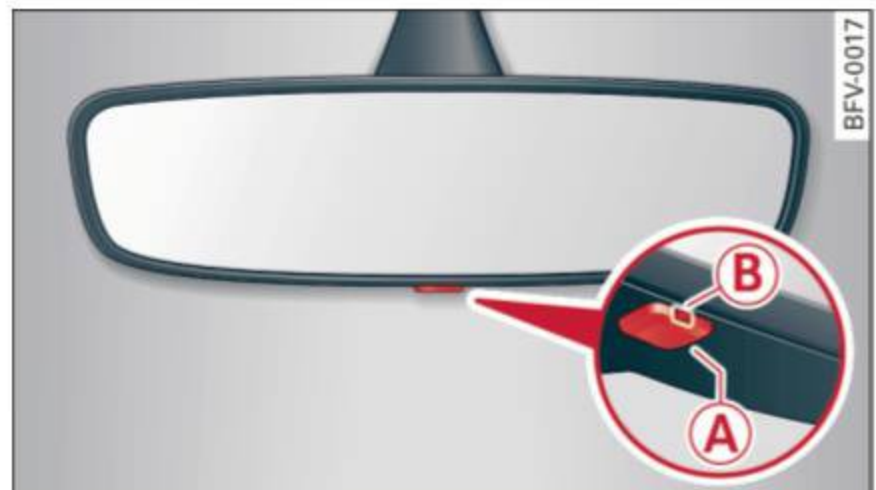

Fig. 37 Automatic dimming rearview mirror\*

**Manual dimming rearview mirror\***

- ▶ Pull the lever on the bottom of the mirror back.

**Automatic dimming rearview mirror\***

- ▶ Press the button **(A)** to switch the dimming function on the mirror on or off. If the indicator light **(B)** turns on, the interior and exterior mirrors\* are dimmed when light shines on them (for example, headlights shining from a vehicle behind you).

**! WARNING**

If the glass on an automatic dimming mirror breaks, electrolyte can leak out. This liquid can irritate the skin, eyes and respiratory system. If there is contact with the fluid, flush immediately with plenty of water. Consult a physician if necessary.

- Repeated or long-term exposure to electrolyte fluid can lead to irritation of the airways, especially in people with asthma or other respiratory conditions. Take deep breaths immediately after leaving the vehicle or, if this is not possible, open all of the doors and windows as wide as possible.
- If electrolyte fluid enters the eyes, flush them thoroughly with a large amount of clean water for at least 15 minutes and then seek medical attention.
- If electrolyte fluid comes into contact with the skin, flush the affected area with clean water for at least 15 minutes and then clean with soap and water and seek medical attention. Clean affected clothing and shoes thoroughly before wearing again.
- If the fluid was swallowed and the person is conscious, flush the mouth with water for at least 15 minutes. Do not induce vomiting unless this is recommended by medical professionals. Seek medical attention immediately.

**! Note**

If the glass on an automatic dimming mirror breaks, electrolyte can leak out. This liquid damages plastic surfaces and paint. Clean

this liquid as quickly as possible, for example with a wet sponge.

**i Tips**

- If the light reaching the rearview mirror is obstructed, the automatic dimming mirror will not function correctly,
- The automatic dimming mirrors do not dim when the interior lighting is turned on or the reverse gear is selected.

**Sun visors**



Fig. 38 Driver's side: sun visor

The sun visors for the driver and front passenger can be released from their mounts and turned toward the doors **(1)**. The sun visors can also be moved\* back and forth lengthwise in this position.

The mirror light switches on when the cover over the vanity mirror\* **(2)** opens.

# Windshield wipers

## Switching the windshield wipers on

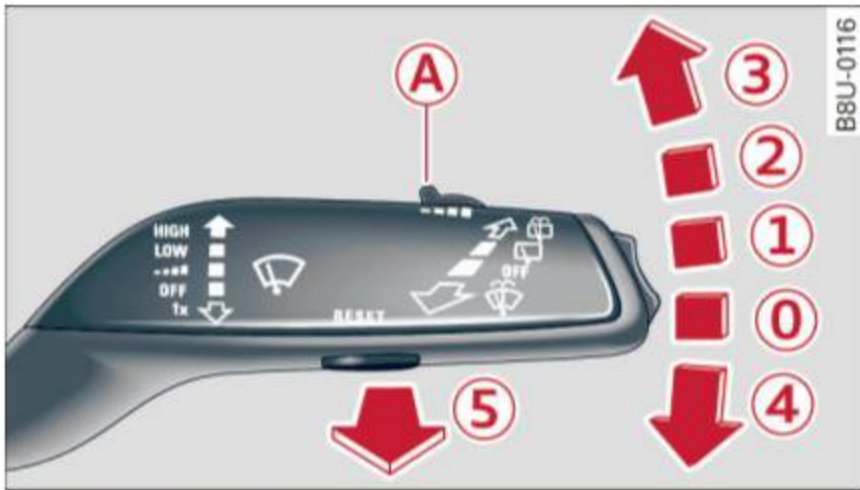

Fig. 39 Windshield wiper lever



Fig. 40 Actuate the rear window wiper

Move the windshield wiper lever to the corresponding position:

- ① - Windshield wipers off
- ② - Interval mode. To increase/decrease the wiper intervals, move the switch **A** to the left/right. In vehicles with a rain sensor\*, the wipers turn on in the rain once the vehicle speed exceeds approximately 2 mph (4 km/h). The higher the sensitivity of the rain sensor that is set (switch **A** to the right), the earlier the windshield wipers react to moisture on the windshield.
- ③ - Slow wiping
- ④ - Fast wiping
- ⑤ - Single wipe. If you hold the lever in this position longer, the wipers switch from slow wiping to fast wiping.
- ⑥ - Clean the windshield. The wipers wipe one time after several seconds of driving to remove water droplets. You can switch this function off by moving the lever to position **⑤** within 10 seconds of the afterwipe. The afterwipe function is

reactivated the next time you switch the ignition on.

- ⑦ - Wipe the rear window. The rear wiper moves about every 6 seconds.
- ⑧ - Clean the rear window. The number of wipes depends on how long the lever is held in position **⑧**.

**! WARNING**

- The rain sensor is only intended to assist the driver. The driver may still be responsible for manually switching the wipers on based on visibility conditions.
- The windshield may not be treated with water-repelling windshield coating agents. Unfavorable conditions, such as wetness, darkness or low sun, can result in increased glare, which increases the risk of an accident. Wiper blade chatter is also possible.
- Properly functioning windshield wiper blades are required for a clear view and safe driving ⇒ page 39, *Replacing windshield wiper blades*.

**! Note**

- If there is frost, make sure the windshield wiper blades are not frozen to the windshield. Switching on the windshield wipers when the blades are frozen to the windshield can damage the wiper blades.
- The windshield wiper system must be switched off (lever in position **①**) before using a car wash. This prevents the wipers from switching on unintentionally and causing damage to the windshield wiper system.

**i Tips**

- The windshield wipers switch off when the ignition is switched off. You can activate the windshield wipers after the ignition is switched back on by moving the windshield wiper lever to any position.
- Worn or dirty windshield wiper blades result in streaking. This can affect the rain sensor\* function. Check your windshield wiper blades regularly.



- The washer fluid nozzles for the windshield washer system are heated at low temperatures when the ignition is on.
- When stopping temporarily, such as at a traffic light, the speed of the windshield wipers automatically reduces by one level.

### Cleaning the wiper blades

Clean the wiper blades when you see wiper streaks. Use a soft cloth and a glass cleaner.

### Windshield wiper

- ▶ Place the windshield wiper arms in the service position ⇒ *page 39*.
- ▶ Fold the windshield wiper arms away from the windshield.

### Rear window wiper

- ▶ Fold the wiper arm away from the rear window.

#### WARNING

Dirty windshield wiper blades can impair vision, which increases the risk of an accident.

### Replacing windshield wiper blades

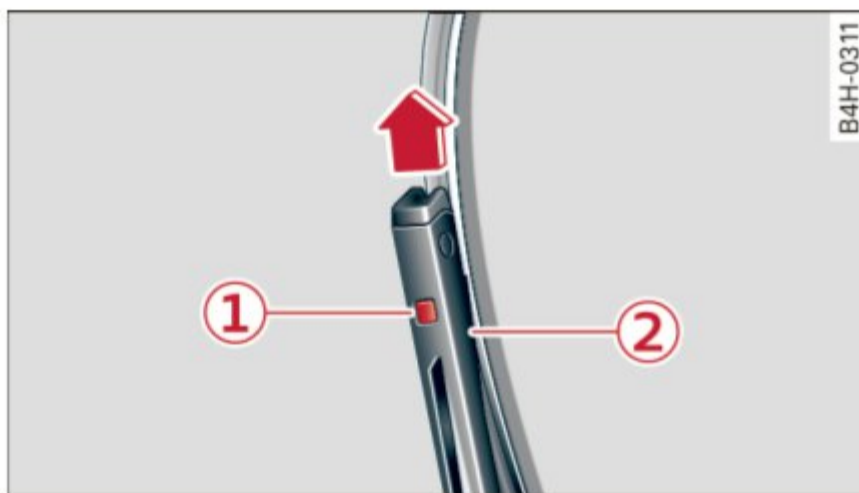

Fig. 41 Removing windshield wiper blades

### Windshield wiper service position/blade replacement position

- ▶ Switch the windshield wipers off (position 0 ⇒ *page 38, fig. 39*).
- ▶ Switch off the ignition and hold the windshield wiper lever in position 4 ⇒ *page 38, fig. 39* until the windshield wiper moves into the service position.
- ▶ To bring the windshield wipers back to the normal position, switch the ignition on and hold

the windshield wiper lever in position 4 until the windshield wipers go back to the normal position, or drive faster than 8 mph (12 km/h).

### Removing the wiper blade

- ▶ Fold the windshield wiper arm away from the windshield.
- ▶ Press the locking knob 1 ⇒ *fig. 41* on the wiper blade. Hold the wiper blade firmly.
- ▶ Remove the wiper blade in the direction of the arrow.

### Installing the wiper blade

- ▶ Insert the new wiper blade into the mount on the wiper arm 2 until you hear it latch into place.
- ▶ Place the wiper arm back on the window.
- ▶ To bring the wiper blades back into the original position, switch the ignition on and operate the windshield wiper lever.

#### WARNING

For safety reasons, the windshield wiper blades should be replaced once or twice each year.

#### Note

- Only fold the windshield wipers away when they are in the service position. Otherwise, you risk damaging the paint on the hood or the windshield wiper motor.
- You should not move your vehicle or operate the windshield wiper lever when the wiper arms are folded away from the windshield. The windshield wipers would move back into their original position and could damage the hood and windshield.

#### Tips

- You can also use the service position, for example, if you want to protect the windshield from icing by using a cover.
- You cannot activate the service position when the hood is open.

**Replacing rear wiper blades**



Fig. 42 Rear window wiper: removing the wiper blade

**Removing the wiper blade**

- ▶ Fold the wiper arm away from the rear window.
- ▶ Pull the wiper blade and holder out of the mount.

**Installing the wiper blade**

- ▶ Press the wiper blade retainer in the direction of the arrow into the mount.
- ▶ Fold the window wiper arm back onto the rear window.

**! WARNING**

For safety reasons, the windshield wiper blades should be replaced once or twice each year.

**Digital compass**

**Switching the compass on and off**

Applies to: vehicles with digital compass



Fig. 43 Rearview mirror: digital compass is switched on

- ▶ To turn the compass in the mirror on or off, press the button **A** until the compass display in the mirror appears or disappears.

The digital compass only works when the ignition is turned on. The directions are indicated with abbreviations: **N** (north), **NE** (northeast), **E** (east), **SE** (southeast), **S** (south), **SW** (southwest), **W** (west), **NW** (northwest).

**i Tips**

To prevent inaccurate compass readings, do not bring any remote controls, electrical devices or metallic objects near the mirror.

**Adjusting the magnetic zone**

Applies to: vehicles with digital compass

*The magnetic zone must be adjusted correctly for the compass to read accurately.*

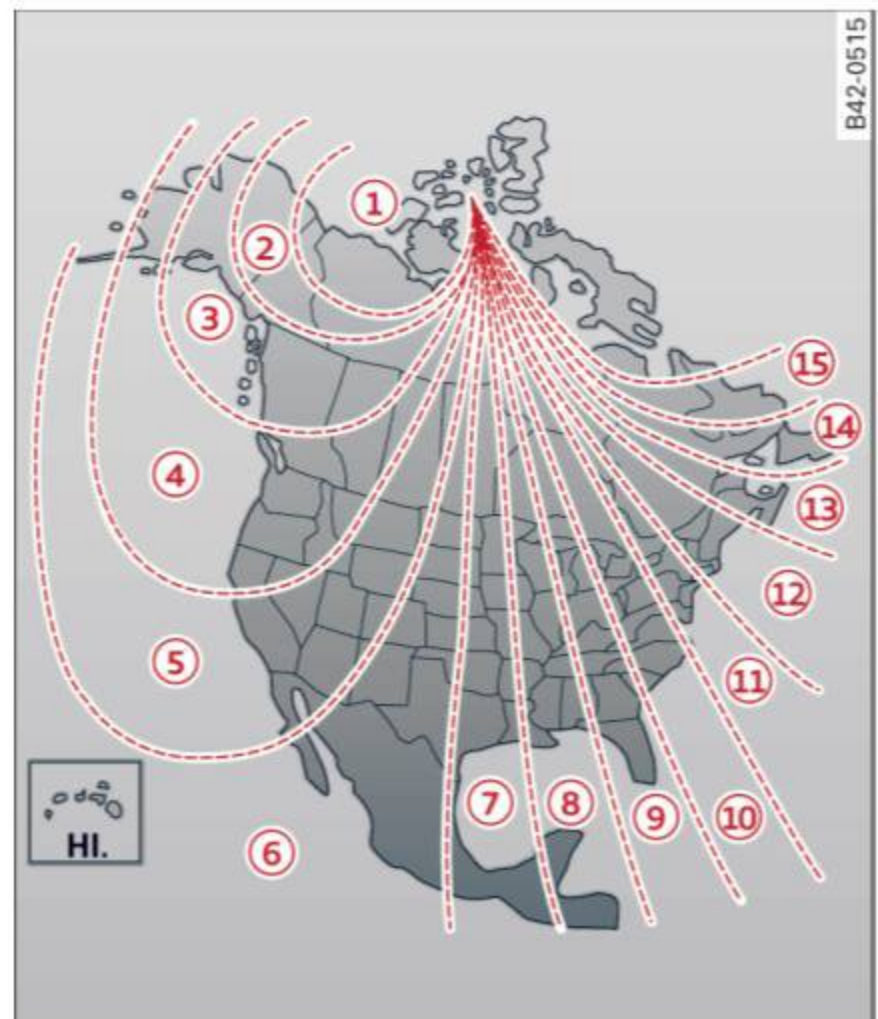



Fig. 44 North America: magnetic zone map

- ▶ Press and hold the button **A** ⇨ fig. 44 until the number of the magnetic zone appears in the rearview mirror.
- ▶ Press the button **A** repeatedly to select the correct magnetic zone. The selection mode turns off after a few seconds.

## Calibrating the compass

Applies to: vehicles with digital compass

*You must recalibrate the compass if it does not display the correct direction.*

- ▶ Press and hold the button  ⇒ page 40, fig. 43 until a **C** appears in the interior rearview mirror.
- ▶ Drive in a circle at about 6 mph (10 km/h) until a direction is displayed in the rearview mirror.



### WARNING

- To reduce the risk to yourself and other drivers, calibrate the compass in an area where there is no traffic.
- Always pay attention to the traffic and the area around your vehicle if you are reading the compass while driving.

## Seats and storage

### General information

#### WARNING

See ⇒ page 97, *Driving safety* for important information, tips, suggestions and warnings that you should read and follow for your own safety and the safety of your passengers.

### Front seats

#### Manual seat adjustment

Applies to vehicles with manual adjustable seats



Fig. 45 Front seat: manual seat adjustment

- ① - Moving the seat forward/back: pull the lever and slide the seat.
- ② - Lengthening/shortening the upper thigh support\*: lift the handle.
- ③ - Adjusting the angle of the seat surface\*. Pull/press the lever.
- ④ - Adjusting the lumbar support\*: press the button in the desired direction.
- ⑤ - Moving the seat up/down: pull/press the lever.
- ⑥ - Adjusting the backrest angle: turn the adjusting wheel.

#### WARNING

- To reduce the risk of an accident, only adjust the front seats when the vehicle is stationary.
- Exercise caution when adjusting the seat height. Adjusting the seat carelessly or

without checking can pinch hands and fingers.

- The front seat backrests must not be reclined too far back when driving, because this impairs the effectiveness of the safety belts and airbag system, which increases the risk of injury.

#### Power seat adjustment

Applies to vehicles with power adjustable seats

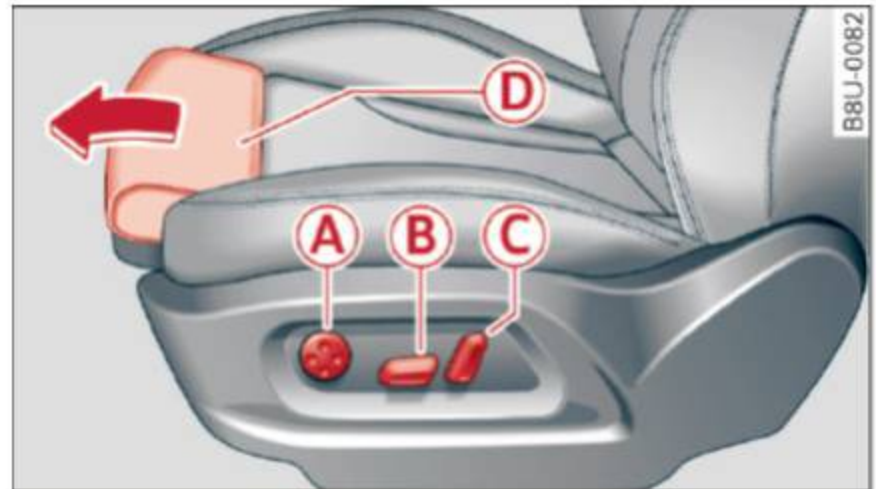

Fig. 46 Front seat: power seat adjustment

- Ⓐ - adjusting the lumbar support: press the button in the applicable position.
- Ⓑ - moving the seat up/down: press the button up/down. To adjust the front seat cushion, press the front button up/down. To adjust the rear seat cushion, press the rear button up/down.
- Ⓑ - moving the seat forward/back: press the button forward/back.
- Ⓒ - adjusting the backrest angle: press the button forward/back.
- Ⓓ - lengthening/shortening the upper thigh support\*: lift the handle.

#### WARNING

- To reduce the risk of an accident, only adjust the front seats when the vehicle is stationary.
- The power adjustment for the front seats also works with the ignition switched off or with the ignition key removed. To reduce the risk of injury, children should never be left unattended in the vehicle for this reason.

- Exercise caution when adjusting the seat height. Unsupervised or careless seat adjustment can pinch fingers or hands, which increases the risk of injury.
- The front seat backrests must not be reclined too far back when driving, because this impairs the effectiveness of the safety belts and airbag system, which increases the risk of injury.
- To minimize the risk of injury during sudden braking or a collision, the driver and the front passenger must not drive or ride with the backrest in the reclined position. The safety belts and airbag system can only provide the greatest protection possible when the backrests are in the upright position and the safety belts are worn correctly. The more a backrest is reclined, the greater the risk of injury due to an incorrect seating position and safety belt position.

### Front center armrest

Applies to vehicles with a front center armrest



**Fig. 47** Armrest between the driver's seat and passenger's seat

- ▶ Fold up the center armrest support to open the storage compartment.
- ▶ To adjust the center armrest, lift up the armrest notch by notch.
- ▶ To bring the center armrest back down, raise it out of the top notch and then fold it back down.

The armrest can slide forward and back.

Please note that the driver's ability to move his or her arm may be restricted when the armrest is folded down. Because of this, the armrest should not be folded down during city driving.

## Head restraints

### Front head restraints

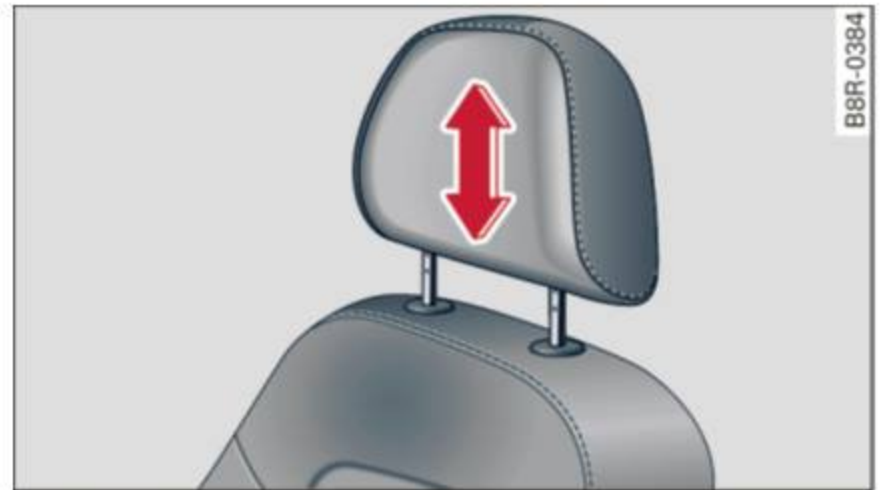

**Fig. 48** Front seat: head restraints

Adjust the head restraints so the upper edge is as even as possible with the top of your head. If that is not possible, try to adjust as close to this position as possible.

- ▶ Hold the head restraint at the sides with both hands and slide the head restraint up/down until it clicks into place.



### WARNING

Always read and follow the applicable warnings ⇒ *page 100, Proper adjustment of head restraints.*

**Rear head restraints**

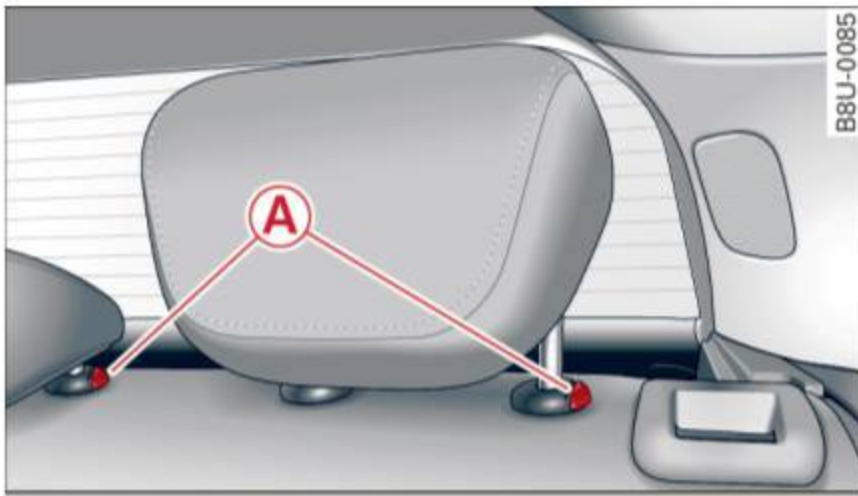

Fig. 49 Rear seats: outer head restraints



Fig. 50 Rear head restraints: release point

If there are passengers in the rear seat, move the head restraints up on the occupied seats at least to the next notch ⇒ ⚠.

**Moving the head restraints**

- ▶ To move the head restraint up, hold it at the sides with both hands and slide it all the way up until you feel it click into place.
- ▶ To move the head restraint down, press the button Ⓐ ⇒ fig. 49 and slide the head restraint downward.

**Removing the head restraints**

- ▶ Fold the backrest forward ⇒ page 47.
- ▶ Slide the headrest all the way up.
- ▶ Press the release point Ⓑ ⇒ fig. 50, for example with the screwdriver from the vehicle tool kit, and press the button Ⓐ. Pull the head restraint out of the backrest at the same time ⇒ ⚠.

**Installing the head restraints**

- ▶ Slide the posts on the head restraint down into the guides until the posts click into place.

- ▶ Press the button Ⓐ and slide the head restraint all the way down. You should not be able to pull the head restraint out of the backrest.

**⚠ WARNING**

- Always read and follow the applicable warnings ⇒ page 100, *Proper adjustment of head restraints.*
- Only remove the rear seat head restraints when necessary in order to install a child safety seat. Install the head restraint again immediately once the child safety seat is removed. Driving with the head restraints removed or not in the upright position increases the risk of serious injury.

**Sockets**

Applies to: vehicles with socket



Fig. 51 Front center console: 12 Volt socket\*



Fig. 52 Rear center console: 12 Volt socket\*

- ▶ Insert the plug for the electrical device into the socket ① ⇒ fig. 51.

The 12 volt socket can be used for electrical accessories. The power consumption at the outlet must not exceed 120 watts.

There is an additional 12V socket in the center console.

**! WARNING**

The sockets and the electrical accessories connected to them only function when the ignition is switched on. Incorrect usage can lead to serious injuries or burns. To reduce the risk of injuries, never leave children unattended in the vehicle with the vehicle key.

**! Note**

- To reduce the risk of damage to the vehicle electrical system, never attempt to charge the vehicle battery by connecting accessories that provide power, such as solar panels or battery chargers, to the 12 Volt sockets.
- To reduce the risk of damage to the sockets, only use plugs that fit correctly.

**i Tips**

The vehicle battery drains when accessories are turned on but the engine is off.

- ▶ Place your beverage in the holder and release the arm. The arm swings back by itself and secures the beverage.
- ▶ To close the cup holders, press the center piece between both arms and push the cup holders all the way back into the slot.

**! WARNING**

- Do not put any hot beverages in the cup holder while the vehicle is moving. Hot beverages could spill, which increases the risk of injury.
- Do not use any breakable beverage containers (for example, made out of glass or porcelain). You could be injured by them in the event of an accident.

**! Note**

Beverage containers in the cup holders should always have a lid. If not, beverages could spill and cause damage to vehicle equipment, such as electronics or seat covers.

## Storage

### Cup holders

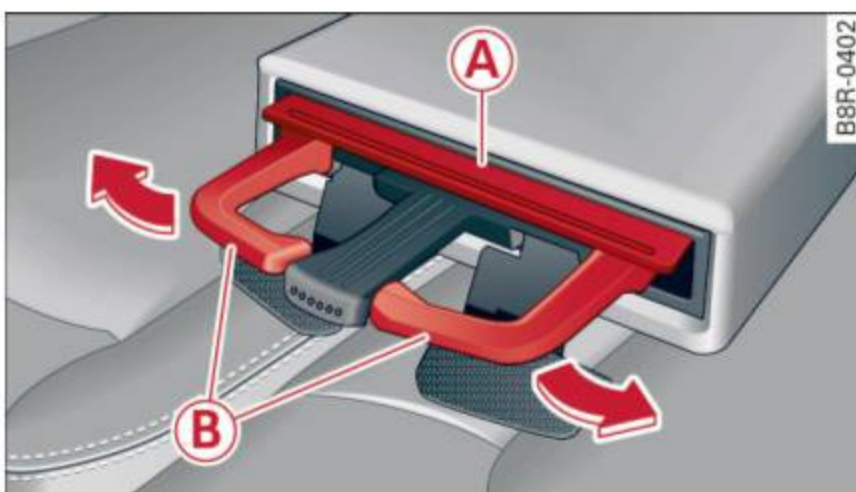



Fig. 53 Rear center armrest: rear cup holders\*

Your vehicle has cup holders in the front center console, in the door pockets and in the rear center armrest\*.

#### Rear cup holders\*

- ▶ Tilt the rear center armrest all the way down.
- ▶ To open the cup holder, tap on the  symbol **(A)** ⇒ fig. 53.
- ▶ To adjust the cup holder to fit the beverage container, push the corresponding arm **(B)** in the direction of the arrow.

### Glove compartment

The glove compartment can lock\*, illuminate\* and refrigerate\*.



Fig. 54 Glove compartment: switching cooling mode\* on/off

- ▶ To open the glove compartment, pull the handle in the lid and tilt the lid downward.
- ▶ To switch the cooling\* on, turn the knob **(A)** counter-clockwise. The symbols on the knob must appear as they do in ⇒ fig. 54.
- ▶ To switch the cooling\* off, turn the knob **(A)** clockwise.
- ▶ To close the glove compartment, swing the lid upward until it clicks into place.

### WARNING

Always keep the glove compartment lid closed while driving to reduce the risk of injury.

### Additional compartments

You will find a variety of storage compartments and holders at various locations in the vehicle.

- In the door trim panels.
- In the center console.
- On the side of the front seats\*. The sliding compartment can hold a maximum of 3.3 lbs (1.5 kg) and the folding compartment can hold 2.2 lbs (1 kg).
- Nets\* on the backrests of the front seats
- Garment hooks next to and above the rear doors.
- Bag/securing hooks in luggage compartment.

### WARNING

- No heavy or hard objects may be placed on the storage compartment behind the rear seat backrest. There is a risk of injuring the vehicle passengers when braking suddenly.
- Make sure that the view to the rear is not obstructed by hanging garments.
- Hang only lightweight clothing and be sure that there are no heavy or sharp-edged objects in the pockets.
- Do not use coat hangers to hang garments, because this could reduce the effectiveness of the side curtain airbags\*.
- Only use the storage compartments in the door trim panels to store small objects that will not stick out of the compartment and impair the range of the side airbags.

### Note

Objects on the rear shelf that rub against the rear window can damage the rear window heating wires.

## Luggage compartment

### General information

### WARNING

Read and follow the important safety precautions in  $\Rightarrow$  page 102.

### Luggage compartment cover

Applies to: vehicles with luggage compartment cover



Fig. 55 Luggage compartment: cover attached



Fig. 56 Right front section of the luggage compartment: removing the luggage compartment cover

### Attaching

- ▶ Pull the cover out and attach it in the mounting eyelets in the side trim panel  $\Rightarrow$  fig. 55.

### Removing

- ▶ Pull both levers all the way in the direction of the arrow  $\Rightarrow$  fig. 56.
- ▶ Pull the cover upward to remove.

### Installing

- ▶ Place both sides of the cover into the mounts on the side trim.
- ▶ Push the cover downward until both sides click into place.



### Storing\*

Depending on the vehicle equipment, you can store the cover under the cargo floor  
⇒ page 49.

#### **! WARNING**

- To reduce the risk of accidents, the luggage compartment cover should never be unsecured under any circumstances.
- The luggage compartment cover is not a surface for storing objects. Objects placed on the cover could endanger all vehicle occupants during sudden braking maneuvers or in a crash.

#### **! Note**

To avoid damage, let the luggage compartment cover roll up slowly after removing.

### Increasing the size of the luggage compartment

The rear seat backrests can be folded forward either separately or together.

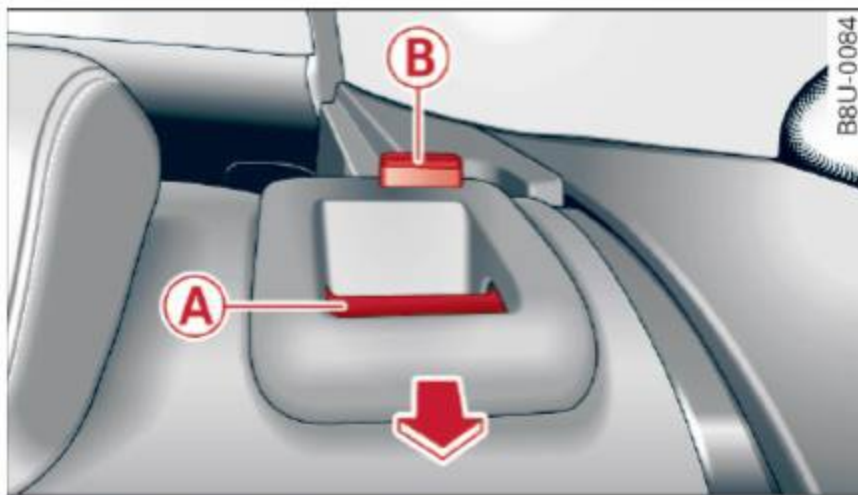

Fig. 57 Backrest: release lever

### Folding the backrest forward

- ▶ Pull the release lever **A** ⇒ fig. 57 in the direction of the arrow and fold the backrest forward.

### Folding the backrest back into the upright position

- ▶ Fold the backrest back up again until it latches and the red marking **B** is no longer visible ⇒ **!**.

#### **! WARNING**

- The backrest must be securely latched to ensure the safety belt is protecting the rear seat positions.
- The backrest must be securely latched so objects cannot slide forward out of the luggage compartment during sudden braking.

#### **! Note**

- If you move the front seat back when the rear seat backrest is folded forward, you could damage the head restraints on the rear seat. If necessary, remove the rear seat head restraint before moving the front seat back
- To reduce the risk of damage, move the rear head restraints down before folding the rear backrests forward ⇒ **!** in *Rear head restraints on page 44*.
- Make sure the outer safety belts are not pinched or damaged when folding the seat back.

### Tie-downs and luggage compartment net/cargo bag

Applies to: vehicles with tie-downs/luggage compartment net

The luggage compartment net\* prevents smaller objects from sliding out of place.



Fig. 58 Luggage compartment: luggage compartment net\* stretched out

Read and follow all warnings ⇒ **!** in *Loading the luggage compartment on page 102*.

### Cargo net

- ▶ Attach the hooks for the luggage compartment net in the tie-downs -arrows- ⇒ fig. 58. ▶

### Cargo bag

- ▶ Engage the two hooks on the side with the cargo bag to the tie-downs on the floor near the rear seat.
- ▶ Engage both eyes on the luggage compartment net to the bag hooks\* in the side trim panel.

You can also use the bag hooks\* to hang light purses, bags, etc.

#### **WARNING**

For strength reasons, only objects with a maximum weight of 10 lb (5 kg) should be secured in the luggage compartment net. Heavier objects are not adequately secured. There is risk of personal injury.

### Bag hooks



Fig. 59 Luggage compartment: bag hooks (example)

The bag hooks can be used to prevent bags with light contents from falling over.

#### **WARNING**

Do not use the **bag hooks** to secure heavy objects. Heavy objects are not adequately secured. There is risk of personal injury.

### Cargo mat

Applies to: vehicles with cargo mat

*The cargo mat\* protects the luggage compartment and bumper from dirt and scratches.*



Fig. 60 Luggage compartment: cargo mat

You can use the cargo mat with the dirt-resistant side or the decorative side. After loading or unloading, fold up the cargo mat and close the luggage compartment lid. Only store the cargo mat if it is dry.

### Pass-through with ski bag

Applies to: vehicles with pass-through and ski bag

*Long objects, such as skis or snowboards, can be transported in the ski bag.*

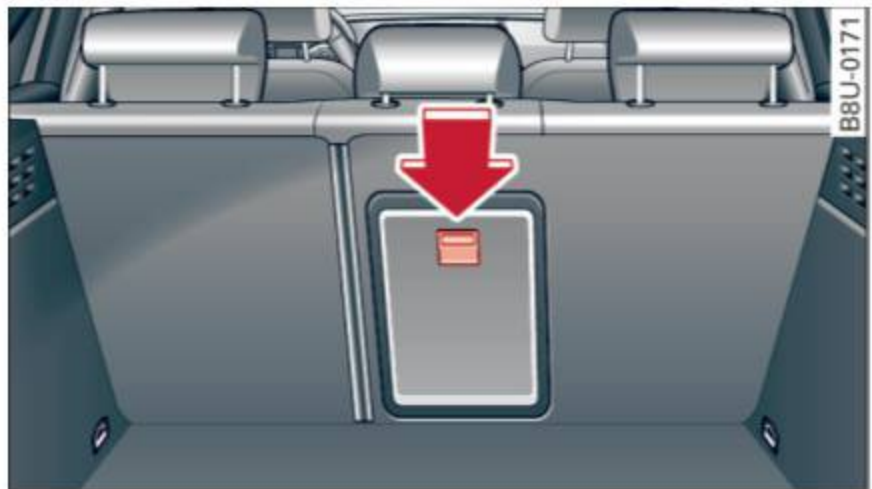

Fig. 61 Luggage compartment: pass-through in the backrest

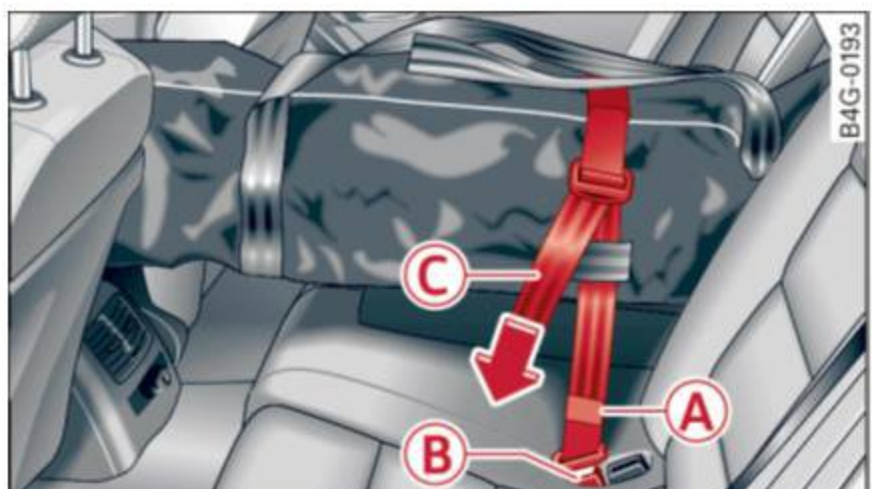





Fig. 62 Rear bench seat: securing the ski sack

### Loading

- ▶ Press the release button in the luggage compartment ⇒ *fig. 61* and fold the pass-through toward the front.
- ▶ Push the ski bag through the opening from the luggage compartment. The zipper must face toward the rear ⇒ .

### Securing

- ▶ Stick the strap  on the bag in the center belt latch  ⇒ *fig. 62*.
- ▶ Tighten and secure the strap .

### WARNING

- The ski sack is intended only for the transportation of skis and other light objects. To reduce the risk of serious personal injury, never transport heavy or pointed objects in the ski sack.
- When braking rapidly or during an accident, the load could be displaced and cause injury to occupants.
- Sharp edges on the load must be covered for protection. Always fasten the belt tightly around the sack and its contents ⇒ *fig. 62*.
- For safety reasons, do not transport more than two pairs of skis in the ski sack.
- You must secure the ski sack with the strap after loading.
- Make sure all objects that you are transporting in the pass-through are secured. Otherwise they could slide around during sudden braking maneuvers and cause injury.

### Tips

- Only fold the bag up if it is dry.
- When transporting skis or snowboards, tighten the securing strap between the bindings.
- Lay skis in the bag with the points facing forward and snowboards and ski pole points facing the rear.

### Reversible cargo floor

Applies to: vehicles with reversible cargo floor



**Fig. 63** Luggage compartment: reversible cargo area floor with the decorative side facing up

### Reversing the cargo area floor

You can use the reversible cargo area floor with the dirt-resistant side or the decorative side.

- ▶ To turn up the dirt-resistant side, pull the cargo floor up at the handle ⇒ *fig. 63* and out toward the rear. Or
- ▶ To turn up the decorative side, take out the cargo floor at both handles on the left and right side.
- ▶ Reinsert the cargo floor.

### Roof rack

Applies to: vehicles with roof rack



**Fig. 64** Attachment points for the roof rack

If luggage or cargo is to be carried on the roof, you must observe the following:

- Only a specially designed roof rack may be used on your vehicle. These roof racks are the basis for a complete roof rack system. Additional attachments/carrier systems are necessary to transport luggage and sports equipment. We ▶

recommend roof racks and attachments from the Audi Genuine Accessories program.

- When installing the roof rack, make sure that it is mounted only at the designated points on the roof ⇒ *fig. 64*.
- The permissible roof load for your vehicle is 165 lb (75 kg). The roof load is the total of the weight of the roof rack, the attachments and the cargo you are carrying. However, you must also note the permitted load of the carrier system being used. For the permitted axle load and the permitted total vehicle weight, see ⇒ *page 209*.

### **WARNING**

- Follow the installation instructions provided with the roof rack system. If you do not secure the roof rack system and objects on the roof correctly, they could come loose from the vehicle and cause an accident.
- The risk of an accident increases when using a roof rack system, because it changes the driving characteristics by shifting the center of gravity and/or the increasing the surface area exposed to wind. Adapt your driving and speed to the current conditions.

### **Note**

- If you use other roof luggage rack systems or do not install the racks as intended, any damage to the vehicle is not covered by the warranty. Carefully follow the assembly and installation instructions included with the roof rack carrier system.
- Make sure that the luggage compartment lid and the panorama glass roof\* do not come into contact with objects on the roof when they are open.

### **For the sake of the environment**

Your vehicle will require more fuel due to the increased wind resistance. So remove the roof rack after using it.

## Warm and cold

### Climate control system

#### Description

Depending on the vehicle equipment, different systems could be installed:

- manual climate control system or
- automatic climate control system\*

The climate control system circulates, warms or cools, and removes humidity from the air in the vehicle interior. It is the most effective when the windows and panorama glass roof\* are closed. If there is a build-up of heat inside the vehicle, ventilation can help to speed up the cooling process.

#### Pollutant filter

The pollutant filter removes pollutants such as dust and pollen from the air.

#### Key recognition\*

The automatic climate control system\* settings are stored and assigned to the remote control key that is in use.

#### WARNING

- Poor visibility can lead to accidents.
- For safer driving, keep all windows free of ice, snow and fog.
  - Become familiar with the correct use and function of the climate control system as quickly as possible, especially with the defrosting and defogging functions.
  - When the temperature is below freezing, only use the windshield washer system after the windshield has been warmed by the climate control system. The washer fluid could

freeze on the windshield and impair visibility.

#### Note

- If you suspect that the climate control system is damaged, switch the system off to prevent further damage and have it checked by an authorized Audi dealer or authorized Audi Service Facility.
- Repairs to the Audi climate control system require special technical knowledge and special tools. See an authorized Audi dealer or authorized Audi Service Facility.

#### For the sake of the environment

- To save fuel, turn off the climate control system cooling mode by pressing the A/C button. This will also reduce emissions. The climate control system is off when the LED in the button turns off.
- In vehicles with the efficiency program\*, you can find other consumption information and more economy tips ⇨ *page 20*.

#### Tips

- To prevent interference with the heating and cooling output and to prevent the windows from fogging over, the air intake in front of the windshield must be free of ice, snow or leaves.
- Condensation from the cooling system\* can drip and form a puddle of water under the vehicle. This is normal and does not mean there is a leak.
- The energy management system may temporarily switch off certain functions, such as the seat heating\* or rear window defogger. These systems are available again as soon as the energy supply has been restored.

**Manual climate control system**

Applies to: vehicles with manual climate control system



Fig. 65 Manual climate control system controls

The functions can be switched on and off by pressing the buttons or adjusted using the dial and thumbwheel. The LED in a button will light up when the function is switched on.

**Manual climate control system**

For a comfortable temperature in cooling mode, we recommend:

- in warmer times of the year, set the temperature so that it is only a few degrees below the outside temperature.
- set the blower at a moderate speed
- don't direct the air flow directly on the passengers

**A/C cooling mode**

The cooling mode only functions with the blower turned on. You can turn the cooling system on or off by pressing the A/C button. The air is not cooled and humidity is not removed when cooling mode is switched off. This can cause fog on the windows. The cooling mode switches off auto-

matically when there are cold outside temperatures.

**● / ● Temperature**



The temperature can be adjusted using the left dial.

**☪ Blower**

Using the center knob, you can manually adjust the volume of air generated by the blower to your preferences. The blower should always run at a low setting to prevent the windows from fogging and to ensure a continuous exchange of air inside the vehicle. When the windows are fogged, using a higher blower speed and setting the knob to ☪ is recommended.

**☪ / ☪ / ☪ / ☪ Air distribution and vents**

The air distribution can be adjusted with the right knob. The setting between ☪ and ☪ provides a comfortable atmosphere in most cases.

In the  setting, the windshield and side windows are defrosted or cleared of condensation as quickly as possible. The recirculation mode switches off, but can be activated again manually by pressing the  button.

You can open or close the center and rear vents in the cockpit and the vents in the rear center console using the ridged thumbwheels. The levers adjust the direction of the airflow from the vents.

To keep the front side windows from fogging up in damp weather, we recommend opening the side air vents and tilting them to the side.

### Recirculation mode

In recirculation mode, the air inside the vehicle is circulated and filtered. This prevents the unfiltered air outside the vehicle from entering the vehicle interior. Switching recirculation mode on when driving through a tunnel or when sitting in traffic is recommended . If recirculation mode is switched on before the engine starts, it will be switched off automatically after approximately 20 minutes.

Recirculation mode is switched off in the defrost setting .

### Rear window defogger

The rear window defogger only operates when the engine is running. It switches off automati-

cally after approximately 10 to 20 minutes, depending on the outside temperature.

### Seat heating\*

You can adjust the left and right heated seat temperature using the left/right thumbwheel. The seat heating is switched off when the level is set to 0.

#### WARNING

- You should not use the recirculation mode for an extended period since no fresh air is drawn in. When the A/C system\* is switched off, the windows can fog up, which increases the risk of an accident.
- Individuals with reduced sensitivity to pain or temperature could develop burns when using the seat heating\* function. To reduce the risk of injury, these individuals should not use seat heating\*.

#### Note

To avoid damaging the seat heating\* elements, do not kneel on the seats or place heavy pressure on one area of the seat.

## Automatic climate control system

Applies to: vehicles with automatic climate control

Pressing AUTO button and setting the temperature to 72 °F (22 °C) is recommended.



Fig. 66 Center console: controls for automatic climate control system

The functions can be switched on and off by pressing the buttons or adjusted by turning the knob. The LED in a button will light up when the function is switched on.

### Automatic climate control system

The automatic climate control system automatically maintains a temperature once it has been set. In all heating mode functions except *defrost*, the blower only switches to a higher speed once the engine coolant has reached a certain temperature.

### OFF climate control system

The OFF button switches the climate control system on or off. Airflow from outside is blocked when the climate control system is switched off.

### AUTO Automatic mode

Automatic mode maintains a constant temperature inside the vehicle. Air temperature, airflow

and air distribution are controlled automatically. AUTO mode switches off once a button in the climate control system is pressed.

### A/C cooling mode

The cooling mode only functions with the blower turned on. You can turn the cooling system on or off by pressing the A/C button. The air is not cooled and humidity is not removed when cooling mode is switched off. This can cause fog on the windows. The cooling mode switches off automatically when there are cold outside temperatures.

### Temperature

The temperature can be set for the driver and the front passenger separately using the left/right knob. Temperatures can be set between a range of 60 °F (+16 °C) and 84 °F (+28 °C). If outside of this range, **LO** or **HI** will appear in the climate control system display. At both of these settings, ►





the climate control system runs continuously at maximum cooling or heating power. There is no temperature regulation.

**Synchronization:** by pressing the AUTO button for two seconds, the temperature setting for the driver's side is transferred to the front passenger's side. This applies a temperature change to the front passenger's side.

### **Blower**

Using the regulator , you can manually adjust the volume of air generated by the blower to your preference.

Use the left  button to decrease the air speed, and use the right  button to increase the air speed.

The blower should always run at a low setting to prevent the windows from fogging and to ensure a continuous exchange of air inside the vehicle. To have the airflow regulated automatically, press the AUTO button.

### **Air distribution and vents**

The air distribution can be adjusted with the buttons. To have the air distribution regulated automatically, press the AUTO button.

You can open or close the center and rear vents in the cockpit and the vents in the rear center console using the ridged thumbwheels. The levers adjust the direction of the airflow from the vents.

To keep the front side windows from fogging up in damp weather, we recommend opening the side air vents and tilting them to the side.

### **MAX Defrosting**

The windshield and side windows are defrosted or cleared of condensation as quickly as possible. The maximum amount of air flows mainly from the vents below the windshield. Recirculation mode switches off. The temperature should be set at +72°F (22°C) or higher.

The AUTO button switches the defroster off.

### **Recirculation mode**

To switch on the recirculation mode, press the  button. The lower LED in the button turns on.

In recirculation mode, the air inside the vehicle is circulated and filtered. This prevents the unfiltered air outside the vehicle from entering the vehicle interior. Switching recirculation mode on when driving through a tunnel or when sitting in traffic is recommended .

The AUTO button or  button switches recirculation mode off.

To switch on the automatic recirculation mode, press the  button again. The upper LED in the button turns on. The system switches to recirculation mode when driving in reverse when the engine is cold. The air quality sensor that is designed for diesel and gasoline exhaust automatically switches the recirculation mode on or off depending on the level of pollutants in the outside air. Automatic recirculation mode is time restricted when cooling mode (A/C) is switched off and frost temperatures are identified.

### **REAR Rear window defogger**

The rear window defogger only operates when the engine is running and will be automatically switched off after approximately 10 minutes.





### **Seat heating\***

Pressing the button switches the seat heating on at the highest setting (level 3).

The LEDs indicate the temperature level. To reduce the temperature, press the button again. To switch the seat heating off, press the button repeatedly until the LED turns off.

After approximately 10 minutes, the seat heating automatically switches from level 3 to level 2.

### **Switching the temperature measurement units**

The temperature display can be switched between °C and °F. Press and hold the  button  *fig. 66* and turn the knob on the driver's side to  for three seconds. 

### **WARNING**

- You should not use the recirculation mode for an extended period of time, because no fresh air is drawn in and the windows can fog when cooling mode is switched off. This increases the risk of an accident.
- Individuals with reduced sensitivity to pain or temperature could develop burns when using the seat heating\* function. To reduce the risk of injury, these individuals should not use seat heating\*.

### **Note**

To avoid damaging the seat heating\* elements, do not kneel on the seats or place heavy pressure on one area of the seat.

## Driving

### General information

#### Breaking in

A new vehicle must be broken in for the first 1,000 miles (1,500 km). For the first 600 miles (1,000 km), do not drive at speeds that are more than 2/3 of the maximum permitted RPM, avoid full acceleration, and do not tow a trailer. You may gradually start increasing the RPM and the speed between 600 miles (1,000 km) and 1,000 miles (1,500 km).

During the first hours of use, the engine has a higher internal friction than later on when all moving parts have settled into place with each other.

How the vehicle is driven during the first 1,000 miles (1,500 km) also affects the engine quality. Drive at moderate engine speeds after the initial break-in period, particularly when running a cold engine. This will reduce engine wear and improve the mileage.

Do not drive at too *low* of an engine speed (RPM). Shift down if the engine stops running “smoothly”. Extremely high engine speeds are automatically reduced.

#### Reducing the risk of vehicle damage

##### Note

When driving on poor roads, by curbs and on steep ramps, make sure that low-hanging components such as the spoiler and exhaust system do not come into contact with these or they could be damaged. This especially applies to vehicles with low ground clearance and vehicles that are heavily loaded.

#### Driving through water on roads

Note the following to reduce the risk of vehicle damage when driving through water, for example on flooded roads:

- The water must not be any higher than the bottom of the vehicle body.

- Do not drive faster than walking speed.

##### WARNING

After driving through water or mud, the effectiveness of the brakes may be reduced due to moisture on the brake rotors and brake pads. A few careful brake applications should dry off the brakes and restore the full braking effect.

##### Note

Vehicle components such as the engine, transmission, suspension or electrical system can be severely damaged by driving through water.

##### Tips

- Determine the depth before driving through water.
- Do not stop the vehicle, drive in reverse or switch the engine off when driving through water.
- Keep in mind that oncoming vehicles may create waves that raise the water level and make it too deep for your vehicle to drive through safely.
- Avoid driving through salt water, because this can cause corrosion.

#### Economical and environmentally-friendly driving

The amount of fuel consumption, the environmental impact and the wear to the engine, brakes and tires depends mostly on your driving style. With an anticipatory and economic driving style, fuel consumption can be reduced by approximately 10-15%. The following tips will help you conserve the environment and your money at the same time.

##### Anticipatory driving

A vehicle uses the most fuel when accelerating. When you drive with anticipation, you do not need to brake as often and so you accelerate less. When possible, let your vehicle coast with a **gear engaged**, for example when you notice that the next traffic light is red. This produces an engine ►

braking effect, which helps to protect the brakes and tires and reduces the emissions and fuel consumption to zero (fuel shut-off during deceleration).

### Shift efficiently

Upshifting *earlier* is an effective way to save fuel. Staying in a gear too long uses fuel unnecessarily.

Press down on the accelerator pedal slowly and avoid “kick-down”.

### Avoid full acceleration

You should rarely travel at the maximum vehicle speed. High speeds cause a disproportionately high increase in fuel consumption, emissions and traffic noise. Slower driving saves fuel.

### Reduce idling time

There are benefits to stopping the engine, for example when at railroad crossings or traffic lights with longer red lights. Stopping the engine for 30-40 seconds already saves more fuel than the amount of extra fuel needed to restart the engine.

It takes a very long time in idle to warm the engine up to operating temperature. Wear and emissions are especially high in the warm-up phase. Therefore, you should begin driving immediately after starting the engine. Avoid high RPMs while doing this.

### Have maintenance performed regularly

By having maintenance performed regularly on your vehicle, you can help to reduce fuel consumption before you even start to drive. The maintenance condition of your vehicle not only affects traffic safety and long-term value but also impacts **fuel consumption**. A poorly maintained engine can lead to fuel consumption that is 10% higher than normal.

Also check the **oil level** when refueling. The **oil consumption** depends largely on the engine load and speed. It is normal for the oil consumption of a new engine to reach its lowest point only after a certain amount of use. Therefore, the oil consumption can only be properly judged after

approximately 3,000 miles (5,000 km) have been driven.

### Avoid short trips

The engine and exhaust cleaning system must reach their optimal **operating temperature** to effectively reduce consumption and emissions.

A cold engine uses a disproportionately high amount of fuel. The engine reaches operating temperature and consumption normalizes only after approximately 2.5 miles (4 km).

### Check the tire pressure

To save fuel, make sure the tires are always inflated to the correct pressure ⇒ *page 175*. The fuel consumption can increase by 5% if the pressure is only 0.5 bar too low. Due to the increased rolling resistance, low tire pressures will also lead to greater tire **wear** and will affect driving behavior.

Do not drive on **winter tires** year-round, as this will consume up to 10% more fuel.

### Eliminate unnecessary weight

Since every pound of extra **weight** increases fuel consumption, a quick inspection of the luggage compartment may be worth it to avoid unnecessary weight.

When not being used, a roof rack should be removed to decrease the wind resistance of the vehicle. This will save you approximately 12% fuel at speeds from 62 - 75 mph (100 - 120 km/h).

### Save energy

The engine drives the generator, which generates electricity; the fuel consumption also increases with the demand for electricity. Therefore, switch electrical equipment off when you no longer need it. Examples of equipment that uses a lot of energy are air blowers at a high setting, the rear window defogger and seat heating\*.

#### Note

- Do not leave engine idling unattended after starting. If warning lights should come on to indicate improper operation, they would go unheeded. Extended idling also produces

heat, which could result in overheating or other damage to the vehicle or other property.

- Have your vehicle maintained properly and in accordance with the service recommendations in your Warranty & Maintenance booklet. Lack of proper maintenance as well as improper use of the vehicle will impair the function of the emission control system and could lead to damage.
- Do not alter or remove any component of the Emission Control System unless approved by the manufacturer.
- Do not alter or remove any device, such as heat shields, switches, ignition wires, valves, which are designed to protect your vehicle's Emission Control System and other important vehicle components.

### **i** Tips

The consumption estimates as published by ENVIRONMENTAL PROTECTION AGENCY (EPA) and Transport Canada may not correspond to your actual consumption on the road, which will vary depending upon vehicle load and speed, road and weather conditions, trip length, etc.

## Steering

### Adjusting the steering wheel position

*The steering wheel position is adjustable up and down and forward and back.*



Fig. 67 Lever under the steering column

- ▶ Tilt the lever downward ⇒ .
- ▶ Bring the steering wheel into the desired position.

- ▶ Press the lever upward again until it locks in place.

### WARNING

Incorrect use of the steering wheel adjustment and an incorrect seating position can cause serious injuries.

- Only adjust the steering column when the vehicle is stationary so that you do not lose control of the vehicle.
- Adjust the driver's seat or steering wheel so that there is at least 10 inches (25 cm) distance between your chest and the steering wheel ⇒ *page 98, fig. 98*. If you do not maintain this distance, the airbag system will not be able to provide its full protection. ⇒ *page 98, fig. 98*.
- If your physical characteristics prevent you from sitting at least 10 inches (25 cm) or more away from the steering wheel, see if an authorized Audi dealer or authorized Audi Service Facility can provide adapters that will help.
- If your face is level with the steering wheel, the airbag does not provide as much protection during a collision. Always make sure that the steering wheel is level with your chest.
- Always hold the steering wheel with your hands in the 9 o'clock and 3 o'clock positions to reduce the risk of injury if the airbag deploys.
- Never hold the steering wheel in the 12 o'clock position or with both hands on the rim or the center of the steering wheel. Holding the steering wheel incorrectly significantly increases the risk of injury to the hands, arms and head if the airbag deploys.

## Starting and stopping the engine (vehicles with an ignition lock)

### Starting the engine

Applies to: vehicles with ignition lock

The ignition is switched on and the engine started with the key in the ignition.

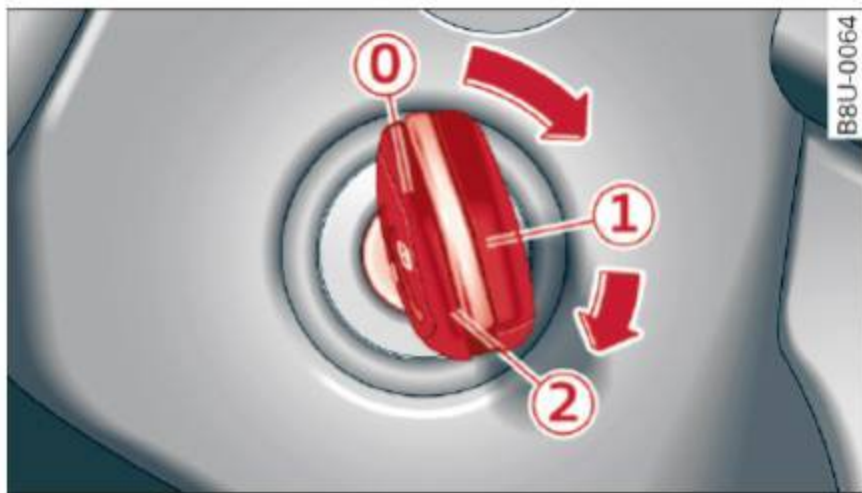

Fig. 68 Ignition lock: position of the ignition key

### Switching the ignition on/off

- ▶ To switch the ignition on, turn the ignition key to position ①.
- ▶ To switch the ignition off, turn the ignition key to position ②.

### Starting the engine

- ▶ Press the brake pedal and move the selector lever to the P or N position.
- ▶ Turn the key to position ②. The ignition key automatically returns to position ①. Do not press the accelerator pedal when doing this.

Equipment that uses a lot of electricity is switched off temporarily when you start the engine.

If the engine does not start immediately, stop the starting procedure by turning the ignition key to position ② and repeat after 30 seconds.

#### WARNING

- To reduce the risk of poisoning, never allow the engine to run in confined spaces.
- Never remove the ignition key from the ignition lock while the vehicle is moving. Otherwise the steering lock will engage and you will not be able to steer the vehicle, which increased the risk of an accident.

#### Note

Avoid high engine speed, full throttle, and heavy engine load if the engine has not reached operating temperature yet. You could damage the engine.

#### For the sake of the environment

Do not let the engine run while parked to warm up. Begin driving immediately. This reduces unnecessary emissions.

#### Tips

- If it is difficult to turn the key to position ①, turn the steering wheel back and forth slightly to release the steering wheel lock.
- Some noise after starting the engine is normal and is no cause for concern.

### Stopping the engine

Applies to: vehicles with ignition lock

#### Stopping the engine

- ▶ Bring the vehicle to a full stop.
- ▶ Turn the key to position ② ⇒ page 60, fig. 68.

#### Engaging the steering lock

Requirement: the selector lever must be in P.

- ▶ Remove the ignition key in position ② ⇒ page 60, fig. 68 ⇒ .
- ▶ Turn the steering wheel until you hear the steering wheel lock.

The locked steering helps prevent vehicle theft.

#### WARNING

- Never turn off the engine before the vehicle has come to a complete stop. The full function of the brake booster and the power steering is not guaranteed. You must use more force to turn or brake. Because you cannot steer and brake as you usually would, this could lead to accidents and serious injuries.
- Never remove the ignition key from the ignition lock while the vehicle is moving. Otherwise the steering lock will engage and you will not be able to steer the vehicle.

- Always take the key with you whenever you leave your vehicle. Otherwise, the engine could be started or electrical equipment such as the power windows could be operated. This can lead to serious injury.
- For safety reasons, always park the vehicle with the selector lever in the P position. Otherwise, there is the risk that the vehicle could roll unintentionally.

### ! Note

If the engine has been under heavy load for an extended period of time, heat builds up in the engine compartment after the engine is switched off and there is a risk of damaging the engine. For this reason, let the engine run for at idle for approximately two minutes before shutting it off.

### i Tips

For up to 10 minutes after stopping the engine, the radiator fan may turn on again automatically or it may continue to run (even if the ignition is switched off) for the following reasons:

- The coolant temperature is increasing due to trapped heat.
- If the engine is warm and the engine compartment also heats up from strong sunlight.

## Starting and stopping the engine (vehicles with a convenience key)

### Starting the engine

Applies to: vehicles with convenience key

The **START ENGINE STOP** button switches the ignition on and starts the engine.

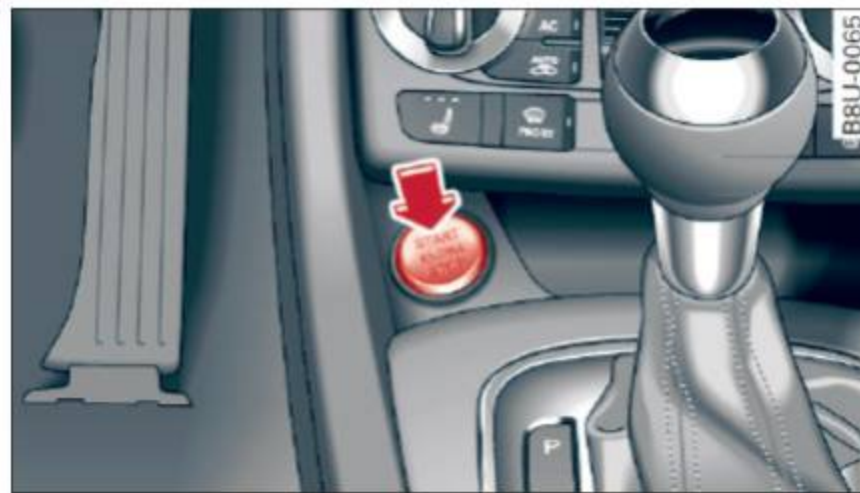

Fig. 69 Center console: START ENGINE STOP button

### Starting the engine

- ▶ Press the brake pedal and move the selector lever to the P or N position.
- ▶ Press the **START ENGINE STOP** button. The engine will start.

If the engine does not start immediately, stop the starting procedure by pushing the **START ENGINE STOP** button again and repeat after 30 seconds.

### Switching the ignition on/off

If you would like to switch the ignition on without starting the engine, follow these steps:

- ▶ Press the **START ENGINE STOP** button **without** pressing the brake pedal.
- ▶ To switch the ignition off, press the button again.

### ! WARNING

To reduce the risk of poisoning, never allow the engine to run in confined spaces.

### ! Note

Avoid high engine speed, full throttle, and heavy engine load if the engine has not

reached operating temperature yet. You could damage the engine.

### For the sake of the environment

Do not let the engine run while parked to warm up. Begin driving immediately. This reduces unnecessary emissions.

### Tips

Some noise after starting the engine is normal and is no cause for concern.

## Stopping the engine

Applies to: vehicles with convenience key

- ▶ Bring the vehicle to a full stop.
- ▶ Move the selector lever into the P position.
- ▶ Press the **START ENGINE STOP** button  
⇒ page 61, fig. 69.

### Engaging the steering lock<sup>1)</sup>

The steering locks when you turn the engine off using the **START ENGINE STOP** button and open the driver's door.

The locked steering helps prevent vehicle theft.

### Emergency off function\*

If it is absolutely necessary, the engine can also be turned off while driving at speeds starting at 4 mph (7 km/h). To switch the engine off, press the **START ENGINE STOP** button twice in a row briefly or press and hold for longer than two seconds.

### WARNING

- Never turn off the engine before the vehicle has come to a complete stop. The brake booster and power steering only work when the engine is running. If the engine is off, you have to use more force when steering or braking. Because you cannot steer and brake as you usually would, this could lead to accidents and serious injuries.
- Always take the key with you whenever you leave your vehicle. Otherwise, the engine

could be started or electrical equipment such as the power windows could be operated. This can lead to serious injury.

- For safety reasons, always park the vehicle with the selector lever in the P position. Otherwise, there is the risk that the vehicle could roll unintentionally.

### Note

If the engine has been under heavy load for an extended period of time, heat builds up in the engine compartment after the engine is switched off and there is a risk of damaging the engine. For this reason, let the engine run for at idle for approximately two minutes before shutting it off.

### Tips

For up to 10 minutes after stopping the engine, the radiator fan may turn on again automatically or it may continue to run (even if the ignition is switched off) for the following reasons:

- The coolant temperature is increasing due to trapped heat.
- If the engine is warm and the engine compartment also heats up from strong sunlight.

<sup>1)</sup> This function is not available in all countries.



## Starting the engine when there is a malfunction

Applies to: vehicles with convenience key

Other circumstances can cause the engine not to start, such as the battery in the remote control key has drained, there is interference with the key or there is a system malfunction.

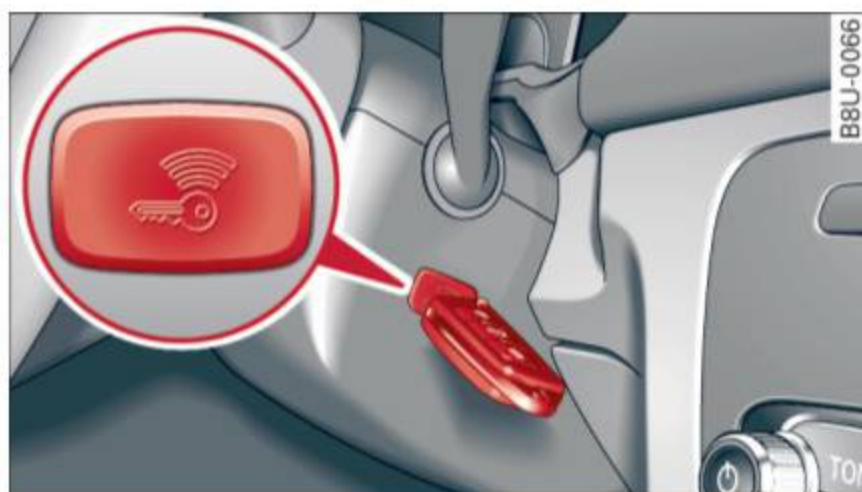



Fig. 70 Steering column/remote control key: starting the engine if there is a malfunction

Requirement: the message **No key identified.** See owner's manual must be displayed and the  indicator light must be on.

- ▶ Hold the remote control key vertically in the location indicated  ⇒ fig. 70.
- ▶ Press the brake pedal.
- ▶ Press the **START ENGINE STOP** button. The engine will start.
- ▶ Drive to an authorized Audi dealer or authorized Audi Service Facility immediately to have the malfunction corrected.

### Tips

You can view the message again by pressing the **START ENGINE STOP** button.

## Messages

### Turn off ignition. Battery discharging

This message appears and a warning tone sounds if you open the driver's door when the ignition is switched on.

### Press brake pedal to start engine

This message appears if you do not step on the brake pedal to start the engine on a vehicle with an automatic transmission.

### Please engage N or P.

This message appears when starting or stopping the engine if the selector lever is not in the N or P position. The engine will not start/stop.

### Is key in the vehicle?

The indicator light turns on and this message appears if the convenience key\* was removed from the vehicle when the engine was running. If the convenience key is no longer in the vehicle, you cannot switch the ignition on or start the engine once you stop it. You also cannot lock the vehicle from the outside.

### Shift to P, vehicle can roll away. Doors can only be locked in P.

This message appears for safety reasons if the selector lever for the automatic transmission is not in the P position after the ignition is switched off. Move the selector lever to the P position. Otherwise the vehicle is not protected from rolling and it cannot be locked.

### No key identified. See owner's manual.

This message appears if there is no convenience key\* inside the vehicle or if the system does not recognize the key. The convenience key may not be recognized, for example, if it is covered by an object that *disrupts* the signal (such as a briefcase), or if the key battery is weak. Electronic devices such as cell phones can also interfere with the signal.

To still be able to start or stop the engine, refer to ⇒ page 63.



## Electromechanical parking brake



Fig. 71 Center console: parking brake

Your vehicle is equipped with an electromechanical parking brake  ⇒ *fig. 71*. The parking brake is designed to prevent the vehicle from rolling unintentionally and replaces the hand brake.

### Setting/manually releasing the parking brake

- ▶ Pull the  switch to set the parking brake. The LED in the switch turns on. The **PARK** (USA models)/ (Canada models) indicator light also turns on in the instrument cluster display.
- ▶ To release the parking brake manually, press the brake or accelerator pedal while the ignition is switched on and press the  switch at the same time. The LED in the button and the indicator light in the display turn off.

### Releasing the parking brake automatically



Requirement: the driver's door must be closed, the driver's safety belt must be latched and the parking brake must be set.

- ▶ To start driving and release the parking brake automatically, press the accelerator pedal as usual.

In addition to releasing the parking brake automatically, other convenience and safety functions are available when you start driving ⇒ *page 65, Starting from a stop*.



### Preventing the automatic parking brake release



The vehicle could begin rolling unintentionally, depending on the hill or if towing a trailer.



- ▶ To prevent the parking brake from releasing automatically, pull and hold the  switch and press the accelerator pedal. The parking brake remains set and prevents the vehicle from rolling backward.
- ▶ You can release the  switch again once you are sure that you are giving enough driving force to the wheels by pressing the accelerator pedal.

### Emergency braking function



You can use the emergency braking function in an emergency situation, or if the standard brake operation malfunctions or is disabled.

- ▶ Pull and hold the  switch.
- ▶ As soon as you release the  switch or accelerate, the braking stops.

Pulling and holding the  switch while driving the vehicle activates the emergency braking function. The vehicle is braked at all four wheels by activating the hydraulic brake system. The braking effect is similar to heavy braking ⇒ .

To reduce the risk of activating the emergency braking by mistake, a warning tone (buzzer) sounds when the  switch is pulled. Emergency braking stops as soon as the  switch is released or the accelerator pedal is pressed.

### Parking

- ▶ Press the brake pedal to stop the vehicle.
- ▶ Pull the  switch to set the parking brake.
- ▶ Place the selector lever in the P position.
- ▶ Turn the engine off ⇒ .
- ▶ Turn the steering wheel when parking on inclines so that the wheels will roll into the curb if the vehicle starts moving.

### WARNING

- Do not press the accelerator pedal inadvertently if a gear is selected when the vehicle is stationary and the engine is running. Otherwise, the vehicle will start to move immediately and this could result in an accident.
- Emergency braking should only be used in an emergency, when the normal brake pedal has failed or the brake pedal is obstructed. During emergency braking, your vehicle will brake similar to heavy braking. ESC and the associated components (ABS, ASR, EDL) cannot overcome the laws of physics. Around curves and when road or weather conditions are bad, a full brake application can cause the vehicle to skid or the rear end to swerve, which increases the risk of an accident.
- If the power supply fails, you cannot set the parking brake if it is released. In this case, park the vehicle on level ground and secure it by placing the selector lever in the P position. See an authorized Audi dealer or authorized Audi Service Facility for assistance.

- Always take the vehicle key with you when leaving your vehicle, even if for a short period of time. This applies particularly when children remain in the vehicle. Otherwise, children could start the engine, release the parking brake or operate electrical equipment such as power windows, which increases the risk of an accident.
- No one, especially children, should remain in the vehicle when it is locked. Locked doors make it more difficult for emergency workers to get into the vehicle, which puts lives at risk.

### Tips

- When stopping at a traffic signal or stopping in city traffic, you can set the parking brake manually. The vehicle does not have to be held with the brake pedal. The parking brake eliminates the tendency to creep when a selector lever position is engaged. As soon as you press the accelerator pedal, the parking brake releases automatically and your vehicle starts to move ⇒ *page 65*.
- Occasional noises when the parking brake is set and released are normal and are not a cause for concern.
- The parking brake goes through a self-test cycle at regular intervals when the vehicle is stopped. Any noises associated with this are normal.
- If there is a power failure, the parking brake will not set if it is released, and it will not release if it is set ⇒ . See an authorized Audi dealer or authorized Audi Service Facility for assistance.

## Starting from a stop

Various convenience and safety functions may be available when the vehicle begins driving, depending on vehicle equipment.

### Starting on hills with the parking brake set

Requirement: the driver's door must be closed.

- ▶ To start driving comfortably when on a hill, set the parking brake and begin driving as usual.

The braking force of the parking brake does not release automatically until the wheels build up enough driving force.

### Starting on hills with hill hold assist

Hill hold assist makes it easier to start on hills.

Requirement: the driver's door must be closed and the engine must be running.

- ▶ To activate hill hold assist, press and hold the brake pedal for several seconds. The vehicle must be in an uphill direction of travel.

After releasing the brake pedal, the braking power is maintained for a brief moment ⇒  to prevent the vehicle from rolling back when starting. During this time, you can easily begin to move your vehicle.

### WARNING

Applies to: vehicles with hill hold assist

- If you do not begin driving immediately or the engine stalls after releasing the brake pedal, your vehicle may begin to roll backward. Press the brake pedal or set the parking brake immediately.
- The intelligent technology of hill hold assist cannot overcome the limitations imposed by natural physical laws. The increased comfort offered by hill hold assist should not cause you to take safety risks.
- Hill hold assist cannot hold the vehicle in place on all hills (for example, if the ground is slippery or icy).
- To reduce the risk of an accident, always make sure the vehicle is situated safely while stationary.

## Driving offroad

### General information

Applies to: vehicles with offroad mode

The electronic stabilization control (ESC) functions were enhanced for driving offroad. ESC offroad mode can be activated in driving situations in which a wheel lock or a differential lock function is needed ⇒ *page 90*. The hill descent assist is also available, which automatically brakes ▶

the vehicle and maintains a constant speed as a result ⇒ *page 91*.

**However, your Audi is not an offroad vehicle. Only drive in terrain that is suitable for the vehicle and your driving ability. Never take any unnecessary risks!**

### After driving offroad

- After driving offroad, remove branches and other debris from the radiator grille, underbody, and wheels. Look especially for foreign objects (such as stones) that may be stuck in the tire tread.
- Clean the vehicle body and underbody and inspect the vehicle for possible damage.
- Clean the windows, headlights, tail lights and the license plate if they are dirty.
- Perform a brake test (especially after driving through water).

### **WARNING**

- Be especially aware and attentive when driving under difficult conditions. Vehicle damage and injuries may occur when driving at excessively high speeds or with incorrect driving maneuvers.
- Always adjust your speed and driving style to the roads, terrain, traffic and weather conditions. Drive especially slowly if there is low visibility when offroad.
- Please note that the wheels can spin more and the vehicle can swerve when in ESC offroad mode, especially when the road is slippery or has loose surface material.
- Driving stability is reduced in the ESC Offroad mode.

### **For the sake of the environment**

Avoid harming the environment and show consideration for nature.

### **Tips**

Only drive where it is allowed and always stay on the provided roads and paths.

## Driving information

Applies to: vehicles with offroad mode

*There is only one right way to drive in difficult conditions: slowly and with caution!*

Observe the following when driving on unpaved roads:

- ▶ Only drive in terrain that is suitable for the vehicle and your driving ability. Never take any unnecessary risks!
- ▶ Drive slowly and cautiously!
- ▶ Pay attention to the **ground clearance** of your vehicle. The clearance may vary depending on the load, ground composition and the environment. The ground clearance is reduced for special suspension systems, such as sport suspension. The driver is therefore responsible for deciding whether a vehicle can handle a specific situation.
- ▶ Activate the **ESC offroad mode** as needed ⇒ *page 90*.
- ▶ Use the **hill descent assist** when driving down steep hills ⇒ *page 91*.

### Difficult terrain

When driving in unfamiliar areas and offroad, drive slowly and keep on the watch for unexpected obstacles (such as potholes, rocks, tree stumps, etc.).

To prevent the vehicle from bottoming out and to reduce the risk of underbody damage, you should drive across uneven ground on only one side of the vehicle so that only two of your wheels cross the uneven area, instead of driving across the center of the uneven area with all four wheels.

Drive quickly through sandy or marshy off-road sections and do not stop, if at all possible.

### Driving through water on roads

Also read the information found in ⇒ *page 57*.

## Automatic transmission

### Introduction

The automatic transmission is controlled electronically. Upshifting and downshifting occur automatically. ▶

When a **moderate driving style** is used, the transmission selects the most economical driving mode. The transmission upshifts at a lower RPM and downshifts at a higher RPM to improve fuel efficiency.

The transmission switches to a sporty mode after a kick-down or when the driver uses a **sporty driving style** characterized by quick accelerator pedal movements, heavy acceleration, frequent changes in speed and traveling at the maximum speed.

If desired, the driver can also select the gears *manually (tiptronic mode)* ⇒ page 70, *Manual shifting (tiptronic mode)*.

Power is transferred using a torque converter.

### Selector lever positions

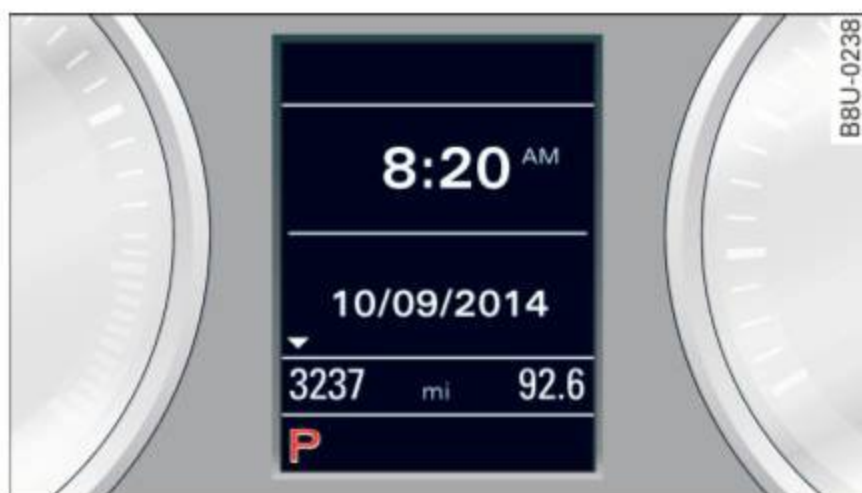

Fig. 72 Instrument cluster: selector lever positions



Fig. 73 Selector lever

The selected selector lever position is shown next to the selector lever ⇒ fig. 73 and in the instrument cluster display ⇒ fig. 72. The current gear will also be displayed in the instrument cluster.

- ▶ Switch the ignition on.
- ▶ In the P/N position, you must release the selector lever lock ⇒ page 67.

- ▶ Move the selector lever into the desired position. The engaged selector lever position is shown in the shift gate.

### Selector lever lock

The selector lever lock prevents you from selecting a gear accidentally, causing the vehicle to roll.

The selector lever is locked in the P and N positions when the ignition is switched on. You must press the brake pedal to select another position. You must also press the interlock button if you are moving from the P and N position.

The selector lever lock only functions when the vehicle is stationary or at speeds below approximately 1 mph (2 km/h). At higher speeds, the lock is automatically deactivated in the N position.

The selector lever is not locked when shifting quickly through N, for example from R to D/S. This makes it possible to free the vehicle when it is stuck by “rocking” it. The selector lever lock engages if the lever stays in the N position longer than approximately 2 seconds when the brake pedal is not pressed.

If the selector lever does not engage, there is a malfunction. The engine is disabled to prevent the vehicle from driving off unintentionally. Press the brake pedal to have the selector lever lock engage again. Place the selector lever in the P or N position and then engage a driving gear.

### Ignition key safety interlock\*

Applies to: vehicles with ignition lock

You can only remove the key from the ignition after switching the ignition off if the selector lever is in the P position. The selector lever will be locked in the P position as long as the key is not in the ignition.

### Interlock button

The interlock button in the selector lever handle prevents you from moving the selector lever inadvertently while in some selector lever positions. The positions that require the interlock button to be pressed are marked in color in the illustration ⇒ fig. 73.

### P - Park

This selector lever position prevents the vehicle from rolling. You can only shift into Park when the vehicle is *stationary* ⇒ ⚠.

To shift in and out of the P selector lever position, press the interlock button in the selector lever *while* pressing the brake pedal.

### R – Reverse

Only shift into reverse gear when the vehicle is *stationary* and the engine is running at idle speed ⇒ ⚠.

To select the R selector lever position, press the interlock button *while* pressing the brake pedal.

### N - Neutral

The transmission is in idle in this position.

To engage the N selector lever position, press the button on the selector lever and shift into the N position.

To move from selector lever position out of N, you must press the brake pedal and the vehicle must be traveling less than 1 mph (2 km/h) or be stationary.

### D/S - Normal position for driving forward

In the D/S selector lever position, the transmission can be operated either in the normal D mode or in the S sport mode. To select the S sport mode, pull the selector lever back briefly. Pulling the lever back again will select the normal D mode. The instrument cluster display shows the selected driving mode.

In the **normal mode** D, the transmission automatically selects the suitable gear ratio. It depends on engine load, vehicle speed and driving style.

The engine's power reserves are used fully in the **Sport mode** S. Shifting may become noticeable when accelerating.

To move from selector lever position N to D, you must press the brake pedal and the vehicle must be traveling less than 1 mph (2 km/h) or be stationary ⇒ ⚠.

### ⚠ WARNING

Read and follow all WARNINGS.

- The vehicle can roll even if the ignition is switched off.
- Never select R or P while driving, because this increases the risk of an accident.
- Power is still transmitted to the wheels when the engine is running at idle. To prevent the vehicle from “creeping”, you must keep your foot on the brake in all selector lever positions (except P) when the engine is running.
- Do not inadvertently press the accelerator pedal when the vehicle is stopped if a gear is engaged. Otherwise, the vehicle will immediately start to move - sometimes even if the parking brake is firmly applied. This increases the risk of an accident.
- To reduce the risk of an accident, do not press the accelerator pedal when changing the selector lever position while the vehicle is stationary and the engine is running.
- Never leave your vehicle with the engine running while in gear. If you must leave your vehicle when the engine is running, set the parking brake and move the selector lever to the P position.
- Before you or other persons open the hood and work on a running engine, the selector lever must be in the P position and the parking brake must be applied to reduce the risk of an accident. Always read and follow the applicable warnings ⇒ *page 155, Working in the engine compartment.*
- Read and following all WARNINGS ⇒ ⚠ *in Driving tips on page 69.*

### ⓘ Note

Never let the vehicle roll downhill with engine off and the selector lever in the N position, because this could damage the automatic transmission and catalytic converter.

### ⓘ Tips

- If you accidentally select N while driving, take your foot off the accelerator pedal and

wait for the engine to slow down to idle before selecting D or S.

- If there is a power failure, the selector lever will not move out of the P position. The emergency release can be used if this happens ⇒ *page 72*.

## Driving tips

### Starting the engine



- ▶ The selector lever must be in the P or the N position.

### Starting from a stop

- ▶ Press and hold the brake pedal.
- ▶ Press and hold the lock button in the selector lever handle, select the desired selector lever position such as D ⇒ *page 67* and release the lock button.
- ▶ Wait a moment until the transmission shifts. You will notice a slight movement when the gear engages.
- ▶ Release the brake pedal and press the accelerator pedal ⇒ .

Various convenience functions are available for starting on hills ⇒ *page 65*.

### Stopping temporarily

- ▶ Press the brake pedal to stop the vehicle, for example at a traffic light. Do not press the accelerator pedal when doing this.
- ▶ To prevent the vehicle from rolling when you start driving, set the parking brake when stopping on steep hills ⇒  and ⇒ .
- ▶ The parking brake will release automatically and the vehicle will start moving once you press the accelerator pedal.

### Stopping/parking

If the selector lever is not in the P position when you open the driver's door, the vehicle could roll. In vehicles with a convenience key\*, the message **Shift to P and turn off ignition, or vehicle can roll away** appears.

- ▶ Press and hold the brake pedal ⇒ .
- ▶ Set the parking brake.
- ▶ Select the P selector lever position.



Under certain circumstances, (such as driving in the mountains or towing a trailer), it may be useful to switch temporarily to the manual shift program in order to adjust the gears to the driving conditions by hand ⇒ *page 70*.

On inclines, activate the parking brake first and then move the selector lever to the P position ⇒ *page 64*. This prevents the locking mechanism from being loaded too heavily and will make it easier to move the selector lever out of the P position.

## WARNING

- The vehicle can roll even when the engine is switched off.
- Unintended vehicle movement can lead to serious injuries.
- Never leave your vehicle with the engine running while in gear. If you must leave your vehicle when the engine is running, set the parking brake and move the selector lever to the P position.
- Power is still transmitted to the wheels when the engine is running at idle. To prevent the vehicle from “creeping”, you must keep your foot on the brake in all selector lever positions (except P) when the engine is running.
- Do not inadvertently press the accelerator pedal when the vehicle is stopped if a gear is engaged. Otherwise the risk of an accident increases because the vehicle will start to move immediately, even if the parking brake is set.
- To reduce the risk of an accident, do not press the accelerator pedal when changing the selector lever position while the vehicle is stationary and the engine is running.
- Never engage the R or P selector level positions while driving. It could cause a crash.
- Before driving down a steep slope, reduce your speed and shift into a lower gear in tiptronic mode.
- Do not ride the brakes or press the brake pedal too often or too long when driving downhill. Constant braking causes the brakes to overheat and substantially

reduces braking performance, increases braking distance or causes complete failure of the brake system.

- If you must stop on an incline, always hold the vehicle in place with the foot brake or parking brake to prevent it from rolling back.
- Never hold the vehicle on an incline with a slipping clutch. The clutch opens automatically when it becomes too hot from the overload. The  indicator light turns on and a message appears ⇒ *page 71* when the clutch is overloaded.
- Read and following all WARNINGS ⇒ .

 **Note**

- When stopping on an incline, do not try to hold the vehicle in place by pressing the accelerator pedal while a driving gear is selected. This can cause the automatic transmission to overheat and can damage it. Set the parking brake or press the brake pedal to prevent the vehicle from rolling.
- Allowing the vehicle to roll when the engine is stopped while the selector lever is in the N position will damage the automatic transmission, because it is not lubricated under those circumstances ⇒ *page 205, Towing with a tow truck*.
- The transmission can overheat and be damaged under certain driving and traffic conditions such as frequent starts, creeping for a long time, or stop-and-go traffic. If the  indicator light turns on, stop the vehicle at the next opportunity and let the transmission cool down ⇒ *page 71*.

**Hill descent control**

*The hill descent control system assists the driver when driving down hills.*

Hill descent control is activated when the selector lever is in the D or S position and you press the brake pedal. The transmission automatically selects a gear that is suitable for the hill. Hill descent control tries to maintain the speed achieved at the time of braking, within physical and

technical limitations. If may still be necessary to adjust the speed with the brake pedal.

Hill descent control switches off once the hill levels out or you press the accelerator pedal.

 **WARNING**

Hill descent control cannot overcome physical limitations, so it may not be able to maintain a constant speed under all conditions. Always be ready to apply the brakes.

**Manual shifting (tiptronic mode)**

*The tiptronic mode allows the driver to shift the gears manually.*



**Fig. 74** Center console: shifting manually with the selector lever

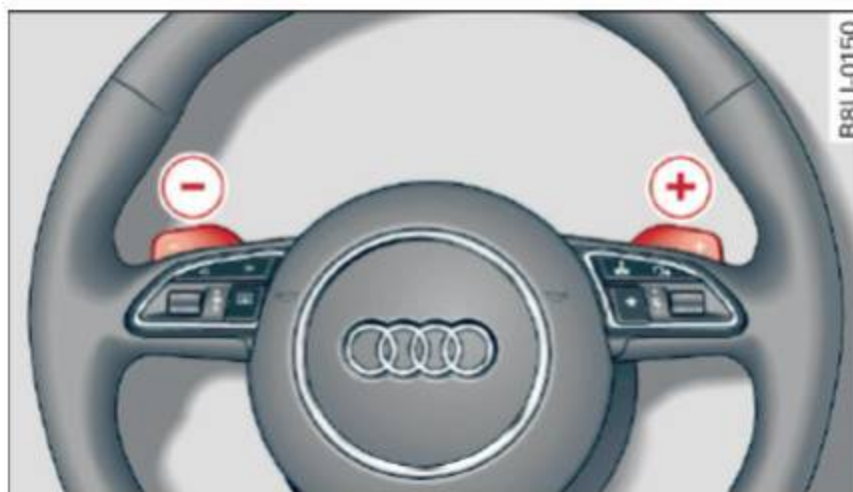

**Fig. 75** Steering wheel: shifting manually with the shift paddles\*



**Shifting with the selector lever**

You can shift into tiptronic mode while stationary and while driving.

- ▶ To shift into tiptronic mode, push the selector lever from the D/S setting to the right in the tiptronic shift gate. Once the transmission has switched modes, the selector lever position **M** is shown in the instrument cluster display ▶





⇒ page 67, fig. 72. For example, **M4** means the fourth gear is engaged.

- ▶ To shift up a gear, tap the selector lever forward  ⇒ fig. 74.
- ▶ To shift down a gear, tap the selector lever to back .

### Shifting with the shift paddles\*

You can operate the shift paddles in the D/S or **M** (tiptronic shift gate) selector lever positions.

- ▶ To shift up one gear, tap the shift paddle  ⇒ fig. 75.
- ▶ To shift down one gear, tap the shift paddle .

If the shift paddles are tapped while in the D/S selector lever position, automatic mode switches off briefly. To switch from manually shifting back to automatic shifting immediately, tap the shift paddle  ⇒ fig. 75 for 1 second.

To keep shifting using the shift paddles, move the selector lever to the right out of the D/S position into the tiptronic shift gate.

### Description

The transmission automatically shifts up or down before critical engine speed is reached.

The transmission only allows manual shifting when the engine speed is within the permitted range.

### Kick-down

*Kick-down enables maximum acceleration.*

When you press the accelerator pedal down beyond the resistance point (called kick-down), the automatic transmission downshifts into a lower gear, depending on vehicle speed and engine RPM. It shifts up into the next higher gear once the maximum specified engine RPM is reached.



### WARNING

Please note that the wheels could spin on slick or slippery roads when kick-down is active.

### Emergency mode

Applies to: vehicles with automatic transmissions

*In the event of a system malfunction, there is an emergency program.*

If all of the selector lever positions are highlighted with a light background in the instrument cluster display, there is a system malfunction and the S tronic transmission is running in the emergency program. The vehicle can still be driven in emergency mode, but only with reduced speed and not in all gears. In some cases, the vehicle **cannot drive in reverse.**



### Note

If the transmission runs in emergency mode, drive to an authorized Audi dealer or authorized Audi Service Facility immediately to have the malfunction corrected.

### Transmission malfunction

Applies to: vehicles with automatic transmissions



### Transmission overheating! Please stop vehicle!

The transmission is too hot and can become damaged. Stop and let the transmission cool with the engine running (at idle) in the P selector lever position. Then the indicator light and the message turn off, drive to an authorized Audi dealer or authorized Audi Service Facility immediately to have the malfunction corrected. If the indicator light and the driver message do not turn off, do not continue driving. See an authorized Audi dealer or authorized Audi Service Facility for assistance.

### Selector lever emergency release

Applies to: vehicles with automatic transmissions

*If the vehicle's power supply fails, the selector lever can be released in an emergency.*



Fig. 76 Selector lever: removing the cover



Fig. 77 Selector lever: emergency release

To maneuver or tow the vehicle, the emergency release must be used to move the selector lever from the P position.

Using the emergency release can be complicated. We recommend contacting an authorized Audi dealer or authorized Audi Service Facility for assistance, if necessary.

A maintenance tool from the vehicle tool kit must be used to release ⇒ *page 191*.

### Preparations

- ▶ To prevent your vehicle from rolling unintentionally, set the parking brake (P) or press the brake pedal ⇒ .
- ▶ Insert the flat side of the maintenance tool sideways in the slot near the shift cover and pry off the shift cover ⇒ *fig. 76*.
- ▶ Pull the frame and the cover upward. You can fold the cover up over the shifter knob.

### Selector lever emergency release

- ▶ Press and hold the yellow release button ⇒ *fig. 77*.
- ▶ Press the button on the selector lever and move the lever into N position.
- ▶ Clip the frame to the cover again.

#### WARNING

- Only activate the emergency release while on a level surface or a slight slope.
- Only move the selector lever out of the P position when the parking brake is set. If it is not functioning, secure the vehicle from rolling using the brake pedal or other suitable means, such as blocking a front and a rear wheel. An unsecured vehicle may roll away, which increases the risk of an accident.

## Trailer towing

### Driving with a trailer

#### General information

Your vehicle is primarily intended for transporting people and luggage. However, if you drive with a trailer, follow the technical requirements, the operation and driving tips, and the legal regulations.

Driving with a trailer affects the vehicle's fuel consumption, performance and wear. It also requires higher concentration from the driver.

#### WARNING

Do not transport any people in a trailer due to the risk of fatal injury.

#### Technical requirements

*Certain requirements must be met when towing a trailer.*

#### Trailer hitch

Only use a trailer hitch with a removable ball hitch mount and ball hitch. The trailer hitch must be permitted for the vehicle, the trailer and the permitted total weight of the trailer being pulled. Above all, it must be securely and safely attached to the vehicle trailer.

Never mount a trailer hitch on the bumper. The trailer hitch must be mounted in a way that does not impair the function of the bumper. Do not make any changes to the exhaust system and the brake system.

Check regularly if the trailer hitch is securely mounted. Always follow the instructions given by the trailer hitch manufacturer.

#### Trailer brakes

If the trailer has its own brake system, then follow the manufacturer specifications. However, the brake system on the trailer must never be connected to the vehicle brake system.

#### Engine cooling system

Driving with a trailer means a higher load on the engine and the cooling system. The cooling system must be designed for additional load and contain enough coolant ⇒ .

#### WARNING

- Never mount a "weight-distributing" or "load-balancing" trailer coupler as the trailer hitch. The vehicle was not designed for these types of trailer hitches. The trailer hitch can malfunction and the trailer can break off from the vehicle.
- If the trailer is equipped with electronic brakes, these brakes cannot be activated by a factory-installed control system, which increases the risk of an accident.
- To reduce the risk of injury, always remove the ball hitch mount if no trailer is mounted.

#### Note

Longer inclines cannot be driven without a suitable cooling system, especially if the outside temperatures are high. otherwise, this increases the risk of engine damage.

#### Operating instructions

*Several things must be noted when towing a trailer.*

#### Towing capacity

The permitted towing capacity for trailers without brakes is 1,650 lbs (750 kg).

The permitted towing capacity for trailers with brakes is 2,200 lbs (1,000 kg).

These values apply to roads with up to 12% incline.

#### Tongue weight

The maximum permitted tongue weight of the trailer drawbar on the trailer hitch ball head may not be exceeded. ►

## Trailer towing

If the tongue weight is too low, this affects the trailer's handling. For driving safety, we recommend to always utilize the maximum permitted tongue weight, but not exceed it. You can reach it, for example, by distributing the cargo in the trailer correctly.

You can determine the tongue weight, for example, with a bathroom scale or a public weigh station.

The permitted tongue weight for your vehicle is 220 lbs (100 kg).

### Load distribution

Poor cargo load and distribution can negatively impact vehicle handling. To have the lowest impact as possible, load the trailer according to these criteria:

- Store objects preferably in the vehicle luggage compartment. The vehicle should always carry the heaviest possible load and the trailer should have the lightest possible load.
- Distribute the load in the trailer so that the heavy objects are as close to the axle as possible.
- Secure objects from sliding out of place.
- Utilize the maximum permitted tongue weight if possible.

### Tires

Set the tire pressure on your vehicle for a “full load”; see the tire pressure sticker ⇒ *page 176*. If necessary, also adjust the tire pressure on the trailer according to the manufacturer's recommendation.

Winter tires should be mounted on the vehicle and on the trailer during winter temperatures.

### Outside mirrors

If you cannot see the traffic behind the trailer with the standard exterior mirrors, then you must attach additional exterior mirrors. Adjust them so you have a sufficient visibility behind you.

### Exterior lighting

Follow the legal regulations regarding the lighting equipment on your trailer. Contact an author-

ized Audi dealer or authorized Audi Service Facility for more information.

Before starting to drive, check all lighting equipment on the hitched trailer.

The headlight range control adjusts automatically to the light range of the headlights.

### Safety chains

Make sure the safety chains are correctly applied when pulling a trailer. The chains should hang enough so that the trailer can drive around curves. However, they must not touch the ground.

#### Tips

- Use chocks when parking on inclines if the trailer is loaded.
- We recommend also having the vehicle inspected between the inspection intervals if you are towing a trailer frequently.
- Avoid driving with a trailer during the vehicle break-in period.

### Driving with a trailer

*Driving with a trailer requires extra caution.*

#### Speed

Adhere to the legal speed limits. Follow the legal regulations specific to the country.

As the speed increases, the driving stability of the trailer decreases. Therefore you should not exceed the maximum legal speed limit when there are unfavorable road, weather and/or wind conditions. This especially applies when driving downhill.

You must always reduce your speed as soon as you notice even the slightest swinging motion of the trailer. Never try to “straighten out” the trailer by accelerating.

The weight distribution is very poor if the vehicle is empty and the trailer is loaded. However if you must drive under these circumstances, then drive especially slowly. ►

## Brakes

Brake in a timely manner. Downshift before driving downhill so that the engine can assist with braking ⇒ .

When using a trailer with overrun brakes, first brake gently then quickly. This reduces the risk of jerking while braking if the trailer wheels lock up.

## Engine coolant temperature

Pay attention specifically to the coolant temperature display when there are high outside temperatures, and when driving on long inclines ⇒ *page 8*. Shift to a higher gear in a timely manner.



### WARNING

Constant braking causes the brakes to overheat and substantially reduces braking performance, increases braking distance or causes complete failure of the brake system.





## Assistance systems

### Speed warning system

#### Description

Applies to: vehicles with speed warning system

The speed warning system helps you to stay below a specified maximum speed that can be set, changed or deleted in the Infotainment system.

The speed warning system warns you if you are exceeding the maximum speed that you have set. A warning tone will sound as soon as your speed exceeds the stored value slightly. The  (USA models) /  (Canada models) indicator light and a message appear in the instrument cluster display at the same time. The  /  indicator light and the message turn off if the speed falls back below the stored maximum speed.

Setting a threshold is recommended if you would like to be reminded when you reach a certain maximum speed. Situations where you may want to do so include driving in a country with a general speed limit or if there is a specified maximum speed for winter tires.

#### Setting the warning threshold

Select:  function button > (Car) Systems\* control button > Driver assist > Speed warning.

#### Tips

Regardless of the speed warning system, you should always monitor your speed using the speedometer and make sure you are following the legal speed limit.

### Cruise control system

#### Switching on

Applies to: vehicles with cruise control system

The cruise control system makes it possible to drive a constant speed that is 30 km/h or higher.



Fig. 78 Operating lever: cruise control system

- ▶ To switch the system on, pull the lever into position **1** ⇒ fig. 78.
- ▶ Drive at the speed to be maintained.
- ▶ To store the speed, press the button **A**.

The **CRUISE** (USA models) /  (Canada models) indicator light turns on in the instrument cluster.

#### WARNING





- Always pay attention to the traffic around you when the cruise control system is in operation. You are always responsible for your speed and the distance between your vehicle and other vehicles.
- For safety reasons, cruise control should not be used in the city, in stop-and-go traffic, on winding roads and when road conditions are poor (such as ice, fog, gravel, heavy rain and hydroplaning), because this increases the risk of an accident.
- Switch the cruise control off temporarily when driving in turning lanes, highway exits or in construction zones.
- Please note that “resting” your foot on the accelerator pedal unintentionally can result in acceleration that overrides the cruise control system.

**i Tips**

The cruise control system cannot maintain the speed consistently if you are driving on steep hills. The vehicle weight causes the speed to increase. Due to this, shift into a lower gear in time or apply the brakes.

**Changing the speed**

Applies to: vehicles with cruise control system

- ▶ To increase or decrease the speed in increments, push the lever toward / ⇒ page 76, fig. 78.
- ▶ To increase or decrease the speed quickly, hold the lever in the / direction until the desired speed is displayed.

**Overriding the speed**

Applies to: vehicles with cruise control system



You can also press the accelerator pedal down to increase your speed, for example if you want to pass someone. The speed you set earlier will resume as soon as you release the accelerator pedal.

However, if you are driving considerably faster than the stored speed for a long period of time, the cruise control system will temporarily switch off. The **CRUISE** (USA models) /  (Canada models) indicator light in the instrument cluster turns off and the stored speed is maintained.

**Preselecting a speed**

Applies to: vehicles with cruise control system

*You can pre-select your desired speed when the vehicle is stationary.*

- ▶ Switch the ignition on.
- ▶ Pull the lever into position  ⇒ page 76, fig. 78.
- ▶ To increase or decrease the speed, push the lever toward /.
- ▶ To store the speed displayed, release the lever.

This function makes it possible, for example, to save the speed you want before driving on the highway. Once on the highway, activate the

cruise control system by pulling the lever toward the position .

**Switching off**

Applies to: vehicles with cruise control system

**Deactivating temporarily**

- ▶ Press the brake pedal, or
- ▶ Press the lever into position  (not clicked into place) ⇒ page 76, fig. 78, or
- ▶ Drive for longer than five minutes at more than 6 mph (10 km/h) above the stored speed.

**Switching off completely**

- ▶ Press the lever into position  (clicked into place), or
- ▶ Switch the ignition off.

The speed you stored will be maintained if the cruise control has been switched off temporarily. To resume the stored speed, release the brake pedal and pull the lever into position .

Switching the ignition off will erase the stored speed.

**WARNING**

You should only resume the stored speed if it is not too high for existing traffic conditions. Otherwise you can increase the risk of an accident.

## Audi side assist

### Description

Applies to: vehicles with Audi side assist

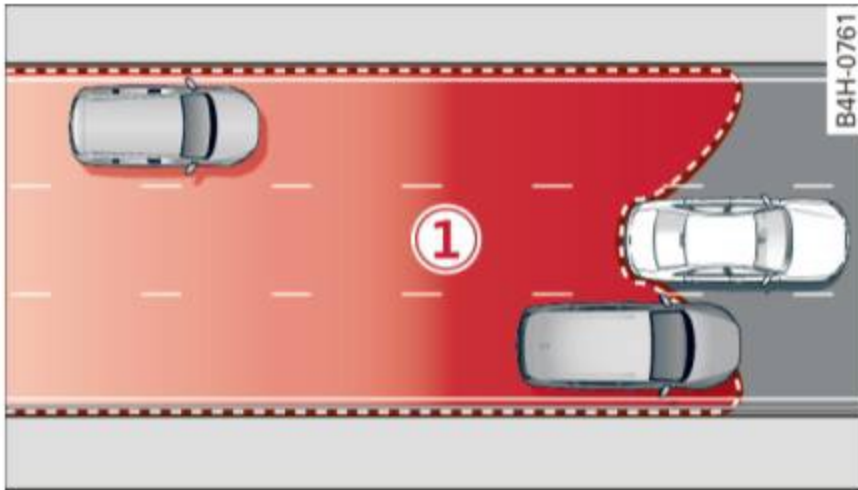

Fig. 79 Sensor detection range



Fig. 80 Display on the exterior mirror

Side assist helps you monitor your blind spot and traffic behind your vehicle. Within the limits of the system, it warns you about vehicles that are coming closer or that are traveling with you within sensor range ① ⇒ fig. 79: if a lane change is classified as critical, the display ② in the exterior mirror ⇒ fig. 80 turns on.

The display in the left exterior mirror provides assistance when making a lane change to the left, while the display in the right exterior mirror provides assistance when making a lane change to the right.

### Information stage

As long as you do not activate the turn signal, side assist *informs* you about vehicles that are detected and classified as critical. The display in the mirror turns on, but is dim.

The display remains dim in the information stage so that your view toward the front is not disturbed.

### Warning stage

If you activate the turn signal, side assist *warns* you about vehicles that are detected and classified as critical. The display in the respective mirror blinks brightly. If this happens, check traffic by glancing in the exterior mirrors and over your shoulder ⇒ ⚠ in *General information* on page 79.

### i Tips

- You can adjust the brightness on of the display on the rearview mirror ⇒ page 80.
- Please refer to the instructions for towing a trailer located in ⇒ page 79.

### General information

Applies to: vehicles with Audi side assist

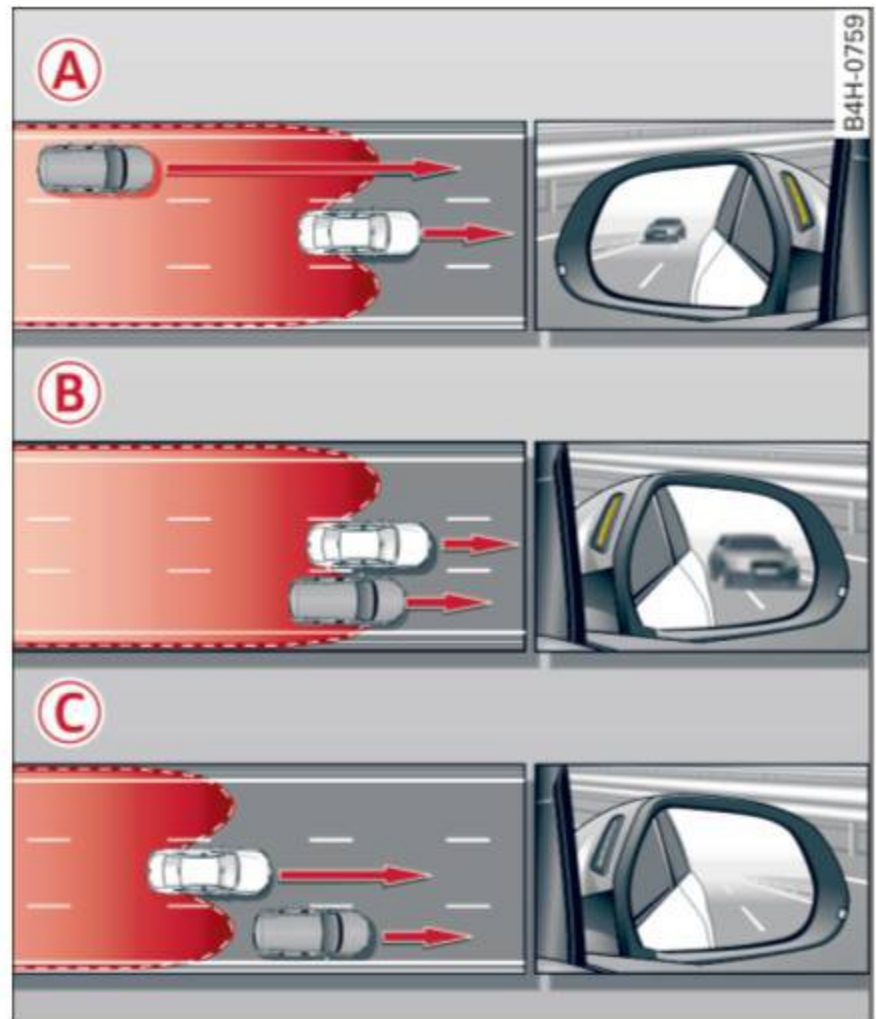

Fig. 81 Driving situations



Fig. 82 Rear of the vehicle: position of the sensors



Side assist functions at speeds above approximately 19 mph (30 km/h).

### **A Vehicles that are approaching**

In certain cases, a vehicle will be classified as critical for a lane change even if it is still somewhat far away. The faster a vehicle approaches, the sooner the display in the exterior mirror will turn on.

### **B Vehicles traveling with you**

Vehicles traveling with you are indicated in the exterior mirror if they are classified as critical for a lane change. All vehicles detected by side assist are indicated by the time they enter your “blind spot”, at the latest.

### **C Vehicles you are passing**

If you slowly pass a vehicle that side assist has detected (the difference in speed between the vehicle and your vehicle is less than 9 mph (15 km/h)), the display in the exterior mirror turns on as soon as the vehicle enters your blind spot.

The display will not turn on if you quickly pass a vehicle that side assist has detected (the difference in speed is greater than 9 mph (15 km/h)).

### **Functional limitations**

The radar sensors are designed to detect the left and right adjacent lanes when the road lanes are the normal width. In some situations, the display in the exterior mirror may turn on even though there is no vehicle located in the area that is critical for a lane change. For example:

- If the lanes are narrow or if you are driving on the edge of your lane. If this is the case, the system may have detected a vehicle in another lane that is *not* adjacent to your current lane.
- If you are driving through a curve. Side assist may react to a vehicle that is one lane over from the adjacent lane.
- If side assist reacts to other objects (such as high or displaced guard rails).
- In poor weather conditions. The side assist functions are limited.

Do not cover the radar sensors ⇒ *fig. 82* with stickers, deposits, bicycle wheels or other ob-

jects, because they will impair the function. Do not use side assist when towing a trailer. For information on cleaning, see ⇒ *page 185*.

### **! WARNING**

- Always pay attention to traffic and to the area around your vehicle. Side assist cannot replace a driver's attention. The driver alone is always responsible for lane changes and similar driving maneuvers.
- In some situations, the system may not function or its function may be limited. For example:
  - If vehicles are approaching or being left behind very quickly. The display may not turn on in time.
  - In poor weather conditions such as heavy rain, snow or heavy mist.
  - On very wide lanes, in tight curves, or if there is a rise in the road surface. Vehicles in the adjacent lane may not be detected because they are outside of the sensor range.

### **! Note**

The sensors can be displaced by impacts or damage to the bumper, wheel housing and underbody. This can impair the system. Have an authorized Audi dealer or authorized Audi Service Facility check their function.

### **i Tips**

- If the window glass in the driver's door or front passenger's door has been tinted, the display in the exterior mirror may be incorrect.
- For an explanation on conformity with the FCC regulations in the United States and the Industry Canada regulations, see ⇒ *page 215*.

### Switching on and off

Applies to: vehicles with Audi side assist



Fig. 83 Driver's door: side assist button

- ▶ Press the button to switch the system on and off ⇒  in *General information on page 79*. The LED in the button turns on when side assist is switched on.

### Adjusting the display brightness

Applies to: vehicles with Audi side assist

*The display brightness can be adjusted in the Infotainment system.*

- ▶ Select: the **CAR** function button > **(Car) Systems\*** control button > **Driver assist** > **Audi side assist**.

The display brightness adjusts automatically to the brightness of the surroundings, both in the information and in the warning stage. In very dark or very bright surroundings, the automatic adjustment will set the display to the minimum or maximum level. In such cases, you may notice no change when adjusting the brightness, or the change may only be noticeable once the surroundings change.

Adjust the brightness to a level where the display in the information stage will not disrupt your view ahead. If you change the brightness, the display in the exterior mirror will briefly show the brightness level in the information stage. The brightness of the warning stage is linked to the brightness in the information stage and is adjusted along with the information stage.

### Tips

- Side assist is not active while you are making the adjustment.
- Your settings are automatically stored and assigned to the remote control key being used.

### Messages

Applies to: vehicles with Audi side assist

If side assist switches off by itself, the LED in the button turns off and a message will appear in the instrument cluster display:

#### **Audi side assist: Unavailable. Sensor vision**

The radar sensor vision is impaired. Do not cover the area in front of the sensors with bike wheels, stickers, dirt or other objects. Clean the area in front of the sensors, if necessary ⇒ *page 78, fig. 82*.

#### **Audi side assist: Unavailable.**

Side assist cannot be switched on at this time because there is a malfunction (for example, the battery charge level may be too low).

#### **Audi side assist: System fault!**

The system cannot guarantee that it will detect vehicles correctly and it has switched off. The sensors have been moved or are faulty. Have the system checked by an authorized Audi dealer or authorized Audi Service Facility soon.

#### **Audi side assist: Unavailable when towing**

Side assist switches off automatically when a factory-installed trailer hitch is connected to the electrical connector on the trailer. There is no guarantee the system will switch off when using a retrofitted trailer hitch. Do not use side assist when towing a trailer.

## Audi drive select

### Introduction

Applies to: vehicles with Audi drive select

Drive select makes it possible to experience different types of vehicle settings in one vehicle. The driver can select from three modes, **Comfort**, ▶

**Auto** and **Dynamic**, using the drive select button in the center console or by using the Infotainment system. This allows you to switch between a sporty and a comfortable driving mode, for example.

### Description

Applies to: vehicles with Audi drive select

The following systems, among other things, are influenced by drive select:

#### Engine and automatic transmission

Depending on the mode, the engine and automatic transmission respond more quickly or in a more balanced manner to accelerator pedal movements. In the sporty dynamic mode, the transmission shifts at higher speed ranges.

#### Suspension control\*

The suspension control uses sensors to record information regarding steering movements, braking and acceleration operations by the driver, as well as information about the road surface, driving speed, and load. With drive select, you can adjust the suspension control to sporty (dynamic), comfortable (comfort) or balanced (auto).

#### Steering

The steering adapts in terms of steering assistance. Indirect steering that moves easily as in comfort mode is especially suited to long drives on a highway. In contrast, dynamic mode provides sporty, direct steering.

#### Cornering light\*

The cornering light adapts to driving on curves. The pivoting action and the lighting also adapt to the mode.

### Tips

The S selector lever position automatically engages if the dynamic mode is selected.

### Selecting the driving mode

Applies to: vehicles with Audi drive select



Fig. 84 Center console: drive select button

- ▶ To set the mode, press the drive select button repeatedly until the desired mode is displayed in the instrument cluster. Or
- ▶ Select in the Infotainment system: **CAR** function button > **Comfort**, **Auto** or **Dynamic**.

You can change the driving mode when the vehicle is stationary or while driving. If traffic permits, after changing modes, briefly take your foot off the accelerator pedal so that the recently selected mode is also activated for the engine.

**Comfort** - provides a comfort-oriented vehicle setup and is suited for long drives on highways.

**Automatic** - provides an overall comfortable yet dynamic driving feel and is suited for everyday use.

**Dynamic** - gives the driver a sporty driving feel and is suited to a sporty driving style.



### WARNING

Pay attention to traffic when operating the drive select to reduce the risk of an accident.

## Parking systems

### General information

Applies to: vehicles with a rear parking system/parking system plus/rearview camera

Depending on your vehicle's equipment, various parking aids will help you when parking and maneuvering.

The **rear parking system** is an audible parking aid that warns you of obstacles *behind* the vehicle  
⇒ *page 83*.

The **parking system plus** assists you when parking by audibly and visually indicating objects detected *in front of* and *behind* the vehicle  
⇒ *page 83*.

The **rearview camera** shows the area behind the vehicle in the Infotainment system display. The lines in the rearview camera image help you to park or maneuver ⇒ *page 84*.

#### **WARNING**

- Always look for traffic and check the area around your vehicle by looking at it directly as well. The parking system cannot replace the driver's attention. The driver is always responsible when entering or leaving a parking space and during similar maneuvers.
- Please note that some surfaces, such as clothing, are not detected by the system.
- Sensors and cameras have blind spots in which people and objects cannot be detected. Be especially cautious of small children and animals.
- Always pay attention to the area around the vehicle – using the rearview mirror, too.
- The sensors can be displaced by impacts or damage to the radiator grille, bumper, wheel housing and the underbody. The parking system may be impaired as a result. Have an authorized Audi dealer or authorized Audi Service Facility check their function.
- Make sure the sensors are not obstructed by stickers, deposits or other materials. If they are, the sensor function could be impaired.

For additional information on cleaning, see  
⇒ *page 185*.

#### **Note**

- Some objects are not detected or displayed by the system under certain circumstances:
  - objects such as barrier chains, trailer draw bars, vertical poles or fences
  - objects above the sensors such as wall extensions
  - objects with certain surfaces or structures such as chain link fences or powder snow
- If you continue driving closer to a low object, it may disappear from the sensor range. Note that you will no longer be warned about this obstacle.

#### **Tips**

- The system may provide a warning even though there are no obstacles in the coverage area in some situations, such as:
  - certain road surfaces or when there is tall grass
  - external ultrasonic sources such as from cleaning vehicles
  - in heavy rain, snow, or thick vehicle exhaust
- We recommend that you practice parking in a traffic-free location or parking lot to become familiar with the system. When doing this, there should be good light and weather conditions.
- The sensors must be kept clean and free of snow and ice for the parking aid to operate. For information on cleaning, see  
⇒ *page 185*.
- You can change the volume and pitch of the signals as well as the display ⇒ *page 87*.
- Please refer to the instructions for towing a trailer located in ⇒ *page 88*.
- What appears in the infotainment display is somewhat time-delayed.

## Rear parking system

### Description

Applies to: vehicles with rear parking system

The rear parking system is an audible parking aid.

There is a sensor in the rear bumper cover. If these detect an obstacle, audible signals warn you.

Make sure the sensors are not covered by stickers, deposits or any other obstructions as it may impair the sensor function. For information on cleaning, see ⇒ page 185.

The range at which the sensors begin to measure is approximately:

rear	side	3 ft (0.90 m)
	center	5.2 ft (1.60 m)

The closer you get to the obstacle, the shorter the interval between the audible signals. A continuous tone sounds when the obstacle is less than approximately 1 foot (0.30 meters) away. Do not continue backing up ⇒ ⚠ in General information on page 82, ⇒ ⚠ in General information on page 82!

If the distance to an obstacle remains constant, the volume of the distance warning gradually drops after about four seconds (this does not apply in the continuous tone range).

### Activating

The parking system activates automatically when the reverse gear is selected. A brief confirmation tone will sound.

## Parking system plus

### Description

Applies to: vehicles with parking system plus

Parking system plus provides audio and visual signals when parking.

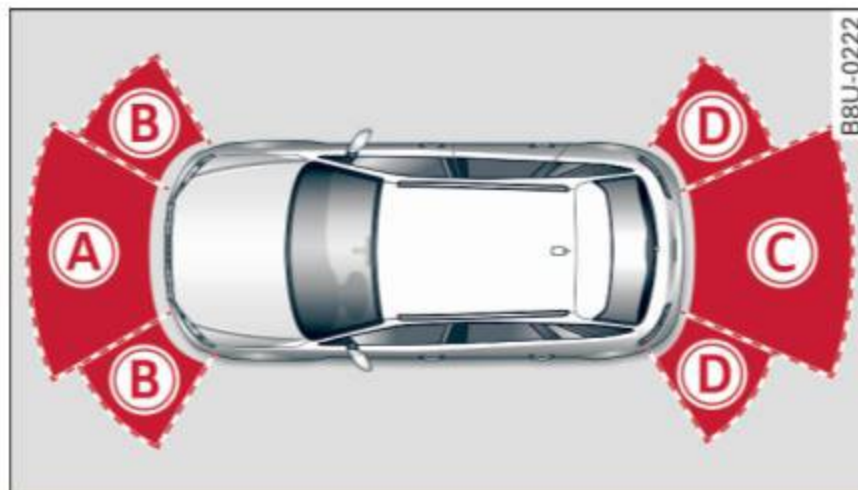

Fig. 85 Illustration:

Sensors are located in the front and rear bumpers. If these detect an obstacle, audible and visual signals warn you.

Make sure the sensors are not covered by stickers, deposits or any other obstructions as it may impair the sensor function. For information on cleaning, see ⇒ page 185.

The display field begins approximately at:

(A)	4 ft (1.20 m)
(B)	3 ft (0.90 m)
(C)	5.2 ft (1.60 m)
(D)	3 ft (0.90 m)

The closer you get to the obstacle, the shorter the interval between the audible signals. A continuous tone sounds when the obstacle is less than approximately 1 foot (0.30 meters) away. Do not continue driving forward or in reverse ⇒ ⚠ in General information on page 82, ⇒ ⚠ in General information on page 82!

If the distance to an obstacle remains constant, the volume of the distance warning gradually drops after about four seconds (this does not apply in the continuous tone range).

### Switching on/off

Applies to: vehicles with parking system plus



Fig. 86 Center console: parking aid button



Fig. 87 Infotainment system: visual distance display

### Switching on

- ▶ Shift into reverse, or
- ▶ Press the PWA button in the center console ⇒ *fig. 86*. A short confirmation tone sounds and the LED in the button turns on.

### Switching off

- ▶ Drive faster than 6 mph (10 km/h), or
- ▶ Press the PWA button, or
- ▶ Switch the ignition off.

### Segments in the visual display

The red segments in front of and behind the vehicle ⇒ *fig. 87* help you to determine the distance between you and a detected obstacle. As your vehicle comes closer to the obstacle, the segments move closer to the vehicle. The collision area has been reached when the next to last segment is displayed. Do not continue driving forward or in reverse ⇒ ⚠ in *General information on page 82*, ⇒ ⚠ in *General information on page 82*!

## Rearview camera

### Introduction

Applies to: vehicles with parking system plus with rearview camera

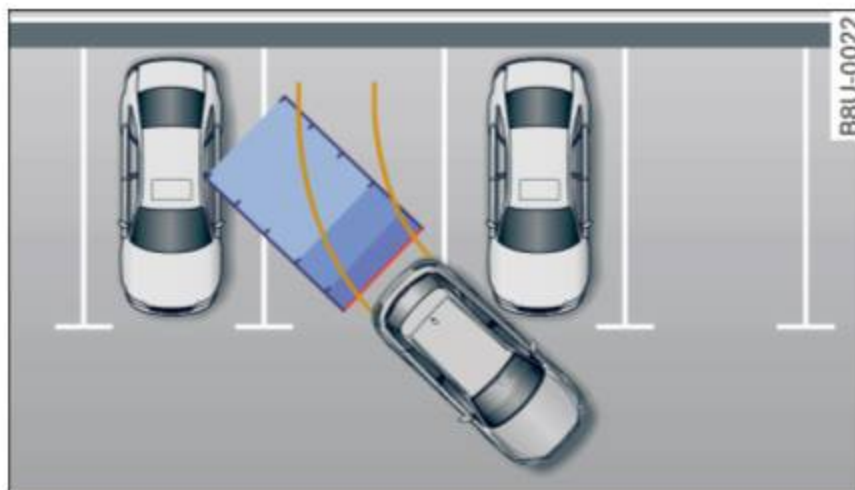

Fig. 88 Illustration: cross parking

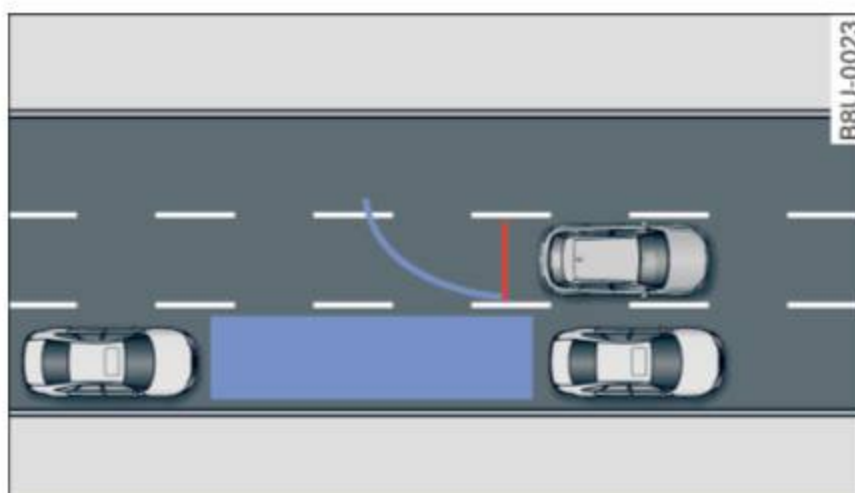

Fig. 89 Illustration: parallel parking

In addition to parking system plus ⇒ *page 83*, this parking system also has a rearview camera.

You can use *cross parking* for example, to park in a parking space or in a garage ⇒ *fig. 88*. You can use *parallel parking* if you would like to park on the side of the road ⇒ *fig. 89*.

**General information**

Applies to: vehicles with parking system plus with rearview camera

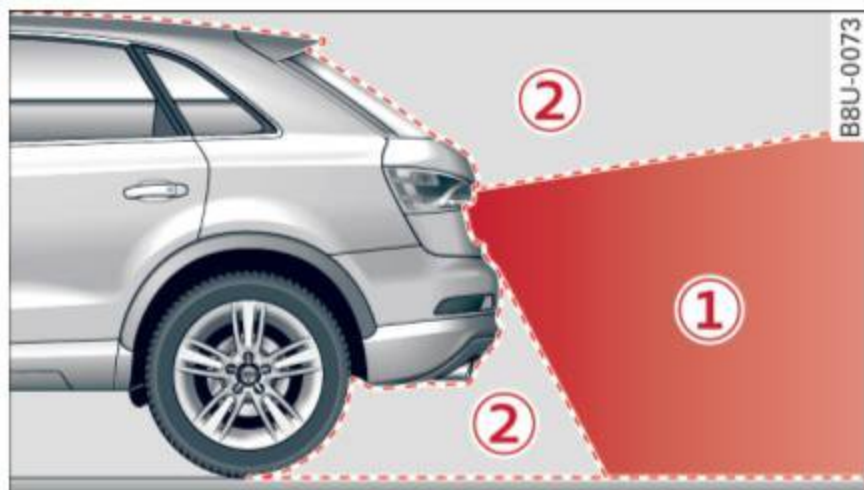

**Fig. 90** Area covered ① and area not covered ② by the rearview camera.



**Fig. 91** Luggage compartment lid: location of the rearview camera

The rearview camera is located above the rear license plate bracket. Make sure that the lens for the parking system ⇒ *fig. 91* is not covered by deposits or any other obstructions because this can affect the function of the parking system. For information on cleaning, see ⇒ *page 185*.

Area ① represents the rearview camera coverage area ⇒ *fig. 90*. Only this area is shown in the Infotainment display. Objects that are in area ②, which is not covered, are not displayed.

**! WARNING**

- Always read and follow the applicable warnings ⇒ **!** in *General information on page 82*.
- If the position and the installation angle of the rearview camera was changed, for example after a collision, do not continue to use the system for safety reasons. Have it checked by an authorized Audi dealer or authorized Audi Service Facility.

- Only use the rearview camera to assist you if it shows a good, clear picture. For example, the image may be affected by the sun shining into the lens, by dirt on the lens, or if there is a malfunction.
- Use the rearview camera only if the luggage compartment lid is completely closed. Make sure any objects you may have mounted on the luggage compartment lid do not block the rearview camera.
- The camera lens enlarges and distorts the field of vision. The object appears both altered and inaccurate on the screen.
- In certain situations, people or objects in the display appear closer or farther away:
  - For objects that do not touch the ground, such as the bumper of a parked vehicle, a trailer hitch or the rear of a truck. Do not use the orientation lines in this case.
  - If driven from a level surface onto an incline, or a downward slope.
  - If driven toward protruding objects.
  - If the vehicle is carrying too much load in the rear.

**! Note**

- Always read and follow the applicable warnings ⇒ **!** in *General information on page 82*.
- The orange-colored orientation lines in the Infotainment display show the vehicle path based on the steering wheel angle. The front of the vehicle swings out more than the rear of the vehicle. Maintain plenty of distance so that an exterior mirror or a corner of the vehicle does not collide with any obstacles.

**Switching on/off**

Applies to: vehicles with parking system plus with rearview camera

**Switching on**

- ▶ Shift into reverse, or
- ▶ Press the **P** button in the center console ⇒ *page 84, fig. 86*. A short confirmation tone sounds and the LED in the button turns on.

### Switching between the rearview camera and optical display

- ▶ Press the **Graphic** control button ⑤  
⇒ page 86, fig. 92 to see the optical display.
- ▶ Press the **Rear view** control button to see the rearview camera image.

### Switching off

- ▶ Drive faster than 6 mph (10 km/h), or
- ▶ Press the **P** button, or
- ▶ Switch the ignition off.

#### **i** Tips

The visual display in the left part of the display should help you detect the critical vehicle areas.

### Perpendicular parking

Applies to: vehicles with parking system plus with rearview camera

*This view may be used when parking in a garage or in a parking space.*

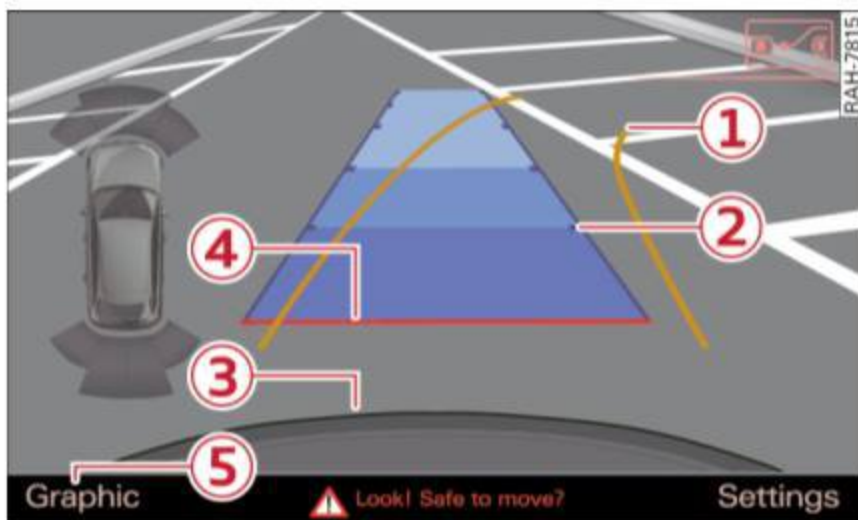

Fig. 92 Infotainment system: aiming at a parking space

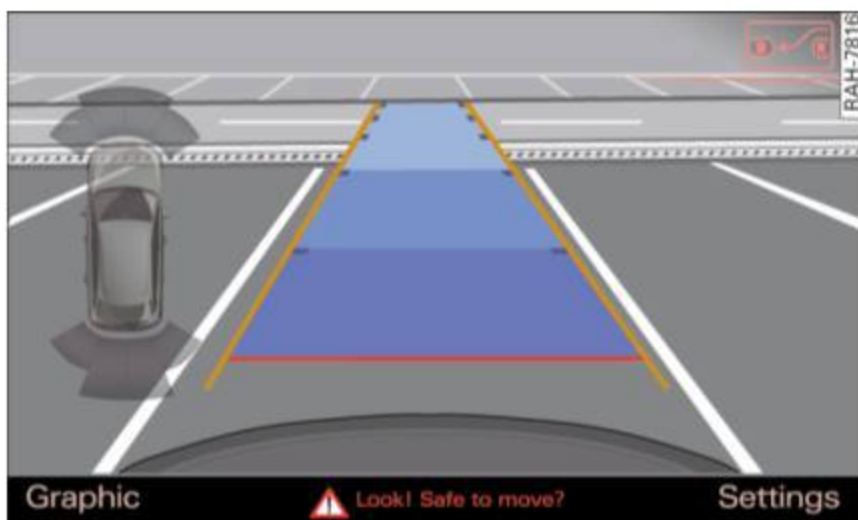

Fig. 93 Infotainment system: aligning the vehicle

- ▶ Turn the Infotainment system on and shift into reverse gear.

- ▶ The orange orientation lines ① show the direction of travel of the vehicle. Turn the steering wheel until the orange orientation lines appear in the parking space ⇒ fig. 92. Use the markings ② to help you estimate the distance from an obstacle. Each marking represents approximately 3 ft (1 m). The blue area represents an extension of the vehicle's outline by approximately 16 ft (5 meters) to the rear.
- ▶ While driving in reverse gear, adjust the steering wheel angle to fit the parking space using the orange orientation lines for assistance ⇒ ⚠ in General information on page 85, ⇒ ! in General information on page 85. ③ marks the rear bumper. Stop the vehicle, at the latest, when the red orientation line ④ borders an object.

### Parallel parking

Applies to: vehicles with parking system plus with rearview camera

*This view may be used when parallel parking along the side of a street.*

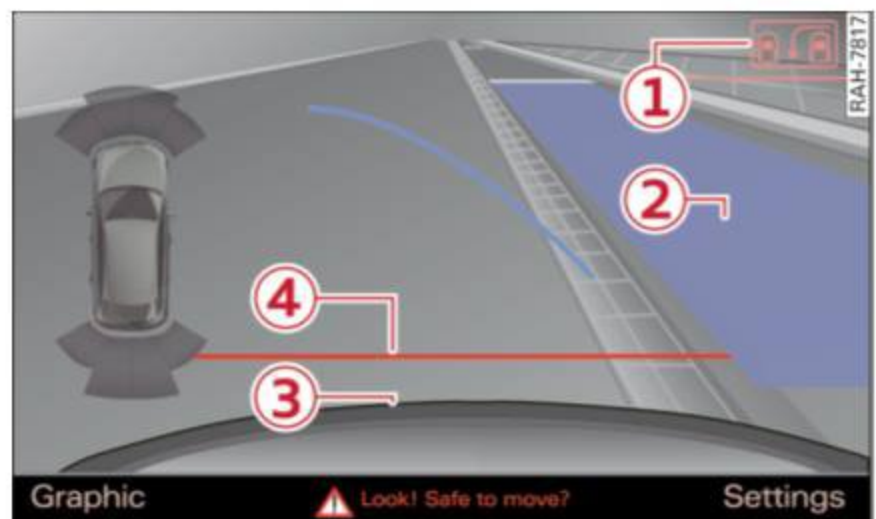

Fig. 94 Infotainment: blue surfaces aligned in the parking space

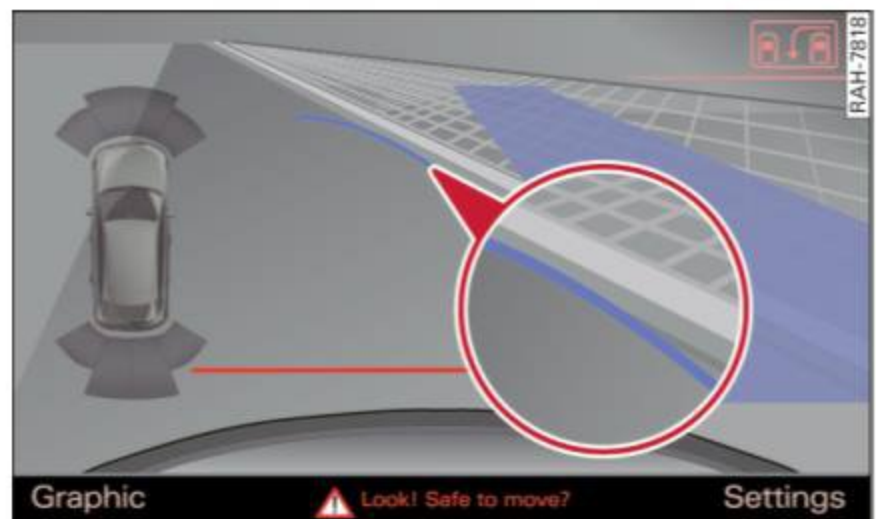

Fig. 95 Infotainment: contact of the blue curved line with the curb



Parking on the right is described here. It is identical when parking on the left.

If there is an obstacle next to the parking space (such as a wall), refer to “Information for parking next to obstacles” ⇒ page 87.

- ▶ Activate the turn signal.
- ▶ Position your vehicle next to a parked vehicle in front of the desired parking space. The distance to this vehicle should be approximately 3 ft. (1 m).
- ▶ Turn the Infotainment system on and shift into reverse gear. The parking system is turned on and the **Cross parking** view is displayed.
- ▶ Press the control button on the Infotainment unit ① ⇒ fig. 94. The **Parallel parking** view is displayed.
- ▶ Back up and align your vehicle so the blue area ② borders on the rear end of the vehicle behind you or on the parking space line ⇒ ⚠ in *General information on page 85*, ⇒ ⚠ in *General information on page 85*. The blue area represents an extension of the vehicle's outline by approximately 16 ft (5 meters) to the rear. The long side of the blue area should be on the curb. The entire blue area must fit into the parking space.
- ▶ With the vehicle stopped, turn the steering wheel to the right as far as it will go.
- ▶ Back into the parking space until the blue curve ⇒ fig. 95 touches the curb ⇒ ⚠ in *General information on page 85*, ⇒ ⚠ in *General information on page 85*. Stop the vehicle.
- ▶ With the vehicle stopped, turn the steering wheel to the left as far as it will go.
- ▶ Continue to back into the parking space until the vehicle is parked parallel to the curb ⇒ ⚠ in *General information on page 85*, ⇒ ⚠ in *General information on page 85*. ③ marks the rear bumper. Stop the vehicle, at the latest, when the red orientation line ④ borders an object. Keep an eye on the front of your vehicle while doing this.

### Parking next to obstacles

If there is an obstacle (such as a wall) next to the parking space, position the vehicle so there is more space on that side. Position the long side of the blue surface so that there is sufficient space

from the obstacle. The surface must not be touching. You will also need to start turning the steering wheel earlier. The blue curve ⇒ fig. 95 must **not** touch the obstacle and should have sufficient room.

#### ! Note

Keep enough distance from the curb to reduce the risk of damage to the rims.

#### i Tips

The left or right orientation lines and surfaces will be displayed, depending on the turn signal being used.

## Adjusting the display and the warning tones

Applies to: vehicles with parking system plus/rearview camera

The display and warning tones can be adjusted in the Infotainment.

- ▶ Select: the **CAR** function button > **(Car) Systems\*** control button > **Driver assist** > **Parking aid**.

### Display

**On\*** - an optical display is shown for the parking system plus, a rearview camera image is shown for parking system plus with rearview camera\*.

**Off** - when the parking system is switched off, only audible signals are given.

### Signal tones

**Front volume\*** - volume for the front area

**Rear volume** - volume for the rear area

**Front frequency\*** - frequency for the front area

**Rear frequency** - frequency for the rear area

**Music volume while parking** - when the parking system is turned on, the volume of the audio/video source is lowered



The newly selected level is demonstrated briefly by the sound generator. ▶





### Tips

- The warning tones can also be adjusted directly from the visual display or the rearview camera image\*. Simply press the **Settings** control button.
- Changed settings are activated when the parking system is switched on again.
- The settings are automatically stored and assigned to the remote control key that is in use.

## Error messages

Applies to: vehicles with parking system plus/rearview camera

There is an error in the system if the LED in the  button is blinking and you hear a continuous alarm for a few seconds after switching on the parking system or when the parking system is already activated. If the error is not corrected before you switch off the ignition, the LED in the  button will blink the next time you switch on the parking system by shifting into reverse.

If a sensor is faulty, the  symbol will appear in front of/behind the vehicle in the Infotainment display. If a rear sensor is faulty, only obstacles that are in areas  and  are displayed ⇒ page 83, fig. 85. If a front sensor is faulty, only obstacles that are in areas  and  are displayed.

Drive to an authorized Audi dealer or authorized Audi Service Facility immediately to have the malfunction corrected.

## Trailer hitch

Applies to: vehicles with parking system plus/rearview camera and trailer hitch

For vehicles using the trailer socket, the parking system rear sensors are not activated when you shift into reverse gear or when you press the  button. This results in the following restrictions.

### Parking system plus\*

There is no distance warning for the rear. The front sensors remain activated. The visual display switches to trailer mode.

### Parking system plus and rearview camera\*

There is no distance warning for the rear. The front sensors remain activated. The visual display switches to trailer mode. The rearview camera image will not show the orientation lines and the blue surfaces.

### Tips

Trailer hitches that are not installed at the factory may cause the parking system to malfunction or they may restrict its function.

## Intelligent Technology

### Electronic stabilization control (ESC)

#### Description

Electronic stabilization control (ESC) supports driver safety. It reduces the risk of slipping and improves driving stability. ESC detects critical situations such as the vehicle oversteering and understeering or the wheels are spinning. The vehicle is stabilized by applying the brakes or reducing engine torque. When the ESC engages, the  indicator light blinks in the instrument cluster.

The following systems are integrated in the ESC:

#### Anti-lock braking system (ABS)

ABS prevents the wheels from locking when braking. The vehicle can still be steered even during hard braking. Apply steady pressure to the brake pedal. Do not pump the pedal. A pulsing in the brake pedal indicates that the system is acting to stabilize the vehicle.

#### Brake assist system

The brake assist system can decrease braking distance. It increases braking power when the driver presses the brake pedal quickly in emergency situations. You must press and hold the brake pedal until the dangerous situation is over.

#### Anti-Slip Regulation (ASR)

ASR reduces engine power when the drive wheels begin spinning and adapts the force to the road conditions. This makes it easier to start, accelerate and drive up hills.

#### Electronic differential lock (EDL)

The EDL applies the brakes to a wheel that starts spinning and transfers the drive power to the other driving wheel or wheels (if the vehicle is equipped with all wheel drive\*). This function is not available at higher speeds.

In extreme cases, EDL automatically switches off to keep the brake on the braked wheel from overheating. The vehicle is still working correctly. EDL

will switch on again automatically when conditions have returned to normal.

#### Steering recommendation

The ESC helps to stabilize the vehicle by changing the steering torque.

#### Selective wheel torque control

Selective wheel torque control is used when driving on curves. The front wheel on the inside of the curve or both wheels on the inside of the curve are braked selectively as needed. This allows more precise driving in curves.

#### Automatic post-collision braking system

The “automatic post-collision braking system” can help to reduce the risk of sliding and of additional collisions after an accident. If the airbag control module detects a collision above a certain vehicle speed, the vehicle is braked by the ESC.

The vehicle does not brake automatically if:

- the driver presses the accelerator pedal, or
- the braking force generated by the pressed brake pedal is greater than the braking force that would be initiated by the system, or
- the ESC, the brake system or the vehicle electrical system are not functioning.

#### WARNING

- The ESC and its integrated systems cannot overcome the limits imposed by natural physical laws. This is especially important on slippery or wet roads. If the systems begin acting to stabilize your vehicle, you should immediately alter your speed to match the road and traffic conditions. Do not let the increased safety provided tempt you into taking risks. This could increase your risk of a collision.
- Please note the risk of a collision increases when driving fast, especially through curves and on slippery or wet roads, and when driving too close to objects ahead. The ESC and its integrated systems cannot always prevent collisions - there is still a risk of accidents!

– Press the accelerator pedal carefully when accelerating on even, slippery surfaces such as ice and snow. The drive wheels can spin even when these control systems are installed and this can affect driving stability and increase the risk of a collision.

condition. Different tire sizes can lead to a reduction in engine power.  
 – You may hear noises when the systems described are working.

**i Tips**

– The ABS and ASR only function correctly when all four wheels have a similar wear

**Switching on/off**

ESC turns on automatically when you start the engine.



Fig. 96 Center console: OFF button

The following examples are unusual situations where it may make sense to switch offroad mode on to allow the wheels to spin:

- Rocking the vehicle to free it when it is stuck
- Driving in deep snow or on loose ground
- Driving on rough terrain when much of the car's weight is lifted off the wheels (axle articulation)
- Driving downhill while braking on loose ground

For your safety, switch the offroad mode off in advance.

The ESC is designed to function in levels. Depending on the level selected, the ESC stabilization function is limited or switched off. The amount of stabilization control will differ depending on the level.

**ESC levels**

	Offroad mode on	ESC/ASR off	Offroad mode off or ESC/ASR on
<b>Behavior</b>	The ESC and ASR stabilization functions are limited ⇒ ⚠.	The stabilization function is not available ⇒ ⚠. ESC and ASR are switched off.	The full stabilization function of the ESC and ASR is available again.
<b>Operation</b>	Press the OFF button briefly.	Press and hold the OFF button longer than three seconds.	Press the OFF button again.
<b>Indicator lights</b>	OFF turns on.	OFF and ESC OFF turn on.	OFF turns off or OFF and ESC OFF turn off.
<b>Messages</b>	<b>Stabilization control (ESC): offroad. Warning! Reduced stability</b>	<b>Stabilization control (ESC): Off. Warning! Reduced stability</b>	<b>Stabilization control (ESC): On</b>

**! WARNING**

You should only switch offroad mode on or switch ESC/ASR off if your driving abilities and the traffic conditions permit. There is a risk of sliding.

- The stabilization function is limited when offroad mode is switched on. The driving wheels could spin and the vehicle could swerve, especially on slick or slippery road surfaces.
- There is no vehicle stabilization when ESC/ASR are switched off.

**Hill descent assist**

Applies to: vehicles with hill hold assist

*Hill descent assist makes it possible to drive down a hill at a constant speed.*



Fig. 97 Center console: hill descent assist button

- ▶ To switch the hill descent assist on, press the  button in the center console ⇨ *fig. 97*. The LED in the button turns on.
- ▶ Press the button again to switch it off. The LED in the button turns off.

Hill descent assist brakes all four wheels automatically in order to limit speed when driving either forward or reverse on hills with a grade up to approximately 50%.

When hill descent assist is on, the speed your vehicle was traveling when it entered the hill is maintained. It is only possible to switch on the assist when driving slower than 37 mph (60 km/h). The assist begins shortly after you start driving and continues up to approximately 19 mph (30 km/h). The driver can increase or decrease

the vehicle speed within these limits by pressing the accelerator or brake pedal.

However, there must be enough traction. Hill descent assist **cannot** function as expected, if for example the hill is icy or if the surface is loose ⇨ .

A blinking indicator light  in the instrument cluster will indicate if the system is actively regulating a specific speed up to approximately 19 mph (30 km/h). The indicator light stays on continuously when in the ready mode.

The system does not work at speeds between 19 and 37 mph (30 and 60 km/h). The system is then in ready-mode. This is indicated by the LED in the button turning on. The system automatically switches off when you drive faster than 37 mph (60 km/h). The LED will also turn off in this scenario.

Hill descent assist is automatically activated under the following conditions:

- the LED in the button turns on
- the vehicle speed is lower than 19 mph (30 km/h)
- the incline angle is at least around 10%

**! WARNING**

- Always adapt your speed to the weather, road and traffic conditions. Do not let the increased safety provided tempt you into taking risks, because this increases the risk of an accident.
- The hill descent assist system cannot overcome the laws of physics. Your driving style must always be adapted to the current road and traffic conditions.
- Hill descent assist may not be able to hold your vehicle at a constant speed under all conditions while driving on a hill (for example if ground under the vehicle is loose).

**Brakes****New brake pads**

New brake pads do not achieve their full braking effect during the first 250 mi (400 km). They must be “broken in” first. However, you can

compensate for the slightly reduced braking force by pressing firmly on the brake pedal. Avoid heavy braking during the break-in period.

### Wear

**Brake pad** wear depends largely on the way the vehicle is driven and on operating conditions. This is especially true if you are driving frequently in the city and on curves or with a sporty driving style.

### Operating noise

Noises may occur when braking depending on the speed, braking force and outside conditions such as temperature and humidity.

### Effect of water or road salt

In certain situations, for example after driving through water, in heavy rain, after overnight condensation or after washing your car, the braking effect can be reduced by moisture or ice on the brake rotors and brake pads. The brakes must be “dried” first with a few careful brake applications.

At higher speeds and with the windshield wipers turned on, the brake pads press against the brake rotors for a short amount of time. This action, which is not felt by the driver, happens at regular intervals and ensures a better reaction time for the brakes in wet weather.

The braking effect can also be reduced if you are driving on salted roads and you do not apply the brakes for long periods of time. The layer of salt on the brake rotors and brake pads must be worn off first when the brakes are applied ⇒ ⚠.

### Corrosion

Leaving the vehicle parked for long periods of time, low mileage and avoiding heavy braking can contribute to corrosion on the brake rotors and to dirty brake pads.

If you usually avoid heavy braking or if there is corrosion present, occasional heavy braking at high speeds is recommended to clean the brake rotors and pads ⇒ ⚠.

### Brake system malfunction

if you notice that the brake pedal travel has *suddenly* gotten larger, then a brake circuit may have failed ⇒ ⚠.

### Low brake fluid level

When the brake fluid level is low, malfunctions in the brake system may occur. The brake fluid level is electronically monitored.

### Brake booster

The brake booster amplifies the pressure you apply to the brake pedal. It only works when the engine is running ⇒ ⚠.

#### ⚠ WARNING

- Only apply the brakes for the purpose of cleaning the brake system when road and traffic conditions permit. You must not endanger other road users. This increases the risk of an accident.
- Never let the vehicle roll while the engine is stopped because this increases the risk of an accident.

#### ! Note

- Never let the brakes “rub” by pressing the pedal lightly when braking is not actually necessary. This causes the brakes to overheat and increases braking distance and causes wear.
- Before driving downhill a long distance on a steep hill, decrease your speed and select a lower gear. This makes use of the engine braking effect and relieves the brakes. If you need to brake additionally, brake in intervals and not continuously.

#### i Tips

- If the brake booster is not working, you must press the brake pedal with much more force than normal.
- If you retrofit your vehicle with a front spoiler, wheel covers or similar items, make sure that the air flow to the front wheels is not interrupted. Otherwise the brake system can become too hot.

## Electromechanical steering

The electromechanical steering supports the driver's steering movements.

Power steering adapts *electronically* based on the vehicle speed.

### Indicator lights and messages

#### **Steering fault! Do not drive vehicle!**

If this indicator light turns on and stays on and this message appears, the power steering may have failed.

Do **not** continue driving. See an authorized Audi dealer or authorized Audi Service Facility for assistance.



If the indicator light turns on, the steering wheel may be more difficult to move or more sensitive than usual. The steering wheel may also be at an angle when driving straight.

Drive slowly to an authorized Audi dealer or authorized Audi Service Facility to have the malfunction corrected.

#### **Steering lock: System fault! Please contact dealer.**



There is a malfunction in the electronic steering lock.

Drive to an authorized Audi dealer or authorized Audi Service Facility immediately to have the malfunction corrected.

#### **WARNING**

Have the system malfunction corrected as soon as possible by an authorized Audi dealer or authorized Audi Service Facility, as this increases the risk of an accident.

#### **Tips**

If the  or  indicator light only stays on for a short time, you may continue driving.

## All wheel drive (quattro)

Applies to: vehicles with all wheel drive

*In all wheel drive, all four wheels are powered.*

### General information

In all wheel drive, the driving power is divided between all four wheels. This happens automatically depending on your driving behavior as well as the current road conditions. Also see ⇒ *page 89*.

The all wheel drive concept is designed for high engine power. Your vehicle is exceptionally powerful and has excellent driving characteristics both under normal driving conditions and on snow and ice. Always read and follow safety precautions ⇒ .

### Winter tires

By using all wheel drive, your vehicle has good *forward* motion with standard tires in winter conditions. However, using winter or all season tires on *all four* wheels in the winter is recommended, because this will improve the *braking* effect.

### Snow chains

If there are snow chain laws, snow chains must also be used on vehicles with all wheel drive ⇒ *page 181, Snow chains*.

### Replacing tires

For vehicles with all wheel drive, only wheels with the same rolling circumference should be used. Avoid using tires with different tread depths ⇒ *page 173, New tires or wheels*.

#### **WARNING**

- Also, in vehicles with all wheel drive, adapt your driving style to the current road and traffic conditions. Do not let the increased safety provided tempt you into taking risks, because this increases the risk of an accident.
- The braking ability of your vehicle is limited to the traction of the wheels. In this way, it is not different from a two wheel drive vehicle. Do not be tempted to accelerate to a high speed when the road is slippery, because this increases the risk of an accident.

- Note that on wet streets, the front wheels can “hydroplane” if driving at speeds that are too high. Unlike front wheel drive vehicles, the engine does not rev higher suddenly when the vehicle begins hydroplaning. For this reason, adapt your speed to the road conditions to reduce the risk of an accident.

## Energy management

### The starting ability is optimized

*The energy management system manages the electrical energy distribution and optimizes the availability of electrical energy for starting the engine.*

When a vehicle with a conventional energy system is not driven for a long time, the vehicle battery is drained by equipment (for example, the immobilizer). In certain circumstances, there could may not be enough energy to start the engine.

Your vehicle is equipped with an intelligent energy management system for distributing electricity. This significantly improves the starting ability and increases the vehicle battery life.

The energy management system Is made up of **battery diagnosis**, **idling current management**, and **dynamic energy management**.

### Battery diagnosis

The battery diagnosis determines the vehicle battery charge level. The sensors determine the battery voltage, the battery current, and the battery temperature. The current charge level and the performance of the vehicle battery are determined based on this.

### Idling current management

The idling current management decreases the energy used while parked. With the engine switched off, it manages the energy distribution to the different electrical components. Data from the battery diagnosis is taken into account for this.

Depending on the vehicle battery charge level, electrical equipment is switched off one item after the other to prevent the vehicle battery from draining and to maintain the starting ability.

### Dynamic energy management

While driving, dynamic energy management distributes the appropriate amount of energy to the electrical equipment. It controls the battery charge level so that the amount of energy is not greater than the amount being generated in order to maintain an optimal vehicle battery charge level.

### Tips

- Energy management cannot overcome the laws of physics. Note that the charge level and length of the vehicle battery life are limited.
- When the starting ability is endangered, the  indicator light turns on ⇒ [page 13](#).

### What you should know

*Maintaining the starting ability is the highest priority.*

A lot of stress is placed on the vehicle battery when driving short distances, during city driving, and at cold times of the year. A lot of energy is used but little is generated. It is also critical when the engine is not running but electrical equipment is switched on. In this case, energy is used but none is generated.

In situations like this, energy management will actively regulate the distribution of energy.

### Long periods without use

If you do not drive your vehicle for several days or weeks, electrical equipment is gradually scaled back or switched off. This reduces energy use and ensures the vehicle will be able to start after long periods of time. Some convenience functions, such as interior lighting, may not be available under certain circumstances. These convenience functions will be available again once you switch the ignition on and start the engine. ▶



**With the engine switched off**

The vehicle battery will drain if you use Infotainment functions such as listening to the radio while the engine is switched off.

The vehicle's ability to start may be impaired by the energy use, a message will appear in the Infotainment system display.

The message indicates that the system will switch off automatically soon. If you would like to continue using the functions, you must start the engine.

**With the engine running**

Although electrical energy is generated while driving, the vehicle battery can drain. This can happen if little energy is generated but much is used, and the charge level of the vehicle battery is not optimal.

To restore the balance of energy, components that require large amounts of energy are temporarily scaled back or switched off. Heating systems in particular require a great deal of energy. If you notice, for example, that the seat heating\* or rear window defogger is not working, then it has been temporarily reduced or switched off. These systems are available again as soon as the energy supply has been restored.

In addition, you may notice that the idle speed has slightly increased. That is normal and no cause for concern. By increasing the idling speed, the additional required energy will be generated and the vehicle battery will be charged.

## **Notice about data recorded by the Event Data Recorder and vehicle control modules**

**Event Data Recorder**

This vehicle is equipped with an Event Data Recorder (EDR). The main purpose of an EDR is to record, in certain crash or near crash-like situations, such as an airbag deployment or hitting a road obstacle, data that will assist in understanding how a vehicle's systems performed. The EDR

is designed to record data related to vehicle dynamics and safety systems for a short period of time, typically 30 seconds or less. The EDR in this vehicle is designed to record such data as:

- How various systems in your vehicle were operating;
- Whether or not the driver and passenger safety belts were buckled/fastened;
- How far (if at all) the driver was depressing the accelerator and/or brake pedal; and,
- How fast the vehicle was traveling.

These data can help provide a better understanding of the circumstances in which crashes and injuries occur. NOTE: EDR data are recorded by your vehicle only if a non-trivial crash situation occurs; no data are recorded by the EDR under normal driving conditions and no personal data (e.g., name, gender, age, and crash location) are recorded. However, other parties, such as law enforcement, could combine the EDR data with the type of personally identifying data routinely acquired during a crash investigation.

To read data recorded by an EDR, special equipment is required, and access to the vehicle or the EDR is needed. In addition to the vehicle manufacturer, other parties, such as law enforcement, that have the special equipment, can read the information if they have access to the vehicle or the EDR.

Some state laws restrict the retrieval or downloading of data stored by EDRs installed in a vehicle for the express purpose of retrieving data after an accident or crash event without the owner's consent.

Audi will not access the EDR and/or similar data or give it to others -

- unless the vehicle owner (or lessee if the vehicle has been leased) agrees; or
- upon the official request by the police; or
- upon the order of a court of law or a government agency; or
- for the defense of a lawsuit through the judicial discovery process.
- Audi may also use the data for research about vehicle operation and safety performance or

provide the data to a third party for research purposes without identifying the specific vehicle or information about the identity of its owner or lessee and only after the recorded vehicle data has been accessed.

### Vehicle control modules

Your vehicle is also equipped with a number of electronic control modules for various vehicle systems, such as engine management, emission control, airbags, and safety belts.

These electronic control modules record data during normal vehicle operation that may be needed by trained technicians for diagnostic and repair purposes. The recording capability of these modules is limited to data (no sound is recorded). Only a small amount of data is actually recorded over a very limited period of time, or stored when a system fault is detected by a control module. Some of the data stored may relate to vehicle speed, direction, or braking, as well as restraint system use and performance in the event of a crash. Stored data can also only be read and downloaded with special equipment that is directly connected to the vehicle.

#### Tips

Your vehicle may be equipped with Audi connect. Your use of certain Audi connect features requires wireless services that are provided by a third party wireless telecommunications provider. For details regarding how information obtained through Audi connect is collected, processed, transmitted, used, and shared, please see your contract with the wireless telecommunications provider and the “About Audi connect” tab in your vehicle’s MMI: **MENU** button > **Audi connect** > **About Audi connect**.

# Driving safety

## Basics

### Safe driving habits

*Please remember - safety first!*

The individual safety features of your vehicle can work together as a system to help protect you and your passengers in a wide range of accidents. These features cannot work as a system if they are not always correctly adjusted and correctly used.

This chapter contains important information, tips, instructions and warnings that you need to read and observe for your own safety, the safety of your passengers and others. We have summarized here what you need to know about safety belts, airbags, child restraints as well as child safety. Your safety is for us *priority number 1*. Always observe the information and warnings in this section - for your own safety as well as that of your passengers.

The information in this section applies to all model versions of your vehicle. Some of the features described in this sections may be standard equipment on some models, or may be optional equipment on others. If you are not sure, ask your authorized Audi dealer.

### WARNING

- Always make sure that you follow the instructions and heed the WARNINGS in this Manual. It is in your interest and in the interest of your passengers.
- Always keep the complete Owner's Literature in your Audi when you lend or sell your vehicle so that this important information will always be available to the driver and passengers.
- Always keep the Owner's literature handy so that you can find it easily if you have questions.

### Important things to do before driving

*Safety is everybody's job! Vehicle and occupant safety always depends on the informed and careful driver.*

For your safety and the safety of your passengers, **before driving always:**

- ▶ Make sure that all lights and signals are operating correctly.
- ▶ Make sure that the tire pressure is correct.
- ▶ Make sure that all windows are clean and afford good visibility to the outside.
- ▶ Secure all luggage and other items carefully ⇒ *page 102*, ⇒ *page 45*.
- ▶ Make sure that nothing can interfere with the pedals.
- ▶ Adjust front seat, head restraint and mirrors correctly for your height.
- ▶ Instruct passengers to adjust the head restraints according to their height.
- ▶ Make sure to use the right child restraint correctly to protect children ⇒ *page 134*, *Child safety*.
- ▶ Sit properly in your seat and make sure that your passengers do the same ⇒ *page 42*, *Front seats*.
- ▶ Fasten your safety belt and wear it properly. Also instruct your passengers to fasten their safety belts properly ⇒ *page 106*.

### What impairs driving safety?

*Safe driving is directly related to the condition of the vehicle, the driver as well as the driver's ability to concentrate on the road without being distracted.*

The driver is responsible for the safety of the vehicle and all of its occupants. If your ability to drive is impaired, safety risks for everybody in the vehicle increase and you also become a hazard to everyone else on the road ⇒ . Therefore:

- ▶ Do not let yourself be distracted by passengers or by using a cellular telephone.
- ▶ NEVER drive when your driving ability is impaired (by medications, alcohol, drugs, etc.).
- ▶ Observe all traffic laws, rules of the road and speed limits and plain common sense. ▶

- ▶ ALWAYS adjust your speed to road, traffic and weather conditions.
- ▶ Take frequent breaks on long trips. Do not drive for more than two hours at a stretch.
- ▶ Do NOT drive when you are tired, under pressure or when you are stressed.

### WARNING

Impaired driving safety increases the risk of serious personal injury and death whenever a vehicle is being used.

## Correct passenger seating positions

### Proper seating position for the driver

The proper driver seating position is important for safe, relaxed driving.

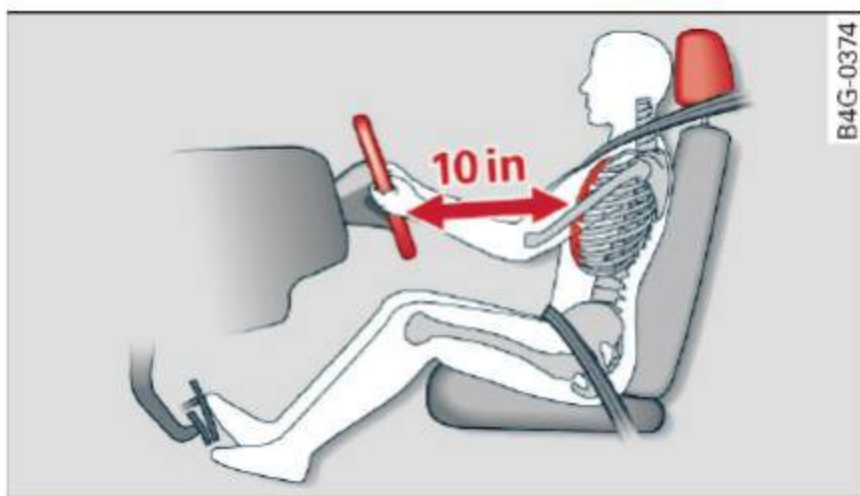



Fig. 98 Correct seating position

For your own safety and to reduce the risk of injury in the event of an accident, we recommend that you adjust the driver's seat to the following position:

- ▶ Adjust the driver's seat so that you can easily push the pedals all the way to the floor while keeping your knee(s) slightly bent ⇒ .
- ▶ Adjust the angle of the seatback so that it is in an upright position so that your back comes in full contact with it when you drive.
- ▶ Adjust the steering wheel so that there is a distance of at least 10 inches (25 cm) between the steering wheel and your breast bone ⇒ *fig. 98*. If not possible, see your authorized Audi dealer about adaptive equipment.

- ▶ Adjust the steering wheel so that the steering wheel and airbag cover points at your chest and not at your face.
- ▶ Grasp the top of the steering wheel with your elbow(s) slightly bent.
- ▶ Adjust the head restraint so the upper edge is as even as possible with the top of your head. If that is not possible, try to adjust the head restraint so that it is as close to this position as possible.
- ▶ Fasten and wear safety belts correctly ⇒ *page 109*.
- ▶ Always keep both feet in the footwell so that you are in control of the vehicle at all times.

For detailed information on how to adjust the driver's seat, see ⇒ *page 42*.

### WARNING

Drivers who are unbelted, out of position or too close to the airbag can be seriously injured by an airbag as it unfolds. To help reduce the risk of serious personal injury:

- Always adjust the driver's seat and the steering wheel so that there are at least 10 inches (25 cm) between your breastbone and the steering wheel.
- Always hold the steering wheel on the outside of the steering wheel rim with your hands at the 9 o'clock and 3 o'clock positions to help reduce the risk of personal injury if the driver's airbag inflates.
- Never hold the steering wheel at the 12 o'clock position or with your hands at other positions inside the steering wheel rim or on the steering wheel hub. Holding the steering wheel the wrong way can cause serious injuries to the hands, arms and head if the driver's airbag deploys.
- Pointing the steering wheel toward your face decreases the ability of the supplemental driver's airbag to protect you in a collision.
- Always sit in an upright position and never lean against or place any part of your body too close to the area where the airbags are located.

- Before driving, always adjust the front seats and head restraints properly and make sure that all passengers are properly restrained.
- Never adjust the seats while the vehicle is moving. Your seat may move unexpectedly and you could lose control of the vehicle.
- Never drive with the backrest reclined or tilted far back! The farther the backrests are tilted back, the greater the risk of injury due to incorrect positioning of the safety belt and improper seating position.
- Children must always ride in child safety seats ⇒ *page 134*. Special precautions apply when installing a child safety seat on the front passenger seat ⇒ *page 114*.

### Proper seating position for the front passenger

*The proper front passenger seating position is important for safe, relaxed driving.*

For your own safety and to reduce the risk of injury in the event of an accident, we recommend that you adjust the seat for the front passenger to the following position:

- ▶ Adjust the angle of the seatback so that it is in an upright position and your back comes in full contact with it whenever the vehicle is moving.
- ▶ Adjust the head restraint so the upper edge is as even as possible with the top of your head. If that is not possible, try to adjust the head restraint so that it is as close to this position as possible ⇒ *page 43*.
- ▶ Keep both feet flat on the floor in front of the front passenger seat.
- ▶ Fasten and wear safety belts correctly ⇒ *page 109*.

For detailed information on how to adjust the front passenger's seat, see ⇒ *page 42*.

#### WARNING

Front seat passengers who are unbelted, out of position or too close to the airbag can be seriously injured or killed by the airbag as it unfolds. To help reduce the risk of serious personal injury:

- Passengers must always sit in an upright position and never lean against or place any part of their body too close to the area where the airbags are located.
- Passengers who are unbelted, out of position or too close to the airbag can be seriously injured by an airbag as it unfolds with great force in the blink of an eye.
- Always make sure that there are at least 10 inches (25 cm) between the front passenger's breastbone and the instrument panel.
- Each passenger must always sit on a seat of their own and properly fasten and wear the safety belt belonging to that seat.
- Before driving, always adjust the front passenger seat and head restraint properly.
- Always keep your feet on the floor in front of the seat. Never rest them on the seat, instrument panel, out of the window, etc. The airbag system and safety belt will not be able to protect you properly and can even increase the risk of injury in a crash.
- Never drive with the backrest reclined or tilted far back! The farther the backrests are tilted back, the greater the risk of injury due to incorrect positioning of the safety belt and improper seating position.
- Children must always ride in child safety seats ⇒ *page 134*. Special precautions apply when installing a child safety seat on the front passenger seat ⇒ *page 114*.

### Proper seating positions for passengers in rear seats

*Rear seat passengers must sit upright with both feet on the floor consistent with their physical size and be properly restrained whenever the vehicle is in use.*

To reduce the risk of injury caused by an incorrect seating position in the event of a sudden braking maneuver or an accident, your passengers on the rear bench seat must always observe the following:

- ▶ Make sure that the seatback is securely latched in the upright position ⇒ *page 47*.

- ▶ If there is a passenger on the rear center seating position, slide the center head restraint upward at least to the next notch ⇒ *page 44*.
- ▶ Keep both feet flat in the footwell in front of the rear seat.
- ▶ Fasten and wear safety belts properly ⇒ *page 109*.
- ▶ Make sure that children are always properly restrained in a child restraint that is appropriate for their size and age ⇒ *page 134*.

### WARNING

Passengers who are improperly seated on the rear seat can be seriously injured in a crash.

- Each passenger must always sit on a seat of their own and properly fasten and wear the safety belt belonging to that seat.
- Safety belts only offer maximum protection when the seatback is securely latched in the upright position and the safety belts are properly positioned on the body. By not sitting upright, a rear seat passenger increases the risk of personal injury from improperly positioned safety belts!
- Always adjust the head restraint properly so that it can give maximum protection.

### Proper adjustment of head restraints

*Correctly adjusted head restraints are an important part of your vehicle's occupant restraint system and can help to reduce the risk of injuries in accident situations.*

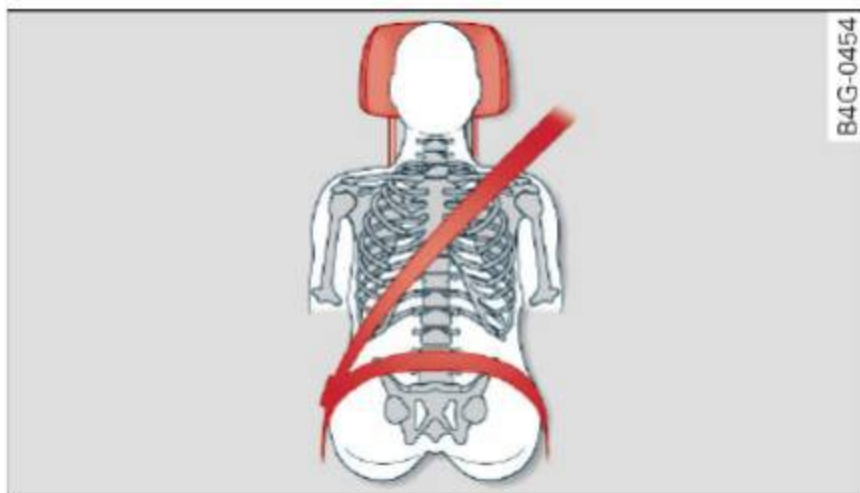

**Fig. 99** Head restraint: viewed from the front

The head restraints must be correctly adjusted to achieve the best protection.

- ▶ Adjust the head restraints so the upper edge is as even as possible with the top of your head. If that is not possible, try to adjust the head restraint so that it is as close to this position as possible ⇒ *fig. 99*.
- ▶ If there is a passenger on the rear center seating position, slide the center head restraint upward at least to the next notch.

Adjusting head restraints ⇒ *page 43*.

### WARNING

All seats are equipped with head restraints.

Driving without head restraints or with head restraints that are not properly adjusted increases the risk of serious or fatal neck injury dramatically. To help reduce the risk of injury:

- Always drive with the head restraints in place and properly adjusted.
- Every person in the vehicle must have a properly adjusted head restraint.
- Always make sure each person in the vehicle properly adjusts their head restraint. Adjust the head restraints so the upper edge is as even as possible with the top of your head. If that is not possible, try to adjust the head restraint so that it is as close to this position as possible.
- Never attempt to adjust head restraint while driving. If you have driven off and must adjust the driver headrest for any reason, first stop the vehicle safely before attempting to adjust the head restraint.
- Children must always be properly restrained in a child restraint that is appropriate for their age and size ⇒ *page 134*.

### Examples of improper seating positions

*The occupant restraint system can only reduce the risk of injury if vehicle occupants are properly seated.*

Improper seating positions can cause serious injury or death. Safety belts can only work when they are properly positioned on the body. Improper seating positions reduce the effectiveness of safety belts and will even increase the risk of injury and death by moving the safety belt to

critical areas of the body. Improper seating positions also increase the risk of serious injury and death when an airbag deploys and strikes an occupant who is not in the proper seating position. A driver is responsible for the safety of all vehicle occupants and especially for children. Therefore:

- ▶ Never allow anyone to assume an incorrect seating position when the vehicle is being used ⇒ .

The following bulletins list only some sample positions that will increase the risk of serious injury and death. Our hope is that these examples will make you more aware of seating positions that are dangerous.

#### Therefore, whenever the vehicle is moving:

- never stand up in the vehicle
- never stand on the seats
- never kneel on the seats
- never ride with the seatback reclined
- never lie down on the seats
- never lean up against the instrument panel
- never sit on the edge of the seat
- never sit sideways
- never lean out the window
- never put your feet out the window
- never put your feet on the instrument panel
- never rest your feet on the seat cushion or back of the seat
- never ride in the footwell
- never ride in the cargo area

#### WARNING

Improper seating positions increase the risk of serious personal injury and death whenever a vehicle is being used.

- Always make sure that all vehicle occupants stay in a proper seating position and are properly restrained whenever the vehicle is being used.

## Pedal area

### Pedals

*The pedals must always be free to move and must never be interfered with by a floor mat or any other object.*

Make sure that all pedals move freely without interference and that nothing prevents them from returning to their original positions.

Only use floor mats that leave the pedal area free and can be secured with floor mat fasteners.

If a brake circuit fails, increased brake pedal travel is required to bring the vehicle to a full stop.

#### WARNING

Pedals that cannot move freely can cause loss of vehicle control and increase the risk of serious injury.

- Never place any objects in the driver's footwell. An object could get into the pedal area and interfere with pedal function. In case of sudden braking or an accident, you would not be able to brake or accelerate!
- Always make sure that nothing can fall or move into the driver's footwell.

### Floor mats on the driver side

*Always use floor mats that can be securely attached to the floor mat fasteners and do not interfere with the free movement of the pedals.*

- ▶ Make sure that the floor mats are properly secured and cannot move and interfere with the pedals ⇒ .

Use only floor mats that leave the pedal area unobstructed and that are firmly secured so that they cannot slip out of position. You can obtain suitable floor mats from your authorized Audi dealer.

Floor mat fasteners are installed in your Audi.

Floor mats used in your vehicle must be attached to these fasteners. Properly securing the floor ▶

mats will prevent them from sliding into positions that could interfere with the pedals or impair safe operation of your vehicle in other ways.

### WARNING

Pedals that cannot move freely can result in a loss of vehicle control and increase the risk of serious personal injury.

- Always make sure that floor mats are properly secured.
- Never place or install floor mats or other floor coverings in the vehicle that cannot be properly secured in place to prevent them from slipping and interfering with the pedals or the ability to control the vehicle.
- Never place or install floor mats or other floor coverings on top of already installed floor mats. Additional floor mats and other coverings will reduce the size of the pedal area and interfere with the pedals.
- Always properly reinstall and secure floor mats that have been taken out for cleaning.
- Always make sure that objects cannot fall into the driver footwell while the vehicle is moving. Objects can become trapped under the brake pedal and accelerator pedal causing a loss of vehicle control.

## Storing cargo correctly

### Loading the luggage compartment

All luggage and other objects must be properly stowed and secured in the luggage compartment.

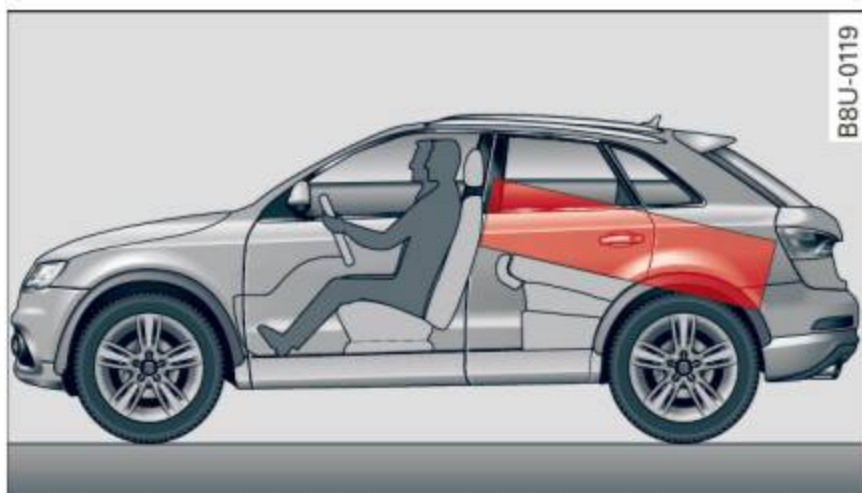

**Fig. 100** Safe load positioning: place heavy objects as low and as far forward as possible.

Loose items in the luggage compartment can shift suddenly, changing vehicle handling characteristics. Loose items can also increase the risk of serious personal injury in a sudden vehicle maneuver or in a collision.

- ▶ Distribute the load evenly in the luggage compartment.
- ▶ Always place and properly secure heavy items in the luggage compartment as low and as far forward as possible ⇒ *fig. 100*.
- ▶ Secure luggage using the tie-downs provided ⇒ *page 47*.
- ▶ Make sure that the rear seatback is securely latched in place.

### WARNING

Improperly stored luggage or other items can fly through the vehicle causing serious personal injury in the event of hard braking or an accident. To help reduce the risk of serious personal injury:

- Always put objects, for example, luggage or other heavy items in the luggage compartment.
- Always secure objects in the luggage compartment using the tie-down eyelets and suitable straps.

### WARNING

Heavy loads will influence the way your vehicle handles. To help reduce the risk of a loss of control leading to serious personal injury:

- Always keep in mind when transporting heavy objects, that a change in the center of gravity can also cause changes in vehicle handling:
  - Always distribute the load as evenly as possible.
  - Place heavy objects as far forward in the luggage compartment as possible.
- Never exceed the Gross Axle Weight Rating or the Gross Vehicle Weight Rating specified on the safety compliance sticker on the left door jamb. Exceeding permissible weight standards can cause the vehicle to slide and handle differently.



- Please observe information on safe driving ⇒ page 97.

### WARNING

To help prevent poisonous exhaust gas from being drawn into the vehicle, always keep the rear lid closed while driving.

- Never transport objects larger than those fitting completely into the luggage area because the rear lid cannot be fully closed.
- If you absolutely must drive with the rear lid open, observe the following notes to reduce the risk of poisoning:
  - Close all windows,
  - Close the Panoramic sliding sunroof\*,
  - Open all air outlets in the instrument panel,
  - Switch off the air recirculation,
  - Set the fresh air fan to the highest speed.

### WARNING

Always make sure that the doors, all windows, the Panoramic sliding sunroof\* and the rear lid are securely closed and locked to reduce the risk of injury when the vehicle is not being used.

- After closing the rear lid, always make sure that it is properly closed and locked.
- Never leave your vehicle unattended especially with the rear lid left open. A child could crawl into the vehicle through the luggage compartment and close the rear lid becoming trapped and unable to get out. Being trapped in a vehicle can lead to serious personal injury.
- Never let children play in or around the vehicle.
- Never let passengers ride in the luggage compartment. Vehicle occupants must always be properly restrained in one of the vehicle's seating positions.

### Tips

- Air circulation helps to reduce window fogging. Stale air escapes to the outside through vents in the trim panel. Be sure to keep these slots free and open.

- The tire pressure must correspond to the load. The tire pressure is shown on the tire pressure label. The tire pressure label is located on the driver's side B-pillar. The tire pressure label lists the recommended cold tire inflation pressures for the vehicle at its maximum capacity weight and the tires that were on your vehicle at the time it was manufactured. For recommended tire pressures for normal load conditions, please see chapter ⇒ page 176.

### Tie-downs

*The luggage compartment is equipped with four tie-downs to secure luggage and other items.*

Use the tie-downs to secure your cargo properly ⇒ page 102, *Loading the luggage compartment.*

In a collision, the laws of physics mean that even smaller items that are loose in the vehicle will become heavy missiles that can cause serious injury. Items in the vehicle possess energy which vary with vehicle speed and the weight of the item. Vehicle speed is the most significant factor.

For example, in a frontal collision at a speed of 30 mph (48 km/h), the forces acting on a 10-lb (4.5 kg) object are about 20 times the normal weight of the item. This means that the weight of the item would suddenly be about 200 lbs. (90 kg). You can imagine the injuries that a 200 lbs. (90 kg) item flying freely through the passenger compartment could cause in a collision like this.

### WARNING

Weak, damaged or improper straps used to secure items to tie-downs can fail during hard braking or in a collision and cause serious personal injury.

- Always use suitable mounting straps and properly secure items to the tie-downs in the luggage compartment to help prevent items from shifting or flying forward as dangerous missiles.
- When the rear seat backrest is folded down, always use suitable mounting straps and properly secure items to the tie-downs in

the luggage compartment to help prevent items from flying forward as dangerous missiles into the passenger compartment.  
– Never attach a child safety seat tether strap to a tie-down.

## Reporting Safety Defects

### Applicable to U.S.A.

If you believe that your vehicle has a defect which could cause a crash or could cause injury or death, you should immediately inform the National Highway Traffic Safety Administration (NHTSA) in addition to notifying Audi of America, Inc.

If NHTSA receives similar complaints, it may open an investigation, and if it finds that a safety defect exists in a group of vehicles, it may order a recall and remedy campaign. However, NHTSA cannot become involved in individual problems between you, your dealer, or Audi of America, Inc.

To contact the NHTSA, you may either call:

Tel.: 1-888-327-4236 (TTY:  
1-800-424-9153) or  
1-800-424-9393

or you may write to:

NHTSA

U.S. Department of Transportation

1200 New Jersey Ave., S.E.

West Building

Washington, DC 20590

You can also obtain other information about motor vehicle safety from:

<http://www.safercar.gov>

### Applicable to Canada

If you live in Canada and you believe that your vehicle has a defect that could cause a crash, injury or death, you should immediately inform Transport Canada, Defect Investigations and Recalls. You should also notify Audi Canada.

Canadian customers who wish to report a safety-related defect to Transport Canada, Defect Investigations and Recalls, may either call Transport Canada toll-free at:

Tel.: 1-800-333-0510 or

Tel.: 1-819-994-3328 (Ottawa region and from other countries)

TTY for hearing impaired:

1-888-675-6863

or contact Transport Canada by mail at: 

Transport Canada  
Motor Vehicle Safety Investiga-  
tions Laboratory  
80 Noel Street  
Gatineau, QC  
J8Z 0A1

For additional road safety infor-  
mation, please visit the Road  
Safety website at:

[http://www.tc.gc.ca/eng/  
roadsafety/menu.htm](http://www.tc.gc.ca/eng/roadsafety/menu.htm)

## Safety belts

### General information

#### Always wear safety belts!

*Wearing safety belts correctly saves lives!*

This chapter explains why safety belts are necessary, how they work and how to adjust and wear them correctly.

- ▶ Read all the information that follows and heed all of the instructions and WARNINGS.

#### WARNING

Not wearing safety belts or wearing them improperly increases the risk of serious personal injury and death.

- Safety belts are the single most effective means available to reduce the risk of serious injury and death in automobile accidents. For your protection and that of your passengers, always correctly wear safety belts when the vehicle is moving.
- Pregnant women, injured, or physically impaired persons must also use safety belts. Like all vehicle occupants, they are more likely to be seriously injured if they do not wear safety belts. The best way to protect a fetus is to protect the mother - throughout the entire pregnancy.

#### Number of seats

Your Audi has a total of five seating positions: two in the front and three in the rear. Each seating position has a safety belt.

#### WARNING

Not wearing safety belts or wearing them improperly increases the risk of serious personal injury and death.

- Never strap more than one person, including small children, into any belt. It is especially dangerous to place a safety belt over a child sitting on your lap.
- Never let more people ride in the vehicle than there are safety belts available.

- Be sure everyone riding in the vehicle is properly restrained with a separate safety belt or child restraint.

#### Safety belt warning light

*Your vehicle has a warning system for the driver and front seat passenger to remind you about the importance of buckling-up.*



Fig. 101 Safety belt warning light in the instrument cluster - enlarged

#### Before driving off, always:

- ▶ Fasten your safety belt and make sure you are wearing it properly.
- ▶ Make sure that your passengers also buckle up and properly wear their safety belts.
- ▶ Protect your children with a child restraint system appropriate for the size and age of the children.

The warning light  in the instrument cluster lights up when the ignition is switched on as a reminder to fasten the safety belts. In addition, you will hear a warning tone for a certain period of time.

**Fasten your safety belt now and make sure that your passengers also properly put on their safety belts.**

#### WARNING

- Safety belts are the single most effective means available to reduce the risk of serious injury and death in automobile accidents. For your protection and that of your passengers, always correctly wear safety belts when the vehicle is moving.

– Failure to pay attention to the warning light that come on, could lead to personal injury.

## Why use safety belts?

### Frontal collisions and the law of physics

Frontal crashes create very strong forces for people riding in vehicles.



Fig. 102 Unbelted occupants in a vehicle heading for a wall



Fig. 103 The vehicle crashes into the wall

The physical principles are simple. Both the vehicle and the passengers possess energy which varies with vehicle speed and body weight. Engineers call this energy “kinetic energy.”

The higher the speed of the vehicle and the greater the vehicle's weight, the more energy that has to be “absorbed” in the crash.

Vehicle speed is the most significant factor. If the speed doubles from 15 to 30 mph (25 to 50 km/h), the energy increases 4 times!

Because the passengers of this vehicle are not using safety belts ⇒ fig. 102, they will keep moving at the same speed the vehicle was moving just before the crash, until something stops them - here, the wall ⇒ fig. 103.

The same principles apply to people sitting in a vehicle that is involved in a frontal collision. Even at city speeds of 20 to 30 mph (30 to 50 km/h), the forces acting on the body can reach one ton (2,000 lbs. or 1,000 kg) or more. At greater speeds, these forces are even higher.

People who do not use safety belts are also not attached to their vehicle. In a frontal collision they will also keep moving forward at the speed their vehicle was travelling just before the crash. Of course, the laws of physics don't just apply to frontal collisions, they determine what happens in all kinds of accidents and collisions.

### What happens to occupants not wearing safety belts?

*In crashes unbelted occupants cannot stop themselves from flying forward and being injured or killed. Always wear your safety belts!*



Fig. 104 A driver not wearing a safety belt is violently thrown forward



Fig. 105 A rear passenger not wearing a safety belt will fly forward and strike the driver

Unbelted occupants are not able to resist the tremendous forces of impact by holding tight or bracing themselves. Without the benefit of safety restraint systems, the unrestrained occupant will slam violently into the steering wheel, ▶

instrument panel, windshield, or whatever else is in the way ⇒ *fig. 104*. This impact with the vehicle interior has all the energy they had just before the crash.

Never rely on airbags alone for protection. Even when they deploy, airbags provide only additional protection. Airbags are not supposed to deploy in all kinds of accidents. Although your Audi is equipped with airbags, all vehicle occupants, including the driver, must wear safety belts correctly in order to minimize the risk of severe injury or death in a crash.

Remember too, that airbags will deploy only once and that your safety belts are always there to offer protection in those accidents in which airbags are not supposed to deploy or when they have already deployed. Unbelted occupants can also be thrown out of the vehicle where even more severe or fatal injuries can occur.

It is also important for the rear passengers to wear safety belts correctly. Unbelted passengers in the rear seats endanger not only themselves but also the driver and other passengers ⇒ *fig. 105*. In a frontal collision they will be thrown forward violently, where they can hit and injure the driver and/or front seat passenger.

### Safety belts protect

*People think it's possible to use the hands to brace the body in a minor collision. It's simply not true!*



**Fig. 106** Driver is correctly restrained in a sudden braking maneuver

Safety belts used properly can make a big difference. Safety belts help to keep passengers in their seats, gradually reduce energy levels ap-

plied to the body in an accident, and help prevent the uncontrolled movement that can cause serious injuries. In addition, safety belts reduce the danger of being thrown out of the vehicle.

Safety belts attach passengers to the car and give them the benefit of being slowed down more gently or “softly” through the “give” in the safety belts, crush zones and other safety features engineered into today’s vehicles. By “absorbing” the kinetic energy over a longer period of time, the safety belts make the forces on the body more “tolerable” and less likely to cause injury.

Although these examples are based on a frontal collision, safety belts can also substantially reduce the risk of injury in other kinds of crashes. So, whether you're on a long trip or just going to the corner store, always buckle up and make sure others do, too. Accident statistics show that vehicle occupants properly wearing safety belts have a lower risk of being injured and a much better chance of surviving an accident. Properly using safety belts also greatly increases the ability of the supplemental airbags to do their job in a collision. For this reason, wearing a safety belt is legally required in most countries including much of the United States and Canada.

Although your Audi is equipped with airbags, you still have to wear the safety belts provided. Front airbags, for example, are activated only in some frontal collisions. The front airbags are not activated in all frontal collisions, in side and rear collisions, in roll overs or in cases where there is not enough deceleration through impact to the front of the vehicle. The same goes for the other airbag systems in your Audi. So, always wear your safety belt and make sure everybody in your vehicle is properly restrained!

### Important safety instructions about safety belts

*Safety belts must always be correctly positioned across the strongest bones of your body.*

- ▶ Always wear safety belts as illustrated and described in this chapter.
- ▶ Make sure that your safety belts are always ready for use and are not damaged.

**! WARNING**

Not wearing safety belts or wearing them improperly increases the risk of serious personal injury and death. Safety belts can work only when used correctly.

- Always fasten your safety belts correctly before driving off and make sure all passengers are correctly restrained.
- For maximum protection, safety belts must always be positioned properly on the body.
- Never strap more than one person, including small children, into any belt.
- Never place a safety belt over a child sitting on your lap.
- Always keep feet in the footwell in front of the seat while the vehicle is being driven.
- Never let any person ride with their feet on the instrument panel or sticking out the window or on the seat.
- Never remove a safety belt while the vehicle is moving. Doing so will increase your risk of being injured or killed.
- Never wear belts twisted.
- Never wear belts over rigid or breakable objects in or on your clothing, such as eye glasses, pens, keys, etc., as these may cause injury.
- Never allow safety belts to become damaged by being caught in door or seat hardware.
- Do not wear the shoulder part of the belt under your arm or otherwise out of position.
- Several layers of heavy clothing may interfere with correct positioning of belts and reduce the overall effectiveness of the system.
- Always keep belt buckles free of anything that may prevent the buckle from latching securely.
- Never use comfort clips or devices that create slack in the shoulder belt. However, special clips may be required for the proper use of some child restraint systems.
- Torn or frayed safety belts can tear, and damaged belt hardware can break in an accident. Inspect belts regularly. If webbing, bindings, buckles, or retractors are dam-

aged, have belts replaced by an authorized Audi dealer or qualified workshop.

- Safety belts that have been worn and loaded in an accident must be replaced with the correct replacement safety belt by an authorized Audi dealer. Replacement may be necessary even if damage cannot be clearly seen. Anchorages that were loaded must also be inspected.
- Never remove, modify, disassemble, or try to repair the safety belts yourself.
- Always keep the belts clean. Dirty belts may not work properly and can impair the function of the inertia reel ⇒ *table Interior cleaning on page 187.*

## Safety belts

### Fastening safety belts

*Safety first - everybody buckle up!*



**Fig. 107** Belt buckle and tongue on the driver's seat

To provide maximum protection, safety belts must always be positioned correctly on the wearer's body.

- ▶ Adjust the front seat and head restraint properly ⇒ *page 42, Front seats.*
- ▶ Make sure the seatback of the rear seat bench is in an upright position and securely latched in place before using the belt ⇒ **!**
- ▶ Pull the safety belt evenly across the chest and pelvis ⇒ **!**
- ▶ Insert the tongue into the correct buckle of your seat until you hear it latch securely.
- ▶ Pull on the belt to make sure that it is securely latched in the buckle.

### Automatic safety belt retractors

Every safety belt is equipped with an automatic belt retractor on the shoulder belt. This feature locks the belt when the belt is pulled out fast, during hard braking and in an accident. The belt may also lock when you drive up or down a steep hill or through a sharp curve. During normal driving the belt lets you move freely.

### Safety belt pretensioners

Safety belts with pretensioners help to tighten the safety belt and remove slack when the pretensioners are activated ⇒ *page 112*. The function of the pretensioner is monitored by a warning light ⇒ *page 14*.

### Convertible locking retractor

Every safety belt except the one on the driver seat is equipped with a convertible locking retractor that **must** be used when the safety belt is used to attach a child safety seat. Be sure to read the important information about this feature ⇒ *page 144*.

#### **WARNING**

Improperly positioned safety belts can cause serious injury in an accident ⇒ *page 110*, *Safety belt position*.

- Safety belts offer optimum protection only when the seatback is upright and belts are properly positioned on the body.
- Always make sure that the rear seat backrest to which the center rear safety belt is attached is securely latched whenever the rear center safety belt is being used. If the backrest is not securely latched, the passenger will move forward with the backrest during sudden braking, in a sudden maneuver and especially in a crash.
- Never attach the safety belt to the buckle for another seat. Attaching the belt to the wrong buckle will reduce safety belt effectiveness and can cause serious personal injury.
- A passenger who is not properly restrained can be seriously injured by the safety belt itself when it moves from the stronger parts

of the body into critical areas like the abdomen.

- Always lock the convertible locking retractor when you are securing a child safety seat in the vehicle ⇒ *page 146*.

### Safety belt position

*Correct belt position is the key to getting maximum protection from safety belts.*

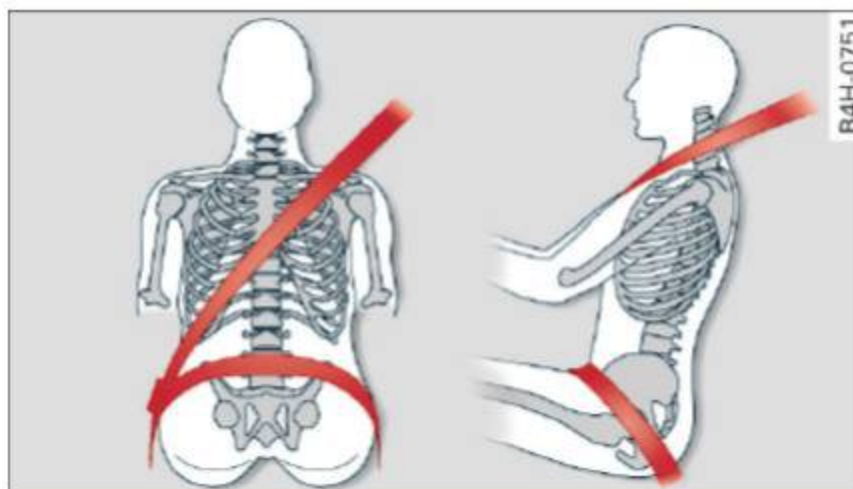

**Fig. 108** Safety belt position

Standard features on your vehicle help you adjust the position of the safety belt to match your body size.

- belt height adjustment for the front seats,
- height-adjustable front seats.

#### **WARNING**

Improperly positioned safety belts can cause serious personal injury in an accident.

- The shoulder belt should lie as close to the center of the collar bone as possible and should fit well on the body. Hold the belt above the latch tongue and pull it evenly across the chest so that it sits as low as possible on the pelvis and there is no pressure on the abdomen. The belt should always fit snugly ⇒ *fig. 108*. Pull on the belt to tighten if necessary.
- The lap belt portion of the safety belt must be positioned as low as possible across pelvis and never over the abdomen. Make sure the belt lies flat and snug ⇒ *fig. 108*. Pull on the belt to tighten if necessary.
- A loose-fitting safety belt can cause serious injuries by shifting its position on your body



from the strong bones to more vulnerable, soft tissue and cause serious injury.  
 – Always read and heed all WARNINGS and other important information ⇒ *page 108*.

**Pregnant women must also be correctly restrained**

The best way to protect the fetus is to make sure that expectant mothers always wear safety belts correctly - throughout the pregnancy.



Fig. 109 Safety belt position during pregnancy

To provide maximum protection, safety belts must always be positioned correctly on the wearer's body ⇒ *page 110*.

- ▶ Adjust the front seat and head restraint correctly ⇒ *page 42, Front seats*.
- ▶ Make sure the seatback of the rear seat bench is in an upright position and securely latched in place before using the belt.
- ▶ Pull the safety belt evenly across the chest so that it sits as low as possible on the pelvis and there is no pressure on the abdomen ⇒ *fig. 109*, ⇒ ⚠.
- ▶ Insert the tongue into the correct buckle of your seat until you hear it latch securely.
- ▶ Pull on the belt to make sure that it is securely latched in the buckle.

**⚠ WARNING**

Improperly positioned safety belts can cause serious personal injury in an accident.  
 – Expectant mothers must always wear the lap portion of the safety belt as low as possible across the pelvis and below the rounding of the abdomen.

– Always read and heed all WARNINGS and other important information ⇒ ⚠ in *Fastening safety belts on page 110*.

**Unfastening safety belts**

Unbuckle the safety belt with the red release button only after the vehicle has stopped.

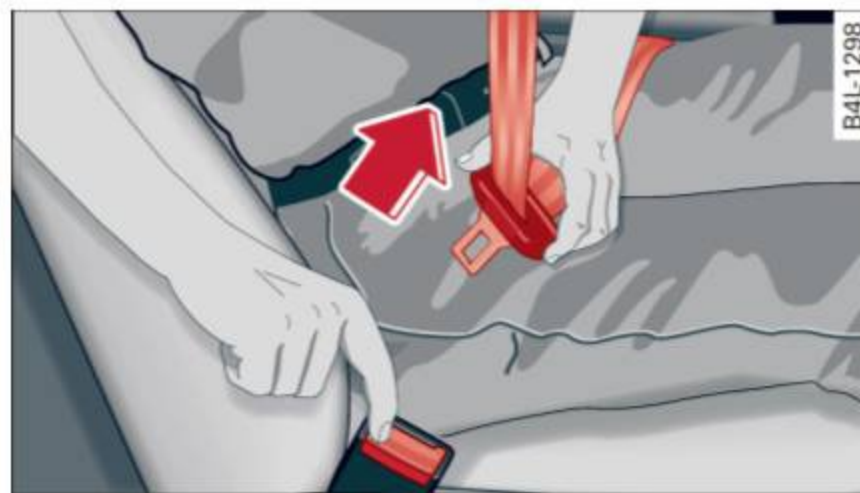

Fig. 110 Releasing the tongue from the buckle

- ▶ Push the red release button on the buckle ⇒ *fig. 110*. The belt tongue will spring out of the buckle ⇒ ⚠.
- ▶ Let the belt wind up on the retractor as you guide the belt tongue to its stowed position.

**⚠ WARNING**

Never unfasten safety belt while the vehicle is moving. Doing so will increase your risk of being injured or killed.

**Adjusting safety belt height**

With the aid of the safety belt height adjustment, the three point safety belt strap routing can be fitted to the shoulder area, according to body size.

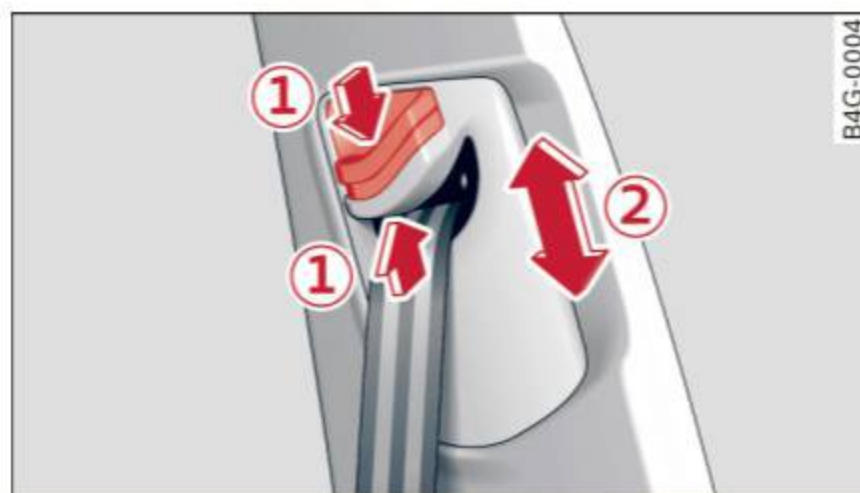





Fig. 111 Safety belt height adjustment for the front seats - loop-around fittings

## Safety belts

The shoulder belt should lie as close to the center of the collar bone as possible and should fit well on the body ⇒  in *Safety belt position on page 110*.

- ▶ Push the loop-around fittings **up** ⇒ *fig. 111* , or
- ▶ squeeze together the  button, and push the loop-around fittings **down** .
- ▶ Pull the belt to make sure that the upper attachment is properly engaged.

### **WARNING**

Always read and heed all WARNINGS and other important information ⇒ *page 108*.

### **Tips**

With the front seats, the height adjustment of the seat can also be used to adjust the position of the safety belts.

## Improperly worn safety belts

*Incorrectly positioned safety belts can cause severe injuries.*

Wearing safety belts improperly can cause serious injury or death. Safety belts can only work when they are correctly positioned on the body. Improper seating positions reduce the effectiveness of safety belts and will even increase the risk of injury and death by moving the safety belt to critical areas of the body. Improper seating positions also increase the risk of serious injury and death when an airbag deploys and strikes an occupant who is not in the correct seating position. A driver is responsible for the safety of all vehicle occupants and especially for children. Therefore:

- ▶ Never permit anyone to assume an incorrect sitting position in the vehicle while traveling ⇒ .

### **WARNING**

Improperly worn safety belts increase the risk of serious personal injury and death whenever a vehicle is being used.

- Always make sure that all vehicle occupants are correctly restrained and stay in a correct seating position whenever the vehicle is being used.
- Always read and heed all WARNINGS and other important information ⇒ *page 108*.

## Belt tensioners

### How safety belt pretensioners work

Seat belts with pyrotechnic safety belt pretensioners are tensioned automatically in severe collisions, depending on the circumstances. This helps to reduce the forward motion of the occupants.

### **WARNING**

- It is possible for the pretensioners to deploy incorrectly.
- Any work on the tensioner system or removal and installation of system components for other repairs must be performed by a qualified workshop.
- The pyrotechnic system can only provide protection for one collision. If the pyrotechnic pretensioners deploy, the pretensioning system must be replaced.

### **Note**

Never let the belt remain over a rear seatback that has been folded forward.

### **Tips**

- A fine dust is released when the pyrotechnic safety belt pretensioners deploy. This is normal and is not caused by a fire in the vehicle.
- The relevant safety requirements must be observed when the vehicle or components of the system are scrapped. A qualified dealership is familiar with these regulations and will be pleased to pass on the information to you.

### Service and disposal of safety belt pretensioner

The safety belt pretensioners are parts of the safety belts on your Audi. Installing, removing, servicing or repairing of belt pretensioners can damage the safety belt system and prevent it from working correctly in a collision.

There are some important things you have to know to make sure that the effectiveness of the system will not be impaired and that discarded components do not cause injury or pollute the environment.



#### WARNING

Improper care, servicing and repair procedures can increase the risk of personal injury and death by preventing a safety belt pretensioner from activating when needed or activating it unexpectedly:

- The belt pretensioner system can be activated only once. If belt pretensioners have been activated, the system must be replaced.
- Never repair, adjust, or change any parts of the safety belt system.
- Safety belt systems including safety belt pretensioners cannot be repaired. Special procedures are required for removal, installation and disposal of this system.
- For any work on the safety belt system, we strongly recommend that you see your authorized Audi dealer or qualified technician who has an Audi approved repair manual, training and special equipment necessary.



#### For the sake of the environment

Undeployed airbag modules and pretensioners might be classified as Perchlorate Material -special handling may apply, see [www.dtsc.ca.gov/hazardouswaste/perchlorate](http://www.dtsc.ca.gov/hazardouswaste/perchlorate). When the vehicle or parts of the restraint system including airbag modules safety belts with pretensioners are scrapped, all applicable laws and regulations must be observed. Your authorized Audi dealer is familiar with these requirements and we recommend

that you have your dealer perform this service for you.

# Airbag system

## Important information

### Importance of wearing safety belts and sitting properly

*Airbags are only supplemental restraints. For airbags to do their job, occupants must always properly wear their safety belts and be in a proper seating position.*

For your safety and the safety of your passengers, before driving off, always:

- ▶ Adjust the driver's seat and steering wheel properly ⇒ *page 98*,
- ▶ Adjust the front passenger's seat properly ⇒ *page 99*,
- ▶ Wear safety belts properly ⇒ *page 108*,
- ▶ Always properly use the proper child restraint to protect children ⇒ *page 134*.

In a collision airbags must inflate within the blink of an eye and with considerable force. The supplemental airbags can cause injuries if the driver or the front seat passenger is not seated properly. Therefore in order to help the airbag to do its job, it is important, both as a driver and as a passenger to sit properly at all times.

By keeping room between your body and the steering wheel and the front of the passenger compartment, the airbag can inflate fully and completely and provide supplemental protection in certain frontal collisions ⇒ *page 98, Correct passenger seating positions*. For details on the operation of the seat adjustment controls ⇒ *page 42*.

It's especially important that children are properly restrained ⇒ *page 134*.

There is a lot that the driver and the passengers can and must do to help the individual safety features installed in your Audi work together as a system.

Proper seating position is important so that the front airbag on the driver side can do its job. If you have a physical impairment or condition that prevents you from sitting properly on the driver seat with the safety belt properly fastened and

reaching the pedals, special modifications to your vehicle may be necessary.

Contact your authorized Audi dealer, or call Audi Customer Relations at 1-800-822-2834.

When the airbag system deploys, a gas generator will fill the airbags, break open the padded covers, and inflate between the steering wheel and the driver and between the instrument panel and the front passenger. The airbags will deflate immediately after deployment so that the front occupants can see through the windshield again without interruption.

All of this takes place in the blink of an eye, so fast that many people don't even realize that the airbags have deployed. The airbags also inflate with a great deal of force and nothing should be in their way when they deploy. Front airbags in combination with properly worn safety belts slow down and limit the occupant's forward movement. Together they help to prevent the driver and front seat passenger from hitting parts of the inside the vehicle while reducing the forces acting on the occupant during the crash. In this way they help to reduce the risk of injury to the head and upper body in the crash. Airbags do not protect the arms or the lower parts of the body.

Both front airbags will not inflate in all frontal collisions. The triggering of the airbag system depends on the vehicle deceleration rate caused by the collision and registered by the electronic control unit. If this rate is below the reference value programmed into the control unit, the airbags will not be triggered, even though the car may be badly damaged as a result of the collision. Vehicle damage, repair costs or even the lack of vehicle damage is not necessarily an indication of whether an airbag should inflate or not.

It is not possible to define a range of vehicle speeds that will cover every possible kind and angle of impact that will always trigger the airbags, since the circumstances will vary considerably between one collision and another. Important factors include, for example, the nature (hard or soft) of the object which the car hits, the angle of impact, vehicle speed, etc. The front airbags will ►

also not inflate in side or rear collisions, or in roll-overs.

**Always remember:** Airbags will deploy only once, and only in certain kinds of collisions. Your safety belts are always there to offer protection in those situations in which airbags are not supposed to deploy, or when they have already deployed; for example, when your vehicle strikes or is struck by another after the first collision.

This is just one of the reasons why an airbag is a supplementary restraint and is not a substitute for a safety belt. The airbag system works most effectively when used with the safety belts. Therefore, always properly wear your safety belts ⇒ *page 106*.

### WARNING

Sitting too close to the steering wheel or instrument panel will decrease the effectiveness of the airbags and will increase the risk of personal injury in a collision.

- Never sit closer than 10 inches (25 cm) to the steering wheel or instrument panel.
- If you cannot sit more than 10 inches (25 cm) from the steering wheel, investigate whether adaptive equipment may be available to help you reach the pedals and increase your seating distance from the steering wheel.
- All vehicle occupants and especially children must be restrained properly whenever riding in a vehicle. An unrestrained or improperly restrained child could be injured by striking the interior or by being ejected from the vehicle during a sudden maneuver or impact. An unrestrained or improperly restrained child is also at greater risk of injury or death through contact with an inflating airbag.
- If you are unrestrained, leaning forward, sitting sideways or out of position in any way, your risk of injury is much higher.
- You will also receive serious injuries and could even be killed if you are up against the airbag or too close to it when it inflates - even with an Advanced Airbag.

- To reduce the risk of injury when an airbag inflates, always wear safety belts properly ⇒ *page 109, Safety belts*.
- Always make certain that children age 12 or younger always ride in the rear seat. If children are not properly restrained, they may be severely injured or killed when an airbag inflates.
- Never let children ride unrestrained or improperly restrained in the vehicle. Adjust the front seats properly.
- Never ride with the backrest reclined.
- Always sit as far as possible from the steering wheel or the instrument panel ⇒ *page 98*.
- Always sit upright with your back against the backrest of your seat.
- Never place your feet on the instrument panel or on the seat. Always keep both feet on the floor in front of the seat to help prevent serious injuries to the legs and hips if the airbag inflates.
- Never recline the front passenger's seat to transport objects. Items can also move into the area of the side airbag or the front airbag during braking or in a sudden maneuver. Objects near the airbags can become projectiles and cause injury when an airbag inflates.

### WARNING

Airbags that have deployed in a crash must be replaced.

- Use only original equipment airbags approved by Audi and installed by a trained technician who has the necessary tools and diagnostic equipment to properly replace any airbag in your vehicle and assure system effectiveness in a crash.
- Never permit salvaged or recycled airbags to be installed in your vehicle.

### Child restraints on the front seat – some important things to know

- ▶ Be sure to read the important information and heed the WARNINGS for important details ▶

about children and Advanced Airbags  
⇒ *page 134*.

Even though your vehicle is equipped with an Advanced Airbag System, make certain that all children, especially those 12 years and younger, always ride in the back seat properly restrained for their age and size. The airbag on the passenger side makes the front seat a potentially dangerous place for a child to ride. The front seat is not the safest place for a child in a forward-facing child safety seat. It can be a very dangerous place for an infant or a child in a rearward-facing seat.

The Advanced Airbag System in your vehicle has been certified to comply with the requirements of United States Federal Motor Vehicle Safety Standard (FMVSS) 208, as well as Canada Motor Vehicle Safety Standard (CMVSS) 208 as applicable at the time your vehicle was manufactured. According to requirements, the front Advanced Airbag System on the passenger side has been certified for “suppression” for infants of about 12 month old and younger and for “low risk deployment” for children aged 3 to 6 years old (as defined in the standard).

The **PASSENGER AIR BAG OFF** light in the instrument panel tells you when the front Advanced Airbag on the passenger side has been turned off by the electronic control unit.

Each time you switch on the ignition, the **PASSENGER AIR BAG OFF** light will come on for a few seconds and:

- will stay on if the front passenger seat is not occupied,
- will stay on if there is a small child or child restraint on the front passenger seat,
- will go off if the front passenger seat is occupied by an adult as registered by the weight-sensing mat ⇒ *page 124, Monitoring the Advanced Airbag System*.

The **PASSENGER AIR BAG OFF** light comes on when the control unit detects a total weight on the front passenger seat that requires the front airbag to be turned off.

If the total weight on the front passenger seat is more than that of a typical 1 year-old child but

less than the weight of a small adult, the front airbag on the passenger side can deploy (the **PASSENGER AIR BAG OFF** light does not come on). If the **PASSENGER AIR BAG OFF** light does not come on, the front airbag on the passenger side has not been turned off by the electronic control unit and can deploy if the control unit senses an impact that meets the conditions stored in its memory.

**For example, the airbag may deploy if:**

- a small child that is heavier than a typical 1 year-old child is on the front passenger seat (regardless of whether the child is in one of the child safety seats listed ⇒ *page 136*), or
- a child who has outgrown child restraints is on the front passenger seat.

If the front passenger airbag is turned off, the **PASSENGER AIR BAG OFF** light comes on in the instrument cluster and stays on.

The front airbag on the passenger side may *not* deploy (the **PASSENGER AIR BAG OFF** light does not illuminate and stay lit) even if a small adult or teenager, or a passenger who is not sitting upright with their back against a non-reclined backrest with their feet on the vehicle floor in front of the seat is on the front passenger seat  
⇒ *page 98, Proper seating position for the driver*.

If the front passenger airbag deploys, the Federal Standard requires the airbag to meet the “low risk” deployment criteria to reduce the risk of injury through interaction with the airbag. “Low risk” deployment occurs in those crashes that take place at lower decelerations as defined in the electronic control unit ⇒ *page 125, PASSENGER AIR BAG OFF light*.

Always remember, a child safety seat or infant carrier installed on the front seat may be struck and knocked out of position by the rapidly inflating passenger's airbag in a frontal collision. The airbag could greatly reduce the effectiveness of the child restraint and even seriously injure the child during inflation.

For this reason, and because the back seat is the safest place for children - when properly restrained according to their age and size - we strongly ►

recommend that children always sit in the back seat ⇒ *page 134, Child safety.*

### WARNING

A child in a rearward-facing child safety seat installed on the front passenger seat will be seriously injured and can be killed if the front airbag inflates - even with an Advanced Airbag System.

- The inflating airbag will hit the child safety seat or infant carrier with great force and will smash the child safety seat and child against the backrest, center armrest, door or roof.
- Always install rear-facing child safety seats on the rear seat.
- If you must install a rearward facing child safety seat on the front passenger seat because of exceptional circumstances and the **PASSENGER AIR BAG OFF** light does not come on and stay on, immediately install the rear-facing child safety seat in a rear seating position and have the airbag system inspected by your authorized Audi dealer.
- Forward-facing child safety seats installed on the front passenger's seat may interfere with the deployment of the airbag and cause serious personal injury to the child.

### WARNING

If, in exceptional circumstances, you must install a forward-facing child restraint on the front passenger's seat:

- Always make sure the forward-facing seat has been designed and certified by its manufacturer for use on a front seat with a passenger front and side airbag.
- Never put the forward-facing child restraint up against or very near the instrument panel.
- Always move the front passenger seat to the highest position in the up and down adjustment range and move it back to the rearmost position in the seat's fore and aft adjustment range, as far away from the airbag as possible, before installing the forward-facing child restraint.

- Always make sure that the safety belt upper anchorage is behind the child restraint and not next to or in front of the child restraint so that the safety belt will be properly positioned.
- Make sure that the **PASSENGER AIR BAG OFF** light comes on and stays on all the time whenever the ignition is switched on.

### WARNING

To reduce the risk of serious injury, make sure that the **PASSENGER AIR BAG OFF** light will be displayed whenever a child restraint is installed on the front passenger seat and the ignition is switched on.

- If the **PASSENGER AIR BAG OFF** light does not stay on, perform the checks described ⇒ *page 124, Monitoring the Advanced Airbag System.*
- Take the child restraint off the front passenger seat and install it properly at one of the rear seat positions if the **PASSENGER AIR BAG OFF** light does not stay on.
- Have the airbag system inspected by your authorized Audi dealer immediately.
- Always carefully follow instructions from child restraint manufacturers when installing child restraints.

### WARNING

If, in exceptional circumstances, you must install a forward or rearward-facing child restraint on the front passenger's seat:

- Improper installation of child restraints can reduce their effectiveness or even prevent them from providing any protection.
- An improperly installed child restraint can interfere with the airbag as it deploys and seriously injure or even kill the child - even with an Advanced Airbag System.
- Always carefully follow the manufacturer's instructions provided with the child safety seat or carrier.
- Never place additional items on the seat that can increase the total weight registered by the weight-sensing mat and can cause injury in a crash.

## Front airbags

### Description of front airbags

The airbag system can provide supplemental protection to properly restrained front seat occupants.



Fig. 112 Location of driver airbag: in steering wheel



Fig. 113 Location of front passenger's airbag: in the instrument panel

Your vehicle is equipped with an “Advanced Airbag System” in compliance with United States Federal Motor Vehicle Safety Standard (FMVSS) 208, as well as Canada Motor Vehicle Safety Standard (CMVSS) 208 as applicable at the time your vehicle was manufactured.

The airbag for the driver is in the steering wheel hub ⇒ *fig. 112* and the airbag for the front passenger is in the instrument panel ⇒ *fig. 113*. The general location of the airbags is marked “AIR-BAG”.

There is a lot you need to know about the airbags in your vehicle. We urge you to read the detailed information about airbags, safety belts and child safety in this and the other chapters that make up the owner's literature. Please be sure to heed the WARNINGS - they are extremely important

for your safety and the safety of your passengers, especially infants and small children.

#### **WARNING**

- Never rely on airbags alone for protection.
- Even when they deploy, airbags provide only supplemental protection.
- Airbags work most effectively when used with properly worn safety belts.
- Therefore, always wear your safety belts and make sure that everybody in your vehicle is properly restrained.

#### **WARNING**

- A person on the front passenger seat, especially infants and small children, will receive serious injuries and can even be killed by being too close to the airbag when it inflates.
- Although the Advanced Airbag System in your vehicle is designed to turn off the front passenger airbag if an infant or a small child is on the front passenger seat, nobody can absolutely guarantee that deployment under these special conditions is impossible in all conceivable situations that may happen during the useful life of your vehicle.
- The Advanced Airbag System can deploy in accordance with the “low risk” option under the U.S. Federal Standard if a child that is heavier than the typical one-year old child is on the front passenger seat and the other conditions for airbag deployment are met.
- Accident statistics have shown that children are generally safer in the rear seat area than in the front seating position.
- For their own safety, all children, especially 12 years and younger, should always ride in the back properly restrained for their age and size.

### Advanced front airbag system

Your vehicle is equipped with a front Advanced Airbag System in compliance with United States Federal Motor Vehicle Safety Standard 208, as well as Canada Motor Vehicle Safety Standard (CMVSS) 208 as applicable at the time your vehicle was manufactured.



The front Advanced Airbag System supplements the safety belts to provide additional protection for the driver's and front passenger's heads and upper bodies in frontal crashes. The airbags inflate only in frontal impacts when the vehicle deceleration is high enough.

The front Advanced Airbag System for the front seat occupants is not a substitute for your safety belts. Rather, it is part of the overall occupant restraint system in your vehicle. Always remember that the airbag system can only help to protect you, if you are sitting upright, wearing your safety belt and wearing it properly. This is why you and your passengers must always be properly restrained, not just because the law requires you to be.

The Advanced Airbag System in your vehicle has been certified to meet the "low risk" requirements for 3 and 6 year-old children on the passenger side and very small adults on the driver side. The low risk deployment criteria are intended to help reduce the risk of injury through interaction with the front airbag that can occur, for example, by being too close to the steering wheel and instrument panel when the airbag inflates.

In addition, the system has been certified to comply with the "suppression" requirements of the Safety Standard, to turn off the front airbag for infants 12 months old and younger who are restrained on the front passenger seat in child restraints that are listed in the Standard  
⇒ *page 136, Child restraints and Advanced Airbags.*

"Suppression" requires the front airbag on the passenger side to be turned off if:

- a child up to about one year of age is restrained on the front passenger seat in one of the rear-facing or forward-facing infant restraints listed in Federal Motor Vehicle Safety Standard 208 with which the Advanced Airbag System in your vehicle was certified. For a listing of the child restraints that were used to certify your vehicle's compliance with the US Safety Standard  
⇒ *page 136,*

- weight less than a threshold level stored in the control unit is detected on the front passenger seat.

When a person is detected on the front passenger seat, weighing more than the total weight of a child that is about 1 year old restrained in one of the rear-facing or forward-facing infant restraints (listed in Federal Motor Vehicle Safety Standard 208 with which the Advanced Airbag System in your vehicle was certified), the front airbag on the passenger side may or may not deploy.

The **PASSENGER AIR BAG OFF** light comes on when the electronic control unit detects a total weight on the front passenger seat that requires the front airbag to be turned off. If the **PASSENGER AIR BAG OFF** light does not come on, the front airbag on the passenger side has not been turned off by the control unit and can deploy if the control unit senses an impact that meets the conditions stored in its memory.

If the total weight on the front passenger seat is more than that of a typical 1 year-old, but less than the weight of a small adult, the front airbag on the passenger side may deploy (the **PASSENGER AIR BAG OFF** light does not come on).

**For example, the airbag may deploy if:**

- a small child that is heavier than a typical 1 year-old child is on the front passenger seat (regardless of whether the child is in one of the child safety seats listed ⇒ *page 136*),
- a child who has outgrown child restraints is on the front passenger seat.

If the front passenger airbag is turned off, the **PASSENGER AIR BAG OFF** light in the center of the instrument panel will come on and stay on.

The front airbag on the passenger side may *not* deploy (the **PASSENGER AIR BAG OFF** light does not illuminate and stay lit) if:

- a small adult or teenager is on the front passenger seat
- a passenger who is not sitting upright with their back against a non-reclined backrest with their feet on the vehicle floor in front of the seat is on the front passenger seat. ►

If the front passenger airbag deploys, the Federal Standard requires the airbag to meet the “low risk” deployment criteria to help reduce the risk of injury through interaction with the airbag. “Low risk” deployment occurs in those crashes that take place at lower decelerations as defined in the electronic control unit. ⇒ *page 124*

**Always remember:** Even though your vehicle is equipped with Advanced Airbags, the safest place for children is properly restrained on the back seat. Please be sure to read the important information in the sections that follow and be sure to heed all of the WARNINGS.

### WARNING

To reduce the risk of injury when an airbag inflates, always wear safety belts properly.

- If you are unrestrained, leaning forward, sitting sideways or out of position in any way, your risk of injury is much higher.
- You will also receive serious injuries and could even be killed if you are up against the airbag or too close to it when it inflates - even with an Advanced Airbag ⇒ *page 114*.

### WARNING

A child in a rearward-facing child safety seat installed on the front passenger seat will be seriously injured and can be killed if the front airbag inflates - even with an Advanced Airbag System.

- Although the Advanced Airbag System in your vehicle is designed to turn off the front airbag when a rearward-facing child restraint has been installed on the front passenger seat, nobody can absolutely guarantee that deployment is impossible in all conceivable situations that may happen during the useful life of your vehicle.
- The inflating airbag will hit the child safety seat or infant carrier with great force and will smash the child safety seat and child against the backrest, center armrest, door, or roof.
- Always install rearward-facing child restraints in the back seat.

– If you must install a rearward facing child safety seat on the front passenger seat because of exceptional circumstances and the **PASSENGER AIR BAG OFF** light does not come on and stay on, immediately install the rear-facing child safety seat in a rear seating position and have the airbag system inspected by your authorized Audi dealer.

### WARNING

If, in exceptional circumstances, you must install a forward-facing child restraint on the front passenger's seat:

- Always make sure the forward-facing seat has been designed and certified by its manufacturer for use on a front seat with a passenger front and side airbag.
- Never put the forward-facing child restraint up against or very near the instrument panel.
- Always move the front passenger seat to the highest position in the up and down adjustment range and move it back to the rearmost position in the seat's fore and aft adjustment range, as far away from the airbag as possible, before installing the forward-facing child restraint.
- Always make sure that the safety belt upper anchorage is behind the child restraint and not next to or in front of the child restraint so that the safety belt will be properly positioned.
- Always move the passenger seat into its rearmost position in the seat's fore and aft adjustment range, as far away from the airbag as possible, before installing the forward-facing child restraint. The backrest must be adjusted to an upright position.
- Make sure that the **PASSENGER AIR BAG OFF** light comes on and stays on all the time whenever the ignition is switched on.

### Advanced Airbag System components

The front passenger seat in your vehicle has a lot of very important parts of the Advanced Airbag System in it. These parts include the weight-sensing mat, sensors, wiring, brackets, and

more. The function of the system in the front passenger seat is checked by the electronic control unit when the ignition is on. The control unit monitors the Advanced Airbag System and turns the airbag indicator light on when a malfunction in the system components is detected. The function of the airbag indicator light is described in greater detail below. Because the front passenger seat contains important parts of the Advanced Airbag System, you must take care to prevent it from being damaged. Damage to the seat may prevent the Advanced Airbag for the front passenger seat from doing its job in a crash.

### The front Advanced Airbag System consists of the following:

- Crash sensors in the front of the vehicle that measure vehicle acceleration/deceleration to provide information to the Advanced Airbag System about the severity of the crash.
- An electronic control unit, with integrated crash sensors for front and side impacts. The control unit “decides” whether to fire the front airbags based on the information received from the crash sensors. The control unit also “decides” whether the safety belt pretensioners should be activated.
- An Advanced Airbag with gas generator and control valve for the driver inside the steering wheel hub.
- An Advanced Airbag with gas generator and control valve inside the instrument panel for the front passenger.
- A weight-sensing mat under the upholstery padding of the front passenger seat cushion that measures the total weight on the seat. The information registered is sent continuously to the electronic control unit to regulate deployment of the front Advanced Airbag on the passenger side.
- An airbag monitoring system and indicator light in the instrument cluster ⇒ *page 124*.
- A sensor in each front seat registers the distance between the respective seat and the steering wheel or instrument panel. The information registered is sent continuously to the electronic control unit to regulate deployment of the front Advanced Airbags.
- The **PASSENGER AIR BAG OFF** light comes on and stays on in the center of the instrument panel ⇒ *page 125, fig. 115* and tells you when the front Advanced Airbag on the passenger side has been turned off.
- A sensor below the safety belt latch for the front seat passenger to measure the tension on the safety belt. The tension on the safety belt and the weight registered by the weight-sensing mat help the control unit “decide” whether the front airbag for the front passenger seat should be turned off or not ⇒ *page 115, Child restraints on the front seat – some important things to know*.
- A sensor in the safety belt latch for the driver and for the front seat passenger that senses whether that safety belt is latched or not and transmits this information to the electronic control unit.

### **WARNING**

- Damage to the front passenger seat can prevent the front airbag from working properly.
- Improper repair or disassembly of the front passenger and driver seat will prevent the Advanced Airbag System from functioning properly.
  - Repairs to the front passenger seat must be performed by qualified and properly trained workshop personnel.
  - Never remove the front passenger or driver seat from the vehicle.
  - Never remove the upholstery from the front passenger seat.
  - Never disassemble or remove parts from the seat or disconnect wires from it.
  - Never carry sharp objects in your pockets or place them on the seat. If the weight-sensing mat in the passenger seat is punctured it cannot work properly.
  - Never carry things on your lap or carry objects on the passenger seat. Such items can increase the weight registered by the weight-sensing mat and send the wrong information to the airbag control unit.
  - Never store items under the front passenger seat. Parts of the Advanced Airbag System under the passenger seat could be

damaged, preventing them and the airbag system from working properly.

- Never place seat covers or replacement upholstery that have not been specifically approved by Audi on the front seats.
- Seat covers can prevent the Advanced Airbag System from recognizing child restraints or occupants on the front passenger seat and prevent the side airbag in the seat backrest from deploying properly.
- Never use cushions, pillows, blankets or similar items on the front passenger seat. The additional padding will prevent the weight-sensing mat in the seat from accurately registering the child restraint or person on the seat and prevent the Advanced Airbag System from functioning properly.
- If you must use a child restraint on the front passenger seat and the child restraint manufacturer's instructions require the use of a towel, foam cushion or something else to properly position the child restraint, make certain that the **PASSENGER AIR BAG OFF** light comes on and stays on whenever the child restraint is installed on the front passenger seat.
- If the **PASSENGER AIR BAG OFF** light does not come on and stay on, immediately install child restraint in a rear seating position and have the airbag system inspected by your authorized Audi dealer.

### How the Advanced Airbag System components work together

The front Advanced Airbag System and the side airbags supplement the protection offered by the front three-point safety belts and the adjustable head restraints to help reduce the risk of injury in a wide range of accident and crash situations. Be sure to read the important information about safety and heed the WARNINGS in this chapter.

Deployment of the Advanced Airbag System and the activation of the safety belt pretensioners depend on the deceleration measured by the crash sensors and registered by the electronic control unit. Crash severity depends on speed and decel-

eration as well as the mass and stiffness of the vehicle or object involved in the crash.

On the passenger side, regardless of safety belt use, the airbag will be turned off if the weight on the passenger seat is less than the amount programmed in the electronic control unit. The front airbag on the passenger side will also be turned off if one of the child safety seats that has been certified under Federal Motor Vehicle Safety Standard 208 has been recognized on the seat. The **PASSENGER AIR BAG OFF** light comes on and stays on to tell you when the front Advanced Airbag on the passenger side has been turned off ⇒ *page 115, Child restraints on the front seat – some important things to know.*

### WARNING

- To reduce the risk of injury when an airbag inflates, always wear safety belts properly.
- If you are unrestrained, leaning forward, sitting sideways or out of position in any way, your risk of injury is much higher.
  - You will also receive serious injuries and could even be killed if you are up against the airbag or too close to it when it inflates - even with an Advanced Airbag ⇒ *page 114.*

### More important things to know about front airbags



Fig. 114 Inflated front airbags

Safety belts are important to help keep front seat occupants in the proper seated position so that airbags can unfold properly and provide supplemental protection in a frontal collision. ►

The front airbags are designed to provide additional protection for the chest and face of the driver and the front seat passenger when:

- safety belts are worn properly,
- the seats have been positioned so that the occupant is properly seated as far as possible from the airbag,
- and the head restraints have been properly adjusted.

Because airbags inflate in the blink of an eye with great force, things you have on your lap or have placed on the seat could become dangerous projectiles, and be pushed into you if the airbag inflates.

When an airbag deploys, fine dust is released. This is normal and is not caused by a fire in the vehicle. This dust is made up mostly of a powder used to lubricate the airbags as they deploy. It could irritate skin.

It is important to remember that while the supplemental airbag system is designed to reduce the likelihood of serious injuries, other injuries, for example swelling, bruising and minor abrasions, can also happen when airbags inflate. Airbags do not protect the arms or the lower parts of the body. Front airbags only supplement the three point safety belts in some frontal collisions in which the vehicle deceleration is high enough to deploy the airbags.

#### Front airbags will not deploy:

- if the ignition is switched off when a crash occurs,
- in side collisions,
- in rear-end collisions,
- in rollovers,
- when the crash deceleration measured by the airbag system is less than the minimum threshold needed for airbag deployment as registered by the electronic control unit.

#### The front passenger airbag will also not deploy:

- when the front passenger seat is not occupied,
- when the weight on the front passenger seat as sensed by the Advanced Airbag System indi-

cates that the front airbag on the passenger side has to be turned off by the electronic control unit (the **PASSENGER AIR BAG OFF** light comes on and stays on).

#### WARNING

Sitting in the wrong position can increase the risk of serious injury in crashes.

- To reduce the risk of injury when the airbags inflate, the driver and passengers must always sit in an upright position, must not lean against or place any part of their body too close to the area where the airbags are located.
- Occupants who are unbelted, out of position or too close to the airbag can be seriously injured by an airbag as it unfolds with great force in the blink of an eye ⇒ *page 115*.

#### WARNING

A child in a rearward-facing child safety seat installed on the front passenger seat will be seriously injured and can be killed if the front airbag inflates - even with an Advanced Airbag System.

- The inflating airbag will hit the child safety seat or infant carrier with great force and will smash the child safety seat and child against the backrest, center armrest, door or roof.
- Always install rear-facing child safety seats on the rear seat.
- If you must install a rearward facing child safety seat on the front passenger seat because of exceptional circumstances and the **PASSENGER AIR BAG OFF** light does not come on and stay on, immediately install the rear-facing child safety seat in a rear seating position and have the airbag system inspected by your authorized Audi dealer.

#### WARNING

Objects between you and the airbag will increase the risk of injury in a crash by interfering with the way the airbag unfolds or by being pushed into you as the airbag inflates. ►

- Never hold things in your hands or on your lap when the vehicle is in use.
- Never transport items on or in the area of the front passenger seat. Objects could move into the area of the front airbags during braking or other sudden maneuver and become dangerous projectiles that can cause serious personal injury if the airbags inflate.
- Never place or attach accessories or other objects (such as cupholders, telephone brackets, large, heavy or bulky objects) on the doors, over or near the area marked “AIRBAG” on the steering wheel, instrument panel, seat backrests or between those areas and yourself. These objects could cause injury in a crash, especially when the airbags inflate.
- Never recline the front passenger's seat to transport objects. Items can also move into the area of the side airbag or the front airbag during braking or in a sudden maneuver. Objects near the airbags can become projectiles and cause injury, particularly when the seat is reclined.

### **WARNING**

The fine dust created when airbags deploy can cause breathing problems for people with a history of asthma or other breathing conditions.

- To reduce the risk of breathing problems, those with asthma or other respiratory conditions should get fresh air right away by getting out of the vehicle or opening windows or doors.
- If you are in a collision in which airbags deploy, wash your hands and face with mild soap and water before eating.
- Be careful not to get the dust into your eyes, or into any cuts or scratches.
- If the residue should get into your eyes, flush them with water.

## Monitoring the Advanced Airbag System

### **Airbag monitoring indicator light**

Two separate indicators monitor the function of the Advanced Airbag System: the airbag monitoring indicator light and the **PASSENGER AIR BAG OFF** light.

The Advanced Airbag System as well as the side airbags and side curtain airbags with ejection mitigation features (including the electronic control unit, sensors and system wiring) are all monitored continuously to make sure that they are functioning properly whenever the ignition is on. Each time you turn on the ignition, the airbag monitoring indicator light  will come on for a few seconds (self diagnostics).

### **The system must be inspected when the indicator light :**

- does not come on when the ignition is switched on,
- does not go out a few seconds after you have switched on the ignition, or
- comes on while driving.

If an airbag system malfunction is detected, the indicator light will come on to serve as a constant reminder to have the system inspected immediately.

If a malfunction occurs that turns the front airbag on the passenger side off, the **PASSENGER AIR BAG OFF** light will come on and stay on whenever the ignition is on.

### **WARNING**

An airbag system that is not functioning properly cannot provide supplemental protection in a frontal crash.

- If the airbag indicator light  *⇒ page 14* comes when the vehicle is being used, have the system inspected immediately by your authorized Audi dealer. It is possible that the airbag will inflate when it is not supposed to, or will not inflate when it should.

## PASSENGER AIR BAG OFF light



**Fig. 115** Section from the instrument panel: PASSENGER AIR BAG OFF light

The **PASSENGER AIR BAG OFF** light is located in the center of the instrument panel ⇒ *fig. 115*.

The **PASSENGER AIR BAG OFF** light will come on and stay on to tell you when the front Advanced Airbag on the passenger side has been turned off by the electronic control unit. Each time you turn on the ignition, the **PASSENGER AIR BAG OFF** light will flash for a few seconds and:

- will stay on if the front passenger seat is not occupied,
- will stay on if there is a small child or child restraint on the front passenger seat,
- will go out if the front passenger seat is occupied by an adult as registered by the weight-sensing mat.

The **PASSENGER AIR BAG OFF** light must come on and stay on if the ignition is on and

- a car bed has been installed on the front seat, or
- a rearward-facing child restraint has been installed on the front passenger seat, or
- a forward-facing child restraint has been installed on the front passenger seat, or
- the weight registered on the front passenger seat is equal to or less than the combined weight of a typical 1 year-old restrained in one of the rear-facing or forward-facing infant restraints listed in Federal Motor Vehicle Safety Standard 208 with which the Advanced Airbag System in your vehicle was certified.

If the front passenger seat is not occupied, the front airbag will not deploy, and the **PASSENGER**

**AIR BAG OFF** light will stay on. Never install a rearward-facing child restraint on the front passenger seat, the safest place for a child in any kind of child restraint is at one of the seating positions on the rear seat ⇒ *page 115, Child restraints on the front seat – some important things to know* and ⇒ *page 134, Child safety*.

**If the PASSENGER AIR BAG OFF light comes on** when one of the conditions listed above is met, be sure to check the light regularly to make certain that the **PASSENGER AIR BAG OFF** light stays on continuously whenever the ignition is on. If the **PASSENGER AIR BAG OFF** light does not appear and not stay on all the time, stop as soon as it is safe to do so and

- reactivate the system by turning the ignition off and then turning it on again;
- remove and reinstall the child restraint. Make sure that the child restraint is properly installed and that the safety belt for the front passenger seat has been correctly routed around the child restraint as described in the child restraint manufacturer's instructions;
- make sure that the convertible locking retractor on the safety belt for the front passenger seat has been activated and that the safety belt has been pulled tight. The belt must not be loose or have loops of slack so that the sensor below the safety belt latch on the seat can do its job ⇒ *page 144*.
- make sure that things that may increase the weight of the child and child safety seat are not being transported on the front passenger seat;
- make sure that the safety belt tension sensor is not blocked. Shake the safety belt latch on the front passenger seatback and forth;
- If a strap or tether is being used to tie the child safety seat to the front passenger seat, make sure that it is not so tight that it causes the weight-sensing mat to measure more weight than is actually on the seat.

**If the PASSENGER AIR BAG OFF light still does not come on** and does not stay on continuously (when the ignition is switched on),

- take the child restraint off the front passenger seat and install it properly at one of the rear

- seat positions. Have the airbag system inspected by your authorized Audi dealer immediately.
- move the child to a rear seat position and make sure that the child is properly restrained in a child restraint that is appropriate for its size and age.

The **PASSENGER AIR BAG OFF** light should NOT come on when the ignition is on and an adult is sitting in a proper seating position on the front passenger seat. If the **PASSENGER AIR BAG OFF** light comes on and stays on or flashes for about 5 seconds while driving, under these circumstances, make sure that:

- the adult on the front passenger seat is properly seated on the center of the seat cushion with his or her back up against the backrest and the backrest is not reclined ⇒ *page 98, Correct passenger seating positions*,
- the adult is not taking weight off the seat by holding on to the passenger assist handle above the front passenger door or supporting their weight on the armrest,
- the safety belt is being properly worn and that there is not a lot of slack in the safety belt webbing,
- accessory seat covers or cushions or other things that may cause an incorrect reading or impression on the weight-sensing mat under the upholstery of the seat have been removed from the front passenger seat,
- a safety belt extender has not been left in the safety belt latch for the front passenger seat.

In addition to the **PASSENGER AIR BAG OFF** light in the center of the instrument panel, the message **PASSENGER AIR BAG OFF** or **PASSENGER AIR BAG ON** will briefly appear in the instrument cluster display. This is to inform the driver of the current front passenger airbag status.

### Important safety instructions on monitoring the Advanced Airbag System

#### WARNING

An airbag system that is not functioning properly cannot provide supplemental protection in a frontal crash.

- If the airbag indicator light ⇒ *page 14* comes when the vehicle is being used, have the system inspected immediately by your authorized Audi dealer. It is possible that the airbag will inflate when it is not supposed to, or will not inflate when it should.

#### WARNING

If the front airbag inflates, a child without a child restraint, in a rearward-facing child safety seat or in a forward-facing child restraint that has not been properly installed will be seriously injured and can be killed.

- Even though your vehicle is equipped with an Advanced Airbag System, make certain that all children, especially 12 years and younger, always ride on the back seat properly restrained for their age and size.
- Always install forward or rear-facing child safety seats on the rear seat – even with an Advanced Airbag System.
- If you must install a rearward-facing child safety seat on the front passenger seat because of exceptional circumstances and the **PASSENGER AIR BAG OFF** light does not appear and stay on, immediately install the rear-facing child safety seat in a rear seating position and have the airbag system inspected by your authorized Audi dealer.
- A tight tether or other strap on a rearward-facing child restraint attached to the front passenger seat can put too much pressure on the weight-sensing mat in the seat and register more weight than is actually on the seat. The heavier weight registered can make the system work as though an adult were on the seat and deploy the Advanced Airbag when it must be suppressed causing serious or even fatal injury to the child.
- If, in exceptional circumstances, you must install a forward-facing child restraint on the front passenger seat, always move the seat into its rearmost position in the seat's fore and aft adjustment range, as far away from the airbag as possible. The backrest must be adjusted to an upright position. Make sure that the **PASSENGER AIR BAG**



**OFF** light comes on and stays on all the time whenever the ignition is switched on.

### **WARNING**

- If the **PASSENGER AIR BAG OFF** light does not go out when an adult is sitting on the front passenger seat after taking the steps described above, make sure the adult is properly seated and restrained at one of the rear seating positions.
- Have the airbag system inspected by your authorized Audi dealer before transporting anyone on the front passenger seat.

### **Tips**

If the weight-sensing mat in the front passenger seat detects an empty seat, the front airbag on the passenger side will be turned off, and **PASSENGER AIR BAG OFF** will stay on.

## Repair, care and disposal of the airbags

Parts of the airbag system are installed at many different places on your Audi. Installing, removing, servicing or repairing a part in an area of the vehicle can damage a part of an airbag system and prevent that system from working properly in a collision.

There are some important things you have to know to make sure that the effectiveness of the system will not be impaired and that discarded components do not cause injury or pollute the environment.

### **WARNING**

Improper care, servicing and repair procedures can increase the risk of personal injury and death by preventing an airbag from deploying when needed or deploying an airbag unexpectedly:

- Never cover, obstruct, or change the steering wheel horn pad or airbag cover or the instrument panel or modify them in any way.
- Never attach any objects such as cupholders or telephone mountings to the surfaces covering the airbag units.

- For cleaning the horn pad or instrument panel, use only a soft, dry cloth or one moistened with plain water. Solvents or cleaners could damage the airbag cover or change the stiffness or strength of the material so that the airbag cannot deploy and protect properly.
- Never repair, adjust, or change any parts of the airbag system.
- All work on the steering wheel, instrument panel, front seats or electrical system (including the installation of audio equipment, cellular telephones and CB radios, etc.) must be performed by a qualified technician who has the training and special equipment necessary.
- For any work on the airbag system, we strongly recommend that you see your authorized Audi dealer or qualified workshop.
- Never modify the front bumper or parts of the vehicle body.
- Always make sure that the side airbag can inflate without interference:
  - Never install seat covers or replacement upholstery over the front seatbacks that have not been specifically approved by Audi.
  - Never use additional seat cushions that cover the areas where the side airbags inflate.
  - Damage to the original seat covers or to the seam in the area of the side airbag module must always be repaired immediately by an authorized Audi dealer.
- The airbag system can be activated only once. After an airbag has inflated, it must be replaced by an authorized Audi dealer or qualified technician who has the technical information, training and special equipment necessary.
- The airbag system can be deployed only once. After an airbag has been deployed, it must be replaced with new replacement parts designed and approved especially for your Audi model version. Replacement of complete airbag systems or airbag components must be performed by qualified workshops only. Make sure that any airbag

service action is entered in your Audi Warranty & Maintenance booklet under *AIRBAG REPLACEMENT RECORD*.

### For the sake of the environment

Undeployed airbag modules and pretensioners might be classified as Perchlorate Material -special handling may apply, see [www.dtsc.ca.gov/hazardouswaste/perchlorate](http://www.dtsc.ca.gov/hazardouswaste/perchlorate). When the vehicle or parts of the restraint system including airbag modules safety belts with pretensioners are scrapped, all applicable laws and regulations must be observed. Your authorized Audi dealer is familiar with these requirements and we recommend that you have your dealer perform this service for you.

### Other things that can affect Advanced Airbag performance

Changing the vehicle's suspension system can change the way that the Advanced Airbag System performs in a crash. For example, using tire-rim combinations not approved by Audi, lowering the vehicle, changing the stiffness of the suspension, including the springs, suspension struts, shock absorbers etc. can change the forces that are measured by the airbag sensors and sent to the electronic control unit. Some suspension changes can, for example, increase the force levels measured by the sensors and make the airbag system deploy in crashes in which it would not deploy if the changes had not been made. Other kinds of changes may reduce the force levels measured by the sensors and prevent the airbag from deploying when it should.

### WARNING

Changing the vehicle's suspension including use of unapproved tire-rim combinations can change Advanced Airbag performance and increase the risk of serious personal injury in a crash.

- Never install suspension components that do not have the same performance characteristics as the components originally installed on your vehicle.

- Never use tire-rim combinations that have not been approved by Audi.

### WARNING

Items stored between the safety belt buckle and the center console can cause the sensors in the buckle to send the wrong information to the electronic control module and prevent the Advanced Airbag System from working properly.

- Always make sure that nothing can interfere with the safety belt buckles and that they are not obstructed.

## Side airbags

### Description of side airbags

*The airbag system can provide supplemental protection to properly restrained occupants.*



Fig. 116 Side airbag location in the driver's seat

The side airbags are located in the sides of the front seat backrests ⇒ *fig. 116* facing the doors. They are identified by the word "AIRBAG".

### The side airbag system basically consists of:

- the electronic control module and external side impact sensors
- the two airbags located in the sides of the front backrests
- the airbag warning light in the instrument cluster.

The airbag system is monitored electronically to make certain that it is functioning properly at all times. Each time you turn on the ignition, the airbag system indicator light will come on for a few seconds (self diagnostics).

The side airbag system supplements the safety belts and can help to reduce the risk of injury to the driver's and front passenger's upper torso on the side of the vehicle that is struck in a side collision. The airbag deploys only in side impacts and only when the vehicle acceleration registered by the control unit is high enough. If this rate is below the reference value programmed into the control unit, the side airbags will not be triggered, even though the car may be badly damaged as a result of the collision. It is not possible to define an airbag triggering range that will cover every possible angle of impact, since the circumstances will vary considerably between one collision and another. Important factors include, for example, the nature (hard or soft) of the impacting object, the angle of impact, vehicle speed, etc. ⇒ *page 130, Important safety instructions on the side airbag system.*

Aside from their normal safety function, safety belts work to help keep the driver or front passenger in position in the event of a side collision so that the side airbags can provide protection.

The airbag system is *not* a substitute for your safety belt. Rather, it is part of the overall occupant restraint system in your vehicle. Always remember that the side airbag system can only help to protect you if you are wearing your safety belt and wearing it properly. This is another reason why you should always wear your safety belts, not just because the law requires you to do so ⇒ *page 106, General information.*

It is important to remember that while the supplemental side airbag system is designed to reduce the likelihood of serious injuries, other injuries, for example, swelling, bruising, and minor abrasions can also be associated with deployed side airbags. Remember too, side airbags will deploy only once and only in certain kinds of accidents - your safety belts are always there to offer protection.

Vehicle damage, repair costs or even the lack of vehicle damage are not necessarily an indication of over-sensitive or failed airbag activation. In some collisions, both front and side airbags may inflate. Remember too, that airbags will deploy only once and only in certain kinds of collisions –

your safety belts are always there to offer protection in those accidents in which airbags are not supposed to deploy or when they have already deployed.

#### The side airbag system will not deploy:

- when the ignition is turned off
- in side collisions when the acceleration measured by the sensor is too low
- in front-end collisions
- in rear-end collisions
- in rollovers.

In some types of accidents the front airbags, side curtain airbags and side airbags may be triggered together.

#### WARNING

- Safety belts and the airbag system will only provide protection when occupants are in the proper seating position ⇒ *page 130.*
- If the airbag indicator light ⇒ *page 14* comes when the vehicle is being used, have the system inspected immediately by your authorized Audi dealer. It is possible that the airbag will inflate when it is not supposed to, or will not inflate when it should.

#### How supplemental side airbags work

*Side airbags deploy instantly and can help reduce the risk of upper torso injuries for occupants who are properly restrained.*



**Fig. 117** Inflated side airbags on left side of vehicle

When the system is triggered, the airbag is filled with propellant gas and breaks through a seam in the seat surface area marked "AIRBAG". It expands between the side trim panel and the

passenger. In order to help provide this additional protection, the side airbag must inflate within a fraction of a second at very high speed and with great force. The supplemental side airbag could injure you if your seating position is not proper or upright or if items are located in the area where the supplemental side airbag expands. This applies especially to children ⇒ *page 134, Child safety*. Supplemental side airbags inflate between the occupant and the door panel on the side of the vehicle that is struck in certain side collision ⇒ *fig. 117*.

Although they are not a soft pillow, they can “cushion” the impact and in this way they can help to reduce the risk of injury to the upper part of the body.

A fine dust may develop when the airbag deploys. This is normal and does not mean there is a fire in the vehicle.

### Important safety instructions on the side airbag system

*Airbags are only supplemental restraints. Always properly wear safety belts and ride in a proper seating position.*

There is a lot that you and your passengers must know and act accordingly to help the safety belts and airbags do their job to provide supplemental protection.

#### WARNING

An inflating side airbag can cause serious or fatal injury. Improperly wearing safety belts and improper seating positions increase the risk of serious personal injury and death whenever a vehicle is being used.

- In order to reduce the risk of injury when the supplemental side airbag inflates:
  - Always sit in an upright position and never lean against the area where the supplemental side airbag is located.
  - Never let a child or anyone else rest their head against the side trim panel in the area where the supplemental side airbag inflates.

- Always make sure that safety belts are worn correctly,
- Do not let anyone sitting in the front seat put their hand or any other parts of their body out of the window.
- Always make sure that the side airbag can inflate without interference.
- Never install seat covers or replacement upholstery over the front seatbacks that have not been specifically approved by Audi.
- Never use additional seat cushions that cover the areas where the side airbags deploy.
- Damage to the original seat covers or to the seam in the area of the side airbag module must always be repaired immediately by an authorized Audi dealer.
- Objects between you and the airbag can increase the risk of injury in an accident by interfering with the way the airbag unfolds or by being pushed into you as the airbag inflates.
- Never place or attach accessories or other objects (such as cupholders, telephone brackets, or even large, bulky objects) on the doors, over or near the area marked “AIRBAG” on the seat backrests.
- Such objects and accessories can become dangerous projectiles and cause injury when the supplemental side airbag deploys.
- Never carry any objects or pets in the deployment space between them and the airbags or allow children or other passengers to travel in this position.
- Always use the built-in coat hooks only for lightweight clothing. Never leave any heavy or sharp-edged objects in the pockets that may interfere with side airbag deployment and can cause personal injury in an accident.
- Always prevent the side airbags from being damaged by heavy objects knocking against or hitting the sides of the seatbacks.
- The airbag system can only be triggered once. If the airbag has been triggered, the system must be replaced by an authorized Audi dealership.

- Damage (cracks, deep scratches etc.) to the original seat covers or to the seam in the area of the side airbag module must always be repaired immediately by an authorized Audi dealer.
- If children are seated improperly, their risk of injury increases in the case of an accident ⇒ page 134, *Child safety*.
- Never attempt to modify any components of the airbag system in any way.
- In a side collision, side airbags will not function properly if sensors cannot correctly measure increasing air pressure inside the doors when air escapes through larger, unclosed openings in the door panel.
  - Never drive with interior door trim panels removed.
  - Never drive when parts have been removed from the inside door panel and the openings they leave have not been properly closed.
  - Never drive when loudspeakers in the doors have been removed unless the speaker holes have been properly closed.
- Always make certain that openings are covered or filled if additional speakers or other equipment is installed in the inside door panels.
- Always have work on the doors done by an authorized Audi dealer or qualified workshop.

## Side curtain airbags

### Description of side curtain airbags

The side curtain airbag system can provide supplemental protection to properly restrained occupants.



**Fig. 118** Side curtain system, driver's side: side curtain airbag location

The side curtain airbags are located on both sides of the interior above the front and rear side windows ⇒ *fig. 118*. They are identified by the word "AIRBAG" on the windshield frame and the center roof pillar.

The side curtain airbags contain features that provide ejection mitigation to help prevent vehicle occupants or parts of their bodies from being completely or partially ejected from the vehicle interior in certain side impacts and vehicle roll-overs.

The side curtain airbag system supplements the safety belts and can help to reduce the risk of injury for occupants' heads and upper torso on the side of the vehicle that is struck in a side collision. The side curtain airbag inflates in side impacts and only when the vehicle acceleration registered by the control unit is high enough. If this rate is below the reference value programmed into the control unit, the side curtain airbag will not be triggered, even though the car may be badly damaged as a result of the collision. It is not possible to define an airbag triggering range that will cover every possible angle of impact, since the circumstances will vary considerably between one collision and another. Important factors include, for example, the nature (hard or

soft) of the impacting object, the angle of impact, vehicle speed, etc. ⇒ *page 132, How side curtain airbags work.*

Aside from their normal safety function, safety belts work to help keep the driver or front passenger in position in the event of a collision so that the side curtain airbags can provide protection.

The airbag system is not a substitute for your safety belt. Rather, it is part of the overall occupant restraint system in your vehicle. Always remember that the airbag system can only help to protect you if you are wearing your safety belt and wearing it properly. This is another reason why you should always wear your safety belts, not just because the law requires you to do so ⇒ *page 106, General information.*

It is important to remember that while the side curtain airbag system is designed to help reduce the likelihood of serious injuries, other injuries, for example, swelling, bruising, and minor abrasions can also be associated with these airbags. Remember too, these airbags will deploy only once and only in certain kinds of accidents - your safety belts are always there to offer protection.

### The side curtain airbag system basically consists of:

- The electronic control module and external side impact sensors
- The side curtain airbags above the front and rear side windows with ejection mitigation features
- The airbag indicator light in the instrument panel

The airbag system is monitored electronically to make certain it is functioning properly at all times. Each time you turn on the ignition, the airbag system indicator light will come on for a few seconds (self diagnostics).

### The side curtain airbag is not activated:

- if the ignition is turned off,
- in side collisions when the acceleration measured by the sensor is too low,
- in rear-end collisions.

### WARNING

- Safety belts and the airbag system will only provide protection when occupants are in the proper seating position ⇒ *page 42, Front seats.*
- If the airbag indicator light ⇒ *page 14* comes when the vehicle is being used, have the system inspected immediately by your authorized Audi dealer. It is possible that the airbag will inflate when it is not supposed to, or will not inflate when it should.

### How side curtain airbags work

*Side curtain airbags can work together with side airbags to help reduce the risk of head and upper torso injuries for occupants who are properly restrained.*



**Fig. 119** Illustration of principle: Inflated side curtain airbags on the left side

The side curtain airbags inflate between the occupant and the windows on the side of the vehicle that is struck in a side collision ⇒ *fig. 119.*

When the system is triggered, the side curtain airbag is filled with propellant gas and breaks through a seam above the front and rear side windows identified by the AIRBAG label. In order to help provide this additional protection, the side curtain airbag must inflate within the blink of an eye at very high speed and with great force. The side curtain airbag could injure you if your seating position is not proper or upright or if items are located in the area where the supplemental side curtain airbag inflates. This applies especially to children ⇒ *page 134.*

Although they are not a soft pillow, side curtain airbags can “cushion” the impact and in this way ►

they can help to reduce the risk of injury to the head and the upper part of the body.

A fine dust may develop when the airbag deploys. This is quite normal and does not mean there is a fire in the vehicle.

### Important safety instructions on the side curtain airbag system

*Airbags are only supplemental restraints. Always properly wear safety belts and ride in a proper seating position.*

There is a lot that you and your passengers must know and do to help the safety belts and airbags do their job to provide supplemental protection.

#### WARNING

Improperly wearing safety belts and improper seating positions increase the risk of serious personal injury and death whenever a vehicle is being used.

- Never let occupants place any parts of their bodies in the area from which the side curtain airbags inflate.
- Always make sure that the side curtain airbags can inflate without interference. Unsuitable accessories fitted inside the expansion range of a head airbag can dangerously interfere with its function. A deploying head airbag develops enough force to catapult any piece of add-on component out of its path of inflation and into the passenger compartment. An occupant hit by such a projectile can suffer serious injury or death ⇒ *page 215, Technical Modifications.*
- Do not swivel the sun visors to the side if you have any objects clipped onto them (for example pens). If the airbag should deploy, you could be injured by these objects.
- Use the built-in coat hooks only for lightweight clothing. Never leave any heavy or sharp-edged objects in the pockets that may interfere with airbag deployment and can cause personal injury in an accident.
- Never use hangers to hang clothing from the hooks.

- Only use factory-installed sun shades or, in the case of shades installed after the vehicle leaves the factory, only Audi roll-up sunscreens may be used ⇒ *page 214, Additional accessories and parts replacement.*
- Always sit in proper seating position and wear safety belts while traveling so that the side curtain airbags can help provide protection.
- The airbag system can only be triggered once. If the airbag has been triggered, the system must be replaced by an authorized Audi dealer or qualified workshop.
- Always have work involving the side curtain airbag system, removal and installation of the airbag components, or other repairs performed by an authorized Audi dealer or qualified workshop. Otherwise the airbag system may not work correctly.
- Never attempt to modify any components of the airbag system in any way.

## Child safety

### Important information

#### Introduction

*The rear seat is generally the safest place in a collision.*

The physical principles of what happens when your vehicle is in a crash apply also to children ⇒ *page 107, What happens to occupants not wearing safety belts?*. But unlike adults and teenagers, their muscles and bones are not fully developed. In many respects children are at greater risk of serious injury in crashes than adults.

Because children's bodies are not fully developed, they require restraint systems especially designed for their size, weight, and body structure. Many countries and all states of the United States and provinces of Canada have laws requiring the use of approved child restraint systems for infants and small children.

In a frontal crash at a speed of 20-35 mph (30-56 km/h) the forces acting on a 13-pound (6 kg) infant will be more than 20 times the weight of the child. This means the weight of the child would suddenly be more than 260 pounds (120 kg). Under these conditions, only an appropriate child restraint properly used can reduce the risk of serious injury. Child restraints, like adult safety belts, must be used properly to be effective. Used improperly, they can increase the risk of serious injury in an accident.

All children, especially those 12 years and younger must always ride in the back seat properly restrained for their age and size. If you must install a child restraint on the front passenger seat in exceptional circumstances, be sure to read and heed the important information and warnings ⇒ *page 115*. Infants and other children who are properly restrained in an appropriate child restraint that is for their size and age can benefit from the protection that supplemental side airbags provide in some kinds of crashes.

For more information please see information provided by the:

- National Highway Traffic Safety Administration (NHTSA), currently at : <http://www.safercar.gov> (for the USA)
- Transport Canada Information Centre, currently at: <http://www.tc.gc.ca> (for Canada)

Consult the child safety seat manufacturer's instructions in order to be sure the seat is right for your child's size ⇒ *page 137, Important safety instructions for using child safety seats*. Please be sure to read and heed all of the important information and WARNINGS about child safety, Advanced Airbags, and the installation of child restraints in this chapter.

There is a lot you need to know about the Advanced Airbags in your vehicle and how they work when infants and children in child restraints are on the front passenger seat. Because of the large amount of important information, we cannot repeat it all here. We urge you to read the detailed information in this owner's manual about airbags and the Advanced Airbag System in your vehicle and the very important information about transporting children on the front passenger seat. Please be sure to heed the WARNINGS - they are extremely important for your safety and the safety of your passengers, especially infants and small children.

#### **WARNING**

- Accident statistics have shown that children are generally safer in the rear seat area than in the front seating position. Always restrain any child age 12 and under in the rear.
- All vehicle occupants and especially children must be restrained properly whenever riding in a vehicle. An unrestrained or improperly restrained child could be injured by striking the interior or by being ejected from the vehicle during a sudden maneuver or impact. An unrestrained or improperly restrained child is also at greater risk of injury or death through contact with an inflating airbag.
- A suitable child restraint properly installed and used at one of the rear seating positions provides the highest degree of protection for infants and small children in most accident situations.



**! WARNING**

Children on the front seat of any car even with Advanced Airbags can be seriously injured or even killed when an airbag inflates. A child in a rearward-facing child safety seat installed on the front passenger seat will be seriously injured and can be killed if the front airbag inflates.

- The inflating airbag will hit the child safety seat or infant carrier with great force and will smash the child safety seat and child against the backrest, center armrest, or door.
- Always install rear-facing child safety seats on the rear seat.
- If you must install a rearward facing child safety seat on the front passenger seat in exceptional circumstances and the **PASSENGER AIR BAG OFF** light does not come on and stay on, immediately install the rear-facing child safety seat in a rear seating position and have the airbag system inspected immediately by your Audi dealer.

**! WARNING**

If, in exceptional circumstances, you must install a forward-facing child restraint on the front passenger's seat:

- Always make sure the forward-facing seat has been designed and certified by its manufacturer for use on a front seat with a passenger front and side airbag.
- Always follow the manufacturer's instructions provided with the child safety seat or carrier.
- Always move the front passenger seat to the highest position in the up and down adjustment range and move it back to the rearmost position in the seat's fore and aft adjustment range, as far away from the airbag as possible, before installing the forward-facing child restraint.
- Always make sure that the safety belt upper anchorage is behind the child restraint and not next to or in front of the child restraint so that the safety belt will be properly positioned.

- Always make sure that the **PASSENGER AIR BAG OFF** light comes on and stays on all the time whenever the ignition is switched on.

**i Tips**

Always replace child restraints that were installed in a vehicle during a crash. Damage to a child restraint that is not visible could cause it to fail in another collision situation.

**Advanced front airbag system and children**

Your vehicle is equipped with a front “Advanced Airbag System” in compliance with United States Federal Motor Vehicle Safety Standard (FMVSS) 208, as well as Canada Motor Vehicle Safety Standard (CMVSS) 208 as applicable at the time your vehicle was manufactured.

The Advanced Airbag system in your vehicle has been certified to meet the “low-risk” requirements for 3- and 6-year old children on the passenger side and small adults on the driver side. The low risk deployment criteria are intended to reduce the risk of injury through interaction with the airbag that can occur, for example, by being too close to the steering wheel and instrument panel when the airbag inflates. In addition, the system has been certified to comply with the “suppression” requirements of the Safety Standard, to turn off the front airbag for infants up to 12 months who are restrained on the front passenger seat in child restraints that are listed in the Standard.

Even though your vehicle is equipped with an Advanced Airbag system, all children, especially those 12 years and younger, should always ride in the back seat properly restrained for their age and size. The airbag on the passenger side makes the front seat a potentially dangerous place for a child to ride. The front seat is not the safest place for a child in a forward-facing child safety seat. It can be a very dangerous place for an infant or a larger child in a rearward-facing seat.

**Advanced Airbags and the weight-sensing mat in the front seat**

The Advanced Airbag System in your vehicle detects the presence of an infant or child in a child restraint on the front passenger seat using the weight-sensing mat in the seat cushion and the sensor below the safety belt latch on the front passenger seat that measures the tension on the safety belt.

The weight-sensing mat measures total weight of the child and the child safety seat and a child blanket on the front passenger seat. The weight on the front passenger seat is related to the design of the child restraint and its “footprint”, the size and shape of the bottom of the child restraint as it sits on the seat. The weight of a child restraint and its “footprint” vary for different kinds of child restraints and for the different models of the same kind of child restraint offered by child restraint manufacturers.

The weight ranges for the individual types, makes and models of child restraints that the NHTSA has specified in the Safety Standard together with the weight ranges of typical infants and typical 1 year-old child have been stored in the control unit of the Advanced Airbag System. When a child restraint is being used on the front passenger seat with a typical 1 year-old child, the Advanced Airbag System compares the weight measured by the weight sensing mat with the information stored in the electronic control unit.

The electronic control unit also registers the tension on the front passenger safety belt. The tension on the safety belt for the front passenger seat will be different for an adult who is properly using the safety belt as compared to the tension on the belt when it is used to attach a child restraint to the seat. The sensor below the latch for the safety belt for the front seat passenger measures the tension on the belt. The input from this sensor is then used with the weight to “decide”, whether there is a child restraint with a typical 1 year-old child on the front passenger seat and whether or not the airbag must be turned off.

**Child restraints and Advanced Airbags**

Regardless of the child restraint that you use, make sure that it has been certified to meet Safety Standards and has been certified by its manufacturer for use with an airbag. Always be sure that the child restraint is properly installed at one of the rear seating positions. If in exceptional circumstances you must use it on the front passenger seat, carefully read all of the information on child safety and Advanced Airbags and heed all of the applicable WARNINGS. Make certain that the child restraint is correctly recognized by the weight-sensing mat inside the front passenger seat, that the front passenger airbag is turned off and that the airbag status is always correctly signaled by the **PASSENGER AIR BAG OFF** light.

Many types and models of child restraints have been available over the years, new models are introduced regularly incorporating new and improved designs and older models are taken out of production. Child restraints are not standardized. Child restraints of the same type typically have different weights and sizes and different ‘footprints,’ the size and shape of the bottom of the child restraint that sits on the seat, when they are installed on a vehicle seat. These differences make it virtually impossible to certify compliance with the requirements for advanced airbags with each and every child restraint that has ever been sold in the past or will be sold over the course of the useful life of your vehicle.

For this reason, the United States National Highway Traffic Safety Administration has published a list of specific type, makes and models of child restraints that must be used to certify compliance of the Advanced Airbag System in your vehicle with the suppression requirements of Federal Motor Vehicle Safety Standard 208. These child restraints are:

**Subpart A – Car bed child restraints**

Model	Manufactured on or after
Angel Guard Angel Ride AA2403FOF	September 25, 2007

**Subpart B – Rear-facing child restraints**

Model	Manufactured on or after
Century SmartFit 4543	December 1, 1999
Cosco Arriva 22-013PAW and base 22-999WHO	September 25, 2007
Evenflo Discovery Adjust Right 212	December 1, 1999
Evenflo First Choice 204	December 1, 1999
Graco Infant 8457	December 1, 1999
Graco Snugride	September 25, 2007
Peg Perego Primo Viaggio SIP IMUN00US	September 25, 2007

**Subpart C – Forward-facing and convertible child restraints**

Model	Manufactured on or after
Britax Roundabout E9L02xx	September 25, 2007
Cosco Touriva 02519	December 1, 1999
Cosco Summit Deluxe High Back Booster 22-262	September 25, 2007
Cosco High Back Booster 22-209	September 25, 2007
Evenflo Tribute V 379xxxx	September 25, 2007
Evenflo Medallion 254	December 1, 1999
Evenflo Generations 352xxxx	September 25, 2007
Graco ComfortSport	September 25, 2007
Graco Toddler Safety Seat Step 2	September 25, 2007
Graco Platinum Cargo	September 25, 2007

**⚠ WARNING**

To reduce the risk of serious injury, make sure that the **PASSENGER AIR BAG OFF** light comes on and stays on whenever a child restraint is installed on the front passenger seat and the ignition is switched on.

- Take the child restraint off the front passenger seat and install it properly at one of the rear seat positions if the **PASSENGER AIR BAG OFF** light does not stay on.
- Have the airbag system inspected by your authorized Audi dealer immediately.

**i Tips**

The child seats listed in categories A to C have been statically tested by Audi only for the Advanced Airbag function.

**Important safety instructions for using child safety seats**

*Correct use of child safety seats substantially reduces the risk of injury in an accident!*

As the driver, you are responsible for the safety of everybody in the vehicle, especially children:

- ▶ Always use the right child safety seat for each child and always use it properly ⇒ *page 140*.
- ▶ Always carefully follow the child safety seat manufacturer's instructions on how to route the safety belt properly through the child safety seat.
- ▶ When using the vehicle safety belt to install a child safety seat, you must first activate the convertible locking retractor on the safety belt to prevent the child safety seat from moving ⇒ *page 144*.
- ▶ Push the child safety seat down with your full weight to get the safety belt really tight so that the seat cannot move forward or sideways more than one inch (2.5 cm).
- ▶ If a strap or tether is being used to tie the child safety seat to the front passenger seat, make sure that it is not so tight that it causes the weight-sensing mat to measure more weight than is actually on the seat.
- ▶ Secure unused safety belts on the rear seat ⇒ *page 139*.

Always remember: Even though your vehicle is equipped with an Advanced Airbag system, all children, especially those 12 years and younger, should always ride in the back seat properly restrained for their age and size.

### **WARNING**

Not using a child safety seat, using the wrong child safety seat or improperly installing a child restraint increases the risk of serious personal injury and death.

- All vehicle occupants and especially children must be restrained properly whenever riding in a vehicle. An unrestrained or improperly restrained child could be injured by striking the interior or by being ejected from the vehicle during a sudden maneuver or impact. An unrestrained or improperly restrained child is also at greater risk of injury or death through contact with an inflating airbag.
- Commercially available child safety seats are required to comply with U.S. Federal Motor Vehicle Safety Standard (FMVSS) 213 (in Canada CMVSS 213).
  - When buying a child restraint, select one that fits your child and the vehicle.
  - Only use child restraint systems that fully contact the flat portion of the seat cushion. The child restraint must not tip or lean to either side. Audi does not recommend using child safety seats that rest on legs or tube-like frames. They do not provide adequate contact with the seat.
  - Always heed all legal requirements pertaining to the installation and use of child safety seats and carefully follow the instructions provided by the manufacturer of the seat you are using.
- Never allow children under 57 inches (1.45 meters) to wear a normal safety belt. They must always be restrained by a proper child restraint system. Otherwise, they could sustain injuries to the abdomen and neck areas during sudden braking maneuvers or accidents.
- Never let more than one child occupy a child safety seat.
- Never let babies or older children ride in a vehicle while sitting on the lap of another passenger.
  - Holding a child in your arms is never a substitute for a child restraint system.

- The strongest person could not hold the child with the forces that exist in an accident. The child will strike the interior of the vehicle and can also be struck by the passenger.
- The child and the passenger can also injure each other in an accident.
- Never install rear-facing child safety seats or infant carriers on the front passenger seat. A child will be seriously injured and can be killed when the passenger airbag inflates – even with an Advanced Airbag System.
- Make sure there is enough space in front of the child in the child seat. If necessary, adjust the angle and position of the seat in front of the child seat.
- The inflating airbag will hit the child safety seat or infant carrier with great force and will smash the child safety seat and child against the backrest, center armrest, door or roof.
- Always install rear-facing child safety seats or infant carriers on the rear seat.
- Forward-facing child safety seats installed on the front passenger's seat can interfere with the airbag when it inflates and cause serious injury to the child. Always install forward-facing child safety seats on the rear seat.
- If exceptional circumstances require the use of a forward-facing child restraint on the front passenger's seat, the child's safety and well-being require that the following special precautions be taken:
  - Make sure the forward-facing seat has been designed and certified by its manufacturer for use on a front seat with a passenger front and side airbag.
  - Always carefully follow the manufacturer's instructions provided with the child safety seat or carrier.
  - Always move the front passenger seat to the highest position in the up and down adjustment range and move it back to the rearmost position in the seat's fore and aft adjustment range, as far away from

the airbag as possible, before installing the forward-facing child restraint.

- Always make sure that the safety belt upper anchorage is behind the child restraint and not next to or in front of the child restraint so that the safety belt will be properly positioned.
- Always make sure that nothing prevents the front passenger's seat from being moved to the rearmost position in its fore and aft adjustment range.
- Always make sure that the backrest is in the upright position.
- Always buckle the child safety seat firmly in place even if a child is not sitting in it. A loose child safety seat can fly around during a sudden stop or in a collision.
- Always read and heed all WARNINGS whenever using a child restrained in a vehicle is being used ⇒ *page 106, Safety belts*, ⇒ *page 114, Airbag system* and ⇒ *page 134, Child safety*.

### WARNING

To reduce the risk of serious injury, make sure that the **PASSENGER AIR BAG OFF** light comes on and stays on whenever a child restraint is installed on the front passenger seat and the ignition is switched on.

- Take the child restraint off the front passenger seat and install it properly at one of the rear seat positions if the **PASSENGER AIR BAG OFF** light does not stay on.
- Have the airbag system inspected by your authorized Audi dealer immediately.

### Secure unused safety belts on the rear seat



**Fig. 120** Schematic overview: keep unused safety belts away from children in child safety seats. **A** - outer rear safety belt, **B** - center rear safety belt

If a child safety seat is used on the rear bench, especially with LATCH universal lower anchorages, the unused safety belts **must** be secured so that the child in the child restraint cannot reach them ⇒ .

- Guide the safety belt webbings **A** and **B** behind the head restraint of the seat where the child restraint is installed ⇒ *fig. 120*. When doing so, do not engage the convertible locking retractor! You should not hear a “clicking” sound when winding up the safety belt.
- Let the belt retractor wind up the safety belt webbing.

### WARNING

A child in a child safety seat installed with the LATCH lower anchorages or with the standard safety belt or a child in a booster seat on the rear seat could play with unused rear seat safety belts and become entangled. This could cause the child serious personal injury and even death.

- Always secure unused rear seat safety belts out of reach of children in child seats such as by properly routing them around the head restraint of the seat where the child restraint is installed.
- Never activate the convertible locking retractor when routing the safety belts around the head restraints.
- Never let anyone sit at the center rear seating position if the center rear safety belt has been routed around a rear head restraint.

## Child safety seats

### Infant seats

Babies and infants up to about one year old and 20 lbs. or 9 kg need special rearward-facing child restraints that support the back, neck and head in a crash.



Fig. 121 Schematic overview: rearward-facing infant seat, properly installed on the rear seat

- ▶ When using the vehicle safety belt to install a child safety seat, you must first activate the convertible locking retractor on the safety belt to prevent the child safety seat from moving ⇒ *page 144* or install the seat using the LATCH attachments.
- ▶ Push the child safety seat down with your full weight to get the safety belt really tight so that the seat cannot move forward or sideways more than one inch (2.5 cm).
- ▶ Secure unused safety belts on the rear seat ⇒ *page 139*.

Infants up to about one year (20 lbs. or 9 kg) are best protected in special infant carriers and child safety seats designed for their age group. Many experts believe that infants and small children should ride only in special restraints in which the child faces the back of the vehicle. These infant seats support the baby's back, neck and head in a crash ⇒ *fig. 121*.

The airbag on the passenger side makes the front seat a potentially dangerous place for a child to ride. The front seat is not the safest place for a child in a forward-facing child seat. It is a very dangerous place for an infant or a larger child in a rearward-facing seat.

### WARNING

Not using a child safety seat, using the wrong child safety seat or improperly installing a child restraint increases the risk of serious personal injury and death in a crash.

- Never install rear-facing child safety seats or infant carriers on the front passenger seat - even with an Advanced Airbag System. A child will be seriously injured and can be killed when the inflating airbag hits the child safety seat or infant carrier with great force and smashes the child safety seat and child against the backrest, center armrest, door or roof ⇒ *page 115, Child restraints on the front seat - some important things to know*.
- Always install rear-facing child safety seats or infant carriers on the rear seat.
- Never install a rear-facing child restraint in the forward-facing direction. Such restraints are designed for the special needs of infants and very small children and cannot protect them properly if the seat is forward-facing.
- If you must install a rearward facing child safety seat on the front passenger seat because of exceptional circumstances and the **PASSENGER AIR BAG OFF** light does not come on and stay on, immediately install the rear-facing child safety seat in a rear seating position and have the airbag system inspected by your Audi dealer.
- Always read and heed all WARNINGS whenever using a child restrained in a vehicle is being used ⇒ *page 106, Safety belts*, ⇒ *page 114, Airbag system* and ⇒ *page 134, Important information*.

## Convertible child safety seats

Properly used convertible child safety seats can help protect toddlers and children over age one who weigh between 20 and 40 lbs. (9 and 18 kg) in a crash.

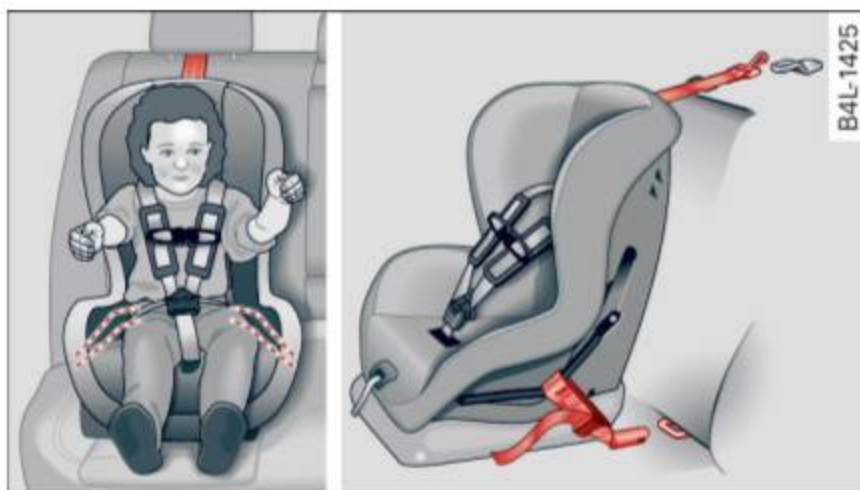

**Fig. 122** Schematic overview: installation of the attachments applicable to a LATCH seat

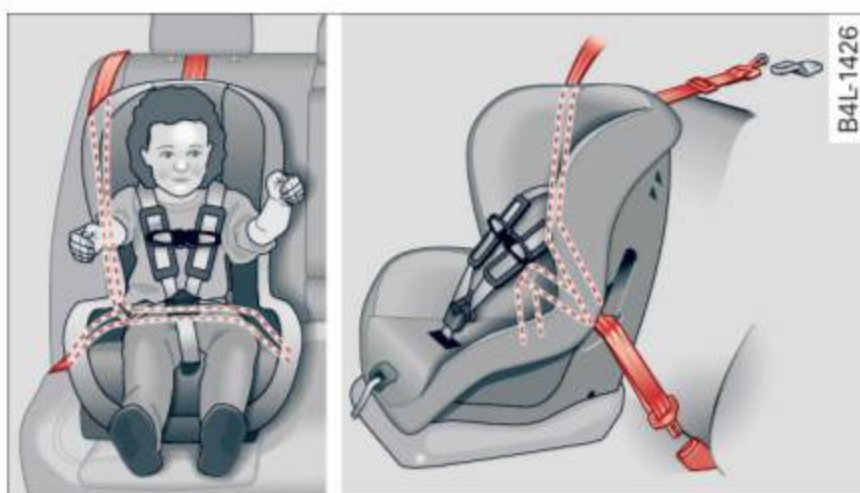

**Fig. 123** Schematic overview: installation of the seat using the vehicle's safety belt system

- ▶ When using the vehicle safety belt to install a child safety seat, you must first activate the convertible locking retractor on the safety belt to prevent the child safety seat from moving ⇒ *page 144* or install the seat using the LATCH attachments.
- ▶ Push the child safety seat down with your full weight to get the safety belt really tight so that the seat cannot move forward or sideways more than one inch (2.5 cm) ⇒ *page 144*.
- ▶ If the child safety seat is equipped with a tether strap, attach it to the tether anchors ⇒ *page 149*.
- ▶ Secure unused safety belts on the rear seat ⇒ *page 139*.

A toddler or child is usually too large for an infant restraint if it is more than one year old and weighs more than 20 lbs. (9 kg).

Toddlers and children who are older than one year up to about 4 years old and weigh more than 20 lbs. (9 kg) up to 40 lbs. (18 kg) must always be properly restrained in a child safety seat certified for their size and weight ⇒ *fig. 122* and ⇒ *fig. 123*.

The airbag on the passenger side makes the front seat a potentially dangerous place for a child to ride. The front seat is not the safest place for a child in a forward-facing child safety seat. It is a very dangerous place for an infant or a larger child in a rearward-facing seat.

### WARNING

Not using a child safety seat, using the wrong child safety seat or improperly installing a child restraint increases the risk of serious personal injury and death in a collision or other emergency situation.

- Children on the front seat of any car, even with Advanced Airbags, can be seriously injured or even killed when an airbag inflates. A child in a rearward-facing child safety seat installed on the front passenger seat will be seriously injured and can be killed if the front airbag inflates – even with an Advanced Airbag System.
- The inflating airbag will hit the child safety seat or infant carrier with great force and will smash the child safety seat and child against the backrest, center armrest, door or roof.
- Always install rear-facing child safety seats on the rear seat.
- If you must install a rearward facing child safety seat on the front passenger seat because of exceptional circumstances and the **PASSENGER AIR BAG OFF** light does not come on and stay on, immediately install the rear-facing child safety seat in a rear seating position and have the airbag system inspected by your Audi dealer.
- The rear side of the child safety seat should be positioned as close as possible to the backrest on the vehicle seat. Adjust or remove the rear seat head restraint if it is difficult to install the child seat with the head

restraint in place ⇒ *page 44*. Install the head restraint again immediately once the child seat is removed. Driving without head restraints or with head restraints that are not properly adjusted increases the risk of serious or fatal neck injury dramatically.

- Always read and heed all WARNINGS whenever using a child restrained in a vehicle is being used ⇒ *page 106, Safety belts*, ⇒ *page 114, Airbag system* and ⇒ *page 134, Important information*.

### WARNING

If exceptional circumstances require the use of a forward-facing child restraint on the front passenger's seat, the child's safety and well-being require that the following special precautions be taken:

- Make sure the forward-facing seat has been designed and certified by its manufacturer for use on a front seat with a passenger front and side airbag.
- Always follow the manufacturer's instructions provided with the child safety seat or infant carrier.
- Always move the front passenger seat to the highest position in the up and down adjustment range and move it back to the rearmost position in the seat's fore and aft adjustment range, as far away from the airbag as possible, before installing the forward-facing child restraint.
- Always make sure that the safety belt upper anchorage is behind the child restraint and not next to or in front of the child restraint so that the safety belt will be properly positioned.
- Always make sure that nothing prevents the front passenger's seat from being moved to the rearmost position in its fore and aft adjustment range.
- Always make sure the backrest is in an upright position.
- Make sure that the **PASSENGER AIR BAG OFF** light comes on and stays on all the time whenever the ignition is switched on.

- If the light does not stay on, perform the checks ⇒ *page 124, Monitoring the Advanced Airbag System*.
- Take the child restraint off the front passenger seat and install it properly at one of the rear seat positions if the **PASSENGER AIR BAG OFF** light does not stay on whenever the ignition is switched on.

### Booster seats and safety belts

Properly used booster seats can help protect children weighing between about 40 lbs. and 80 lbs. (18 kg and 36 kg) who are less than 4 ft. 9 in. (57 inches/1.45 meters) tall.



**Fig. 124** Rear seat: child properly restrained in a booster seat

The vehicle's safety belts alone will not fit most children until they are at least 4 ft. 9 in. (57 inches/1.45 meters) tall and weigh about 80 lbs. (36 kg). Booster seats raise these children up so that the safety belt will pass properly over the stronger parts of their bodies and the safety belt can help protect them in a crash.

- ▶ Do not use the convertible locking retractor when using the vehicle's safety belt to restrain a child on a booster seat.
- ▶ The shoulder belt must lie as close to the center of the child's collar bone as possible and must lie flat and snug on the upper body. It must never lie across the throat or neck. The lap belt must lie across the pelvis and never across the stomach or abdomen. Make sure the belt lies flat and snug. Pull on the belt to tighten if necessary.
- ▶ If you must transport an older child in a booster seat on the front passenger seat, you can ▶



use the safety belt height adjustment to help adjust the shoulder portion properly.

- ▶ Secure unused safety belts on the rear seat  
⇒ *page 139*.

Children up to at least 8 years old (over 40 lbs. or 18 kg) are best protected in child safety seats designed for their age and weight. Experts say that the skeletal structure, particularly the pelvis, of these children is not fully developed, and they must not use the vehicle safety belts without a suitable child restraint.

It is usually best to put these children in appropriate booster seats. Be sure the booster seat meets all applicable safety standards.

Booster seats raise the seating position of the child and reposition both the lap and shoulder parts of the safety belt so that they pass across the child's body in the right places. The routing of the belt over the child's body is very important for the child's protection, whether or not a booster seat is used. Children age 12 and under must always ride in the rear seat.

Children who are at least 4 ft. 9 in. (57 inches/ 1.45 meters) tall can generally use the vehicle's three point lap and shoulder belts. Never use the lap belt portion of the vehicle's safety belt alone to restrain any child, regardless of how big the child is. Always remember that children do not have the pronounced pelvic structure required for the proper function of lap belt portion of the vehicle's three point lap and shoulder belts. The child's safety absolutely requires that a lap belt portion of the safety belt be fastened snugly and as low as possible around the pelvis. Never let the lap belt portion of the safety belt pass over the child's stomach or abdomen.

In a crash, airbags must inflate within a blink of an eye and with considerable force. In order to do its job, the airbag needs room to inflate so that it will be there to protect the occupant as the occupant moves forward into the airbag.

A vehicle occupant who is out of position and too close to the airbag gets in the way of an inflating airbag. When an occupant is too close, he or she will be struck violently and will receive serious or possibly even fatal injury.

In order for the airbag to offer protection, it is important that all vehicle occupants, especially any children, who must be in the front seat because of exceptional circumstances, be properly restrained and as far away from the airbag as possible. By keeping room between the child's body and the front of the passenger compartment, the airbag can inflate completely and provide supplemental protection in certain frontal collisions.

### **WARNING**

Not using a booster seat, using the booster seat improperly, incorrectly installing a booster seat or using the vehicle safety belt improperly increases the risk of serious personal injury and death in a collision or other emergency situation. To help reduce the risk of serious personal injury and/or death:

- The shoulder belt must lie as close to the center of the child's collar bone as possible and must lie flat and snug on the upper body. It must never lie across the throat or neck. The lap belt must lie across the pelvis and never across the stomach or abdomen. Make sure the belt lies flat and snug. Pull on the belt to tighten if necessary.
- Failure to properly route safety belts over a child's body will cause severe injuries in an accident or other emergency situation  
⇒ *page 106*.
- The rear side of the child safety seat should be positioned as close as possible to the backrest on the vehicle seat. Adjust or remove the rear seat head restraint if it is difficult to install the child seat with the head restraint in place ⇒ *page 44*. Install the head restraint again immediately once the child seat is removed. Driving without head restraints or with head restraints that are not properly adjusted increases the risk of serious or fatal neck injury dramatically.
- Never let a child put the shoulder belt under the arm or behind the back, because it could cause severe injuries in a crash.
- Children on the front seat of any car, even with Advanced Airbags, can be seriously injured or even killed when an airbag inflates.

- Never let a child stand or kneel on any seat, for example the front seat.
- Never let a child ride in the cargo area of your vehicle.
- Always remember that a child leaning forward, sitting sideways or out of position in any way during an accident can be struck by a deploying airbag. This will result in serious personal injury or death.
- If you must install a booster seat on the front passenger seat because of exceptional circumstances the **PASSENGER AIR BAG OFF** light must come on and stay on, whenever the ignition is switched on.
- If the **PASSENGER AIR BAG OFF** light does not come on and stay on, perform the checks described ⇒ *page 124, Monitoring the Advanced Airbag System*.
- Take the child restraint off the front passenger seat and install it properly at one of the rear seat positions if the **PASSENGER AIR BAG OFF** light does not stay on whenever the ignition is switched on.
- Always read and heed all WARNINGS whenever using a child restrained in a vehicle is being used ⇒ *page 106, Safety belts*, ⇒ *page 114, Airbag system* and ⇒ *page 134, Important information*.

## Securing child safety seats

### Securing a child safety seat using a safety belt

*Safety belts for the rear seats and the front passenger can be locked with the convertible locking retractor to properly secure child safety seats.*

The safety belts emergency locking retractors for the rear seats safety belts and for the front passenger's seat safety belt have a convertible locking retractor for child restraints. The safety belt must be locked so that belt webbing cannot unreel. The retractor can be activated to lock the safety belt and prevent the safety belt webbing from loosening up during normal driving. A child safety seat can only be properly installed when

the safety belt is locked so that the child and child safety seat will stay in place.

Always remember: Even though your vehicle is equipped with an Advanced Airbag system, all children, especially those 12 years and younger, should always ride in the back seat properly restrained for their age and size.

### **WARNING**

Improperly installed child safety seats increase the risk of serious personal injury and death in a collision.

- Always make sure that the safety belt retractor is locked when installing a child safety seat. An unlocked safety belt retractor cannot hold the child safety seat in place during normal driving or in a crash.
- Always buckle the child safety seat firmly in place even if a child is not sitting in it. A loose child safety seat can fly around during a sudden stop or in a collision.
- Always make sure that the rear seat backrest to which the center rear safety belt is attached is securely latched whenever the rear center safety belt is being used to secure a child restraint.
- If the backrest is not securely latched, the child and the child restraint will be thrown forward together with the backrest and will strike parts of the vehicle interior. The child can be seriously injured or killed.
- Never install rear-facing child safety seats or infant carriers on the front passenger seat. A child will be seriously injured and can be killed when the passenger airbag inflates.
- The inflating airbag will hit the child safety seat or infant carrier with great force and will smash the child safety seat and child against the backrest, center armrest, door or roof.
- Always install rear-facing child safety seats or infant carriers on the rear seat.
- Forward-facing child safety seats or infant carriers installed on the front passenger's seat may interfere with the deployment of

the airbag and cause serious injury to the child.

- It is safer to install a forward-facing child safety seat on the rear seat.
- Always read and heed all WARNINGS whenever using a child restrained in a vehicle is being used ⇒ *page 134*. Special precautions apply when installing a child safety seat on the front passenger seat ⇒ *page 115, Child restraints on the front seat – some important things to know*.

### WARNING

Always take special precautions if you must install a forward or rearward-facing child restraint on the front passenger's seat in exceptional situations:

- Whenever a forward or rearward-facing child restraint is installed on the front passenger seat, the **PASSENGER AIR BAG OFF** light must come on and stay on whenever the ignition is switched on.
- If the **PASSENGER AIR BAG OFF** light does not come on and stay on, perform the checks described ⇒ *page 124, Monitoring the Advanced Airbag System*.
- Take the child restraint off the front passenger seat and install it properly at one of the rear seat positions if the **PASSENGER AIR BAG OFF** light does not stay on whenever the ignition is switched on.
- Improper installation of child restraints can reduce their effectiveness or even prevent them from providing any protection.
- An improperly installed child restraint can interfere with the airbag as it deploys and seriously injure or even kill the child.
- Always carefully follow the manufacturer's instructions provided with the child safety seat or carrier.
- Never place additional items on the seat that can increase the total weight registered by the weight-sensing mat and can cause injury in a crash.

### WARNING

Forward-facing child restraints:

- Always make sure the forward-facing seat has been designed and certified by its manufacturer for use on a front seat with a passenger front and side airbag.
- Never put the forward-facing child restraint up, against or very near the instrument panel.
- Always move the front passenger seat to the highest position in the up and down adjustment range and move it back to the rearmost position in the seat's fore and aft adjustment range, as far away from the airbag as possible, before installing the forward-facing child restraint.
- Always make sure that the safety belt upper anchorage is behind the child restraint and not next to or in front of the child restraint so that the safety belt will be properly positioned.
- Make sure that the **PASSENGER AIR BAG OFF** light comes on and stays on all the time whenever the ignition is switched on.

### WARNING

Rearward-facing child restraints:

- A child in a rearward-facing child safety seat installed on the front passenger seat will be seriously injured and can be killed if the front airbag inflates - even with an Advanced Airbag System.
- The inflating airbag will hit the child safety seat or infant carrier with great force and will smash the child safety seat and child against the backrest, center armrest, door or roof.
- Always be especially careful if you must install a rearward facing child safety seat on the front passenger seat in exceptional circumstances.
- A tight tether strap on a rearward-facing child restraint attached to the front passenger seat can put too much pressure on the weight-mat in the seat and register a heavier weight in the Advanced Airbag System. The heavier weight registered can make the system work as though an adult were on the seat and deploy the Advanced Airbag when

it must be suppressed causing serious or even fatal injury to the child.

- Make sure that the **PASSENGER AIR BAG OFF** light comes on and stays on all the time whenever the ignition is switched on.
- If the **PASSENGER AIR BAG OFF** light does not come on and stay on, immediately install the rear-facing child safety seat in a rear seating position and have the airbag system inspected by your Audi dealer.

### Activating the convertible locking retractor

*Use the convertible locking retractor to secure a child restraint.*

Always heed the child safety seat manufacturer's instructions when installing a child restraint in your vehicle. To activate the convertible locking retractor:

- ▶ Place the child restraint on a seat, preferably on the rear seat.
- ▶ Slowly pull the belt **all the way out**.
- ▶ Route it around or through the child restraint belt path ⇒ .
- ▶ Push the child safety seat down with your full weight to get the safety belt really tight.
- ▶ Insert the belt tongue into the buckle for that seating position.
- ▶ Guide the safety belt back into the retractor until the belt lies flat and snug on the child safety seat.
- ▶ You should hear a "clicking" noise as the belt winds back into the inertia reel. Test the convertible locking retractor by pulling on the belt. You should no longer be able to pull the belt out of the retractor. The convertible locking retractor is now activated.
- ▶ Make sure that the red release button is facing away from the child restraint so that it can be unbuckled quickly.
- ▶ Pull on the belt to make sure the safety belt is properly tight and fastened so that the seat cannot move forward or sideways more than one inch (2.5 cm).

### WARNING

Using the wrong child restraint or an improperly installed child restraint can cause serious personal injury or death in a crash.

- Always make sure that the safety belt retractor is locked when installing a child safety seat. An unlocked safety belt retractor cannot hold the child safety seat in place during normal driving or in a crash.
- Always buckle the child safety seat firmly in place even if a child is not sitting in it. A loose child safety seat can fly around during a sudden stop or in a crash.
- Always make sure the seat backrest to which the child restraint is installed is in an upright position and securely latched into place and cannot fold forward. Otherwise, the seatback with the child safety seat attached to it could fly forward in the event of an accident or other emergency situation.
- Always read and heed all WARNINGS whenever using a child restrained in a vehicle is being used ⇒ *page 134*. Special precautions apply when installing a child safety seat on the front passenger seat ⇒ *page 115, Child restraints on the front seat – some important things to know*.

### Deactivating the convertible locking retractor

*The convertible locking retractor for child restraints will be deactivated automatically when the belt is wound all the way back into the retractor.*

- ▶ Press the red button on the safety belt buckle. The belt tongue will pop out of the buckle.
- ▶ Guide the safety belt all the way back into its stowed position.

Always let the safety belt retract completely into its stowed position. The safety belt can now be used as an ordinary safety belt without the convertible locking retractor for child restraints.

If the convertible locking retractor should be activated inadvertently, the safety belt must be unfastened and guided completely back into its

stowed position to deactivate this feature. If the convertible locking retractor is not deactivated, the safety belt will gradually become tighter and uncomfortable to wear.

### **WARNING**

Improperly installed child safety seats increase the risk of serious personal injury and death in a collision.

- Never unfasten the safety belt to deactivate the convertible locking retractor for child restraints while the vehicle is moving. You would not be restrained and could be seriously injured in an accident.
- Always read and heed all WARNINGS whenever using a child restrained in a vehicle is being used ⇒ *page 134*. Special precautions apply when installing a child safety seat on the front passenger seat ⇒ *page 115, Child restraints on the front seat – some important things to know*.

## LATCH system (lower anchorages and tethers for children)

### Child Restraint System anchors and how are they related to child safety

To provide a simpler and more practicable way to attach the child restraint on the vehicle seat, Federal regulations require special lower anchorages in vehicles and devices on new child restraints to attach to the vehicle anchorages.

In the United States, the combination of the tether anchorages and the lower anchorages is now generally called the LATCH system for “**L**ower **A**nchorages and **T**ethers for **C**hildren”. In Canada, the terms “top tether” with “lower universal anchorages” (or “lower universal anchorage bars”) are used to describe the system.

In other countries the term “ISOFIX” is used to describe the lower anchorages.

Forward-facing child restraints manufactured after September 1, 1999, are required by U.S. federal regulations to comply with new child head movement performance requirements. These

new performance requirements make a tether necessary on most new child seats.

Installing a child restraint that requires a top tether without one can seriously impair the performance of the child restraint and its ability to protect the child in a collision. Installing a child restraint that requires a top tether without the top tether may be a violation of state law.

Child restraint manufacturers offer LATCH lower anchorages on their child seats with hook-on or push-on connectors attached to adjustable straps.

In addition to the LATCH lower anchorages, these child restraint systems usually require the use of tether straps to help keep the child restraint firmly in place.

### **WARNING**

Improper installation of child restraints will increase the risk of injury and death in a crash.

- Always follow the instructions provided by the manufacturer of the child restraint you intend to install in your vehicle.
- Never install a child restraint without a properly attached top tether strap if the child restraint manufacturer's instructions require the top tether strap to be used.
- Improper use of child restraint LATCH lower anchorage points can lead to injury in a collision. The LATCH lower anchorage points are designed to withstand only those loads imposed by correctly fitted child restraints.
- Never mount two child restraint systems on one LATCH lower anchorage point.
- Never secure or attach any luggage or other item to the LATCH lower anchorages.

### Location

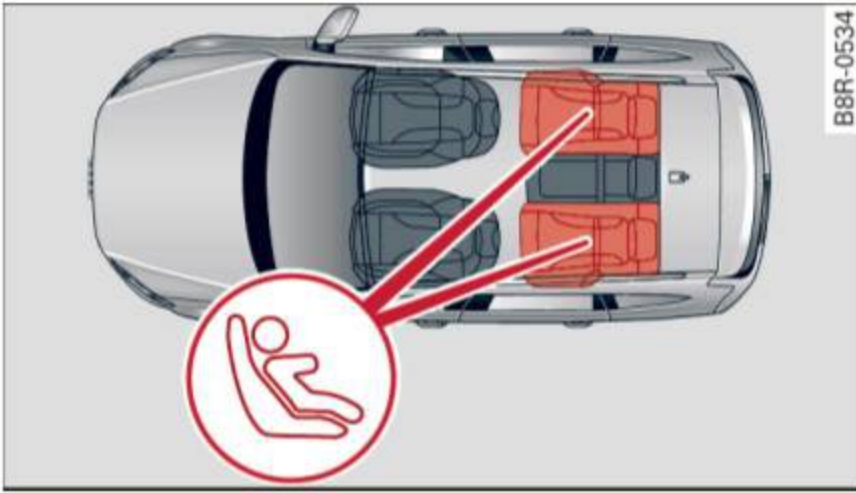

**Fig. 125** Schematic overview: LATCH anchorage point locations

The illustration shows the seating locations in your vehicle which are equipped with the lower anchorages system.

### Description

The lower anchorage positions are marked for quick locating.



**Fig. 126** Rear seats: lower anchorages, covers marked



**Fig. 127** Rear seats: lower anchorage bracket locations

### Lower anchorages

The lower anchorage attachment points are located between the rear seatback and rear seat cushion.

Remove the covers ⇒ *fig. 126* to access the lower anchorage attachment points.

The lower anchorage attachment points are visible ⇒ *fig. 127*.

Lower anchorages secure the child restraint in the seat without using the vehicle's safety belts. Anchorages provide a secure and easy-to-use attachment and minimize the possibility of improper child restraint installation.

All child restraints manufactured after September 1, 2002, must have lower anchorage attachments for the *LATCH* system.

Remember that the lower anchorage points are only intended for installation and attachment of child restraints specifically certified for use with *LATCH* lower anchorages. Child restraints that are not equipped with the lower anchorage attachments can still be installed in compliance with the child restraint manufacturer's instructions on using vehicle safety belts.

### WARNING

Improper use of *LATCH* lower anchorages can cause serious personal injury in an accident.

- Always carefully follow the child restraints manufacturer's instructions for proper installation of the child restraint and proper use of the lower anchorages or safety belts in your vehicle.
- Never secure or attach any luggage or other items to the *LATCH* lower anchorages.
- Always read and heed the important information about child restraints in this chapter and WARNINGS ⇒ *page 134, Child safety*.

## Installing a child restraint with LATCH lower anchorages

Whenever you install a child restraint always follow the child restraint manufacturer's instructions.

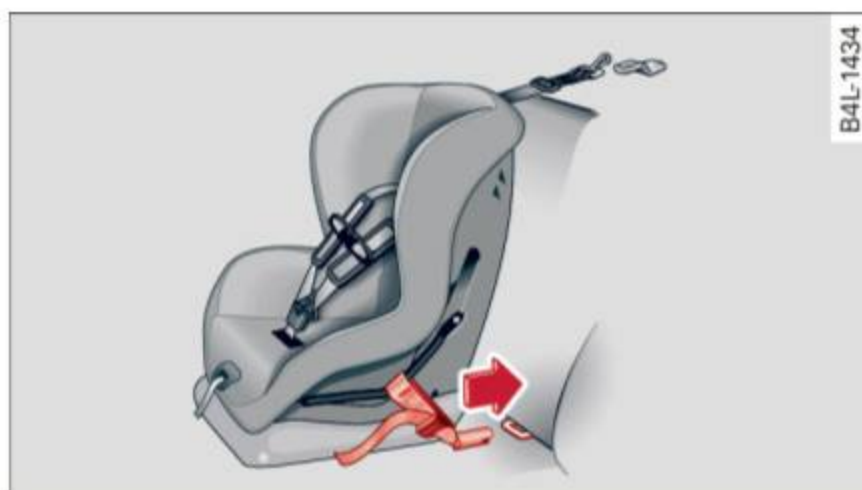

Fig. 128 Lower anchorages: proper mounting

### Mounting

- ▶ Make sure the seatback of the rear seat bench is in the upright position and securely latched in place.
- ▶ Attach both hook-on connectors with the spring catch release on the child safety seat onto the LATCH lower anchorage so that the connectors lock into place ⇒ *fig. 128*.
- ▶ Pull on the connector attachments to make sure they are properly attached to the LATCH lower anchorage.
- ▶ Pull straps tight following the child restraint manufacturer's instructions.

### Releasing

- ▶ Loosen the tension on the straps following the child restraint manufacturer's instructions.
- ▶ Depress the spring catches to release the anchorage hooks from the lower anchorages.

Remember: Use tether straps to help keep the child restraint firmly in place.

### WARNING

Improper use of the LATCH system can increase the risk of serious personal injury and death in an accident.

- These anchors were developed only for child safety seats using the “LATCH” system.
- Never attach other child safety seats, belts or other objects to these anchors.

- Always make sure that you hear a click when latching the seat in place. If you do not hear a click the seat is not secure and could fly forward and hit the interior of the vehicle, or be ejected from the vehicle.

### WARNING

Improper installation of child restraints will increase the risk of injury in an accident.

- Always follow the child restraint system manufacturer's instructions for proper installation of the child restraint system and proper use of tether straps as well as the lower anchorages or safety belts in your vehicle.
- Always read and heed the important information and WARNINGS about child safety and the installation of child restraint systems ⇒ *page 134, Child safety*.

## Tether anchors and tether straps

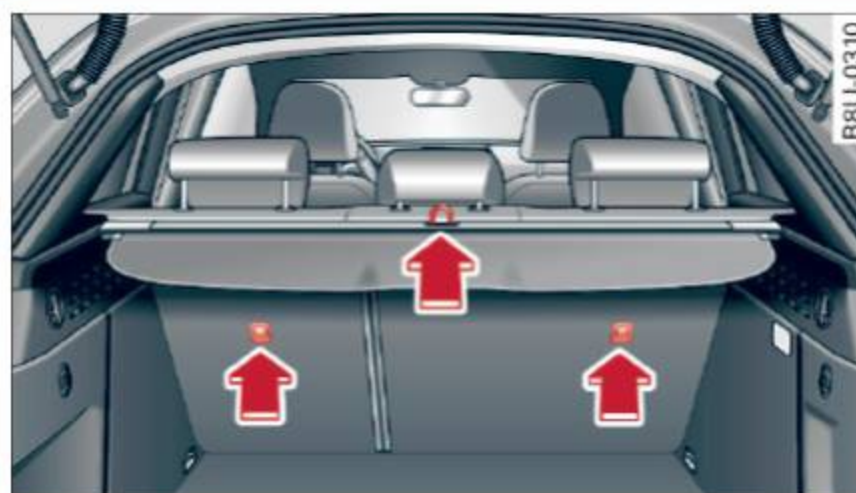

Fig. 129 Tether anchors: attachment hook locations behind the rear seatbacks

The tether anchors for the rear seating positions are located on the backside of the rear seatbacks ⇒ *fig. 129*.

A tether is a straight or V-shaped strap that attaches the top part of a child restraint to special anchorage points in the vehicle.

The purpose of the tether is to reduce the forward movement of the child restraint in a crash, in order to help reduce the risk of head injury that could be caused by striking the vehicle interior.

Forward facing child restraints manufactured after September 1, 1999, are required by U.S. federal regulations to comply with new child head movement performance requirements. These new performance requirements make a tether necessary on most new child safety seats.

### **WARNING**

Improper installation of child restraints will increase the risk of injury and death in a crash.

- Always follow the instructions provided by the manufacturer of the child restraint you intend to install in your Audi.
- Improper use of child restraint anchors (including tether anchors) can lead to injury in a collision. The anchors are designed to withstand only those loads imposed by correctly fitted child restraints.
- Never mount two child restraint systems on one LATCH lower anchor point.
- Never attach two child restraint systems to one tether strap or tether anchorage.
- Never attach a tether strap to a tie-down hook in the luggage compartment.
- Never use child restraint tether anchorages to secure safety belts or other kinds of occupant restraints.
- Never secure or attach any luggage or other items to the LATCH lower anchorages or to the tether anchors.
- If a tether or other strap is used to attach a child restraint to the front passenger seat, make sure that it is not so tight, that it causes the weight-sensing mat to measure more weight than is actually on the seat.
- The heavier weight registered can make the Advanced Airbag System work as though an adult were on the seat and deploy the Advanced Airbag when it must be suppressed causing serious or even fatal injury to the child.
- If you must install a rearward facing child safety seat on the front passenger seat because of exceptional circumstances and the **PASSENGER AIR BAG OFF** light does not come on and stay on, immediately install the rear-facing child safety seat in a rear

seating position and have the airbag system inspected by your Audi dealer.

### Installing the upper tether strap on the anchorage

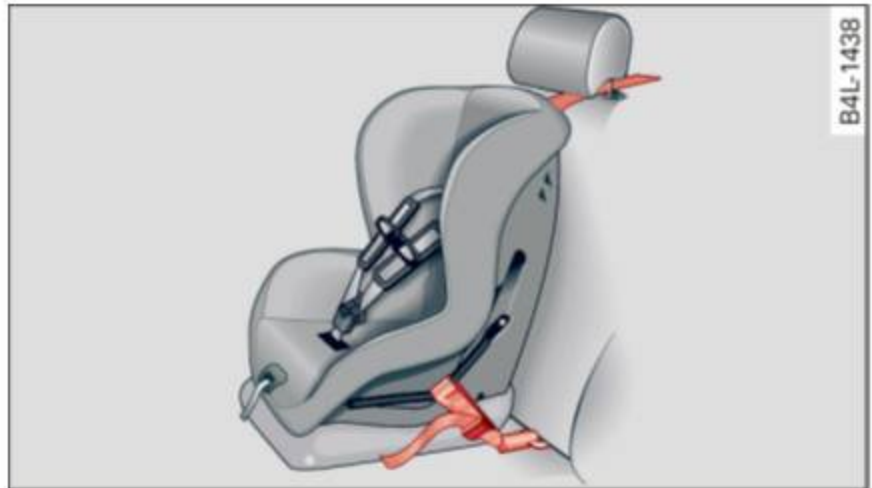

Fig. 130 Tether strap: proper routing and mounting



Fig. 131 Tether strap: proper routing and mounting

### Installing the tether strap

- ▶ Release or deploy the tether strap on the child restraint according to the child restraint manufacturer's instructions.
- ▶ Guide the upper tether strap **under** the rear head restraint and into the rear cargo area ⇒ *fig. 131* (raise the head restraint if necessary). For child restraints with V-tether straps, always make sure that the head restraint guide rods do not interfere with any part of the top tether strap.
- ▶ Slide the tether strap hook over the anchor bracket.
- ▶ Pull on the tether strap hook so that the spring catch of the hook engages.
- ▶ Tighten the tether strap firmly following the child restraint manufacturer's instructions.

### Releasing the tether strap

- ▶ Loosen the tension following the child restraint manufacturer's instructions. ▶



- ▶ Depress the spring catch on the hook and release it from the anchorage.

### Note

If you leave the child restraint with the tether strap firmly installed for several days, this could leave a mark on the upholstery on the seat cushion and backrest in the area where the tether strap was installed. The upholstery would also be permanently stretched around the tether strap. This applies especially to leather seats.

### Using tether straps on rearward-facing child restraints

Currently, few rear-facing child restraint systems come with a tether. Please read and heed the child restraint system manufacturer's instructions carefully to determine how to properly install the tether.

### WARNING

A child in a rearward-facing child safety seat installed on the front passenger seat will be seriously injured and can be killed if the front airbag inflates - even with an Advanced Airbag System.

- The inflating airbag will hit the child safety seat or infant carrier with great force and will smash the child safety seat and child against the backrest, center armrest, or door.
- A tight tether or other strap on a rearward-facing child restraint attached to the front passenger seat can put too much pressure on the weight-mat in the seat and register a heavier weight in the Advanced Airbag System. The heavier weight registered can make the system work as though an adult were on the seat and deploy the Advanced Airbag when it must be suppressed causing serious or even fatal injury to the child.
- If you must install a rearward facing child safety seat on the front passenger seat because of exceptional circumstances and the **PASSENGER AIR BAG OFF** light does not come on and stay on, immediately install

the rear-facing child safety seat in a rear seating position and have the airbag system inspected by your Audi dealer.

## Additional information

### Sources of information about child restraints and their use

There are a number of sources of additional information about child restraint selection, installation and use:

NHTSA advises that the best child safety seat is the one that fits your child and fits in your vehicle, and that you will use correctly and consistently.

Try before you buy!

#### U.S National Highway Traffic Safety Administration

Tel.: 1-888-327-4236 (TTY: 1-800-424-9153)

<http://www.nhtsa.gov>

<http://www.safercar.gov>

#### National SAFE KIDS Campaign

Tel.: (202) 662-0600

<http://www.safekids.org>

#### Safety BeltSafe U.S.A

Tel.: (800) 745-SAFE (English)

Tel.: (800) 747-SANO (Spanish)

<http://www.carseat.org>

#### Transport Canada Information Centre

Tel.: 1-800-333-0371 or call 1-613-998-8616 if you are in the Ottawa area

<http://www.tc.gc.ca/eng/roadsafety/menu.htm>

#### Audi Customer Relations

Tel.: (800) 822-2834

# Checking and Filling

## Fuel

### Gasoline grade

Applies to: vehicles with gasoline engines

*The correct gasoline grade is stated on the inside of the fuel filler door.*

The vehicle is equipped with a catalytic converter and must only be driven with **unleaded gasoline**.

Audi recommends using TOP TIER Detergent Gasoline. Additional information on TOP TIER Detergent Gasoline can be found on the official website ([www.toptiergas.com](http://www.toptiergas.com)).

The individual gasoline grades are differentiated by **octane ratings**. This value is given with (R+M)/2 equating to AKI or in RON.

The following headings match the corresponding sticker in the fuel filler door.

### **UNLEADED FUEL ONLY MIN. (R+M)/2 87 Regular / MIN. RON 91 Regular**

Use regular gasoline with minimum 87 AKI / 91 RON ⇔ ⚠.

The maximum engine power is only reached if premium gasoline 91 AKI / 95 RON is used.

### ⚠ Note

- Filling the tank just one time with leaded fuel or other metallic additives will cause permanent deterioration to the catalytic converter function.
- When gasoline with an octane rating that is too low is used, high speeds or heavy engine load can lead to engine damage.

### i Tips

The vehicle may be filled with fuel that has a higher octane rating than what is required by the engine.

### Blended gasoline

#### Use of gasoline containing alcohol or MTBE (methyl tertiary butyl ether)

You may use unleaded gasoline blended with alcohol or MTBE (commonly referred to as oxygenates) if the blended mixture meets the following criteria:

#### Blend of gasoline methanol (wood alcohol or methyl alcohol)

- Anti-knock index must be 87 AKI or higher.
- Blend must contain no more than 3% methanol.
- Blend must contain more than 2% co-solvents.

#### Blend of gasoline and ethanol (grain alcohol or ethyl alcohol)

- Anti-knock index must be 87 AKI or higher.
- Blend must not contain more than 15% ethanol.

#### Blend of gasoline and MTBE

- Anti-knock index must be 87 AKI or higher.
- Blend must contain not more than 15% MTBE.

#### Seasonally adjusted gasoline

Many gasoline grades are blended to perform especially well for winter or summer driving. During seasonal change-over, we suggest that you fill up at busy gas stations where the seasonal adjustment is more likely to be made in time.

### ⚠ Note

- Methanol fuels which do not meet these requirements may cause corrosion and damage to plastic and rubber components in the fuel system.
- Do not use fuels that fail to meet the specified criteria in this chapter.
- If you are unable to determine whether or not a particular fuel blend meets the specifications, ask your service station or its fuel supplier.
- Do not use fuel for which the contents cannot be identified.

- Fuel system damage and performance problems resulting from the use of fuels different from those specified are not the responsibility of Audi and are not covered under the New Vehicle or the Emission Control System Warranties.
- If you experience a loss of fuel economy or driveability and performance problems due to the use of one of these fuel blends, we recommend that you switch to unblended fuel.

### Gasoline additives

A major concern among many auto manufacturers is carbon deposit build-up caused by the type of gasoline you use.

Although gasoline grades differ from one manufacturer to another, they have certain things in common. All gasoline grades contain substances that can cause deposits to collect on vital engine parts, such as fuel injectors and intake valves. Although most gasoline brands include additives to keep engine and fuel systems clean, they are not equally effective.

Audi recommends using TOP TIER Detergent Gasoline. For more information on TOP TIER Detergent Gasoline, please go to the official website ([www.toptiergas.com](http://www.toptiergas.com)).

After an extended period of using inadequate fuels, built-up carbon deposits can rob your engine of peak performance.

#### Note

- Damage or malfunction due to poor fuel quality is not covered by the Audi New Vehicle Limited Warranty.

## Refueling

### Fueling procedure



Fig. 132 Right rear side of the vehicle: opening the fuel filler door



Fig. 133 Fuel filler door with attached fuel cap

The fuel filler door is unlocked or locked by the central locking system.

- ▶ Press on the left side of the fuel filler door to open ⇒ *fig. 132*.
- ▶ Unscrew the tank cap counterclockwise.
- ▶ Place the cap from above on the open fuel filler door ⇒ *fig. 133*.
- ▶ Insert the fuel pump nozzle all the way into the fuel filler neck.
- ▶ Start refueling. As soon as the fuel pump nozzle turns off the first time, the fuel tank is full. Do not continue fueling, or else the expansion space in the tank will be filled with fuel.
- ▶ Pull the pump nozzle out of the tank filler neck five seconds after it has switched off, so that the rest of the fuel can flow out of the pump nozzle into the filler neck.
- ▶ Turn the fuel cap clockwise until you hear it lock.
- ▶ Then press on the left side of the tank door until it latches.

The correct fuel type for your vehicle can be found on a label located on the inside of the fuel filler door. For additional information on fuel, see ⇒ *page 152*.

For the tank capacity in your vehicle, refer to the Technical Data ⇒ *page 210*.

To reduce the risk of fuel leaking out or vapors escaping, make sure that the fuel tank is closed correctly. Otherwise the <sup>1)</sup> indicator light may turn on.

If the central locking system malfunctions, the fuel filler door may emergency release ⇒ *page 155*.

### **WARNING**

An improper fueling procedure and improper handling of fuel can lead to explosions, fires, severe burns and other injuries.

- Do not smoke and keep away from open flames.
- The ignition must be switched off when refueling.
- Cell phones, radio devices and other radio equipment should always be switched off when refueling. Electromagnetic rays could cause sparks and start a fire.
- If you do not insert the fuel pump nozzle all the way into the filler tube, then fuel can leak out. Spilled fuel can ignite and start a fire.
- Never get into the vehicle when refueling. If there is an exceptional situation where the vehicle must be entered, close the door and touch a metal surface before touching the fuel pump nozzle again. This will reduce the risk of electrostatic discharge that can cause flying sparks. Sparks can start a fire when refueling.

### **WARNING**

We recommend that you do not transport any fuel containers in the vehicle. Fuel could leak out of the container and ignite, especially dur-

ing an accident. This can cause explosions, fires and injuries.

- If you must transport fuel in a fuel container, please note the following:
  - Always place a fuel container on the ground before filling. Never fill the fuel container with fuel while it is in or on the vehicle. Electrostatic charge can occur while refueling and the fuel vapors could ignite.
  - For fuel containers made of metal, the fuel pump nozzle must always maintain contact with the container to reduce the risk of static charge.
  - Insert the fuel pump nozzle as far as possible into the filler opening while refueling.
  - Follow legal requirements when using, storing and transporting fuel containers.
  - Make sure that the fuel container meets the industry standards, for example ANSI or ASTM F852-86.

### **Note**

- Remove fuel that has overflowed onto any vehicle components immediately to reduce the risk of damage to the vehicle.
- Never drive until the fuel tank is completely empty. The irregular supply of fuel that results from that can cause engine misfires. Uncombusted fuel will enter the exhaust system and increase the risk of damage to the catalytic converter.

### **For the sake of the environment**

Do not overfill the fuel tank, otherwise fuel can leak out when the vehicle is warming up.

### **Tips**

The fuel filler door on your vehicle does not lock if you lock the vehicle from the inside using the central locking switch.

<sup>1)</sup> Market-specific

### Fuel filler door emergency release

If the central locking system is faulty, the fuel filler door can be unlocked manually.



**Fig. 134** Right side trim panel in the luggage compartment: emergency release mechanism

The emergency opening mechanism is located behind the right side trim panel in the luggage compartment.

- ▶ Remove the cover in the side panel.
- ▶ Loosen the strap from its bracket -arrow- and pull on it carefully ⇒ *fig. 134* ⇒ ⚠. The filler door is released.
- ▶ Press on the left side of the fuel filler door to open it ⇒ *page 153, fig. 132*.

#### ⚠ Note

Only pull on the loop until you feel resistance. You will not hear it release. Otherwise you could damage the emergency release mechanism.

## Catalytic converter

The vehicle may only be driven with unleaded gasoline, otherwise the catalytic converter will be destroyed.

Never drive until the tank is completely empty. The irregular supply of fuel that results from that can cause engine misfires. Uncombusted fuel will enter the exhaust system, which can cause overheating and damage to the catalytic converter.

#### ⚠ WARNING

- The temperature in the exhaust system is high, both when driving and after stopping the engine.

- Never touch the exhaust tail pipes once they have become hot. This could result in burns.
- Do not park your vehicle over flammable materials such as grass or leaves because the high temperature of the emissions control system could start a fire.
- Do not apply underbody protectant in the exhaust system area, because this increases the risk of fire.

## Engine compartment

### Working in the engine compartment

*Special care is required if you are working in the engine compartment*

**For work in the engine compartment, such as checking and filling fluids, there is a risk of injury, scalding, accidents, and burns. For this reason, follow all the warnings and general safety precautions provided in the following information. The engine compartment is a dangerous area on the vehicle. ⇒ ⚠.**

#### ⚠ WARNING

- Turn the engine off.
- Switch the ignition off.
- Set the parking brake.
- Move the selector lever into the P position.
- Never open the hood when there is steam or coolant escaping from the engine compartment, because there is a risk that you could be burned. Wait until no steam or coolant is escaping.
- Let the engine cool down.
- Keep children away from the engine compartment.
- Never spill fluids on a hot engine. These fluids (such as the freeze protection contained in the coolant) can catch fire.
- Avoid short circuits in the electrical system.
- When working in the engine compartment, remember that the radiator fan can switch on even if the ignition is switched off, which increases the risk of personal injury.

- Never open the cap on the coolant expansion tank when the engine is warm. The cooling system is under pressure.
- To protect your face, hands, and arms from hot steam or coolant, cover the cap with a large cloth when opening.
- Do not remove the engine cover under any circumstances. This increases the risk of burns.
- If tests need to be performed with the engine running, there is additional danger due to moving components (such as the ribbed belt, alternator and radiator fan) and from the high-voltage ignition system.
- Do not under any circumstances give gas inadvertently (for example, by hand from the engine compartment) if the vehicle is stationary but the engine is running and a gear is engaged. Otherwise, the vehicle will start to move immediately and this could result in an accident.
- Pay attention to the following warnings listed when work on the fuel system or on the electrical equipment is required.
  - Do not smoke.
  - Never work near open flames.
  - Always have a working fire extinguisher nearby.
- All work on the battery or electrical system in your vehicle can result in injuries, chemical burns, accidents or burns. Because of this, all work must be performed **only** by an authorized Audi dealer or authorized Audi Service Facility.
- To reduce the risk of electric shock and injury, never touch the following components when the engine is running or is being started:
  - Ignition cable
  - Other components in the electronic high-voltage ignition system
- If you must check or perform work on the engine while it is running:
  - Set the parking brake and place the selector lever in the P (park) position first.
  - Always proceed with extreme caution so that clothing, jewelry or long hair do not

- become caught in the radiator fan, fan belt or other moving components or do not come into contact with hot components. Tie back long hair before beginning work and do not wear clothing that can hang down into the engine.
- Limit your exposure to exhaust and chemicals to as short a time as possible ⇒ ⚠.

### **WARNING**

California Proposition 65 Warning:

- Engine exhaust, some of its constituents, and certain vehicle components contain or emit chemicals known to the State of California to cause cancer and birth defects and reproductive harm. In addition, certain fluids contained in vehicles and certain products of component wear contain or emit chemicals known to the State of California to cause cancer and birth defects or other reproductive harm.
- Battery posts, terminals and related accessories contain lead and lead compounds, chemicals known to the State of California to cause cancer and reproductive harms. Wash hands after handling.

### **Note**

When filling fluids, be sure not to mix the fluids up. Otherwise severe malfunctions and engine damage will occur.

### **For the sake of the environment**

You should regularly check the ground under your vehicle in order to detect leaks quickly. If there are visible spots from oil or other fluids, bring your vehicle to an authorized Audi dealer or authorized Audi Service Facility to be checked.

### Opening/closing the hood

The hood is released from inside the vehicle.



Fig. 135 Driver footwell: release lever



Fig. 136 Rocker switch under the hood

Make sure the wiper arms are not raised up from the windshield. Otherwise the paint could be damaged.

#### Opening the hood

- ▶ With the driver's door open, pull the lever below the instrument panel in the direction of the arrow ⇒ *fig. 135*.

- ▶ Raise the hood slightly ⇒ ⚠.
- ▶ Press the rocker switch under the hood upward ⇒ *fig. 136*. This releases the catch.
- ▶ Open the hood.

#### Closing the hood

- ▶ Push the hood down until you override the force of the strut.
- ▶ Let the hood fall lightly into the latch. *Do not press it in.* ⇒ ⚠.

#### ⚠ WARNING

- Never open the hood when there is steam or coolant escaping from the engine compartment, because there is a risk that you could be burned. Wait until no steam or coolant is escaping.
- If the hood is not latched completely, it could fly up while you are driving and obstruct your vision.
- For safety reasons, the hood must always be closed securely while driving. Because of this, always check the hood after closing it to make sure it is latched correctly. The hood is latched if the front corners cannot be lifted.
- If you notice that the hood is not latched while you are driving, stop immediately and close it, because driving when the hood is not latched increases the risk of an accident.

### Engine compartment overview

The most important check points.

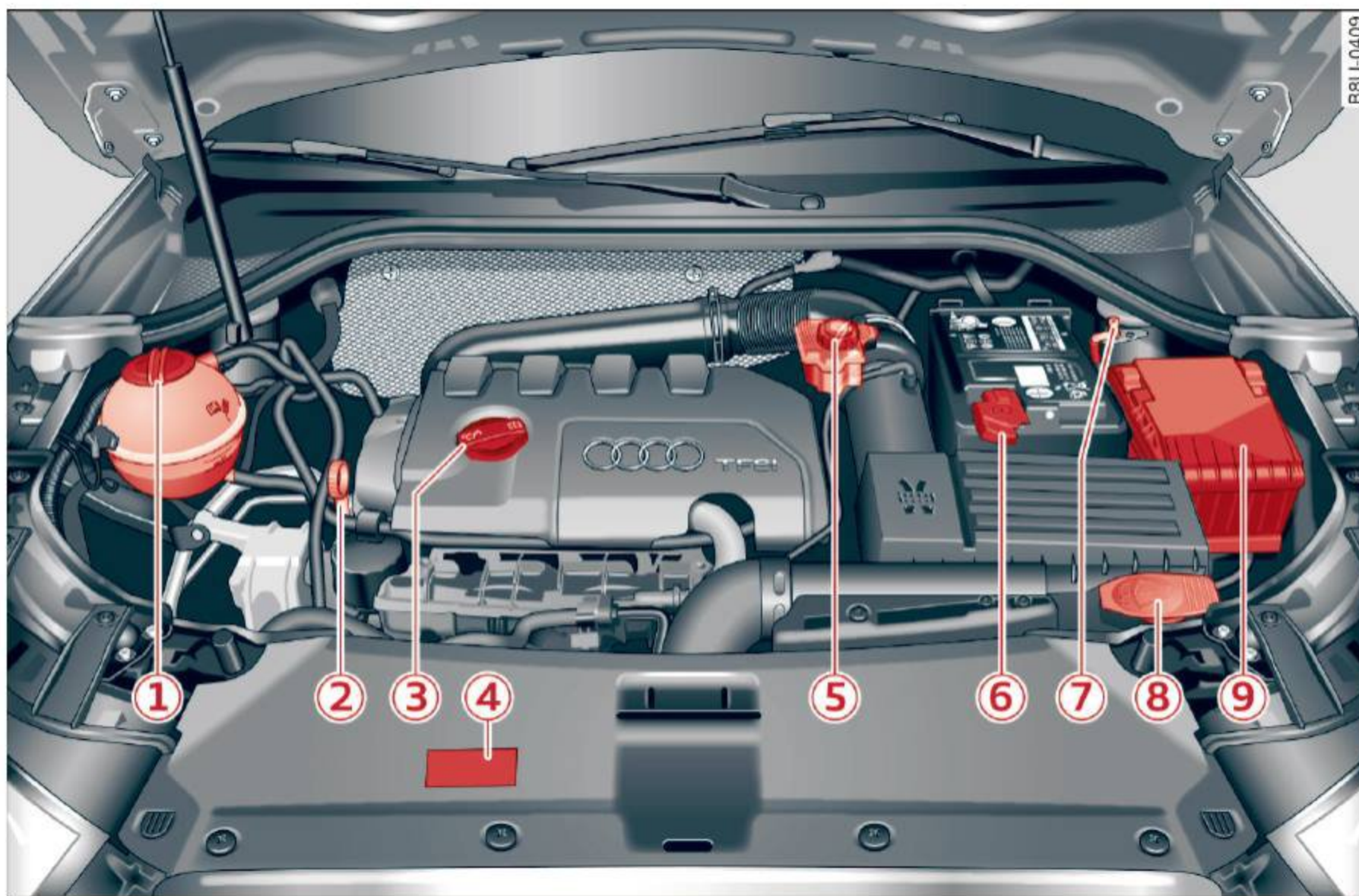



Fig. 137 Typical location of the reservoir and the engine oil filler opening

- ① Coolant reservoir (☞) ⇒ page 162
- ② Oil dipstick ⇒ page 160
- ③ Engine oil filler opening (☞) ⇒ page 160
- ④ Engine oil label\* with VW standard ⇒ page 158
- ⑤ Brake fluid reservoir (☞) ⇒ page 163
- ⑥ Vehicle battery (+) ⇒ page 164, ⇒ page 203
- ⑦ Jump start point (-) with hex head screw ⇒ page 164, ⇒ page 203
- ⑧ Washer fluid reservoir (☞) ⇒ page 165
- ⑨ Fuse housing ⇒ page 199

The oil dipstick (item ②) and the engine oil filler opening (item ③) can be located in different positions depending on the engine version.

#### WARNING

Read and follow all WARNINGS before checking anything in the engine compartment ⇒  in Working in the engine compartment on page 155.

## Engine oil

### Engine oil specifications

The engine oil used must conform to exact specifications.

The service interval display in the instrument cluster of your vehicle will inform you when it is time for an oil change. We recommend that you have your oil changed by an authorized Audi Service Advisor.

If you must add oil between oil changes, use an oil that matches the Audi oil quality standard listed on the sticker. The sticker is located at the front of the engine compartment ⇒ page 158, fig. 137.

#### Audi recommends

 **EDGE** PROFESSIONAL

Audi recommends LongLife high performance engine oil from Audi Genuine Parts



Using the proper engine oil is important for the functionality and service life of the engine. Your engine was factory-filled with a high-quality oil which can usually be used throughout the entire year.

**Note**

- Your Limited New Vehicle Warranty does not cover damage or malfunctions due to failure to follow recommended maintenance and use requirements as set forth in the Audi Owner's Manual and Warranty & Maintenance booklet.
- Use only a high quality engine oil that expressly complies with the Audi oil quality standard specified for your vehicle's engine. Using any other oil can cause serious engine damage.
  - Do not mix any lubricants or other additives into the engine oil. Doing so can cause engine damage.

**Tips**

- If you need to add oil and there is none available that meets the Audi oil quality standard your engine requires, you may add a total of no more than 0.5 quart/liter of a high-quality "synthetic" oil that meets the following specifications.
- ACEA A3 or API SM with a viscosity grade of SAE 0W-30, SAE 5W-30 or SAE 5W-40.
  - For more information about engine oil that has been approved for your vehicle, please contact either your authorized Audi dealer or Audi Customer Relations at 1 (800) 822-2834 or visit our web site at [www.audiusa.com](http://www.audiusa.com) or [www.audicanada.ca](http://www.audicanada.ca).

**Engine oil consumption**

*The engine in your vehicle depends on an adequate amount of oil to lubricate and cool all of its moving parts.*

In order to provide effective lubrication and cooling of internal engine components, all internal combustion engines consume a certain amount of oil. Oil consumption varies from engine to engine and may change significantly over the life of the engine. Typically, engines with a specified

break-in period (see ⇒ *page 57*) consume more oil during the break-in period than they consume after oil consumption has stabilized.

Under normal conditions, the rate of oil consumption depends on the quality and viscosity of the oil, the RPM (revolutions per minute) at which the engine is operated, the ambient temperature and road conditions. Further factors are the amount of oil dilution from water condensation or fuel residue and the oxidation level of the oil. As any engine is subject to wear as mileage builds up, the oil consumption may increase over time until replacement of worn components may become necessary.

With all these variables coming into play, no standard rate of oil consumption can be established or specified. There is no alternative to regular and frequent checking of the oil level, see **Note**.

If the yellow engine oil level warning symbol  in the instrument cluster lights up, you should check the oil level as soon as possible ⇒ *page 160*. Top off the oil at your earliest convenience.

**WARNING**

Before you check anything in the engine compartment, always read and heed all WARNINGS ⇒  *in Working in the engine compartment on page 155*.

**Note**

Driving with an insufficient oil level is likely to cause severe damage to the engine.

**Tips**

- The oil pressure warning display  is not an indicator of the oil level. Do not rely on it. Instead, check the oil level in your engine at regular intervals, preferably each time you refuel, and always before going on a long trip.
- If you have the impression your engine consumes excessive amounts of oil, we recommend that you consult an authorized Audi dealer to have the cause of your concern

properly diagnosed. Keep in mind that the accurate measurement of oil consumption requires great care and may take some time. An authorized Audi dealer has instructions about how to measure oil consumption accurately.

### Checking the engine oil level and adding engine oil

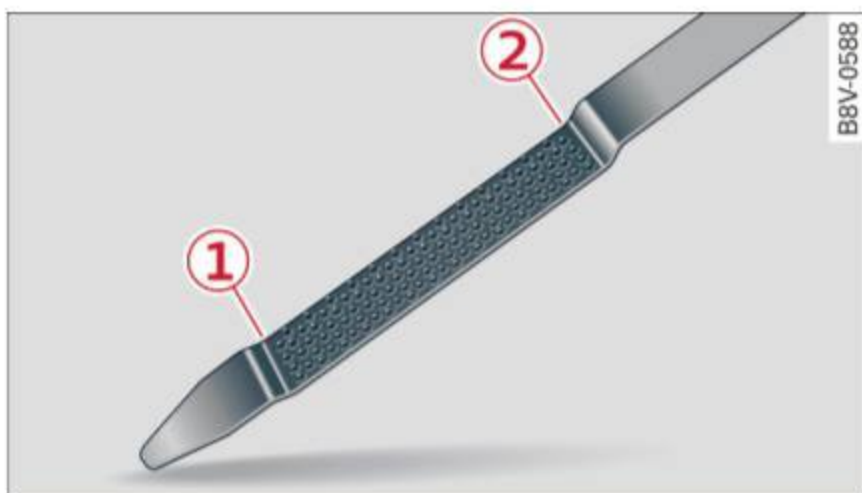

**Fig. 138** Oil dipstick (example): checking the engine oil level



**Fig. 139** Engine compartment: engine oil filler opening cover

Observe the safety precautions ⇒ *page 155, Working in the engine compartment.*

### Checking the engine oil level

- Park the vehicle on a level surface.
- Shut the engine off when it is warm. Wait approximately two minutes so that the engine oil can flow back into the oil pan.
- Open the hood ⇒ *page 157.*
- Remove the oil dipstick ⇒ *page 158, fig. 137,* wipe it off with a clean cloth and insert it all the way in again.
- Remove the oil dipstick again and then read the oil level ⇒ *table on page 160.*
- Add engine oil if necessary.

Areas on the oil dipstick ⇒ *fig. 138.*

- |   |   |
|---|---|
| ① | If the engine oil level is just before the marking ①, then engine oil must be added. See ⇒ ⚠. |
| ② | Do not add engine oil.  |

### Adding engine oil

- Unscrew the cap 🗝 ⇒ *fig. 139* for the engine oil filling opening ⇒ *page 158, fig. 137.*
- Carefully add 0.5 quart (0.5 liter) of the correct oil ⇒ *page 158.*
- Check the oil level again after two minutes.
- Add a smaller amount of engine oil if necessary. The marking ② ⇒ *fig. 138* must not be exceeded ⇒ ⚠.
- Screw the engine oil filler cap 🗝 and slide the dipstick all the way in.

### ⚠ WARNING

- When adding engine oil, do not let oil drip onto hot engine components. This increases the risk of a fire.
- You must seal the cap on the oil filler opening correctly so that oil does not leak out onto the hot engine and exhaust system when the engine is running, because this is a fire hazard.
- Always clean skin thoroughly if it comes into contact with engine oil.

### ⚠ Note

- The engine oil level must not be under the marking ①, because this increases the risk of engine damage.
- After adding engine oil, the oil level must not be above the marking ②, because this increases the risk of catalytic converter and/or engine damage. Do not start the engine. Contact an authorized Audi dealer or authorized Audi Service Facility to have excess engine oil extracted if necessary.
- Do not mix any additional lubricants into the engine oil. Damage caused by such additives is not covered by the warranty.



**For the sake of the environment**

- Engine oil should never enter the sewer system or come into contact with the ground under any circumstances.
- Pay attention to legal requirements when disposing of empty oil containers.



**Tips**

The engine oil consumption may be up to 0.5 quart/600 miles (0.5 liter/1,000 km), depending on driving style and operating conditions. Consumption may be higher during the first 3,000 miles (5,000 km). The engine oil level must be checked regularly. It would be best to check each time you refuel your vehicle and before long drives.

**Changing the engine oil**

*We recommend that have your oil changed by an authorized Audi dealer or a qualified service station.*

Before you check anything in the engine compartment, **always read and heed all WARNINGS** ⇨  *in Working in the engine compartment on page 155.*

The engine oil must be changed according to the intervals specified in your Warranty & Maintenance booklet. This is very important because the lubricating properties of oil diminish gradually during normal vehicle use.

Under some circumstances the engine oil should be changed more frequently. Change oil more often if you drive mostly short distances, operate the vehicle in dusty areas or under predominantly stop-and-go traffic conditions, or have your vehicle where temperatures remain below freezing for extended periods.

Detergent additives in the oil will make fresh oil look dark after the engine has been running for a short time. This is normal and is not a reason to change the oil more often than recommended.

Because of the problem of proper disposal, along with the special tools and necessary expertise required, we strongly recommend that you have

your oil changed by an authorized **Audi dealer** or a qualified service station.

**If you choose to change your oil yourself**, please note the following important information:



**WARNING**

To reduce the risk of personal injury if you must change the engine oil in your vehicle yourself:

- Wear eye protection.
- To reduce the risk of burns from hot engine oil, let the engine cool down to the touch.
- When removing the oil drain plug with your fingers, stay as far away as possible. Always keep your forearm parallel to the ground to help prevent hot oil from running down your arm.
- Drain the oil into a container designed for this purpose, one large enough to hold at least the total amount of oil in your engine.
- Engine oil is poisonous. Keep it well out of the reach of children.
- Continuous contact with used engine oil is harmful to your skin. Always protect your skin by washing oil off thoroughly with soap and water.



**Note**

Never mix oil additives with your engine oil. These additives can damage your engine and adversely affect your Audi Limited New Vehicle Warranty.



**For the sake of the environment**

- Before changing your oil, first make sure you know where you can properly dispose of the used oil.
- Always dispose of used engine oil properly. Do not dump it on garden soil, wooded areas, into open streams or down sewage drains.
- Recycle used engine oil by taking it to a used engine oil collection facility in your area, or contact a service station.

## Cooling system

### Coolant

The engine cooling system is filled with a mixture of purified water and coolant additive at the factory. This coolant must not be not changed.

The coolant level is monitored through the  indicator light ⇒ *page 12*. However, we do recommend occasionally checking the coolant level manually.

If you must add coolant, use a mixture of water and coolant additive. Mixing the coolant additive with distilled water is recommended.

### Coolant additive

The coolant additive is made of anti-freezing and corrosion protection agents. Only use the following coolant additives. These additives may be mixed with each other.

Coolant additive	Specification
G13	TL 774 J
G12++	TL 774 G

The amount of coolant additive that needs to be mixed with water depends on the climate where the vehicle will be operated. If the coolant additive percentage is too low, the coolant can freeze and damage the engine.

	Coolant additive	Freeze protection
Warm regions	min. 40% max. 45%	min. -13 °F (-25 °C)
Cold regions	min. 50% max. 55%	max. -40 °F (-40 °C)

### Note

- Before the start of winter, have an authorized Audi dealer or authorized Audi Service Facility check if the coolant additive in your vehicle matches the percentage appropriate for the climate. This is especially important when driving in colder climates.
- If the appropriate coolant additive is not available in an emergency, do not add any other additive. You could damage the en-

gine. If this happens, only use water and restore the correct mixture ratio with the specified coolant additive as soon as possible.

- Only refill with new coolant.
- Radiator sealant must not be mixed with the coolant.

### Adding coolant



Fig. 140 Engine compartment: coolant expansion tank cover

Observe the safety precautions ⇒ *page 155, Working in the engine compartment*.

### Checking the engine coolant level

- ▶ Park the vehicle on a level surface.
- ▶ Switch the ignition off.
- ▶ Read the coolant level on the coolant expansion tank ⇒ *page 158, fig. 137*. The coolant level must be between the markings when the engine is cold. When the engine is warm it can be slightly above the upper marking.

### Adding coolant

Requirement: there must be a residual amount of coolant in the expansion tank ⇒ .

- ▶ Let the engine cool down.
- ▶ Place a cloth over the coolant expansion tank cap and unscrew the cap counterclockwise ⇒ .
- ▶ Add coolant mixed in the correct ratio ⇒ *page 162* up to the upper marking.
- ▶ Make sure that the fluid level remains stable. Add more coolant if necessary.
- ▶ Close the cap securely.

Coolant loss usually indicates there is a leak. Immediately drive your vehicle to an authorized

Audi dealer or authorized Audi Service Facility and have the cooling system inspected. If the cooling system is not leaking, a loss can come from the coolant boiling through overheating and being pushed out of the cooling system.

**! WARNING**

- The cooling system is under pressure. Do not open the coolant expansion tank cap when the engine is hot. This increases the risk of burns.
- The coolant additive and the coolant can be dangerous to your health. For this reason, keep the coolant in the original container and away from children. There is a risk of poisoning.
- When working in the engine compartment, remember that the radiator fan can switch on even if the ignition is switched off, which increases the risk of injury.

**! Note**

Do not add coolant if the expansion tank is empty. Air could enter the cooling system and damage the engine. If this is the case, do not continue driving. See an authorized Audi dealer or authorized Audi Service Facility for assistance.

## Brake fluid



Fig. 141 Engine compartment: cap on brake fluid reservoir

Observe the safety precautions ⇒ *page 155, Working in the engine compartment.*

### Checking the brake fluid level

- ▶ Read the brake fluid level on the brake fluid reservoir ⇒ *page 158, fig. 137.* The brake fluid

level must be between the MIN and MAX markings ⇒ **!**.

The brake fluid level is monitored automatically.

### Changing the brake fluid

Have the brake fluid changed regularly by an authorized Audi dealer or authorized Audi Service Facility.

**! WARNING**

- If the brake fluid level is below the MIN marking, it can impair the braking effect and driving safety, which increase the risk of an accident. Do not continue driving. See an authorized Audi dealer or authorized Audi Service Facility for assistance.
- If the brake fluid is old, bubbles may form in the brake system during heavy braking. This would impair braking performance and driving safety, which increases the risk of an accident.
- To ensure the brake system functions correctly, only use brake fluids that comply with VW standard 501 14 or FMVSS-116 DOT 4.

**! Note**

- If the brake fluid level is above the MAX marking, brake fluid may leak out over the edge of the reservoir and result in damage to the vehicle.
- Do not get any brake fluid on the vehicle paint, because it will corrode the paint.





## Battery

### General warnings about batteries

Because of the complex power supply, all work on batteries such as disconnecting, replacing, etc. should **only** be performed by an authorized Audi dealer or authorized Audi Service Facility ⇒ **!**.

The term "vehicle battery" refers to the 12 Volt battery in your vehicle. ▶

### Detailed warnings for the vehicle battery:

	Wear eye protection.
	Battery acid is highly corrosive. Wear protective gloves and eye protection.
	Fire, sparks, open flame and smoking are forbidden.
	A highly explosive mixture of gases can form when charging batteries.
	Keep children away from battery acid and batteries.

#### WARNING

All work on the battery or electrical system in your vehicle can result in injuries, chemical burns, accidents or burns. Because of this, all work must be performed **only** by an authorized Audi dealer or authorized Audi Service Facility.

#### WARNING

California Proposition 65 Warning:  
 – Battery posts, terminals and related accessories contain lead and lead compounds, chemicals known to the State of California to cause cancer and reproductive problems. Wash hands after handling.

#### Note

Protect the vehicle battery against freezing if the vehicle will be parked for long periods of time so that it is not destroyed by “freezing”  
 ⇒ page 164, *Charging the vehicle battery*.

## Charging the vehicle battery







Fig. 142 Engine compartment: connectors for a charger and jump start cables

Observe the safety precautions ⇒ page 155, *Working in the engine compartment*.

Requirement: only use chargers with a **maximum charging current of 30 amps/14.8 Volts**. The vehicle battery cables remain connected.

The battery is located in the engine compartment. The ground point  is always located on the vehicle body.

- ▶ Read the warnings ⇒  in *General warnings about batteries* on page 164 and ⇒ .
- ▶ Switch off the ignition and all electrical equipment.
- ▶ Open the hood ⇒ page 157.
- ▶ Fold the battery cover upward ⇒ fig. 142.
- ▶ Clamp the terminal clamps on the charger correctly onto the ground point  and the positive terminal .
- ▶ Now insert the power cable for the charging device into the socket and switch the device on.
- ▶ At the end of the charging process, switch the charger off and pull the power cable out of the socket.
- ▶ Now remove the charging device terminal clamps.
- ▶ Close the battery cover.
- ▶ Close the hood ⇒ page 157.

#### WARNING

- A highly explosive mixture of gases can form when charging batteries. Only charge the vehicle battery in well-ventilated areas.
- A drained vehicle battery can freeze at temperatures around 32 °F (0 °C). A frozen or thawed vehicle battery must not be charged and must not be used anymore. The battery housing can crack and battery acid can leak out if ice forms, which increases the risk of an explosion and chemical burns. Contact an authorized Audi dealer or authorized Audi Service Facility for more information.
- Do not connect or disconnect the charging cable while charging because this increases the risk of an explosion.

**i Tips**

- Only charge the vehicle battery through the connections in the engine compartment.
- Read all of the manufacturer's instructions for the charger before charging the vehicle battery.

**Windshield washer system**

**Fig. 143** Engine compartment: windshield washer fluid reservoir

Observe the safety precautions ⇒ *page 155, Working in the engine compartment.*

The windshield washer fluid reservoir  contains the cleaning solution for the windshield and the rear window ⇒ *page 158, fig. 137, .* The reservoir capacity can be found in ⇒ *page 210.*

To reduce the risk of lime scale deposits on the spray nozzles, use clean water with low amounts of calcium. Always add window cleaner to the water. When the outside temperatures are cold, an anti-freezing agent should be added to the water so that it does not freeze.

**! Note**

- The concentration of anti-freezing agent must be adjusted to the vehicle operating conditions in the respective climate. A concentration that is too high can lead to vehicle damage.
- Never add radiator anti-freeze or other additives to the washer fluid.
- Do not use a glass cleaner that contains paint solvents, because this could damage the paint.

**Service interval display**

*The service interval display detects when your vehicle is due for service.*

The service interval display works in two stages:

- **Inspection or oil change reminder:** after a certain distance is driven, a message appears in the instrument cluster display every time the ignition is switched on. The remaining distance or time is displayed briefly.
- **Inspection or oil change due:** if your vehicle has reached an inspection or oil change interval or both intervals at the same time, the message **Inspection due!** or **Oil change due!** or **Oil change and inspection due!** appears briefly after switching the ignition on.

**Checking service intervals**

You can check the remaining distance or time until the next oil change or next inspection.

- Select: the **CAR** function button > **(Car) Systems\*** control button > **Servicing & checks** > **Service intervals.**

**Resetting the indicator**

An authorized Audi dealer or authorized Audi Service Facility will reset the service interval display after performing service.

If you have changed the oil yourself, you must reset the oil change interval.

Perform the following to reset the display:

- Select: the **CAR** function button > **(Car) Systems\*** control button > **Servicing & checks** > **Service intervals.** Turn the control knob downward to **Reset oil change interval** and press the control knob.

**! Note**

- Only reset the oil change indicator if the oil was changed.
- Following the service intervals is critical to maintaining the service life and value of your vehicle, especially the engine. Even if the mileage on the vehicle is low, do not exceed the time for the next service.

## Wheels

### Wheels and Tires

#### General information

- ▶ Check your tires regularly for damage (punctures, cuts, cracks and bulges). Remove foreign objects from the tire tread.
- ▶ If driving over curbs or similar obstacles, drive slowly and approach the curb at an angle.
- ▶ Have faulty tires or rims replaced immediately.
- ▶ Protect your tires from oil, grease and fuel.
- ▶ Mark tires before removing them so that the same running direction can be maintained if they are reinstalled.
- ▶ Lay tires flat when storing and store them in a cool, dry location with as little exposure to light as possible.

#### WARNING

- Never drive faster than the maximum permitted speed for your tires. This could cause the tires to heat up too much. This increases the risk of an accident because it can cause the tire to burst.
- Always adapt your driving to the road and traffic condi-

tions. Drive carefully and reduce your speed on icy or slippery roads. Even winter tires can lose traction on black ice.

#### Note

- Please note that summer and winter tires are designed for the conditions that are typical in those seasons. Audi recommends using winter tires during the winter months. Low temperatures significantly decrease the elasticity of summer tires, which affects traction and braking ability. If summer tires are used in very cold temperatures, cracks can form on the tread bars, resulting in permanent tire damage that can cause loud driving noise and unbalanced tires.
- Burnished, polished or chromed rims must not be used in winter driving conditions. The surface of the rims does not have sufficient corrosion protection for this and could be permanently damaged by road salt or similar substances.



## Tire designations

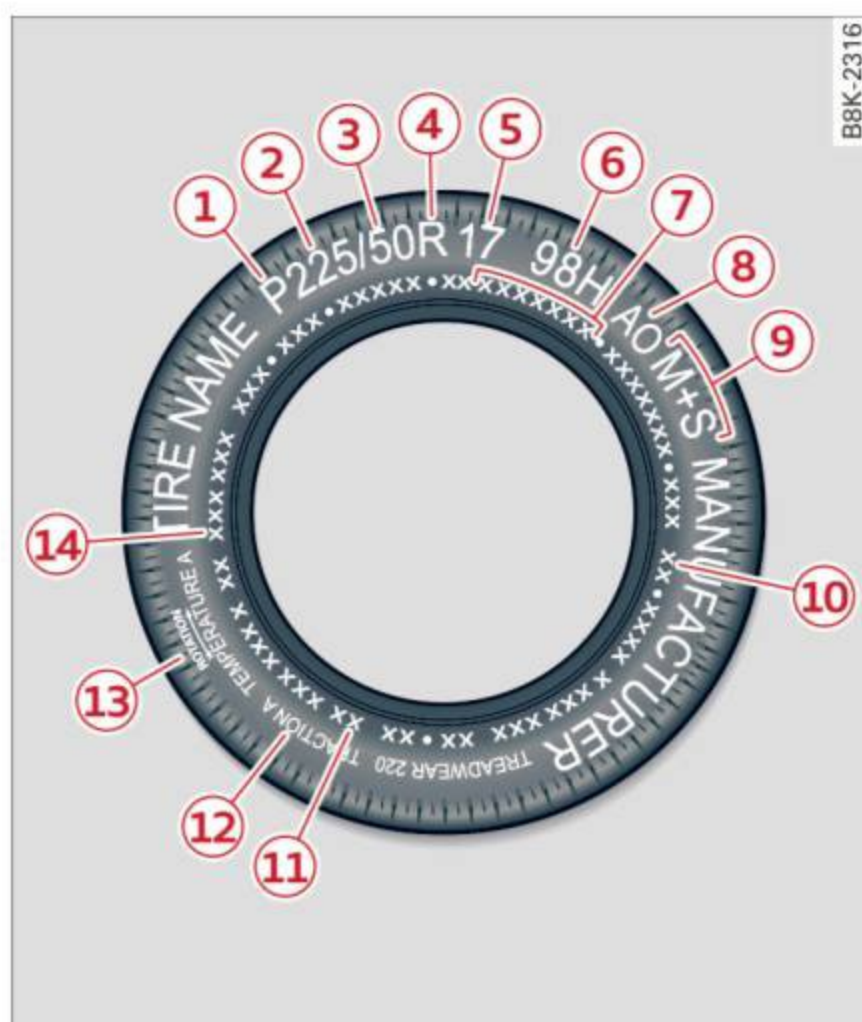

**Fig. 144** Tire designations on the sidewall

### ① Tires for passenger vehicles (if applicable)

"P" indicates a tire for a passenger vehicle. "T" indicates a tire designated for temporary use.

### ② Nominal width

Nominal width of the tire between the sidewalls in millimeters. In general: the larger the number, the wider the tire.

### ③ Aspect ratio

Height/width ratio expressed as a percentage.

### ④ Tire construction

R indicates a radial tire.

### ⑤ Rim diameter

Size of the rim diameter in inches.

### ⑥ Load index and speed rating

The load index indicates the tire's load-carrying capacity.

The speed rating indicates the maximum permitted speed. Also see ⇒ ⚠ in *General information on page 166*.

"EXTRA LOAD", "xl" or "RF" indicates that the tire is reinforced or is an Extra Load tire.

Speed rating	Maximum permitted speed
P	up to 93 mph (150 km/h)
Q	up to 99 mph (160 km/h)
R	up to 106 mph (170 km/h)
S	up to 110 mph (180 km/h)
T	up to 118 mph (190 km/h)
U	up to 124 mph (200 km/h)
H	up to 130 mph (210 km/h)
V	up to 149 mph (240 km/h) <sup>a)</sup>
Z	above 149 mph (240 km/h) <sup>a)</sup>
W	up to 168 mph (270 km/h) <sup>a)</sup>
Y	up to 186 mph (300 km/h) <sup>a)</sup>

<sup>a)</sup> For tires above 149 mph (240 km/h), tire manufacturers sometimes use the code "ZR".

### ⑦ US DOT number (TIN) and manufacture date

The manufacture date is listed on the tire sidewall (it may only appear on the inner side of the tire):

**DOT ... 2217 ...**

means, for example, that the tire was produced in the 22nd week of the year 2017.

### ⑧ Audi Original Tires

Audi Original equipment tires with the designation “AO” have been specially matched to your Audi. When used correctly, these tires meet the highest standards for safety and handling. An authorized Audi dealer or authorized Audi Service Facility will be able to provide you with more information.

### ⑨ Mud and snow capability

“M/S” or “M+S” indicates the tire has properties making it suitable to drive in mud or snow.  indicates a winter tire.

### ⑩ Composition of the tire cord and materials

The number of plies indicates the number of rubberized fabric layers in the tire. In general: the more layers, the more weight a

tire can carry. Tire manufacturers must also specify the materials used in the tire. These include steel, nylon, polyester and other materials.

### ⑪ Maximum permitted load

This number indicates the maximum load in kilograms and pounds that the tire can carry.

### ⑫ Uniform tire quality grade standards for treadwear, traction and temperature resistance

Treadwear, traction and temperature ranges ⇒ *page 182*.

### ⑬ Running direction

The arrows indicate the running direction of unidirectional tires. You must always follow the specified running direction ⇒ *page 196*.

### ⑭ Maximum permitted inflation pressure

This number indicates the maximum pressure to which a tire can be inflated under normal operating conditions.

## Glossary of tire and loading terminology

### Accessory weight

means the combined weight (in excess of those standard items which may be replaced) of automatic transmission, power steering, power brakes, power windows, power seats, radio, and heater, to the extent that these items are available as factory-installed equipment (whether installed or not).

### Aspect ratio

means the ratio of the height to the width of the tire in percent. Numbers of 55 or lower indicate a low sidewall for improved steering response and better overall handling on dry pavement.

### Bead

means the part of the tire that is made of steel wires, wrapped or reinforced by ply cords and that is shaped to fit the rim.

### Bead separation

means a breakdown of the bond between components in the bead.

### Cord

means the strands forming the plies in the tire.

### Cold tire inflation pressure

means the tire pressure recommended by the vehicle manufacturer for a tire of a designated size that has not been driven for more than a couple of miles (kilometers) at low speeds in the three hour period before the tire pressure is measured or adjusted.

### Curb weight

means the weight of a motor vehicle with standard equipment including the maximum capacity of fuel, oil, and coolant, air conditioning and additional weight of optional equipment.

### Extra load tire

means a tire designed to operate at higher loads and at higher inflation pressures than the corresponding standard tire. Extra load tires may be identified as “XL”, “xl”, “EXTRA LOAD”, or “RF” on the sidewall. ▶

**Gross Axle Weight Rating (“GAWR”)**

means the load-carrying capacity of a single axle system, measured at the tire-ground interfaces.

**Gross Vehicle Weight Rating (“GVWR”)**

means the maximum total loaded weight of the vehicle.

**Groove**

means the space between two adjacent tread ribs.

**Load rating (code)**

means the maximum load that a tire is rated to carry for a given inflation pressure. You may not find this information on all tires because it is not required by law.

**Maximum load rating**

means the load rating for a tire at the maximum permissible inflation pressure for that tire.

**Maximum loaded vehicle weight**

means the sum of:

- (a) Curb weight
- (b) Accessory weight
- (c) Vehicle capacity weight, and
- (d) Production options weight

**Maximum (permissible) inflation pressure**

means the maximum cold inflation pressure to which a tire may be inflated. Also called “maximum inflation pressure.”

**Normal occupant weight**

means 150 lbs. (68 kilograms) times the number of occupants seated in the vehicle up to the total seating capacity of your vehicle.

**Occupant distribution**

means distribution of occupants in a vehicle.

**Outer diameter**

means the overall diameter of an inflated new tire.

**Overall width**

means the linear distance between the exteriors of the sidewalls of an inflated tire, including elevations due to labeling, decorations, or protective bands or ribs.

**Ply**

means a layer of rubber-coated parallel cords. ▶

**Production options weight**

means the combined weight of those installed regular production options weighing over 5 lbs.

(2.3 kg) in excess of those standard items which they replace, not previously considered in curb weight or accessory weight, including heavy duty brakes, ride levelers, roof rack, heavy duty battery, and special trim.

**Radial ply tire**

means a pneumatic tire in which the ply cords that extend to the beads are laid at substantially 90 degrees to the centerline of the tread.

**Recommended inflation pressure**

see ⇨ *page 169, Cold tire inflation pressure.*

**Reinforced tire**

means a tire designed to operate at higher loads and at higher inflation pressures than the corresponding standard tire. Reinforced tires may be identified as “XL”, “xl”, “EXTRA LOAD”, or “RF” on the sidewall.

**Rim**

means a metal support for a tire or a tire and tube assembly upon which the tire beads are seated.

**Rim diameter**

means nominal diameter of the bead seat. If you change your wheel size, you will have to purchase new tires to match the new rim diameter.

**Rim size designation**

means rim diameter and width.

**Rim width**

means nominal distance between rim flanges.

**Sidewall**

means that portion of a tire between the tread and bead.

**Speed rating (letter code)**

means the speed at which a tire is designed to be driven for extended periods of time. The ratings range from 93 mph (150 km/h) to 186 mph (298 km/h) ⇨ *table on page 167.* You may not find this information on all tires because it is not required by law.

The speed rating letter code, where applicable, is molded on the tire sidewall and indicates the ►

maximum permissible road speeds. See also ⇒  in *General information on page 166*.

### **Tire pressure monitoring system\***

means a system that detects when one or more of a vehicle's tires are underinflated and illuminates a low tire pressure warning telltale.

### **Tread**

means that portion of a tire that comes into contact with the road.

### **Tread separation**

means pulling away of the tread from the tire carcass.

### **Treadwear indicators (TWI)**

means the projections within the principal grooves designed to give a visual indication of the degrees of wear of the tread. See ⇒ *page 175, Treadwear indicator* for more information on measuring tire wear.

### **Uniform Tire Quality Grading**

is a tire information system developed by the United States National Highway Traffic Safety Administration (NHTSA) that is designed to help buyers make relative com-

parisons among tires. The UTQG is not a safety rating and not a guarantee that a tire will last for a prescribed number of miles (kilometers) or perform in a certain way. It simply gives tire buyers additional information to combine with other considerations, such as price, brand loyalty and dealer recommendations. Under UTQG, tires are graded by the tire manufacturers in three areas: treadwear, traction, and temperature resistance. The UTQG information on the tires, molded into the sidewalls.

### **U.S. DOT Tire Identification Number (TIN)**

This is the tire's "serial number". It begins with the letters "DOT" and indicates that the tire meets all federal standards. The next two numbers or letters indicate the plant where it was manufactured, and the last four numbers represent the week and year of manufacture. For example,

**DOT ... 2217 ...**

means that the tire was produced in the 22nd week of 2017. The other numbers are marketing codes that may or may not be used ▶

by the tire manufacturer. This information is used to contact consumers if a tire defect requires a recall.

### **Vehicle capacity weight**

means the rated cargo and luggage load plus 150 lbs. (68 kilograms) times the vehicle's designated seating capacity.

### **Vehicle maximum load on the tire**

means that load on an individual tire that is determined by distributing to each axle its share of the maximum loaded vehicle weight and dividing by two.

### **Vehicle normal load on the tire**

means that load on an individual tire that is determined by distributing to each axle its share of the curb weight, accessory weight, and normal occupant weight (distributed in accordance with ⇒ *table on page 178*) and dividing by two.

### **Occupant loading and distribution for vehicle normal load for various designated seating capacities**

Refer to the tire inflation pressure label ⇒ *page 176, fig. 147*

for the number of seating positions. Refer to the table ⇒ *table on page 178* for the number of people that correspond to the vehicle normal load.

### **New tires or wheels**

Audi recommends having all work on tires or wheels performed by an authorized Audi dealer or authorized Audi Service Facility. These facilities have the proper knowledge and are equipped with the required tools and replacement parts.

- ▶ New tires do not yet have the optimum gripping properties. Drive carefully and at moderate speeds for the first 350 miles (500 km) with new tires.
- ▶ Only use tires with the same design, size (rolling circumference) and as close to the same tread pattern as possible on all four wheels.
- ▶ Do not replace tires individually. At least replace both tires on the same axle at the same time.
- ▶ Audi recommends that you use Audi Original Tires. If you would like to use different tires, please note that the tires may perform ▶

differently even if they are the same size ⇒ ⚠.

- ▶ If you would like to equip your vehicle with a tire/rim combination that is different from what was installed at the factory, consult with an authorized Audi dealer or authorized Audi Service Facility before making a purchase ⇒ ⚠.

If the spare tire is different from the regular tires installed on the vehicle - for example, if winter tires or wide tires are installed - then only use the spare tire temporarily in case of emergency and drive carefully while it is in use. It should be replaced with a regular tire as soon as possible.

Applies to: vehicles with all wheel drive: all four wheels must be equipped with tires that are the same brand and have the same construction and tread pattern so that the drive system is not damaged by different wheel speeds. For this reason, in case of emergency, only use a spare tire that has the same circumference as the regular tires.

### WARNING

- Only use tire/rim combinations and suitable wheel bolts that have been approved by Audi. Otherwise, damage to the vehicle and an accident could result.
- For technical reasons, it is not possible to use tires from other vehicles - in some cases, you cannot even use tires from the same vehicle model.
- Make sure that the tires you select have enough clearance to the vehicle. Replacement tires should not be chosen simply based on the nominal size, because tires with a different construction can differ greatly even if they are the same size. If there is not enough clearance, the tires or the vehicle can be damaged and this can reduce driving safety and increase the risk of an accident.
- Only use tires that are more than six years old when absolutely necessary and drive carefully when doing so.
- Do not use run-flat tires on your vehicle. Using them when



not permitted can lead to vehicle damage or accidents.

- If you install wheel covers on the vehicle, make sure they allow enough air circulation to cool the brake system. If they do not, this could increase the risk of an accident.

## Tire wear/damage



**Fig. 145** Tire profile: treadwear indicator

## Tire wear

Check the tires regularly for wear.

- Inflation pressure that is too low or high can increase tire wear considerably.
- Driving quickly through curves, rapid acceleration and heavy braking increase tire wear.
- Have an authorized Audi dealer or authorized Audi Service Facili-

ty check the wheel alignment if there is unusual wear.

- Have the wheels rebalanced if an imbalance is causing noticeable vibration in the steering wheel. If you do not, the tires and other vehicle components could wear more quickly.

## Treadwear indicator

Original equipment tires contain treadwear indicators in the tread pattern, which are bars that are 1/16 in (1.6 mm) high and are spaced evenly around the tire perpendicular to the running direction ⇒ *fig. 145*. The letters “TWI” or triangles on the tire sidewall indicate the location of the treadwear indicators.

The tires have reached the minimum tread depth <sup>1)</sup> when they have worn down to the treadwear indicators. Replace the tires with new ones ⇒ ⚠.

## Tire rotation

Rotating the tires regularly is recommended to ensure the tires wear evenly. To rotate the tires, install the tires from the rear axle ►

<sup>1)</sup> Obey any applicable regulations in your country.

on the front axle and vice versa. This will allow the tires to have approximately the same length of service life.

For unidirectional tires, make sure the tires are installed according to the running direction indicated on the tire sidewall

⇒ *page 196.*

### Hidden damage

Damage to tires and rims can often occur in locations that are hidden. Unusual vibrations in the vehicle or pulling to one side may indicate that there is tire damage. Reduce your speed immediately. Check the tires for damage. If no damage is visible from the outside, drive slowly and carefully to the nearest authorized Audi dealer or authorized Audi Service Facility to have the vehicle inspected.

**⚠ WARNING**

Tread that has worn too low or different tread depths on the tires can reduce driving safety. This can increase the risk of an accident because it has a negative effect on handling, driving through curves, and braking, and because it increases the

risk of hydroplaning when driving through deep puddles.

### Tire pressure



**Fig. 146** Driver's side B-pillar: tire pressure label

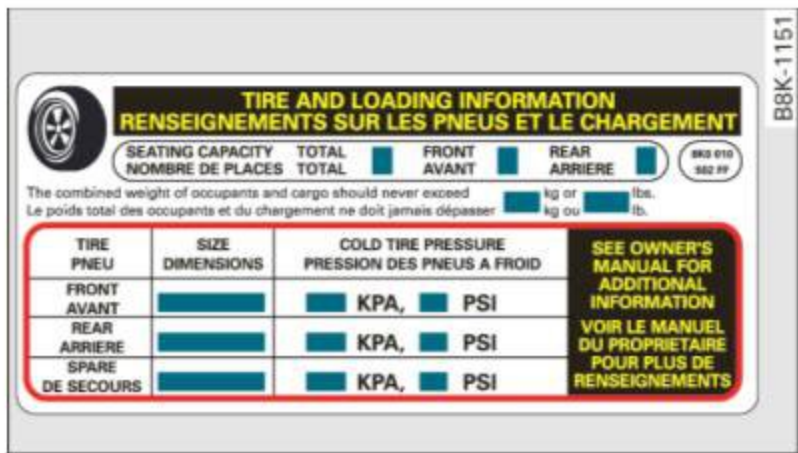

**Fig. 147** Tire pressure label

The correct tire pressure for tires mounted in the factory and for the spare tire\* is indicated on a label. The label is located on the B-pillar ⇒ *fig. 146*, ⇒ *fig. 147*.

Use the tire pressure specified for a normal vehicle load when the vehicle is partially loaded ⇒ *table on page 178*. If driving the vehicle when fully loaded, you must increase the tire pressure to the maximum specified pressure ⇒ ⚠ ▶

## Checking/correcting tire pressure

- ▶ Check the tire pressure at least once per month and also check it before every long drive.
- ▶ Always check the tire pressure when the tires are *cold*. Do not reduce the pressure if it increases when the tires are warm.
- ▶ Check the label ⇒ *fig. 147* for the correct tire pressure based on vehicle load.
- ▶ Correct the tire pressure if necessary.
- ▶ Vehicles with Tire Pressure Monitoring System\*: store the modified tire pressure in the Infotainment system ⇒ *page 184*.
- ▶ Check the pressure in the emergency tire\*/spare tire\*. Always maintain the maximum temperature that is specified for the tire.

### WARNING

Always adapt the tire pressure to your driving style and vehicle load.

- Overloading can lead to loss of vehicle control and increase the risk of an accident. Read and follow the important safety precautions in ⇒ *page 178, Tires and vehicle load limits*.
- The tire must flex more if the tire pressure is too low or if the vehicle speed or load are too high. This heats the tire up too much. This increases the risk of an accident because it can cause the tire to burst and result in loss of vehicle control.
- Incorrect tire pressure increases tire wear and has a negative effect on driving and braking behavior, which increases the risk of an accident.

### Note

Replace lost valve caps to reduce the risk of damage to the tire valves.

### For the sake of the environment

Tire pressure that is too low increases fuel consumption.

## Tire pressure table

Please note that the information contained in the following table was correct at the time of print-

ing, and the information is subject to change. If there are differences between this information ▶

and the tire pressures specified on the label on the driver's side B-pillar, always follow the specification on the B-pillar label  
 ⇒ *page 176, fig. 146.*

Make sure that the tire designation on your tire matches the des-

ignation on the tire pressure label and the tire pressure table.

The following table lists recommended tire pressures in cold tires according to the load and the size of the tires installed.

Model/ Engine	Tire designation	Tire pressure							
		Normal load (up to 3 people) <sup>a)</sup>				Maximum load			
		front		rear		front		rear	
		PSI	kPA	PSI	kPA	PSI	kPA	PSI	kPA
Q3: 2.0L 4 cylinders	235/50 R18 97H	32	220	32	220	33	230	36	250
	235/50 R18 97V	32	220	32	220	33	230	36	250
	255/40 R19 100Y	33	230	33	230	44	300	46	320
	255/35 R20 97Y	33	230	33	230	44	300	46	320
	255/40 R19 100H	33	230	33	230	44	300	46	320

a) 2 people in the front, 1 person in the rear

 **WARNING**

Please note the important safety precautions regarding tire pressure ⇒ *page 176* and load limits ⇒ *page 178*.

### Tires and vehicle load limits

There are limits to the amount of load or weight that any vehicle and any tire can carry. A vehicle that is overloaded will not handle well and is more difficult to stop. Overloading can not only lead to loss of vehicle control, but can also damage important parts of the vehicle and can lead to sudden

tire failure, including a blowout and sudden deflation that can cause the vehicle to crash.

Your safety and that of your passengers also depends on making sure that load limits are not exceeded. Vehicle load includes everybody and everything in and on the vehicle. These load limits are technically referred to as the vehicle's **Gross Vehicle Weight Rating** ("GVWR").

The "GVWR" includes the weight of the basic vehicle, all factory installed accessories, a full tank of ►

fuel, oil, coolant and other fluids plus maximum load. The maximum load includes the number of passengers that the vehicle is intended to carry (“seating capacity”) with an assumed weight of 150 lbs. (68 kg) for each passenger at a designated seating position and the total weight of any luggage in the vehicle. If you tow a trailer, the weight of the trailer hitch and the tongue weight of the loaded trailer must be included as part of the vehicle load.

The **Gross Axle Weight Rating** (“GAWR”) is the maximum load that can be applied at each of the vehicle’s two axles.

The fact that there is an upper limit to your vehicle’s Gross Vehicle Weight Rating means that the total weight of whatever is being carried in the vehicle (including the weight of a trailer hitch and the tongue weight of the loaded trailer) is limited. The more passengers in the vehicle or passengers who are heavier than the standard weights assumed mean that less weight can be carried as luggage.

The Gross Vehicle Weight Rating and the Gross Axle Weight Rating are listed on the safety compliance sticker label located on the driver’s side B-pillar.

 **WARNING**

Overloading a vehicle can cause loss of vehicle control, a crash or other accident, serious personal injury, and even death.

- Carrying more weight than your vehicle was designed to carry will prevent the vehicle from handling properly and increase the risk of the loss of vehicle control.
- The brakes on a vehicle that has been overloaded may not be able to stop the vehicle within a safe distance.
- Tires on a vehicle that has been overloaded can fail suddenly, including a blowout and sudden deflation, causing loss of control and a crash.
- Always make sure that the total load being transported – including the weight of a trailer hitch and the tongue weight of a loaded trailer – does not make the vehicle heavier than the vehicle’s Gross Vehicle Weight Rating.

## Determining correct load limit

Use the example below to calculate the total weight of the passengers and luggage or other things that you plan to transport so that you can make sure that your vehicle will not be overloaded.

### Steps for Determining Correct Load Limit

1. Locate the statement “THE COMBINED WEIGHT OF OCCUPANTS AND CARGO SHOULD NEVER EXCEED XXX KG OR XXX LBS” on your vehicle’s placard (tire inflation pressure label) ⇒ *page 176, fig. 146.*
2. Determine the combined weight of the driver and passengers that will be riding in your vehicle.
3. Subtract the combined weight of the driver and passengers from “XXX” kilograms or “XXX” pounds shown on the sticker ⇒ *page 176, fig. 146.*
4. The resulting figure equals the available amount of cargo and luggage load capacity. For example, if the “XXX” amount equals 1400 lbs. and there will

be five 150 lbs. passengers in your vehicle, the amount of available cargo and luggage load capacity is 650 lbs.

( $1400 - 750 (5 \times 150) = 650$  lbs.)

5. Determine the combined weight of luggage and cargo being loaded on the vehicle. That weight may not safely exceed the available cargo and luggage load capacity calculated in Step 4.
6. If your vehicle will be towing a trailer, load from your trailer will be transferred to your vehicle. Consult this manual to determine how this reduces the available cargo and luggage load capacity of your vehicle.
  - ▶ Check the tire sidewall (⇒ *page 167, fig. 144*) to determine the designated load rating for a specific tire.

## Wheel bolts and rims

### Wheel bolts

Wheel bolts must be clean and loosen/tighten easily.

### Rims

Rims with a bolted rim ring\* or with bolted wheel covers\* consist of multiple pieces. These components were bolted together using special bolts ▶

and a special procedure. You must not repair or disassemble them ⇒ ⚠.

### **WARNING**

Wheel bolts that are tightened or repaired incorrectly can become loose and result in loss of vehicle control, which increases the risk of an accident. For the correct tightening specification, see ⇒ *page 192, After changing a wheel.*

- Always keep the wheel bolts and the threads in the wheel hub clean and free of grease.
- Only use wheel bolts that fit the rim.
- Always have damaged rims repaired by an authorized Audi dealer or authorized Audi Service Facility. Never repair or disassemble rims yourself, because this increases the risk of an accident.

### **Winter tires**

Winter tires significantly improve the vehicle's handling when driving in winter conditions. Because of their construction (width, compound, tread pattern), summer tires provide less traction on ice and snow.

- ▶ Use winter tires on all four wheels.
- ▶ Only use winter tires that are approved for your vehicle.
- ▶ Please note that the maximum permitted speed may be lower with winter tires ⇒ ⚠ *in General information on page 166.* An authorized Audi dealer or authorized Audi Service Facility can inform you about the maximum permitted speed for your tires.
- ▶ Check the tire pressure after installing wheels ⇒ *page 176.*

The effectiveness of winter tires is reduced greatly when the tread is worn down to a depth of 0.157 in (4 mm). The characteristics of winter tires also decrease greatly as the tire ages, regardless of the remaining tread.

### **For the sake of the environment**

Reinstall summer tires at the appropriate time, because they provide better handling

when roads are free of snow and ice. Summer tires cause less road noise, tire wear and fuel consumption.

### **Tips**

You can also use all season tires instead of winter tires. Please note that in some countries where winter tires are required, only winter tires with the  symbol may be permitted.

### **Snow chains**

Snow chains not only improve the driving in winter road conditions, but also the braking.

- ▶ Only install snow chains on the front wheels. This applies also to vehicles with all wheel drive\*.
- ▶ Check and correct the seating of the snow chains after driving a few feet, if necessary. Follow the instructions from the manufacturer.
- ▶ Note the maximum permitted speed when driving with snow chains. Do not exceed 30 mph (50 km/h).

Use **fine-mesh snow chains**. They must not add more than 0.53 inch (13.5 mm) in height, including the chain lock.

You must remove the snow chains on roads without snow. Otherwise, you could impair driving ability and damage the tires.

Use of snow chains is only permitted with certain rim/tire combinations due to technical reasons. Check with an authorized Audi dealer or authorized Audi Service Facility to see if you may use snow chains.

### **WARNING**

Using incorrect snow chains or installing snow chains incorrectly can result in loss of vehicle control, which increases the risk of an accident.

### **Note**

Snow chains can damage the rims/wheel covers\* if the chains come into direct contact

with them. Remove the wheel covers\* first.  
Use coated snow chains.

### Low-profile tires

Applies to: vehicles with low-profile tires

Your vehicle is equipped with low-profile tires\* at the factory. Compared to other tire/rim combinations, low-profile tires offer a wider tread surface and a larger rim diameter with shorter tire sidewalls. This results in an agile driving style. However, it may reduce the level of comfort and increase road noise when driving on roads in poor condition.

Low-profile tires can become damaged more quickly than standard tires when driving over large bumps, potholes, manhole covers, speed bumps and curbs. Therefore, it is particularly important to maintain the correct tire pressure  
⇒ *page 176*.

To reduce the risk of damage to the tires and rims, drive very carefully on poor roads.

Check your wheels regularly every 2,000 mi (3,000 km) for damage. For example, check for bulges/cracks on the tires or deformations/cracks on the rims.

After a heavy impact or damage, have the tires and rims inspected or replaced immediately by an authorized Audi dealer or authorized Audi Service Facility.

Low-profile tires can wear out faster than standard tires.

Summer tires are not suitable for cold weather, snow or black ice. If you are driving in these conditions, use winter or all season tires  
⇒ *page 181*.

### Uniform tire quality grading

- Tread wear
- Traction AA A B C
- Temperature A B C

Quality grades can be found where applicable on the tire side wall between tread shoulder and maximum section width ⇒ *page 167, fig. 144*.

**For example:** Tread wear **200**, Traction **AA**, Temperature **A**.

All passenger car tires must conform to Federal Safety Requirements in addition to these grades.

### Tread wear

The *tread wear* grade is a comparative rating based on the wear rate of the tire when tested under controlled conditions on a specified government test course.

For example, a tire graded 150 would wear one and one half (1 1/2) times as well on the government course as a tire graded 100.

The relative performance of tires depends upon the actual conditions of their use, however, and may depart significantly from the norm due to variations in driving habits, service practices and differences in road characteristics and climate.

### Traction

The *traction* grades, from highest to lowest, are AA, A, B and C. Those grades represent the tire's ability to stop on wet pavement as measured under controlled conditions on specified government test surfaces of asphalt and concrete. A tire marked C may have poor traction performance  
⇒ .

### Temperature

The *temperature* grades are A (the highest), B, and C, representing the tire's resistance to the generation of heat and its ability to dissipate heat when tested under controlled conditions on a specified indoor laboratory test wheel.

Sustained high temperature can cause the material of the tire to degenerate and reduce tire life, and excessive temperature can lead to sudden tire failure ⇒ .

The grade C corresponds to a level of performance which all passenger car tires must meet under the Federal Motor Vehicle Safety Standard No. 109. Grades B and A represent higher levels of performance on the laboratory test wheel than the minimum required by law. ►



**⚠ WARNING**

The traction grade assigned to this tire is based on straight-ahead braking traction tests, and does not include acceleration, cornering, hydroplaning or peak traction characteristics.

**⚠ WARNING**

The temperature grade for this tire is established for a tire that is properly inflated and not overloaded. Excessive speed, underinflation, or excessive loading, either separately or in combination, can cause heat buildup and possible tire failure.

**⚠ WARNING**

Temperature grades apply to tires that are properly inflated and not over or underinflated.

## Tire pressure monitoring system

### **(i) General notes**

Applies to: vehicles with tire pressure monitoring system

Each tire, including the spare (if provided), should be checked monthly when cold and inflated to the inflation pressure recommended by the vehicle manufacturer on the vehicle placard or tire inflation pressure label. (If your vehicle has tires of a different size than the size indicated on the vehicle placard or tire inflation pressure label, you should determine the proper tire inflation pressure for those tires).

As an added safety feature, your vehicle has been equipped with a tire pressure monitoring system (TPMS) that illuminates a low tire pressure telltale when one or more of your tires is significantly under-inflated. Accordingly, when the low tire pressure telltale illuminates, you should stop and check your tires as soon as possible, and inflate them to the proper pressure. Driving on a significantly under-inflated tire causes the tire to overheat and can lead to tire failure. Under-inflation also reduces fuel efficiency and tire tread life,

and may affect the vehicle's handling and stopping ability.

Please note that the TPMS is not a substitute for proper tire maintenance, and it is the driver's responsibility to maintain correct tire pressure, even if under-inflation has not reached the level to trigger illumination of the TPMS low tire pressure telltale.

Your vehicle has also been equipped with a TPMS malfunction indicator to indicate when the system is not operating properly. The TPMS malfunction indicator is combined with the low tire pressure telltale. When the system detects a malfunction, the telltale will flash for approximately one minute and then remain continuously illuminated. This sequence will continue upon subsequent vehicle start-ups as long as the malfunction exists.

When the malfunction indicator is illuminated, the system may not be able to detect or signal low tire pressure as intended. TPMS malfunctions may occur for a variety of reasons, including the installation of replacement or alternate tires or wheels on the vehicle that prevent the TPMS from functioning properly. Always check the TPMS malfunction telltale after replacing one or more tires or wheels on your vehicle to ensure that the replacement or alternate tires and wheels allow the TPMS to continue to function properly.

### **If the Tire Pressure Monitoring System indicator appears**

Applies to: vehicles with Tire Pressure Monitoring System indicator

*The tire pressure indicator in the instrument cluster informs you if the tire pressure is too low or if there is a system malfunction.*



Using the ABS sensors, the tire pressure monitoring system compares the tire tread circumference and vibration characteristics of the individual tires. If the pressure changes in one or more wheels, this is indicated in the instrument cluster display with the **(i)** indicator light and a message. If only one tire is affected, the location of that tire will be indicated. ►

The tire pressures must be stored in the Infotainment system again each time the pressures change (switching between partial and full load pressure) or after changing or replacing a tire on your vehicle ⇒ *page 184*. The tire pressure monitoring system only monitors the tire pressure you have stored. Refer to the tire pressure label for the recommended tire pressure for your vehicle ⇒ *page 176, fig. 147*.

Tire tread circumference and vibration characteristics can change and cause a tire pressure warning if:

- the tire pressure in one or more tires is too low
- the tire has structural damage
- the tire was replaced or the tire pressure was changed and it was not stored ⇒ *page 184*
- the spare tire\* is installed

### Indicator lights

 - Loss of pressure in at least one tire ⇒ . Check the tires and replace or repair if necessary. Check/correct the pressures of all four tires and store the pressure again in the menu display ⇒ *page 184*.

**TPMS** (Tire Pressure Monitoring System) **Tire pressure: System malfunction!** If **TPMS** appears after switching the ignition on or while driving and the  indicator light in the instrument cluster blinks for approximately one minute and then stays on, there is system malfunction. Try to store the correct tire pressures ⇒ *page 184*. If the indicator light does turn off or turns on again after a short period of time, drive to an authorized Audi dealer or authorized Audi Service Facility immediately to have the malfunction corrected.

### WARNING

- If the tire pressure indicator appears in the display, reduce your speed immediately and avoid any hard steering or braking maneuvers. Stop as soon as possible and check the tires and their pressure.
- The driver is responsible for maintaining the correct tire pressure. You must check the tire pressure regularly.

- Under certain conditions (such as a sporty driving style, winter conditions or unpaved roads), the tire pressure monitoring system indicator may be delayed.
- Do not use run-flat tires on your vehicle. Using them when not permitted can lead to vehicle damage or accidents.

### Tips

- The tire pressure monitoring system can also stop working when there is an ESC malfunction.
- Using snow chains may result in a system malfunction.
- The tire pressure monitoring system in your Audi was calibrated with “Audi Original Tires” ⇒ *page 173*. Using these tires is recommended.

### Storing tire pressures

Applies to: vehicles with Tire Pressure Monitoring System indicator

- ▶ Make sure before storing that the tire pressures of all four tires meet the specified values and are adapted to the load ⇒ *page 175*.
- ▶ Switch the ignition on.
- ▶ Select: the **CAR** function button > **(Car) Systems\*** control button > **Servicing & checks** > **Tire pressure monitoring** > **Store tire pressures** > **Yes, store now**.

### Tips

Do not store the tire pressures if snow chains are installed.

## Care and cleaning

### General information

Regular, proper care helps to maintain your vehicle's value. It can also be a requirement when submitting warranty claims for corrosion damage and paint defects on the body.

The necessary care products can be obtained from an authorized Audi dealer or authorized Audi Service Facility. Read and follow the instructions for use on the packaging.

#### **WARNING**

- Using cleaning and care products incorrectly can be dangerous to your health.
- Always store cleaning and care products out of reach of children to reduce the risk of poisoning.

#### **For the sake of the environment**

- Preferably purchase environmentally-friendly cleaning products.
- Do not dispose of leftover cleaning and care products with household trash.

### Car washes

The longer that deposits remain on the vehicle, the more the surface may be damaged. High temperatures such as those caused by sunlight increase the damaging effect.

Before washing, rinse off heavy deposits with plenty of water.

Stubborn deposits such as bird droppings or tree sap are best removed with plenty of water and a microfiber cloth.

Also, wash the underside of your vehicle once road salt stops being used for the season.

#### Pressure washers

When washing your vehicle with a pressure washer, always follow the operating instructions provided with the pressure washer. This is especially important in regard to the pressure and spraying distance. Do not aim the spray directly at seals on side windows, doors, the hood, the luggage com-

partment lid or the panorama glass roof\* or at tires, rubber hoses, insulating material, sensors\* or camera lenses\*. Keep a distance of at least 16 in (40 cm).

Do not remove snow and ice with a pressure washer.

Never use cone nozzles or high pressure nozzles.

The water temperature must not be above 140 °F (60 °C).

#### Automatic car washes

Spray off the vehicle before washing.

Make sure that the windows and roof\* are closed and the windshield wipers are off. Follow instructions from the car wash operator, especially if there are accessories attached to your vehicle.

If possible, use car washes that do not have brushes.

#### Washing by hand

Clean the vehicle starting from the top and working down using a soft sponge or cleaning brush. Use solvent-free cleaning products.

#### Washing vehicles with matte finish paint by hand

To avoid damaging the paint when washing, first remove dust and large particles from your vehicle. Insects, grease spots and fingerprints are best removed with a special cleaner for matte finish paint.

Apply the product using a microfiber cloth. To avoid damaging the paint surface, do not use too much pressure.

Rinse the vehicle thoroughly with water. Then clean using a neutral shampoo and a soft microfiber cloth.

Rinse the vehicle thoroughly again and let it air dry. Remove any water residue using a chamois.

#### **WARNING**

- Only wash the vehicle when the ignition is off and follow the instructions from the car

wash operator to reduce the risk of accidents.

- To reduce the risk of cuts, protect yourself from sharp metal components when washing the underbody or the inside of the wheel housings.
- After washing the vehicle, the braking effect may be delayed due to moisture on the brake rotors or ice in the winter. This increases the risk of an accident. The brakes must be dried first with a few careful brake applications.

- To reduce the risk of damage to the surface, do not use insect removing sponges, kitchen sponges or similar items.
- Matte finish painted vehicle components:
  - To reduce the risk of damage to the surface, do not use polishing agents or hard wax.
  - Never use protective wax. It can destroy the matte finish effect.
  - Do not place any stickers or magnetic signs on vehicle parts painted with matte finish paint. The paint could be damaged when the stickers or magnets are removed.

### Note

- If you wash the vehicle in an automatic car wash, you must fold the exterior mirrors in to reduce the risk of damage to the mirrors. Power folding exterior mirrors\* must only be folded in and out using the power folding function.
- To reduce the risk of paint damage, do not wash the vehicle in direct sunlight.

### For the sake of the environment

Only wash the vehicle in facilities specially designed for that purpose. This will reduce the risk of dirty water contaminated with oil from entering the sewer system.

## Cleaning and care information

When cleaning and caring for individual vehicle components, refer to the following tables. The information contained there is simply recommendations. For questions or for components

that are not listed, consult an authorized Audi dealer or authorized Audi Service Facility. Also follow the information found in ⇒ .

### Exterior cleaning

Component	Situation	Solution
<b>Windshield wiper blades</b>	Deposits	⇒ page 39, <i>Cleaning the wiper blades</i>
<b>Headlights/ Tail lights</b>	Deposits	Soft sponge with a mild soap solution <sup>a)</sup>
<b>Sensors/ Camera lenses</b>	Deposits	Sensors: soft cloth with solvent-free cleaning solution Camera lenses: soft cloth with alcohol-free cleaning solution
	Snow/ice	Hand brush/solvent-free de-icing spray
<b>Wheels</b>	Road salt	Water
	Brake dust	Acid-free special cleaning solution
<b>Exhaust tail pipes</b>	Road salt	Water, cleaning solution suitable for stainless steel, if necessary
<b>Decorative parts/ Trim</b>	Deposits	Mild soap solution <sup>a)</sup> , a cleaning solution suitable for stainless steel, if necessary

Component	Situation	Solution
<b>Paint</b>	Paint damage	Refer to the paint number on the vehicle data label, repair with touch up paint ⇒ <i>page 209</i>
	Spilled fuel	Rinse with water immediately
	Surface rust	Rust remover, then protect with hard wax; for questions, consult an authorized Audi dealer or authorized Audi Service Facility.
	Corrosion	Have it removed by an authorized Audi dealer or authorized Audi Service Facility.
	Water no longer beads on the surface of clean paint	Protect with hard wax (at least twice per year)
	No shine even though paint has been protected/paint looks poor	Treat with suitable polish; then apply paint protectant if the polish that was used does not contain any protectant
	Deposits such as insects, bird droppings, tree sap and road salt	Dampen with water immediately and remove with a micro-fiber cloth
Grease-based contaminants such as cosmetics or sunblock	Remove immediately with a mild soap solution <sup>a)</sup> and a soft cloth	
<b>Carbon parts</b>	Deposits	clean the same way as painted parts ⇒ <i>page 185</i>

<sup>a)</sup> Mild soap solution: maximum two tablespoons of neutral soap in 1 quart (1 liter) of water

### Interior cleaning

Component	Situation	Solution
<b>Windows</b>	Deposits	Glass cleaner, then wipe dry
<b>Decorative parts/Trim</b>	Deposits	Mild soap solution <sup>a)</sup>
<b>Plastic parts</b>	Deposits	Damp cloth
	Heavier deposits	Mild soap solution <sup>a)</sup> , detergent-free plastic cleaning solution, if necessary
<b>Displays/instrument cluster</b>	Deposits	Soft cloth with LCD cleaner
<b>Controls</b>	Deposits	Soft brush, then a soft cloth with a mild soap solution <sup>a)</sup>
<b>Safety belts</b>	Deposits	Mild soap solution <sup>a)</sup> , allow to dry before letting them retract

## Care and cleaning

Component	Situation	Solution
<b>Textiles artificial leather, Alcantara</b>	Deposits adhering to the surface	Vacuum cleaner
	Water-based deposits such as coffee, tea, blood, etc.	Absorbent cloth and mild soap solution <sup>a)</sup>
	Oil-based deposits such as oil, make-up, etc.	Apply a mild soap solution <sup>a)</sup> , blot away the dissolved oil or dye, treat afterward with water, if necessary
	Special deposits such as ink, nail polish, latex paint, shoe polish, etc.	Special stain remover, blot with absorbent material, treat afterward with mild soap solution, if necessary <sup>a)</sup>
<b>Natural leather</b>	Fresh stains	Cotton cloth with a mild soap solution <sup>a)</sup>
	Water-based deposits such as coffee, tea, blood, etc.	Fresh stains: absorbent cloth dried stains: stain remover suitable for leather
	Oil-based deposits such as oil, make-up, etc.	Fresh stains: absorbent cloth and stain remover suitable for leather dried stains: oil cleaning spray
	Special deposits such as ink, nail polish, latex paint, shoe polish, etc.	Spot remover suitable for leather
	Care	Regularly apply conditioning cream that protects from light and penetrates into the material. Use specially-colored conditioning cream, if necessary.
<b>Carbon parts</b>	Deposits	clean the same way as plastic parts

<sup>a)</sup> Mild soap solution: maximum two tablespoons of neutral soap in 1 quart (1 liter) of water

### **WARNING**

The windshield may not be treated with water-repelling windshield coating agents. Unfavorable conditions such as wetness, darkness, or low sun can result in increased glare. Wiper blade chatter is also possible.

### **Note**

- **Headlights/tail lights**
  - Never clean headlights or tail lights with a dry cloth or sponge.
  - Do not use any cleaning product that contains alcohol, because they could cause cracks to form.
- **Wheels**

- Never use any paint polish or other abrasive materials.
- Damage to the protective layer on the rims such as stone chips or scratches must be repaired immediately.
- **Sensors/camera lenses**
  - Never use warm or hot water to remove snow or ice from the camera lens. This could cause the lens to crack.
  - Never use abrasive cleaning materials or alcohol to clean the camera lens. This could cause scratches and cracks.
- **Door windows**
  - Remove snow and ice on windows and exterior mirrors with a plastic scraper. To

avoid scratches, move the scraper only in one direction and not back and forth.

- Never remove snow or ice from door windows and mirrors using warm or hot water because this could cause cracks to form.
- To avoid damage to the rear window defogger, do not apply any stickers on the heating wires on the inside of the window.

#### – **Decorative parts/trim**

- Never use chrome care or cleaning products.

#### – **Paint**

- To reduce the risk of scratches, the vehicle must be free of dirt and dust before polishing or waxing.
- To prevent paint damage, do not polish or wax the vehicle in direct sunlight.
- To reduce the risk of paint damage, do not polish away rust spots.
- Remove cosmetics and sunscreen immediately - these could damage the paint.

#### – **Displays/instrument cluster**

- The displays/instrument cluster and the trim surrounding them must not be cleaned with dry cleaning methods because they could be scratched.
- Make sure that the instrument cluster is switched off and has cooled off before cleaning it.
- Make sure no fluids enter the spaces between the instrument cluster and the trim, because that could cause damage.

#### – **Controls**

- Make sure that no fluids enter the controls, because this could cause damage.

#### – **Safety belts**

- Do not remove the safety belts to clean them.
- Never clean safety belts or their components chemically or with corrosive fluids or solvents and never allow sharp objects to come into contact with the safety belts. This could cause damage to the belt webbing.
- If there is damage to the webbing, the connections, the retractors or the buckles,

have them replaced by an authorized Audi dealer or authorized Audi Service Facility.

#### – **Textiles/artificial leather/Alcantara**

- Never treat artificial leather/Alcantara with leather care products, solvents, floor polish, shoe polish, spot remove or similar products.
- Have a specialist remove stubborn stains to prevent damage.
- Never use steam cleaners, brushes, hard sponges, etc. when cleaning.
- Do not turn on the seat heating\* to dry the seat.
- Objects with sharp edges, such as zippers or rivets on clothing or belts, can cause damage to the surface.
- Open hook and loop fasteners, for example on clothing, can damage seat covers. Make sure hook and loop fasteners are closed.

#### – **Natural leather**

- Never treat leather with solvents, floor polish, shoe polish, spot remover or similar products.
- Objects with sharp edges, such as zippers or rivets on clothing or belts, can cause damage to the surface.
- Never use steam cleaners, brushes, hard sponges, etc. when cleaning.
- Do not turn on the seat heating\* to dry the seat.
- To help prevent the leather from fading, do not leave the vehicle in direct sunlight for long periods of time. If leaving the vehicle parked for long periods of time, you should cover the leather to protect it from direct sunlight.

#### **Tips**

- Insects are easier to remove from paint that has been freshly waxed.
- Regular waxing can prevent rust spots from forming.

## Placing your vehicle out of service

If you would like to take your vehicle out of service for a longer period of time, contact an authorized Audi dealer or authorized Audi Service Facility. They will advise you of important measures, such as corrosion protection, service and storage procedures. Also follow the information about the vehicle battery ⇒ *page 163*.



## Emergency assistance

### General information

- ▶ Park the vehicle as far as possible from moving traffic in the event of a breakdown. In the event of a flat tire, park the vehicle on a level surface. If you are on a steep hill, be especially careful.
- ▶ Set the parking brake.
- ▶ Switch the emergency flashers on.
- ▶ Put on a reflective vest.
- ▶ Set up the warning triangle, if available.
- ▶ Have the passengers exit the vehicle. They should move to a safe place, for example behind a guard rail.

#### WARNING

Follow the steps given above. This is for your protection and the for the safety of other drivers.

### Equipment

#### Vehicle tool kit

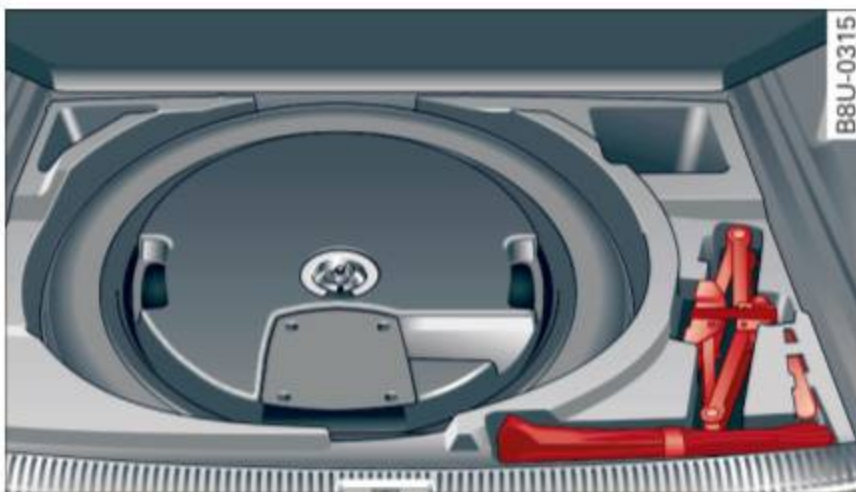

**Fig. 148** Luggage compartment: cargo floor cover folded upward

The vehicle tool kit is located in the luggage compartment under the cargo floor cover.

- ▶ Push on the plastic handle and lift up the cargo floor.
- ▶ Open the cargo floor.

Completely retract the vehicle jack arm before storing the vehicle jack\*.

#### WARNING

Applies to: vehicles with jack

Improper use of the vehicle jack can cause serious personal injuries.

- Never use the screw driver hex head to tighten wheel bolts, since the bolts cannot attain the necessary tightening torque if you use the hex head, potentially causing an accident.
- The factory-supplied jack is intended only for your vehicle model. Under no circumstances should it be used to lift heavy vehicles or other loads; you risk injuring yourself.
- Never start the engine when the vehicle is raised, which could cause an accident.
- Support the vehicle securely with appropriate stands if work is to be performed underneath the vehicle; otherwise, there is a potential risk for injury.
- Never use the jack supplied with your Audi on another vehicle, particularly on a heavier one. The jack is only suitable for use on the vehicle it came with.

#### Tips

The vehicle jack\* in your vehicle is maintenance-free.

### Replacing wheels

#### Preparation

*You must complete the preparation before changing a tire.*

- ▶ Read and follow the important safety precautions ⇒ *page 191*.
- ▶ Set the parking brake.
- ▶ Select the P selector lever position.
- ▶ When towing a trailer: disconnect the trailer from your vehicle.
- ▶ Lay out the vehicle tool kit ⇒ *page 191* and the spare tire ⇒ *page 197*.

### WARNING

You or your passengers could be injured while changing a wheel if you do not follow these safety precautions:

- If you have a flat tire, move a safe distance off the road. Turn off the engine, turn the emergency flashers on and use other warning devices to alert other motorists.
- Make sure that passengers wait in a safe place away from the vehicle and well away from the road and traffic.
- To help prevent the vehicle from moving suddenly and possibly slipping off the jack, always fully set the parking brake and block the front and back of the wheel diagonally opposite the wheel being changed with the folding chocks or other objects. When one front wheel is lifted off the ground, placing the Automatic Transmission in “P” (Park) will *not* prevent the vehicle from moving.
- Before you change a wheel, be sure the ground is level and firm. If necessary, use a sturdy board under the jack.
- Always store the vehicle tool kit, the jack and the replaced tire in the luggage compartment ⇒ *page 102*.

### Tips

Obey all laws.

## Changing a wheel

*When you change a wheel, follow the sequence described below step-by-step and in exactly that order.*

1. Remove the **decorative wheel cover\*** or the **wheel bolt caps\***. For more details see also ⇒ *page 193*.
2. Loosen the **wheel bolts** ⇒ *page 193*.
3. Locate the proper mounting point for the jack and align the jack below that point ⇒ *page 194*.
4. **Lift** the car with the jack ⇒ *page 194*.
5. Remove the **wheel with the flat tire** and then install the **spare tire** ⇒ *page 195*.
6. Tighten all wheel bolts lightly.
7. **Lower** the vehicle with the jack.

8. Use the wheel bolt wrench and **firmly** tighten all wheel bolts in a crisscross pattern ⇒ *page 193*.
9. Replace the **decorative wheel cover\*** or the **wheel bolt caps\***.

### WARNING

Always read and follow all WARNINGS and information ⇒  in *Raising the vehicle on page 194* and ⇒ *page 196*.

## After changing a wheel

*A wheel change is not complete without the doing the following.*

- ▶ Always store the vehicle tool kit, the jack\* and the replaced tire in the luggage compartment ⇒ *page 102*.
- ▶ Check the **tire pressure** of the spare tire as soon as possible.
- ▶ As soon as possible, have the **tightening torques** on all wheel bolts checked with a torque wrench. The correct tightening torque is 105 ft lbs (140 Nm).
- ▶ Have the flat tire **replaced** as soon as possible.

### Tips

- If you notice that the wheel bolts are corroded and difficult to turn while changing a tire, they should be replaced before you check the tightening torque.
- Drive at reduced speed until you have the tightening torques checked.

### Removing the wheel covers/bolt caps



Fig. 149 Changing a wheel: removing the wheel cover



Fig. 150 Changing a wheel: removing the wheel bolt caps

#### Wheel cover\*

- ▶ Insert the **hook** provided with the vehicle tool kit in the hole in the hub ⇒ *fig. 149*.
- ▶ Pull off the **decorative wheel cover**.

#### Wheel bolt caps\*

- ▶ Push the **plastic clip** provided with the vehicle tool kit over the wheel bolt cap until it engages ⇒ *fig. 150*.
- ▶ Pull on the **plastic clip** to remove the cap.

### Loosening and tightening the wheel bolts

The wheel bolts must be loosened before raising the vehicle.



Fig. 151 Changing a wheel: loosening the wheel bolts

#### Loosening

- ▶ Install the **wheel bolt wrench** over the wheel bolt and push it down as far as it will go.
- ▶ Take tight hold of the *end* of the wrench handle and turn the wheel bolts **counter-clockwise** about *one single* turn in the direction of arrow ⇒ *fig. 151*.

#### Tightening

- ▶ Install the **wheel bolt wrench** over the wheel bolt and push it down as far as it will go.
- ▶ Take tight hold of the *end* of the wrench handle and turn each wheel bolt **clockwise** until it is seated.

#### ! WARNING

- Do not use force or hurry when changing a wheel - you can cause the vehicle to slip off the jack and cause serious personal injuries.
- *Do not* loosen the wheel bolts *more than one turn* before you raise the vehicle with the jack. - You risk an injury.

#### i Tips

- Never use the hexagonal socket in the handle of the screwdriver to loosen or tighten the wheel bolts.
- If a wheel bolt is very tight, you may find it easier to loosen by carefully pushing down on the end of the wheel bolt wrench with *one foot only*. As you do so, hold on to the car to keep your balance and take care not to slip.

### Raising the vehicle

The vehicle must be lifted with the jack first before the wheel can be removed.

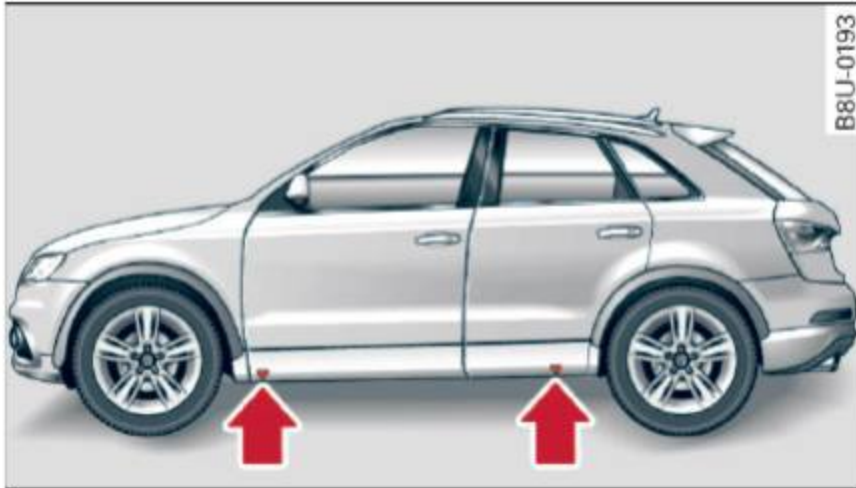

Fig. 152 Sill panels: markings

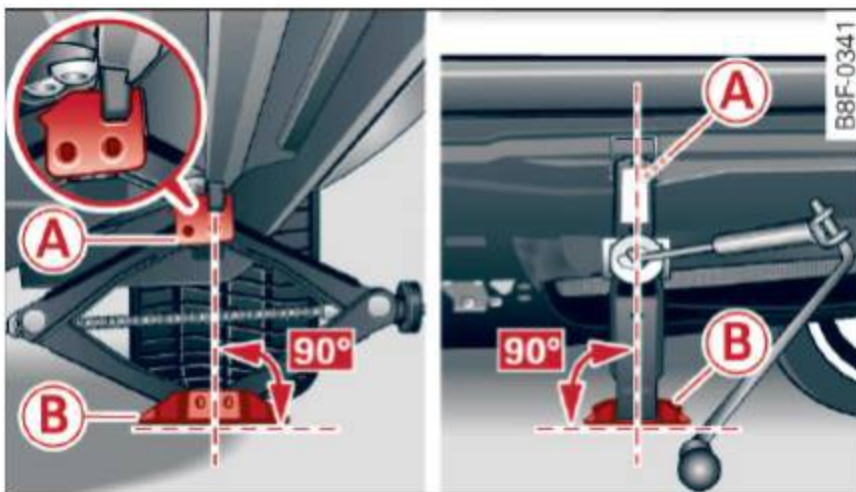

Fig. 153 Sill: positioning the vehicle jack

The location of the jack point is indicated by an indentation on the underside of the vehicle ⇒ fig. 152.

- ▶ Activate the **parking brake** to prevent the vehicle from rolling unintentionally.
- ▶ Move the selector lever to the P position.
- ▶ Find the **marking** (imprint) on the sill that is nearest the wheel that will be changed ⇒ fig. 152. Behind the marking, there is a **lifting point** on the sill for the vehicle jack.
- ▶ Turn the **vehicle jack** located under the lifting point on the sill to raise the jack until the jaw (A) ⇒ fig. 153 covers the **notch** on the vehicle ⇒ ⚠, ⇒ ⚠.
- ▶ Align the vehicle jack so the jaw (A) covers the notch and the base plate (B) is flat on the floor. The base plate (B) must be *vertical* under the lifting point (A).
- ▶ Install the rod on the vehicle jack: Insert the rod into the opening on the handwheel. Turn the rod left or right to secure it.

- ▶ Continue raising the jack with the rod until the wheel lifts off the ground slightly.

Position the vehicle jack **only** under the designated lifting points on the sill ⇒ fig. 152. There is exactly *one* location for each wheel. The jack must not be positioned at any other location ⇒ ⚠, ⇒ ⚠.

**Soft ground** under the jack can cause the vehicle to slip off the jack. Always place the jack on firm ground. Use a flat, stable support if necessary. Use a non-slip surface such as a rubber mat on a **slippery surface** such as tile.

### ⚠ WARNING

- You or your passengers could be injured while changing a wheel if you do not follow these safety precautions:
- Position the vehicle jack only at the designated lifting points and align the jack. Otherwise, the vehicle jack could slip and cause an injury if it does not have sufficient hold on the vehicle.
- Use only the jack\* supplied with your vehicle to raise the vehicle. If you use a jack from a different vehicle, your vehicle may slip off the jack - risk of injury!
- Do not use the jack\* supplied with your vehicle to raise other vehicles, as these may slip off the jack - risk of injury!
- A soft or unstable surface under the jack may cause the vehicle to slip off the jack. Always provide a firm base for the jack on the ground. If necessary, use a sturdy board under the jack.
- On hard, slippery surface (such as tiles) use a rubber mat or similar to prevent the jack from slipping.
- To help prevent injury to yourself and your passengers:
  - Do not raise the vehicle until you are sure the jack is securely engaged.
  - Passengers must not remain in the vehicle when it is jacked up.
  - Make sure that passengers wait in a safe place away from the vehicle and well away from the road and traffic.

- Make sure jack position is correct, adjust as necessary and then continue to raise the jack.
- If work has to be done under the vehicle, ensure that it is safely supported on suitable stands – risk of injury!
- Never start the engine when the vehicle is on the jack – risk of accident!

### ! Note

Do not lift the vehicle by the sill. Position the vehicle jack only at the designated lifting points on the sill. Otherwise, your vehicle will be damaged.

### Taking the wheel off/installing the spare tire

Follow these instructions step-by-step for changing the wheel.



**Fig. 154** Changing a wheel: using the hexagonal socket (with the blade removed) to turn the bolts



**Fig. 155** Changing a wheel: alignment pin inside the top hole

After you have loosened all wheel bolts and raised the vehicle off the ground, remove and replace the wheel as follows:

### Removing the wheel

- ▶ Remove the topmost wheel bolt completely with the **hexagonal socket** in the screwdriver handle (vehicle tool kit) ⇒ *fig. 154* and set it aside on a *clean* surface.
- ▶ Screw the threaded end of the **alignment pin** from the tool kit hand-tight into the empty bolt hole ⇒ *fig. 155*.
- ▶ Then remove the other wheel bolts as described above.
- ▶ Take off the wheel leaving the alignment pin in the bolt hole ⇒ !.

### Putting on the spare tire

- ▶ Push the spare tire over the alignment pin ⇒ !.
- ▶ Screw on the wheel bolts and tighten them *slightly* using the hexagonal socket.
- ▶ Remove the alignment pin and insert and tighten the remaining wheel bolt slightly like the rest.
- ▶ Turn the jack handle counter-clockwise to lower the vehicle until the jack is fully released.
- ▶ Use the wheel bolt wrench to tighten all wheel bolts firmly. Tighten them *in a crisscross pattern*, from one bolt to the (approximately) opposite one, to keep the wheel centered.
- ▶ Perform the steps required after changing the wheel ⇒ *page 192, After changing a wheel*.

### ! WARNING

Do not use the hexagonal socket in the screwdriver handle to tighten the wheel bolts. It is not possible to tighten the bolts to the required torque using the hexagonal socket – risk of accident!

### ! Note

When removing or installing the wheel, the rim could hit the brake rotor and damage the rotor. Work carefully and have a second person to help you.

### i Tips

- When mounting tires with **unidirectional tread design** make sure the tread pattern is pointed the right way ⇒ *page 196*.

- The wheel bolts should be clean and easy to turn. Check for dirt and corrosion on the mating surfaces of both the wheel and the hub. Remove all dirt from these surfaces before remounting the wheel.

### Tires with unidirectional tread design

*Tires with unidirectional tread design must be mounted with their tread pattern pointed in the right direction.*

### Using a spare tire with a tread pattern intended for use in a specific direction

When using a spare tire with a tread pattern intended for use in a specific direction, please note the following:

- The direction of rotation is marked by an **arrow on the side of the tire**.
- If the spare tire has to be installed in the incorrect direction, use the spare tire only temporarily since the tire will not be able to achieve its optimum performance characteristics with regard to aquaplaning, noise and wear.
- We recommend that you pay particular attention to this fact during wet weather and that you adjust your speed to match road conditions.
- Replace the flat tire with a new one and have it installed on your vehicle as soon as possible to restore the handling advantages of a unidirectional tire.

### Notes on wheel changing

Please read the information ⇨ *page 173, New tires or wheels* if you are going to use a spare tire which is different from the tires on your vehicle.

After you change a tire:

- **Check the tire pressure on the spare immediately after installation.**
- **Have the wheel bolt tightening torque checked with a torque wrench as soon as possible by your authorized Audi dealer or qualified workshop.**

- **With steel and alloy wheel rims, the wheel bolts are correctly tightened at a torque of 105 ft lbs (140 Nm).**
- **If you notice that the wheel bolts are corroded and difficult to turn while changing a tire, they should be replaced before you check the tightening torque.**
- **Replace the flat tire with a new one and have it installed on your vehicle as soon as possible. Remount the wheel cover.**

**Until then, drive with extra care and at reduced speeds.**

### **WARNING**

- If you are going to equip your vehicle with tires or rims which differ from those which were factory installed, then be sure to read the information ⇨ *page 173, New tires or wheels*.
- Always make sure the damaged wheel or even a flat tire and the jack and tool kit are properly secured in the luggage compartment and are not loose in the passenger compartment.
- In an accident or sudden maneuver they could fly forward, injuring anyone in the vehicle.
- Always store damaged wheel, jack and tools securely in the luggage compartment. Otherwise, in an accident or sudden maneuver they could fly forward, causing injury to passengers in the vehicle.

### **Note**

Do not use commercially available tire sealants. Otherwise, the electrical components of the tire pressure monitoring system\* will no longer work properly and the sensor for the tire pressure monitoring system\* will have to be replaced by qualified workshop.

## Spare tire

### Space-saving spare tire (compact spare tire)

Applies to: vehicles with spare tire/space-saving spare tire (compact spare tire)

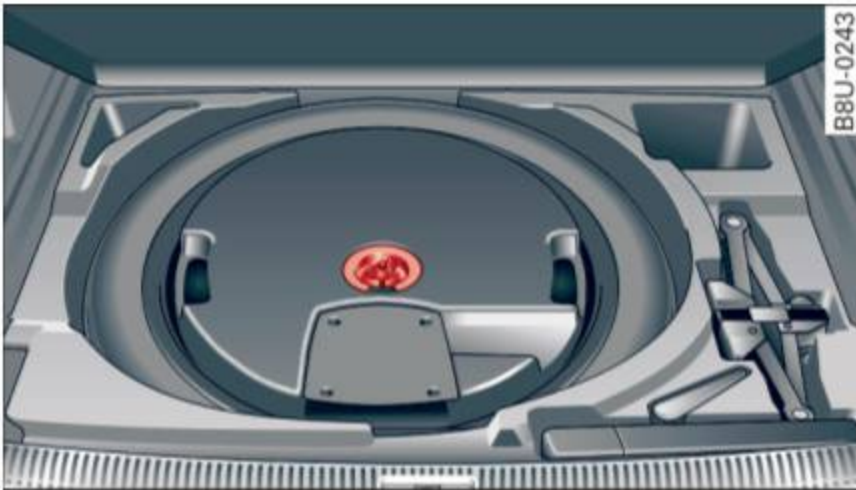

**Fig. 156** Luggage compartment: space-saving spare tire (compact spare tire)

The spare tire is intended for short-term use only. Have the damaged tire checked and replaced, if necessary, by an authorized Audi dealer or authorized Audi Service Facility as soon as possible.

There are some restrictions on the use of the compact spare tire. The compact spare tire has been designed specifically for your type of vehicle. Do not replace it with the spare tire from another type of vehicle.

### Removing the spare tire

- ▶ Remove the cargo floor.
- ▶ Remove the wing bolt ⇒ *fig. 156* and then remove the retainer underneath it.
- ▶ Remove the subwoofer\* ⇒ *page 198*.
- ▶ Remove the spare tire.

### Snow chains

For technical reasons, the use of snow chains on the compact spare tire is not permitted.

If you have to drive with snow chains and a front tire fails, mount the spare tire in place of a rear tire. Install the snow chains on the rear tire that you removed, and install that in place of the front tire that failed.

### WARNING

- Never use the spare tire if it is damaged or if it is worn down to the tread wear indicators.

- If the spare tire is more than 6 years old, use it only in an emergency and with extreme caution and careful driving.
- The spare tire is intended only for temporary and short-term use. It should be replaced as soon as possible with the normal wheel and tire.
- After mounting the compact spare tire, the tire pressure must be checked as soon as possible. The tire pressure of the compact spare tire must be 4.2 bar; otherwise, you risk having an accident.
- Do not drive faster than 50 mph (80 km/h). You risk having an accident.
- Avoid full-throttle acceleration, heavy braking, and fast cornering. You risk having an accident.
- Never drive using more than one spare wheel and tire. You risk having an accident.
- Normal summer or winter tires must not be mounted on the compact spare wheel rim.
- For technical reasons, the use of tire chains on the spare tire is not permitted. If it is necessary to drive with tire chains, the spare wheel must be mounted on the front axle in the event of a flat in a rear tire. The newly available front wheel must then be installed in place of the rear wheel with the flat tire. Installing the tire chain before mounting the wheel and tire is recommended.
- Loose items in the passenger compartment can cause serious personal injury during hard braking or in an accident. Never store the spare tire or jack and tools in the passenger compartment.

### Removing the subwoofer

Applies to: vehicles with subwoofer

*The subwoofer must be removed before the spare tire\*/temporary spare tire\* can be removed.*



Fig. 157 Spare tire well: subwoofer

### Removing the subwoofer

- ▶ Remove the cargo floor.
- ▶ Press the connector tabs ① ⇒ *fig. 157* together.
- ▶ Remove the connector ② and set the disconnected cable aside.
- ▶ Remove the wing bolt and then remove the retainer underneath it.
- ▶ Carefully remove the subwoofer.

### Installing the subwoofer

- ▶ Carefully place the subwoofer in the rim well. The word "FRONT" on the subwoofer must face forward.
- ▶ Insert the connector that was removed.
- ▶ Secure the subwoofer with the wing bolt.
- ▶ Reinsert the cargo floor.



## Fuses and bulbs

### Electrical fuses

#### Changing fuses

A fuse that has blown will have metal strips that have burned through.



Fig. 158 Driver's side of the cockpit: folding the storage compartment down



Fig. 159 Engine compartment: removing the fuse panel cover

The fuses are located in the driver's side footwell behind the storage compartment and in the engine compartment.

#### Preparations

- ▶ Switch the ignition and all electrical equipment off.
- ▶ Check the following table to see which fuse belongs to the equipment.

#### Fuses behind the storage compartment

- ▶ Open the storage compartment.
- ▶ Press the left and right retainers inward and fold the compartment all the way down ⇒ *fig. 158*.

#### Fuses in the engine compartment

- ▶ Open the hood ⇒ *page 155*.

- ▶ To release the fuse panel cover, slide both sliding retainers at the left and right forward ⇒ *fig. 159*.
- ▶ Remove the fuse panel cover.

#### Replacing fuses

The clamp is located below the fuses behind the storage compartment (driver's side).

- ▶ Fold this compartment all the way down and remove the clamp from the holder.
- ▶ Remove the colored plastic clip from the fuse panel, if necessary. You can dispose of the plastic clip.
- ▶ Remove the fuse using the clamp.
- ▶ Replace the blown fuse only with an identical new one.
- ▶ Install the cover.

#### Fuse color identification

Color	Current rating in amps
Black	1
Purple	3
Light brown	5
Brown	7.5
Red	10
Blue	15
Yellow	20
White or transparent	25
Green	30
Orange	40

#### WARNING

Do not repair fuses and never replace a blown fuse with one that has a higher amp rating. This can cause damage to the electrical system and increases the risk of fire.

#### Note



If a new fuse burns out again shortly after you have installed it, have the electrical system checked as soon as possible by an authorized Audi dealer or authorized Audi Service Facility.

### Tips

- The following table does not list fuse locations that are not used.
- Some of the equipment listed in the following tables applies only to certain model versions or certain optional equipment.

### Fuse assignment, cockpit

The fuse number is stamped into the plastic below or above each fuse.

No.	Equipment
1	LED headlight (left)
2	LED headlight (right)
5	LED headlight (left)
6	LED headlight (right)
7	Steering lock
8	Convenience access control module
9	Airbag control module, AIRBAG OFF indicator light
12	Transmission control module, selector mechanism
13	Air quality sensor for climate control system, heated window washer nozzles,  button, reverse light,  button, oil level sensor, climate control system, seat occupant detection system, seat heating, buttons in the center console, automatic dimming mirror
14	Engine control module, quattro control module, transmission control module, brake lights, electromechanical steering, Gateway control module, trailer hitch control module, ESC control module, light switch, damping control module
15	Headlight range control module, instrument illumination, headlights (left, right), diagnostic connector, crankcase housing heater, air flow sensor, socket relay, DC/DC converter
16	Parking aid
17	Parking system rearview camera
18	TV tuner
19	Engine starter control, DC/DC converter

No.	Equipment
20	ESC control module, climate/heating control, special functions interface
21	Selector mechanism power supply
22	Interior monitoring
23	 button, front interior lighting buttons, diagnostic connector, light switch, light/rain sensor, humidity sensor, emergency call system
25	Headlight power supply
26	Rear window wiper
27	Starter system
28	Infotainment system
29	Supply for the parking system rearview camera and TV tuner
30	Infotainment system
31	Infotainment system
32	Instrument cluster
33	Automatic dimming rearview mirror
36	Cigarette lighter, cockpit/luggage compartment socket
37	Cockpit/rear socket
38	Transmission control module
40	Trailer hitch control module
41	Trailer hitch control module
42	Trailer hitch control module
44	Rear window defogger
45	Electromechanical parking brake control module
46	Trailer hitch control module
47	quattro control module
48	Automatic luggage compartment lid control module
50	Blower
51	Electromechanical parking brake control module
52	BCM
53	Front seat heating
54	Panorama glass roof
55	Sunshade on the panorama glass roof
56	Control module for suspension control

## Engine compartment fuse assignment

The fuse number is stamped into the plastic below or above each fuse.

No.	Equipment
1	Transmission supply
2	ESC
3	Horn
4	DC/DC converter
5	BCM, battery data module
6	BCM (right)
7	Washer fluid pump
8	BCM (left)
9	Seat adjustment lumbar support
10	Glow time control module, fuel pump, heated oxygen sensor
11	Steering column lever, multifunction steering wheel controls
12	Cell phone adapter
13	Engine control module
14	Engine control module
15	Gateway
16	Heated oxygen sensor, fuel pump, engine components
17	Engine components
18	Fuel pump control module
19	Sound amplifier, DC/DC converter
20	Clutch pedal sensor, brake light sensor
22	Windshield wipers
23	Radiator fan, engine components, coolant recirculation pump, auxiliary heater, fuel pump relay coils
24	Ignition coils
25	Driver's door control module (central locking, window regulators)
26	Front passenger's door control module (central locking, window regulators)
27	Terminal 15 supply
29	Power seat adjustment (driver, front passenger)
30	ESC

## Bulbs

### Replacing light bulbs

*For your safety, we recommend that you have your authorized Audi dealer replace any bulbs for you.*

It is becoming increasingly more and more difficult to replace vehicle light bulbs since in many cases, other parts of the car must first be removed before you are able to get to the bulb. This applies especially to the light bulbs in the front of your car which you can only reach through the engine compartment.

Sheet metal and bulb holders can have sharp edges that can cause serious cuts, parts must be correctly taken apart and then properly put back together to help prevent breakage of parts and long term damage from water that can enter housings that have not been properly resealed.

For your safety, we recommend that you have your authorized Audi dealer replace any bulbs for you, since your dealer has the proper tools, the correct bulbs and the expertise.

### Gas discharge lamps (Xenon lights):

Due to the high electrical voltage, have the bulbs replaced by a qualified technician. Headlights with Xenon light are identified by the high voltage sticker.

LED headlights\* require no maintenance. Please contact your authorized Audi dealer if a bulb needs to be replaced.

### WARNING

Changing Xenon lamps without the necessary equipment can cause serious personal injury.

- Bulbs are pressurized and can explode when being changed. Potential risk of injury!
- On vehicles equipped with gas discharge bulbs (Xenon light) life-threatening injuries can result from improper handling of the high-voltage portions of such lamps!
- Only your authorized Audi dealer or qualified workshop should change the bulbs in gas discharge lamps. There are parts with sharp edges on the openings and on the

bulb holders that can cause serious cuts. If you are uncertain about what to do, have the work performed by an authorized Audi dealer or qualified workshop. Serious personal injury may result from improperly performed work.

### Tips

- If you still prefer to replace the light bulbs yourself, be aware that the engine compartment is a hazardous area to work in ⇒  *in Working in the engine compartment on page 155.*
- It is best to ask your authorized Audi dealer whenever you want to change a bulb.

## Emergency situations

### General

This chapter is intended for trained emergency crews and working personnel who have the necessary tools and equipment to perform these operations.

### Starting by pushing or towing

#### Note

Vehicles with an automatic transmission cannot be started by pushing or towing.

### Starting with jumper cables

*If necessary, the engine can be started by connecting it to the battery of another vehicle.*

If the engine should fail to start because of a discharged or weak battery, the battery can be connected to the battery of *another* vehicle, using a **pair of jumper cables** to start the engine.

#### Jumper cables

Use *only* jumper cables of sufficiently large **cross section** to carry the starter current safely. Refer to the manufacturer's specifications.

Use only jumper cables with *insulated* terminal clamps which are distinctly marked:

**plus (+) cable** in most cases colored **red**

**minus (-) cable** in most cases colored **black**.

#### WARNING

Batteries contain electricity, acid, and gas. Any of these can cause very serious or fatal injury. Follow the instructions below for safe handling of your vehicle's battery.

- Always shield your eyes and avoid leaning over the battery whenever possible.
- A dead battery can freeze at temperatures around 32 °F (0 °C). If the vehicle battery is frozen, you must thaw it before connecting the jump start cables. If you do not, this in-

creases the risk of an explosion and chemical burns. After jump starting the vehicle, drive to an authorized Audi dealer or authorized Audi Service Facility immediately to have the vehicle battery checked.

- Do not allow battery acid to contact eyes or skin. Flush any contacted area with water immediately.
- Improper use of a booster battery to start a vehicle may cause an explosion.
- Vehicle batteries generate explosive gases. Keep sparks, flame and lighted cigarettes away from batteries.
- Do not try to jump start any vehicle with a low acid level in the battery.
- The voltage of the booster battery must also have a 12-Volt rating. The capacity (Ah) of the booster battery should not be lower than that of the discharged battery. Use of batteries of different voltage or substantially different "Ah" rating may cause an explosion and personal injury.
- Never charge a frozen battery. Gas trapped in the ice may cause an explosion.
- Never charge or use a battery that has been frozen. The battery case may have be weakened.
- Use of batteries of different voltage or substantially different capacity (Ah) rating may cause an explosion and injury. The capacity (Ah) of the booster battery should not be lower than that of the discharged battery.
- Before you check anything in the engine compartment, always read and heed all WARNINGS ⇨ page 155.

#### Note

- Applying a higher voltage booster battery will cause expensive damage to sensitive electronic components, such as control units, relays, radio, etc.
- There must be no electrical contact between the vehicles as otherwise current could already start to flow as soon as the positive (+) terminals are connected.

### **i** Tips

The discharged battery must be properly connected to the vehicle's electrical system. When jump starting or charging the battery, never connect the negative ground cable to the battery negative post because the battery manager system must be able to detect the battery's state of charge. Always connect the negative ground cable to the negative ground post of the battery manager control unit.

## Use of jumper cables

Make sure to connect the jumper cable clamps in exactly the order described below!



Fig. 160 Engine compartment: Connectors for jumper cables and charger

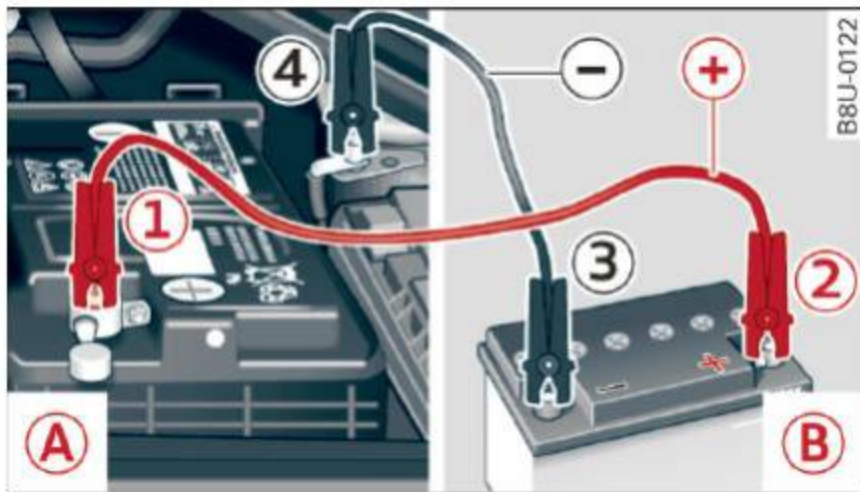

Fig. 161 Jump starting with the battery of another vehicle: **A** discharged vehicle battery, **B** booster battery

The procedure described below for connecting jumper cables is intended to provide a jump start for your vehicle.

### Vehicle with discharged battery:

- ▶ Turn off lights and accessories, move lever of automatic transmission to N (Neutral) or P (Park) and set parking brake.

### Connect POSITIVE (+) to POSITIVE (+) (red)

- ▶ To access the positive terminal, remove the battery cover ⇒ fig. 160.
1. Connect one end of the red positive cable on the **jump start bolt 1** ⇒ fig. 161 (Bolt under cover = “positive”) of the vehicle to be started **A**.
  2. Connect the other end to the positive terminal **2** of the booster battery **B**.

### Connect NEGATIVE (-) to NEGATIVE (-) (black)

3. Connect one end of the black negative cable to the negative terminal **3** of the booster battery **B**.
4. Connect the other end to the **jump start bolt 4** (Bolt with hex head = “negative”) of the vehicle to be started **A**.

### Starting the engine

- ▶ Start the engine of the vehicle with the booster battery **B**. Run the engine at a moderate speed.
- ▶ Start engine with discharged vehicle battery **A** in the usual manner.
- ▶ If the engine fails to start: do not keep the starter cranking for longer than 10 seconds. Wait for about 30 seconds and then try again.
- ▶ With engine running, remove jumper cables from both vehicles in the exact *reverse* order.
- ▶ Fit the cover back onto the battery.

The battery is vented to the outside to prevent gases from entering the vehicle interior. Make sure that the jumper clamps are well connected with their *metal parts in full contact* with the battery terminals.

### **!** WARNING

To avoid serious personal injury and damage to the vehicle, heed all warnings and instructions of the jumper cable manufacturer. If in doubt, call for road service.

- Jumper cables must be long enough so that the vehicles do not touch.
- When connecting jumper cables, make sure that they cannot get caught in any moving parts in the engine compartment.

- Do not bend over the batteries - danger of chemical burns!
- The battery cell locking screws must be tightened securely.
- Before you check anything in the engine compartment, always read and heed all WARNINGS ⇨ page 155.

### ! Note

Improper hook-up of jumper cables can ruin the generator.

- Always connect POSITIVE (+) to POSITIVE (+), and NEGATIVE (-) to NEGATIVE (-) ground post of the battery manager control unit.
- Check that all screw plugs on the battery cells are screwed in firmly. If not, tighten plugs prior to connecting clamp on negative battery terminal.
- Please note that the procedure for connecting a jumper cable as described above applies specifically to the case of your vehicle being jump started. When you are giving a jump start to another vehicle, do *not* connect the negative (-) cable to the negative (-) terminal on the discharged battery ④ ⇨ fig. 161. Instead, securely connect the negative (-) cable to either a solid metal component that is firmly bolted to the engine block or to the engine block itself. If the battery that is being charged does not vent to the outside, escaping battery gas could ignite and explode!

## Towing with a tow truck

### General hints

Your Audi requires special handling for towing.

The following information is to be used by commercial tow truck operators who know how to operate their equipment safely.

- **Never tow your Audi, towing will cause damage to the engine and transmission.**
- **Never wrap the safety chains or winch cables around the brake lines.**

- **To prevent unnecessary damage, your Audi must be transported with a flat bed truck.**
- **To load the vehicle on to the flat bed, use the towing loop found in the vehicle tools and attach to the front or rear anchorage**  
⇨ page 205 and ⇨ page 206.

### ! WARNING

A vehicle being towed is not safe for passengers. Never allow anyone to ride in a vehicle being towed, for any reason.

### Front towing loop

Only install the front towing loop when it is needed.

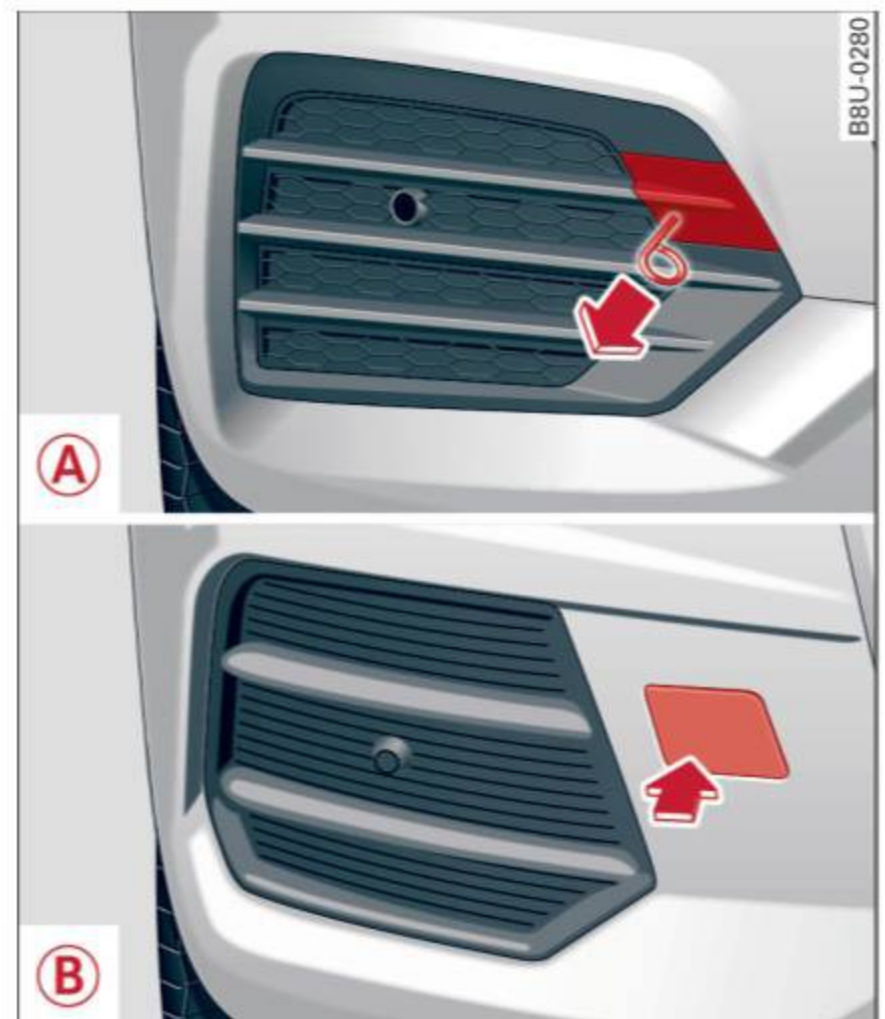

Fig. 162 Front bumper on the right side: remove the cover



Fig. 163 Front bumper on the right side: screw in the towing loop

## Emergency situations

The threaded opening for the towing loop is located behind a cover on the right side of the front bumper. Depending on the version, the cover can be removed in different ways ⇒ *fig. 162*.

- ▶ Version **(A)**: remove the towing loop and the hook from the vehicle tool kit ⇒ *page 191*. Or
- ▶ Version **(B)**: remove the towing loop from the vehicle tool kit ⇒ *page 191*.
- ▶ Version **(A)**: insert the hook into the hole on the cover and carefully pull off the cover in the direction of the arrow ⇒ *fig. 162*. Or
- ▶ Version **(B)**: press the cap inward with brief, forceful pressure ⇒ *fig. 162*. The cap will loosen from the bumper.
- ▶ Tighten the towing loop in the threaded opening until it stops ⇒ *fig. 163* and then tighten it with a wheel wrench.
- ▶ After using, place the towing loop back in the vehicle tool kit.

### **WARNING**

If the towing loop is not tightened until it stops when installing, the threads may be pulled out when towing the vehicle and that could cause an accident.

### Rear towing loop



Fig. 164 Rear bumper: cover



Fig. 165 Rear bumper: installing the towing loop

### Vehicles with a towing loop

On vehicles without a factory-installed trailer hitch\*, the rear towing loop is located on the right side of the bumper.

- ▶ Remove the towing loop from the vehicle tool kit ⇒ *page 191*.
- ▶ Press the cap inward with brief, forceful pressure ⇒ *fig. 164*. The cap will loosen from the bumper.
- ▶ Tighten the towing loop in the threaded opening until it stops ⇒ *fig. 165* and then tighten it with a wheel wrench.
- ▶ After using, place the towing loop back in the vehicle tool kit.

### Vehicles with a trailer hitch\*

- ▶ Tilt the trailer hitch out.
- ▶ Attach the towing bar or the towing cable to the trailer hitch.

### **WARNING**

If the towing loop is not tightened until it stops when installing, the threads may be pulled out when towing the vehicle and that could cause an accident.

### **WARNING**

Applies to: vehicles with trailer hitch

- Only use a special towing bar to prevent damaging the ball hitch. These towing bars have been specially designed for trailer towing hitches.
- Only use special towing cables.



## Loading the vehicle onto a flat bed truck



Fig. 166 Vehicle on flat bed truck

### Front hook up

- ▶ Align the vehicle with the centerline of the car carrier ramp.
- ▶ Attach the winch hook to the front towline eye previously installed.

### Rear hook up

- ▶ Align the vehicle with the centerline of the car carrier ramp.
- ▶ Attach the winch hook to the rear towline eye previously installed.

### Tips

Check carefully to make sure the hook-up is secure before moving the car up the flatbed truck ramp.

## Raising the vehicle

### Lifting with workshop hoist and with floor jack

The vehicle may only be lifted at the lifting points illustrated.

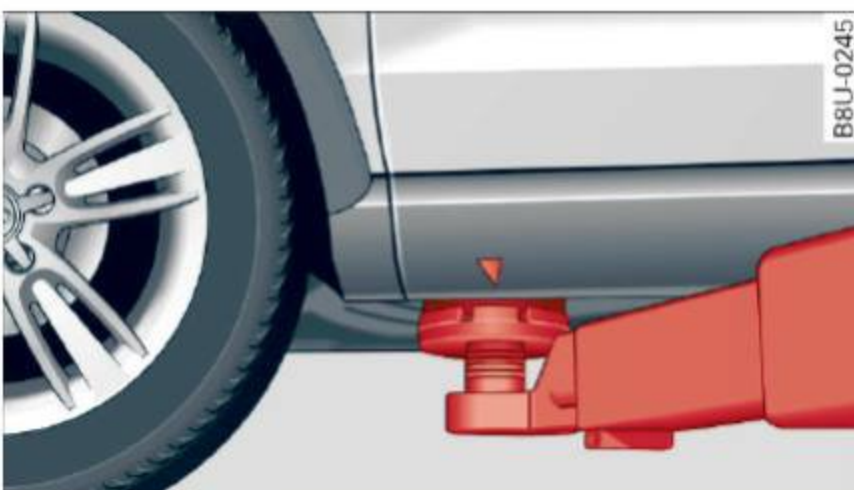

Fig. 167 Front lifting point

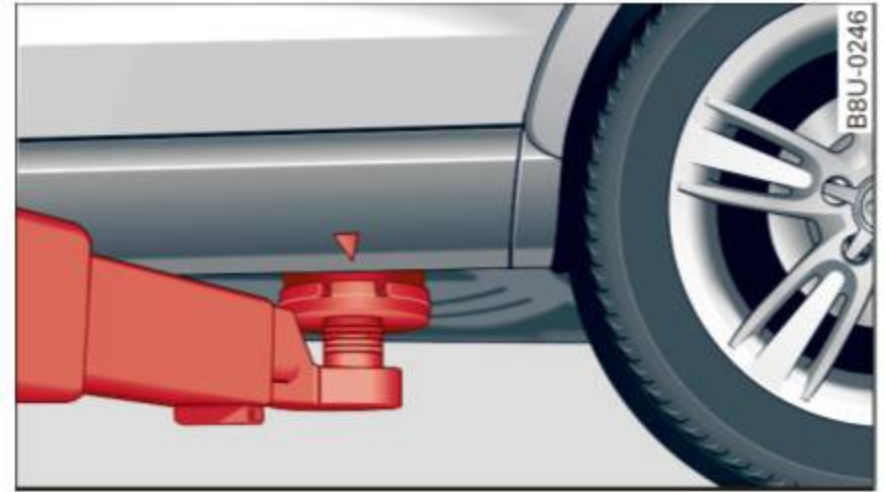



Fig. 168 Rear lifting point

- ▶ Read and heed WARNING .
- ▶ Locate lifting points  $\Rightarrow$  fig. 167 and  $\Rightarrow$  fig. 168.
- ▶ Adjust lifting arms of workshop hoist or floor jack to match vehicle lifting points.
- ▶ Insert a rubber pad between the floor jack/workshop hoist and the lifting points.

**If you must lift your vehicle with a floor jack to work underneath, be sure the vehicle is safely supported on stands intended for this purpose.**

### Front lifting point

The lifting point is located on the floor pan reinforcement about at the same level as the jack mounting point  $\Rightarrow$  fig. 167. **Do not lift the vehicle at the vertical sill reinforcement.**

### Rear lifting point

The lifting point is located on the vertical reinforcement of the lower sill for the onboard jack  $\Rightarrow$  fig. 168.

### Lifting with vehicle jack

Refer to  $\Rightarrow$  page 194.

### WARNING

- To reduce the risk of serious injury and vehicle damage.
- Always lift the vehicle only at the special workshop hoist and floor jack lift points illustrated  $\Rightarrow$  fig. 167 and  $\Rightarrow$  fig. 168.
- Failure to lift the vehicle at these points could cause the vehicle to tilt or fall from a lift if there is a change in vehicle weight

distribution and balance. This might happen, for example, when heavy components such as the engine block or transmission are removed.

- When removing heavy components like these, anchor vehicle to hoist or add corresponding weights to maintain the center of gravity. Otherwise, the vehicle might tilt or slip off the hoist, causing serious personal injury.

### Note

- Be aware of the following points before lifting the vehicle:
  - **The vehicle should never be lifted or jacked up from underneath the engine oil pan, the transmission housing, the front or rear axle or the body side members. This could lead to serious damage.**
  - **To avoid damage to the underbody or chassis frame, a rubber pad must be inserted between the floor jack and the lift points.**
  - **Before driving over a workshop hoist, check that the vehicle weight does not exceed the permissible lifting capacity of the hoist.**
  - **Before driving over a workshop hoist, ensure that there is sufficient clearance between the hoist and low parts of the vehicle.**

## Technical data

### Vehicle specifications

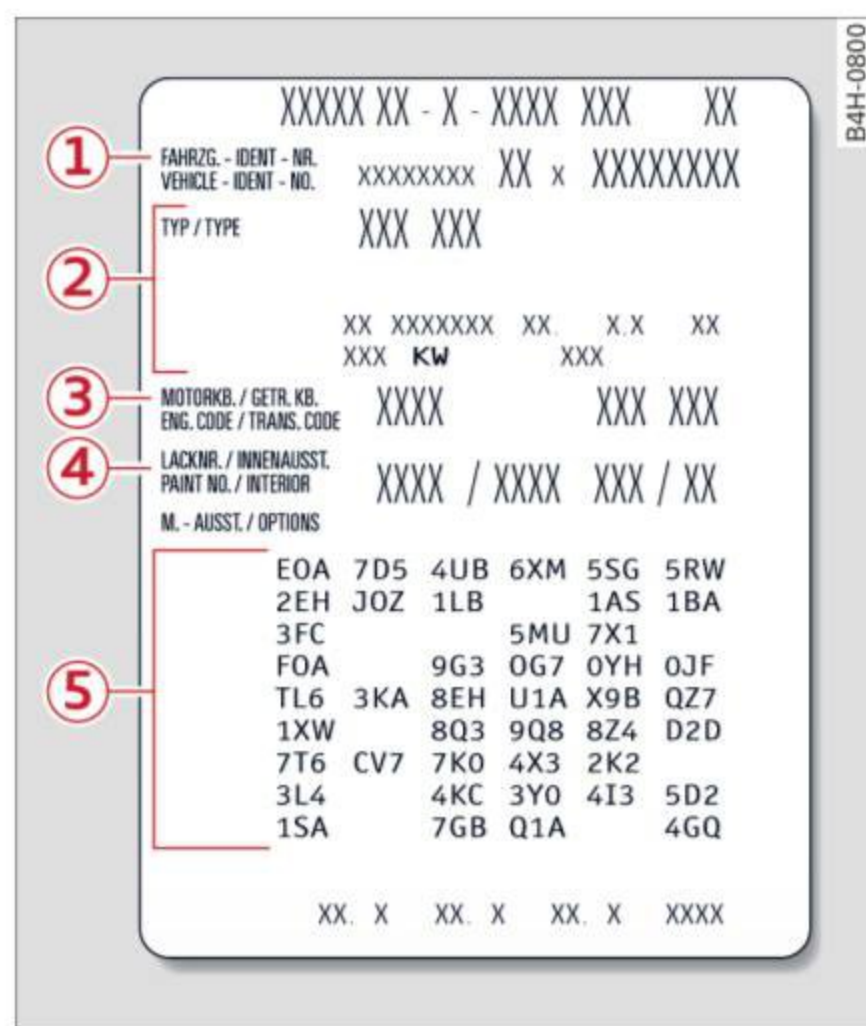

Fig. 169 Vehicle identification label

#### Vehicle Identification Number (VIN)

The VIN number is located in the following places:

- In the Infotainment system: select: the **CAR** function button > **(Car)\* systems** control button > **Servicing & checks** > **VIN number**.
- under the windshield on the driver's side\*
- on the vehicle identification label

#### Vehicle identification label

The vehicle identification label ⇨ *fig. 169* is located in the luggage compartment under the cargo floor cover.

The information of the vehicle identification label can also be found in your Warranty & Maintenance booklet.

The sticker contains the following vehicle data:

- ① Vehicle Identification Number (VIN)
- ② Vehicle type, engine output, transmission
- ③ Engine and transmission codes
- ④ Paint and interior codes

- ⑤ Optional equipment numbers

#### Safety compliance sticker

The safety compliance sticker is your assurance that your new vehicle complies with all applicable Federal Motor Vehicle Safety Standards which were in effect at the time the vehicle was manufactured. You can find this sticker on the door jamb on the driver's side. It shows the month and year of production and the vehicle identification number of your vehicle (perforation) as well as the Gross Vehicle Weight Rating (GVWR) and the Gross Axle Weight Rating (GAWR).

#### High voltage warning label

The high voltage warning label is located in the engine compartment next to the engine hood release. The spark ignition system complies with the Canadian standard ICES-002.

### Notes about technical data

The values may vary based on special equipment as well as market-specific equipment and measuring methods.

Please note that the specifications listed in the vehicle documentation always take precedence.

#### **i** Tips

Missing technical data was not available at the time of printing.

### Weights

#### Gross Vehicle Weight Rating

The Gross Vehicle Weight Rating (GVWR), and the Gross Axle Weight Rating (GAWR) for front and rear are listed on a sticker on the door jamb on the driver's side.

The Gross Vehicle Weight Rating includes the weight of the basic vehicle plus full fuel tank, oil and coolant, plus maximum load, which includes passenger weight (150 lbs/68 kg per designated seating position) and luggage weight ⇨ ⚠.

## Technical data

### Gross Axle Weight Rating

The Gross Axle Weight Rating is the maximum load that can be applied at each axle of the vehicle ⇒ ⚠.

### Vehicle capacity weight

The vehicle capacity weight (max. load) is listed on the driver's side B-pillar.

#### **WARNING**

- The actual Gross Axle Weight Rating at the front and rear axles should not exceed the permissible weights, and their combination must not exceed the Gross Vehicle Weight Rating.

- Exceeding permissible weight ratings can result in vehicle damage, accidents and personal injury.

#### **Note**

- The vehicle capacity weight figures apply when the load is distributed evenly in the vehicle (passengers and luggage). When transporting a heavy load in the luggage compartment, carry the load as near to the rear axle as possible so that the vehicle's handling is not impaired.
- Do not exceed the maximum permissible axle loads or the maximum gross vehicle weight. Always remember that the vehicle's handling will be affected by the extra load. Therefore, adjust your speed accordingly.
- Always observe local regulations.

## Dimensions

	Length (in (mm))	Width (in (mm))	Width across the mirrors (in (mm))	Height at curb weight (in (mm))
Q3	172.8 (4,388)	72.0 (1,831)	79.4 (2,019)	62.5 (1,590)

## Capacities

	Approximate capacities
Fuel tank	16.9 qt (64.0 L)
Windshield and headlight washer system	4.8 qt (4.5 L)

## Gasoline engines

### Q3 2.0, 4 cylinder

Maximum output SAE net	hp @ rpm	200 @ 5100 - 6000
Maximum torque SAE net	lb-ft @ rpm	207 @ 1700 - 5000
Displacement	CID (cm <sup>3</sup> )	121 (1984)
Engine oil with filter change <sup>1)</sup>		
Fuel	<b>Premium unleaded (91 AKI)</b> ⇨ <i>page 152, Fuel</i>	

<sup>1)</sup> For specific engine oil capacities, please see the most current information for the USA at <http://www.audiusa.com/help/maintenance> or for Canada at [http://www.audi.ca/ca/brand/en/your\\_audi/audi\\_services\\_and/Care\\_and\\_Maintenance/schedule.html](http://www.audi.ca/ca/brand/en/your_audi/audi_services_and/Care_and_Maintenance/schedule.html) or call 800-822-2834.

## Consumer Information

### Warranty coverages

Your Audi is covered by the following warranties:

- *New Vehicle Limited Warranty*
- *Limited Warranty Against Corrosion Perforation*
- *Emissions Control System Warranty*
- *Emissions Performance Warranty*
- *California Emissions Control Warranty (USA vehicles only)*
- *California Emissions Performance Warranty (USA vehicles only)*

Detailed information regarding your warranties can be found in your **Warranty & Maintenance booklet**.

### Operating your vehicle outside the U.S.A. or Canada

Government regulations in the United States and Canada require that automobiles meet specific emission regulations and safety standards.

Therefore, vehicles built for the U.S.A. and Canada differ from vehicles sold in other countries.

If you plan to take your vehicle outside the continental limits of the United States or Canada, there is the possibility that:

- unleaded fuels for vehicles with catalytic converter may not be available;
- fuel may have a considerably lower octane rating. Improper fuel may cause engine damage;
- service may be inadequate due to lack of proper service facilities, tools or testing equipment;
- replacement parts may not be readily available.
- Navigation systems for vehicles built for the U.S.A. and Canada will not necessarily work in Europe, and may not work in other countries outside of North America.

#### Note

Audi cannot be responsible for mechanical damage that could result from inadequate fuel, service or parts availability.

### Audi Service Repair Manuals and Literature

Audi Official Factory Service Manuals and Literature are published as soon as possible after model introduction. Service Manuals and literature are available to order from the Audi Technical Literature Ordering Center at:

[www.audi.techliterature.com](http://www.audi.techliterature.com)

### Maintenance

#### General

Your vehicle has been designed to help keep maintenance requirements to a minimum. However, a certain amount of regular maintenance is still necessary to assure your vehicle's safety, economy and reliability. For detailed vehicle maintenance consult your **Warranty & Maintenance booklet**.

**Under difficult operating conditions**, for example at extremely low outside temperatures, in very dusty regions, when towing a trailer very frequently, etc., some service work should be performed between the intervals specified. This applies particularly to:

- oil changes, and
- cleaning or replacing the air filter.

#### For the sake of the environment

By regularly maintaining your vehicle, you help make sure that emission standards are maintained, thus minimizing adverse effects on the environment.

#### Important considerations for you and your vehicle

The increasing use of electronics, sophisticated fuel injection and emission control systems, and the generally increasing technical complexity of ►

today's automobiles, have steadily reduced the scope of maintenance and repairs which can be carried out by vehicle owners. **Also, safety and environmental** concerns place very strict limits on the nature of repairs and adjustments to engine and transmission parts which an owner can perform.

Maintenance, adjustments and repairs usually require special tools, testing devices and other equipment available to specially trained workshop personnel in order to assure proper performance, reliability and safety of the vehicle and its many systems.



Improper maintenance, adjustments and repairs can impair the operation and reliability of your vehicle and even void your vehicle warranty. Therefore, proof of servicing in accordance with the maintenance schedule may be a condition for upholding a possible warranty claim made within the warranty period.

Above all, operational safety can be adversely affected, creating unnecessary risks for you and your passengers.

If in doubt about any servicing, have it done by your authorized Audi dealer or any other properly equipped and qualified workshop. We strongly urge you to give your authorized Audi dealer the opportunity to perform all scheduled maintenance and necessary repairs. Your dealer has the facilities, original parts and trained specialists to keep your vehicle running properly.

### Performing limited maintenance yourself

The following pages describe a limited number of procedures which can be performed on your vehicle with ordinary tools, should the need arise and trained personnel be unavailable. Before performing any of these procedures, always thoroughly read all of the applicable text and carefully follow the instructions given. Always rigorously observe the **WARNINGS** provided.

**Before you check anything in the engine compartment, always read and heed all WARNINGS** ⇨  **and** ⇨  *in Working in the engine compartment on page 155.*

### **WARNING**

- Serious personal injury may occur as a result of improperly performed maintenance, adjustments or repairs.
- Always be extremely careful when working on the vehicle. Always follow commonly accepted safety practices and general common sense. Never risk personal injury.
- Do not attempt any of the maintenance, checks or repairs described on the following pages if you are not fully familiar with these or other procedures with respect to the vehicle, or are uncertain how to proceed.
- Do not do any work without the proper tools and equipment. Have the necessary work done by your authorized Audi dealer or another properly equipped and qualified workshop.
- The engine compartment of any motor vehicle is a potentially hazardous area. Never reach into the area around or touch the radiator fan. It is temperature controlled and can switch on suddenly - even when the engine is off and the ignition key has been removed. The radiator fan switches on automatically when the coolant reaches a certain temperature and will continue to run until the coolant temperature drops.
- Always remove the ignition key before anyone gets under the vehicle.
- Always support your vehicle with safety stands if it is necessary to work underneath the vehicle. The jack\* supplied with the vehicle is not adequate for this purpose and could collapse causing serious personal injury.
- If you must work underneath the vehicle with the wheels on the ground, always make sure the vehicle is on level ground, that the wheels are always securely blocked and that the engine cannot be started.
- Always make sure the transmission selector lever (automatic transmission) is in P (Park position) and the park brake is applied.



### For the sake of the environment

- Changing the engine settings will adversely affect emission levels. This is detrimental to the environment and increases fuel consumption.
- Always observe environmental regulations when disposing of old engine oil, used brake fluid, dirty engine coolant, spent batteries or worn out tires.
- Undeployed airbag modules and pretensioners might be classified as Perchlorate Material -special handling may apply, see [www.dtsc.ca.gov/hazardouswaste/perchlorate](http://www.dtsc.ca.gov/hazardouswaste/perchlorate). When the vehicle or parts of the restraint system including airbag modules safety belts with pretensioners are scrapped, all applicable laws and regulations must be observed. Your authorized Audi dealer is familiar with these requirements and we recommend that you have your dealer perform this service for you.

## Accessories and technical changes

### Additional accessories and parts replacement

*Always consult an authorized Audi dealer before purchasing accessories.*

Audi vehicles that are constructed with advanced materials like Steel/Aluminum (Hybrid construction), Aluminum (Audi Space Frame), and/or Aluminum/Carbon Fiber (Ultra Advanced Light Weight Materials) are as unique as their drivers. Therefore, the availability of certain parts needed for repair, restoration, or reconstruction will be restricted, or parts will be unavailable, if the vehicle is not repaired at an authorized Audi collision repair facility. This includes but is not limited to structural parts which require specialized training and equipment to restore their crash-worthiness back to the original NHTSA and IIHS performance.

Your vehicle incorporates the latest safety design features ensuring a high standard of active and passive safety.

This safety could be compromised by non-approved changes to the vehicle. For this reason, if parts have to be replaced, please observe the following points when installing additional accessories:

Approved Audi accessories and genuine Audi parts are available from authorized Audi dealers.

These dealers also have the necessary facilities, tools and trained specialists to install the parts and accessories properly.



### WARNING

- Using the wrong spare parts or using non-approved accessories can cause damage to the vehicle and serious personal injury.
- Use only accessories expressly approved by Audi and genuine Audi spare parts
  - These parts and accessories have been specially designed to be used on your vehicle.
  - Never install accessories such as telephone cradles or beverage holders on airbag covers or within the airbag deployment zones. Doing so will increase the risk of injury if airbags are triggered in an accident!
  - Before you check anything in the engine compartment, always read and heed all WARNINGS ⇒ page 155.



### Note

- If items other than genuine Audi spare parts, add-on equipment and accessory items are used or if repair work is not performed according to specified methods, this can result in severe damage to your vehicle's engine and body (such as corrosion) and adversely affect your vehicle's warranty.
- If emergency repairs must be performed elsewhere, have the vehicle examined by an authorized Audi dealer as soon as possible.
- The manufacturer cannot be held liable for damage which occurs due to failure to comply with these stipulations.



## Technical Modifications

*Our guidelines must be complied with when technical modifications are made.*

Always consult an authorized Audi dealer **before** starting work on any modifications.

This will help ensure that vehicle function, performance and safety are not impaired ⇒ ⚠.

Attempting to work on electronic components and the software used with them can cause malfunctions. Because of the way electronic components are interconnected with each other, such malfunctions can also have an adverse affect on other systems that are not directly involved. This means that you risk both a substantial reduction in the operational safety of your vehicle and an increased wear of vehicle parts ⇒ ⚠.

Authorized Audi dealers will perform this work in a professional and competent manner or, in special cases, refer you to a professional company that specializes in such modifications.

### **WARNING**

Improper repairs and modifications can change the way vehicle systems work and cause damage to the vehicle and serious personal injury.

### **Note**

If emergency repairs must be performed elsewhere, have the vehicle examined by an authorized Audi dealer as soon as possible.

## Declaration of compliance for telecommunications equipment and electronic systems

The manufacturer is not liable for radio malfunctions that are caused by unauthorized changes to the equipment.

### Equipment

The following equipment complies with FCC section 15 and RSS-Gen:

- Audi adaptive cruise control\*
- Audi side assist\*
- Electronic immobilizer
- Remote control key
- Cell phone package\*

### FCC Part 15.19

This device complies with part 15 of the FCC Rules. Operation is subject to the following two conditions: (1) This device may not cause harmful interference, and (2) this device must accept any interference received, including interference that may cause undesired operation.

### FCC Part 15.21

Changes or modifications not expressly approved by the party responsible for compliance could void the user's authority to operate the equipment.

### RSS-Gen

This device complies with Industry Canada's licence-exempt RSSs. Operation is subject to the following two conditions:

- (1) This device may not cause interference; and
- (2) This device must accept any interference, including interference that may cause undesired operation of the device.

### CNR-Gen

Le présent appareil est conforme aux CNR d'Industrie Canada applicables aux appareils radio exempts de licence. L'exploitation est autorisée aux deux conditions suivantes :

- 1) l'appareil ne doit pas produire de brouillage;
- 2) l'appareil doit accepter tout brouillage radioélectrique subi, même si le brouillage est susceptible d'en compromettre le fonctionnement.

<b>A</b>	
A/C (automatic climate control system) . . . . .	54
A/C (manual climate control system) . . . . .	52
ABS	
<i>refer to</i> Anti-lock braking system . . . . .	89
Accessories . . . . .	44, 214
Adaptive dampers . . . . .	81
Adaptive light . . . . .	81
<i>also refer to</i> Audi adaptive light . . . . .	16
Additional accessories . . . . .	214
Adjusting the air distribution	
Automatic climate control system . . . . .	55
Manual climate control system . . . . .	52
Adjusting the air vents	
Automatic climate control system . . . . .	55
Manual climate control system . . . . .	52
Adjusting the center console lighting . . . . .	35
Adjusting the temperature	
Heating/ventilation system and manual climate control system . . . . .	52
Advanced key	
<i>refer to</i> Convenience key . . . . .	61
Airbag . . . . .	114
Airbag system . . . . .	129
Advanced Airbag System . . . . .	118
Advanced Airbag System components . . . . .	120
Care . . . . .	127
Children . . . . .	135
Child restraints . . . . .	136
Components (front airbags) . . . . .	120
Danger of fitting a child safety seat on the front passenger seat . . . . .	115
Disposal . . . . .	127
Front airbags . . . . .	118
How do the front airbags work? . . . . .	122
How many airbags does my vehicle have? . . . . .	120
How the Advanced Airbag System components work together . . . . .	122
Important information . . . . .	114
Indicator light . . . . .	124
Monitoring . . . . .	124
PASSENGER AIR BAG OFF light . . . . .	125
Repairs . . . . .	127
Safety instructions . . . . .	126
Side airbags . . . . .	128
Side curtain airbags . . . . .	131
Weight-sensing mat . . . . .	136
When must the system be inspected? . . . . .	124
Air pressure (tires) . . . . .	176
Air pressure (tire) . . . . .	183
All season tires . . . . .	181
All weather lights . . . . .	33
All wheel drive . . . . .	93
Anti-freeze	
Windshield washer system . . . . .	165
Anti-lock braking system . . . . .	89
Anti-Slip Regulation . . . . .	89
Armrest . . . . .	43
ASR	
<i>refer to</i> Anti-Slip Regulation . . . . .	89
Audi adaptive light . . . . .	16
Audi drive select . . . . .	80
Audi Service Repair Manuals and Literature . . . . .	212
Audi side assist . . . . .	78
Adjusting the brightness . . . . .	80
Cleaning the sensors . . . . .	186
Sensor range . . . . .	78
Switching on and off . . . . .	80
AUTO	
Automatic climate control system . . . . .	54
Automatic headlights . . . . .	33
Auto Lock (central locking system) . . . . .	22
Automatic belt retractor . . . . .	109
Automatic climate control	
<i>refer to</i> Climate control system	
(automatic) . . . . .	51, 54
Automatic climate control system	
<i>refer to</i> Climate control system	
(automatic) . . . . .	51, 54
Automatic transmission . . . . .	66
Driving tips . . . . .	69
Emergency mode . . . . .	71
Hill descent control . . . . .	70
Kick-down . . . . .	71
Manual shifting . . . . .	70
Selector lever emergency release . . . . .	72
Selector lever positions . . . . .	67
Steering wheel with shift paddles . . . . .	70
tiptronic mode . . . . .	70
Automatic wipe/wash system . . . . .	38
Auto Safety Hotline . . . . .	104
Average consumption . . . . .	19

Average speed	19	Center armrest	43
<b>B</b>		Central locking	22
Bag/securing hooks	46	Certification	215
Bag hooks	48	Changing engine oil	161
Battery		Child restraints	
Jump starting	203	Danger of using child restraints in the front seat	115
<i>also refer to</i> Vehicle battery	163	Where can I get additional information about child restraints and their use?	151
Before driving	97	Child restraints system anchors	147
Belt tensioners	112	Child safety	134
Blended gasoline	152	Important safety instructions for using child safety seats	137
Blower		Important things to know when driving with children	134
Automatic climate control system	55	Installing a child restraint using the LATCH system	149
Heating/ventilation system and manual climate control system	52	Mounting and releasing the anchorage hook	149
Booster seats	142	Tether anchors	149
Brakes	91	Tether straps	149
Brake assist	89	Child safety lock	30
Brake booster	91	Child safety seats	140
Brake fluid	163	Booster seats	142
Electromechanical parking brake	63	Convertible child seats	141
Emergency braking function	64	Convertible locking retractor	146
New brake pads	91	Danger of using child restraints in the front seat	115
Worn brake pads	14	How do I properly install a child safety seat in my vehicle?	137
Breaking in		Infant seats	140
New brake pads	91	LATCH system	149
New engine	57	Lower anchorages	148
New tires	173	Safety instructions	137
Bulbs	201	Securing	144
<b>C</b>		Unused safety belts on the rear seat	139
California Proposition 65 Warning	156	Cleaning	185
Battery specific	164	Cleaning/removing ice from windows	187
Capacities		Cleaning Alcantara	188
Fuel tank	210	Cleaning artificial leather	188
Washer fluid reservoir	210	Cleaning carbon parts	187, 188
Caps for wheel bolts, removing	193	Cleaning controls	187
Care	185	Cleaning decorative parts and trim	186, 187
Cargo area		Cleaning exhaust tail pipes	186
<i>refer to</i> Loading the luggage compartment	102	Cleaning plastic parts	187
Cargo bag	47	Cleaning rims	186
Cargo floor	49	Cleaning textiles	188
Cargo mat	48		
Catalytic converter	155		

Cleaning the tail lights . . . . .	186	Coolant level checking . . . . .	162
Climate control system		Coolant temperature . . . . .	8
Drive select . . . . .	81	Crossing water . . . . .	57, 66
Climate control system (automatic) . . . . .	51	Cruise control system . . . . .	76
AUTO (automatic mode) . . . . .	54	Cup holders . . . . .	45
Changing the temperature unit . . . . .	55	Current consumption . . . . .	19
Description . . . . .	51		
Key recognition . . . . .	51	<b>D</b>	
Operation . . . . .	54	Data recorder . . . . .	95
Synchronizing . . . . .	54	Date . . . . .	9
Climate control system (manual)		Daytime running lights . . . . .	33
Description . . . . .	51	Declaration of compliance . . . . .	215
Operation . . . . .	52	Defrosting (windows)	
Closing		Automatic climate control system . . . . .	55
Hood . . . . .	157	Manual climate control system . . . . .	52
Panorama glass roof . . . . .	31	DEF (instrument cluster) . . . . .	9
Windows . . . . .	30	Determining correct load limit . . . . .	180
Closing/opening		Digital compass . . . . .	40
<i>refer to</i> Unlocking/locking . . . . .	24	Dimensions . . . . .	210
Cockpit (overview) . . . . .	6	Dimming the exterior mirrors . . . . .	36
Coming home . . . . .	34	Dimming the rearview mirror . . . . .	36
Compact spare tire . . . . .	197	Display	
Compartments . . . . .	45, 46	Cleaning . . . . .	187
Compass in the mirror . . . . .	40	Distance . . . . .	19
Compliance . . . . .	215	Doors	
Consumer Information . . . . .	104, 212	Child safety lock . . . . .	30
Consumption (fuel) . . . . .	19	Emergency locking . . . . .	26
Contacting NHTSA . . . . .	104	Driver information system	
Convenience key		Driver messages . . . . .	19
Starting the engine . . . . .	61	Efficiency program . . . . .	20
Stopping the engine . . . . .	62	On-board computer . . . . .	19
Switching the ignition on . . . . .	61	Operating using the multifunction steering	
Unlocking/locking . . . . .	24	wheel . . . . .	19
Convenience opening/closing . . . . .	31	Operating using windshield wiper lever . . .	18
Convertible child safety seats . . . . .	141	Overview . . . . .	18
Convertible locking retractor		Service interval display . . . . .	165
Activating . . . . .	146	Driver seat	
Deactivating . . . . .	146	<i>refer to</i> Seating position . . . . .	98
Using to secure a child safety seat . . . . .	146	Drive select	
Cooling mode (automatic climate control sys-		<i>refer to</i> Audi drive select . . . . .	80
tem) . . . . .	54	Driving economically . . . . .	57
Cooling mode (manual climate control sys-		Driving offroad . . . . .	65
tem) . . . . .	52	Driving safely . . . . .	97
Cooling system		Driving through water . . . . .	57, 66
Adding coolant . . . . .	162	Driving time . . . . .	19
Coolant . . . . .	162		

Dust filter		
<i>refer to</i> Pollutant filter	.....	51
<b>E</b>		
EDL		
<i>refer to</i> Electronic Differential Lock	.....	89
Efficiency program		
Fuel economy messages	.....	21
Other equipment	.....	20
Overview	.....	20
Electromechanical parking brake	.....	63
Electromechanical steering	.....	93
Electronic Differential Lock	.....	89
Electronic immobilizer	.....	23
Electronic stabilization control	.....	89
Electronic Stabilization Control		
Hill descent assist	.....	91
Offroad mode	.....	90
Emergency assistance	.....	191
Emergency braking function	.....	64
Emergency flashers	.....	34
Emergency locking the front passenger's door	.....	26
Emergency operation		
Front passenger's door	.....	26
Fuel filler door	.....	155
Luggage compartment lid	.....	29
Panorama glass roof	.....	32
Sunshade (roof)	.....	32
Emergency release		
Selector lever	.....	72
Emergency starting	.....	203
Emergency unlocking/locking		
On lock cylinder	.....	26
Emissions control system		
Catalytic converter	.....	155
Energy management	.....	94
Engine		
Coolant	.....	162
Starting/stopping (convenience key)	..	61, 62
Starting/stopping (ignition lock)	.....	60
Starting with jumper cables	.....	203
Stopping (ignition lock)	.....	60
Engine compartment	.....	155
Engine oil	.....	158
Adding	.....	160
Changing	.....	161
Checking the engine oil level	.....	160
Dipstick	.....	160
Economy	.....	160
Oil consumption	.....	159
Oil grades	.....	158
Specification and viscosity	.....	158
Engine speed limitation (indicator light)	...	15
Environment		
Proper disposal of drained engine oil	....	161
Unleaded gasoline	.....	152
EPC (engine control)	.....	14
ESC		
<i>refer to</i> Electronic stabilization control	...	89
Event Data Recorder (EDR)	.....	95
Exterior lighting	.....	33
Exterior mirrors		
Adjusting	.....	36
Dimming	.....	36
Heating	.....	36
<b>F</b>		
Fastening		
Booster seats	.....	142
Convertible child safety seats	.....	141
Infant seats	.....	140
Federal Communications Commission (FCC)	.....	215
Floor mats	.....	101
Folding the rear seats	.....	47
Foot pedals	.....	101
For the sake of the environment		
Environmentally-friendly driving	.....	57
Fueling	.....	153
Leaks	.....	156
Roof rack	.....	50
Freeze protection		
Coolant	.....	162
Front airbags		
Description	.....	118
How they work	.....	122
Frontal collisions and the laws of physics	..	107
Front seats	.....	42
Adjusting	.....	99
Child restraints in the front seat	.....	115
Fuel	.....	152
Additives	.....	152
Blended gasoline	.....	152

Current consumption . . . . .	19	Hill hold assist . . . . .	65
Fuel gauge . . . . .	8, 9	<i>also refer to</i> Hill hold assist . . . . .	65
Fuel tank capacity . . . . .	210	Hold assist (hill) . . . . .	65
Gasoline . . . . .	152	Horn . . . . .	6
Gasoline additives . . . . .	153	How are child restraint system anchors related to child safety . . . . .	147
Saving fuel . . . . .	57, 81	How many airbags does my vehicle have? . .	120
Fuel economy messages (efficiency program) .	21	How safety belt pretensioners work . . . . .	112
Fueling			
Fuel filler door emergency release . . . . .	155		
Fuel gauge . . . . .	9		
Fuel tank capacity . . . . .	210		
Opening the fuel filler door . . . . .	153		
Fuses . . . . .	199		
		<b>I</b>	
<b>G</b>		Ignition	
Garment hooks . . . . .	46	Switching on and off (convenience key) . . .	61
Gas discharge lamps . . . . .	201	Switching on and off (ignition lock) . . . . .	60
Gasoline . . . . .	152	Imbalance (wheels) . . . . .	175
Octane rating . . . . .	152	Immobilizer . . . . .	23
Recommendation . . . . .	152	Important things to do before driving . . . . .	97
Generator (indicator light) . . . . .	13	Improperly worn safety belts . . . . .	112
Glossary of tire and loading terminology . .	169	Indicator lights . . . . .	10
Glove compartment . . . . .	45	Airbag system . . . . .	124, 125
Gross Vehicle Weight Rating (GVWR) . . . . .	209	PASSENGER AIR BAG OFF . . . . .	125
Ground clearance . . . . .	66	Infant seats . . . . .	140
		Inspection interval . . . . .	165
		Installing child safety seats	
		Safety belts . . . . .	144
		Installing the upper tether strap on the anchorage . . . . .	150
		Instrument cluster . . . . .	8
		Cleaning . . . . .	187
		Instruments . . . . .	8
		Adjusting the lighting . . . . .	35
		Interior lighting . . . . .	35
		Interior lighting . . . . .	35
		Interval mode (windshield wipers) . . . . .	38
		<b>J</b>	
		Jack . . . . .	194
		Jump-starting . . . . .	203
		Jumper cables . . . . .	204
		<b>K</b>	
		Key . . . . .	23
		Key not recognized . . . . .	63
		Key recognition . . . . .	51
		Key replacement . . . . .	23
		Replacing the battery . . . . .	23

- Kick-down (automatic transmission) . . . . . 71
- L**
- LATCH . . . . . 147  
 Description . . . . . 148  
 Installing a child restraint . . . . . 149  
 Location . . . . . 148  
 Mounting and releasing the anchorage  
 hook . . . . . 149  
 Leather care/cleaning . . . . . 188  
 Leaving home . . . . . 34  
 Light/rain sensor  
 Headlights . . . . . 33  
 Interval mode (windshield wipers) . . . . . 38  
 Lighting  
 Exterior . . . . . 33  
 Interior . . . . . 35  
 Lights  
 Interior/reading lights . . . . . 35  
 Interior lighting . . . . . 35  
 Loading the luggage compartment . . . . . 102  
 Locking/unlocking  
*refer to* Unlocking/locking . . . . . 24  
 Low-profile tires . . . . . 182  
 Low beam headlights . . . . . 33  
 Lower universal anchorages (Canada) . . . . . 147  
 Luggage compartment . . . . . 46  
 Luggage compartment lid . . . . . 27  
 Storing cargo correctly . . . . . 102  
*also refer to* Loading the luggage compart-  
 ment . . . . . 102  
 Luggage compartment net . . . . . 47  
 Luggage rack . . . . . 49  
 Lumbar support . . . . . 42
- M**
- Maintenance . . . . . 212  
 Maintenance intervals . . . . . 165  
 Malfunction indicator lamp (MIL) . . . . . 14, 17  
 Manual climate control system  
*refer to* Climate control system  
 (manual) . . . . . 51, 52  
 Mirror compass . . . . . 40  
 Mirrors . . . . . 36  
 Monitoring the Advanced Airbag System . . . . . 124
- Multifunction steering wheel . . . . . 19
- N**
- Natural leather care/cleaning . . . . . 188  
 Net . . . . . 46  
 NHTSA  
 Contacting . . . . . 104  
 Number of seats . . . . . 106
- O**
- Occupant seating positions . . . . . 98  
 Octane rating (gasoline) . . . . . 152  
 Odometer . . . . . 9  
 Oil  
*refer to* Engine oil . . . . . 158, 160  
 Oil change interval . . . . . 165  
 On-board computer . . . . . 19  
 On-Board Diagnostic System (OBD)  
 Data Link Connector (DLC) . . . . . 17  
 Malfunction indicator lamp (MIL) . . . . . 17  
 Opening . . . . . 22  
 Fuel filler door . . . . . 153  
 Hood . . . . . 157  
 Luggage compartment lid . . . . . 28  
 Panorama glass roof . . . . . 31  
 Windows . . . . . 30  
 Opening/closing  
*refer to* Unlocking/locking . . . . . 24  
 Other equipment (efficiency program) . . . . . 20  
 Outside temperature display . . . . . 9  
 Overview (Cockpit) . . . . . 6
- P**
- Paint damage . . . . . 187  
 Paint number . . . . . 209  
 Panorama glass roof . . . . . 31  
 Emergency closing . . . . . 32  
*also refer to* Convenience opening/closing . . . . . 31  
 Parking brake  
*refer to* Electromechanical parking brake . . . . . 63  
 Parking lights . . . . . 33  
 Parking system  
 Parking system plus . . . . . 83  
*also refer to* Parking systems . . . . . 83, 84

Parking systems . . . . .	82	Rear fog lights . . . . .	33
Adjusting the display/warning tone . . . . .	87	Rearview camera	
Cleaning the rearview camera . . . . .	85	<i>refer to</i> Parking systems . . . . .	83, 84
Cleaning the sensors/camera . . . . .	186	Rear window defogger	
Malfunction . . . . .	88	Automatic climate control system . . . . .	55
Rear parking system . . . . .	83	Manual climate control system . . . . .	53
Rearview camera . . . . .	84	Rear window wiper	
Trailer hitch . . . . .	88	Replacing wiper blades . . . . .	39, 40
Parking (automatic transmission) . . . . .	69	Recirculation mode	
Parts replacement . . . . .	214	Automatic climate control system . . . . .	55
Pass-through . . . . .	48	Manual climate control system . . . . .	53
PASSENGER AIR BAG OFF light . . . . .	125	Refueling . . . . .	153
Pedals . . . . .	101	Remote control	
Physical principles of a frontal collision . . .	107	<i>refer to</i> Remote control key . . . . .	23
Polishing . . . . .	187	Remote control key . . . . .	23
Pollen filter		LED . . . . .	23
<i>refer to</i> Pollutant filter . . . . .	51	Personalization . . . . .	23
Pollutant filter . . . . .	51	Replacing the battery . . . . .	23
Power seat adjustment . . . . .	42	Synchronization . . . . .	24
Power windows . . . . .	30	Unlocking/locking . . . . .	24
Child safety lock . . . . .	30	Repair manuals . . . . .	212
Malfunction . . . . .	31	Repairs	
Pregnant women		Airbag system . . . . .	127
Special considerations when wearing a safe-		Replacement key . . . . .	23
ty belt . . . . .	111	Replacing	
Proper safety belt position . . . . .	110	Light bulbs . . . . .	201
Proper seating position		Replacing wiper blades . . . . .	39, 40
Front passenger . . . . .	99	Reporting Safety Defects . . . . .	104
Occupants . . . . .	98	Reset button (trip odometer) . . . . .	9
Rear passengers . . . . .	99	Resetting the trip odometer . . . . .	9
Protective liner . . . . .	49	Retractor . . . . .	109
<b>Q</b>		Rims . . . . .	180
quattro (all wheel drive) . . . . .	93	Roof load . . . . .	49
Question		Roof rack . . . . .	49
What happens to unbelted occupants? . .	107	<b>S</b>	
<b>R</b>		Safe driving habits . . . . .	97
Radio Standards Specification (RSS) . . . . .	215	Safety	
Rain/light sensor		Airbag system . . . . .	114
Headlights . . . . .	33	Belts . . . . .	106
Interval mode (windshield wipers) . . . . .	38	Cargo . . . . .	102
Raising the vehicle . . . . .	207	Correct seating position . . . . .	98
Range (fuel level) . . . . .	19	Pedal area . . . . .	101
Reading lights . . . . .	35	Safety belt position . . . . .	110
		Safety belt height adjustment . . . . .	111
		Safety belts worn by pregnant women . . .	111



- Safety belt pretensioner  
 Service and disposal . . . . . 113
- Safety belts . . . . . 106, 109  
 Cleaning . . . . . 187  
 Danger to passengers who do not wear a  
 safety belt . . . . . 107  
 Fastening . . . . . 109  
 Height adjustment . . . . . 111  
 Improperly worn . . . . . 112  
 Not worn . . . . . 107  
 Safety belt position . . . . . 110  
 Safety instructions . . . . . 108  
 Securing child safety seats . . . . . 144  
 Special considerations for pregnant wom-  
 en . . . . . 111  
 Unfastening . . . . . 111  
 Warning/indicator light . . . . . 106  
 Worn properly . . . . . 108
- Safety instructions  
 for side curtain airbags . . . . . 133  
 for using child safety seats . . . . . 137  
 for using safety belts . . . . . 108  
 Monitoring the Advanced Airbag System . . . . . 126
- Safety systems . . . . . 14
- Seat  
 Number of seats . . . . . 106
- Seat adjustment  
 Head restraints . . . . . 100
- Seat belts  
*refer to* Safety belts . . . . . 106
- Seat heating  
 Automatic climate control system . . . . . 55  
 Manual climate control system . . . . . 53
- Seating capacity . . . . . 106
- Seating position  
 Driver . . . . . 98  
 Front passenger . . . . . 99  
 How to adjust the front seats . . . . . 99  
 Incorrect seat position . . . . . 100  
 Occupants . . . . . 98  
 Rear passengers . . . . . 99
- Seats  
 Adjusting . . . . . 42  
 Cleaning . . . . . 188  
 Correct seating position . . . . . 98  
 Folding . . . . . 47
- Selective wheel torque control . . . . . 89
- Selector lever (automatic transmission)  
 Emergency operation . . . . . 72  
 Position . . . . . 67
- Service and disposal  
 Safety belt pretensioner . . . . . 113
- Service interval display . . . . . 165
- Service position  
*refer to* Replacing wiper blades . . . . . 39
- Setting the temperature  
 Automatic climate control system . . . . . 54
- Shift paddles (automatic transmission) . . . . . 70
- Side airbags  
 Description . . . . . 128  
 How they work . . . . . 129
- Side assist  
*refer to* Audi side assist . . . . . 78
- Side curtain airbags . . . . . 131  
 Description . . . . . 131  
 How they work . . . . . 132  
 Safety instructions . . . . . 133
- Ski bag . . . . . 48
- Snow chains . . . . . 181
- Sockets . . . . . 44
- Sources of information about child restraints  
 and their use . . . . . 151
- Space-saving spare tire (compact spare tire) . . . . . 197
- Spare tire . . . . . 197
- Speedometer . . . . . 8
- Speed warning system . . . . . 76
- Stabilization control  
*refer to* Electronic stabilization control . . . . . 89
- START ENGINE STOP button . . . . . 61
- Starting (engine) . . . . . 60, 61
- Steering  
 Electromechanical steering . . . . . 93  
 Locking (convenience key) . . . . . 62  
 Locking (ignition lock) . . . . . 60  
*also refer to* Electromechanical steering . . . . . 93
- Steering wheel  
 Adjusting . . . . . 59  
 Shift paddles (automatic transmission) . . . . . 70
- Steps for determining correct load limit . . . . . 180
- Stopping (engine) . . . . . 60, 62
- Storage compartments . . . . . 45
- Subwoofer . . . . . 198

Sunroof	
<i>refer to</i> Panorama glass roof	31
Sunshade	
Emergency closing (panorama glass roof)	32
Sun visors	37
Symbols	
<i>refer to</i> Indicator lights	10
<b>T</b>	
Tachometer	8, 9
Technical data	209
Technical modifications	215
Temperature display	
Outside temperature	9
Temperature indicator	
Coolant	8
Temporary spare tire	197
Tether anchors	149
Tether strap	149
Tie-down rings	103
Tie-downs	47
Time	9
tiptronic mode (automatic transmission)	70
tiptronic (automatic transmission)	66
Tires	166
All wheel drive	93
Low-profile tires	182
Replacing	191
Service life	175
Tire pressure	176
Tire pressure monitoring system	183
Tire pressure table	177
Tire pressure (trailer towing)	73
Treadwear indicators	175
Unidirectional	168
Uniform tire quality grading	182
Tires and wheels	
Glossary of tire and loading terminology	169
Tires and vehicle load limits	178
Tool	191
Torn or frayed safety belts	108
Towing	
Tow trucks	205
Towing loop	205, 206
TPMS (Tire Pressure Monitoring System)	183
Trailer towing	73
Parking systems	88
Trailer load	73
Turn signals	16
Transport Canada	104
Turn signal	34
<b>U</b>	
Unfastening safety belts	111
Uniform tire quality grading	182
Unlocking/locking	
By remote control	24
With the central locking switch	25
With the convenience key	24
Use of jumper cables	204
<b>V</b>	
Vanity mirror	37
Vehicle	
Care/cleaning	185
Dimensions	210
Out of service	190
Specifications	209
Vehicle battery	163
Charge level	94
Charging	13, 164
Energy management	94
Vehicle control modules	95
Vehicle jack	191, 194
Vehicle key	23
Vehicle tool kit	191
VIN	209
<b>W</b>	
Warning lights	
<i>refer to</i> Indicator lights	10
Warranty coverages	212
Washing matte finish paint	185
Weights	209
What happens if you wear your safety belt too loose?	110
What happens to unbelted occupants?	107
What impairs driving safety?	97
Wheel bolt caps	
Removing	193

Wheel bolts .....	180
Loosening .....	193
Tightening .....	193
Wheel covers, removing .....	193
Wheels .....	166
Cleaning .....	186
Glossary of tire and loading terminology .	169
Replacing .....	191
Tires and vehicle load limits .....	178
When must a safety belt be replaced? ....	108
When must the airbag system be inspected? .	124
Where are lower anchorages located? ....	148
Window regulators .....	30
Child safety lock .....	30
Windows	
Cleaning/removing ice .....	187
Windshield	
Cleaning .....	38
<i>also refer to</i> Windshield .....	38
Windshield washer system .....	38, 165
Reservoir capacity .....	210
Winter operation	
Car washes .....	185
Cooling system .....	162
Defrosting windows (automatic climate control system) .....	55
Defrosting windows (manual climate control system) .....	52
Removing ice from windows .....	187
Seat heating (automatic climate control system) .....	55
Snow chains .....	181
Tires .....	181
Windshield washer system .....	165
Winter tires .....	181
<b>X</b>	
Xenon headlights .....	201



It has always been Audi's policy to continuously improve its products. AUDI AG reserves the right to make changes in design and specifications, and to make additions or improvements in its products without incurring any obligation to install them on products previously manufactured. This Owner's Manual is based on the current data available when it was printed. Text, illustrations and specifications in this owner's manual are based on the most up-to-date information available at the time of printing, and shall not constitute a basis for liability claims.

These instructions may not be reproduced or translated in whole or in part without written consent of AUDI AG. All rights reserved by AUDI AG.



**For the sake of the environment**

Printed on environmentally friendly paper  
(bleached without chlorine, recyclable)

**Owner's Manual**  
**Englisch Nordamerika 01.2017**  
**8U0012721BD**



8U0012721BD

[www.audi.com](http://www.audi.com)