

# AIR CONDITIONER WALL CONTROLLER

## Operating Instructions

### Controller Model Numbers

LM7  
LM7-D  
LM24W



### Please Read This Manual

Congratulations on your purchase of an ActronAir air conditioning system. This unit has been designed and manufactured with the highest quality standard in mind.

Please read this manual carefully and keep it for future reference.

## GENERAL INFORMATION

**INSIDE THIS MANUAL** You will find instructions for two types of wall controllers, the standard 7-Day programmable model LM7 and the optional model LM24W. The LM7 series controllers have all the features of LM24W series plus the addition of a fully programmable 7-Day Timeclock.

NOTE: Most of the basic functions in this manual are shown using the LM24W controller, the buttons and basic functions are the same for LM7.

**SUMMER OPERATION** is when your system is operating on COOLING CYCLE, the room air is circulated through the filter and indoor unit where heat, excess moisture and dust are removed. The clean, cool air is then returned to your room. Dust and other air born particles are trapped in the filter, and condensed moisture is drained away. The indoor heat is transferred by interconnecting refrigeration pipes to the outdoor unit, which then exhaust this heat to the outdoor atmosphere.

**WINTER OPERATION** is just the reverse use of the system to obtain heat into our rooms. During the HEATING CYCLE the outdoor unit extracts heat from the outside air and then transferred by the same interconnecting pipes to the indoor unit where the circulated air is heated and returned to your rooms. Again, the room air is filtered reducing dust and other particles.

## SAFETY AND OPERATION PRECAUTION

**ACCESS PANELS AND GUARDS:** NEVER remove any access panels or guards as this could cause injury from electric shock and burns from extremely hot components. Never allow any bodily parts such as fingers or objects to protrude through the fan guards or any other opening as they could cause personal injury and damage the air conditioner.



**SUPERVISION OF CHILDREN AND INFIRM PERSON:** This appliance is not intended for use by young children or infirm person unless they have been adequately supervised by a responsible person to ensure that they can use the appliance safely. Young children should be supervised to ensure that they do not play with the appliance.

**RETURN AIR FILTER:** The air conditioner must never be operated without a return air filter as this will allow a build up of dust etc on the Indoor Coil. This is very difficult to clean and causes the system to operate inefficiently or even fail.

**CRANKCASE HEATER PRECAUTION:** The main power ( Outside switch board ) to the system must be kept ON at all times to prevent damage to the outdoor compressor unit. Should the main power be disconnected or interrupted for 6 hours or longer, then no attempt should be made to start the system for 2 hours after the power has been restored to outdoor unit. This allows the compressor to warm up, and remove any liquid refrigerant that may cause damage.

# CONTENTS

General information.....Page 2  
 Safety and operation precautions.....Page 2  
 System information..... Page 3  
 Advance features..... Page 4

## Basic Operation \*

Wall controller functions ..... Page 5  
 LCD Backlight ..... Page 8  
 ON/OFF Button Light ..... Page 9  
 Cooling operation ..... Page 10  
 Heating operation ..... Page 11  
 Auto operation ..... Page 12  
 Fan Only operation ..... Page 13  
 ESP Fan Feature ..... Page 14  
 Countdown timer (off) ..... Page 15  
 Countdown timer (on) ..... Page 16

## 7-Day Programmable Model

(Model LM7 -- only)  
 7-Day Timeclock operation .....Page 17  
 Setting the time and day .....Page 18

Activating and de-activating  
 the 7-Day Timeclock .....Page 19  
 Programming the events ..... Page 20  
 Cancelling an individual event .....Page 21  
 Repeating a days event and times ..... Page 22

## Additional Features \*

Zone controller functions ..... Page 23  
 Room temperature display ..... Page 23  
 Dual wall controller operation ..... Page 24  
 Setting the upper and lower  
 temperature limits .....Page 25

## Additional Features

Operating tips for extreme weather  
 (Summer) ..... Page 26  
 Operating tips for extreme weather  
 (Winter) ..... Page 27  
 Energy conservation tips ..... Page 28  
 Maintenance .....Page 29  
 Trouble Shooting .....Page 30  
 Resetting wall control ..... Page 31

\* **Basic Operation and Additional Features show LM7 Wall Controller for illustration purposes only. Buttons, functions and controller operation are the same for both controllers.**

# SYSTEM INFORMATION

<b>Air Conditioner</b>	
<b>Model No.</b>	
<b>Serial No.</b>	
The air conditioner model and serial number is situated on the access panel of the outdoor unit bottom left corner.	
<b>Wall Controller</b>	
<b>Model No.</b>	
The wall controller model number is situated inside the wall controller flip lid.	
<b>Installer</b>	
<b>Company Name</b>	
<b>Phone Number</b>	
<b>Technicians Name</b>	

## ADVANCE FEATURES

<b>1</b>	<p><b>Auto-Restart After Power Failure</b> Should a power failure occur whilst the air conditioner is running, the wall controller will restart the air conditioner in the same mode when the power is restored.</p>
<b>2</b>	<p><b>Dual Wall Control Operation ( Optional )</b> Two wall controls can be installed on one system. This is particularly useful on two storey houses, where you can have one control upstairs and one control downstairs or having the second wall controller in the master bedroom, for improved temperature control. ( See Dual Wall Control Operation for more info, Page 23 ).</p>
<b>3</b>	<p><b>Room Temp Display with One Touch</b> Simply press SELECT UP <math>\triangle</math> or DOWN <math>\nabla</math> arrow button and the set temperature display will change to show the room temperature for 3 seconds.</p> <p>Note: When zones are fitted, the temperature displayed will depend on which sensor has been selected by the wall controller ( See Zone Controller Functions, Page 22 ).</p>
<b>4</b>	<p><b>Integrated Zoning ( Optional )</b> The integrated zoning system has a unique feature where it can select which remote temperature sensor to use depending on which zones are selected. One example is on a two-storey house and you only have the downstairs zone on, the zone control will select the downstairs sensor to control the temperature, thus ensuring perfect comfort in the area occupied.</p>
<b>5</b>	<p><b>Auto Defrost Function ( Heating Mode )</b> At certain outdoor conditions (low temperature) there may be a build up of frost on the outdoor heat exchanger. This gradual build up of frost reduces the performance of the air conditioner. The microprocessor detects this frost build up and will automatically activate the defrost mode.</p> <p>The defrost mode is displayed on the wall controller by flashing the "HEAT" symbol every 10 seconds.</p>
<b>6</b>	<p><b>Hot Start Function ( Heating Mode )</b> When the air conditioner starts in heating mode, the indoor fan is delayed for a short period of time, this allows the heat exchanger to warm up before the air flow starts, thus preventing cold drafts. The hot start feature also activates itself when the system finishes defrosting.</p>
<b>7</b>	<p><b>Filter Clean Light</b> The microprocessor monitors the accumulated run time of the air conditioner and after a preset number of hours has passed, the "FILTER" light will flash, indicating it's time to check if filter needs cleaning. (See Maintenance Sec, page 28).</p>
<b>8</b>	<p><b>Self Diagnosis</b> In the unlikely event that a fault develops with the air conditioner the microprocessor will diagnose the fault (where possible) and display a fault code on the wall controller. (See Trouble shooting, page 29)</p>

# WALL CONTROLLER FUNCTIONS

**Model LM7 & LM24W Series** - Buttons & functions are the same, except for items ②, ⑥ & ⑳ which are not available to LM24W.

LM7 & LM7-D

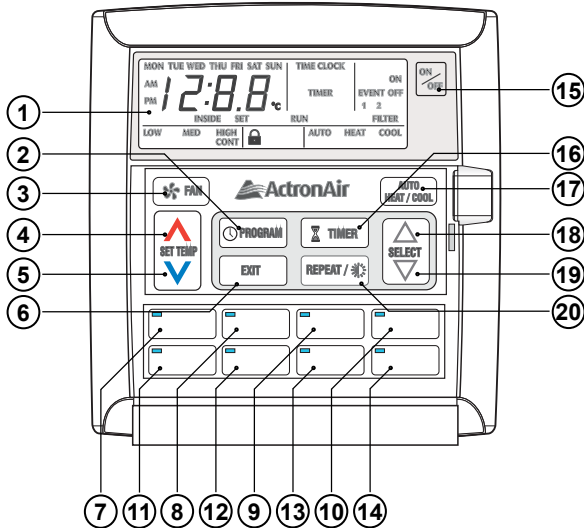

LM24W

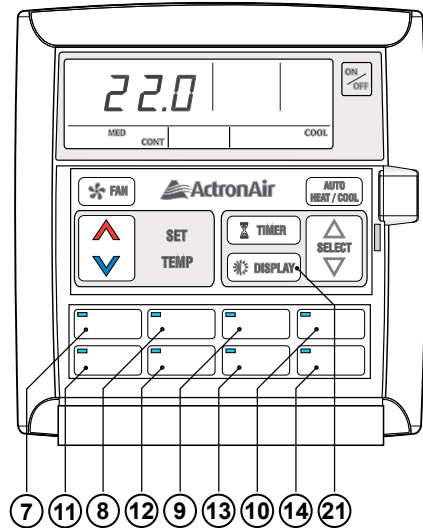

- ① **LCD Display**  
Displays the setting and operation conditions (see next page for details).
- ② **Program Button** (Not used on LM24W)  
For setting the clock and for entering the 7-Day timeclock menu.
- ③ **Fan Control Button**  
Changes fan speed (high, medium and low). Selects continuous and non-continuous fan operation.
- ④ **Temperature-Up Setting Button**  
Raises room temperature setting.
- ⑤ **Temperature-Down Setting Button**  
Lowers room temperature setting.
- ⑥ **Exit Button** (Not used on LM24W)  
Quick exit from time clock programming menu.
- ⑦ **Zone 1 Button with On/Off Indicator**
- ⑧ **Zone 2 Button with On/Off Indicator**
- ⑨ **Zone 3 Button with On/Off Indicator**
- ⑩ **Zone 4 Button with On/Off Indicator**
- ⑪ **Zone 5 Button with On/Off Indicator**
- ⑫ **Zone 6 Button with On/Off Indicator**
- ⑬ **Zone 7 Button with On/Off Indicator**
- ⑭ **Zone 8 Button with On/Off Indicator**
- ⑮ **On/Off Button**
- ⑯ **Timer Operation Button**  
Activates timer function.
- ⑰ **Operation Mode Button**  
Selects cooling, heating & auto modes.
- ⑱ **Select/Clock-Up Setting and Room Temp Display Button**
- ⑲ **Select/Clock-Down Setting and Room Temp Display Button**
- ⑳ **Repeat/Backlight Button** (LM7 only)
  - Repeats the previous day settings to the current day.
  - Adjust and Turn On/Off Backlight.
- ㉑ **Display/Backlight Button** (LM24W only)  
Adjust and Turn On/Off Backlight.

# WALL CONTROLLER FUNCTIONS

## LM7 & LM7-D Display

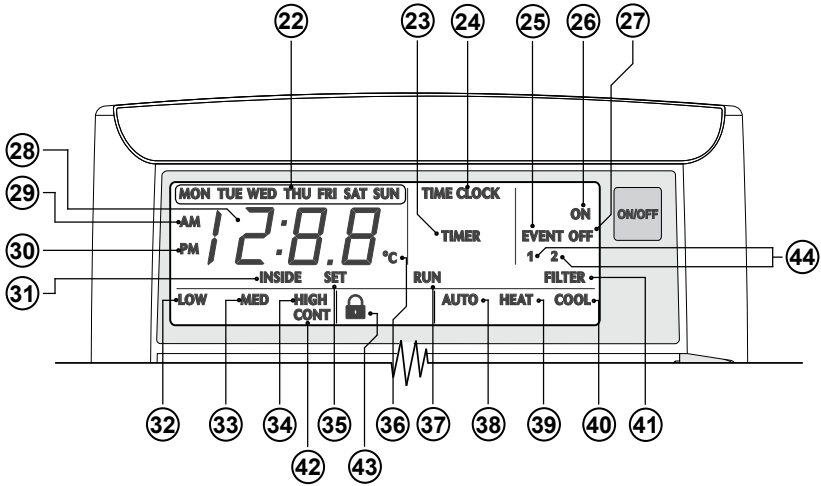

## LM24W Display

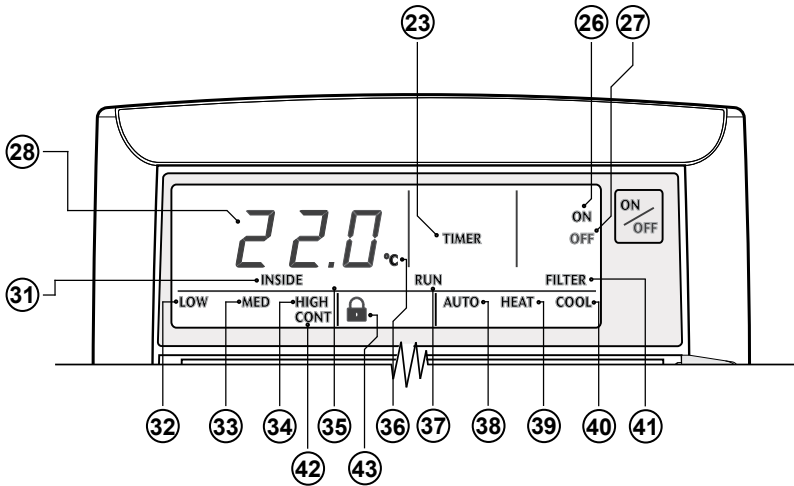

# WALL CONTROLLER FUNCTIONS

## LM7, LM7-D & LM24W Display Functions

- ②② **Day indicator** (LM7 / LM7-D only)  
Display the day of the week when the time is shown and which day is selected for programming.
- ②③ **Timer Indicator**  
Indicates timer is in operation.
- ②④ **Time Clock Indicator** (LM7 / LM7-D only)
- ②⑤ **Event Indicator** (LM7 / LM7-D only)  
Indicates which event of the day Timeclock is set.
- ②⑥ **On Indicator**
- ②⑦ **Off Indicator**
- ②⑧ **Timer/Clock and Room/Setpoint Temperature Indicator** (LM7 / LM7-D only)  
Displays the setpoint & current room temperatures, current time, count down timer times and event times
- ②⑧ **Timer and Room/Setpoint Temperature Indicator** (LM24W only)  
Displays the setpoint & current room temperatures and Filter countdown time.
- ②⑨ **AM Indicator** (LM7 / LM7-D only)
- ③① **PM Indicator** (LM7 / LM7-D only)
- ③① **Inside Room Temperature Indicator**  
Flashes to indicate current room temperature reading.
- ③② **Low Speed Fan Indicator**
- ③③ **Medium Speed Fan Indicator**
- ③④ **High Speed Fan Indicator**
- ③⑤ **Set Indicator**  
Illuminates during time and timeclock setting adjustments.
- ③⑥ **Degree Centigrade Indicator**  
Flashes to indicate current room temperature reading.
- ③⑦ **Run Indicator**  
Indicates the outdoor unit is in operation, flashes if on delay.
- ③⑧ **Auto Indicator**  
Indicates the system will automatically select heating or cooling operation.
- ③⑨ **Heating Operation Indicator**
- ④① **Cooling Operation Indicator**
- ④① **Filter Indicator**
- ④② **Continuous Indicator**  
Illuminates when fan is set to continuous mode of operation.
- ④③ **Lock Symbol**  
Shows during backlight adjustments and when Turning On/Off backlight.
- ④④ **1 & 2 Indicator** (LM7 / LM7-D only)  
Illuminates together with Event to show the programming event.

## LCD BACKLIGHT

LM7

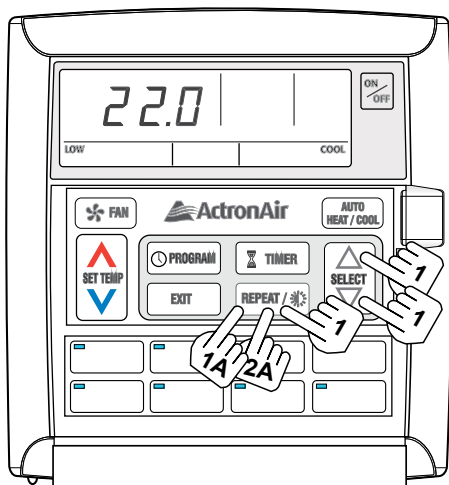

LM24W

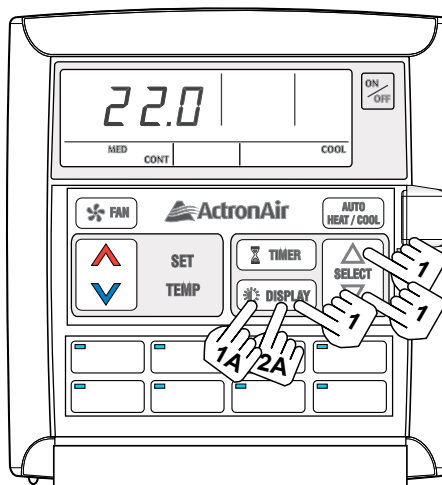

### LCD Backlight Level Adjustments

1

**Press and hold REPEAT (LM7) or DISPLAY (LM24W) Button. Then press SELECT UP  $\Delta$  / DOWN  $\nabla$  Arrow Button to adjust the backlight level, as follows:**

- To brighten backlight, press SELECT UP Button.
- To dim backlight, press SELECT DOWN Button.

Release the buttons at the desired level of LCD brightness and the LOCK symbol will appear for 1 second indicating the backlight level is set.

### Turn On/Off LCD Backlight

1A

**Turn On LCD Backlight.**

Press and hold REPEAT (LM7) or DISPLAY (LM24W) Button for 4 seconds. LOCK symbol will appear, then release button and backlight will remain On.

2A

**Turn Off LCD Backlight.**

Press and hold REPEAT (LM7) or DISPLAY (LM24W) Button for 4 seconds. LOCK symbol will appear, then release button and backlight will turn Off after 6 seconds.



## ON/OFF BUTTON LIGHT

LM7

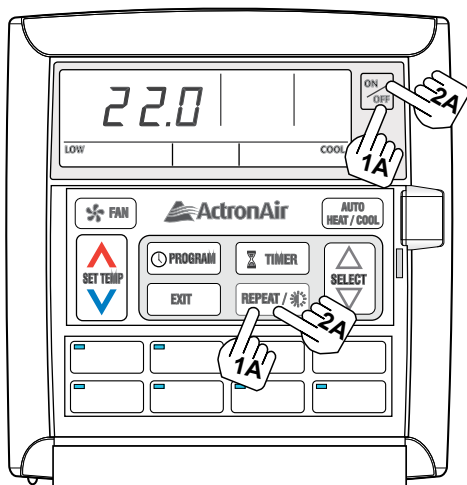

LM24W

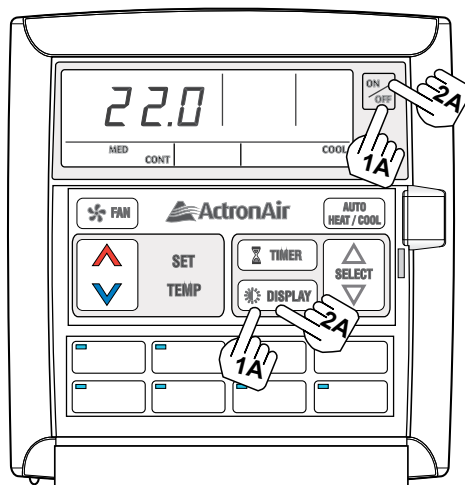

NOTE: The Wall Controller must be turned on before operating this procedure.

### Turn On the On/Off Button Light

- 1A** Press and hold **REPEAT** (LM7) or **DISPLAY** (LM24W) Button, press and release **ON/OFF** Button and then release **REPEAT** (LM7) or **DISPLAY** (LM24W) Button.

LOCK symbol will appear and the On/Off Button light will remain on.

### Turn Off the On/Off Button Light



- 2A** Press and hold **REPEAT** (LM7) or **DISPLAY** (LM24W) Button, press and release **ON/OFF** Button and then release **REPEAT** (LM7) or **DISPLAY** (LM24W) Button.

LOCK symbol will appear and the On/Off Button light will turn off after 6 seconds.

## COOLING OPERATION

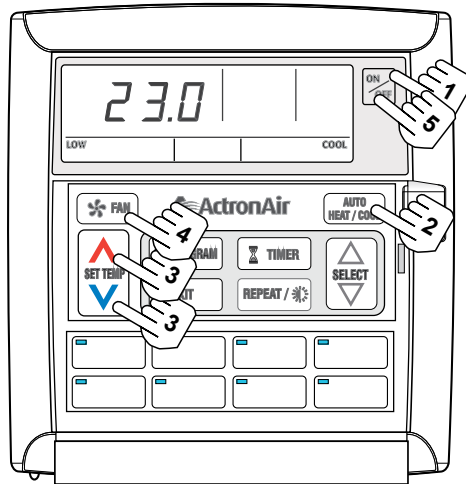
LM7



1	<b>Press ON/OFF Button.</b>
2	<b>Press the  Button until “COOL” appears on display.</b>
3	<p><b>Set the desired temperature by pressing either the SET TEMP UP  or DOWN  arrow key.</b></p> <ul style="list-style-type: none"> <li>• Maximum temperature setting 30.</li> <li>• Minimum temperature setting 16.</li> <li>• For a WARMER room temperature, press the UP arrow key.</li> <li>• For a COOLER room temperature, press the DOWN arrow key.</li> </ul>
4	<p><b>Adjust the desired fan speed by pressing the FAN Control Button.</b></p> <p>When your air conditioner is turned ON the indoor fan can run continuously and is indicated by the CONT indicator. This is generally preferred during the cooling mode to ensure maximum air circulation. However, during the heating mode this can create the effect of cool drafts. It then would be preferable to have the indoor fan, cycle On and Off automatically with the Outdoor Unit. This is selected by pressing the FAN button until the CONT indicator is Off.</p>



## OFF

- |   |   |
|---|---|
| 5 | <p><b>Press ON/OFF Button again.</b><br/>The system will retain your last setting until next operation.</p> |
|---|---|

# HEATING OPERATION

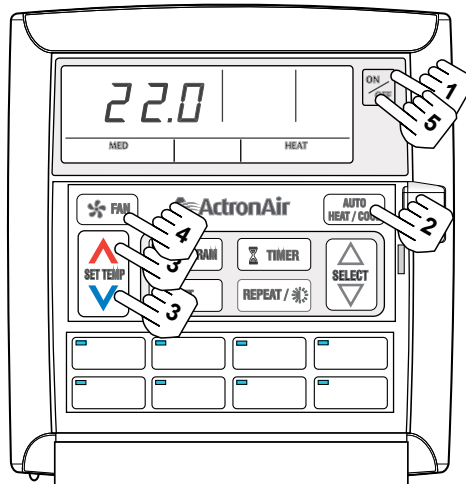
LM7



<b>1</b>	<b>Press ON/OFF Button.</b>
<b>2</b>	<b>Press the  Button until “HEAT” appears on display.</b>
<b>3</b>	<p><b>Set the desired temperature by pressing either the SET TEMP UP  or DOWN  arrow key.</b></p> <ul style="list-style-type: none"> <li>• Maximum temperature setting 30.</li> <li>• Minimum temperature setting 16.</li> <li>• For a WARMER room temperature, press the UP arrow key.</li> <li>• For a COOLER room temperature, press the DOWN arrow key.</li> </ul>
<b>4</b>	<p><b>Adjust the desired fan speed by pressing the FAN Control Button.</b></p> <p>When your air conditioner is turned ON the indoor fan can run continuously and is indicated by the CONT indicator. This is generally preferred during the cooling mode to ensure maximum air circulation. However, during the heating mode this can create the effect of cool drafts. It then would be preferable to have the indoor fan, cycle On and Off automatically with the Outdoor Unit. This is selected by pressing the FAN button until the CONT indicator is Off.</p>

## OFF

<b>5</b>	<p><b>Press ON/OFF Button again.</b></p> <p>The system will retain your last setting until next operation.</p>
----------	--

## AUTO OPERATION

Automatically changes between heating and cooling mode

LM7

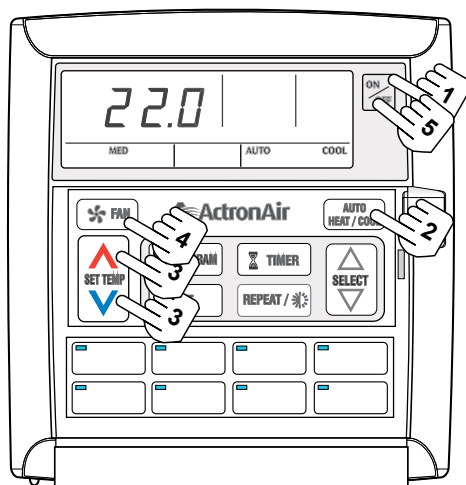

<b>1</b>	<b>Press ON/OFF Button.</b>
<b>2</b>	Press the  <b>Button</b> until “AUTO” appears on display.
<b>3</b>	<p><b>Set the desired temperature by pressing either the SET TEMP UP ▲ or DOWN ▼ arrow key.</b></p> <ul style="list-style-type: none"> <li>• Maximum temperature setting 30.</li> <li>• Minimum temperature setting 16.</li> <li>• For a WARMER room temperature, press the UP arrow key.</li> <li>• For a COOLER room temperature, press the DOWN arrow key.</li> </ul>
<b>4</b>	<p><b>Adjust the desired fan speed by pressing the FAN Control Button.</b></p> <p>When your air conditioner is turned ON the indoor fan can run continuously and is indicated by the CONT indicator. This is generally preferred during the cooling mode to ensure maximum air circulation. However, during the heating mode this can create the effect of cool drafts. It then would be preferable to have the indoor fan, cycle On and Off automatically with the Outdoor Unit. This is selected by pressing the FAN button until the CONT indicator is Off.</p>



## OFF

- |          |  |
|----------|--|
| <b>5</b> | <p><b>Press ON/OFF Button again.</b></p> <p>The system will retain your last setting until next operation.</p> |
|----------|--|

## FAN ONLY OPERATION

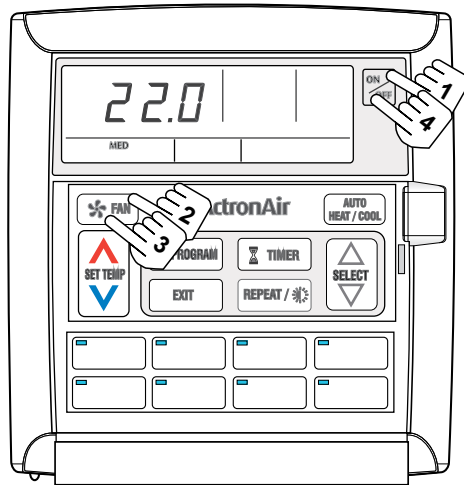
LM7



1	<b>Make sure the system is off.</b>
2	<b>Press the FAN  Button.</b>
3	<b>Adjust the fan speed by pressing the FAN  Button.</b>

## OFF

4	<b>Press ON/OFF button again.</b> The system will retain your last setting until next operation.
---	---

# ESP FAN FEATURE

Available for ESP Plus and ESP Ultima Models

## CIRCULATION OPERATION

FAN SPEED CYCLE:

HIGH = High air circulation.

MED = Normal air circulation.

LOW = Low air circulation.

ESP = Variable air circulation, varying fan speed will be determined by the controller automatically. This will depend on number of outlets or zones open in an installation.

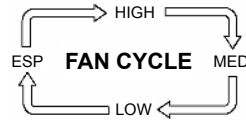

## WALL CONTROLLER DISPLAY

SPEED	SEGMENT INDICATOR			LCD DISPLAY
	HIGH	MED	LOW	
HIGH	ON			SET TEMP
MED		ON		SET TEMP
LOW			ON	SET TEMP
ESP	ON	ON	ON	ESP THEN SET TEMP

## CIRCULATION OPERATION

FAN SPEED CYCLE:

HIGH = High air circulation.

MED = Normal air circulation.

LOW = Low air circulation.

CONT HIGH = High air circulation, continuous run.

CONT MED = Normal air circulation, continuous run.

CONT LOW = Low air circulation, continuous run.

ESP = Variable air circulation, variable fan speed will be determined by the controller automatically. This will depend on number of outlets or zones open in an installation.

CONT ESP = Continuous variable air circulation, varying fan speed will be determined by the controller automatically. This will depend on number of outlets or zones open in an installation.



## WALL CONTROLLER DISPLAY



SPEED	SEGMENT INDICATOR				LCD DISPLAY
	HIGH	MED	LOW	CONT	
HIGH	ON				SET TEMP
MED		ON			SET TEMP
LOW			ON		SET TEMP
ESP	ON	ON	ON		ESP THEN SET TEMP
CONT HIGH	ON			ON	SET TEMP
CONT MED		ON		ON	SET TEMP
CONT LOW			ON	ON	SET TEMP
CONT ESP	ON	ON	ON	ON	ESP THEN SET TEMP

## TIMER OPERATION

OFF Timer  
Function

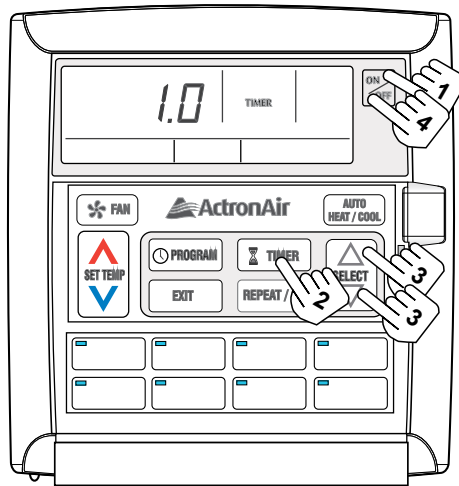
LM7



- |   |   |
|---|---|
| 1 | <b>Press the ON/OFF Button.</b><br>Make sure the system is running and the operating conditions are those desired.  |
| 2 | <b>Press the TIMER  Button.</b>  |
| 3 | <b>Set the desired hours for the system to turn OFF by pressing either the SELECT UP  or DOWN  arrow key.</b><br>The up/down arrow keys must be pressed whilst "Timer" is flashing.<br>The timer can be set from 0.5 hours to 24 hours. |

### Timer Cancellation

- |   |                                   |
|---|-----------------------------------|
| 4 | <b>Press ON/OFF Button again.</b> |
|---|-----------------------------------|

### Changing the Hours Set



- |   |                                  |
|---|----------------------------------|
| 5 | <b>Follow the steps 2 and 3.</b> |
|---|----------------------------------|

## TIMER OPERATION

### ON Timer Function

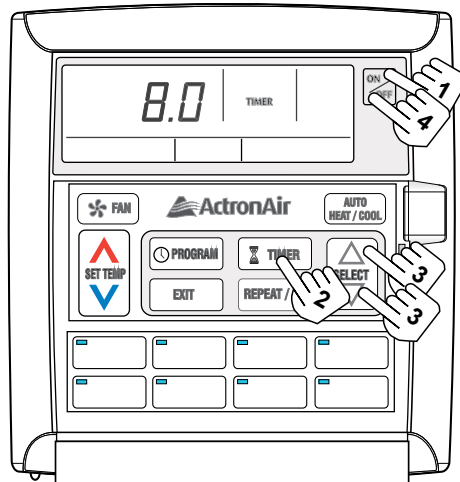
LM7



1	<b>Make sure the system is OFF.</b>
2	<b>Press the TIMER  Button.</b>
3	<b>Set the desired hours for the system to turn ON by pressing either the SELECT UP  / DOWN  Arrow key.</b> The up/down arrow keys must be pressed whilst “Timer” is flashing. The timer can be set from 0.5 hours to 24 hours.

### Timer Cancellation

4	<b>Press ON/OFF Button again.</b>
---	-----------------------------------

### Changing the Hours Set

5	<b>Follow the steps 2 and 3.</b>
---	----------------------------------

#### Notice

- When the air conditioner is started by the timer function, it will only start in Auto mode.
- Circulation mode cannot be turned ON by timer.



## 7-DAY PROGRAMMABLE MODEL

### Timeclock Operation

LM7

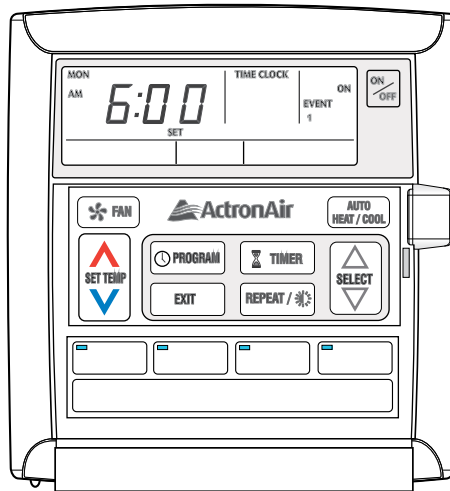

- The 7-Day timeclock feature on the controller allows you to set the air conditioner to turn ON and OFF at different times for each day of the week.
- Each day can have two programmed events.
- Each event has an ON and OFF time.

### Example of Typical Timeclock Set Up

		MON	TUE	WED	THU	FRI	SAT	SUN
EVENT 1	ON TIME	6:00am	6:00am	6:00am	6:00am	6:00am	7:00am	8:00am
	OFF TIME	10:00am	10:00am	10:00am	10:00am	10:00am	9:00am	11:00am
EVENT 2	ON TIME	4:00pm	4:00pm	4:00pm	4:00pm	1:00pm	-:--	-:--
	OFF TIME	10:00pm	10:00pm	10:00pm	10:00pm	11:00pm	-:--	-:--

### Cancelling an Individual Event



Go to the ON time for the event you wish to cancel and press the ON/OFF button. -:-- will be displayed indicating the event is cancelled.

## 7-DAY PROGRAMMABLE MODEL

### Setting the Time and Day

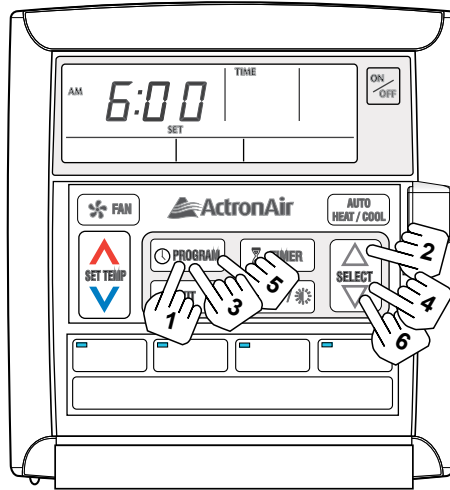
LM7



1	Press the “PROGRAM” button 3 times and “SET” will be illuminated with “TIME” flashing.
2	Adjust the “Hours” by using  buttons.
3	Press the “PROGRAM” button.
4	Adjust the “Minutes” by using  buttons.
5	Press the “PROGRAM” button.
6	Adjust the “Day” by using  buttons.

### Battery Backup

During a power failure, the clock retains the time and day via the backup battery inside the system.

## 7-DAY PROGRAMMABLE MODEL

Activating and  
De-activating the  
7-Day Timeclock

LM7

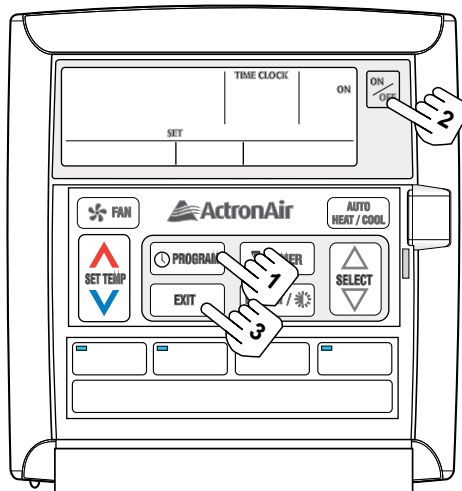

### Activating

1	Press the PROGRAM button twice.
2	Press ON/OFF until "ON" is flashing.
3	Press the EXIT button.
4	TIME CLOCK indicator should now be turned on.

### De-Activating

1	Press the PROGRAM button twice.
2	Press ON/OFF until "OFF" is flashing.
3	Press the EXIT button.
4	TIME CLOCK indicator should now be turned off.

## 7-DAY PROGRAMMABLE MODEL

### Programming the Events

LM7

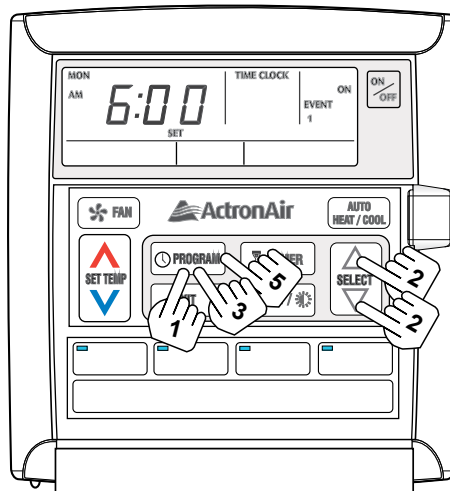

- |          |   |
|----------|---|
| <b>1</b> | <b>Press the PROGRAM button repeatedly until event 1 and “MON” is showing.</b><br>You are now setting MONDAY, event 1, ON time.   |
| <b>2</b> | Use the  buttons to adjust time.  |
| <b>3</b> | <b>Press the PROGRAM button to move to event 1 off time and follow step 2.</b>  |
| <b>4</b> | <b>Press the PROGRAM button to move to the next event.</b><br>The event time is entered once you press the PROGRAM button.<br>If you press the EXIT button before moving to the next event, the time you have programmed will not be entered. |
| <b>5</b> | <b>Repeat the above steps until you have programmed all the events you require.</b>   |

### Programming Past Midnight

- |          |   |
|----------|---|
| <b>1</b> | <b>Event On times can be set to 11:45 PM of the current day.</b>    |
| <b>2</b> | <b>Event Off times can be set to 9:00 AM the following morning.</b> |

#### Notice

- If you program event 1 past midnight, event 2 will be automatically cancelled.

## 7-DAY PROGRAMMABLE MODEL

### Canceling an Individual Event

LM7

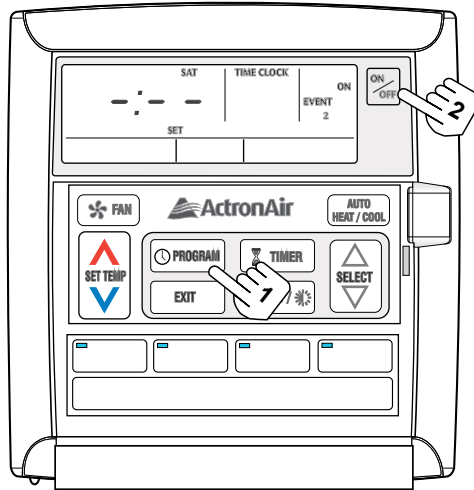

1	Press the <b>PROGRAM</b> button repeatedly until the “ON” time for the event you wish to cancel is displayed.
2	Press the <b>ON/OFF</b> button.
3	- :- - will be displayed indicating the event is cancelled.
4	Repeat the above steps until you have cancelled all the desired events.
5	See 7-Day timeclock operation for programming sequence. Page 16.

### Re-Activate an Event

1	Repeat steps 1 & 2 as above.
2	Press the <b>ON/OFF</b> button until the time re-appears.

## 7-DAY PROGRAMMABLE MODEL

### Repeating a Days Events & Times

LM7

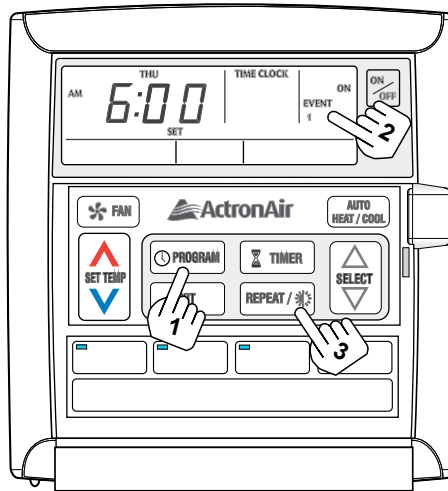

This feature allows you to automatically repeat the previous days, events and times, therefore eliminating the need to re-enter the events and times.

<b>1</b>	<b>Go to the day you wish to copy and program your events and times.</b> See "Programming the Events" page 19.
<b>2</b>	<b>Press PROGRAM button until the following days, event 1, ON time is displayed.</b> Display shows "SET", "EVENT", "1", "TIMECLOCK" and "ON".
<b>3</b>	<b>Press the REPEAT button.</b> You have now copied the previous days events into the current day displayed.
<b>4</b>	<b>Repeat steps 2 and 3 for the remaining days.</b>

## ZONE CONTROLLER FUNCTIONS

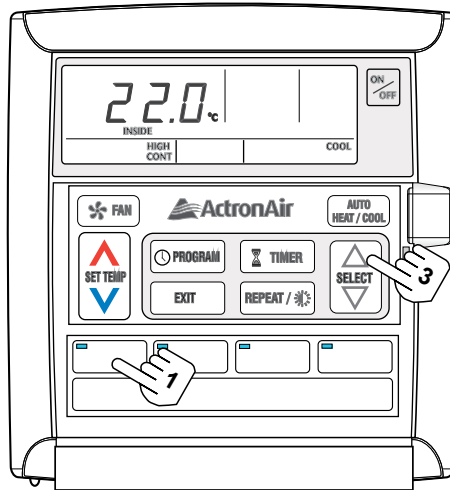

### Turning Zones ON & OFF

- 1 Press the Zone Button to turn zones on & off.**
- 2 Lights are illuminated when zone is turned on.**

#### Notice

- By default, the minimum of one zone must be left ON. This is controlled automatically by the wall control and will not allow you to turn off the last zone operating. However, it is possible to turn OFF all zones in some models. Contact your installer for more details.
- Switching the last zone off will cause the controller to divert to Zone 1 automatically.

### Room Temperature Display

- 3 Press SELECT Up  $\Delta$  or Down  $\nabla$  Arrow Button and the room temperature will be displayed for 3 seconds.**

#### Notice

- The room temperature displayed can be the temperature at the wall controls or remote wall sensors or a combination of both, depending on which zones are turned on.

# DUAL WALL CONTROLLER OPERATION

## MIMIC CONTROL

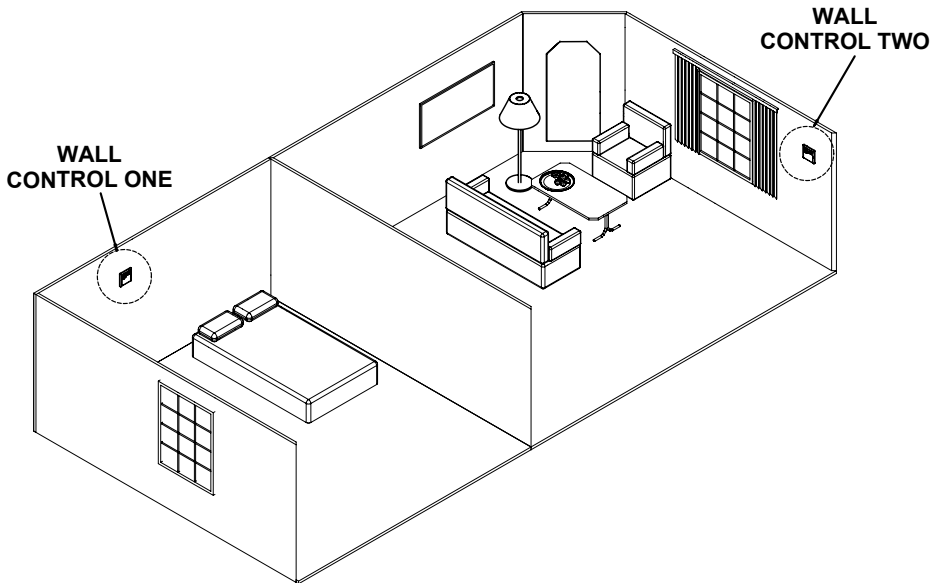

- The air conditioner can be operated from either wall controller.
- Information displayed on the two wall controllers is identical.
- Last wall controller used has priority.

### Eg. 1

Using wall controller one, the cooling operation is started, both wall controllers will now show the system is in cooling mode. If another person uses wall controller two to select heating operation, the system will now change to the heating operation and both wall controllers will display the system is in heating operation.

### Eg. 2

Using wall controller two, the circulation operation is selected, both wall controllers will now show the system in circulation mode. If another person uses wall controller two to select cooling operation, the system will now change to the cooling operation and both wall controllers will display the system is in cooling operation.



## SETTING THE UPPER & LOWER TEMPERATURE LIMITS

This feature allows you to set the upper and lower temperature limits on your wall control.

This can be used in a variety of ways.

1. You may want the maximum set-temp limited to 25°C and the minimum set-temp to 20°C, thus stopping anyone from setting the temperature too high or too low.
2. You may want to lock the set-temp to 22°C to stop anyone else adjusting the set-temp up and down. To do this, simply adjust the upper and lower limit until they are the same.

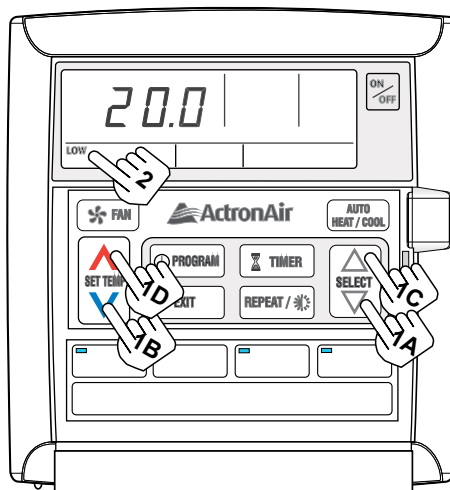

**Default Upper and Lower Limits = Upper (30°C), Lower (16°C)**

It is recommended not to adjust the upper and lower limits outside the defaults above. Doing so, may cause damage to your system and void warranty.

**Adjustable limits: Upper = 10°C to 32°C Lower = 10°C to 32°C**

NOTE: The unit must be turned off before operating this procedure.

### Setting the Lower Limit

1	Press the <b>SELECT DOWN</b> ▽ (1A) button, then press <b>SET TEMP DOWN</b> ▼ (1B) button. You must press the two buttons in quick succession.
2	The display will now show the “Lower” limit for 3 seconds and this is confirmed by “LOW” indicator also being turned on.
3	While the “Lower limit” is displayed, use the <b>SET-TEMP ARROW</b> buttons to adjust up or down.
4	After 5 seconds the Lower limit will be automatically accepted.

### Setting the Upper Limit

1	Press the <b>SELECT UP</b> △ (1C) button, then press <b>SET TEMP UP</b> ▲ (1D) button. You must press the two buttons in quick succession.
2	The display will now show the “Upper” limit for 3 seconds and this is confirmed by “HIGH” indicator also being turned on.
3	While the “Upper limit” is displayed, use the <b>SET-TEMP ARROW</b> buttons to adjust up or down.
4	After 5 seconds the Upper limit will be automatically accepted.

#### Notice

- You cannot adjust the upper limit below your current set-temperature.
- You cannot adjust the lower limit above your current set-temperature.

## OPERATING TIPS FOR SUMMER

- |          |   |
|----------|---|
| <b>1</b> | <b>Always test run your air conditioner a few weeks before the start of summer and make sure it's cooling sufficiently.</b><br>If the air conditioner needs servicing, it's advised you have this done before the summer season arrives.  |
| <b>2</b> | <b>A HOT day is forecast for tomorrow, what should you do?</b><br>Always start the air conditioner early in the morning and keep the house/office cool. If you try and start the air conditioner in the afternoon when the house/office is already very hot, it may take a while to cool down.<br><br>Keep all curtains and windows closed. Also stop drafts coming in from your front & back doors.<br><br>If you have zones, turn off any you are not using and close doors to these areas, this will give you more cooling capacity in the areas you need.<br><br>Ask your installer on the minimum zones you should use on your system. |

### Notice

Always allow the necessary amount of fresh air into rooms.

## OPERATING TIPS FOR WINTER

<b>1</b>	<b>Always test run your air conditioner a few weeks before the start of summer and make sure it's cooling sufficiently.</b> If the air conditioner needs servicing, it's advised you have this done before the summer season arrives.
<b>2</b>	<b>A COLD day is forecast for tomorrow, what should you do?</b>  You can leave air conditioner running overnight, but lower the set point 2-4°C from your normal setting to help save electricity. This will prevent the house/office from becoming too cold overnight and thus enabling the air conditioner to warm the house/office quicker when you raise the temperature set point back to your usual setting. OR Start the air conditioner a couple of hours earlier than you normally would in the morning.  If outside conditions are very cold (approx. 7°C or lower) supplementary heating may be used such as electric or gas heaters to complement & speed the heating up.  Keep all curtains and windows closed. Also stop drafts coming in from your front & back doors.  If you have zones, turn off any you are not using and close doors to these areas, as this will give you more heating capacity in the areas you need.  Ask your installer on the minimum zones you should use on your system.

### Notice

Always allow the necessary amount of fresh air into rooms.

## ENERGY CONSERVATION TIPS

- 1** For the most efficient operation, keep the windows and doors closed including unused areas where possible. They not only help to insulate against heat and cold, they also reduce dust, pollen and noise.
- Occasionally allow fresh air into rooms and offices that are closed off.
- Should you wish to leave your air conditioner on over night during the winter. Set your thermostat down by 2°C to 4°C when going to bed and reset to your normal setting upon arising, as there is no reason to pay for extra electricity when you are under the blankets. This can also apply during the summer nights and therefore raise the temperature by 2°C to 4°C.
- On days when extreme conditions of High or Low temperatures prevail and the home is unoccupied, it can be practical to leave the air conditioner ON. However to reduce energy costs, set the temperature up 2°C to 4°C (Cool Mode) for summer and down 2°C to 4°C (Heat Mode) for winter and reset to your normal setting upon returning. This will provide a more comfortable situation and reduce the high heat load as the Air Conditioner not only has to cool or heat the air, it also has to cool and heat the furniture, walls, floors and ceilings.
- The normal setting recommended is 22°C for both summer and winter.
- By raising the set point by 1°C in summer or lowering the set point by 1°C in winter can save approx. 10% on electricity costs.

## ZONING

- 2** If your air conditioner has zones fitted, always turn off the zones you aren't using as this will save energy by the air conditioner not having to operate as long.

## MAINTENANCE

### Wall Controller

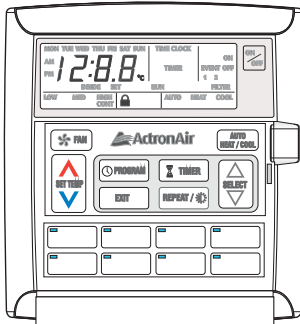

Wipe the controller with a dry cloth.  
Do not use water.

### Outlets and Return Air

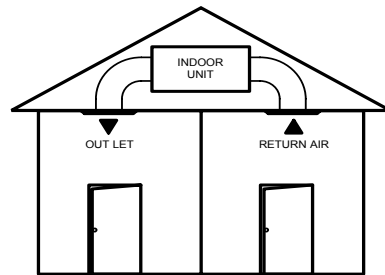

Dust off the outlets and return air, use a household duster. Do this regularly to prevent any build up of dust or dirt.

### Air Filter Cleaning

Clean every 4 weeks or when the filter light is displayed on wall control.

#### 1. Open the inlet grille.

Caution, dust may fall from return air grille.

#### 2. Remove the filter by sliding it out from the grille.

#### 3. Clean the filter

Using a vacuum cleaner to remove the dust or wash the filter with water.

Be gentle when cleaning the filter to avoid tearing the filter material.

#### 4. Replace filter.

### Notice

- When the filter light is illuminated, check the air filter and clean if necessary and press the ON/OFF button to extinguish filter light.
- Always check with your installer for the proper care and maintenance of the filter system.

#### 1. Do not obstruct airflow.



#### 2. Keep grass or plants away from the unit. This will ensure your air conditioner operates efficiently.

Regular servicing of equipment by a qualified technician is recommended every 12 months for residential applications and every quarter for commercial applications.

## TROUBLE SHOOTING

CONDITION	CAUSES OR CHECK POINTS
<b>The system does not start.</b>	<ul style="list-style-type: none"> <li>• Check that 5 minutes has passed from turn on time, as the system has inbuilt safety timers.</li> <li>• Check thermostat settings are correct.</li> <li>• Check the thermostat “set-point” is set low enough for cooling or high enough for heating.</li> </ul>
<b>Air does not flow. (Indoor Unit)</b>	<ul style="list-style-type: none"> <li>• Check Zones are switched on. (where fitted)</li> <li>• During heating operation, air does not flow out for approx. 15 seconds after start up, this prevents cold drafts.</li> <li>• During the defrost of the outdoor unit in heating operation, the indoor fan will not operate for several minutes, this is to prevent cold air being blown into rooms.</li> </ul>
<b>Cooling/Heating is not sufficient.</b>	<ul style="list-style-type: none"> <li>• The cooling/heating function may not work effectively when the “return air filter” is clogged with dust and dirt.</li> <li>• Make sure the air inlet and air outlet on the outdoor unit are not blocked.</li> <li>• The outside temperature is above or below the design conditions.</li> </ul>
<b>Steam from outdoor unit.</b>	<ul style="list-style-type: none"> <li>• It is caused by the defrosting of the outdoor unit in heating operation in cold conditions.</li> </ul>
<b>Water from outdoor unit.</b>	<ul style="list-style-type: none"> <li>• This is normal during heating operation, it is due to water forming on the heat exchanger.</li> </ul>
<b>Occurring of noises</b>	<ul style="list-style-type: none"> <li>• When heating or cooling is started or stopped, a swishing or gurgling noise may be heard. This noise is generated by the refrigerant flowing between the outdoor and indoor units.</li> <li>• A whooshing noise may be heard from the outdoor unit during operation. This noise is generated when the refrigerant changes direction in the defrost operation.</li> <li>• On start up, the outdoor unit may be louder than normal for a few seconds whilst the compressor reaches the designated speed and operating pressure.</li> <li>• During defrost operation the compressor may generate more noise than normal.</li> </ul>
<b>Fault Codes</b>	<ul style="list-style-type: none"> <li>• When EXX is displayed on the wall controller, take note of the digits after E and contact your installer.</li> </ul>

**Before contacting your installer, please have your air conditioners Model No. and Serial No. with you. (See page 2)**

## TROUBLE SHOOTING

<b>CONDITION</b>	
<b>Set-temp can't be adjusted.</b>	<ul style="list-style-type: none"> <li>• Check your wall control set-temp limits are not being exceeded.</li> <li>• Check the upper and lower temperature are set correctly. (see page 24)</li> </ul>
<b>7-day timeclock is not turning the air conditioner on and off.</b> <small>(7-Day programmable model only)</small>	<ul style="list-style-type: none"> <li>• Check the timeclock is activated. (see page 18)</li> </ul>
<b>7-day timeclock is not accepting times you enter.</b> <small>(7-Day programmable model only)</small>	<ul style="list-style-type: none"> <li>• Check you don't have times overlapping from another day.</li> <li>• Make sure your not trying to set the time past the maximum allowable. (see programming past midnight page 19)</li> </ul>
<p><b>Before contacting your installer, please have your air conditioners Model No. and Serial No. with you. (See page 2)</b></p>	

## Re-Setting the Wall Control

<b>Re-Setting all functions for LM7 &amp; LM24W</b>	
<b>Note: This does not reset the 7-day timeclock features on the LM7 wall controller.</b>	
<b>1</b>	Make sure the air conditioner is in the OFF position.
<b>2</b>	Press and hold down FAN, press and release SET TEMP DOWN, press and release ON/OFF and then release FAN  All the display indicators will flash, with the ON/OFF indicators flashing for a further 20 seconds. The wall control is now reset to the original factory settings.

<b>Re-Setting the timeclock (7-Day programmable model only)</b>	
<b>Note: This will reset all the 7-Day timeclock programs.</b>	
<b>1</b>	Make sure the wall controller is in the OFF position.
<b>2</b>	Press and release "PROGRAM" button, then press and hold ON/OFF button for 3 seconds.
<b>3</b>	All the display indicators will light up for approximately 1 second and then all timeclock programs have been re-set to the original factory settings.



**1800 119 229**  
**[www.actronair.com.au](http://www.actronair.com.au)**



---

**Actron Engineering Pty Ltd**  
ABN 34 002 767 240  
HEAD OFFICE SYDNEY AUSTRALIA  
Copyright © 2015 Actron Engineering Pty. Ltd.

Printed in Australia  
Part No. 0500-121  
Version No. 4.0 141125