



ETA-Danmark A/S  
Göteborg Plads 1  
DK-2150 Nordhavn  
Tel. +45 72 24 59 00  
Fax +45 72 24 59 04  
Internet www.etadanmark.dk

Authorised and notified according  
to Article 29 of the Regulation (EU)  
No 305/2011 of the European  
Parliament and of the Council of 9  
March 2011

MEMBER OF EOTA



## European Technical Assessment ETA-18/0101 of 2025/07/03

### I General Part

**Technical Assessment Body issuing the ETA and designated according to Article 29 of the Regulation (EU) No 305/2011:** ETA-Danmark A/S

**Trade name of the construction product:**

fischer Bolt Anchor FBN II HDG Torque controlled expansion anchor

**Product family to which the above construction product belongs:**

Mechanical fasteners of sizes M8, M10, M12, M16 and M20 for use in uncracked concrete

**Manufacturer:**

fischerwerke GmbH & Co. KG  
Klaus-Fischer-Straße 1  
D-72178 Waldachtal

**Manufacturing plant:**

fischerwerke

**This European Technical Assessment contains:**

15 pages including 10 annexes which form an integral part of the document

**This European Technical Assessment is issued in accordance with Regulation (EU) No 305/2011, on the basis of:**

European Assessment Document (EAD) No. EAD 330232-01-0601-v01; Mechanical fasteners for use in concrete.

**This version replaces:**

The ETA with the same number issued on 2018-07-16

Translations of this European Technical Assessment in other languages shall fully correspond to the original issued document and should be identified as such.

Communication of this European Technical Assessment, including transmission by electronic means, shall be in full (except the confidential Annexes referred to above). However, partial reproduction may be made, with the written consent of the issuing Technical Assessment Body. Any partial reproduction has to be identified as such.

## **II SPECIFIC PART OF THE EUROPEAN TECHNICAL ASSESSMENT**

### **1 Technical description of product**

The Fischer Bolt anchor FBN II HDG is an anchor made of zinc plated, hot-dip galvanised steel which is placed into a drilled hole and anchored by torque controlled expansion. The thickness of the corrosion protection layer is minimum 40 µm with a batch average of minimum 50 µm

Product and product description is given in Annex A.

The characteristic material values, dimensions and tolerances of the anchors not indicated in Annexes shall correspond to the respective values laid down in the technical documentation of this European Technical Assessment.

The anchors are intended to be used with embedment depth given in Annex B, Table B4.1. The intended use specifications of the product are detailed in Annex B1.

### **2 Specification of the intended use(s) in accordance with the applicable European Assessment Document (hereinafter EAD)**

The performances given in Section 3 are only valid if the anchor is used in compliance with the specifications and conditions given in Annex B.

The provisions made in this European Technical Assessment are based on an assumed intended working life of the anchor as given in Annex B depending on the corrosion protection.

The indications given on the working life cannot be interpreted as a guarantee given by the producer or Assessment Body, but are to be regarded only as a means for choosing the right products in relation to the expected economically reasonable working life of the works.

### **3 Performance of the product and references to the methods used for its assessment**

#### **3.1 Characteristics of product**

##### **Mechanical resistance and stability (BWR 1):**

The essential characteristics are detailed in the Annex from C1 to C2.

##### **Safety in case of fire (BWR 2):**

No Performance assessed.

#### **3.2 Methods of assessment**

The assessment of fitness of the anchor for the intended use in relation to the requirements for mechanical resistance and stability and safety in use in the sense of the Basic Works Requirements 1 and 4 has been made in accordance with EAD 330232-01-0601-v01; Mechanical fasteners for use in concrete.

#### **4 Assessment and verification of constancy of performance (hereinafter AVCP) system applied, with reference to its legal base**

##### **4.1 AVCP system**

According to the decision 1996/582/EC of the European Commission, the system(s) of assessment and verification of constancy of performance (see Annex V to Regulation (EU) No 305/2011) is 1.

#### **5 Technical details necessary for the implementation of the AVCP system, as provided for in the applicable EAD**

Technical details necessary for the implementation of the AVCP system are laid down in the control plan deposited at ETA-Danmark prior to CE marking

Issued in Copenhagen on 2025-07-03 by



Thomas Bruun  
Managing Director, ETA-Danmark

Cone bolt manufactured by cold - forming:

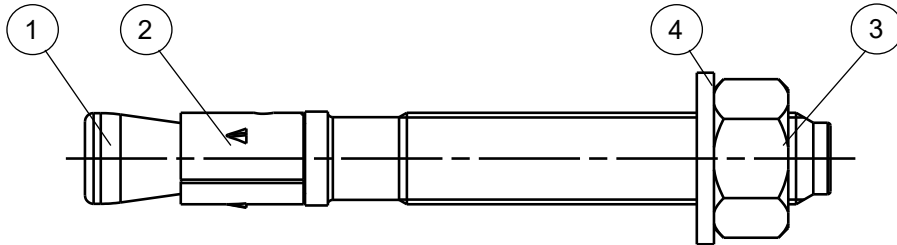

Cone bolt manufactured by turning:

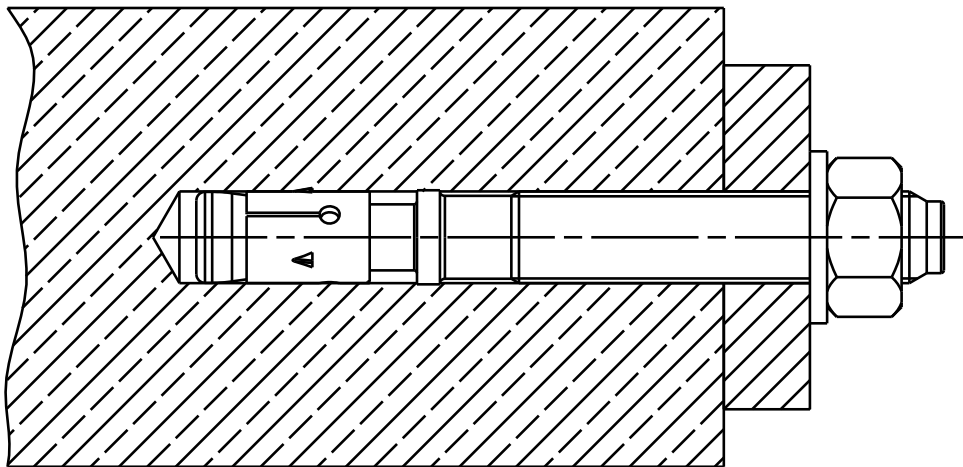
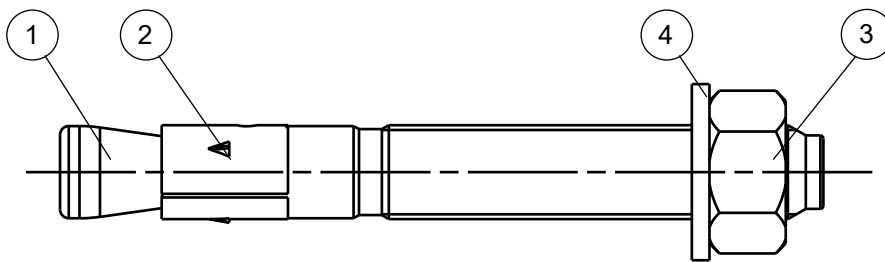

- ① Cone bolt (cold – formed or turned)
- ② Expansion sleeve
- ③ Hexagon nut
- ④ Washer

*(Fig. not to scale)*

fischer Bolt Anchor hot-dip galvanised FBN II HDG

**Product description**  
Installed condition

**Annex A1**  
of European  
Technical Assessment  
ETA-XX/YYYY

**FBN II HDG for use with standard and reduced embedment depth ( $h_{ef, sta}$  and  $h_{ef, red}$ )**

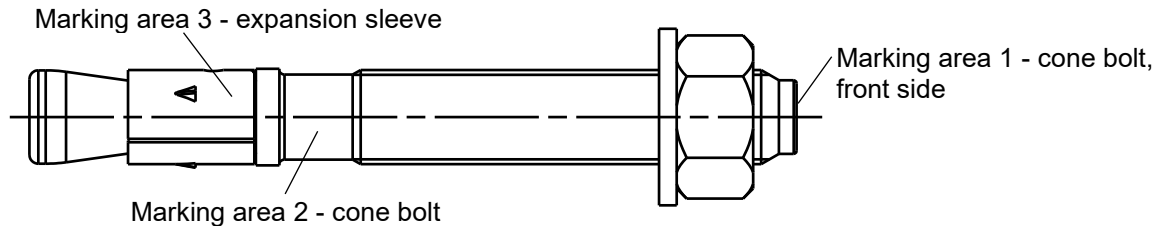

Product label, example:

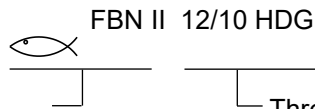

Brand | type of fastener placed at marking area 2 or marking area 3

Thread Size / max. thickness of fixture ( $t_{fix}$ ) for  $h_{ef, sta}$  placed at marking area 2

**Table A2.1:** Letter-code on marking area 1 and maximum thickness of fixture  $t_{fix}$

Marking		A	B	C	D	E	F	G	H	I	K	L	M	N	O	P	R	S	T	U	V	W	X	Y	Z
Max. $t_{fix}$ for $h_{ef, sta}$	M8-M20	5	10	15	20	25	30	35	40	45	50	60	70	80	90	100	120	140	160	180	200	250	300	350	400
Max. $t_{fix}$ for $h_{ef, red}$	M8, M10	15	20	25	30	35	40	45	50	55	60	70	80	90	100	110	130	150	170	190	210	260	310	360	410
	M12, M16	20	25	30	35	40	45	50	55	60	65	75	85	95	105	115	135	155	175	195	215	265	315	365	415
	M20	30	35	40	45	50	55	60	65	70	75	85	95	105	115	125	145	165	185	205	225	275	325	375	425

**FBN II K HDG for use with reduced embedment depth only ( $h_{ef, red}$ ):**

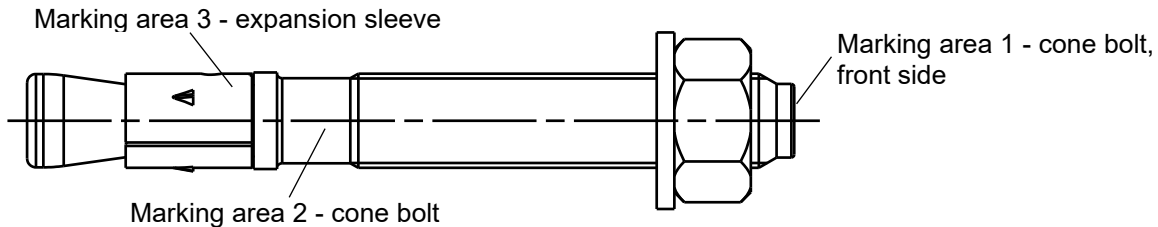

Product label, example:

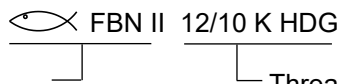

Brand | type of fastener placed at marking area 2 or marking area 3

Thread Size / max. thickness of fixture ( $t_{fix}$ ) identification K for  $h_{ef, red}$  placed at marking area 2

**Table A2.2:** Letter-code on marking area 1 and maximum thickness of fixture  $t_{fix}$

Marking		-A-	-B-	-C-	-D-	-E-	-F-	-G-	-H-	-I-	-K-	-L-	-M-	-N-	-O-	-P-	-R-	-S-	-T-	-U-	-V-	-W-	-X-	-Y-	-Z-
Max. $t_{fix}$ for $h_{ef, red}$	M8-M20	5	10	15	20	25	30	35	40	45	50	60	70	80	90	100	120	140	160	180	200	250	300	350	400

(Fig. not to scale)

fischer Bolt Anchor hot-dip galvanised FBN II HDG	<b>Annex A2</b> of European Technical Assessment ETA-XX/YYYY
<b>Product description</b> Anchor types	

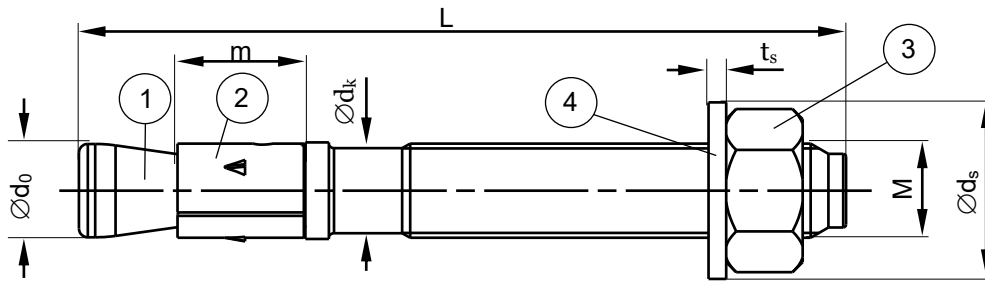

**Table A3.1:** Anchor dimensions [mm]

Part	Designation	M8	M10	M12	M16	M20	
1	Cone bolt	$\varnothing d_0$	7,9	9,9	11,9	15,9	19,6
		$\varnothing d_k$	7,1	8,9	10,8	14,5	18,2
		$L_{min} \geq$	56	71	86	120	139
		$L_{max} \leq$	261	316	396	520	654
2	Expansion sleeve	$m$	11,5	13,5	16,5	21,5	33,5
3	Hexagon nut	Wrench Size	13	17	19	24	30
4	Washer	$t_s \geq$	1,4	1,8	2,3	2,7	2,7
		$\varnothing d_s \geq$	15	19	23	29	36

**Table A3.2:** Materials

Part	Designation	Material
1	Cone bolt	Cold form steel or free cutting steel <sup>1)</sup>
2	Expansion sleeve	Stainless steel acc. to EN 10088-1:2023
3	Hexagon nut	Steel, property class 8 <sup>1)</sup>
4	Washer	Cold strip <sup>1) 2)</sup>

<sup>1)</sup> Hot-dip galvanised  $\geq 50 \mu\text{m}$ , according to EN ISO 10684:2004+AC:2009

<sup>2)</sup> Alternative mechanical plated  $\geq 53 \mu\text{m}$ , according to EN ISO 12683:2004

(Fig. not to scale)

fischer Bolt Anchor hot-dip galvanised FBN II HDG

**Product description**  
Anchor dimensions  
Materials

**Annex A3**  
of European  
Technical Assessment  
ETA-XX/YYYY



**Specifications of intended use**

fischer Bolt Anchor hot-dip galvanised FBN II HDG	M8	M10	M12	M16	M20
Static and quasi-static loads			✓		
Standard embedment depth			✓		
Reduced embedment depth			✓		
Uncracked concrete			✓		

**Base materials:**

- Normal weight concrete (uncracked) according to EN 206:2013+A2:2021
- Strength classes C20/25 to C50/60 according to EN 206:2013+A2:2021

**Use conditions (Environmental conditions):**

- Structures subject to dry internal conditions and to external atmospheric Classification of atmospheric corrosivity, determination and estimation C1 – CX according to EAD 330232-01-0601-v01

**Design:**

- Anchorages are to be designed under the responsibility of an engineer experienced in anchorages and concrete work
- Verifiable calculation notes and drawings are to be prepared taking account of the loads to be anchored. The position of the anchor is indicated on the design drawings (e.g. position of the anchor relative to reinforcement or to supports, etc.)
- Design of fastenings according to EN 1992-4:2018

**Installation:**

- Anchor installation carried out by appropriately qualified personnel and under the supervision of the person responsible for technical matters of the site
- Hammer or hollow drilling according to Annex B5

**Durability:**

- Variable working life according to EAD 330232-01-0601-v01

**Table B1.1:** Durability of hot dip galvanised **coatings** according to EN ISO 10684:2004+AC:2009 for coatings with mean thickness of minimum 50 µm

Corrosivity category	Corrosivity	Durability
		Thickness according to EN ISO 10684:2004+AC:2009 chapter 8.3 $\geq 50\mu\text{m}$ in average Durability [years]
C1	Very low	50 <sup>1)</sup>
C2	Low	50 <sup>1)</sup>
C3	Medium	25
C4	High	12,5
C5	Very high	5
CX	Extreme	2

<sup>1)</sup> Durability of coating thickness. Working life of fastener according to EAD 330232-01-0601-v01 section 1.2.2 (limited to 50 years)

fischer Bolt Anchor hot-dip galvanised FBN II HDG	<b>Annex B1</b> of European Technical Assessment ETA-XX/YYYY
<b>Intended use</b> Specification	

**Table B2.1** Description of typical atmospheric environments **indoor** related to the estimation of corrosivity categories according to ISO 9223:2012 Table C.1 and the corresponding durability categories according to EAD 330232-01-0601-v01 chapter 2.2.20 a (1) – (2)

Corrosivity category	Corrosivity	Typical environments – Examples	
		<b>Indoor</b>	EAD-330232 chapter 2.2.20 a
C1	Very low	Heated spaces with low relative humidity and insignificant pollution, e.g. offices, schools, museums	(1)
C2	Low	Unheated spaces with varying temperature and relative humidity. Low frequency of condensation and low pollution, e.g. storage, sport halls	(1)
C3	Medium	Spaces with moderate frequency of condensation and moderate pollution from production process, e.g. food-processing plants, laundries, breweries, dairies	(2)
C4	High	Spaces with high frequency of condensation and high pollution from production process, e.g. industrial processing plants, swimming pools	(2)
C5	Very high	Spaces with very high frequency of condensation and/or high pollution from production process, e.g. mines, caverns for industrial purposes, unventilated sheds in subtropical and tropical zones	(2)
CX	Extreme	Spaces with almost permanent condensation or extensive periods of exposure to extreme humidity effects and/or high pollution from production process, e.g. unventilated sheds in humid tropical zones with penetration of outdoor pollution including airborne chlorides and corrosion-stimulating particulate matter	(2)

fischer Bolt Anchor hot-dip galvanised FBN II HDG

**Intended use**  
Specification

**Annex B2**  
of European  
Technical Assessment  
ETA-XX/YYYY

**Table B3.1** Description of typical atmospheric environments **outdoor** related to the estimation of corrosivity categories according to ISO 9223:2012 Table C.1 and the corresponding durability categories according to EAD 330232-01-0601-v01 chapter 2.2.20 a (1) – (2)

Corrosivity category	Corrosivity	Typical environments – Examples	
		<b>Outdoor</b>	EAD-330232 chapter 2.2.20 a
C1	Very low	Dry or cold zone, atmospheric environment with very low pollution and time of wetness, e.g. certain deserts, Central Arctic/Antarctica	(2)
C2	Low	Temperate zone, atmospheric environment with low pollution ( $\text{SO}_2 < 5 \mu\text{g}/\text{m}^3$ ), e.g. rural areas, small towns Dry or cold zone, atmospheric environment with short time of wetness, e.g. deserts, subarctic areas	(2)
C3	Medium	Temperate zone, atmospheric environment with medium pollution ( $\text{SO}_2: 5 \mu\text{g}/\text{m}^3$ to $30 \mu\text{g}/\text{m}^3$ ) or some effect of chlorides, e.g. urban areas, coastal areas with low deposition of chlorides Subtropical and tropical zone, atmosphere with low pollution	(2)
C4	High	Temperate zone, atmospheric environment with high pollution ( $\text{SO}_2: 30 \mu\text{g}/\text{m}^3$ to $90 \mu\text{g}/\text{m}^3$ ) or substantial effect of chlorides, e.g. polluted urban areas, industrial areas, coastal areas without spray of salt water or, exposure to strong effect of de-icing salts Subtropical and tropical zone, atmosphere with medium pollution	(2)
C5	Very high	Temperate and subtropical zone, atmospheric environment with very high pollution ( $\text{SO}_2: 90 \mu\text{g}/\text{m}^3$ to $250 \mu\text{g}/\text{m}^3$ ) and/or significant effect of chlorides, e.g. industrial areas, coastal areas, sheltered positions on coastline	(2)
CX	Extreme	Subtropical and tropical zone (very high time of wetness), atmospheric environment with very high $\text{SO}_2$ pollution (higher than $250 \mu\text{g}/\text{m}^3$ ) including accompanying and production factors and/or strong effect of chlorides, e.g. extreme industrial areas, coastal and offshore areas, occasional contact with salt spray	(2)

fischer Bolt Anchor hot-dip galvanised FBN II HDG

**Intended use**  
Specification

**Annex B3**  
of European  
Technical Assessment  
ETA-XX/YYYY

**Table B4.1:** Installation parameters

Size	M8	M10	M12	M16	M20
Nominal drill hole diameter $d_0$	8	10	12	16	20
Maximum diameter of drill bit $d_{cut} \leq$	8,45	10,45	12,5	16,5	20,55
Effective embedment depth $h_{ef} \geq$ [mm]	40 (30 <sup>1)</sup> 2 <sup>2)</sup> )	50 (40 <sup>1)</sup> )	65 (50 <sup>1)</sup> )	80 (65 <sup>1)</sup> )	105 (80 <sup>1)</sup> )
Depth of drill hole to deepest point $h_1 \geq$	56 (46 <sup>1)</sup> 2 <sup>2)</sup> )	68 (58 <sup>1)</sup> )	85 (70 <sup>1)</sup> )	104 (89 <sup>1)</sup> )	135 (110 <sup>1)</sup> )
Diameter of clearance hole in the fixture $d_f \leq$	9	12	14	18	22
Required setting torque $T_{inst}$ [Nm]	15	30	40	70	200

<sup>1)</sup> Only for reduced embedment depth

<sup>2)</sup> Use restricted to anchoring of structural components which are statically indeterminate

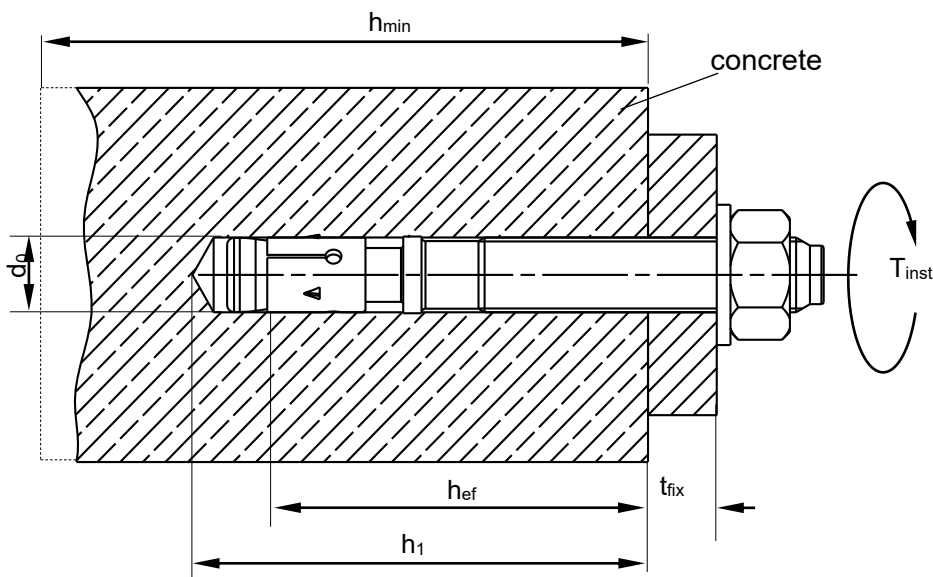

- $h_{ef}$  = Effective embedment depth
- $t_{fix}$  = Thickness of fixture
- $h_1$  = Depth of drill hole to deepest point
- $h_{min}$  = Minimum thickness of concrete member
- $T_{inst}$  = Required setting torque
- $d_0$  = Nominal drill hole diameter

(Fig. not to scale)

fischer Bolt Anchor hot-dip galvanised FBN II HDG	<b>Annex B4</b> of European Technical Assessment ETA-XX/YYYY
<b>Intended use</b> Installation parameters	

**Table B5.1:** Minimum thickness of concrete members, minimum spacing and minimum edge distance

Size		M8	M10	M12	M16	M20
Standard embedment depth	Effective embedment depth $h_{ef, sta}$	40	50	65	80	105
	Minimum thickness of member $h_{min}$	100	100	120	160	200
	Minimum spacing $s_{min}$	40	50	70	90	120
	Minimum edge distance $c_{min}$	40	50	70	90	120
Reduced embedment depth	Effective embedment depth $h_{ef, red}$	30 <sup>1)</sup>	40	50	65	80
	Minimum thickness of member $h_{min}$	100	100	100	120	160
	Minimum spacing $s_{min}$	40	50	70	90	120
	Minimum edge distance $c_{min}$	40	80	100	120	120

<sup>1)</sup> Use restricted to anchoring of structural components which are statically indeterminate

**Installation instructions**

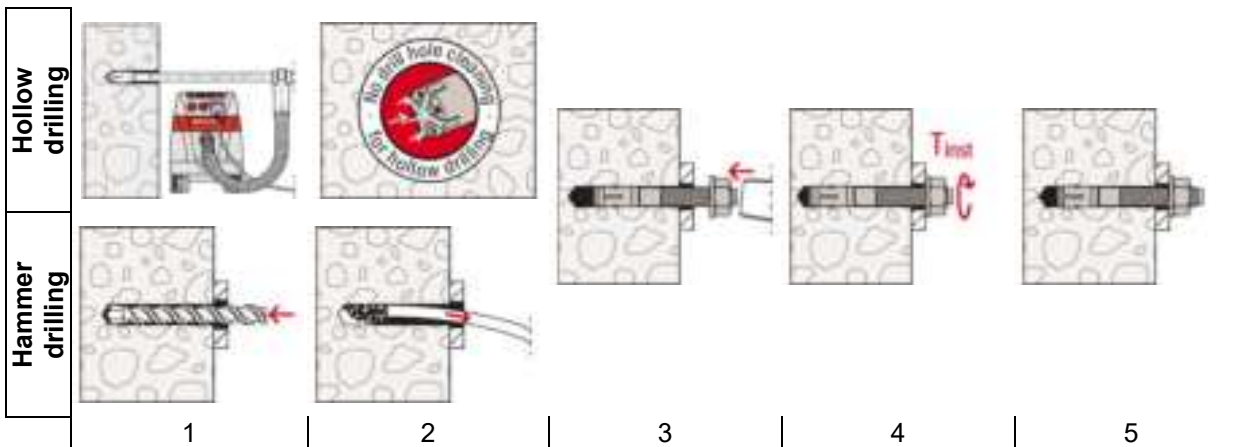

No.	Description	
1	Create drill hole with hammer drill	Create drill hole with hollow drill and vacuum cleaner
2	Clean bore hole	-
3	Set anchor	
4	Expand anchor with prescribed installation torque $T_{inst}$	
5	Finished installation	

Types of drills	
Hammer drill	
Hollow drill	

(Fig. not to scale)

fischer Bolt Anchor hot-dip galvanised FBN II HDG	<b>Annex B5</b> of European Technical Assessment ETA-XX/YYYY
<b>Intended use</b> Minimum thickness of member, minimum spacing and edge distance Installation instructions	

**Table C1.1:** Characteristic values of **tension** resistance for **standard and reduced embedment depth** under static and quasi-static loads

Size			M8	M10	M12	M16	M20
<b>Steel failure for standard and reduced embedment depth</b>							
Characteristic resistance	$N_{Rk,s}$	[kN]	16,5	27,2	41,6	77,9	107
Partial safety factor	$\gamma_{Ms}$	[-]	1,4	1,4	1,4	1,5	1,5
<b>Pullout failure for standard embedment depth</b>							
Characteristic resistance C20/25	$N_{Rk,p}$	[kN]	- <sup>1)</sup>				
<b>Pullout failure for reduced embedment depth</b>							
Characteristic resistance C20/25	$N_{Rk,p}$	[kN]	6 <sup>2)</sup>	- <sup>1)</sup>			
Increasing factors for $N_{Rk,p}$	$\psi_c$	C25/30	1,12				
		C30/37	1,23				
		C35/45	1,32				
		C40/50	1,41				
		C45/55	1,50				
		C50/60	1,58				
Installation safety factor	$\gamma_{inst}$	[-]	1,0				
<b>Concrete cone and splitting failure for standard and reduced embedment depth</b>							
Effective embedment depth	$\frac{h_{ef, sta}}{h_{ef, red}}$	[mm]	40	50	65	80	105
			30 <sup>2)</sup>	40	50	65	80
Factor $k_1$ for uncracked concrete	$k_{ucr,N}$	[-]	11,0				
Spacing	$s_{cr,N}$	[mm]	3 $h_{ef}$				
Edge distance	$c_{cr,N}$	[mm]	1,5 $h_{ef}$				
Spacing (splitting failure)	$s_{cr,sp}$	[mm]	190	200	290	350	370
Edge distance (splitting failure)	$c_{cr,sp}$	[mm]	95	100	145	175	185

<sup>1)</sup> Pullout failure is not relevant

<sup>2)</sup> Use restricted to anchoring of structural components which are statically indeterminate

fischer Bolt Anchor hot-dip galvanised FBN II HDG

**Performances**  
Characteristic values of tension resistance for standard and reduced embedment

**Annex C1**  
of European  
Technical Assessment  
ETA-XX/YYYY

**Table C2.1:** Characteristic values of **shear** resistance for **standard and reduced embedment depth** under static and quasi-static loads

Size		M8	M10	M12	M16	M20
<b>Steel failure without lever arm for standard and reduced embedment depth</b>						
Characteristic resistance	$V_{RK,s}^0$ [kN]	13,3	21,0	31,3	55,1	67
<b>Steel failure with lever arm for standard embedment depth</b>						
Characteristic bending moment	$M_{RK,s}^0$ [Nm]	26,2	52,3	91,6	232,2	422
<b>Steel failure with lever arm for reduced embedment depth</b>						
Characteristic bending moment	$M_{RK,s}^0$ [Nm]	19,9 <sup>1)</sup>	45,9	90,0	226,9	349
<b>Concrete pryout failure for standard and reduced embedment depth</b>						
Factor for pryout	$k_8$	1,8	2,1	2,3	2,3	2,3
Installation safety factor	$\gamma_{inst}$ [-]	1,0				
<b>Concrete edge failure for standard and reduced embedment depth</b>						
Effective length of anchor	$l_{f,sta}$	40	50	65	80	105
	$l_{f,red}$ [mm]	30 <sup>1)</sup>	40	50	65	80
Effective diameter of anchor	$d_{nom}$	8	10	12	16	20
Installation safety factor	$\gamma_{inst}$ [-]	1,0				

<sup>1)</sup> Use restricted to anchoring of structural components which are statically indeterminate

**Table C2.2:** Displacements due to tension loads

Size		M8	M10	M12	M16	M20
Standard embedment depth	$h_{ef, sta}$ [mm]	40	50	65	80	105
Tension load C20/25	N [kN]	6,1	8,5	12,6	17,2	25,8
Displacements	$\frac{\delta_{N0}}{\delta_{N\infty}}$ [mm]	0,6	0,9	1,5	1,8	1,8
		3,1				
Reduced embedment depth	$h_{ef, red}$ [mm]	30	40	50	65	80
Tension load C20/25	N [kN]	2,8	6,1	8,5	12,6	17,2
Displacements	$\frac{\delta_{N0}}{\delta_{N\infty}}$ [mm]	0,4	0,7	0,7	0,9	1,0
		1,6				

**Table C2.3:** Displacements due to shear loads

Size		M8	M10	M12	M16	M20
Shear load	V [kN]	7,6	12,0	17,9	31,5	38,2
Displacements	$\frac{\delta_{V0}}{\delta_{V\infty}}$ [mm]	1,5	1,6	2,0	3,0	2,6
		2,3	2,4	3,0	4,5	3,9

fischer Bolt Anchor hot-dip galvanised FBN II HDG

**Performances**  
Characteristic values of shear resistance for standard and reduced embedment depth  
Displacements

**Annex C2**  
of European  
Technical Assessment  
ETA-XX/YYYY