

IFB

DeepClean®

POWERED BY 

WASHING MACHINE USER MANUAL

TL650MB1/TL650CB1/TL650EP1/TL650AG1/TL650MG1
TL701WR2/TL701CB1/TL701EP1/TL701AG1/TL701MG1
TL801AG1/TL801MG1

TL421PKMAN310 B

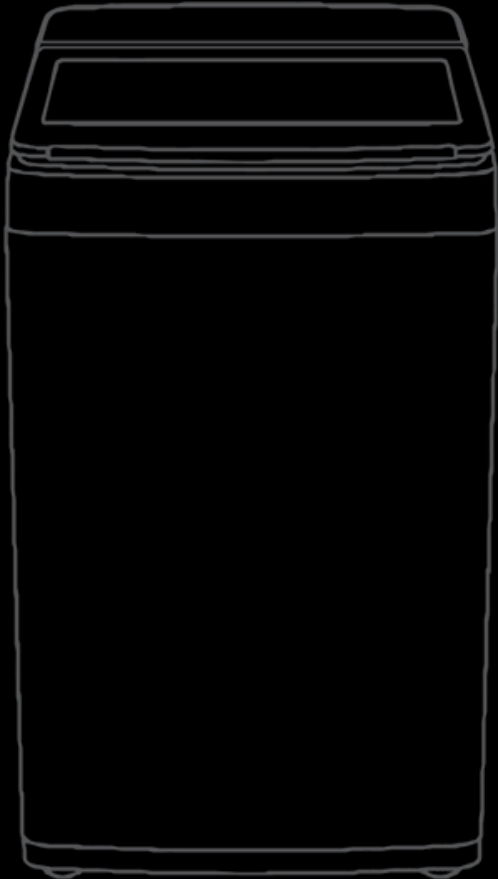

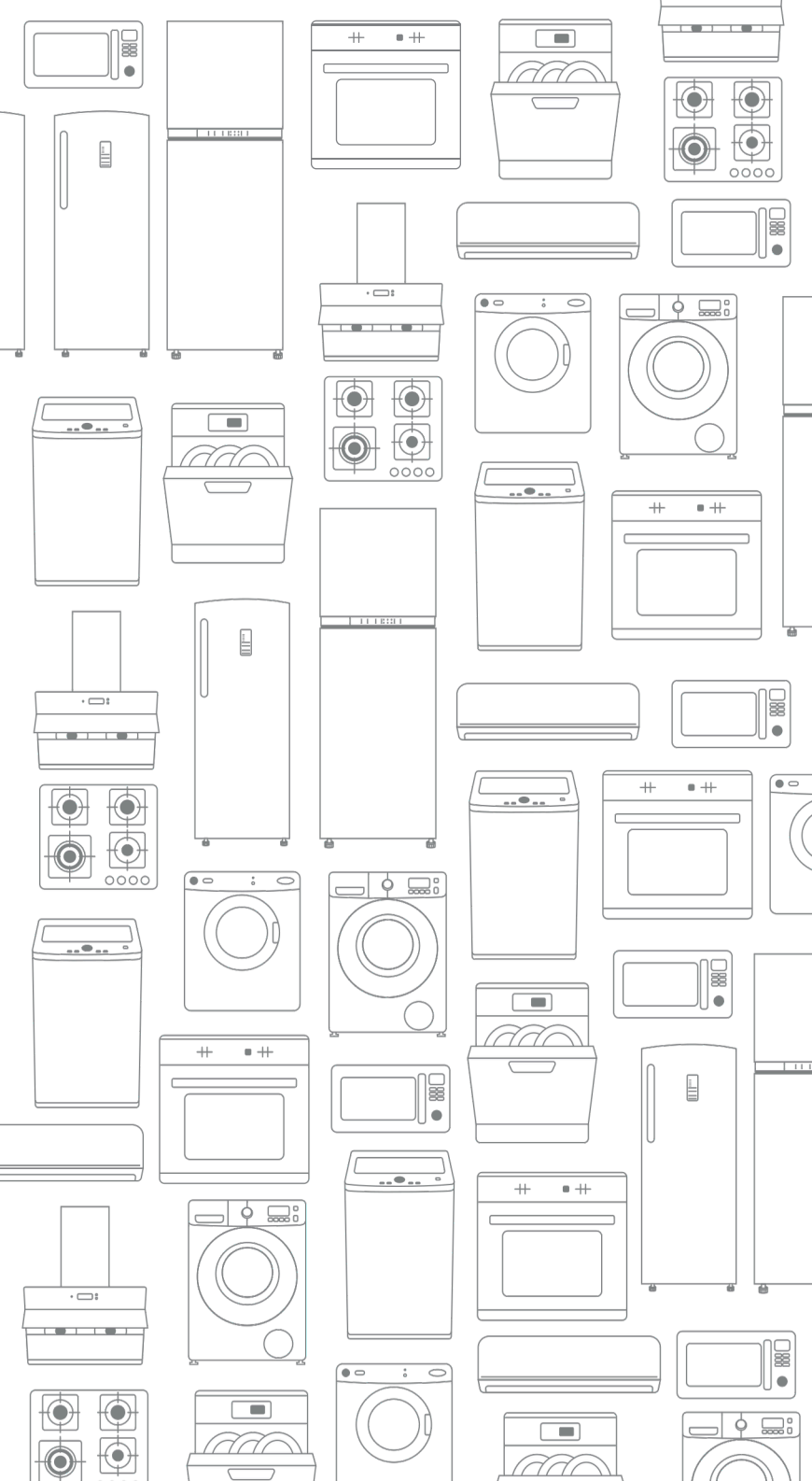

Welcome to the IFB Family

Get ready to experience excellence
in washing and long lasting peace
of mind. Happy Laundry Days to you!

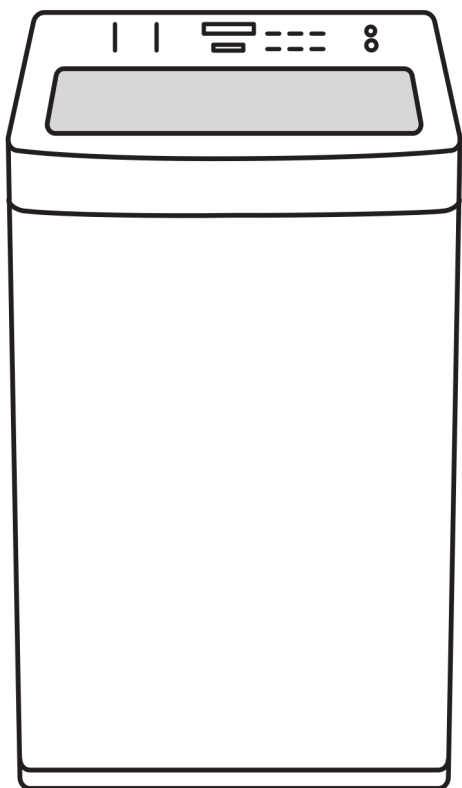

Top Load Washer

Contents

The A to Z of Your Washing Machine	06
The Display Panel	11
Safety Guidelines	
Installation	14
Instructions	16
Caution	17
About eWaste	21
Section 1 Getting Started With Your Washing Machine	
Installing Your Machine & Safety Guidelines	23
Before You Start	30
Section 2 Running Your Machine	
6 Easy Steps For Doing Your Laundry	31
Finishing	36
Program Guide	37
Wash Options	39
Wash Guide Map	46
Key Features	49
Section 3 Getting More From Your Machine	
Tips for Best Results	56
Stain Treatment	58
Maintenance and Cleaning	62
Section 4 Useful Information	
Display	68
Troubleshooting	69
Technical Specifications	74
Revisions Sheet	75

PRECAUTIONS

This appliance meets the required safety standards, but using it improperly could cause injury or property damage. Make sure to read this manual carefully—it covers safety, installation, use and maintenance. Use detergents with low foam to prevent any problems. Following these guidelines will help you get the most out of your new washing machine and keep it running smoothly while avoiding accidents or damage.

The A to Z of Your Washing Machine

TL801AG1/TL801MG1

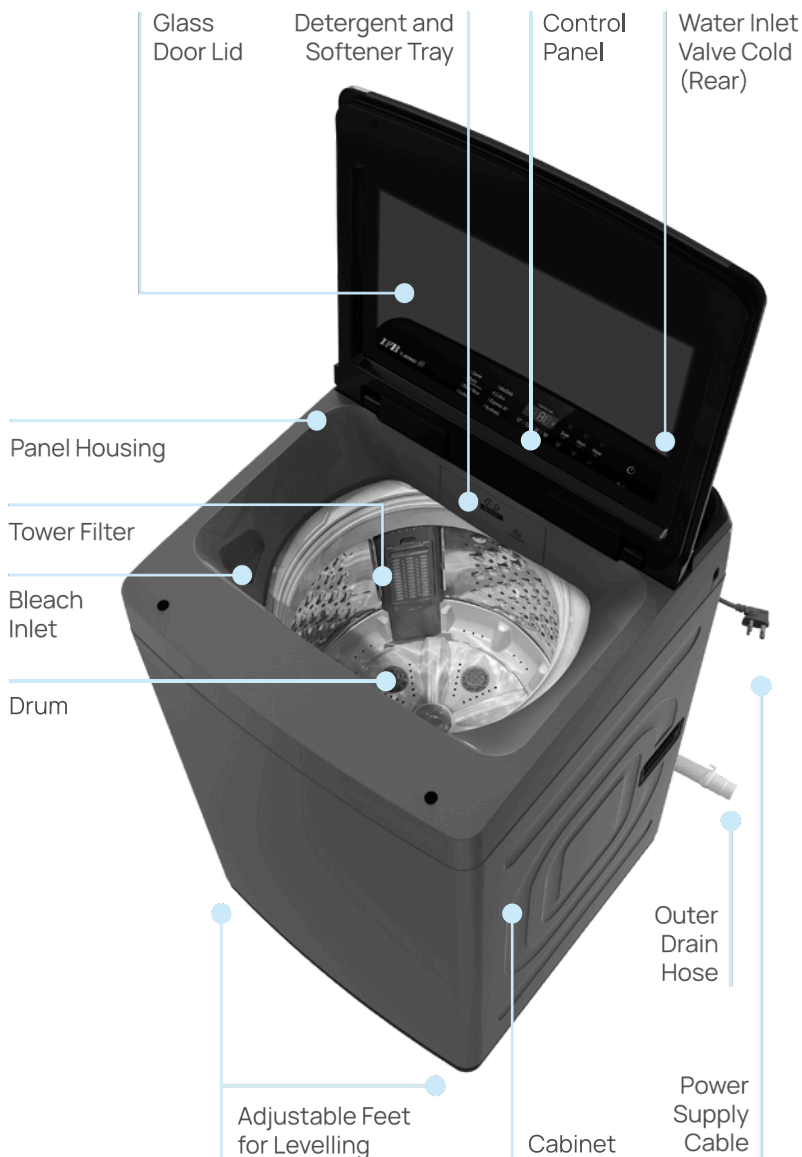

The A to Z of Your Washing Machine

TL801AG1/TL801MG1

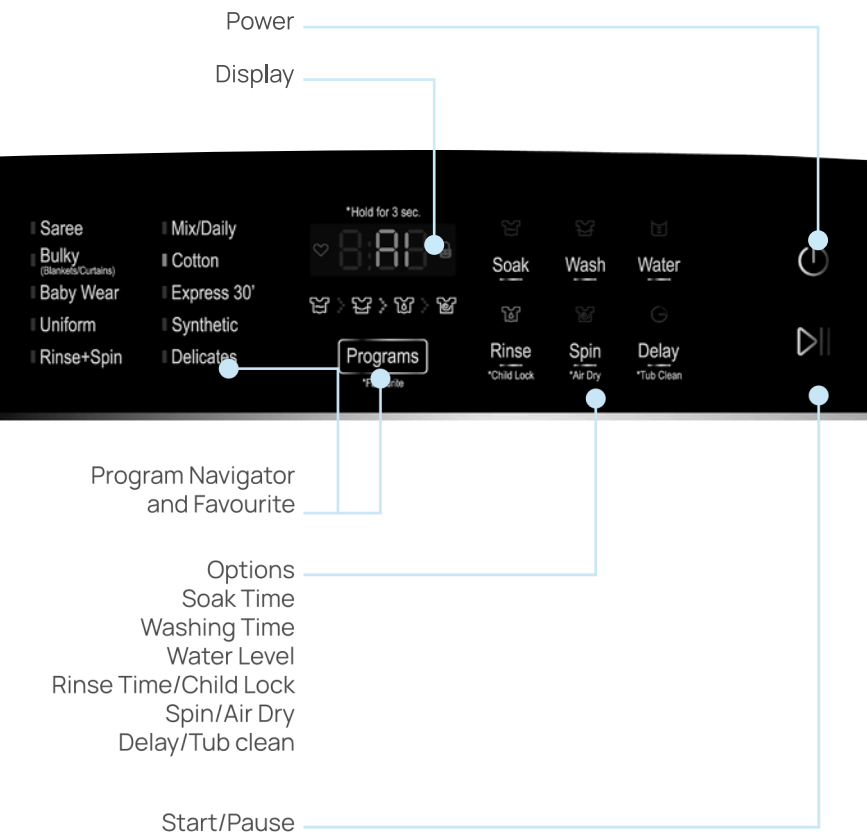

The A to Z of Your Washing Machine

TL650MB1/TL650CB1/TL650EP1/
TL650AG1/TL650MG1

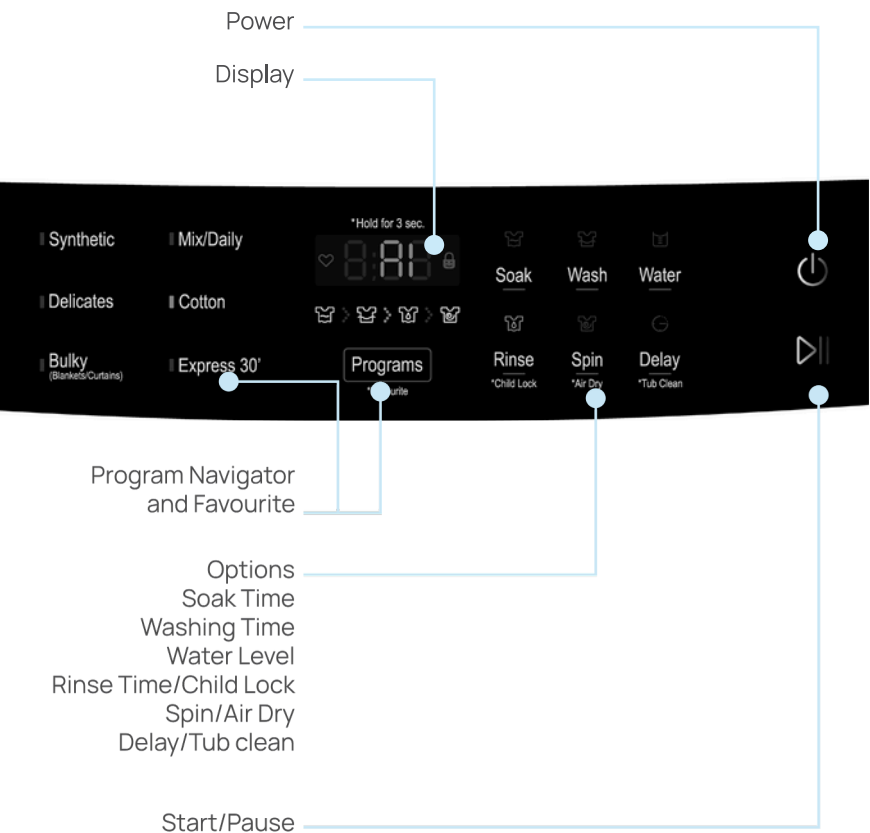

The A to Z of Your Washing Machine

TL701WR2/TL701CB1/TL701EP1/
TL701AG1/TL701MG1

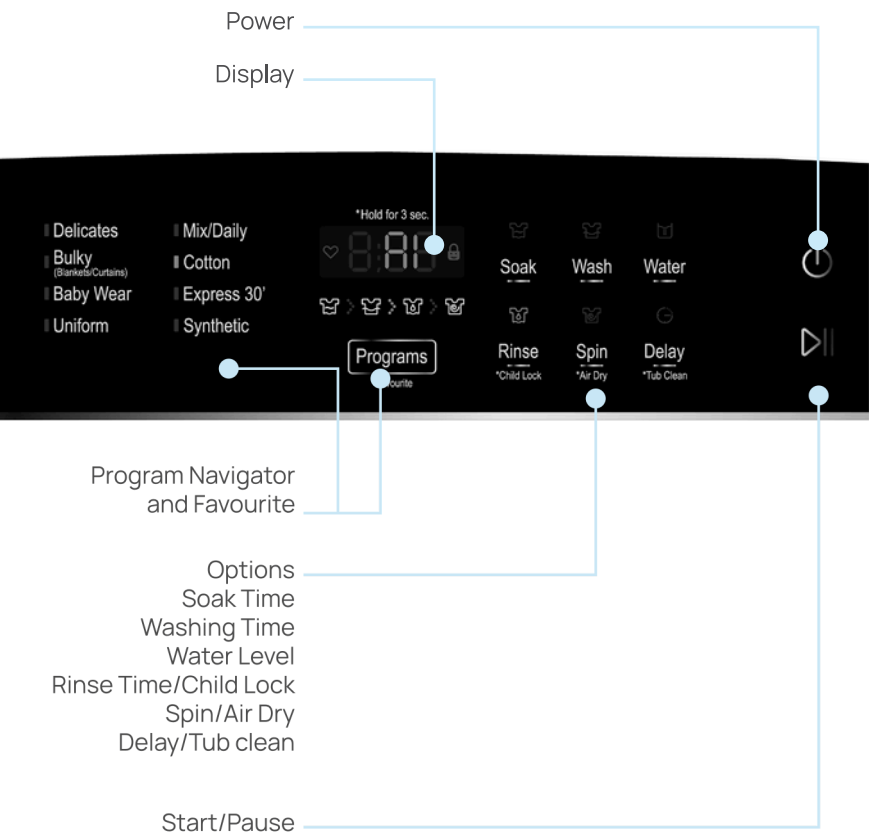

The A to Z of Your Washing Machine

Accessories Included

1 WATER INLET HOSE, 1 PIECE

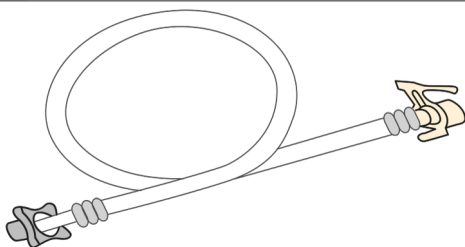

2 OUTER DRAIN HOSE, 1 PIECE

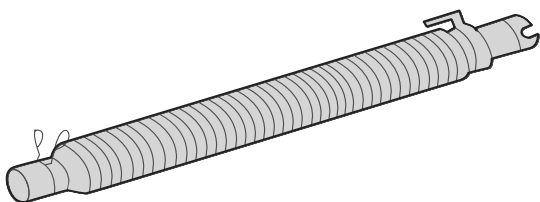

3 RAT MESH, 1 PIECE

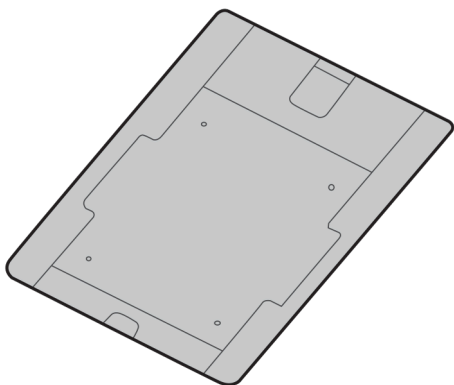

The Display Panel

Functions



1 POWER ON/OFF

Press the Power button to turn the power ON or OFF.



2 START/PAUSE

Touch this button to Start the machine or Pause the wash cycle. Once paused, you can change the program or select different options if available. Press this button again to start the wash cycle.



3 PROGRAM NAVIGATOR

Touch this button to select the program you want to use. Touch again to change the selection. LED glows for the selected program. You can only choose one program at a time.

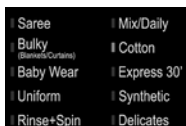

Select more wash options or press the Start/Pause button to Start the program.

Set the program+options selected as a Favourite with this button. (Scroll to the Favourite Option Selection for details.)

The Display Panel

Functions

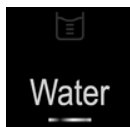

4 WATER

Use this button to adjust or set the Water Level. The default selection changes each time you press the button.

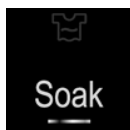

5 SOAK

Soak dirty clothes in soapy water for better cleaning. Touch this button to Select/Deselect the Soak option.

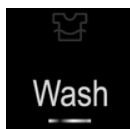

6 WASH

Touch this button to select/change the Wash Time.

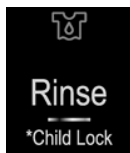

7 RINSE

Touch this button to Select/Change the number of Rinses before starting the program.

To Select/Deselect the Child Lock function press and hold the Rinse button for 3 secs.

Note Select the Wash Options before starting the program. You may change the Wash Options when the machine is on Pause (if applicable).

The Display Panel

Functions

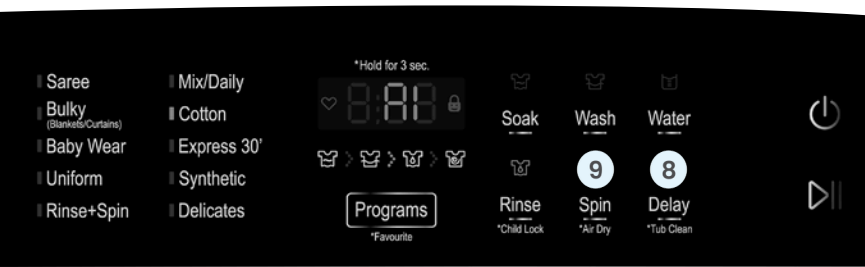

Delay

*Tub Clean

8 DELAY/TUB CLEAN

Touch this button to Select/Change the Delay Time before starting the program.

Use this button to Select/Deselect the Tub Clean program. (Scroll to the Tub Clean function for details).



Spin

*Air Dry

9 SPIN/AIR DRY

Touch this button to Select/Change the Spin Time before starting the program.

Press and hold this button for 3 secs to select and deselect Air Dry option.





Safety Guidelines

FOR INSTALLATION

Read all instructions & explanations carefully before installation. Choose the area where the machine will be placed carefully after reading the requirements.



Keep the packaging material. It may come in handy when shifting residence.

Not removing all packaging and transit bolts before using your appliance could damage your appliance. Please do not operate your machine until the transit bolts have been removed.



Pre-installation plumbing and electrical connections must be handled by qualified fitters, electricians, or technicians.

All washing machine installation work must be carried out only by authorised IFB Care Service Personnel.

Use only the new hoses provided with the machine; old hoses should never be reused.

Do not connect your machine to a hot water supply.

This machine works best with water pressure between 0.3 and 10 bar (that's about 3.5 to 10 litres/ minute). If the water pressure is too low, your machine might malfunction.



Your machine comes with ventilating openings on the base. Always put it directly on the floor after removing any carpets.

Keep your machine safe from direct sunlight and rainfall.

Avoid installing the machine in damp areas or bathrooms exposed to direct showers

Don't put the machine on a sloping, uneven, or unstable surface.

Make sure your machine is installed in a room with adequate ventilation. Don't pick a room without windows. And make sure there's at least 4 inches (100 mm) of space between the back of the machine and the wall.

Don't put your washing machine in places where the temperature is below freezing. If hoses freeze, they could burst when under pressure. Also, the electronic control unit might not work if it's too cold (below freezing) or too hot (above 50 °C).

A concrete floor is recommended for installation, as it reduces vibration during the spin cycle compared to wooden floorboards.

Ensure the machine is placed on a stable, level surface to prevent vibrations during operation. All four washer feet should be levelled and balanced against the floor.

Before cleaning your machine, make sure you disconnect the main electricity supply & remove the plug from the socket.

Don't use your appliance near flammable stuff like oil, benzene, or highly flammable gas. These might start fires or explosions. And don't use combustible detergents that can catch fire either.



Safety Guidelines

INSTRUCTIONS FOR USE

Safety first, always. Make sure you read all the instructions carefully before you start using the appliance. Keep the operating instructions handy for future reference



Remember, if cockroaches or other pests cause any damage, the appliance guarantee won't cover it.

Don't install or use a machine that's damaged. Before you plug it in, check if the connection details on the data plate (like fusing, voltage and frequency) match your electricity supply. If you're not sure, reach out to IFB Care for help.

Avoid washing or drying articles contaminated with combustible or explosive substances, such as oil, paint, gasoline, or solvents, to prevent fire or explosions.

Before using the machine for the first time, ensure the transit bolt at the rear is removed (refer to the installation section).

If you're leaving the machine for a while, for example if you're going on holiday, remember to turn OFF the stopcock, especially if there's no floor drain nearby.

Keep children away from the appliance, and closely supervise them when the machine is in use.

Appliances are not intended for use by children. Parents or legal guardians are responsible for supervising or training children on safe product usage. Do not let children clean or maintain appliances without adult supervision.



Caution

A WORD OF WARNING



The manufacturer isn't responsible if there's a problem with the earthing system. Make sure your machine is connected to a grounded outlet with a 16A Fuse or MCB. If you're unsure whether the machine is properly grounded, get it checked by a qualified technician or licensed electrician.

If the earthing connection is not properly carried out, it could lead to electric shocks or damage the machine.

Make sure the machine is connected to a 3-pin socket with good earthing and 16 Amp MCB for protection against short circuits.

Avoid using extension cables with the appliance for safety reasons, as they do not meet the required levels of safety.

When disconnecting the plug, hold the plug itself, not the cord. Don't insert or remove the plug with damp hands.

Overheating could be a real danger.

Your machine has been built according to current safety requirements.

Your machine is totally disconnected from electricity when you switch it OFF at the wall socket and remove the plug, or turn it OFF from the main source, or remove the main fuse, or switch OFF the MCB.



Caution



Letting unauthorised mechanics repair your machine, may pose unforeseen dangers. Only authorised IFB Care Service Personnel should undertake repairs.

Only use a new hose kit to connect your machine to the water supply on site. Don't try to reuse old hoses. If any parts need replacing, make sure to use genuine IFB spare parts. That way, you can be sure your machine meets safety standards.

Faulty connection cables must be replaced by authorised IFB Care Service Personnel to prevent potential danger to the user.

Make sure the assembly holder protector and tub cushion are used when transporting the machine to prevent damage to the appliance.

First use after installation—Condensed water droplets may remain inside the drum after assembly and test run. Run the first cycle without garments. Use the Cotton program at the highest temperature, add detergent, **DO NOT** put any clothes in the machine.

If the trolley vibrates excessively, it needs to be replaced right away. Otherwise, it could make the machine less reliable and shorten its lifespan.

If your machine has a porthole door, keep in mind that the glass might get hot when you're washing at high temperatures. Make sure children don't touch it.

Always ensure the drum is stationary before removing clothes to avoid accidents.

Avoid dragging the washing machine while it's loaded or if it's running, to prevent damage.



Caution

Keep your machine dry to avoid corrosion/rusting.

Don't spill water on the machine. If spills occur, wipe it dry. Your machine should be kept away from floor cleaning chemicals. Don't wash or spray water over the switch or control panel. Keep the machine dry to prevent corrosion and rusting. Make sure to wipe the machine after cleaning the coin trap.



Don't wash shoes or utensils in this appliance.

Check the labels on your clothes for the washing instructions for the fabric.

Use detergents that have been recommended for this washing machine.

Only use dyes specified by the manufacturer for domestic washing machines. Make sure to follow the manufacturer's instructions carefully.

Never use solvent-based cleaning agents in the machine. They can damage parts and produce dangerous fumes. Plus, they can also increase the risk of fire and explosions.

If your clothes have been treated with solvent-based cleaning agents before washing, make sure to rinse them really well in clean water before you put them in the machine.

Avoid using colour run and dye removers containing sulphur compounds, as they can cause corrosion or damage.



Caution

Your machine has been built according to current safety requirements.

During assembly, the machine is tested with water to make sure it performs correctly. Sometimes, a few water droplets may be left inside the drum.

Flooding Danger

When you're connecting the drain hose to a washbasin, make sure the water drains away fast to stop the sink from overflowing. Also, make sure the hose is firmly in place so the water flow doesn't push it out. Otherwise, you might end up with flooding.

Be careful to not let things like nails, pins, coins, or paper clips end up in the machine with your laundry. They can damage parts like the suds container or drum, which can then ruin your clothes during the wash.

USE OF APPLIANCE

This appliance is not intended to be used in household and similar applications such as—

- Staff kitchen areas in shops, offices and other working environments,
- Farm houses,
- By clients in hotels, motels and other residential type environments,
- Bed and breakfast type environments, and
- Areas for communal use in blocks of flats or in laundrettes.

If the manufacturer wants to limit the use of the appliance to less than the above, this shall be clearly stated in the instructions.

About eWaste

eWaste, or Waste Electrical and Electronic Equipment (WEET), refers to discarded appliances using electricity. To responsibly manage eWaste, follow the guidelines below.



DOs

- Always dispose of end-of-lifecycle products by contacting an authorised local eWaste recycler.
- Do drop off used electronic products, batteries, or accessories at authorised eWaste recyclers.
- Sort packaging materials for responsible waste disposal and recycling options whenever possible or as instructed.



DON'Ts

- Do not dismantle electronic products on your own.
- Never dispose of electronic products in bins marked 'Do Not Dispose'.
- Refrain from giving eWaste to informal sectors like local scrap dealers or rag pickers.
- Do not dispose of your product in garbage bins along with municipal waste that ultimately reaches landfills.

RISKS OF IMPROPER HANDLING OF eWASTE

eWaste usually includes components which, if disposed of improperly, hold environmental consequences such as air, water and soil pollution and also pose risks to human health.

By ensuring your appliance is disposed of correctly, you will help prevent potential negative consequences for the environment and human health. Components and materials used in this washing machine are fully compliant with the Provisions of Hazardous Substances outlined in eWaste Management Rule, 2016.



FOR DETAILED INFORMATION AND DISPOSAL REQUEST
Contact **IFB Care** at **080 695 45678**. Provide your details to our representative to arrange for proper product disposal.

Getting started with your washing machine

Installation and Safety Guidelines

1 SELECTING THE RIGHT SPOT

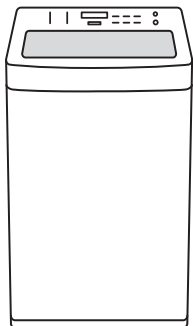

Place the machine on a level floor.

Make sure the machine is close to both water and electrical connections.

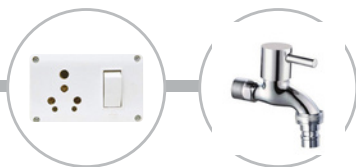

Getting started with your washing machine

Installation and Safety Guidelines

2 INSTALL THE RAT MESH

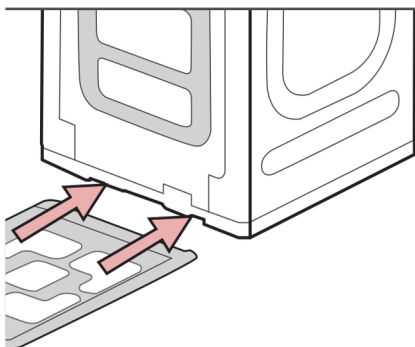

Unpack the machine and remove the rat mesh from the top cushion.

Tilt the washing machine forward, about 45°. There are slots at the back of the washing machine. Insert the rat mesh in between these slots. Push it in and press it upwards till you hear a 'click' sound. This indicates that the rat mesh is installed correctly.

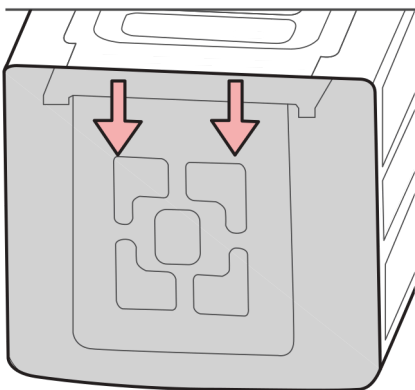
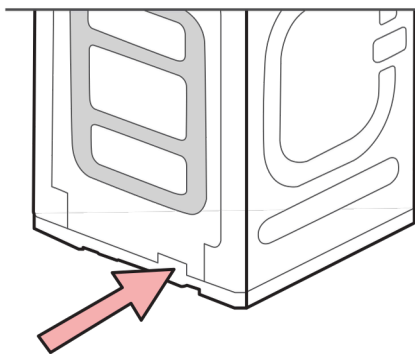

Getting started with your washing machine

Installation and Safety Guidelines

3 LEVELLING

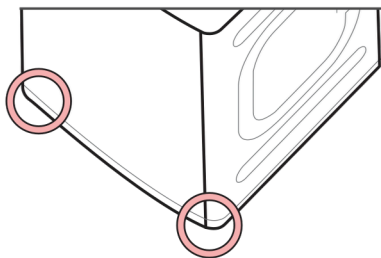

Level the machine by using the adjustable legs that are on the bottom of the machine.

Adjust the front legs up or down to get a balanced horizontal setting.

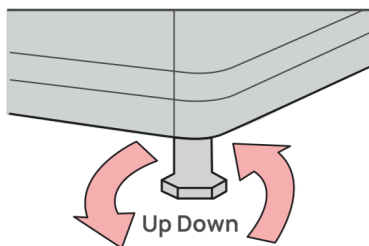

Make sure all 4 legs are evenly placed on the level surface.

If not balanced properly, the machine will make a lot of noise, shake and could malfunction.

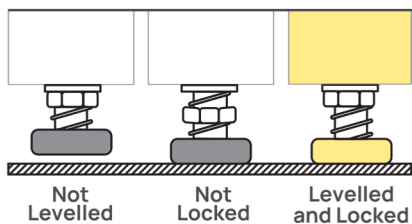
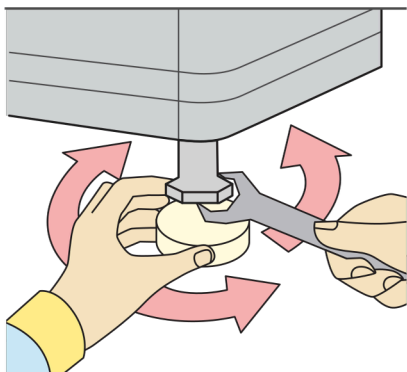

Getting Started With Your Washing Machine

Installation and Safety Guidelines

4 CONNECTION TO WATER SUPPLY

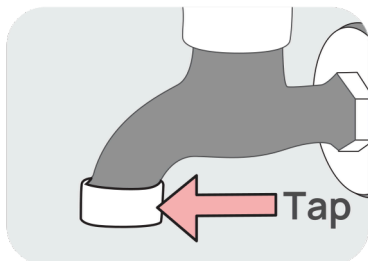

First fix the water inlet hose to the tap. The water inlet hose has a nut on one end. Pull it upwards and screw it into the tap tightly. Hold the water inlet hose and pull it downwards to check whether it is fixed properly.

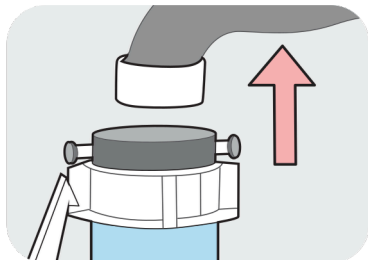

Second fix the other end of the hose into the machine. Use the new hose kit to connect the machine to the water supply. Do not reuse an old hose.

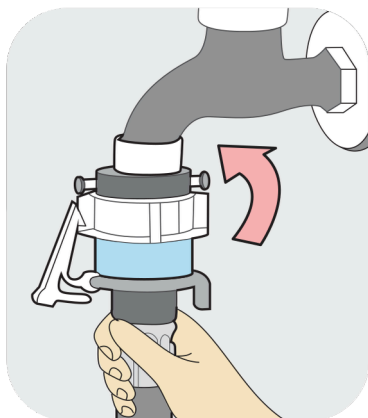

Do not start the washing machine immediately. Open the tap and check if water is leaking at either end. Check the water pressure, if it is too high turn the tap down a little to avoid water leaks.

The machine is designed to operate with water pressure between 0.3 Bar–8 Bar. Lower or higher pressure can cause malfunctions.

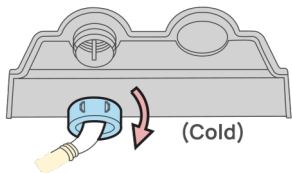

Note After connecting inlet hose to water tap, turn ON the water tap to flush out foreign substances such as dirt, sand or sawdust in the pipelines.

Getting Started With Your Washing Machine

Installation and Safety Guidelines

5 CONNECTION TO DRAIN HOSE

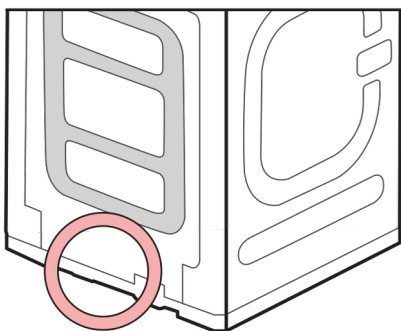

Take the drain hose out of the packing. You must install this before using the machine.

Connect it to the drain outlet at the back of the washing machine.

Note If the washing machine is on a carpeted floor make the sure the opening is not blocked. If the drain hose is blocked it will flood the area.

The cabinet has a protective film for safety during transit. Remove it before installation.

Insert the drain hose into the drain outlet which is at the back of the machine.

Press the hose clamp and push the drain hose towards the body. Release the hose clamp after pushing the drain hose in.

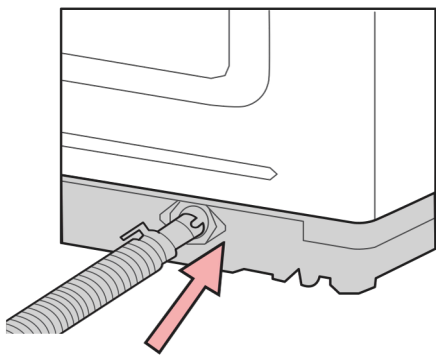
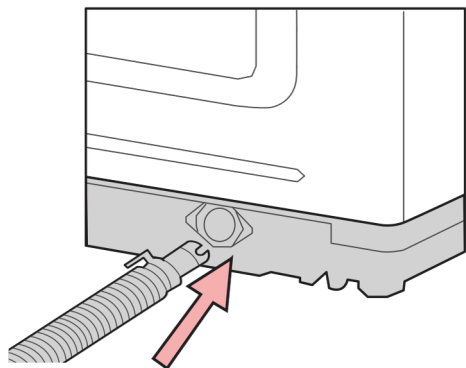

Getting Started With Your Washing Machine

Installation and Safety Guidelines

6

CONNECTION TO DRAIN HOSE

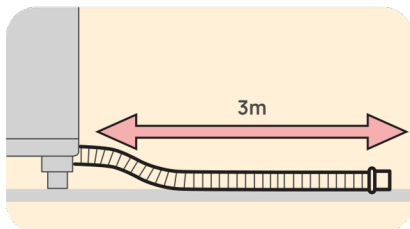

Install the drain hose

In some cases the drain hose is extended. Don't let it get longer than 3 m.

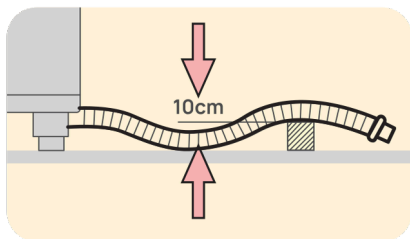

In case the hose goes over a door sill it should not be higher than 10 cm (from the bottom of the washer).

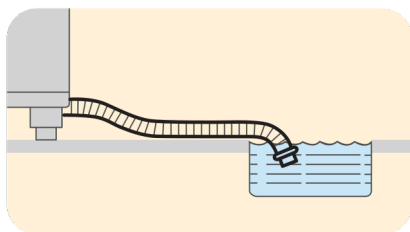

The end of the drain hose should not be immersed in water.

Getting Started With Your Washing Machine

Installation and Safety Guidelines

7 ELECTRICAL CONNECTION

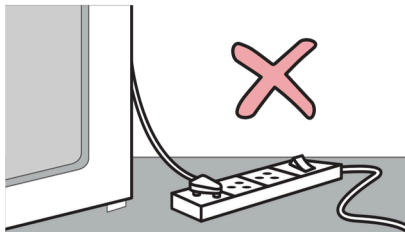

A 16 Amp, 3 pin 220-240 V AC, 50 Hz electrical point with a 16 Amp MCB (or automatic short circuit protection device) within 1 m of the machine is mandatory.

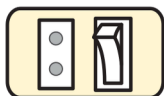

Make sure your home has proper earthing and the connection between the socket and the plug is firm.

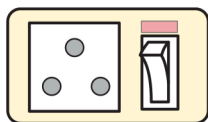

WARNING ELECTRICAL SHOCK HAZARD

If you do not follow these instructions you are at risk.

Do not earth with a gas pipe. Proper electrical earthing is mandatory. If you're unsure whether the machine is properly earthed, get it checked by a qualified technician or licensed electrician.

Do not change the power supply cable plug. If the plug does not fit the outlet have a suitable one installed by a qualified technician or licensed electrician.

If the connection cable is damaged, do not run the washing machine. Call IFB Service and get it replaced by an authorised IFB Care Service Personnel.

Getting Started With Your Washing Machine

BEFORE YOU START

Make sure that the machine has been installed and connected as per the instructions given.

Check the electrical connection, hose and drain pipe fittings. Check the water connection. The water tap should be within 1 metre of the machine—external or parallel thread used should be 3/4". Turn ON the tap once securely connected.

To remove any water left over from factory testing of your machine, the first wash cycle should be carried out without any laundry in the machine.

Turn ON the water tap,

- > Pull out the detergent drawer completely
- > Pour approximately 20 g of detergent in the dispenser
- > Close the detergent drawer
- > Press and hold the Delay button to set the Tub Clean program
- > Press Start/Pause
- > The power will turn OFF automatically after the program ends.

Running Your Machine

6 Easy Steps for Doing Your Laundry

1

SORT THE LAUNDRY

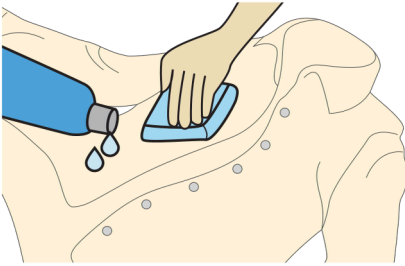

Pre treat collars, cuffs and stains.

Check for wash care symbols.

Close zippers, hooks and strings.

Empty the pockets of your clothes.

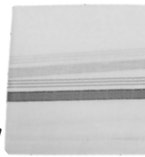

6 Easy Steps for Doing Your Laundry

2 LOAD THE LAUNDRY



Make sure the laundry drum is empty. Nothing should be placed on the rubber gasket.

Load garments one by one, place them loosely inside the drum.

Close the door.

Note Once loaded, press your clothes down to ensure they're fully inside the machine. Do not overload the tub. Make sure nothing remains outside the tub.

Note Use a laundry bag to avoid damage to your delicates—silk, wool, lacy clothes, lingerie, nylon stocking etc.

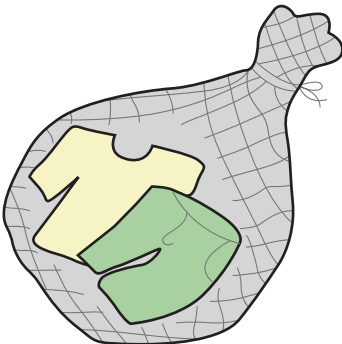

For smaller loads reduce the Wash Time setting.

6 Easy Steps for Doing Your Laundry

3 ADD DETERGENT

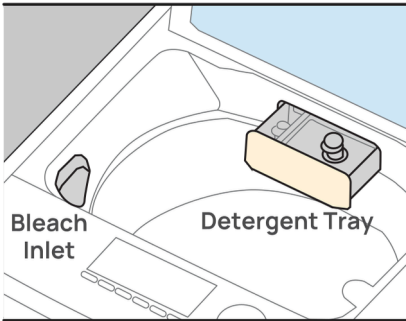

Pull out detergent tray completely. **Add the correct amount of detergent.** Close the detergent tray. Follow the manufacturer's directions.

Add fabric conditioner or softener (optional). For fabric conditioner or additives use the softener dispenser compartment which is next to the detergent tray. Take care not to exceed the maximum level. Use as recommended on the packaging.

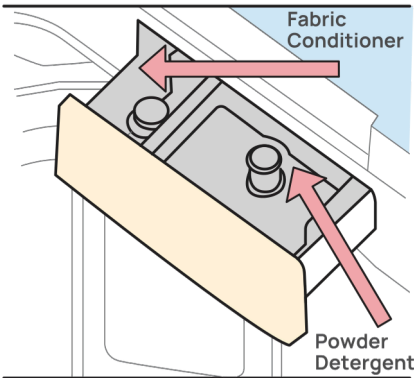

Add liquid bleach (optional). If you want to use bleach add the recommended amount to the bleach inlet. You can only use liquid bleach. Follow the manufacturer's directions for safe use.

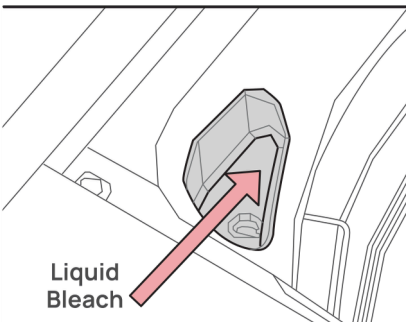

Running Your Machine

**Note**

Always use detergents that are recommended for top load washing machines. Using the wrong detergent can cause laundry issues. Avoid using soap flakes or granulated soap powders in your washing machine. When washing woollens or silk, make sure to use the detergent type recommended by the manufacturer. If you notice too many suds, reduce the amount of detergent you're using.

6 Easy Steps for Doing Your Laundry

4 SELECT PROGRAM



Close the washing machine door. Press the power button to switch ON the machine.

You can select any of the fully automatic programs available.

Saree	Mix/Daily
Bulky (Blankets/Curtains)	Cotton
Baby Wear	Express 30'
Uniform	Synthetic
Rinse+Spin	Delicates

Programs
*Favourite

For more information scroll to the **Program Guide** section.

5 SELECT WASH OPTIONS

Once the program is selected choose the Wash Options or additional options as required.

For details scroll to the **Wash Options** section.

6 START WASHING



Press the Start/Pause button to start washing.

Finishing

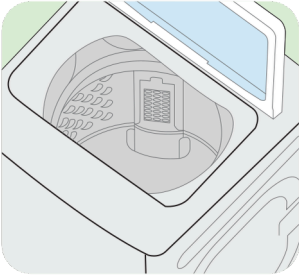

The washing machine will automatically turn OFF once the program is over.

Take the clothes out of the drum.

Wipe the panel and cabinet with a dry cloth to remove the moisture.



Turn OFF the tap.

Switch OFF the power supply or remove the power supply cable from the wall socket.

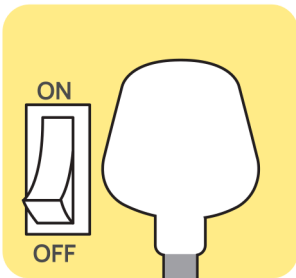

The machine has been programmed to switch OFF all visual displays such as LEDs to save energy. Start/pause LED will slowly blink after END of program. This is in line with the latest 'Energy Using Product' norms (EUP).

Program Guide

PROGRAM	TYPE OF LAUNDRY
Mix/Daily	Cotton, synthetic and easy-care garments. Not recommended for special garments like silk/delicates, dark clothes, wool, duvets, curtains, etc. Use for every day clothes.
Cotton	Cotton colour-fast garments. Shirts, pants, uniforms, bed and table linen, towels, night dresses, pyjamas, underwear, etc.
Express 30'	Lightly soiled coloured laundry made of cotton, linen, synthetic or blended fabrics. Wash small loads, quickly—up to 2 Kg.
Synthetic	Polyester, acrylic or polyamide daily wear garments, gym wear, sportswear etc.
Delicates	Hand wash and delicate wash garments. Silk, woollens, lingerie, satin, sheer fabrics etc. The gentle movement washes clothes without damaging or stretching the fibres. We recommend using a laundry bag.
Saree	Special program for machine washable sarees.

Running Your Machine

Program Guide

PROGRAM	TYPE OF LAUNDRY
Blankets (Curtain/Bulky)	<p>Machine washable cotton curtains.</p> <p>Large items like blankets, bedding covers, sofa covers, pillow covers and bedspreads.</p> <p>Strong washing movement thoroughly cleans out dust mites. Only 6~10 Water Level may be selected.</p>
Baby Wear	<p>Recommended for baby clothes, bibs, rompers, underwear, cloth diapers, pillows,bedsheets, etc.</p> <p>Extra rinses ensure better wash performance.</p>
Uniform	<p>Shirts, pants as well as uniforms.</p>
Rinse+Spin	<p>Use this program only when you want to run a Rinse and Spin cycle.</p>

Running Your Machine

Wash Options

OPTIONS

Details

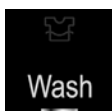

Wash Time

You can select the Wash Time as follows
10 → 15 → 20 → 0 → 5 → . . . & Repeat.

If you do not want to use this option, set the Wash Time to '0'.

The Wash LED glows when the option is selected.

Select more wash options or press the Start/Pause button to start the program.

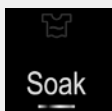

Soak Time

You can select the Soak time as follows
c10 → c20 → c30 → 0 → . . . & Repeat.

If you do not want to use this process, set the Soak Time to '0'.

The Soak LED glows when the option is selected.

Select more wash options or press the Start/Pause button to start the program.

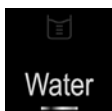

Water Level

You can select the Water Level as follows
L:1, L:2, L:3, L:4, L:5, L:6, L:7, L:8 L:9, L:10--L:1, L:2, L:3, . . . & Repeat.

The Water Level LED glows when the option is selected

Select more wash options or press the Start/Pause button to start the program.

Running Your Machine

Wash Options

OPTIONS

Details

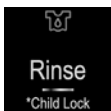

Rinse

Select the number of Rinses you need. Keep pressing the button to change the number. Stop when the desired selection is displayed—1 Rinse → 2 Rinse → 3 Rinse → 4 Rinse → 5 Rinse → 0 → 1 Rinse → . . .& Repeat. The maximum number is 5.

If you do not want to use this process, set the Rinses to '0'.

The Rinse LED glows when the option is selected.

Select more wash options or press the Start/Pause button to start the program.

Child Lock

Child Lock activates protection against unintentional changes to the program sequence.

To select the Child Lock function press and hold the Rinse button for 3 secs while the machine is running. No changes can be made while the program is running, only the Power button can be used.

The Child Lock LED glows when the option has been selected.

You can disable this option the same way you enabled it.

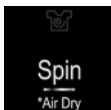

Spin Time

You can select the Spin Time (mins) as follows: 1 → 2 → 3 → 4 → 5 → 6 → 7 → 8 → 9 → 0 . . .& Repeat.

The Spin LED glows when the option is selected.

When you only want to drain the clothes and not Spin them select the Spin Time as '0'.

Running Your Machine

Wash Options

OPTIONS

Details

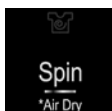

Air Dry

To select the Air Dry option, Press and hold the Spin button for 3 secs. Select as follows—60 mins → 90 mins → 120 mins → 0 → 60 mins. . . & Repeat.

Select more wash options or press the Start/Pause button to start the program.

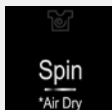

Only Spin/Drain

To select Only Drain: Power ON the machine and set the Spin Time to '0'. Close the door and press Start/Pause once to start the drain cycle.

To select only Spin: Power ON the machine and set the desired Spin time. Close the door and Press Start/Pause button once to start the Spin Cycle.

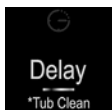

Delay

This option allows you to specify the time a program should start. The delay can be set from 1 Hr to 24 Hrs.

Power ON the machine, select program and wash options. Press the Delay button to select—1 → 2 → 3 → . . . → 11 → 12 → 13 → . . . → 22 → 23 → 24 → 0 → 1 → 2 → 3 → . . . & Repeat. It can be set at hourly intervals up to 24 Hrs.

The Display LED glows when the option is selected.

Press the Start/Pause button to start the program. To cancel the Delay Wash, press Power ON/OFF button.

Running Your Machine

Wash Options

OPTIONS

Details

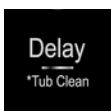

Tub Clean

Run this program to eliminate impurities, scaling, bacteria and unpleasant smell from the washing machine.



IMPORTANT

Do not put laundry in the washing machine during Tub Clean. Before running the program empty the drum.

Do not use any cleaning agents/additives when running this program.

Press and hold the Delay button for 3 secs to select Tub Clean.

Display will show 'Tub ' for 1 sec, 'cln' for 1 sec and 'program time' for 1 sec indicating the program has been selected.

Press the Start/Pause button once to start the Tub Clean program.

Tub Clean Reminder

The Tub Clean Reminder will appear after every 40 washes. The display will show Run tub cln for 2 mins after the end of the wash program. The reminder will be displayed for the next 5 programs, if the the Tun Clean program is not selected. We recommend running the Tub Clean program every 40 cycles to keep your washing machine clean.

Note The reminder will be displayed for 5 wash cycles and then go OFF.

Running Your Machine

Washing Symbols—A Guide



RESISTANT MATERIAL



DELICATE FABRIC



WASHABLE AT 95°C



WASHABLE AT 60°C



WASHABLE AT 40°C



WASHABLE AT 30°C



HAND WASH



DRY CLEAN ONLY



WOOL SEAL



BLEACHABLE IN COLD WATER



DON'T BLEACH



DON'T DRY CLEAN



DRY FLAT



HANG TO DRY



DRY ON CLOTHES HANGER



TUMBLE DRY, NORMAL HEAT



TUMBLE DRY, REDUCED HEAT



DON'T TUMBLE DRY

Running Your Machine

Water Level & Detergent Usage

Detergent dosage

Use the proper amount of detergent as per the instructions of the detergent manufacturer.

Normal Dosage

Regular detergent—30 gms/30 litres of water.

Concentrated detergent— 20 gms/30 litres of water.

DETERGENT DOSAGE—WATER VOLUME & LOAD

WATER LEVEL	WATER VOLUME in L		LAUNDRY LOAD in Kg	DETERGENT in g	
	6.5/7 Kg	8 Kg		6.5/7 Kg	8 Kg
10	60	62	>5 Kg	60	62
9	54	54	5 Kg	54	54
8	44	44	~4 Kg	44	44
7	42	42	~3.5 Kg	42	42
6	40	40	~3 Kg	40	40
5	38	38	~2.5 Kg	38	38
4	36	36	~2 Kg	36	36
3	33	33	~1.5 Kg	33	33
2	30	30	~1 Kg	30	30
1	26	26	~0.5 Kg	26	26

Note The water volume listed above is for a normal load. Use low or mild foam powder. The detergent dosage varies across wash programs. If the washing machine does not run properly, adjust the laundry load or Water Level.

Running Your Machine

Wash Programs—Default Selection

	WATER LEVEL	TEMPERATURE	WASH TIME min	SOAK	AIR DRY	RINSE CYCLES	SPIN TIME min
--	-------------	-------------	------------------	------	---------	-----------------	---------------

PROGRAM

Mix/Daily	10	Cold	15	—	—	2	4
Cotton	10	Cold	5	10	—	2	5
Express 30'	5	Cold	5	—	—	1	2
Synthetic	10	Cold	5	—	—	1	2
Delicates	7	Cold	5	—	—	1	1
Saree	10	Cold	5	—	—	3	1
Bulky	10	Cold	15	—	—	3	7
Baby Wear	8	Cold	10	—	—	2	5
Uniform	8	Cold	10	—	—	2	6
Rinse+Spin	10	Cold	—	—	—	1	5

Note Depending on inlet water pressure, water hardness, quantity and type of textile, detergent used, unbalance detection, ambient condition, selected additional functions and input power supply fluctuations, the actual values given in the User Manual or with the machine can deviate from the declared standard values as they are tested according to laboratory conditions.

The design and specifications (including colours/shades/aesthetics/ features etc) are subject to change without prior notice due to continuous improvement and product development.

* Program setting for BEE test in conformity with IEC 60456.

To select BEE Energy saving program

- Press Power button to turn ON the washing machine.
- Press Program button to select Cotton program with Water Level 10, Wash 15 mins, Rinse 1, Spin 5 mins, Soak 0.

Running Your Machine

Wash Guide Map

	WATER LEVEL	WASH TIME min	SOAK	AIR DRY	RINSE CYCLES	SPIN TIME min	DELAY	LAUNDRY WEIGHT Kg
--	-------------	---------------	------	---------	--------------	---------------	-------	-------------------

PROGRAM

Mix/Daily	1~10	0~20	0~30	✓	0~5	0~9	✓	Rated Capacity
------------------	------	------	------	---	-----	-----	---	----------------

Temperature °C Cold

Cotton	1~10	0~20	0~30	✓	0~5	0~9	✓	Rated Capacity
---------------	------	------	------	---	-----	-----	---	----------------

Temperature °C Cold

Express 30'	1~10	0~20	0~30	✓	0~5	0~9	✓	2
--------------------	------	------	------	---	-----	-----	---	---

Temperature °C Cold

Synthetic	6~10	0~20	0~30	✗	0~5	0~3	✓	4
------------------	------	------	------	---	-----	-----	---	---

Temperature °C Cold

Note Note Number of program varies from model to model; some of the programs may not be available in few models. 6.5 Kg-6 Programs, 7.0 Kg-8 Programs, 8.0 Kg-10 Programs



Option available for selection



Option not available for selection

Running Your Machine

Wash Guide Map

	WATER LEVEL	WASH TIME min	SOAK	AIR DRY	RINSE CYCLES	SPIN TIME min	DELAY	LAUNDRY WEIGHT Kg
--	-------------	---------------	------	---------	--------------	---------------	-------	-------------------

PROGRAM

Delicates	6~10	0~20	✗	✗	0~5	0~3	✓	2
------------------	------	------	---	---	-----	-----	---	---

Temperature °C Cold

Saree	6~10	0~20	✗	✗	0~5	0~3	✓	4
--------------	------	------	---	---	-----	-----	---	---

Temperature °C Cold

Bulky	6~10	0~20	0~30	✓	0~5	0~9	✓	4
--------------	------	------	------	---	-----	-----	---	---

Temperature °C Cold

Baby Wear	1~10	0~20	0~30	✗	0~5	0~9	✓	4
------------------	------	------	------	---	-----	-----	---	---

Temperature °C Cold

Note Note Number of program varies from model to model; some of the programs may not be available in few models. 6.5 Kg-6 Programs, 7.0 Kg-8 Programs, 8.0 Kg-10 Programs



Option available for selection



Option not available for selection

Running Your Machine

Wash Guide Map

	WATER LEVEL	WASH TIME min	SOAK	AIR DRY	RINSE CYCLES	SPIN TIME min	DELAY	LAUNDRY WEIGHT Kg
--	-------------	---------------	------	---------	--------------	---------------	-------	-------------------

PROGRAM

Uniform	1~10	0~20	0~30	✓	0~5	0~9	✓	4
----------------	------	------	------	---	-----	-----	---	---

Temperature °C Cold

Rinse+Spin	1~10	✗	✗	✓	0~5	0~9	✓	Rated Capacity
-------------------	------	---	---	---	-----	-----	---	----------------

Temperature °C Cold

Tub Clean	10	0~20	0~30	✗	✗	6	✗	✗
------------------	----	------	------	---	---	---	---	---

Temperature °C Cold

Note Note Number of program varies from model to model; some of the programs may not be available in few models. 6.5 Kg-6 Programs, 7.0 Kg-8 Programs, 8.0 Kg-10 Programs



Option available for selection



Option not available for selection

Running Your Machine

Key Features

FABRICS FOR LIFE

DeepClean® Powered by Ai



The intuitive sensing logic in the machine—

- Detects the Load
- Optimises Water Level
- Optimises Wash Program



The Ai model, based on thousands of parameters, selects the optimised configuration suitable for the laundry.



Thus it helps in reducing the washing time and water consumption while ensuring the best care for your clothes without any manual intervention.

Running Your Machine

Key Features

ADVANCED WASH TECHNOLOGY

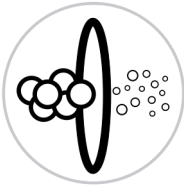

Aqua Energie

The technology that energises water to carry the detergent deep into the fabric.



Triadic Pulsator

Soft Scrub Pads

Gently scrubs off stubborn dirt.

Swirl Jets

Powerful water jets remove the dirt from every corner of the fabric.

Centre Punch Gentle mechanical action squeezes the dirt out.

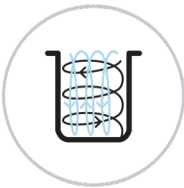

Bi-Axial Clothes Rotation

Clothes rotate horizontally and tumble vertically for a 360° wash. Dirt is loosened from the fabric and washed away.

Running Your Machine

Key Features

ADVANCED WASH TECHNOLOGY



Crescent Moon Drum

The crescent moon design of the drum allows the water to cushion the wash and protect the fabric.

Key Features

WASH PROGRAMS AND OPTIONS

Thoughtfully designed programs and options to give your clothes the ultimate wash experience.

Time, Water Saving

Express 30'
Mix/Daily

Fabric Friendly Wash (available in select models)

Bulky—blankets/curtains
Delicates
Synthetic
Cotton
Saree

Hygienic Wash (available in select models)

Baby Wear
Tub Clean

Customisable Modes (available in select models)

Uniform
Favourite

Key Features

MACHINE CARE



Auto Tub Clean

Automatically ensures tub hygiene after the wash.



High-Low Voltage Protection

A microcontroller continuously monitors the voltage fluctuations and stops the program if it goes below $165 \pm 10V$ or rises above $270 \pm 10V$. The program will resume once the voltage is within a safe range.



Program Memory Backup

The program remembers where to pick up from when power is restored after failure, thus saving on time, water, and energy, while adding longevity to the machine.



Auto Imbalance System

This system automatically balances the clothes inside to stabilise the spin cycle.

Running Your Machine

Key Features

USER CONVENIENCE



Child Lock

Locks the machine settings—prevents children from accidentally changing them.



Auto Softener Dispenser (available in select models)

A special compartment where you can add softener before you start the wash.



Bleach Dispenser

A special inlet to add bleach to the wash.

Air Dry Option

Fresh air comes in from the exchange window. This enables clean, hygienic drying.

Running Your Machine

Key Features

USER CONVENIENCE



Wheels

Allow you to easily move the machine. Just tilt the machine and move around as needed for cleaning or to change location.



Lint Tower Filter

Effectively captures fine fabric fibres floating inside the tub. This prevents them from getting onto other clothes.

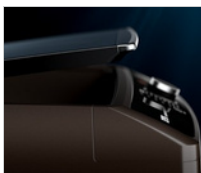

Soft Closing

The door slowly slides and shuts softly when released. Not banging it hard helps to prolong the life of the door.

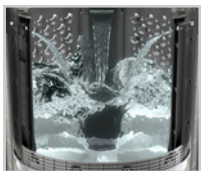

Shower Rinse

A jet sprays water evenly over your clothes for optimum washing and rinsing.

Get More From Your Machine

Tips for best results

BEFORE WASHING



Empty all pockets, remove everything including coins, keys, clips, bolts, nuts, notes, safety pins etc. Do not put sharp metal objects in the machine. Close all zips and fasten all hooks.

Check the wash care label. Avoid washing any non-machine washable items.

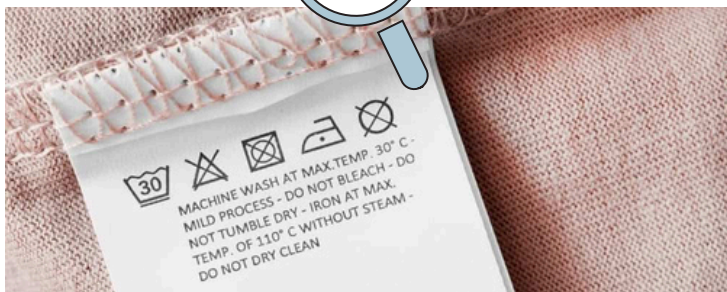

WHILE SORTING



Separate polyester fabrics from cotton.

Try to have a mix of large and small clothes in each load.

Wash dark clothes separately.



Get More From Your Machine

Tips for best results

WHILE LOADING



Load large items first.

Don't wash single items, add similar items.

Place small items in a laundry bag.

EASY TIPS TO REMOVE STAINS

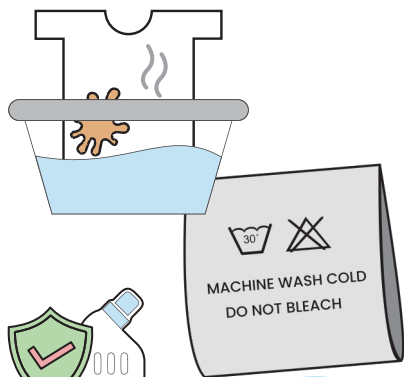

Soak or pre wash the stained laundry in warm water.

Try to wash immediately after staining.

Understand the fabric, the nature of the stain and check the wash care label before treating it.

Start with cold or warm water as hot water can set the stain in.

Use fabric safe bleach if recommended.

Put the stained area face down on a paper towel or white cloth.

Apply the stain remover to the back of the stain so that the stain is forced out of the cloth.

You can also use IFB Fabo Stain Remover for stubborn stains



SECTION

3

Get More From Your Machine

Stain Treatment



Get More From Your Machine

Stain Treatment

STAIN	TREATMENT
Chewing gum Adhesive Tape Rubber Cement	Use ice in a plastic bag to harden the gum. Scrape off what you can and then sponge with white spirits.
Blood	Rinse and soak immediately in cold water with an enzyme pre wash.
Chocolate Cocoa	<p>Sponge with cold water and soak in enzyme pre wash.</p> <p>Rub in a little detergent and rinse in cold water.</p>
Coffee	Rinse in cold water. Rub in detergent and wash in the maximum temperature allowed for the fabric.
Cream Milk Ice-cream	<p>Rinse in cold water and wash normally.</p> <p>Sponge with white spirits.</p>
Deodorant	<p>Rub affected area with white vinegar and then rinse in cold water.</p> <p>Sponge with white spirits and then treat stiffened areas with an enzyme pre wash.</p>
Egg	Soak in cold enzyme pre wash, rinse and wash.
Fabric Softener	Rub affected areas with bar soap and wash.

Get More From Your Machine

Stain Treatment

STAIN	TREATMENT
Fruit	Treat as soon as possible by sponging with cold water. Rub a little detergent on the stain and wash.
Grass	Sponge with white spirits. Rub in an enzyme pre wash and then wash.
Grease Oil	Sponge with white spirits or dry-cleaning fluid and then wash.
Iron Rust	Apply lemon juice and salt and place in the sun before washing.
Collars Cuffs Cosmetics	Pre-treat with a pre wash stain remover or rub with a bar soap.
Mildew	Rub affected area with white vinegar and then rinse in cold water. Sponge with white spirits and then treat stiffened areas with an enzyme pre wash.
Mud	Brush off the mud and rinse in cold water. Rub a little detergent and wash.
Oil Paint	Scrape off any fresh paint. Sponge with a non-flammable dry cleaning fluid and wash.

Get More From Your Machine

Stain Treatment

STAIN	TREATMENT
Water Based Paint	Treat while still wet. Rinse in warm water and wash.
Scorch Marks	Dampen a cloth with hydrogen peroxide. Lay it over the affected area and press with a hot iron.
Ink	Some inks are impossible to remove. However, try using a pre wash stain remover, denatured alcohol or non-flammable dry cleaning fluid.
Nail Polish	Try applying nail polish remover to the back of the stain. Blot with paper towels and repeat. Don't use acetate fabrics. However, it may be impossible to remove in some cases.
Shoe Polish	<p>Liquid Pre-treat with a paste of granular detergent and water.</p> <p>Paste Scrape the residue and pre-treat with a pre wash stain remover or non-flammable dry cleaning liquid. Apply detergent to the dampened area and wash using bleach safe for the fabric.</p>
Candle Wax Crayon	Scrape off surface wax. Press with warm iron until wax is absorbed into a paper towel. Treat remaining stain with a pre wash stain remover or non-flammable dry cleaning fluid. Hand wash to remove solvent and wash using bleach safe for the fabric.

Get More From Your Machine

Maintenance and Cleaning

CLEANING YOUR WASHING MACHINE



Exterior

Use a soft, damp cloth or sponge to wipe detergent, bleach, and other spills. Wipe the outside of the washing machine occasionally.

Run the Tub Clean Program

Use a non-corrosive descalant and follow the manufacturer's instructions. Do not put any laundry in the machine.

CLEANING THE DETERGENT DISPENSER DRAWER

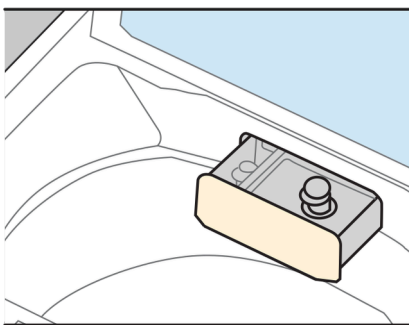

Remove detergent residue regularly. Clean the detergent dispenser drawer with warm water.

Remove and clean the siphon under running warm water.

Detergent residue can build in the dispenser housing, clean it before reinstalling the dispenser.

Get More From Your Machine

Maintenance and Cleaning

CLEAN THE WATER INLET FILTER

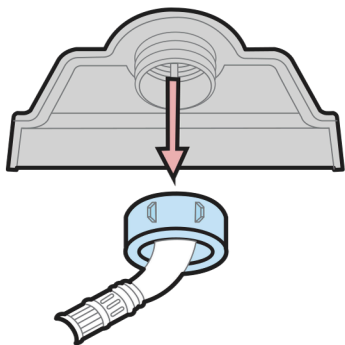

Turn OFF taps.

Remove water from the washing machine completely. Select water temperature to warm and then press the Start/Pause button.

Turn OFF the power and disconnect the cable.

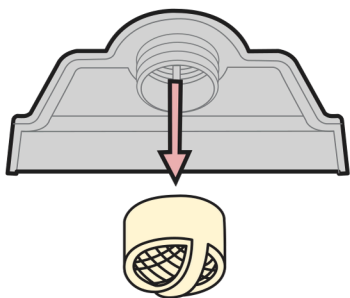

Pull the Inlet Filter out of the Inlet Valve to separate. Clean the Inlet Filter with a brush. Reconnect when done.

Turn ON the water tap to check if the connection is watertight.

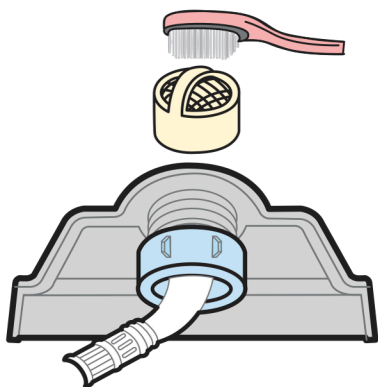

Note Dirt, sediments or sand in the water can affect both your wash quality and the water valve.

Get More From Your Machine

Maintenance and Cleaning

CLEAN THE LINT TOWER FILTER

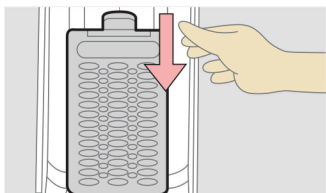

The filter should be cleaned frequently in order to increase the life of the machine.

Push the upper part of the Tower Filter and pull it out.

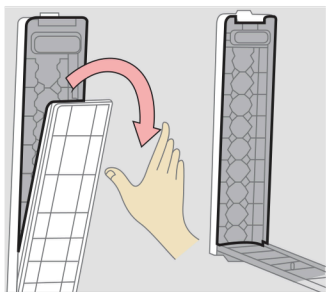

Open the Tower Filter inner and remove the dirt.

Don't open the filter when a program is running.

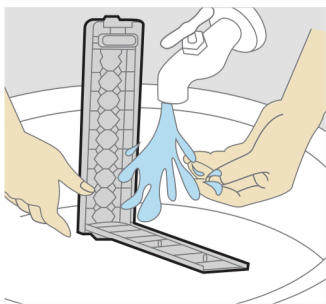

Fix it back in the same position when done.

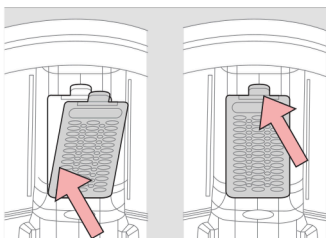

Get More From Your Machine

Maintenance and Cleaning

WINTER—STORING THE MACHINE OR MOVING IT

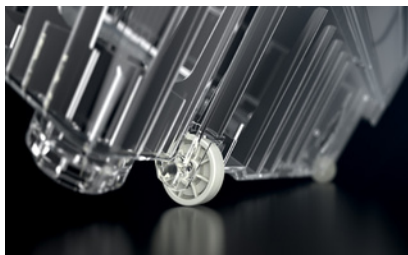

Turn OFF the tap. Disconnect and drain the water inlet hoses. Run the washing machine on Drain and Spin setting for 1 min. Unplug the power cable.

The wheels are for easy moving. Store the machine where it will not freeze. Leftover in the hoses can freeze and affect the machine.

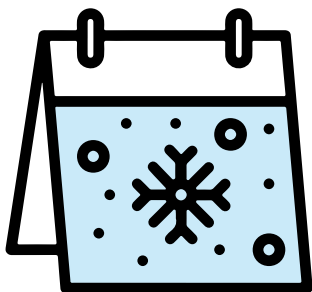

To use the machine again flush the water pipes, hoses and reconnect them. Turn ON the tap. Reconnect the power cable.

GOING ON VACATION?



If you are going on a holiday or do not plan to use the machine for an extended period of time— Disconnect the power supply. Turn OFF the tap to avoid accidental flooding which happens due to water pressure surges.

Get More From Your Machine

Let's make washing easier.

Here is a list of clothes and their approximate weights to help you figure out a perfect wash load.

CLOTHING WEIGHTS

Bottoms

Lungi/Dhoti	200 g
Skirts	200 g
Trousers	250 g
Jeans	400 g

Tops

Cotton Shirts	280 g
Other Shirts	200 g
Cotton Blouses	140 g
Other Blouses	100 g
Woollen Sweaters	400 g
Heavy Sweaters	300 g
Light Sweaters	150 g

Other Clothes

Cotton Sarees	650 g
Synthetic Sarees	350 g
Bath Towels	600 g
Hand Towels	250 g
Pyjama Kurta	400 g
Panties	60 g
Cotton Vests	100 g
Underslips	100 g
Long Socks, 2 pairs	150 g
Short Socks, 2 pairs	85 g
6 Handkerchiefs	85 g
12 Napkins	1.1 Kg

Sheets

Cotton (Double)	1 Kg
Cotton (Single)	500 g
Non Cotton (Double)	650 g
Non Cotton (Single)	400 g

Pillow slips

Cotton Pillow Slips	110 g
Other Pillow Slips	85 g

Table Cloths

Small	230 g
Large	600 g
Table Napkins (4)	150 g

Bedspread

3 Kg

Blankets

Wool	2 Kg
Acrylic	1.5 Kg

Get More From Your Machine

This table may help you plan a laundry load of 6.5, 7, 8 Kg.

LAUNDRY ITEMS	6.5 Kg	7 Kg	8 Kg
Bath Towels	2	2	2
Shirts	4	4	4
Blouses	2	3	3
Skirts	3	4	5
Pair of Pants	1	1	1
Pair of Jeans	2	2	3
T-shirts	3	3	4
Set of Pyjamas	4	4	4
Tea Towels	2	2	4

The chart indicates average weights of clothes. Make sure not to overload your machine beyond the recommended weight. This way, your clothes will get a thorough wash. Suggested weights are approximate and may vary.

Useful Information About Your Washing Machine

Display



THE LED DISPLAY GIVES YOU COMPLETE INFORMATION

- Program Selection
- Wash Option Selection
- Program Time Left
- Program Status
- Problem/Fault Indications, if any
- Child Lock Selection
- Display Messages & Error Codes

Useful Information About Your Washing Machine

Troubleshooting, Display Messages & Error Codes

In case of machine malfunction, check the following points for a solution. Error Codes are displayed on the screen. For any code displayed that is not present in the following list or if the suggested solution does not fix the problem, contact IFB Care or an authorised dealer.

DISPLAY	PROBLEM	CHECK POINT
	The machine is not working	<p>Is there a power failure? Turn ON the power switch. Plug the electrical power cord in securely and check. Check the fuse. Press the Start/Pause button.</p>
tAP	<p>No/low water pressure tAP Error message when the water supply is not finished within 10 mins</p>	<p>Ensure that the Water supply tap is turned ON. Clean and unclog the inlet hose filter. Check if it is fitted properly. Is the Hot Inlet Hose connected to the Cold Valve, and/or vice versa? Low water pressure; operations will restart when water supply is normal.</p>
	tAP Continuous water supply	<p>Check the pressure tube and fix if loose or leaking. Inlet valve, pressure sensor or PCB could be defective.</p>

If the problem persists, contact IFB Care.

Useful Information About Your Washing Machine

Troubleshooting, Display Messages & Error Codes

DISPLAY	PROBLEM	CHECK POINT
Unb	The washer will not spin Unb	The laundry collects on one side of the drum during Spin; unbalancing it—the program autocorrects this. If message is still displayed you can spread out the laundry evenly on all sides. Check and level the machine on a flat surface.
dor	dor	Indicates that the door is not closed securely. Check and close.
drE	The washer will not drain drE Error message when draining is not finished within ~20 mins	Check if the drain hose is frozen. Clean and unclog the drain hose filter. Check if it is fitted properly. The end of the drain hose should not be immersed in water. The drain hose should not be more than 10 cm above the ground, don't place it too high. Straighten the bend or twisted hose. In case of damage it needs to be replaced.

If the problem persists, contact IFB Care.

Useful Information About Your Washing Machine

Troubleshooting, Display Messages & Error Codes

DISPLAY	PROBLEM	CHECK POINT
ACH	Input voltage is too high ACH	Machine will start automatically after the voltage decreases to a safe operating level. If this error display persists/occurs frequently, contact your electrician to locate the fault in the electrical system.
ACL	Input voltage is too low ACL	Machine will start automatically after the voltage increases to a safe operating level. If this error display persists/occurs frequently, contact your electrician to locate the fault in the electrical system.
FrH FrL	Input frequency is too high or low FrH FrL	Machine will start automatically after the frequency increases or decreases to a safe operating level. If this error display persists/occurs frequently, contact your electrician to locate the fault in the electrical system.

If the problem persists, contact IFB Care.

Useful Information About Your Washing Machine



Troubleshooting, Display Messages & Error Codes

DISPLAY	PROBLEM	CHECK POINT
LSE	Load sensing error LSE	<p>The load sensing (detects the weight of load) is inferior.</p> <p>Press the Power button to turn the power OFF.</p> <p>Press the Power button to turn the power ON.</p> <p>Operate your washing machine again. This error will also be displayed in case of overloading of clothes/motor, overload/clutch malfunction or incorrect belt tension. If the error display persists or occurs frequently, contact IFB Care.</p>
PrS	Water level sensing error PrS	<p>Switch OFF the washing machine, wait for 2 secs and restart. If the same message appears again, turn OFF the tap, switch OFF the appliance and contact IFB Care.</p>

If the problem persists, contact IFB Care.

Useful Information About Your Washing Machine

Troubleshooting, Display Messages & Error Codes

DISPLAY	PROBLEM	CHECK POINT
	Motor error eEr	There is a problem with the motors. Switch OFF the washing machine and switch it ON again. Start the machine. If the problem and/or the display persists, contact IFB Care.
	Capacitor error CPE	The running capacitor is defective (open error). The clothes are overloaded (more than maximum capacity). The motor is overload. Contact IFB Care.

If the problem persists, contact IFB Care.

For further assistance please download My IFB App for service registrations or you call us on our call centre number

08045845678/ 080 695 45678

Useful Information About Your Washing Machine

Technical Specifications

MODEL	6.5Kg/7 Kg/8 Kg
POWER SUPPLY	AC 220-240V/50 Hz
DIMENSIONS mm Net Size WxDxH	543x575x912 (650 models) 543x575x946 (701/801models)
NEW WEIGHT	31 Kg
CAPACITY	6.5 Kg of dry cotton (6.5 Kg) 7.0 Kg of dry cotton (7.0 Kg) 8.0 Kg of dry cotton (8.0 Kg)
WASH CARE PROGRAMS	6 Programs (6.5 Kg) 8 Programs (7.0 Kg) 10 Programs (8.0 Kg)
SELECTOR BUTTONS	Start/Pause, Soak, Wash, Water, Rinse/Child Lock, Spin/Air Dry, Delay/Tub Clean, Power, Programs
PROGRAM SELECTOR	Program Button
PROGRAM CONSUMPTION	Refer to the product label
WATER CONSUMPTION	≤ 23 Ltr/Kg/Cycle (Cotton*) *Program settings for BEE test in conformity with IEC 60456.
WATER PRESSURE	0.3 Bar-8 Bar (3.5 Ltr-8 Ltr/min)
POWER RATING	Refer to the product label
DRUM	Stainless Steel

TRUSTED BY OVER
9 MILLION
CUSTOMERS



+91 080 458 45678/080 695 45678

     +91 92310 04321

www.ifbappliances.com