

# NINJA®

**DT200**  
Series

**OWNER'S GUIDE**

## **FOODI™ XL PRO AIR OVEN**





# THANK YOU

for purchasing the Ninja® Foodi™ XL Pro Air Oven



## REGISTER YOUR PURCHASE

 [registeryourninja.com](http://registeryourninja.com)

 Scan QR code using mobile device

## RECORD THIS INFORMATION

Model Number: \_\_\_\_\_

Serial Number: \_\_\_\_\_

Date of Purchase: \_\_\_\_\_  
(Keep receipt)

Store of Purchase: \_\_\_\_\_

## TECHNICAL SPECIFICATIONS

Voltage: 120V~, 60Hz

Watts: 1800W

**TIP:** You can find the model and serial numbers on the QR code label on the base of the unit.

# CONTENTS

<b>Important Safeguards</b> .....	<b>2</b>
<b>Parts</b> .....	<b>4</b>
<b>Accessory Placement</b> .....	<b>5</b>
<b>Before First Use</b> .....	<b>5</b>
<b>Using the Control Panel</b> .....	<b>6</b>
Functions .....	6
Control Panel Display & Operating Buttons .....	7
<b>Using Your Foodi™ XL Pro Air Oven</b> .....	<b>8</b>
When to Use the Roast Tray .....	8
Using the Cooking Functions with Rack Levels .....	8
How to Reduce Smoke .....	9
Using the Cooking Functions .....	10
Whole Roast .....	10
Air Roast .....	10
Air Fry .....	11
Bake .....	11
Dehydrate .....	12
Broil .....	12
Toast .....	12
Bagel .....	13
Pizza .....	13
Reheat .....	13
<b>Cleaning &amp; Maintenance</b> .....	<b>14</b>
Everyday Cleaning .....	14
Deep Cleaning .....	14
<b>Accessories for Purchase</b> .....	<b>15</b>
<b>Troubleshooting &amp; FAQ</b> .....	<b>15</b>
<b>Replacement Parts</b> .....	<b>16</b>
<b>Warranty</b> .....	<b>17</b>

# IMPORTANT SAFEGUARDS

HOUSEHOLD USE ONLY • READ ALL INSTRUCTIONS BEFORE USE

When using electrical appliances, basic safety precautions should always be followed, including the following:

## ⚠ WARNING

- 1 Read all instructions prior to using the oven and its accessories.
- 2 This appliance can be used by persons with reduced physical, sensory or mental capabilities or lack of experience and knowledge if they have been given supervision or instruction concerning use of the appliance in a safe way and understand the hazards involved.
- 3 If food contents were to catch fire during cooking, **DO NOT** open the oven door.
  - If you can safely do so, unplug the oven immediately.
  - **DO NOT** throw water onto the fire. Food contents may contain grease and water may cause fire growth.
  - If fire were to emit from the oven door, call the fire department immediately.
  - **DO NOT** use the oven after it has experienced a fire, it may have been damaged and present a risk of fire or shock.
- 4 To eliminate a choking hazard for young children, discard all packaging materials immediately upon unpacking.
- 5 Take inventory of all contents to ensure you have all parts needed to properly and safely operate your oven.
- 6 **DO NOT** use an extension cord. A short power-supply cord is used to reduce the risk of children grabbing the cord or becoming entangled and to reduce the risk of people tripping over a longer cord.
- 7 **NEVER** use outlet below counter level.
- 8 Keep the appliance and its cord out of reach of children. Do not allow the appliance to be used by children. Close supervision is necessary when used near children.
- 9 **DO NOT** let cord hang over edges of tables or counters or touch hot surfaces, including stoves and other heating ovens.
- 10 **NEVER** leave the oven unattended while in use.
- 11 **DO NOT** place any object directly onto the heating elements and **DO NOT** cover crumb tray or any part of the oven with aluminum foil. This will cause the oven to overheat or cause a fire.
- 12 **DO NOT** use the oven with crumb tray incorrectly installed. Crumb tray **MUST** be placed below lower heating elements.
- 13 To protect against electrical shock **DO NOT** immerse cord, plugs, or main unit housing in water or other liquid.
- 14 **DO NOT** use the oven with damage to the power cord or plug. Regularly inspect the oven and power cord. If the oven malfunctions or has been damaged in any way, immediately stop use and call Customer Service.
- 15 **DO NOT** cover the air intake vents or air outlet vents while unit is operating. Doing so will prevent even cooking and may damage the unit or cause it to overheat.
- 16 **DO NOT** insert anything in the ventilation slots and do not obstruct them.
- 17 **DO NOT** place items on top of surface while unit is operating except for authorized recommended Ninja® accessories.
- 18 Before placing any accessories into the oven ensure they are clean and dry.
- 19 Intended for countertop use only. **DO NOT** place the oven near the edge of a countertop on or near a hot gas or electric burner. Ensure the surface is level, clean and dry.
- 20 This oven is for household use only. **DO NOT** use this oven for anything other than its intended use. Misuse may cause injury.
- 21 **DO NOT** store any materials, other than supplied accessories, in this oven when not in use.
- 22 **DO NOT** use outdoors. **DO NOT** use in moving vehicles or boats.
- 23 **DO NOT** use accessory and attachments not recommended or sold by SharkNinja.

- 24 When using this oven, provide adequate space (at least 1 inch above and on all sides) for air circulation.
- 25 A fire may occur if the oven is covered or touching flammable material, including curtains, draperies, walls, or the like when in operation.
- 26 This oven has a tempered glass door and is more resistant to breakage. Avoid scratching door surface or nicking edges.
- 27 **DO NOT** place anything directly on heating elements and **DO NOT** use the oven without a wire rack or air fry basket installed.
- 28 **DO NOT** spray any type of aerosol spray or flavoring inside the oven while cooking.
- 29 Use caution when inserting and removing anything from the oven, especially when hot.
- 30 Outlet voltages can vary, affecting the performance of your product. To prevent possible illness, use a thermometer to check that your food is cooked to the temperatures recommended.
- 31 Prevent food contact with heating elements. Excessive food loads may cause personal injury or property damage or affect the safe use of the oven.
- 32 Oversize foods or metal utensils must not be inserted in a toaster oven as they may create a fire or risk of electric shock.
- 33 With the exception of parchment paper, **DO NOT** place any of the following materials in the oven: paper, cardboard, plastic, roasting bags and the like.
- 34 Extreme caution should be exercised when using containers constructed of any materials other than metal or glass.
- 35 **DO NOT** touch hot surfaces. Oven surfaces and glass door are hot during and after operation. To prevent burns or personal injury, **ALWAYS** use protective hot pads or insulated oven mitts and use available handles.
- 36 Spilled food can cause serious burns. Extreme caution must be used when the oven contains hot food. Improper use may result in personal injury.
- 37 Please refer to the Cleaning & Maintenance section for regular maintenance of the oven.
- 38 Cleaning and user maintenance shall not be done by children.
- 38 Allow to cool completely before cleaning and moving for storage.
- 40 When not in use, turn any control to 'off', then unplug. Grasp the plug by the body and pull from the outlet. Never unplug by grasping and pulling flexible cord.
- 41 **DO NOT** clean with metal scouring pads. Pieces can break off the pad and touch electrical parts, causing a risk of electrical shock.
- 42 **DO NOT** use the oven as a source of heat or for drying.
- 43 This appliance has important markings on the plug blade. The entire supply cord is not suitable for replacement. If damaged, please contact SharkNinja for service.



Indicates to read and review instructions to understand operation and use of product.



Indicates the presence of a hazard that can cause personal injury, death or substantial property damage if the warning included with this symbol is ignored.



Take care to avoid contact with hot surface. Always use hand protection to avoid burns.



For indoor and household use only.

## SAVE THESE INSTRUCTIONS

## PARTS

- A** Main Unit  
(attached power cord not shown)

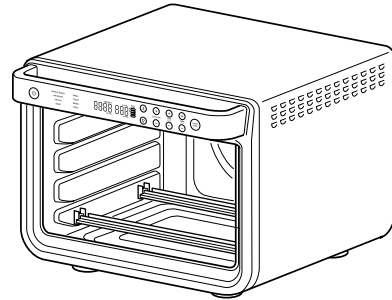

- B** Air Fry Basket

Install when using the air fry function. Hand-wash recommended.

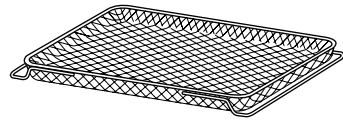

- C** Roast Tray

Fits on top of the sheet pan to catch grease below roasted or air fried foods to reduce smoke and grease splatter. Hand-wash only.

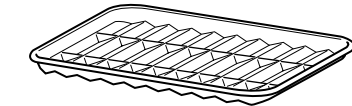

- D** Sheet Pan(s)

Place on top of the wire rack. Hand-wash only. Additional sheet pan is not available on all models.

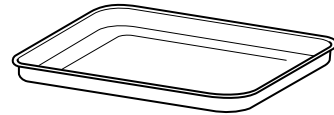

- E** 2 Wire Racks

Use on its own or place the sheet pan on top. Hand-wash recommended.

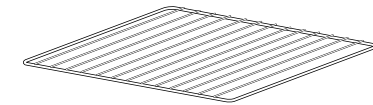

- F** Removable Crumb Tray  
(already installed in unit)

Must remain installed when the oven is in use. Hand-wash only.

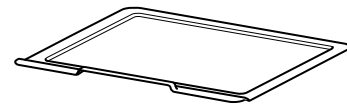

**IMPORTANT:** Place crumb tray below lower heating elements. **DO NOT** slide into any rack positions.

### COMMON-SENSE PRACTICES/GOOD HABITS:

- **DO NOT** leave your toaster oven unattended while making food. If possible, unplug the oven while not in use to eliminate the possibility of accidents occurring.
- Have a fire extinguisher or fire containment blanket handy in a safe, known location. If you don't have a fire extinguisher, douse the flames with baking soda until they are put out.
- If a fire occurs and the food in the oven is not greasy, immediately unplug the unit and douse the flames with water until the fire is extinguished. **DO NOT** use water if grease is present, since it could make the fire worse. Use baking soda instead.

## ACCESSORY PLACEMENT

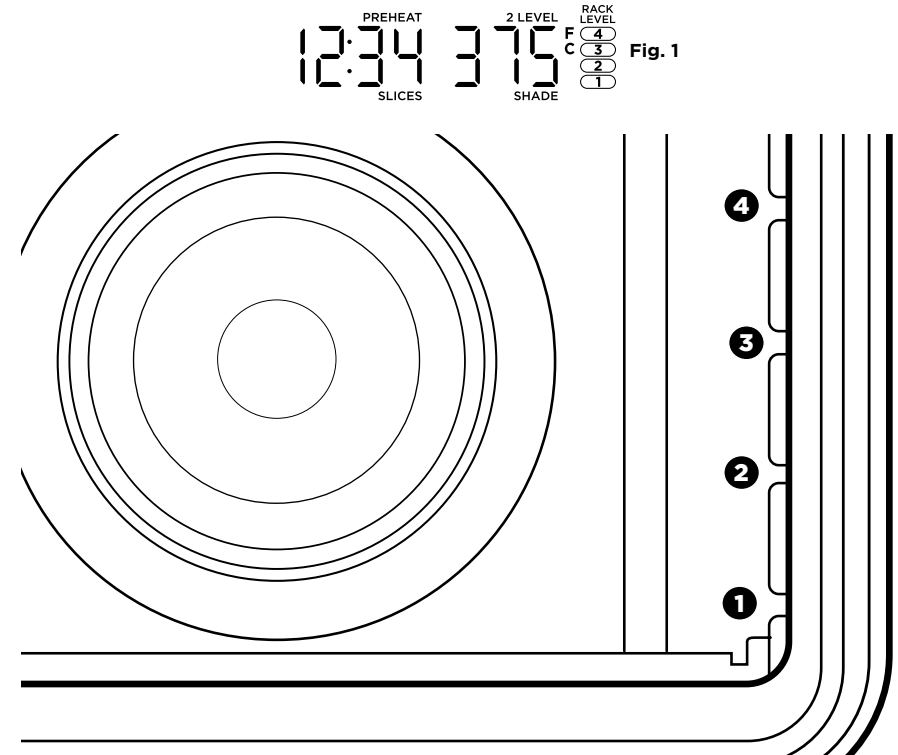

The oven has 4 available rack positions where your accessories can slide into the unit (**see image above**). When you select a function, the corresponding rack number(s) will illuminate on the control panel. The numbers on the control panel (**see Fig. 1**) will coincide with those on the interior of the unit. See the chart on page 8 for further details.

## BEFORE FIRST USE

- 1 Remove and discard any packaging material, promotional labels, and tape from the unit.
- 2 Remove all accessories from the package and read this manual carefully. Please pay particular attention to operational instructions, warnings, and important safeguards to avoid any injury or property damage.
- 3 Wash the air fry basket, sheet pan, wire rack, roast tray, and removable crumb tray in warm, soapy water, then rinse and dry thoroughly. **DO NOT** put sheet pan, roast tray, or removable crumb tray in the dishwasher. Finishes may degrade. **NEVER** submerge the main unit in water.
- 4 We recommend placing all accessories inside the oven and running it on Air Roast at 450°F for 20 minutes without adding food. This removes any residues. This is completely safe and not detrimental to the performance of the oven.

**NOTE:** The accessories are hand-wash recommended. The air fry basket and wire racks can be put in the dishwasher, but may wear more quickly over time.

# USING THE CONTROL PANEL

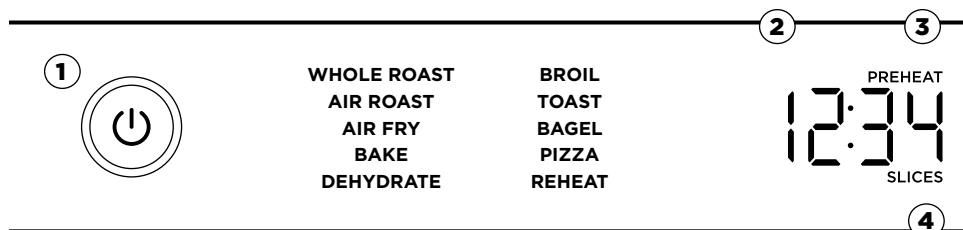

## FUNCTIONS

Once you've selected a function below, you can change temperature/shade and time/slices.

**WHOLE ROAST:** Simultaneously roast large proteins, like a 5-lb chicken, and sides for a complete meal. Or cook a larger protein, like a 12-lb turkey, on its own.

**AIR ROAST:** Achieve a crispy outside and perfectly cooked inside for full-sized sheet pan meals, thicker proteins, and roasted veggies.

**AIR FRY:** Foods that would traditionally be fried—such as chicken wings, French fries, and chicken nuggets—with little to no added oil.

**BAKE:** Evenly bake everything from your favorite cookies to cakes.

**DEHYDRATE:** Dehydrate meats, fruits, and vegetables for healthy snacks.

**BROIL:** Evenly broil meats, fish and brown the tops of casseroles.

**TOAST:** Toast up to 9 slices of bread to your desired level of darkness.

**BAGEL:** Perfectly toast up to 9 bagel halves when they're placed cut-side up on the wire rack.

**PIZZA:** Cook frozen or homemade pizzas evenly.

**REHEAT:** Heat leftovers without over cooking.

**NOTE:** The Dehydrate and Reheat functions are not included on all models.

**NOTE:** The oven's technology leads to faster cooking. Always monitor food to prevent overcooking. Refer to cook charts in the Inspiration Guide for more guidance on cook times and temperatures.

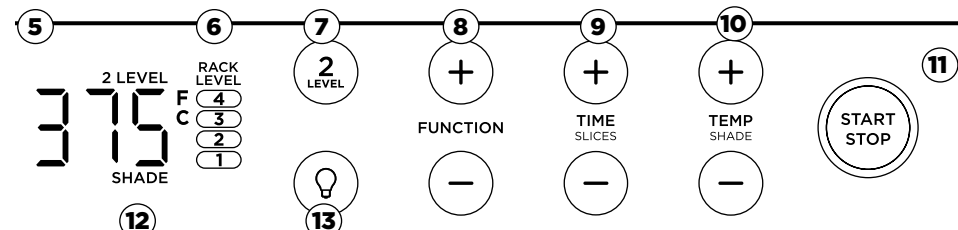

## CONTROL PANEL DISPLAY & OPERATING BUTTONS

- Power button:** Press to turn the unit on and off.
- Time display:** Shows the cook time. The time will count down when cooking is in progress.
- PREHEAT:** Flashes when the unit is preheating. If the oven is already up to temperature from using a previous cooking function, the unit will skip preheating.
- SLICES:** Illuminates when using the Toast or Bagel function to designate number of slices.
- Temperature display:** Shows the cook temperature.

**NOTE:** Time and temperature will always return to the settings used the last time the oven was in operation.

- RACK LEVEL:** Depending on the function you choose, the illuminated rack level(s) will indicate where your accessory should be placed in the unit.
- 2 LEVEL:** For functions that allow you to cook on 2 levels, press the button to select 2-level cooking and rack levels will update.
- FUNCTION +/- buttons:** To select a cooking function, press the FUNCTION +/- buttons.

**NOTE:** As you move through functions, you'll notice the rack level recommendations change for best results.

- TIME/SLICES +/- buttons:** To select a cook time, press the TIME +/- buttons. When using the Toast or Bagel function, these buttons will adjust the number of slices/bagel halves instead of the time. Time will increase in 1-minute increments under 1 hour and 5-minute increments over 1 hour. Hold the +/- buttons for 2 seconds to activate faster scrolling in 5-minute increments.
- TEMP/SHADE +/- buttons:** To adjust temperature, press the TEMP +/- buttons. When using the Toast or Bagel function, these buttons will adjust the shade level (1, lightest - 7, darkest) instead of the temperature. Temperature will increase in 5-degree increments. Hold the +/- buttons for 2 seconds to activate faster scrolling in 10-degree increments.

**NOTE:** The cook time and temperature may be adjusted at any time during the cooking cycle.

- START/STOP button:** Press to start or stop cooking.
- SHADE:** Illuminates when using the Toast or Bagel function to designate desired shade.
- Light button:** Press to turn the oven's interior light on and off.

**NOTE:** The light will automatically turn on when 1 minute of cook time remains and when door is open.

# USING YOUR FOODI™ XL PRO AIR OVEN

## WHEN TO USE THE ROAST TRAY

Use Roast Tray on Sheet Pan when cooking on convection functions (such as Whole Roast, Air Roast, and Air Fry), or with greasy foods like: whole chicken, chicken wings, bacon, marinated meats, or oiled vegetables.

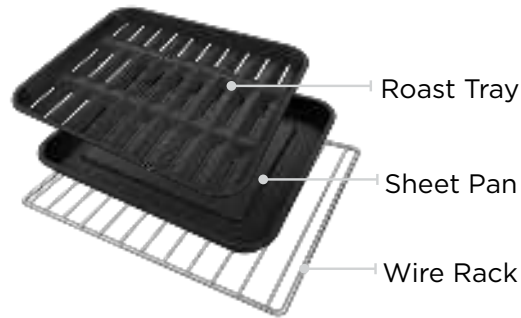

### Recommended for



Whole Chicken



Chicken Wings  
or Thighs



Bacon



Marinated Meats



Oiled Vegetables

## HOW TO REDUCE SMOKE

We recommend using canola, coconut, avocado, grapeseed, or vegetable oil instead of olive oil.



**Recommended:**  
Canola  
Refined coconut  
Avocado  
Vegetable  
Grapeseed



**Not recommended:**  
Olive oil  
Butter  
Margarine

The unit may produce smoke when cooking on a hotter setting than what is recommended.

**NOTE:** For more cooking charts, refer to your Inspiration Guide or visit [ninjakitchen.com](http://ninjakitchen.com).

## USING THE COOKING FUNCTIONS WITH RACK LEVELS

When you select a cooking function, the control panel will illuminate the recommended rack height(s). The chart below outlines these recommendations along with the suggested accessories. For best results, use only the recommended accessories for a given function and remove others from the oven.

	WHOLE ROAST		AIR ROAST		AIR FRY		BAKE	
	1 Layer	2 Layers	1 Layer	2 Layers	1 Layer	2 Layers	1 Layer	2 Layers
<b>LEVEL 4</b>		Air Fry Basket				Air Fry Basket		
<b>LEVEL 3</b>			Roast Tray on Sheet Pan	Air Fry Basket	Air Fry Basket		Sheet Pan on Wire Rack	Accessory on Wire Rack
<b>LEVEL 2</b>						Roast Tray on Sheet Pan		
<b>LEVEL 1</b>	Roast Tray on Sheet Pan	Roast Tray on Sheet Pan		Roast Tray on Sheet Pan	Roast Tray on Sheet Pan			Accessory on Wire Rack

**NOTE:** When cooking greasy, drippy foods on one level, place the Sheet Pan on the Wire Rack below to catch the drippings. Alternatively, use the Roast Tray on top of the Sheet Pan.

DEHYDRATE		BROIL	TOAST	BAGEL	REHEAT	PIZZA	
1 Layer	2 Layers	1 Layer	1 Layer	1 Layer	1 Layer	1 Layer	2 Layers
	Air Fry Basket						
Air Fry Basket		Roast Tray on Sheet Pan	Wire Rack	Wire Rack	Wire Rack	Wire Rack	Wire Rack
	Sheet Pan						
							Wire Rack

**NOTE:** Always place Sheet Pan on Wire Rack, **DO NOT** place directly on heating elements.

# USING YOUR FOODI™ XL PRO AIR OVEN - CONT.

## USING THE COOKING FUNCTIONS

To turn on the unit, plug the power cord into an outlet and press the  button. The unit will automatically shut off after 10 minutes of inactivity.

### Whole Roast

- 1 To select the function, press the function +/- buttons until WHOLE ROAST brightly illuminates. The default time and temperature settings will display. When cooking 2 layers, select the 2 LEVEL button so that "2 LEVEL" appears on the display.
- 2 Press the TIME/SLICES +/- buttons to select a cook time up to 4 hours.

**NOTE:** If cooking for 1 hour or less, the clock will count down by minutes and seconds. If cooking for more than 1 hour, the clock will count down by hours and minutes.

- 3 Press the TEMP/SHADE +/- buttons to select a temperature between 250°F-450°F.
- 4 Press START/PAUSE to begin preheating.

**NOTE:** Food cooks faster when using the Whole Roast function so refer to cook charts in the Inspiration Guide for more guidance on cook times and temperatures.

- 5 Place ingredients on the roast tray or directly on sheet pan. When the unit beeps to signify it has preheated, immediately place roast tray on the sheet pan on the wire rack on Level 1. Close oven door. When cooking on 2 levels, place the sheet pan on Level 1 and use the air fry basket as the second layer on Level 4.

**NOTE:** The timer will start counting down as soon as the unit has preheated. If ingredients are not ready to go into the oven, simply press the TIME +/- buttons to add more time.

- 6 When cook time is complete, the unit will beep and "END" will appear on the display.

### Air Roast

- 1 To select the function, press the function +/- buttons until AIR ROAST brightly illuminates. The default time and temperature settings will display. When cooking 2 layers, select the 2 LEVEL button so that "2 LEVEL" appears on the display.
- 2 Press the TIME/SLICES +/- buttons to select a cook time up to 4 hours.

**NOTE:** If cooking for 1 hour or less, the clock will count down by minutes and seconds. If cooking for more than 1 hour, the clock will count down by hours and minutes.

- 3 Press the TEMP/SHADE +/- buttons to select a temperature between 250°F-450°F.
- 4 Press START/PAUSE to begin preheating.

**NOTE:** Food cooks faster when using the Air Roast function, so refer to cook charts in the Inspiration Guide for more guidance on cook times and temperatures.

- 5 Place ingredients on the sheet pan. When the unit beeps to signify it has preheated, immediately place the roast tray on sheet pan on the wire rack on Level 1. Close oven door. When cooking on 2 levels, place the sheet pan on Level 1 and use the air fry basket as the second layer on Level 3.

**NOTE:** The timer will start counting down as soon as the unit has preheated. If ingredients are not ready to go into the oven, simply press TIME +/- buttons to add more time.

- 6 When cook time is complete, the unit will beep and "END" will appear on the display.

### Air Fry

- 1 To select the function, press the function +/- buttons until AIR FRY brightly illuminates. The default time and temperature settings will display. When cooking 2 layers, select the 2 LEVEL button so that "2 LEVEL" appears on the display.
- 2 Press the TIME/SLICES +/- buttons to select a cook time up to 4 hours.
- 3 Then press the TEMP/SHADE +/- buttons to select a temperature between 250°F-450°F.
- 4 Press START/PAUSE to begin preheating.

**NOTE:** Food cooks faster when using the Air Fry function. Refer to Air Fry Chart in the Inspiration Guide for more guidance on cook times and temperatures.

- 5 Place ingredients in the air fry basket and roast tray with sheet pan. If ingredients are fatty, oily, or marinated, place the basket on the sheet pan. Use air fry basket for dry ingredients.
- 6 When the unit beeps to signify it has preheated, immediately slide the basket into the rack level(s) designated on the control panel. If also using the sheet pan, slide both into the oven at the same time, with the basket in the upper rack and the pan on the wire rack beneath the basket. Close oven door.
- 7 When cook time is complete, the unit will beep and "END" will appear on the display.

**NOTE:** The timer will start counting down as soon as the unit has preheated. If ingredients are not ready to go into the oven, simply press the TIME +/- buttons to add more time.

### Bake

- 1 To select the function, press the function +/- buttons until BAKE brightly illuminates. The default time and temperature settings will display. When cooking 2 layers, select the 2 LEVEL button so that "2 LEVEL" appears on the display.
- 2 Press the TIME/SLICES +/- buttons to select a cook time up to 4 hours.

**NOTE:** If cooking for 1 hour or less, the clock will count down by minutes and seconds. If cooking for more than 1 hour, the clock will count down by hours and minutes.

- 3 Press the TEMP/SHADE +/- buttons to select a temperature between 180°F-450°F.
- 4 Press START/PAUSE to begin preheating.
- 5 Place ingredients on the sheet pan, air fry basket, cake pan, or casserole dish. When the unit beeps to signify it has preheated, immediately place the sheet pan on the wire rack. Close oven door.

**NOTE:** The timer will start counting down as soon as the unit has preheated. If ingredients are not ready to go into the oven, simply press the TIME +/- buttons to add more time.

- 6 During cooking, you can turn on the light  to check on progress.
- 7 When cook time is complete, the unit will beep and "END" will appear on the display.

**NOTE:** For best results with baked goods such as cookies, line the Ninja® Sheet Pan with parchment paper.

## USING YOUR FOODI™ XL PRO AIR OVEN – CONT.

### Dehydrate

**NOTE:** The unit does not preheat in Dehydrate mode.

- 1 To select the function, press the function +/- buttons until DEHYDRATE brightly illuminates. The default time and temperature settings will display. When dehydrating 2 layers, select the 2 LEVEL button so that “2 LEVEL” appears on the display.
- 2 Press the TIME/SLICES +/- buttons to select a dehydrate time up to 24 hours.
- 3 Press the TEMP/SHADE +/- buttons to select a temperature between 85°F–200°F.
- 4 Place ingredients in the air fry basket and place basket in oven. Close oven door and press START/PAUSE to begin cooking.

**NOTE:** For best results, lay ingredients flat on each layer; do not stack food.

- 5 When cook time is complete, the unit will beep and “END” will appear on the display.

**NOTE:** Purchase additional dehydrate accessory to dehydrate up to 4 levels at one time.

### Broil

**NOTE:** The unit does not preheat in Broil mode.

- 1 To select the function, press the function +/- buttons until BROIL brightly illuminates. The default time and temperature settings will display.
- 2 Press the TIME/SLICES +/- buttons to select a cook time up to 30 minutes.
- 3 Press the TEMP/SHADE +/- buttons to select either HI or LO.
- 4 Place ingredients on the sheet pan. Place the sheet pan on the wire rack and close the oven door, press START/STOP to start cooking.
- 5 When cook time is complete, the unit will beep and “END” will appear on the display.

### Toast

**NOTE:** The unit does not preheat in Toast mode.

- 1 To select the function, press the function +/- buttons until TOAST brightly illuminates. The default amount of slices and darkness level will display.
- 2 Press the TIME/SLICES +/- buttons to select the number of bread slices. You may toast up to 9 slices at once.
- 3 Press the TEMP/SHADE +/- buttons to select a darkness level.

**NOTE:** There is no temperature adjustment available for the Toast function, and the unit does not preheat in Toast mode. It is very important to select the exact number of slices to avoid over- or under-toasting.

- 4 Place bread slices on the wire rack. Close oven door and press START/PAUSE to begin cooking.
- 5 When cook time is complete, the unit will beep and “END” will appear on the display.

### Bagel

**NOTE:** The unit does not preheat in Bagel mode.

- 1 To select the function, press the function +/- buttons until BAGEL brightly illuminates. The default number of slices and darkness level will display.
- 2 Press the TIME/SLICES +/- buttons to select the number of slices. You may toast up to 9 bagel slices at once.
- 3 Press the TEMP +/- buttons to select a darkness level.

**NOTE:** There is no temperature adjustment available for the Bagel function, and the unit does not preheat in Bagel mode. It is very important to select the exact number of slices to avoid over- or under-toasting.

- 4 Place bagel slices, cut-side up, in the middle of the wire rack. Close oven door and press START/PAUSE to begin cooking.
- 5 When cook time is complete, the unit will beep and “END” will appear on the display.

### Pizza

- 1 To select the function, press the function +/- buttons until PIZZA brightly illuminates. The default number of slices and darkness level will display.
- 2 Press the TIME/SLICES +/- buttons to select a cook time up to 4 hours.
- 3 Press the TEMP +/- buttons to select a temperature between 180°F–450°F.
- 4 Place pizza on the sheet pan or directly on the wire rack. Close oven door and press START/PAUSE to begin cooking.
- 5 When cook time is complete, the unit will beep and “END” will appear on the display.

### Reheat

**NOTE:** The unit does not preheat in Reheat mode.

- 1 To select the function, press the function +/- buttons until REHEAT brightly illuminates.
- 2 Press the TIME/SLICES +/- buttons to select a reheat time up to 4 hours.
- 3 Press the TEMP/SHADE +/- buttons to select a temperature between 100°F–450°F.
- 4 Place food on the sheet pan or in an oven-safe container and place the pan or container on the wire rack. Close oven door and press START/PAUSE to begin warming.
- 5 When cook time is complete, the unit will beep and “END” will appear on the display.



## CLEANING & MAINTENANCE

### EVERYDAY CLEANING

The unit should be cleaned thoroughly after every use.

- 1 Unplug the unit from the outlet and allow it to cool down before cleaning.
- 2 Empty crumb tray by sliding it out of the oven.

**NOTE:** Empty crumb tray frequently. Hand-wash when necessary.

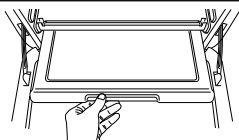

- 3 After every use, wipe away any food splatter on the interior walls and glass door of the unit with a soft, damp sponge.
- 4 To clean the exterior of the main unit and the control panel, wipe them clean with a damp cloth. A non-abrasive liquid cleanser or mild spray solution may be used. Apply the cleanser to the sponge, not the oven surface, before cleaning.
- 5 When using accessories, we recommend greasing them with butter or oil, or covering them with parchment paper or aluminum foil before placing food on top. **DO NOT** cover roast tray holes with parchment paper or aluminum foil.

### DEEP CLEANING

- 1 Unplug the unit from the outlet and allow it to cool down before cleaning.
- 2 Remove all accessories from the unit, including the crumb tray, and wash separately. Use a non-abrasive cleaning brush to more thoroughly wash the air fry basket. Accessories are hand-wash recommended. The air fry basket and wire racks can be put in the dishwasher, but may wear more quickly over time. **DO NOT** place roast tray, sheet pan, or crumb tray in dishwasher.
- 3 Use warm, soapy water and a soft cloth to wash the oven's interior and glass door, **DO NOT** use abrasive cleaners, scrubbing brushes, or chemical cleaners, as they will damage the oven.  
**CAUTION: NEVER** put the main unit in the dishwasher or immerse it in water or any other liquid.
- 4 To remove tough grease, let sheet pan and roast tray soak overnight in warm, soapy water, then wash with a non-abrasive sponge or brush.
- 5 Thoroughly dry all parts before placing them back in the oven.

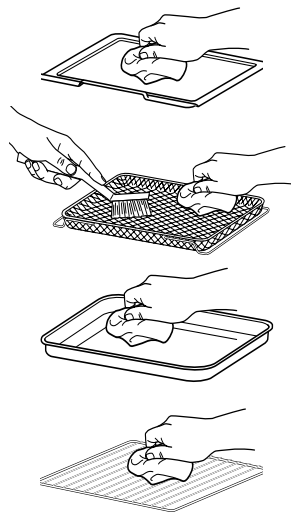

**IMPORTANT:** Place crumb tray below lower heating elements. **DO NOT** slide into any rack positions.

## ACCESSORIES FOR PURCHASE

We offer a suite of accessories custom made for your Ninja® Foodi™ XL Pro Air Fry Oven. Visit [ninjaaccessories.com](http://ninjaaccessories.com) to expand your capabilities and take your cooking to the next level.

- Cutting Board

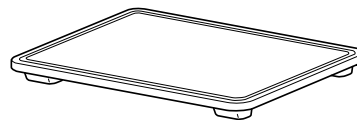

- Dehydrating Kit

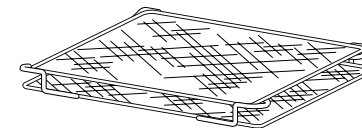

- Muffin Tray

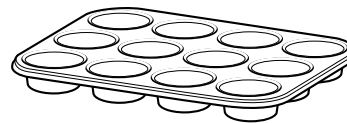

- Casserole Dish (9 x 13)

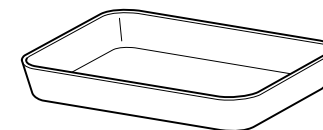

- Oven Mitts

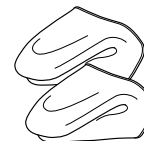

## TROUBLESHOOTING & FAQ

### ERROR MESSAGES

**“CALL CUST SrVC” followed by “Er0” - “Er3”**

Power off the unit and call Customer Service at **1-877-646-5288**. So we may better assist you, please register your product online at [registryourninja.com](http://registryourninja.com) and have the product on hand when you call.

## TROUBLESHOOTING & FAQ - CONT.

### FAQ

#### Why won't the oven turn on?

- Make sure the power cord is securely plugged into the outlet.
- Insert the power cord into a different outlet.
- Reset the circuit breaker if necessary.
- Press the power button.

#### Can I use the sheet pan instead of the air fry basket with Air Fry function?

- Yes, but crispiness results may vary.

#### Do I need to adjust the cook times and temperatures of traditional oven recipes?

- For best results, keep an eye out on your food while cooking. Refer to cook charts in the Inspiration Guide for more guidance on cook times and temperatures.

#### Can I restore the unit to its default settings?

- The oven will remember the last setting used for each function, even if you unplug it. To restore the oven's default settings for each function, press the Light  $\odot$  and 2 LEVEL buttons simultaneously for 5 seconds.

#### Why do the heating elements appear to be turning on and off?

- This is normal. The oven is designed to control temperature precisely for every function by adjusting the heating elements' power levels.

#### Why is steam coming out from the oven door?

- This is normal. Foods with a high moisture content may release steam around the door.

#### Why is water dripping onto the counter from under the door?

- This is normal. The condensation created by foods with a high moisture content (such as frozen breads) may run down the inside of the door and drip onto the counter.

#### Why is the unit generating smoke?

- Ensure you are using the roast tray on the sheet pan when cooking all greasy foods, or when using Air Fry, Air Roast, or Whole Roast functions.
- If problem persists, run a Toast cycle on shade 7 with accessories removed; this will burn off any additional grease on the heating elements that are causing smoke.

#### How can I clean the sheet pan?

- For stuck-on food, let the sheet pan soak before cleaning.
- Line the sheet pan with aluminum foil or parchment paper when cooking to make clean-up easier.

#### Why did a circuit breaker trip while using the unit?

- The unit uses 1800 watts of power, so it must be plugged into an outlet on a 15-amp circuit breaker. It is also important that the unit be the only appliance plugged into an outlet when in use. To avoid tripping a breaker, make sure the unit is the only appliance plugged into an outlet on a 15-amp breaker.

#### Why does the unit sound like it is still running even though the power is off?

- The cooling fan may continue to run even after the unit has been turned off. This is a normal function and should not be a source of concern. The cooling fan will stop after the temperature of the unit reaches below 95°F (35°C).

## REPLACEMENT PARTS

To order additional parts and accessories, visit [ninjaaccessories.com](http://ninjaaccessories.com) or contact Customer Service at **1-877-646-5288**. So we may better assist you, please register your product online at [registeryourninja.com](http://registeryourninja.com) and have the product on hand when you call.

# Shark | NINJA

## ONE (1) YEAR LIMITED WARRANTY

The One (1) Year Limited Warranty applies to purchases made from authorized retailers of **SharkNinja Operating LLC**. Warranty coverage applies to the original owner and to the original product only and is not transferable.

SharkNinja warrants that the unit shall be free from defects in material and workmanship for a period of one (1) year from the date of purchase when it is used under normal household conditions and maintained according to the requirements outlined in the Owner's Guide, subject to the following conditions and exclusions:

#### What is covered by this warranty?

1. The original unit and/or non-wearable parts deemed defective, in SharkNinja's sole discretion, will be repaired or replaced up to one (1) year from the original purchase date.
2. In the event a replacement unit is issued, the warranty coverage ends six (6) months following the receipt date of the replacement unit or the remainder of the existing warranty, whichever is later. SharkNinja reserves the right to replace the unit with one of equal or greater value.

#### What is not covered by this warranty?

1. Normal wear and tear of wearable parts (such as removable pots, racks, pans, etc.), which require regular maintenance and/or replacement to ensure the proper functioning of your unit, are not covered by this warranty. Replacement parts are available for purchase at [ninjaaccessories.com](http://ninjaaccessories.com).
2. Any unit that has been tampered with or used for commercial purposes
3. Damage caused by misuse, abuse, negligent handling, failure to perform required maintenance (e.g., failure to keep the oven clear of food spills and other debris), or damage due to mishandling in transit.
4. Consequential and incidental damages.
5. Defects caused by repair persons not authorized by SharkNinja. These defects include damages caused in the process of shipping, altering, or repairing the SharkNinja product (or any of its parts) when the repair is performed by a repair person not authorized by SharkNinja.
6. Products purchased, used, or operated outside North America.

#### How to get service

If your appliance fails to operate properly while in use under normal household conditions within the warranty period, visit [ninjakitchen.com/support](http://ninjakitchen.com/support) for product care and maintenance self-help. Our Customer Service Specialists are also available at **1-877-646-5288** to assist with product support and warranty service options, including the possibility of upgrading to our VIP warranty service options for select product categories. So we may better assist you, please register your product online at [registeryourninja.com](http://registeryourninja.com) and have the product on hand when you call.

SharkNinja will cover the cost for the customer to send in the unit to us for repair or replacement. A fee of \$19.95 (subject to change) will be charged when SharkNinja ships the repaired or replacement unit.

#### How to initiate a warranty claim

You must call **1-877-646-5288** to initiate a warranty claim. You will need the receipt as proof of purchase. We also ask that you register your product online at [registeryourninja.com](http://registeryourninja.com) and have the product on hand when you call, so we may better assist you. A Customer Service Specialist will provide you with return and packing instruction information.

#### How state law applies

This warranty gives you specific legal rights, and you also may have other rights that vary from state to state. Some states do not permit the exclusion or limitation of incidental or consequential damages, so the above may not apply to you.

**SharkNinja Operating LLC**  
**US: Needham, MA 02494**  
**1-877-646-5288**  
**ninjakitchen.com**

Illustrations may differ from actual product. We are constantly striving to improve our products, therefore the specifications contained herein are subject to change without notice.

NINJA is a registered trademark of SharkNinja Operating LLC.

FOODI is a trademark of SharkNinja Operating LLC.

For SharkNinja U.S. patent information, visit [sharkninja.com/uspatents/](http://sharkninja.com/uspatents/)

© 2020 SharkNinja Operating LLC

PRINTED IN CHINA

DT200Series\_IB\_MP\_Mv8



**@ninjakitchen**