

Owner's Manual

2021 Q3



Foreword

Thank you for choosing an Audi – we value your trust in us.

Your new Audi will allow you to experience the best in groundbreaking technology and premium quality equipment that a vehicle has to offer. Audi recommends that you read your Owner's Manual thoroughly so that you quickly become acquainted with your Audi and make use of all of its features.

In addition to explaining how the different features work, there are many useful tips and information concerning your safety, how to care for your vehicle, and how to maintain your vehicle's value. Audi also gives you useful tips and information on how to drive your vehicle more efficiently and in an environmentally-friendly manner.

Audi hopes you enjoy driving your vehicle and wishes you safe and pleasant motoring.



WARNING

Operating, servicing and maintaining a passenger vehicle or off-highway motor vehicle can expose you to chemicals including engine exhaust, carbon monoxide, phthalates, and lead, which are known to the State of California to cause cancer and birth defects or other reproductive harm. To minimize exposure, avoid breathing exhaust, do not idle the engine except as necessary, service your vehicle in a well-ventilated area and wear gloves or wash your hands frequently when servicing your vehicle. For more information go to www.P65Warnings.ca.gov/passenger-vehicle.

Table of contents

About this Owner's Manual	5	Windshield wipers	50
Summary	6	Digital compass	53
Quick access	6	Sitting correctly and safely	55
Cockpit	6	Correct passenger seating position	55
Indicator lights overview	7	Front seats	55
Display and operation	11	Rear seats	57
Instrument cluster	11	Steering wheel	58
Instrument cluster overview	11	Head restraints	59
Operating	12	Safety belts	60
Adjusting the display	12	Airbag system	63
Coolant temperature display	13	Child safety seats	68
Tachometer	13	Storage and convenience	74
Odometer	14	Power sources	74
Outside temperature display	14	Cup holders	74
Engine oil temperature indicator	14	Storage areas and compartments	75
Vehicle functions	14	Luggage compartment	75
Touch display	16	Roof rack	78
General touch display operation	16	Warm and cold	79
Multi Media Interface	18	Climate control system	79
Voice operation	24	Deluxe automatic climate control with 2 zones/3 zones	80
General information	24	Steering wheel heating	81
Voice recognition system	24	Fluids in the A/C system	82
External voice operation	25	Driving	83
Global functions	26	Starting the vehicle	83
Additional function buttons	26	When driving	85
Starting and driving	27	Drive system	89
Personalization	27	Start/Stop system	90
User	27	Brakes	92
Opening and closing	28	Electromechanical parking brake	94
Central locking	28	Special driving situations	95
Keys	32	Driving dynamic	98
Luggage compartment lid	34	Audi drive select	98
Child safety lock	38	Suspension	99
Power windows	39	Steering	99
Panoramic glass roof	40	All wheel drive (quattro)	100
Garage door opener	40	Electronic Stabilization Control	100
Lights and Vision	44	Trailer towing	103
Exterior lighting	44	Driving with a trailer	103
Interior lighting	47		
Vision	48		

Assist systems	106	Emergency call	162
Assist systems	106	Overview	162
General information	106	Emergency call	162
Surrounding area detection	107	Online roadside assistance	163
Driving information	110	Navigation	164
Speed warning system	110	Opening navigation	164
Camera-based traffic sign recognition ...	110	myAudi navigation	164
Traffic light information	112	Entering a destination	165
Driver assistance	114	Stopping route guidance	169
Cruise control system	114	Map	170
Adaptive cruise assist	115	Personal route assistance	172
Distance warning	123	Alternative routes	172
Lane departure warning	124	Additional functions	173
Audi pre sense	126	Satellite map	174
Side assist	129	Map update	175
Parking and maneuvering	131	Traffic incidents	176
Introduction	131	Options and settings	177
Parking aid plus	131	Radio	180
Rearview camera and peripheral cameras .	133	Opening the radio	180
Rear cross-traffic assist	137	Radio functions	181
Assisted parking	138	Online radio	184
Park assist	140	Options and settings	185
Infotainment system	143	Do It Yourself	187
Telephone	143	Media	188
Introduction	143	General information	188
Setup	143	SD card reader	188
Using the Audi phone box	145	Bluetooth audio player	188
Using the telephone	147	Online media	189
Messages	151	Amazon Alexa	190
Settings	153	Multimedia connections	190
Instrument cluster	155	Playing media	191
Do It Yourself	155	Options and settings	195
Audi connect	157	Supported media and file formats	196
General information	157	Do It Yourself	197
Audi connect Infotainment	157	Audi smartphone interface	199
Using a Wi-Fi hotspot	158	Setup	199
Audi connect Infotainment services	158	Do It Yourself	200
Settings	159		
Do It Yourself	161		

Table of contents

Additional settings	201	Customer information	261
System settings	201	Data privacy	261
Connected devices	202	Privacy notice	261
Legal information	203	Image recording	261
Additional information	205	Data memories	261
Brands and licenses	205	Transmitted information	262
Maintenance and Care	206	Accessories and technical	
Checking and Filling	206	changes	264
Fuel	206	Warranty	264
Refueling	207	Audi Literature Shop	264
Emissions control system	209	Driving in other countries	264
Engine compartment	210	Maintenance, repairs, and technical	
Engine oil	213	modifications	264
Cooling system	216	Accessories and parts	266
Brake fluid	218	Reporting Safety Defects	266
Electrical system	219	Declaration of compliance for	
Battery	219	telecommunications equipment and	
Windshield washer system	222	electronic systems	267
Service interval display	222	Technical data	269
Wheels	223	Identification data	269
Wheels and Tires	223	Vehicle data	269
Tire pressure monitoring system	240	Index	271
Care and cleaning	242		
General information	242		
Car washes	242		
Cleaning and care information	243		
Taking your vehicle out of service	247		
Do It Yourself	248		
Emergency assistance	248		
General information	248		
Equipment	248		
Changing a tire	248		
Spare tire	251		
Jump starting	252		
Towing	254		
Fuses and bulbs	257		
Fuses	257		
Bulbs	259		

In this manual, Audi provides important information, tips, suggestions, and warnings for using your vehicle. "Audi" refers to AUDI AG, the respective importer in a country, as well as joint ventures.

It has always been Audi's policy to continuously improve its products. Audi reserves the right to make changes in design and specifications, and to make additions or improvements in its products without incurring any obligation to install them on products previously manufactured. This owner's manual is based on the current data available when it was printed. Text, illustrations, and specifications in this owner's manual are based on the most current information available at the time of printing, and shall not constitute a basis for liability claims.

KEEP THIS GUIDE

Keep this manual and any other applicable documents in your vehicle at all times. This is especially important if you loan your vehicle to others or sell it.

This owner's manual describes the **equipment range** for all model versions of this vehicle at the time of printing. Individual equipment options described may only be available at a later date or may only be offered in certain countries.

Some sections in this manual do not apply to all vehicles. When this is the case, the beginning of the section indicates the **validity**, for example "Applies to: vehicles with speed warning system". Optional or vehicle-specific equipment is also identified with an asterisk "*".

The **illustrations** in this manual are a guide. Some of the details in your vehicle may differ from the illustration.

All **directions**, such as "left", "right", "front" and "rear", are based on the vehicle's direction of travel.

- * Optional equipment or vehicle-specific equipment
- ▶ The section continues on the next page.

⇒ ⚠ Cross reference to a "WARNING" within a section. If a page number is indicated, the WARNING is located outside of the section.

WARNING

Text with this symbol contains information about safety and how to reduce the risk of serious personal injury or death.

Note

Text with this symbol contains information about reducing the risk of damage to your vehicle.

For the sake of the environment

Text with this symbol contains information on protecting the environment.

Tips

Text with this symbol contains additional useful information.

Quick access

Cockpit

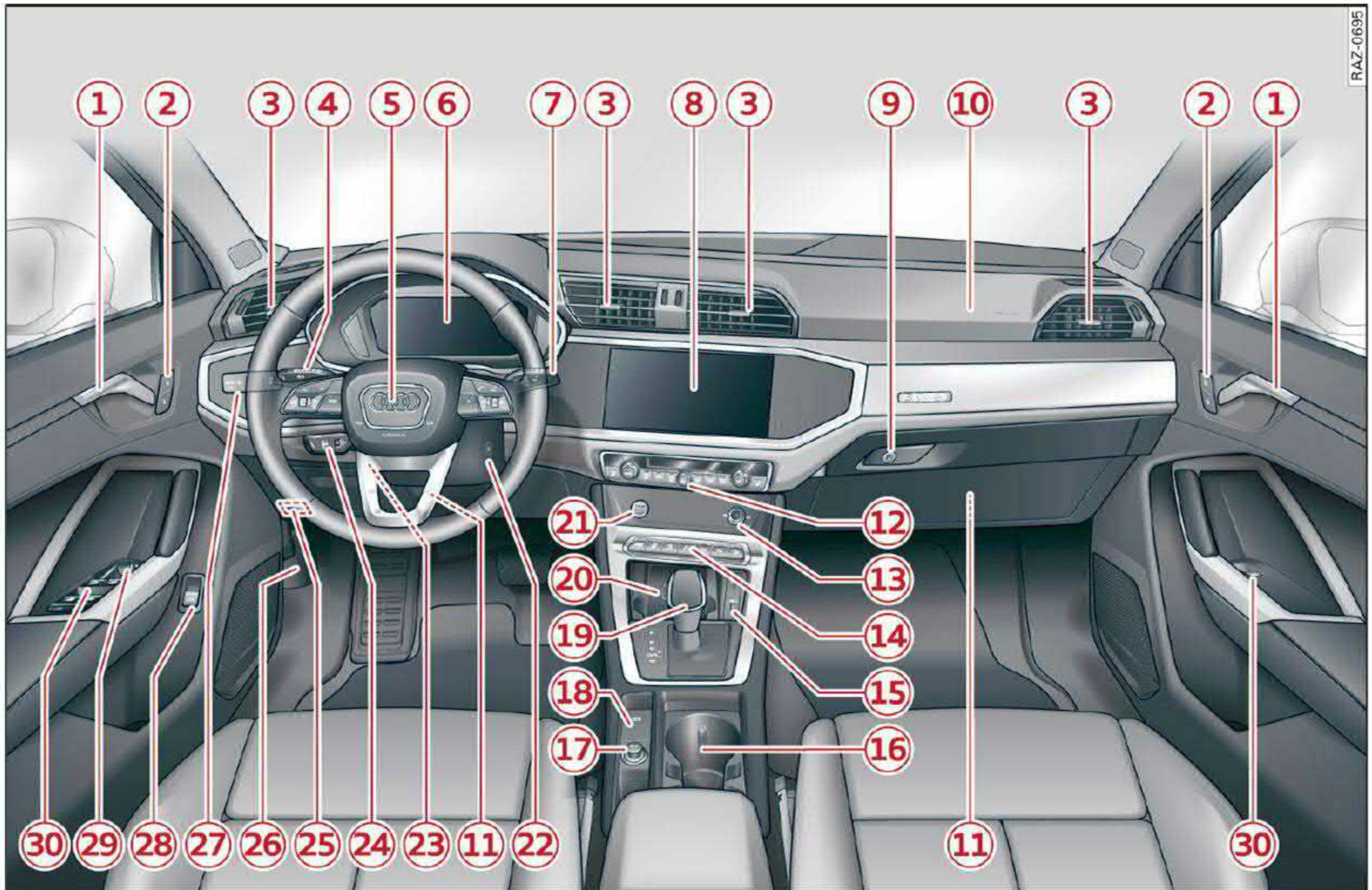

Fig. 1 Cockpit

① Door handle		⑪ Knee airbag	63
② Central locking switch	30	⑫ Climate control system	79
③ Air vent with thumbwheel		⑬ MMI On/Off button	18, 26
④ Lever for:		⑭ Depending on equipment, buttons for:	
– Turn signals and high beams	45	– drive select	98
– High beam assistant	45	– Electronic Stabilization Control (ESC)	101
– Lane departure warning	124	– Start/Stop system	90
– Lane guidance	119	– Emergency flashers	46
⑤ Multifunction steering wheel with:		– Parking system	131
– Horn		– Park assist	140
– Driver's airbag	63	– Hill hold assist	96
– Operating buttons	12, 26	⑮ Audi music interface	190
– Shift paddles	87	⑯ Depending on equipment:	
⑥ Instrument cluster	11	– Cup holder	74
⑦ Windshield washer system lever	50	– Mount for mobile device	
⑧ Center display	18	⑰ Socket	74
⑨ Lockable glove compartment with:		⑱ Electromechanical parking brake button	94 ▶
– SD card reader	188		
⑩ Front passenger's airbag	63		

- 19 Selector lever (automatic transmission) 86
- 20 Audi phone box 145
- 21 **START ENGINE STOP** button 83
- 22 Depending on equipment:
 - Starting the engine if there is a malfunction 84
 - Ignition lock 83
- 23 Steering wheel adjustment 58
- 24 Lever for:
 - Cruise control system 114
 - Adaptive cruise assist 115
- 25 Connection port for the On Board Diagnostic System (OBD) 261
- 26 Hood release 211
- 27 Buttons for:
 - Lights 44
 - All-weather lights 44
- 28 Luggage compartment lid button . 34
- 29 Exterior mirror adjustment 48
- 30 Buttons for:
 - Power windows 39
 - Child safety lock 38

i Tips

Some the equipment listed here is only installed in certain models or is available as an option.

Indicator lights overview

Description

The indicator lights in the instrument cluster blink or turn on. They indicate functions or malfunctions. Some warning and indicator lights turn on when you switch the ignition on and must turn off when the drive system is switched on or while driving.

With some indicator lights, messages may appear and warning signals may sound. The indicator lights and messages may be covered by other displays. To show them again, select the second tab for messages with the multifunction steering wheel ⇒ page 12.

Some indicator lights in the display can display in several colors.











⚠ Central indicator light

If the  or  indicator light turns on, check the message in the instrument cluster.





Overview

The following indicator lights may be available, depending on the vehicle equipment:











Red indicator lights

















	Central indicator light ⇒ page 7, Instrument cluster ⇒ page 11
	Safety belt ⇒ page 62
	Transmission ⇒ page 88
	Drive system ⇒ page 90
PARK	Electromechanical parking brake ⇒ page 95
	Electromechanical parking brake ⇒ page 95
	Brake system ⇒ page 93, ⇒ page 95, ⇒ page 218
BRAKE	Brake system ⇒ page 93, ⇒ page 95, ⇒ page 218
	Steering ⇒ page 99
	Steering lock ⇒ page 99
	Electrical system ⇒ page 219
	Engine oil pressure ⇒ page 213
	Cooling system ⇒ page 216











Quick access

	Hood ⇒ page 211
	Distance warning ⇒ page 123
	Safe start monitor ⇒ page 122, Driver intervention request ⇒ page 122
	Adaptive cruise assist ⇒ page 117
	Lane departure warning ⇒ page 125
	Steering intervention request ⇒ page 120
	Audi pre sense ⇒ page 127



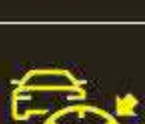

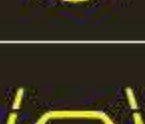





Yellow indicator lights





















	Central indicator light ⇒ page 7
	Safety systems ⇒ page 64
	Transmission/clutch ⇒ page 88
	Drive system ⇒ page 90
	Engine start system ⇒ page 84
	Keys ⇒ page 84
	Electromechanical parking brake ⇒ page 95
	Hill hold assist ⇒ page 86
	Electronic Stabilization Control (ESC) ⇒ page 100
	Electronic Stabilization Control (ESC) ⇒ page 100
ESC OFF	Electronic Stabilization Control (ESC) ⇒ page 101

ABS	Anti-Lock Braking System (ABS) ⇒ page 102, ⇒ page 93
	Anti-Lock Braking System (ABS) ⇒ page 102, ⇒ page 93
	Steering ⇒ page 99
	Steering lock ⇒ page 99
	All wheel drive ⇒ page 100
	Suspension control ⇒ page 99
	Engine speed limitation ⇒ page 13
	Tank system ⇒ page 208
	Electrical system ⇒ page 219
	Engine oil level (MIN) ⇒ page 213
	Engine oil sensor ⇒ page 213
	Malfunction Indicator Lamp (MIL) ⇒ page 209,
	Washer fluid level ⇒ page 222
	Engine warm-up request ⇒ page 213
	Windshield wipers ⇒ page 52
P	Parking system plus ⇒ page 133
P OFF	Park assist ⇒ page 142
	Rear cross-traffic assist ⇒ page 138
	Tire pressure ⇒ page 240
TPMS	Tire pressure ⇒ page 240
	Bulb failure indicator ⇒ page 47













	Adaptive light ⇒ page 47
	Light/rain sensor ⇒ page 47, ⇒ page 52
	Door lock ⇒ page 30
	Battery in vehicle key ⇒ page 34
	Distance warning ⇒ page 123
	Side assist ⇒ page 130
	Adaptive cruise assist ⇒ page 123
	Steering intervention request ⇒ page 120, ⇒ page 125
	Lane departure warning ⇒ page 126
	Audi pre sense ⇒ page 128

Other indicator lights

	Rear safety belt ⇒ page 62
	Start/Stop system ⇒ page 90
	Hill hold assist ⇒ page 96
	Turn signals ⇒ page 45, ⇒ page 46
	Low beam headlights ⇒ page 44
	Parking lights ⇒ page 44
	Cruise control system ⇒ page 114
	Cruise control system ⇒ page 114
	Adaptive cruise assist ⇒ page 117
	Adaptive cruise assist ⇒ page 117

	Adaptive cruise assist ⇒ page 117
	Adaptive cruise assist ⇒ page 117
	Adaptive cruise assist ⇒ page 117
	Adaptive cruise assist ⇒ page 117
	Lane departure warning ⇒ page 125
	High beam headlights ⇒ page 45
	High beam assistant ⇒ page 45
	Rear safety belt ⇒ page 62
	Transmission/clutch ⇒ page 88
	Start/Stop system ⇒ page 91
	Convenience key ⇒ page 84
	Electromechanical parking brake ⇒ page 95
	Electromechanical parking brake ⇒ page 95
	Hill hold assist ⇒ page 96
	Parking systems ⇒ page 133
	Park assist ⇒ page 140
	Park assist ⇒ page 142
	Rear cross-traffic assist ⇒ page 138
	High beam assistant ⇒ page 45
	Door lock ⇒ page 30

Quick access

	Child safety lock ⇒ <i>page 38</i>
	
	Speed warning system ⇒ <i>page 110</i>
	Speed warning system ⇒ <i>page 110</i>
CRUISE	Cruise control system ⇒ <i>page 114</i>
	Cruise control system ⇒ <i>page 114</i>
	Distance warning ⇒ <i>page 123</i>
	Side assist ⇒ <i>page 130</i>
	Adaptive cruise assist ⇒ <i>page 123</i>
	Adaptive cruise assist ⇒ <i>page 120</i>
	Adaptive cruise assist ⇒ <i>page 117</i>
	Lane departure warning ⇒ <i>page 125</i>
	Lane departure warning ⇒ <i>page 126</i>
	Audi pre sense ⇒ <i>page 128</i>

Instrument cluster

Instrument cluster overview



Fig. 2 Audi virtual cockpit plus overview



Fig. 3 Digital instrument cluster or Audi virtual cockpit overview

Depending on the vehicle equipment, the following items may appear in the instrument cluster:

- ① Display
 - Engine coolant temperature ... 13
- ② Left dial
 - Tachometer 13
- ③ Tab area 12
- ④ Central area 12
- ⑤ Status line (one or two lines)
- ⑥ Right dial
 - Convenience display
- ⑦ Fuel level 208

- ⑧ Right additional display with speedometer
- ⑨ Left additional display with:
 - Gear 86
 - Audi drive select mode 98

⚠ WARNING

If there is a severe malfunction in the instrument cluster, the display may turn off. The indicator light may also turn on. Stop the vehicle safely. See an authorized Audi dealer or authorized Audi Service Facility for assistance.

i Tips

- The following pages primarily show illustrations of the Audi virtual cockpit plus*. The display or location of the items that are shown may vary on the different versions of the instrument cluster.
- You can select the units used for temperature, speed, and other measurements ⇒ *page 201*.
- Speeds are displayed in mph (miles per hour) or km/h (kilometers per hour).
- If there is a malfunction in the instrument cluster, **DEF** will appear in the trip odometer display. Have the malfunction corrected as soon as possible.

Operating

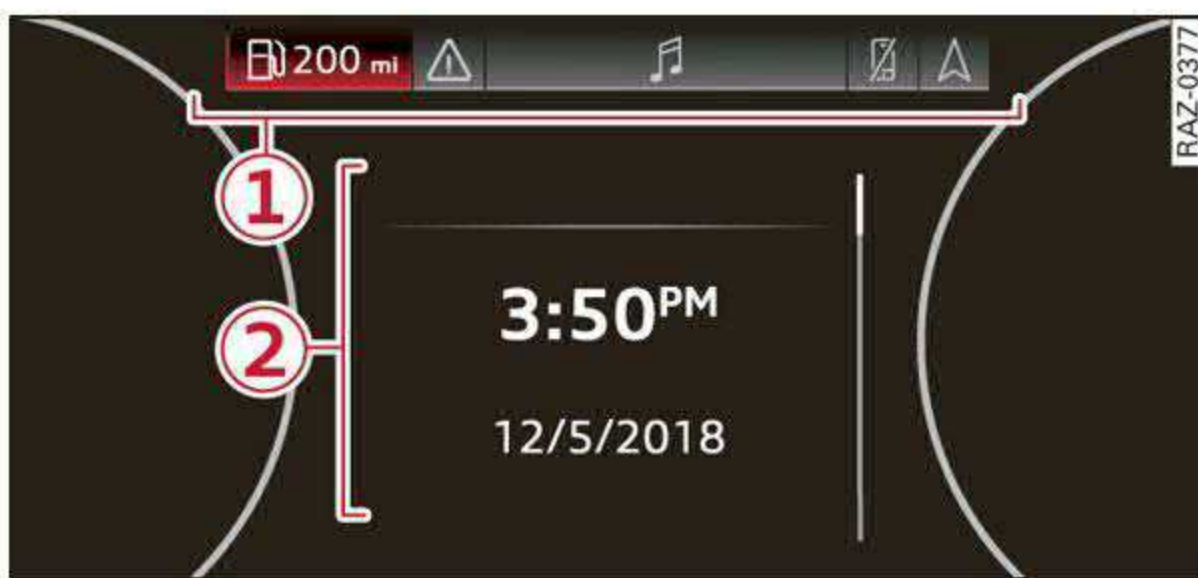

Fig. 4 Driver information system display

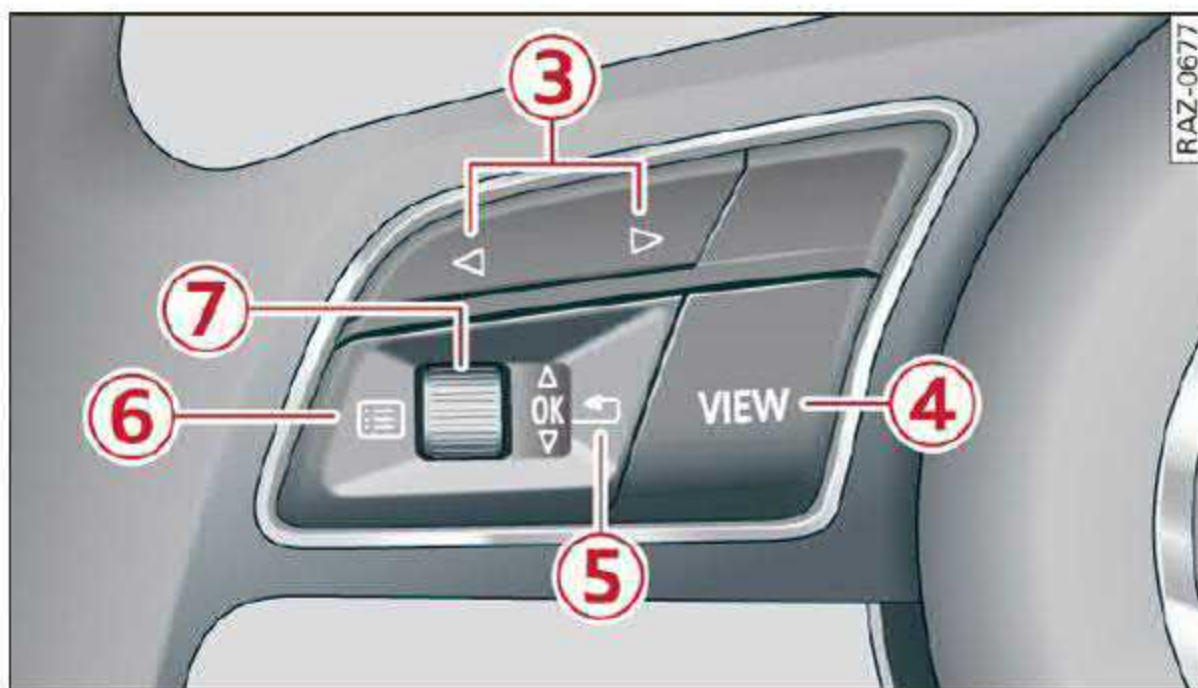

Fig. 5 Left side of multifunction steering wheel

Information is organized within various tabs ① in the instrument cluster. The tab contents are displayed in the central area ②.

Requirement: the ignition must be switched on.

Selecting a tab

- ▶ Press the </> button ③ repeatedly until the desired tab is selected.

Returning to functions at higher levels

- ▶ Press the ↶ button ⑤.

Opening and closing the menu

- ▶ Press the ☰ button ⑥.

Selecting and confirming a function

Requirement: a menu or list must be displayed.

- ▶ To select a function, turn the left thumbwheel ⑦ to the desired function.
- ▶ To confirm a selection, press the left thumbwheel ⑦.

Switching the view

- ▶ Press the VIEW button ④ ⇒ *page 12*.

The following tabs may be available, depending on vehicle equipment:

First tab	Vehicle functions ⇒ <i>page 14</i>
Second tab	Driver messages (this is only displayed if at least one indicator light/message is being displayed)
Third tab	Radio ⇒ <i>page 180</i> Media ⇒ <i>page 192</i>
Fourth tab	Telephone ⇒ <i>page 155</i>
Fifth tab	Navigation ⇒ <i>page 164</i>

Adjusting the display

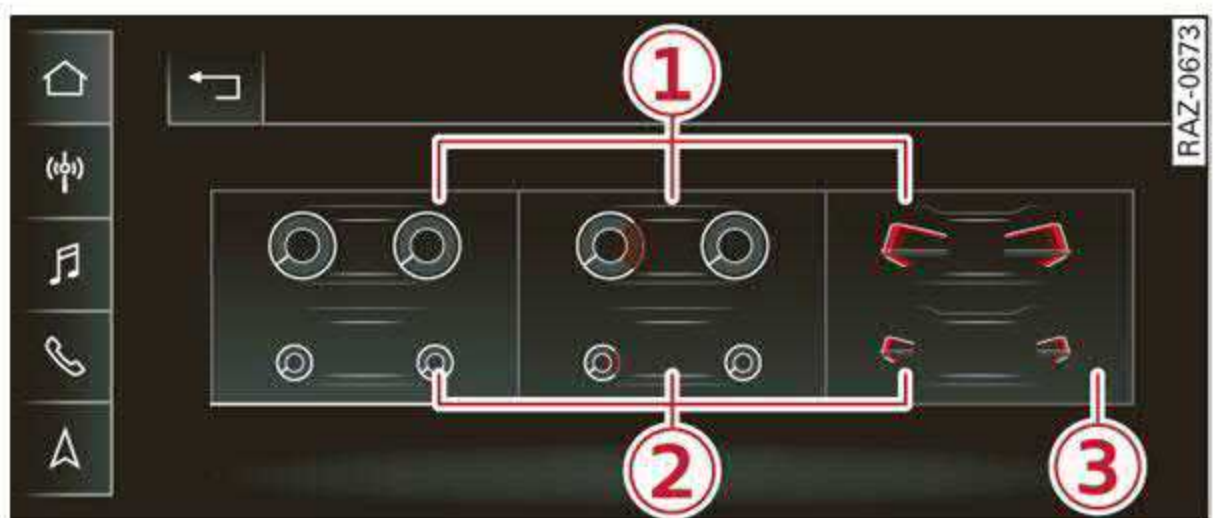

Applies to: Audi virtual cockpit

Fig. 6 Center display: adjusting the display

Switching the view

Applies to: Audi virtual cockpit

- ▶ Press the VIEW button to switch between the default view ① and the enhanced view ②.

Adjusting the layout¹⁾

Applies to: Audi virtual cockpit

Depending on the vehicle equipment, various layouts may be available.

- ▶ Applies to: MMI: Select on the home screen: **SETTINGS > Display & brightness > Virtual cockpit**.
- ▶ To adjust the desired layout, press **3**.

Adjusting the additional display

Applies to: Audi virtual cockpit

Depending on the vehicle equipment, the additional displays that can be selected may vary.

- ▶ Applies to: MMI: Select on the home screen: **SETTINGS > Display & brightness > Virtual cockpit > (Configure)¹⁾**.
- ▶ Select the desired additional display.

Reducing the display

Depending on the vehicle equipment, you can hide the central area in the instrument cluster.

- ▶ Select on the instrument cluster: vehicle functions tab >  button > **Reduced display**, or
- ▶ Press the VIEW button on the multifunction steering wheel.

Coolant temperature display

The coolant temperature display **1** ⇒ *page 11* only functions when the ignition is switched on. To reduce the risk of engine damage, please observe the following notes about the temperature ranges.

Cold range

If only the LEDs at the bottom of the gauge turn on, the engine has not reached operating temperature yet. Avoid high engine speeds, full acceleration, and heavy engine loads.

Normal range

The engine has reached its operating temperature once the LEDs up to the center of the gauge turn on. If the  indicator light in the instru-

ment cluster display turns on, the coolant temperature is too high ⇒ *page 216*.

Note

- Auxiliary headlights and other accessories in front of the air intake impair the cooling effect of the coolant. This increases the risk of the engine overheating during high outside temperatures and heavy engine load.
- The front spoiler also helps to distribute cooling air correctly while driving. If the spoiler is damaged, the cooling effect will be impaired and the risk of the engine overheating will increase. See an authorized Audi dealer or authorized Audi Service Facility for assistance.

Tachometer

The tachometer **2** ⇒ *page 11* displays the engine speed in revolutions per minute (RPM). The beginning of the red zone in the tachometer indicates the maximum permissible engine speed for all gears once the engine has been broken in. Before reaching the red zone, you should shift into the next higher gear, select the "D" or "S" selector lever position, or remove your foot from the accelerator pedal.

Engine speed limitation

If the  indicator light turns on, the engine will be automatically limited to the RPM displayed in the instrument cluster. This will protect the engine components, for example during a cold start or from overheating.

The engine speed limitation is deactivated if you release the accelerator pedal while the engine is at normal operating temperature.

If the engine speed limitation was activated by an engine control malfunction, the  indicator light also turns on. Make sure the engine speed does not go above the speed displayed, for example when downshifting. Drive to an authorized Audi dealer or authorized Audi Service Facility immediately to have the malfunction corrected. ▶

¹⁾ In preparation at the time of printing.

Note

The needle in the tachometer may only be in the red area of the gauge for a short period of time before there is a risk of damaging the engine. The location where the red zone begins varies depending on the engine.

Odometer

The trip odometer and odometer are displayed in the status bar  ⇒ *page 11*.

The trip odometer shows the distance driven since it was last reset. It can be used to measure short distances. The odometer shows the total distance that the vehicle has been driven.

Resetting the trip odometer

- ▶ Select on the instrument cluster: vehicle functions tab >  button > **Reset mi.**

Tips

Distances are displayed in mi (miles) or km (kilometers).

Outside temperature display

The outside temperature is displayed in the status bar  ⇒ *page 11*.

If your vehicle is stationary or if you are driving at very low speeds, the temperature displayed in the instrument cluster may be slightly higher than the actual temperature outside due to heat radiating from the engine.

At temperatures below 41 °F (+5 °C), a snowflake symbol appears in front of the temperature display ⇒ .

WARNING



Do not assume the roads are free of ice based on the outside temperature display. Be aware that there may be ice on roads even when the outside temperature is around 41 °F (+5 °C) and that ice can increase the risk of accidents.

Engine oil temperature indicator

Applies to: vehicles with engine oil temperature indicator

Depending on the vehicle equipment, the engine oil temperature  may be indicated by a bar in the instrument cluster.

- ▶ Open the vehicle functions tab and switch to the enhanced view ⇒ *page 12*.

When engine oil temperatures are low, the display --- °F (--- °C) appears in the instrument cluster. The engine has reached its operating temperature when the engine oil temperature is between 176 °F (80 °C) and 248 °F (120 °C) under normal driving conditions. The engine oil temperature may be higher if there is heavy engine load and high temperatures outside. This is not a cause for concern as long as the  ⇒ *page 213* or  ⇒ *page 213* indicator lights do not turn on.

Vehicle functions

Overview

The trip computer is displayed in the first tab of the driver information system. Additional vehicle functions can be accessed depending on the vehicle equipment.

- ▶ Press the  button on the multifunction steering wheel.
 - On-board computer ⇒ *page 14*
 - Reduced display ⇒ *page 13*
 - Reset trip odometer ⇒ *page 14*

On-board computer

Resetting values to zero

Requirement: the **Consumption**, **Short-term memory**, or **Long-term memory** display must be selected.

- ▶ To reset the values in one of the memories to zero, press and hold the left thumbwheel on the multifunction steering wheel for one second, or
- ▶ Select on the instrument cluster: vehicle functions tab >  button > **Reset mi.**

Depending on the vehicle equipment, you can call up the following displays in the on-board computer one at a time by turning the left thumb-wheel on the multifunction steering wheel:

- Time and date ⇒ *page 201*
- Average consumption ⇒ *page 15*
- Short-term memory overview
- Long-term memory overview
- Energy consumers ⇒ *page 15*
- Driver assistance
- Traffic light information

Short-term memory and long-term memory

The short-term memory collects driving information from the time the ignition is switched on until it is switched off. If you continue driving within two hours after switching the ignition off, the new values will be included when calculating the current trip information.

Unlike the short-term memory, the long-term memory is not erased automatically. You can select the time period for evaluating trip information yourself.

Average consumption

The current consumption can be shown using a bar graph. The average consumption stored in the short-term memory is also displayed. If the bar is green, your vehicle is saving fuel (for example, using recuperation).

Energy consumers

The **Energy consumers** view lists other equipment that is currently affecting fuel consumption. The display shows up to three equipment items. The equipment using the most power is listed first. If more than three items using power are switched on, the equipment that is currently using the most power is displayed. A gauge also shows the current total consumption of all other equipment.

Tips

The date, time of day, and time and date format can be set ⇒ *page 201*.

Touch display

General touch display operation

General information

The center display is a touchscreen. Operation is very similar to operating a smartphone.

Tips

Certain gestures are not available in every menu.

Pressing

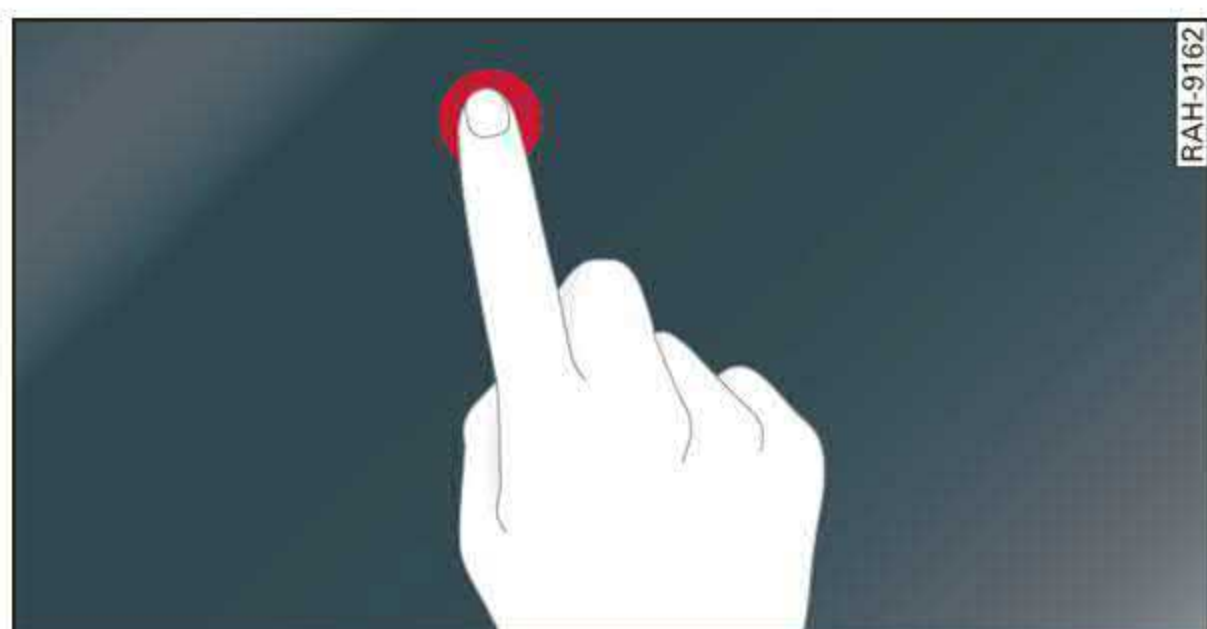

Fig. 7 Touch display: pressing

Selecting a function or button

- ▶ Press the desired function or button.

Pressing and holding

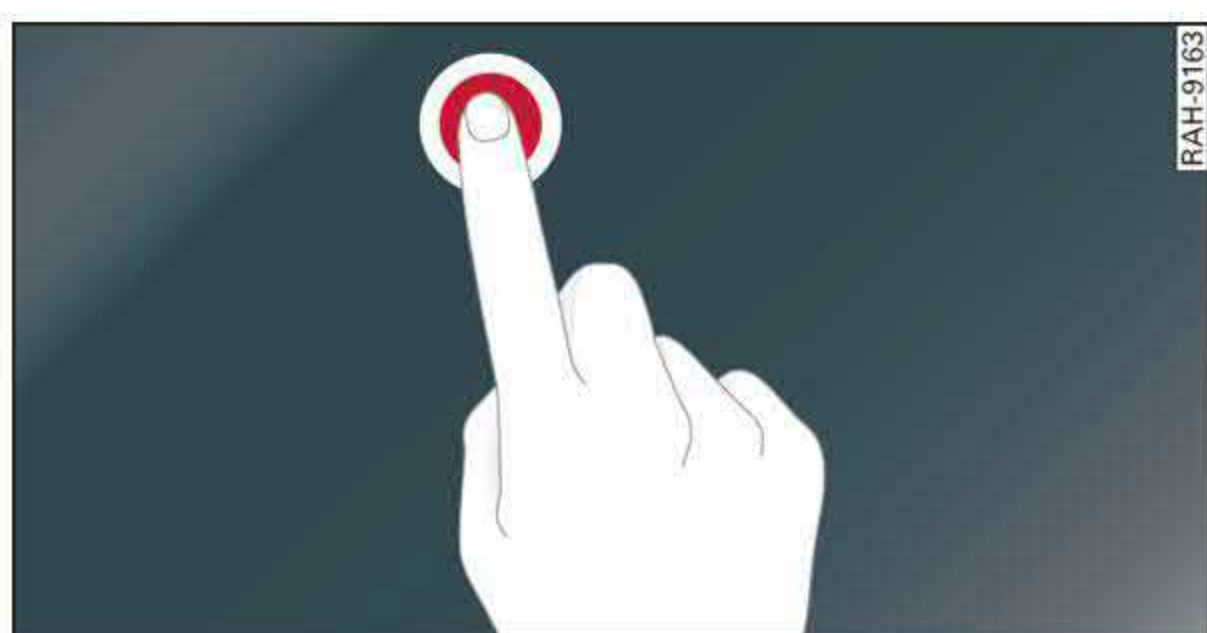

Fig. 8 Touch display: pressing and holding

Accessing options

For some items, you can access additional options that are not directly visible.

- ▶ Press and hold an item until the associated options are displayed.

Pressing and pulling

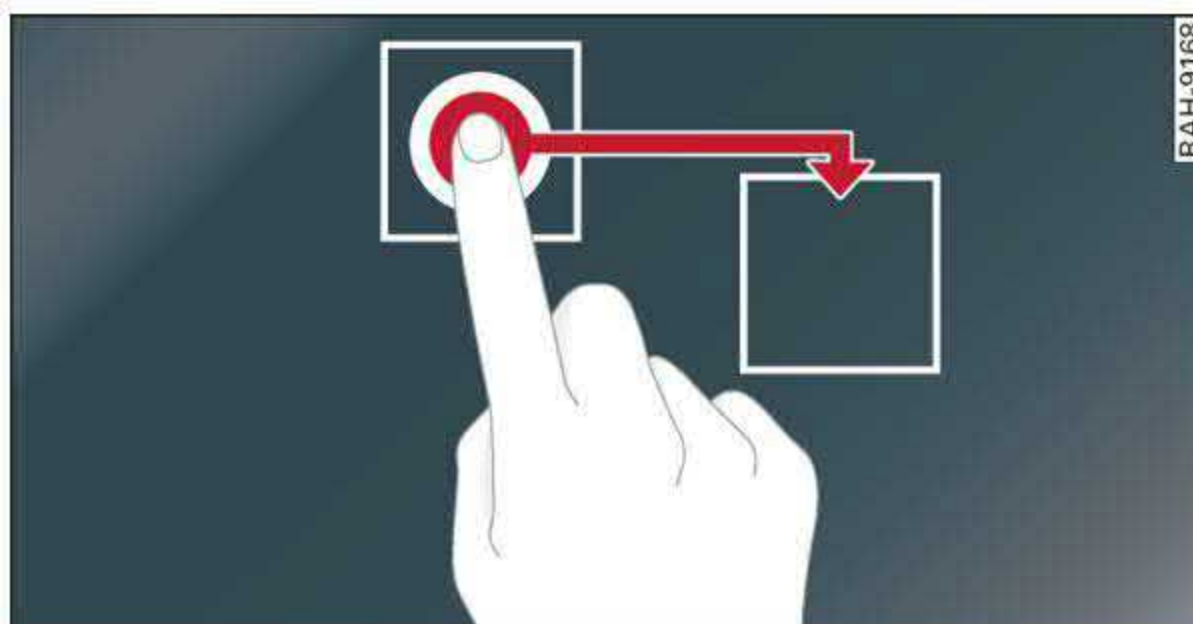

Fig. 9 Touch display: pressing and pulling

Moving an item

You can position some items at any location on the screen.

- ▶ Press and hold an item, and then use your finger to pull it to the desired location.

Pinching fingers together and pulling apart

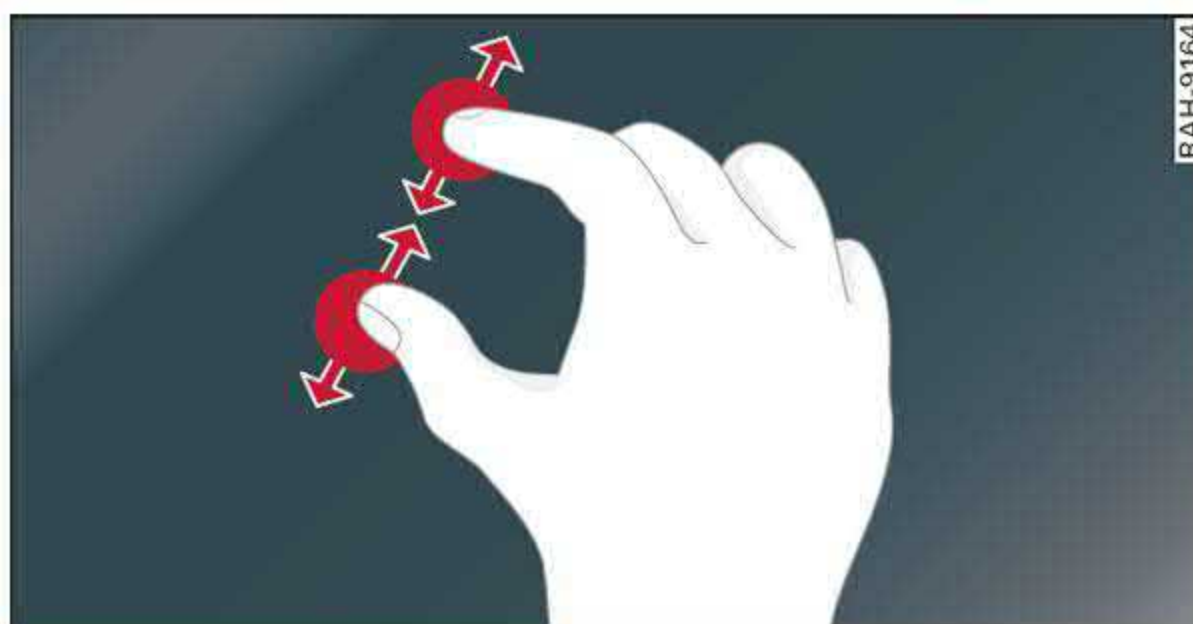

Fig. 10 Touch display: pinching fingers together and pulling them apart

Zooming in and out on an item

- ▶ To increase the size of an item, touch it with two fingers and pull your fingers apart.
- ▶ To decrease the size of an item, touch it with two fingers and pull your fingers together.

Rotating

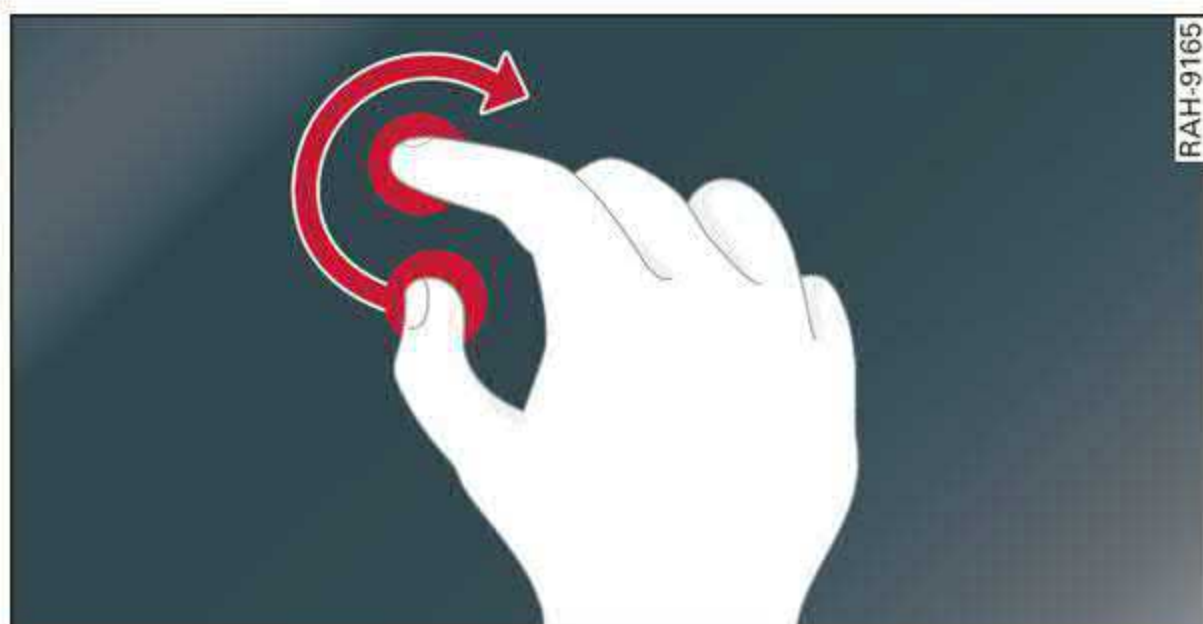

Fig. 11 Touch display: rotating

Rotating the view or perspective

- ▶ Rotate the item using two fingers.

Dragging

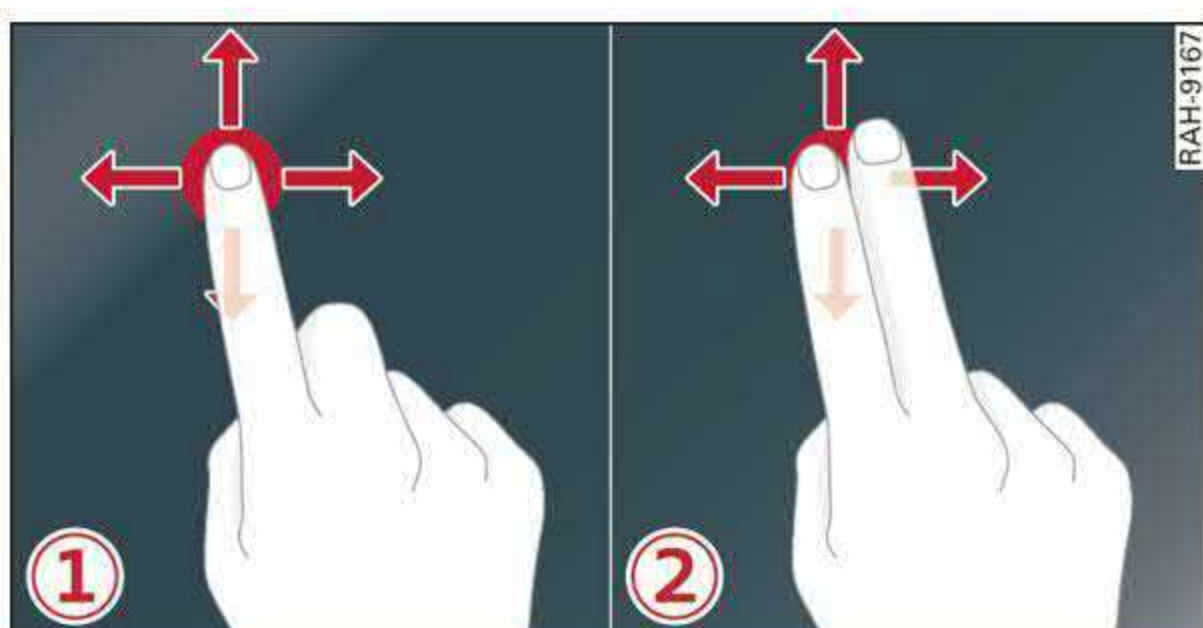

Fig. 12 Touch display: ① dragging with one finger, ② dragging with two fingers

Scrolling or browsing through menus/lists

- ▶ To scroll through menus and lists, swipe upward or downward with one finger.
- ▶ To browse through menus and lists, swipe to the right or left with one finger.

Tilting 3D displays

- ▶ Drag upward or downward with two fingers.

Dragging away from/toward the edge of the screen

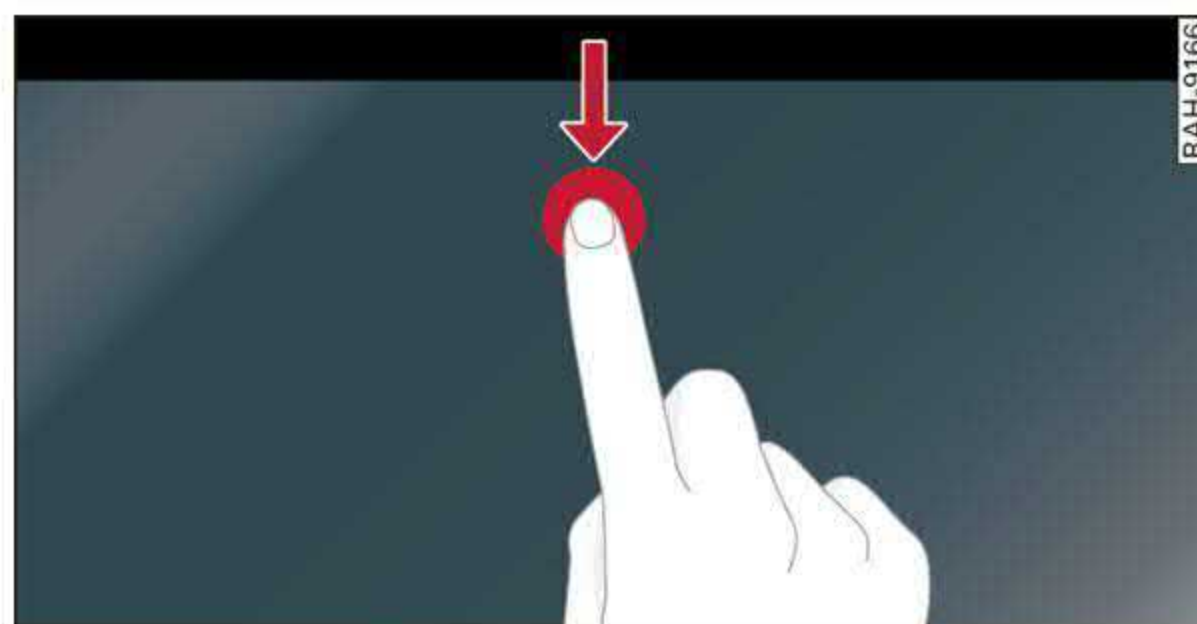



Fig. 13 Touch display: dragging away from the edge of the screen

Opening hidden menus

The  symbol indicates that there is a hidden menu.

- ▶ Use your finger to drag inward from the upper or lower edge of the screen, or
- ▶ Press the  button.

Closing hidden menus

- ▶ Press within the menu and drag it toward the upper or lower edge of the screen.

Information about menu paths

This guide shows you at a glance the paths for opening a desired menu and its settings and functions.

Example of a path

- ▶ Applies to: MMI: Select on the home screen: **SETTINGS** > **General** > **Date & time**.

Following the path

- ▶ First, determine in which display the path should be entered. In this example, it is the MMI display.
- ▶ To open the home screen, press .
- ▶ If the **SETTINGS** button is not displayed, use your finger to swipe to the left or right until it appears.
- ▶ Press the **SETTINGS** button.
- ▶ If the **General** button is not displayed, swipe toward the left or right with one finger until it appears.
- ▶ Press the **General** button.

Touch display

- ▶ If the **Date & time** button is not displayed, swipe upward or downward with one finger until it appears.
- ▶ Press the **Date & time** button.

Tips

If a menu or symbol is in parentheses in the path, for example, (**General**) or (⚙️), then it is an optional menu item that does not need to be used in every system.

Settings

- ▶ Applies to MMI: Select on the home screen: **SETTINGS > Display & Brightness > MMI**.

Possible settings:

- **Brightness**
- **Acoustic feedback during touch input**

Multi Media Interface

Traffic safety information

Audi recommends performing certain Infotainment system functions, such as entering a destination, only when the vehicle is stationary. Always be prepared to stop operating the Infotainment system in the interest of your safety and the safety of other road users.

WARNING

Only use the Infotainment system when road, traffic, weather, and visibility conditions permit and always in a way that allows you to maintain complete control over your vehicle.

Tips

Certain functions are not available while driving.

Switching on or off

Switching the MMI on or off

- ▶ To switch the MMI off, press and hold the volume knob ⇨ *page 26, fig. 20* until all Infotainment functions are switched off.

- ▶ To switch the MMI on, press the volume knob.

Restarting the MMI

- ▶ Press and hold the volume knob for at least 10 seconds.

Switching the center display on or off

- ▶ To switch the center display off, press  in the notification center ⇨ *page 20*.
- ▶ To switch on the center display, touch the display.

Introduction

You can display and operate Infotainment system and vehicle functions using the touch display in the Multi Media Interface, abbreviated MMI.

Configuration wizard

After starting for the first time, the configuration wizard helps you to set up the vehicle, for example to set the desired system language and connect a telephone.

- ▶ Follow the instructions in the center display.
- ▶ Applies to: MMI: To access the configuration wizard at a later time, select on the home screen: **HELP > Configuration wizard**.

Tool tips

Tool tips are displayed on the center display after starting for the first time. They introduce various MMI functions to you.

- ▶ Follow the instructions in the center display.
- ▶ Applies to: MMI: To access the tool tips at a later time, select on the home screen: **SETTINGS > Help > Show tool tips**.
- ▶ Applies to: MMI: To receive additional tool tips, select on the home screen: **HELP > Tool tips > Basic information** or **Expert information**.

Menus and symbols



Fig. 14 Center display: home screen

	Label	Description
①	Quick access bar	Return to the home screen or open a menu quickly ⇒ <i>page 19</i>
②	Status bar	Operate functions and apply quick settings ⇒ <i>page 20</i> , display of available notifications ⑤ ⇒ <i>page 20</i> , status indicator ⑥ ⇒ <i>page 20</i> , time
③	Display area	Select a menu, apply settings, display content ⇒ <i>page 20</i>
④	Shortcuts	Use shortcuts ⇒ <i>page 21</i>

Description of common symbols

You can operate the default functions using the symbols that follow. The symbols may be found in any menu, depending on the context.

Symbol	Description
↶	Go back one level
✕	Close the menu
🔍	Search for content
ⓘ	Open explanations for a menu
⚙️	Open settings for the selected menu
🗄️	Open the submenu
✎	Adjust the settings
☆/★	Set as favorite
☐/☑️	Switch functions on or off
🔌/🔌	Switch functions on or off
🔵/🔵	Switch functions on or off
⋮	Open additional actions
>	Open additional information for the selected menu

i Tips

The following information primarily shows illustrations of the center display in the largest possible screen size. The display or location of the items shown may vary depending on the vehicle equipment.

Quick access

With quick access, you can return to the home screen and quickly switch between four menus that can be individually configured.

Returning to the home screen or opening a menu quickly

- ▶ Press or one of the four buttons.

Configuring quick access

- ▶ Press and hold a button on the home screen display area or in the quick access bar.
- ▶ To move a button to the quick access bar, pull it from the display area to the quick access bar.
- ▶ To adjust the placement of the buttons in the quick access bar, pull them to the desired position in the bar.
- ▶ Press **Done** to complete the configuration. ▶

i Tips

The position of  cannot be adjusted.

Display area

You can freely change the location of the buttons on the home screen display area.

Configuring the display area

- ▶ Press and hold a button on the home screen display area.
- ▶ To adjust the placement of the buttons, pull them to the desired locations.
- ▶ Press **Done** to complete the configuration.

Switching between menu pages

If a menu contains multiple menu pages,  is displayed in the display area. The white bar shows the location of the current menu page.

- ▶ To switch between menu pages, swipe your finger to the right or left.

Status display

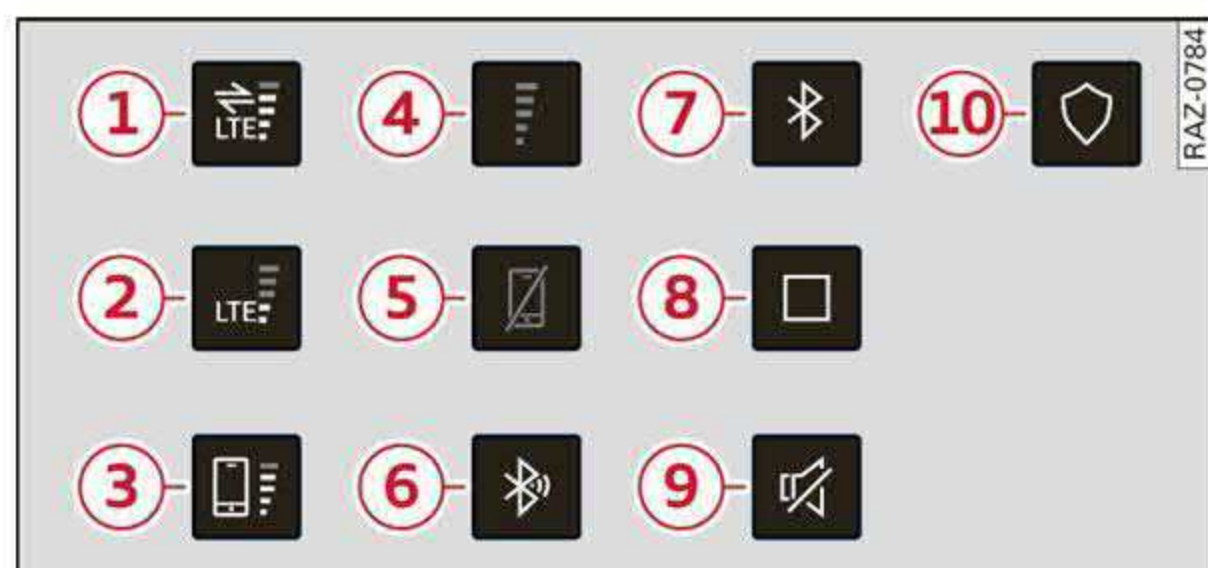

Fig. 15 Center display: frequently used symbols in the status bar

The symbols in the status bar show you information at a glance, such as if a mobile device is connected or if there is a data connection. The most common symbols are listed in the table.

	Description
①	There is a data connection. The bar indicates the signal strength of the data connection. Data is being transmitted now.
②	There is a data connection. The bar indicates the signal strength of the data connection. No data is being transmitted now.

	Description
③	A mobile device is connected. The bar indicates the signal strength of the cell phone connection.
④	There is no data connection.
⑤	An error occurred with the mobile device connection to the MMI.
⑥	A Bluetooth device is connected.
⑦	Bluetooth is switched on, but no Bluetooth device is connected.
⑧	Audio playback was interrupted.
⑨	The audio source is muted.
⑩	Privacy settings are enabled. The additional symbol indicates which privacy settings are currently activated ⇒ <i>page 262</i> .

Notification center

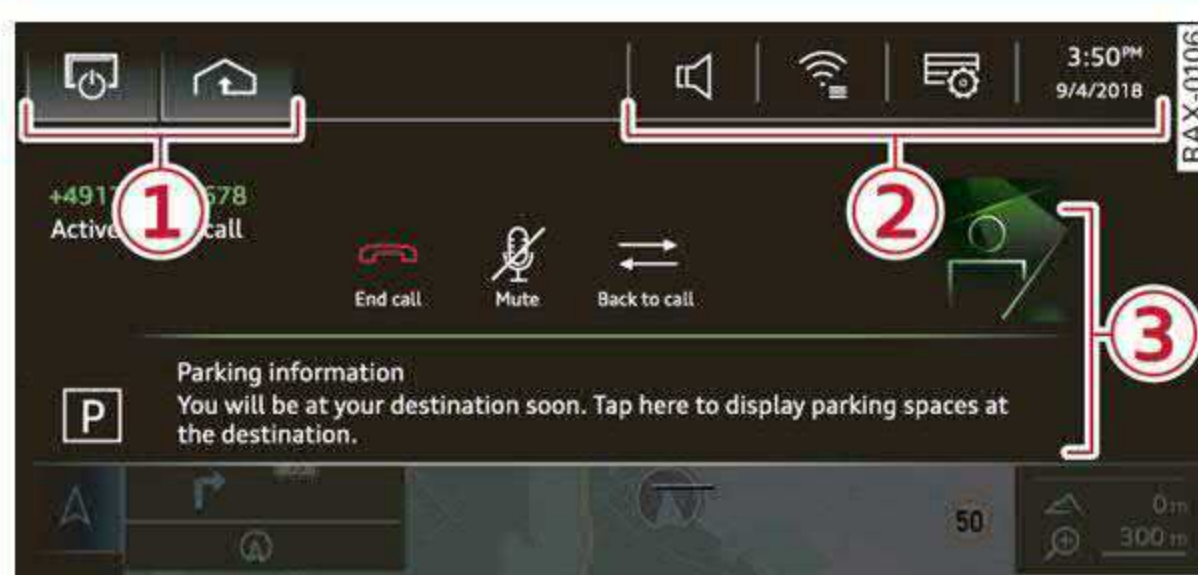



Fig. 16 Center display: notification center

Notifications can be displayed in the center display. After a specified time, they will be hidden and a corresponding symbol will appear in the status bar ⑤ ⇒ *page 19, fig. 14*. In the notification center, you can view these notifications ③ ⇒ *fig. 16*, apply quick settings ②, and operate functions ①.

Using the notification center

- ▶ To open the notification center, pull the status bar downward, or
- ▶ Press the  button on the status bar.
- ▶ To turn quick settings on or off, press the respective symbol ①.
- ▶ To apply quick settings, press the respective symbol ②.
- ▶ To obtain additional information about a notification, press it.



- ▶ To delete a notification, pull it toward the right edge of the screen.
- ▶ If there are more than four notifications in the notification center, the older notifications will be hidden. To display the older notifications, drag your finger upward on the screen.

Setting which content is displayed



You can set whether some notifications should be displayed.

- ▶ To set the displayed content, press , or
- ▶ Applies to MMI: Select on the home screen: **SETTINGS > Notifications.**
- ▶ Select and confirm which notifications should be displayed.

Possible functions

Symbol	Description
	Press: switches the center display on or off
	Press and hold: switches screen clearing mode on or off
	Opens the garage door opener function

Possible quick settings

Symbol	Description
	Apply sound settings
	Manage connected devices
	Set displayed content in the notification center
9/4/2018	Set date and time

Shortcuts

By creating shortcuts, you have quick access to various items, such as radio stations, frequently used contacts, or vehicle settings.

Adding shortcuts

The **...** buttons in the center display indicate, for example, if a selected radio station can be added to the shortcuts. Depending on the context, you may also be able to add items from a list to the shortcuts.

- ▶ Press **...** or press and hold an item in a list.
- ▶ Press **Save as a shortcut.** The selected item will be added to the shortcuts and displayed as a tile.

Using shortcuts

- ▶ Applies to: MMI: Select on the home screen: **SHORTCUTS**  ⇒ *page 19, fig. 14.* The saved shortcuts will be displayed.
- ▶ To access the stored function, press the respective tile.

Moving or deleting shortcuts

- ▶ Press and hold a shortcut.
- ▶ To adjust the order of the shortcuts, drag a shortcut to the desired location.
- ▶ To delete a shortcut, press .

Text input

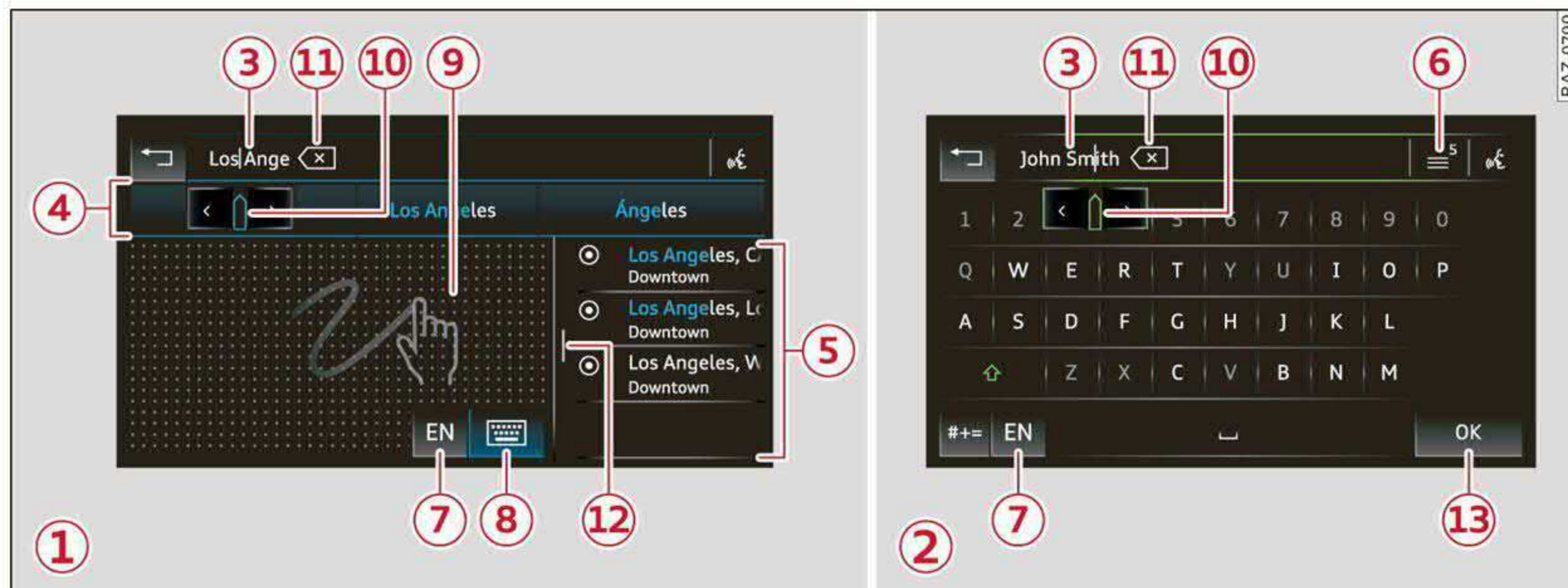

Fig. 17 Center display: text input diagram with MMI Navigation plus ① / MMI Radio plus ②

Overview

Depending on the vehicle equipment, your vehicle may have the following systems for entering text:

- ▶ Applies to: vehicles with MMI Navigation plus: ① You can enter text using the on-screen keyboard or with the handwriting function.
- ▶ Applies to: vehicles with MMI Radio plus: ② You can only enter text using the on-screen keyboard.

In the input fields of various menus, you can enter letters, numbers and characters, for example to find an address in navigation*.

The text that is currently entered is displayed in the center display ③. Depending on the context, suggestions will be given based on the characters already entered ④ and results will be displayed ⑤ or ⑥.

Opening text input

- ▶ Tap inside the input field ③.

Switching input languages

Requirement: multiple input languages must be defined in the MMI ⇒ page 23.

- ▶ To switch between the defined input languages, press the button ⑦.

Switching the input methods



Applies to: vehicles with MMI Navigation plus

- ▶ To switch between handwriting input or the on-screen keyboard, press the button ⑧.

Entering text

- ▶ Applies to: the on-screen keyboard: To enter text, press the buttons on the keyboard. Depending on the usage context, you may also be able to swipe over the letters ¹⁾.
- ▶ Applies to handwriting input: To enter text, simply write in the input area using one finger ⑨. You can write the separate characters next to each other or one on top of the other without having to move your finger over after writing a character. When you end the entry, the writing is interpreted by the system.
- ▶ Applies to: the on-screen keyboard with an input language that uses accented characters: To enter accented characters (such as â, ç, ñ, ö), press and hold a character that has accented versions available and select the desired accented character.
- ▶ Applies to: handwriting input: To enter a space, drag a line from left to right in the input section ⑨.
- ▶ To select a location in the text input, press on the desired location in the input field. You can control the location more accurately using the slider in the display ⑩.

1) Depending on the country or equipment

- ▶ To delete individual characters, press  11, or
- ▶ Applies to: handwriting input: Drag a line from right to left in the input section 9.
- ▶ To delete multiple characters, press and hold  11.
- ▶ To delete all characters at a specific location, press and hold  11 and drag up to the desired location ¹⁾. When released, the highlighted characters are deleted.

Accepting suggested words or selecting entries from the results list

Applies to: vehicles with MMI Navigation plus

- ▶ To accept a suggested word 4 or select an entry from the results list 5, press on it.
- ▶ To display more content in the results list, drag your finger upward or downward on the screen.
- ▶ To expand the results list, press the button 12 or drag it to the desired position.

Selecting entries from the results list

Applies to: vehicles with MMI Radio plus

- ▶ To display the results list, press the button 6 or 13.
- ▶ To display more content in the results list, drag your finger upward or downward on the screen.

Setting the input language or keyboard layout

- ▶ Select on the home screen: **SETTINGS** > **Language & keyboard** > **Keyboard**.
- ▶ To define additional input languages, press the  button.
- ▶ To change the keyboard layout for an input language, press >. For example, you can select between QWERTZ and QWERTY.

¹⁾ Depending on the country or equipment

Voice operation

General information

You can operate many functions in the vehicle easily using voice commands.

Using the voice operation system effectively

- ▶ Speak clearly and distinctly at a normal volume. Speak louder when driving faster.
- ▶ Emphasize the words in the commands evenly and do not leave long pauses.
- ▶ Close the doors, the windows, and the sunroof* to reduce background noise. Make sure that passengers are not speaking when you are giving a voice command.
- ▶ Do not direct the vents toward the hands-free microphone, which is in the roof headliner near the front interior lights.
- ▶ Only the driver should speak to the system, because the handsfree microphone is aimed toward this seating position.

WARNING

- Direct your full attention to driving. As the driver, you have complete responsibility for safety in traffic. Only use the functions in such a way that you always maintain complete control over your vehicle in all traffic situations.
- Do not use voice operation in emergencies because your voice may change in stressful situations. The system may take longer to dial the number or may not be able to dial it at all. Dial the emergency number manually.

Tips

There are no voice guidance* prompts when a dialog is active.

Voice recognition system





Applies to: vehicles with voice recognition system



Fig. 18 Center display: voice recognition system





Switching the voice recognition system on or off

Requirement: the ignition and the MMI must be switched on. A system language supported by the voice recognition system must be set. There must be no phone calls in progress and the parking aid must not be active.

- ▶ To switch the voice recognition system on, briefly press the  button on the multifunction steering wheel, or depending on the context, press  in the center display.
- ▶ To switch the voice recognition system off, press and hold the  button on the multifunction steering wheel, or say or press **Cancel** .

Using the voice recognition system

In the voice recognition system menu, possible commands or help settings are displayed for the current dialog .

- ▶ Say the desired command after the signal tone.
- ▶ To receive additional help for the current dialog, say or press **Help** .
- ▶ To pause voice recognition, say or press **Pause** . To reactivate voice recognition, press  again or briefly press the  button on the multifunction steering wheel.
- ▶ Applies to: MMI: Select on the home screen: **SETTINGS > General > Speech dialog system > Allow commands during voice output**. If the function is switched on, you can simply say a new command during a prompt.

Activating the online recognizer

Applies to: vehicles with online recognizer

You can activate the online recognizer for additional functions and to improve the results of

voice recognition. When there is an active Internet connection, the spoken command is evaluated in the vehicle and online.

- ▶ When you switch on the voice recognition system for the first time, a menu for the online recognizer opens. Or:
- ▶ Applies to MMI: Select on the home screen: **SETTINGS > General > Speech dialog system > Consent to online speech recognizer.**
- ▶ Read the licensing agreements and accept them.

Activating Amazon Alexa¹⁾

Applies to: vehicles with Amazon Alexa Integration

You can activate Amazon Alexa to access special additional functions. A supported menu language must be selected. A reduced number of commands are available during this.

Requirement: you must be logged in to your myAudi account in the vehicle. The online recognizer must be activated.

- ▶ Applies to: MMI: Select on the home screen: **USER > Connect to Amazon Alexa.**
- ▶ Follow the instructions in the display.
- ▶ After connecting successfully, turn on the voice recognition system as normal ⇒ *page 24, Switching the voice recognition system on or off*, say the activation word “Alexa”, and then say the desired command.

Note

Read the information about Audi connect, and be sure to note the connectivity costs section ⇒  in *General information on page 157*.



External voice operation

Applies to: vehicles with external speech dialog system



You can access and control the voice operation on a connected mobile device through your vehicle.

Switching external voice operation on or off

Requirement: the ignition and the MMI must be switched on. A cell phone must be connected to the MMI with the **Handsfree** profile ⇒ *page 143*. The mobile device being connected must have voice control that can be controlled externally. There must be no phone calls in progress and the parking aid must not be active.

- ▶ To switch on the external voice operation, press and hold the  button longer on the multifunction steering wheel.
- ▶ To switch the external voice operation off, press and hold the  button on the multifunction steering wheel or press  ⇒ *page 24, fig. 18*.

Using external voice operation

- ▶ Say the desired command after the signal tone.
- ▶ To reactivate voice recognition when it is paused, press the  button briefly on the multifunction steering wheel or press  ⇒ *page 24, fig. 18*.

Tips

Audi simply provides access to control your cell phone with voice operation and does not take any responsibility for the contents and commands within the external voice control.

¹⁾ Audi provides access to services from third party providers. Permanent availability cannot be guaranteed, because that depends on the third party provider.

Global functions

Additional function buttons



Fig. 19 Right side of the multifunction steering wheel



Fig. 20 Volume knob with joystick function

Adjusting the volume

You can adjust the volume of an audio source or a system message (for example, from the voice recognition system) when the sound is playing.

- ▶ To raise or lower the volume, turn the right thumbwheel (3) ⇒ fig. 19 upward or downward, or turn the volume knob ⇒ fig. 20 to the right or left.
- ▶ To mute, push the right thumbwheel or the volume knob.

Selecting the previous/next track or station

- ▶ Press the |◀◀ / ▶▶| (4) or briefly press the volume knob to the left or right.

Fast forward/rewind

- ▶ Press and hold the |◀◀ / ▶▶| button (4), or press the volume control to the left or right until the desired playback position is reached.

Quick access steering wheel button

Depending on vehicle equipment, the button (5) may provide quick access to various functions.

- ▶ ☎ button, see ⇒ page 81.

You can program the * button with various functions.

- ▶ To bring up the function that is currently set, press the * button.
- ▶ To perform the function that is currently set, press and hold the * button, or:
- ▶ Applies to MMI: Select on the home screen: **VEHICLE > Settings & Service > Steering wheel button assignment.**
- ▶ Select and confirm the desired function.

Switching voice operation on or off

- ▶ ☎ button (2), see ⇒ page 24.

Using the telephone functions

- ▶ ☎ button (1), see ⇒ page 150.

WARNING

Adjust the volume of the audio system so that signals from outside the vehicle, such as police and fire sirens, can be heard easily at all times.

Personalization

User

myAudi

Applies to: vehicles with myAudi login

Requirement: you must have successfully registered at my.audi.com.

Logging in from the vehicle

Applies to: MMI

- ▶ Select on the home screen: **USER > myAudi login**.
- ▶ Log in to myAudi in the vehicle using your e-mail address and password.

To transfer existing destinations from the MMI to your myAudi account one time, confirm the system prompts with **Yes**.

Automatic login

You can select if and when an automatic login to myAudi in the vehicle should occur.

Bluetooth device 1/Bluetooth device 2*: Requirement: after a Bluetooth device has been paired with the MMI, you must be logged in to myAudi in the vehicle. Follow the system instructions and save the desired Bluetooth device. You will be automatically logged in when your Bluetooth device is connected to the MMI, and automatically logged out when the Bluetooth connection to your mobile device is disconnected.

Tips

- For some Audi connect Infotainment services, you may also have to enter your myAudi access information when accessing services in the MMI.
- You can only connect one myAudi account to your vehicle.

Opening and closing

Central locking

General information

WARNING

- If you leave the vehicle, switch the ignition off and take the key with you. This applies particularly when children remain in the vehicle. Otherwise, children could start the vehicle or operate electrical equipment (such as power windows), which increases the risk of an accident.
- Applies to vehicles with anti-theft alarm system: When the vehicle is locked from the outside, no one - especially children - should remain in the vehicle, because the windows can no longer open from the inside
⇒ *page 31, Anti-theft alarm system.* Locked doors make it more difficult for emergency workers to enter the vehicle, which puts lives at risk.

Description

All doors and the luggage compartment lid can be centrally unlocked and locked at once. You can select in the MMI if the entire vehicle or only the driver's door should unlock when unlocking the vehicle ⇒ *page 29*. The turn signals flash twice when you unlock the vehicle and flash once when you lock the vehicle. If they do not flash when locking, check if all doors and lids are closed.

Depending on the vehicle equipment, you may have different options for centrally unlocking and locking your vehicle.

- Vehicle key ⇒ *page 33*
- Sensors in the front door handles ⇒ *page 33*
- Lock cylinder in the driver's door ⇒ *page 30*
- Interior central locking switch ⇒ *page 30*

Key / vehicle key

The term “vehicle key” refers to the remote control key or convenience key*. The convenience key* is a remote control key with special functions ⇒ *page 33* and ⇒ *page 83*.

Automatic locking

If you unlock the vehicle but then do not open any of the doors, the luggage compartment, or the hood within a short period time, the vehicle locks again automatically. This feature prevents the vehicle from being accidentally left unlocked for a long period of time.

Automatic locking (Auto Lock)

The Auto Lock function locks all doors and the luggage compartment lid once the speed has exceeded approximately 9 mph (15 km/h). The vehicle will unlock again if the unlock function in the central locking switch is pressed, the “P” gear is engaged, or the ignition is switched off.



You can open the doors individually from the inside by pulling the door handle one time. To open the rear doors individually, you must pull the door handle twice.

In the event of a crash with airbag deployment, the doors will also automatically unlock to allow access to the vehicle.

Unintentionally locking yourself out

Only lock your vehicle when all of the doors and the luggage compartment lid are closed and there is no key in the vehicle. This reduces the risk of locking yourself out accidentally.

The following features help to reduce the risk of locking your vehicle key in the vehicle:

- If the driver's door is open, the vehicle cannot be locked by pressing the  button on the remote control key or by touching the locking sensor* on one of the front doors.
- Applies to: vehicles with convenience key: If the vehicle key that was used most recently is inside the luggage compartment, the luggage compartment lid will automatically open again after it closes ⇒ .
- Applies to: vehicles with convenience key: If the vehicle key that was last used is detected inside the vehicle, then it will not be possible to lock the vehicle from the outside ⇒ .

WARNING

Observe the safety precautions ⇒ *page 28*.

Note

Applies to: vehicles with convenience key

The following applies when locking the vehicle:

- If the vehicle key that was last used is detected inside the passenger compartment, then the vehicle cannot be locked from the outside **using the sensor**. Take the vehicle key with you and lock the vehicle again. Otherwise, the vehicle will not be protected against unauthorized access.
- If you try to lock the vehicle **using the button on the vehicle key** while the front passenger's or rear door is open, and you accidentally place the vehicle key inside the passenger compartment and close the door, the vehicle will lock at first. But if the keyless system detects a vehicle key inside the vehicle after it locks, then the vehicle will unlock again. The turn signals will flash several times to indicate this. If you do not open the vehicle to remove the vehicle key within a brief period, then the vehicle will lock automatically. This prevents the vehicle from being left unlocked for long periods of time. The vehicle key will then be locked inside the vehicle.
- If the luggage compartment lid closes and the system detects that the last vehicle key that was used is inside the luggage compartment, then the luggage compartment lid will open again. The turn signals will flash several times to indicate this. The doors will lock. Always take the vehicle key with you, or unauthorized persons may be able to enter the vehicle.

Tips

- Do not leave valuables unattended in the vehicle. A locked vehicle is not a safe!
- The LED in the driver's door rail blinks when you lock the vehicle. If the LED turns on for approximately 30 seconds after locking, there is a malfunction in the central locking system. Have the problem corrected by an

authorized Audi dealer or authorized Audi Service Facility.

Setting the central locking system

You can adjust the central locking system to your preferences. The settings depend on the vehicle equipment.

- ▶ Select on the home screen: **VEHICLE > Settings & Service > Central locking**.

Door unlocking

- If you select **All**, all doors and the luggage compartment lid will be unlocked when unlocking the vehicle.
- If you select **Driver's door**, only the driver's door will be unlocked. To unlock all doors and the luggage compartment lid, press the  button on the vehicle key twice. In vehicles with a convenience key*, only the driver's door will unlock when you pull the driver's door handle. If you pull another door handle, the entire vehicle will be unlocked.

The entire vehicle will always be locked if you press the  button.

Long press to open windows

You can select if all windows and the panoramic glass roof* should open using the vehicle key ⇒ *page 39, Convenience opening and closing*. If you press and hold the  button on the vehicle key, all of the windows and the panoramic glass roof* will close.

Fold mirrors

You can select if the exterior mirrors automatically fold in when locking.

Tone when locking¹⁾



You can select if an audio signal sounds when locking the vehicle.

¹⁾ This function is not available in all countries.

Central locking switch



Fig. 21 Driver's door: central locking switch

- ▶ To lock or unlock the vehicle, press the  or  button ⇒ .

When locking the vehicle with the central locking switch, the following applies:

- The doors and the luggage compartment lid cannot be opened from the outside for security reasons, for example, to reduce the risk of unauthorized entry while stopped at a light.
- The LED in the central locking switch turns on when all doors are closed and locked.
- You can open the doors individually from the inside by pulling the door handle one time. To open the rear doors individually, you must pull the door handle twice.
- In the event of a crash with airbag deployment, the doors unlock automatically to allow access to the vehicle.

WARNING

- Observe the safety precautions ⇒ *page 28*.
- The central locking button works when the ignition is switched off.
- The central locking switch is inoperative when the vehicle is locked from the outside.

Messages

 **Driver's door: malfunction! Shift to P before leaving vehicle. See owner's manual**

There is a malfunction in the driver's door. Secure the vehicle before exiting by selecting the "P" selector lever position. Drive immediately to an authorized Audi dealer or authorized Audi Service Facility to have the malfunction repaired.

Mechanically unlocking and locking the doors

If the central locking fails, you must unlock or lock the doors separately.

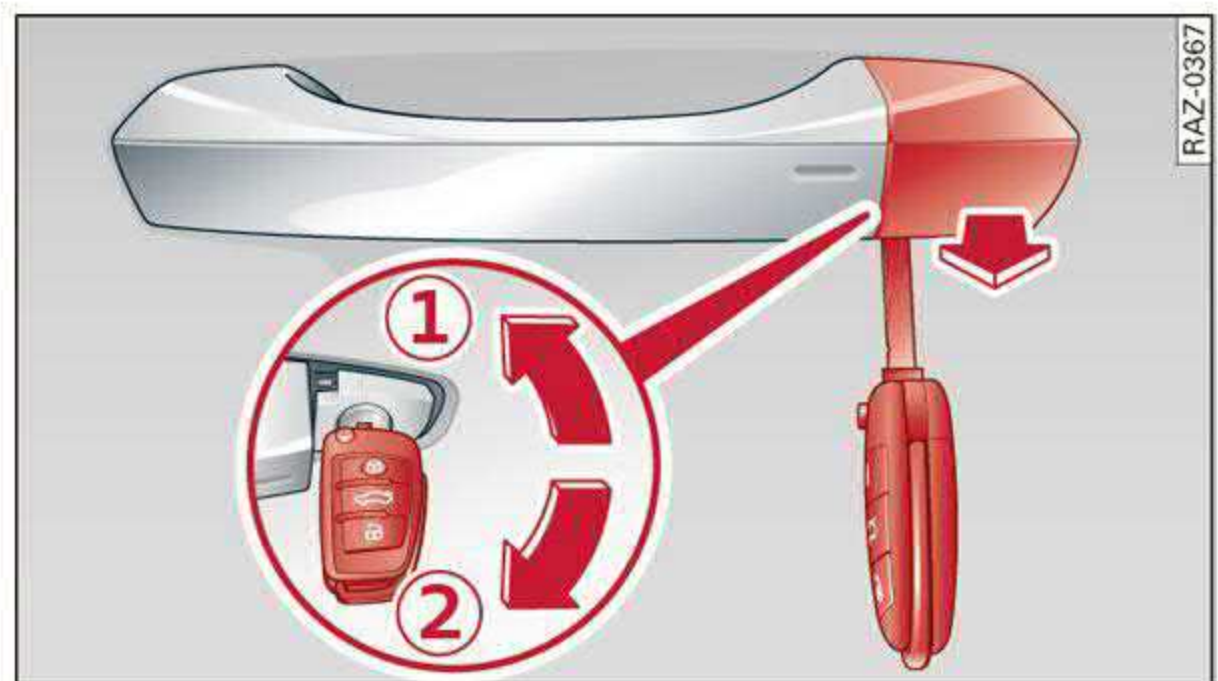



Fig. 22 Driver's door: door lock cylinder



Fig. 23 Door: mechanically locking

Unlocking or locking the driver's door with the vehicle key

- ▶ Fold out the vehicle key ⇒ *page 32, fig. 24*.
- ▶ Insert the vehicle key into the slot under the door handle and pry the cap off ⇒ *fig. 22*.
- ▶ To unlock the driver's door, turn the key to the open position in the direction of arrow **1**.
- ▶ Pull the door handle to open the driver's door.
- ▶ To lock the driver's door, select the "P" position and turn the key once to the close position **2** ⇒ .

Locking the front passenger's door and rear doors using the vehicle key

The mechanical lock is located on the edge of the doors. It is only visible when the door is open.

- ▶ Fold out the vehicle key ⇒ *page 32, fig. 24*.
- ▶ Remove the cap from the opening ⇒ *fig. 23*.
- ▶ Insert the vehicle key into the slot on the inside and turn it all the way to the right (on the right door) or left (on the left door).

- ▶ Install the cap in the opening and close the door.

Once the front passenger's door or rear doors close, it will no longer be possible to open them from the outside. The front doors can be opened from the inside by pulling the door handle one time. The rear doors can be unlocked from the inside by pulling the door handle one time and then opened by pulling the door handle again. If the child safety lock in one of the rear doors is activated, you must first pull the door handle from the inside. Then you can open the door from the outside.

WARNING

Observe the safety precautions ⇒ *page 28*.

Anti-theft alarm system

Applies to: vehicles with anti-theft alarm system

If the anti-theft alarm system detects a vehicle break-in, audio and visual warning signals are triggered. The anti-theft alarm system is switched on or off when locking or unlocking your vehicle. If the alarm is triggered, it will shut off automatically after a certain amount of time.

Switching the alarm off manually

- ▶ To switch the alarm off, press the  button on the vehicle key or switch the ignition on.

Depending on the vehicle equipment, the anti-theft alarm system may have the following features:

Break-in security feature

The alarm will sound if there is a break-in at the doors, hood, and/or luggage compartment lid.

Interior/towing protection monitor

The alarm will be triggered if there are movements detected in the vehicle interior (for example, by animals) or if there is a change in the vehicle angle (for example, when the vehicle is being towed).

You can prevent the alarm from being triggered by deactivating the interior/towing protection monitor.

Deactivating the interior/towing protection monitor

There are the following options for deactivating the interior/towing protection monitor:

- ▶ Press the  button on the vehicle key a second time **within two seconds**. Or
- ▶ Applies to: vehicles with convenience key:
Touch the sensor on the door handle a second time **within two seconds**. Or
- ▶ Turn the vehicle key in the door lock to the close position a second time **within two seconds**.

If you lock the vehicle, then the interior/towing protection monitor will stay off until the next time the vehicle is unlocked.

WARNING

No one, especially children, should stay in the vehicle when it is locked from the outside, because the windows can no longer be opened from the inside. Locked doors make it more difficult for emergency workers to enter the vehicle, which puts lives at risk.

Tips

The interior/towing protection monitoring only functions correctly when the windows and the roof* are closed.

Keys

Key set

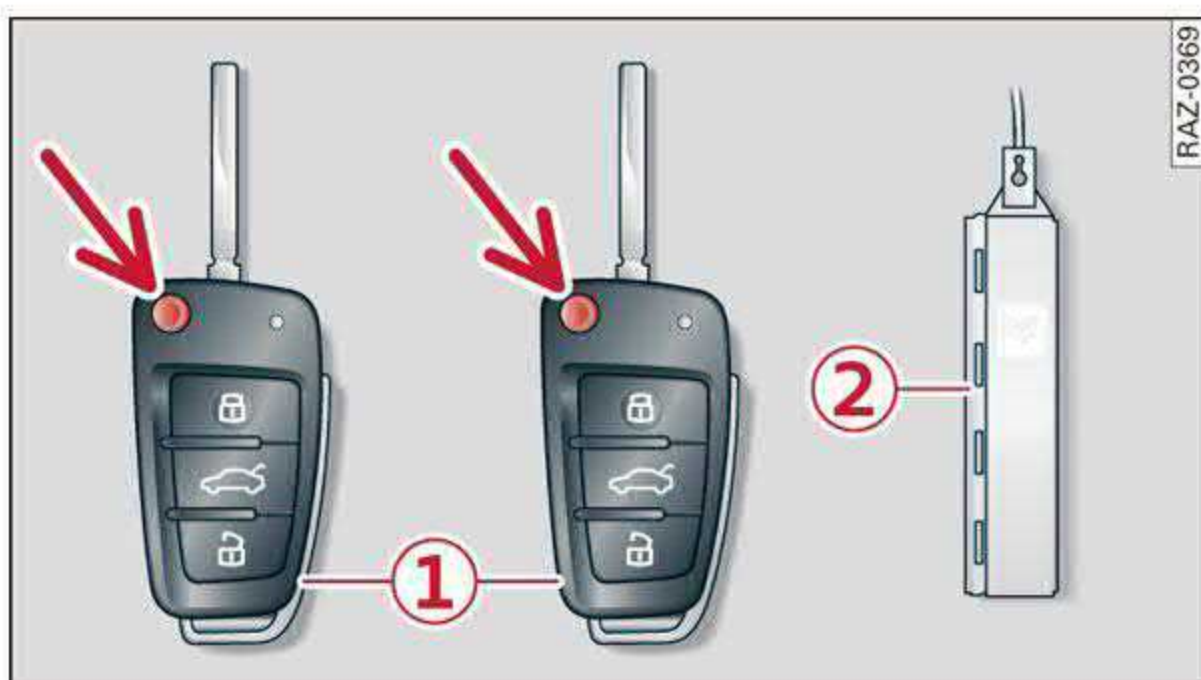

Fig. 24 Your vehicle key set



Fig. 25 Vehicle key: PANIC button

① Vehicle key

You can unlock and lock your vehicle with the vehicle key. To fold the key out, press the release button ⇒ *fig. 24*.

If necessary, you can use the vehicle key to:

- Applies to: vehicles with lockable glove compartment: locking/unlocking the glove compartment.
- Manually unlock and lock the doors ⇒ *page 30*.
- Unlock the luggage compartment lid using the emergency release ⇒ *page 37*.

② Key fob with vehicle code

The key tag can be scratched off to reveal the vehicle code. It does not have a function.

③ PANIC button

In an emergency, you can press the PANIC button to trigger the alarm for the anti-theft alarm system. The vehicle horn and emergency flashers will turn on if you trigger the alarm.

- To trigger the alarm, press the **PANIC** button ③ ⇒ *fig. 25*.
- To turn the alarm off, press the **PANIC** button again.

Lost key/replacing a key

If a vehicle key is lost, contact an authorized Audi dealer or authorized Audi Service Facility. Have this vehicle key deactivated. It is important to bring all keys with you. If a key is lost, you should report it to your insurance company.

Electronic immobilizer

The immobilizer prevents unauthorized use of the vehicle.

In some cases, it may not be possible to start the vehicle if there is a vehicle key from a different vehicle manufacturer on the key chain.

Data in the vehicle key

When driving, service and maintenance-relevant data is continuously stored in your vehicle key. An authorized Audi dealer or authorized Audi Service Facility can read out this data and tell you about the work your vehicle needs.

⚠ WARNING

Observe the safety precautions ⇒ *page 28*.

! Note

Protect the key against high temperatures and direct sunlight.

🌱 For the sake of the environment

⊗ Do not dispose of vehicle keys in household trash. They contain materials that can be recycled. Contact an authorized Audi dealer or authorized Audi Service Facility for more information.

i Tips

- The vehicle key function can be temporarily disrupted by interference from transmitters near the vehicle working in the same frequency range (such as a mobile device or radio equipment). Always check if your vehicle is locked.

- You can view the number of keys programmed to the vehicle by selecting on the home screen: **VEHICLE > Settings & Service > Vehicle information**.
- The system complies with United States FCC regulations and ISED regulations
⇒ *page 267*.

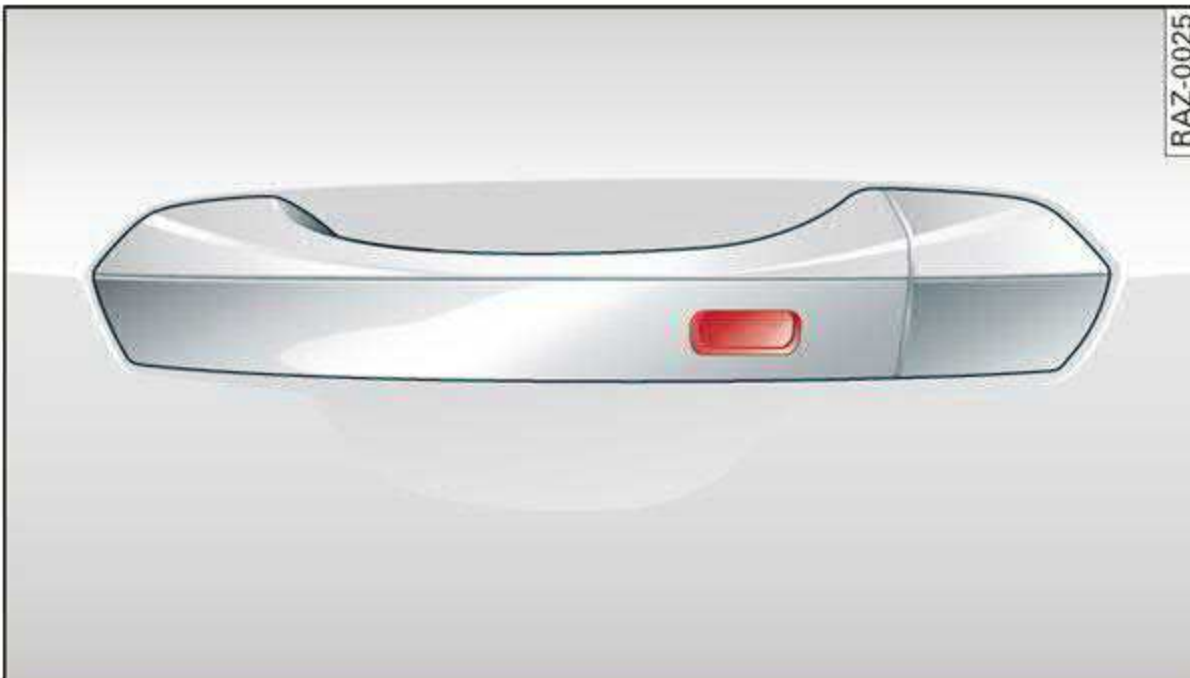

Unlocking and locking the vehicle



Applies to: vehicles with convenience key
Fig. 26 Door handle: sensor* for locking the vehicle

Depending on the vehicle equipment, you may have various options for unlocking and locking your vehicle. The settings in the MMI specify which doors will unlock ⇒ *page 29*.

Unlocking or locking using the vehicle key buttons

- ▶ To unlock the vehicle, press the  button
⇒ *page 32, fig. 24*.
- ▶ To lock the vehicle, press the  button **once**.

Unlocking or locking using the sensors

Applies to: vehicles with convenience key

- ▶ To unlock the doors or the luggage compartment lid, grasp the door handle on the door you would like to unlock or the luggage compartment lid handle.
- ▶ To lock the vehicle, close the doors and touch the outer sensor on the door handle **once** ⇒ *fig. 26*. Do not grasp the door handle while locking the vehicle, or else the vehicle will not lock. The door cannot be opened for a brief period directly after locking it. This way you have the opportunity to check if the doors locked correctly.

Deactivating the sensor unlocking function

Applies to: vehicles with convenience key

You can deactivate the unlock function with the convenience key (keyless access) for one locking and unlocking cycle.

- ▶ Place the selector lever in the "P" position; otherwise, the vehicle cannot be locked.
- ▶ Close the door.
- ▶ Press the  lock button on the convenience key and touch the sensor on the door handle (driver's door) one time within five seconds of pressing the button ⇒ *fig. 26*. Do not grasp the door handle while locking the vehicle, or else the vehicle will not lock.
- ▶ To check if the function has been deactivated, wait at least 10 seconds and pull the door handle again. The door should not open.

After that, it will only be possible to unlock the vehicle using the remote control key or by mechanically unlocking the lock cylinder. Keyless access will be active again after the next time the vehicle is locked/unlocked.

WARNING

Observe the safety precautions ⇒ *page 28*.

Tips

- Only use the vehicle key when you can see the vehicle.
- The vehicle can only be locked when the "P" selector lever position is engaged.
- Do not use the vehicle key to lock and unlock when you are inside the vehicle. Otherwise, you could trigger the anti-theft alarm*. If this happens, press the  unlock button.

Tips

Applies to: vehicles with convenience key

- When unlocking or locking the vehicle, the convenience key cannot be more than approximately 4 feet (1.5 m) away from the door handle or luggage compartment.
- Unlocking with the convenience key (keyless access) can be deactivated ⇒ *page 33*.

Opening and closing

- To prevent the vehicle battery from discharging, the energy management gradually switches off convenience functions that are not needed. You then may no longer be able to unlock your vehicle with the sensors.

LED and batteries in the remote control key

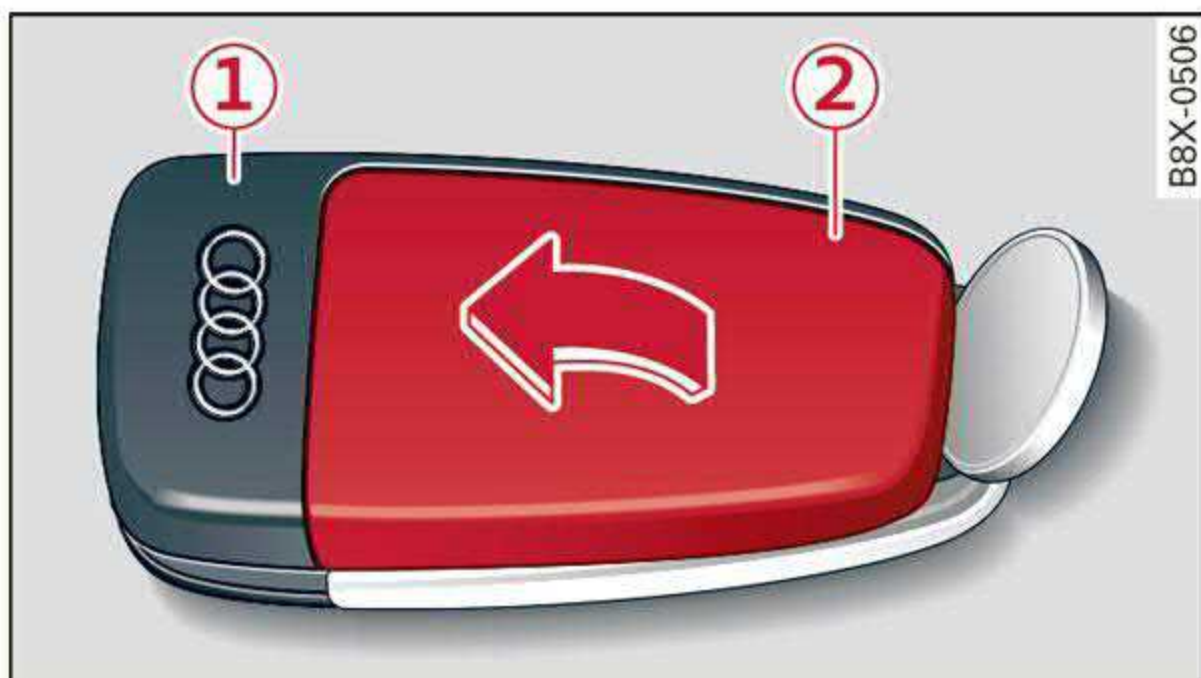

Fig. 27 Remote control key (rear side): opening the cover

LED on the remote control key

The LED in the remote control key (front side) indicates the status of the key.

- ▶ If you press a button briefly, the LED blinks once.
- ▶ If you press and hold a button (convenience opening/closing), the LED blinks several times.
- ▶ If the LED does not blink, the vehicle key battery is drained. Replace the battery in the vehicle key.

Replacing the remote control key battery

- ▶ Pry the cover ② off of the key ① using a coin ⇒ *fig. 27*.
- ▶ Insert the new battery with the “+” facing up.
- ▶ Press the cover back onto the key until it clicks into place.

WARNING

If batteries or coin cell batteries are swallowed or enter the body in any other way, they can cause serious or fatal injuries within a short period of time. There is a risk of chemical burns.

- Keep vehicle keys and key fobs with batteries out of the reach of children.
- Keep new or used batteries away from children.

- If the battery compartment on a vehicle key does not close securely, stop using the key and keep it away from children.
- Seek medical attention immediately if you suspect that a battery was swallowed or has entered the body in any other way.



For the sake of the environment

Discharged batteries must be disposed of using methods that will not harm the environment. Do not dispose of them in household trash.





Tips

Replacement batteries for the remote control key must meet the same specifications as the original battery.

Remote control key synchronization

The remote control key must be synchronized if the vehicle does not lock/unlock with the remote control.

- ▶ Press the  remote control key button.
- ▶ Insert the key in the driver's door lock within 30 seconds ⇒ *page 30*.
- ▶ Press the  button or  button.

Luggage compartment lid

General information



WARNING

- Applies to vehicles with anti-theft alarm system: When the vehicle is locked from the outside, no one - especially children - should remain in the vehicle, because the windows can no longer open from the inside ⇒ *page 31, Anti-theft alarm system*. Locked doors make it more difficult for emergency workers to enter the vehicle, which puts lives at risk.
- Always close and lock the luggage compartment lid and the doors when the vehicle is not in use. Otherwise someone such as a child could enter the vehicle through the

luggage compartment and become locked inside it. To reduce the risk of injury, do not allow children to play in or around the vehicle.

- To reduce the risk of injuries by pinching, make sure that no one is in the operating area of the luggage compartment lid, including the hinge areas and the upper and lower edge of the luggage compartment lid.
- After closing the luggage compartment lid, make sure that it is latched. The luggage compartment lid could open suddenly while driving, which would increase the risk of an accident.
- Never drive with the luggage compartment lid ajar or open, because poisonous gases from the surrounding area can enter the vehicle interior and increase the risk of asphyxiation.
- Applies to vehicles with power-operated or sensor-controlled luggage compartment lid: if there is a luggage rack (such as a bicycle rack) on the luggage compartment lid, the luggage compartment lid may not open completely, or it may close by itself if open due to the extra weight. Therefore, the open luggage compartment lid must be given additional support or the cargo must first be removed from the luggage rack.
- Applies to vehicles with power-operated or sensor-controlled luggage compartment lid: Pay careful attention when closing the luggage compartment lid. Otherwise, you could cause serious injury to yourself or others despite the pinch protection.

Note

The luggage compartment lid can bump into objects such as the garage ceiling when opening and become damaged.

Tips





When the vehicle is locked, the luggage compartment lid can be unlocked separately by pressing the  button on the vehicle key. The luggage compartment lid locks automatically when it is closed again.

Opening and closing the luggage compartment lid



Fig. 28 Driver's door: opening the luggage compartment lid

Opening the luggage compartment lid

- ▶ Applies to: vehicles without convenience key: Unlock the vehicle or the luggage compartment lid using the /  button on the vehicle key and press the handle in the luggage compartment lid. Or
- ▶ Applies to: vehicles with convenience key: Press the handle in the luggage compartment lid. The vehicle key cannot be more than approximately 4 feet (1.5 m) away from the luggage compartment. Or
- ▶ Applies to: vehicles with automatic luggage compartment lid: When the ignition is switched off, press and hold the  button on the vehicle key for at least one second. Or
- ▶ Engage the "P" selector lever position and pull the  button* in the driver's door.

Closing the luggage compartment lid

- ▶ Applies to vehicles without automatic luggage compartment lid: Use the inside grip to pull the luggage compartment lid down and allow it to drop gently to close it.
- ▶ Applies to vehicles with automatic luggage compartment lid: Note ⇨ [page 36](#).

Automatic luggage compartment lid

Applies to: vehicles with automatic luggage compartment lid

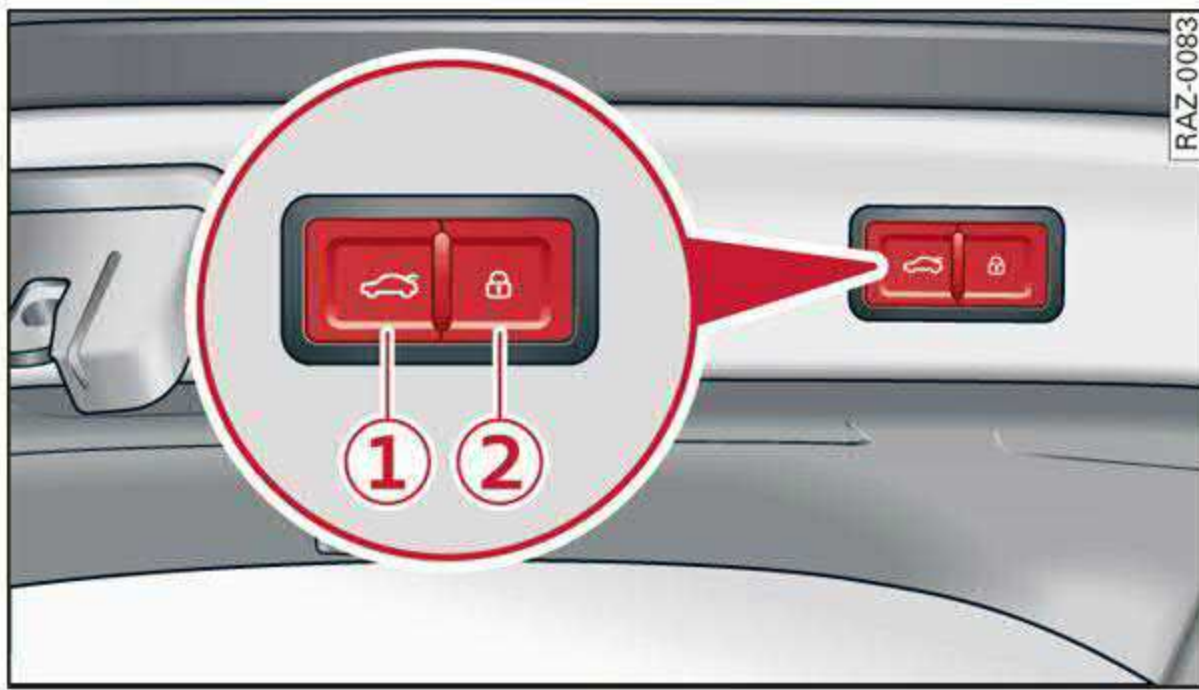

Fig. 29 Luggage compartment lid: ① closing button*, ② lock button* (vehicles with convenience key*)

The luggage compartment lid can be opened and closed automatically ⇒ ⚠ in *General information on page 34*.

Opening the luggage compartment lid

- ▶ When the ignition is switched off, press and hold the button on the vehicle key for at least one second ⇒ *page 32, fig. 24*. Or
- ▶ Engage the "P" selector lever position and pull the button* in the driver's door. Or
- ▶ Applies to: vehicles with convenience key: Press the handle in the luggage compartment lid. The vehicle key cannot be more than approximately 4 feet (1.5 m) away from the luggage compartment.

Closing the luggage compartment lid

- ▶ Press the button in the luggage compartment lid. Or
- ▶ Press the handle in the luggage compartment lid. Or
- ▶ Press the luggage compartment lid downward slightly. Or
- ▶ When the ignition is switched on, pull the switch in the driver's door ⇒ *page 35, fig. 28* until the luggage compartment lid is closed. Or
- ▶ Applies to: vehicles with convenience key: Press and hold the button on the vehicle key while the ignition is switched off until the luggage compartment lid closes. Make sure there is enough distance (maximum of approximately 9 feet (3 m)) between you and the luggage compartment lid. Or
- ▶ Press the button. Or

- ▶ Applies to vehicles with convenience key: When the ignition is switched off, press the * button in the luggage compartment lid. The vehicle key must not be more than approximately 4 feet (1.5 m) away from the luggage compartment and it must not be inside the vehicle. If you press the * button, then the vehicle will lock.

Stopping automatic opening or closing

You can interrupt the luggage compartment lid when it is opening or closing automatically:

- ▶ Press the button on the convenience key*.
- ▶ Press the / * buttons in the luggage compartment lid or the handle again.
- ▶ If you now press the / * buttons in the luggage compartment lid, the handle, or the button on the convenience key again, the luggage compartment lid will open or close again.

If something blocks the luggage compartment lid or makes it difficult for the lid to move, the lid will stop opening or closing.

Storing the luggage compartment lid opening position

The position must be at a certain height or higher to store.

- ▶ Bring the luggage compartment lid into the desired open position. If you want to move the luggage compartment lid to a lower position, move it slowly in small increments; otherwise, the luggage compartment lid will close automatically.
- ▶ Press and hold the button in the luggage compartment lid for at least four seconds to store the new opening position. A visual and audio signal will follow.
- ▶ To set a higher open position, wait at least five seconds and then carefully press the luggage compartment lid upward.
- ▶ Press and hold the button again for at least four seconds to store the desired opening position.

Tips

The luggage compartment lid can be operated manually if the vehicle battery is low. It is

necessary to use more force when doing this. Move the lid slowly to reduce the amount of force needed.

Opening and closing the luggage compartment lid with foot motion (kicking movement)

Applies to: vehicles with sensor-controlled luggage compartment lid



Fig. 30 Vehicle rear: foot motion (example)

The luggage compartment lid can be opened and closed automatically ¹⁾ ⇒ ⚠ in *General information* on page 34.

Requirements: you must be carrying your convenience key* with you. The ignition must be switched off. You must be standing behind the luggage compartment lid, toward the left side of the vehicle. Depending on the equipment, it may also be possible to stand near the center of the vehicle or toward the right side of it.

- ▶ Move your foot back and forth under the bumper one time ⇒ *fig. 30*. Do not touch the bumper. Make sure you have firm footing. The luggage compartment lid will open or close ¹⁾ once the system detects the movement. The automatic opening or closing will be canceled if you repeat one of the movements described.

⚠ WARNING

Observe the safety precautions ⇒ *page 34*.

i Tips

The luggage compartment lid will only open or close ¹⁾ if you perform the movement as

described. This prevents the luggage compartment lid from opening or closing due to similar movements ¹⁾, such as when you walk between the rear of the vehicle and your garage door. In some situations, the function may be limited or temporarily unavailable. This may happen if:

- You are standing too close to the bumper or too far away from it
- The luggage compartment lid was closed or opened immediately beforehand
- You park close to a hedge and the branches move back and forth under the vehicle for a long period of time
- You clean your vehicle, for example with a pressure washer or in a car wash
- There is heavy rain
- The bumper is very dirty, for example after driving on salt-covered roads
- There is interference to the vehicle key's radio signal, such as from mobile devices or remote controls

Mechanically unlocking the luggage compartment lid

The luggage compartment lid can be released from the inside in an emergency.



Fig. 31 Rear lid opening: access to the emergency release

- ▶ Fold the backrest on the rear bench seat forward ⇒ *page 77*.
- ▶ Fold out the vehicle key ⇒ *page 32, fig. 24*.
- ▶ Pry the cover off using the vehicle key ①. ▶

¹⁾ The closing function applies to vehicles that also have automatic luggage compartment lid operation.

- ▶ Press the lever with the vehicle key in the direction of the arrow ② to release the luggage compartment lid.
- ▶ Fold the backrest backward until it locks into place.

WARNING

Observe the safety precautions ⇒ *page 34*.

WARNING

If you have folded the backrests into the upright position, always check if the lock is correctly engaged by pulling forward on the backrest.

Child safety lock

The child safety lock prevents the rear doors from being opened from the inside and the rear power windows from being operated.

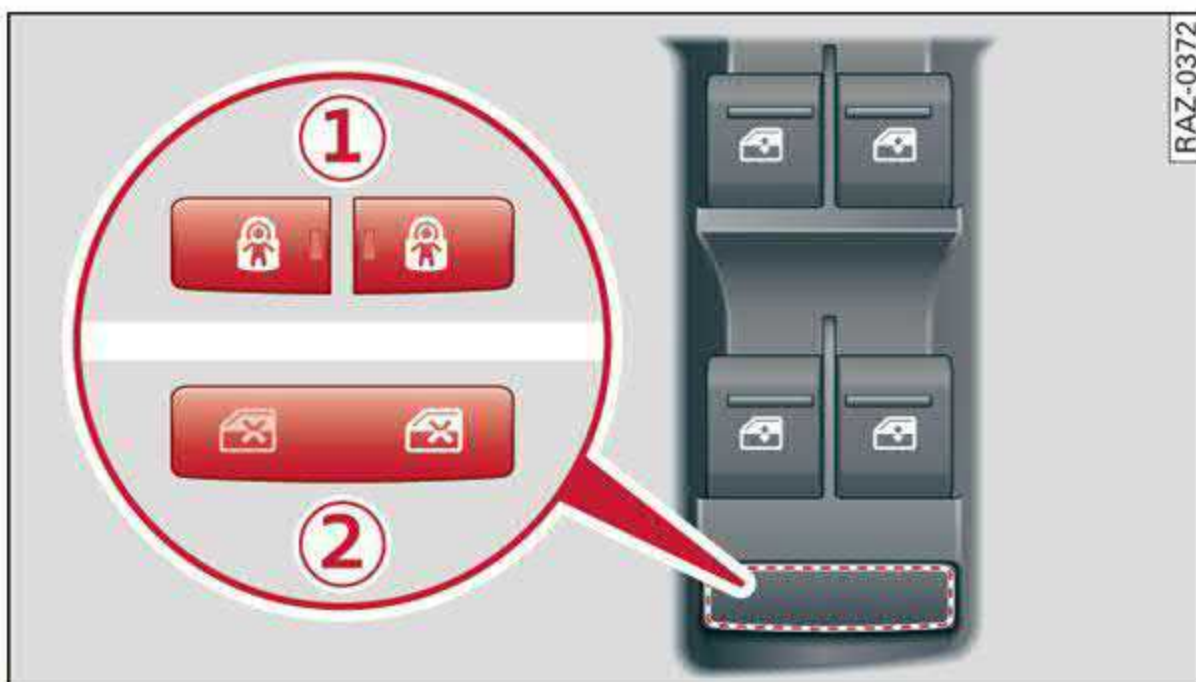



Fig. 32 Section of driver's door: controls



Fig. 33 Rear door: manual child safety lock

Vehicles with button

Applies to: vehicles with power child safety locks

- ▶ To activate and deactivate the child safety lock (door handle and power window switch) for the a rear door, press the left or right  button in the driver's door ① that corresponds to that

rear door ⇒ *fig. 32*. The indicator light in the button turns on/blinks.

- ▶ Make sure the child safety lock is working by checking the function on the rear power window switch and door handle.

Vehicles with button

Applies to: vehicles with manual child safety lock

- ▶ To activate or deactivate the child safety lock for the power window switch in the rear doors, press the  button in the driver's door ② ⇒ *fig. 32*. The indicator light in the button turns on/blinks.
- ▶ To activate or deactivate the manual child safety lock for the rear door handle, open the rear door and turn the key switch either in the direction of the arrow (to activate) or opposite the direction of the arrow (to deactivate) using with the vehicle key ⇒ *fig. 33*. This will disable the function of the rear door handle.
- ▶ Make sure the child safety lock is working by checking the function on the rear power window switch and door handle.

When the child safety lock is switched on, the following functions are disabled:

- The rear inner door handles
- The rear power windows

Message in the instrument cluster display

 /  **Child safety lock: malfunction! Please contact Service**

There is a malfunction in the child safety lock. Press the  button again.

If the message stays on, drive immediately to an authorized Audi dealer or authorized Audi Service Facility to have the malfunction repaired.

WARNING

- Observe the safety precautions ⇒ *page 28*.
- A malfunction in the child safety lock could allow the rear doors to be opened from the inside, which increases the risk of an accident.

Power windows

Opening and closing the windows

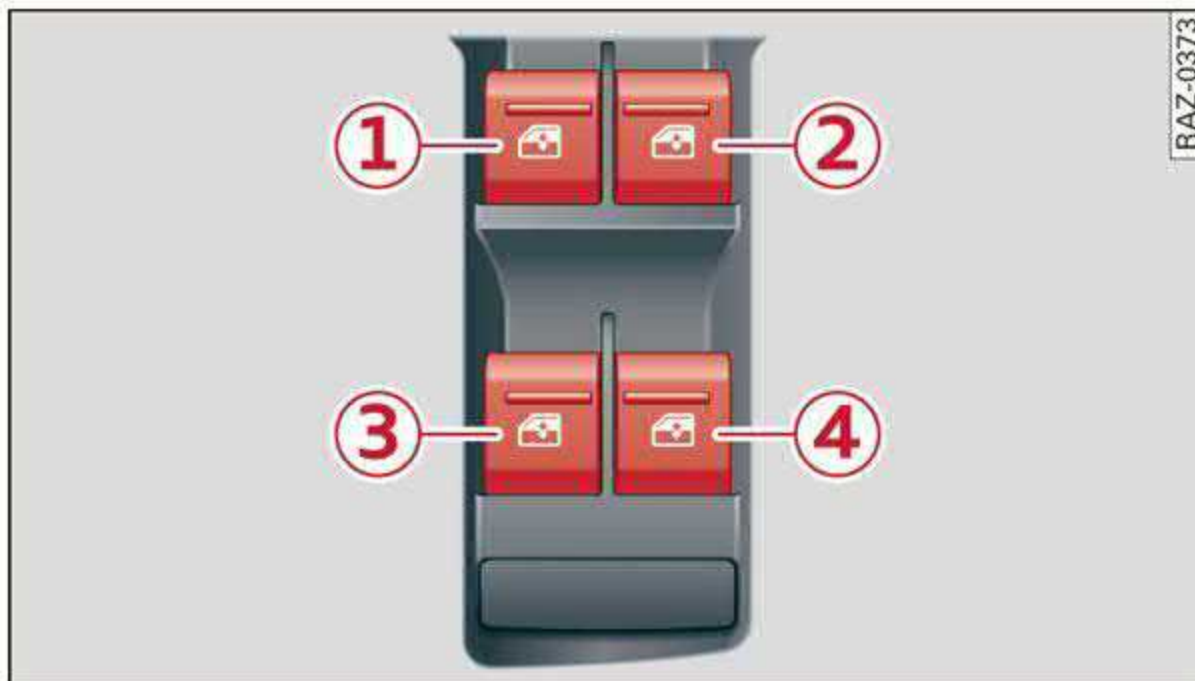

Fig. 34 Driver's door: power window switch

Power window switches:

- ① Left front door
- ② Right front door
- ③ Left rear door
- ④ Right rear door

Opening and closing the windows

The driver can control all power windows. All power window switches are equipped with a two-stage function:

- ▶ To open or close the window completely, press the switch down or pull the switch up briefly to the second level. The operation will stop if the switch is pressed or pulled again.
- ▶ To select a position in between opened and closed, press or pull the switch to the first level until the desired window position is reached.

Correcting a malfunction in the one-touch up/down function

You can reactivate the one-touch up/down function if it malfunctions.

- ▶ Pull the power window switch up until the window is completely raised.
- ▶ Release the switch and pull it up again for at least one second.

WARNING

- Observe the safety precautions ⇒ *page 28*.
- Never close the windows carelessly or in an uncontrolled manner, because this increases the risk of injury.

Tips



- You can still open and close the windows for several minutes after turning the ignition off. The power window switch is not disabled until the driver's door or front passenger's door is opened.
- The power windows are equipped with pinch protection. The automatic window may stop closing and will open all the way again even if no obstacle is detected. Pull the power window switch up until the window is completely raised.

Convenience opening and closing

Applies to: vehicles with convenience key



Convenience opening and closing the windows and roof*

You can set in the MMI if all windows or the roof* should open or close all at once ⇒ *page 29, Setting the central locking system*.

- ▶ Press and hold the  or  button on the vehicle key until all windows and the roof* have reached the desired position ⇒ .
- ▶ Touch the sensor* on the door handle until all of the windows and the roof* are closed. Do not place your hand in the door handle when doing this.

When all of the windows and the roof* are closed, the turn signals will flash once.

WARNING

- Never close the windows or the roof* carelessly or in an uncontrolled manner, because this increases the risk of injury.
- For security reasons, the windows and the roof* can only be opened and closed with the vehicle key at a maximum distance of approximately 6.5 feet (2 m) away from the vehicle. Always pay attention when using the  button to close the windows and the roof* so that no one is pinched. The closing process will stop immediately when the  button is released.

Panoramic glass roof

Operating the roof and roof sunshade

Applies to: vehicles with panoramic glass roof and roof sunshade

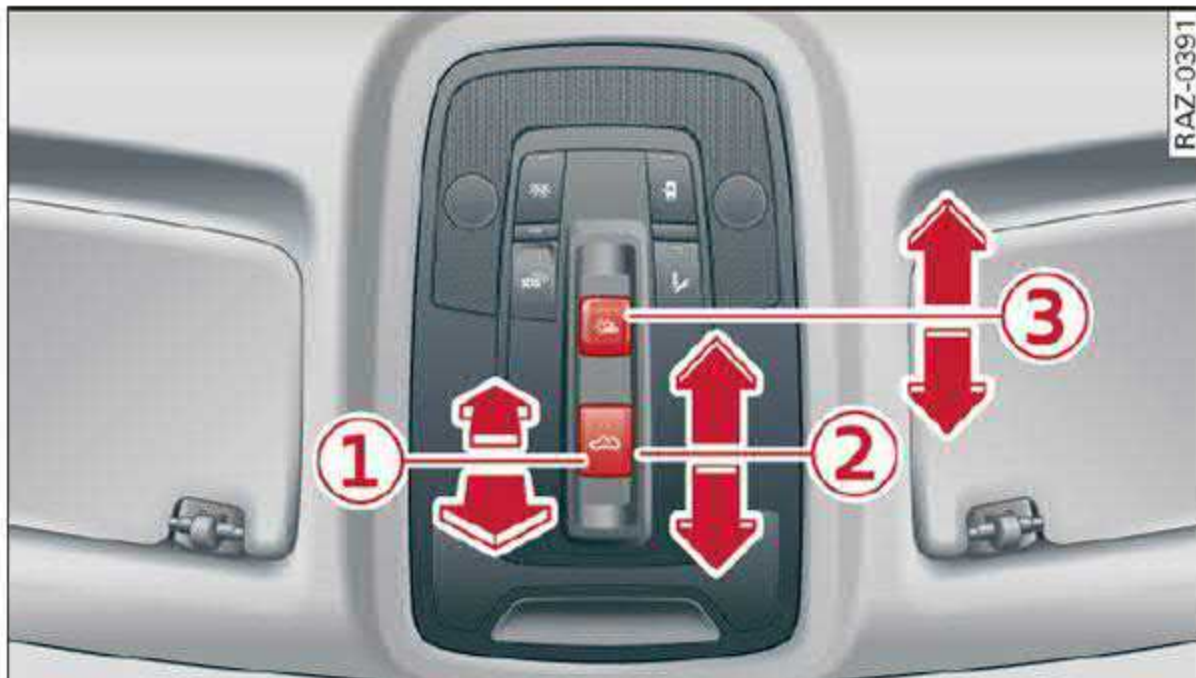

Fig. 35 Headliner: panoramic glass roof and sunshade* buttons

The control buttons are equipped with a two-stage function.

When tilting or opening the roof, the roof sunshade will automatically open partially or completely.

Operating the roof sunshade

Requirement: the roof must be closed.

- ▶ Opening and closing the sunshade: push the switch in the headliner ③ briefly toward the rear or forward to the second level.
- ▶ Partially opening the sunshade: press the switch to the first level until the sunshade reaches the desired position.

Operating the roof

- ▶ Tilting the roof: press the switch in the headliner briefly up to the second level ①.
- ▶ Closing the tilted roof: pull the switch down briefly to the second level.
- ▶ Opening the roof: slide the switch back briefly twice in a row to the second level ②.
- ▶ Closing the opened roof: push the switch forward briefly to the second level.
- ▶ Opening or closing partially: slide the switch to the first level and hold it there until the roof reaches the desired position.

Quick opening

You can also open the roof and roof sunshade in one movement.

- ▶ Push the switch back briefly to the second level ②.

Roof emergency closing

If an object is detected when closing, the roof will open again automatically. In this case, you can then close it with the power emergency closing function.

- ▶ Within five seconds after the sunroof opens automatically, pull the applicable button until the roof is closed.

WARNING

To reduce the risk of injury, always pay attention when closing the roof. Always switch the ignition off and take the key with you when leaving the vehicle.

Note

Always close the roof when you leave the vehicle and when there is precipitation to reduce the risk of damage to the interior equipment, particularly the electronic equipment.

Tips

- After switching off the ignition, the roof and sunshades can still be operated for several minutes as long as neither of the front doors have been opened.
- It is not possible to open the roof when temperatures are too low.

Garage door opener

Description

Applies to: vehicles with garage door opener

With the garage door opener, you can activate systems such as the garage doors, security systems or house lights from inside your vehicle. ▶

These functions are operated in the MMI. Multiple receivers can be programmed, which can control the functions of up to eight¹⁾ hand-held transmitters.

WARNING

- When operating or programming the garage door opener, make sure that no people or objects are in the area immediately surrounding the equipment. People can be injured or property can be damaged if struck when closing.
- Do not allow yourself to be distracted from traffic by the viewing and operating the displays.

Tips

- If you sell your vehicle, reset all settings to the factory default settings ⇒ *page 202*.
- The system complies with United States FCC regulations and ISED regulations ⇒ *page 267*.

Tips







- Before you program your system to the garage door opener, first check the compatibility:
- Ask an authorized Audi dealer or authorized Audi Service Facility or check at www.homelink.com. You can also find more information about HomeLink there.
 - You can display information about HomeLink (compatibility level/status/country code/HomeLink generation) in the MMI:
 - Select on the home screen: **VEHICLE > Settings & Service > Garage door opener > **.

Operation

Applies to: vehicles with garage door opener

Requirements: the remote control transmitter must be programmed ⇒ *page 41*, the vehicle must be within range of the system, and the ignition must be switched on.

There are multiple options to open or close the system (such as the garage door).

- ▶ To display the  button (**Garage door opener**) for the garage door opener, press the  button in the status bar ⇒ *page 20*.
- ▶ If you have only programmed one remote control transmitter, press the  button in the status bar on the display ⇒ *page 19*. Or
- ▶ If you have programmed multiple remote control transmitters, press the  button in the status bar on the display ⇒ *page 19* and then press the button for the respective system. Or
- ▶ Applies to: vehicles with programmable steering wheel button: If you have configured the programmable steering wheel button, press the  button ⇒ *page 26* and then press the respective button for the system. Or
- ▶ Applies to: vehicles with GPS pairing: If you have programmed **Location pairing**, press the respective button in the center display (notification center ⇒ *page 20*). As you approach the system, the button is displayed on the MMI. Or
- ▶ When reverse gear is selected, the parking system* / rearview camera* / peripheral camera* will appear in the display. To display the buttons of the first three garage door openers, press the  button in the status bar and then press the button for the respective system.

If transmission was successful, the message: **Send to: XXX** will appear.

Programming

Applies to: vehicles with garage door opener

You can program both fixed code and rolling code systems in the MMI using the procedure that is described.

Requirement: the ignition must be switched on.







Programming the system

Requirement: the hand transmitter must be present and the vehicle must be within range of the system (such as the garage door) that you would like to program. If you program more than ▶

¹⁾ The possible number of hand-held transmitters depends on the equipment.

Opening and closing

three remote control transmitters, assign the first three spots to the systems that you would also like to use when driving in reverse.

- ▶ To display the  button for the garage door opener, press the  button in the status bar ⇒ *page 20*.
- ▶ If you are programming the garage door opener for the **first time**, press the  button on the display. Follow the instructions in the MMI. Or
- ▶ If you would like to program **other** systems, select on the home screen: **VEHICLE > Settings & Service > Garage door opener**. Select the desired button: . Follow the instructions in the MMI.
- ▶ If you would like to **reprogram** systems that are already programmed, select on the home screen: **VEHICLE > Settings & Service > Garage door opener**. Press the  button and select  for the system to be reprogrammed. Select: **Program**. Follow the instructions in the MMI.

With some systems, the garage door opener will be immediately available after programming. With other systems, the garage door opener must also be synchronized.

Synchronizing¹⁾

Requirement: the hand transmitter must already be programmed and the vehicle must be within range of the system (such as the garage door).

If the system synchronization is performed directly after the programming procedure, follow the instructions on the MMI.

If you would like to sync at a later time:

- ▶ Select on the home screen: **VEHICLE > Settings & Service > Garage door opener**.
- ▶ Press the button for the system that you would like to synchronize.
- ▶ Follow the instructions in the MMI.

Location pairing

Applies to: vehicles with location pairing

For easier operation, you can program your system's location.

- ▶ Select on the home screen: **VEHICLE > Settings & Service > Garage door opener**.
- ▶ Press the  button.
- ▶ Press the  button for the system your vehicle is facing.
- ▶ Select: **Location pairing**.
- ▶ Follow the instructions in the MMI.

Only a maximum of three systems can be displayed in the notification center ⇒ *page 20*. If you would like to have all systems displayed, press .

Renaming programmed systems

You can rename the programmed systems individually.

- ▶ Select on the home screen: **VEHICLE > Settings & Service > Garage door opener**.
- ▶ Press the  button.
- ▶ Press the  button for the system that you would like to rename.
- ▶ Select: **Rename**.
- ▶ Follow the instructions in the MMI.

Deleting programmed systems

The programmed systems can be deleted individually or all at once.

- ▶ Select on the home screen: **VEHICLE > Settings & Service > Garage door opener**.
- ▶ Press the  button.
- ▶ To delete an **individual** system, press the  button for the desired system. If the checkmark  is set, select: **Delete**.
- ▶ To delete **all** systems, select: **All > Delete**.

Tips

- Make sure the batteries in the hand transmitter are charged before starting the programming process.
- The programming process may take up to 30 seconds. It may be necessary for the hand transmitter to be pressed again in the meantime.
- The garage door opener may need to be synchronized with the system after

¹⁾ Only applies to rolling code systems

programming. Follow the manufacturer's instructions for doing this.

Tips

In some cases, the system may need to be programmed in a different mode (“D mode”).

- Switch the ignition on.
- Select on the home screen: **VEHICLE > Settings & Service > Garage door opener.**
- Press and hold the desired button .
- Select **Yes, in D mode** and follow the instructions on the MMI.

Lights and Vision

Exterior lighting



Switching the lights on and off





Fig. 36 Instrument panel: light button module

① Light switch

Press and hold ① until the desired light function is selected. The selected function is displayed briefly in the instrument cluster. When switching on the ignition, the AUTO light function is automatically selected.

- AUTO - The automatic headlights adapt to the surrounding brightness automatically. The daytime running lights* will automatically turn on. In vehicles for certain markets, you can switch the automatic daytime running lights* on and off in the MMI.
-  – You can switch the low beam headlights on manually once the ignition is switched on.
-  – You can switch the parking lights on at speeds below 20 mph (32 km/h).
- USA models: OFF – You can switch off all light functions at speeds under 6 mph (10 km/h).
- Canada models: OFF – You can only switch off all light functions when the ignition is switched off while the vehicle is stationary.

When the low beam headlights or parking lights are switched on, the respective  or  indicator light appears in the instrument cluster.

② All-weather lights

Applies to: vehicle with all-weather lights: The headlights automatically adjust so that there will be less glare, for example when the road surface is wet.

Automatic headlight range control

Your vehicle is equipped with automatic headlight range control. It reduces glare for oncoming traffic if the vehicle load changes. The headlight range adjusts automatically.

Audi adaptive light

Applies to: vehicles with adaptive light

Audi adaptive light provides better visibility when driving in the dark. The lights are adapted to the road conditions based on speed, such as when driving on expressways, rural roads, at intersections, and around curves. The adaptive light only functions when the automatic headlights are activated.

WARNING

- Observe the safety precautions and note the limits of the assist systems, sensors, and cameras ⇒ page 106.
- Automatic headlights are only intended to assist the driver. The driver is still responsible for controlling the headlights and may need to switch them on and off manually depending on light and visibility conditions. For example, fog cannot be detected by the light sensors. So always switch on the low beams  under these weather conditions and when driving in the dark.

Tips

- If the vehicle battery has been discharging for a while, the parking light may switch off automatically. Avoid using the parking lights for several hours.
- Follow the regulations applicable to the country where you are operating the vehicle when stopping the vehicle and when using the lighting systems.
- Only the front headlights turn on when the daytime running lights are switched on*. In vehicles in certain markets, the tail lights will also turn on.
- In cool or damp weather, the inside of the headlights, turn signals, and tail lights can fog over due to the temperature difference between the inside and outside. They will clear shortly after switching them on. This

does not affect the service life of the lighting.

- When the parking lights are switched on and the ignition is switched off, the  symbol appears in the light switch module.

Turn signal and high beam lever

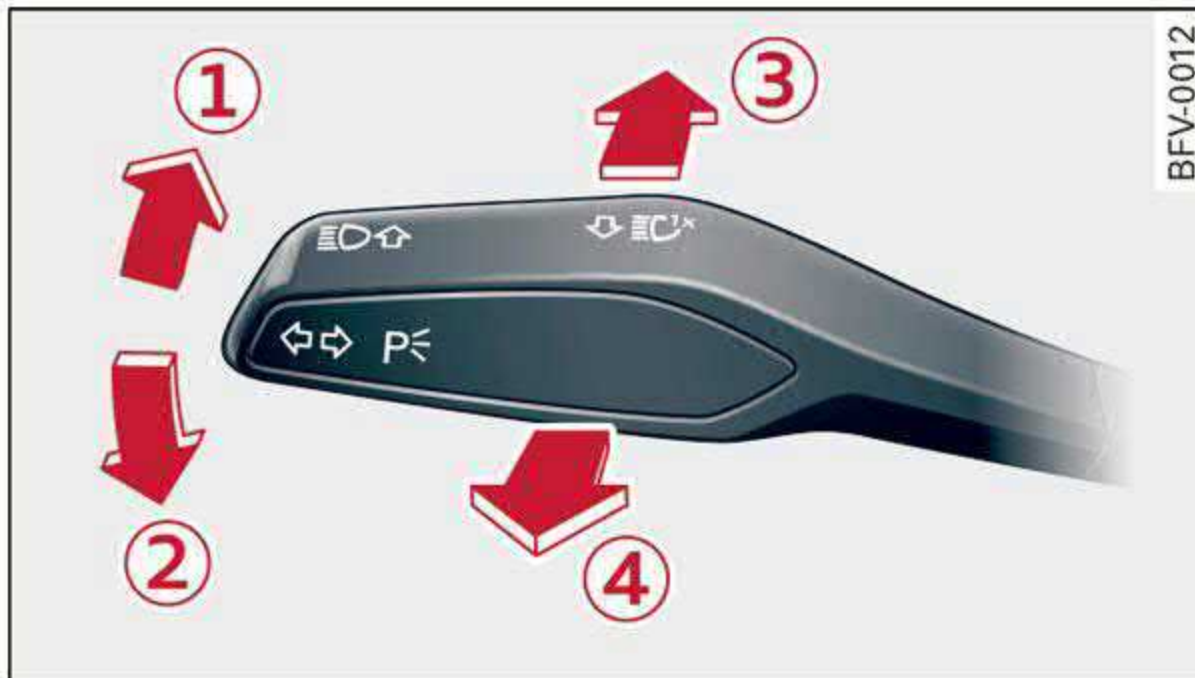



Fig. 37 Lever: switching on the turn signal and high beams

The lever operates the turn signals, the high beams and the headlight flasher.

Turn signals

The turn signal will activate when you move the lever into a turn signal position while the ignition is switched on. The respective  or  indicator light will flash.

- ① Right turn signal
- ② Left turn signal

The turn signal blinks three times if you tap the lever (convenience turn signal).

If an indicator light blinks twice as fast as usual, a turn signal bulb has failed. Carefully drive to an authorized Audi dealer or authorized Audi Service Facility immediately to have the malfunction corrected.

High beams and headlight flasher

- ▶ Move the lever to the corresponding position:
 - ③ High beams on (vehicles with high beam assistant*) ⇒ page 45
 - ④ High beams off or headlight flasher

The  indicator light in the instrument cluster turns on.

WARNING

High beams can cause glare for other drivers, which increases the risk of an accident. For this reason, only use the high beams or the headlight flasher when they will not create glare for other drivers.

High beam assistant



Applies to: vehicles with high beam assistant

The high beam assistant automatically turns the high beams on or off depending on the surrounding conditions.

A camera on the rearview mirror mount can detect light sources from other road users. The high beams switch on or off automatically depending on the position of vehicles driving ahead and oncoming vehicles, the vehicle speed as well as other environmental factors and traffic conditions.

Activating high beam assistant

Requirement: the AUTO light function must be selected and the high beam assistant must be switched on in the MMI ⇒ page 46.

- ▶ To activate the high beam assistant, tap the lever forward ③ ⇒ page 45, fig. 37. The  indicator light will appear in the instrument cluster display and the high beams will be switched on or off. The  indicator light will turn on if the high beams are switched on.

Activating and deactivating the high beam head lights manually

If the high beams did not switch on or off as expected, you may switch them on or off manually instead:

- ▶ To activate the high beams manually, tap the lever forward ③ ⇒ page 45, fig. 37. The  indicator light turns on.
- ▶ To deactivate the high beams manually, pull the lever back ④ ⇒ page 45, fig. 37. The high beam assistant is deactivated.

Operating the headlight flasher

- ▶ To operate the headlight flashers, pull the lever back ④ ⇒ page 45, fig. 37. If the high beam

headlights are not switched on, the high beam assistant will remain activated.

WARNING

- Observe the safety precautions and note the limits of the assist systems, sensors, and cameras ⇒ *page 106*.
- High beam assistant is only intended to assist the driver. The driver is responsible for controlling the high beam headlights and adjusting them to match the lighting and visibility conditions.
- High beams can cause glare for other drivers, which increases the risk of an accident. For this reason, only use the high beams or the headlight flasher when they will not create glare for other drivers.

Tips

Adhere to any local applicable regulations when using the lighting equipment, for example in regard to reducing glare for other drivers. The driver is always responsible for adhering to the regulations applicable in the country where the vehicle is being operated.

Adjusting the exterior lighting

You can adjust the exterior lighting separately. The settings depend on the vehicle equipment.

- ▶ Applies to: MMI: Select on the home screen: **VEHICLE > Light & Visibility > Exterior lighting**.

Automatic headlights

You can adjust the following settings in the **Automatic headlights** menu:

Activation time - You can adjust if the headlights switch on **Early**, **Medium**, or **Late** based on the sensitivity of the light sensor.

High beam assistant - You can switch the high beam assistant on and off.

Entry/exit lighting

The **Entry/exit lighting** illuminates the area around the vehicle when the vehicle is unlocked or when the driver's door is opened while the ig-

nition is off. The entry/exit lighting works when it is dark and when the **AUTO** light function is switched on. The front and rear daytime running lights* switch on automatically each time the vehicle is unlocked regardless of how bright it is outside the vehicle.

Daytime running lights

USA models: The daytime running lights can be switched on and off.

Canada models: This function cannot be switched off. They activate automatically each time the ignition is switched on.

Emergency flashers

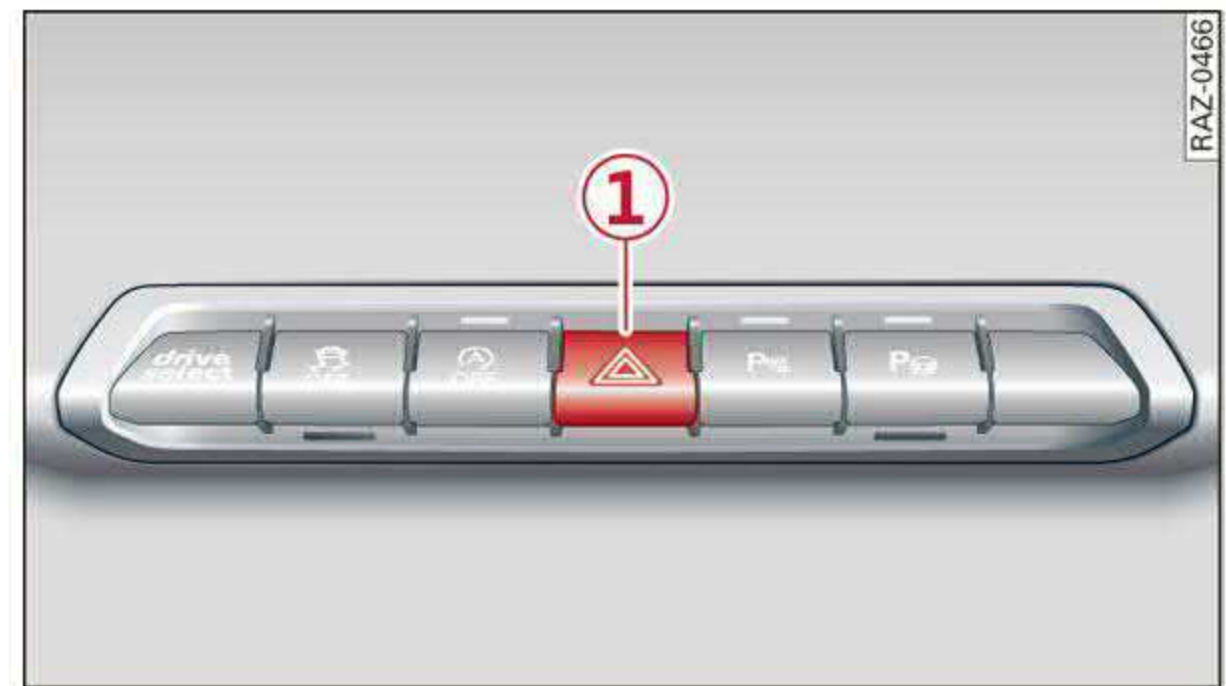



Fig. 38 Center console: emergency flashers

The emergency flashers help to make other drivers aware of your vehicle in dangerous situations.

- ▶ Press the  button to switch the emergency flashers on or off.

When the emergency flashers are turned on, the  and  indicator lights will flash at the same time.

You can indicate a lane change or a turn when the emergency flashers are switched on by using the turn signal lever. The emergency flashers stop temporarily.

The emergency flashers also work when the ignition is turned off.

Tips

You should switch the emergency flashers on if:

- you are the last car in a traffic jam so that all other vehicles approaching from behind can see your vehicle
- your vehicle has broken down or you are having an emergency
- your vehicle is being towed or if you are towing another vehicle

Messages

If the  indicator light turns on, a bulb has failed. The displayed message indicates the cause and possible solutions. If one of the messages remains on, drive immediately to an authorized Audi dealer or authorized Audi Service Facility to have the malfunction repaired.

 **Audi adaptive light: malfunction! See owner's manual**

Adaptive light* is not working. The headlights still function. Drive immediately to an authorized Audi dealer or authorized Audi Service Facility to have the malfunction repaired.

 **High beam assistant: malfunction! See owner's manual**

You can still switch the high beams on or off manually. Drive immediately to an authorized Audi dealer or authorized Audi Service Facility to have the malfunction repaired.

 **High beam assistant: currently unavailable. Camera view limited due to surroundings. See owner's manual**

This message appears if the camera's visual field is blocked. The system will switch itself off. Try switching the systems on later.

 **Automatic headlights: malfunction! See owner's manual**

The light/rain sensor is malfunctioning. The low beams remain switched on at all times for safety reasons with the AUTO light function. Drive immediately to an authorized Audi dealer or authorized Audi Service Facility to have the malfunction repaired.

Interior lighting

Front interior lighting



Fig. 39 Headliner: interior lighting

Interior lighting buttons

 – Interior lighting on/off

 – Door contact switch on/off. The interior lighting is controlled automatically.

Touch-sensitive reading lights*



- ▶ To turn a reading light on or off, touch the surface **1** briefly.
- ▶ To activate the manual dimming function, touch the surface **1** when the light is switched off and keep touching it until the desired brightness is reached.

Rear interior lighting



Fig. 40 Headliner: reading lights

Reading lights

- ▶ To switch the reading lamp on or off, press the  button **1**.
- ▶ To activate the manual dimming function*, touch the surface while the light is switched off  **1** and keep touching it until the desired brightness is reached.

Interior lighting

Applies to: vehicles with interior lighting

The ambient lighting turns on when the ignition is switched on. The ambient lighting is deactivated when the light function is OFF.

You can adjust the interior lighting individually. The settings depend on the vehicle equipment.

► Applies to MMI: Select on the home screen: **VEHICLE > Light & Visibility > Interior lighting.**

Possible settings:

- Color
- Brightness

Display brightness

You can adjust the instrument and display illumination separately. The settings depend on the vehicle equipment.

► Applies to MMI: select on the home screen: **SETTINGS > Display & brightness.**

Possible settings:

- Cockpit dimming
- MMI
- Virtual cockpit

Vision

Adjusting exterior mirrors



Fig. 41 Driver's door: knob for the exterior mirrors

► Turn the knob in the driver's door to the desired position:

0 – Deactivates all adjustment functions.

◀ / ▶ – Selects the left or right exterior mirror. To adjust the mirror glass in a mirror, press the knob in the desired direction.

☀ – Heats* the mirror glass depending on the outside temperature.

🔒 – Folds the exterior mirrors*. To fold the mirrors out, turn the knob to one of the other positions. In the MMI, you can select if the mirrors fold in automatically when you lock the vehicle ⇒ page 29.

Front passenger's exterior mirror tilt function*

Requirement: the knob must be in the position for the front passenger's exterior mirror.

The mirror surfaces tilt slightly when reverse gear is selected to provide a better view, for example of the edge of the curb.

You can adjust the mirror surface by turning the knob in the desired direction.

The mirror moves from the reversing position back to the original position:

- When you switch the ignition off
- When you drive forward at speeds faster than 9 mph (15 km/h).
- When the knob is no longer in the position for the front passenger exterior mirror

⚠ WARNING

Curved mirror surfaces (for example convex) enlarge the field of vision. However, they make objects in the mirror appear smaller and farther away. When using these mirrors to estimate your distance to vehicles behind you when changing lanes, you could estimate incorrectly, which increases the risk of an accident.

⚠ Note

– Applies to: vehicles with power folding exterior mirrors: If the mirror housing was moved by outside forces (such as an impact when maneuvering), you must use the power folding function to fold the mirror all the way out. The mirrors will make a loud noise ▶

when they latch into place. The mirror housing must not be moved back into place by hand because this could impair the function of the mirror mechanism.

- Applies to: vehicles without power folding exterior mirrors: If the mirror housing was moved by outside forces (such as an impact when maneuvering), you must move it back in place by hand.
- If you wash the vehicle in an automatic car wash, you must fold the exterior mirrors in to reduce the risk of damage to the mirrors. Never fold power folding exterior mirrors* by hand. Only fold them in and out using the power controls.

i Tips

If the power adjusting function malfunctions, the glass in both mirrors can be adjusted by pressing on the edge of it by hand.

Dimming the mirrors

Manual dimming rearview mirror

- ▶ Pull the lever on the bottom of the mirror back.

Automatic dimming rearview mirror*

- ▶ The interior and exterior mirrors* dim automatically when light shines on them, for example from headlights on a vehicle behind you.

! WARNING

If the glass on an automatic dimming mirror* breaks, electrolyte can leak out. This liquid can irritate the skin, eyes and respiratory system. If there is contact with the fluid, flush immediately with plenty of water. Consult a physician if necessary.

- Repeated or long-term exposure to electrolyte fluid can lead to irritation of the airways, especially in people with asthma or other respiratory conditions. Take deep breaths immediately after leaving the vehicle or, if this is not possible, open all of the doors and windows as wide as possible.
- If electrolyte fluid comes into contact with the eyes, flush them thoroughly with plenty

- of clean water for at least 15 minutes and then seek medical attention.
- If electrolyte fluid comes into contact with the skin, flush the affected area with clean water for at least 15 minutes, and then clean with soap and water and seek medical attention. Clean affected clothing and shoes thoroughly before wearing again.
- If the fluid was swallowed and the person is conscious, flush the mouth with water for at least 15 minutes. Do not induce vomiting unless this is recommended by medical professionals. Seek medical attention immediately.

! Note

If the glass on an automatic dimming mirror* breaks, electrolyte can leak out. This liquid damages plastic surfaces and paint. Clean this liquid as quickly as possible, for example with a wet sponge.

i Tips

- If the light reaching the rearview mirror is obstructed, the automatic dimming mirror* will not function correctly.
- The automatic dimming mirrors* do not dim when the interior lighting is turned on or reverse gear is selected.

Sun visors



Fig. 42 Front headliner: sun visor

Sun visor

The sun visors can be moved out of their brackets and turned toward the doors ①.

They can also be moved back and forth lengthwise in this position.

Vanity mirror

The mirror light switches on when the cover over the vanity mirror ② opens.

Windshield wipers

Switching the windshield wipers on



Fig. 43 Lever: windshield wipers



Fig. 44 Lever: rear window wiper

► Move the windshield wiper lever  to the corresponding position:

- ① Windshield wipers off
- ① Rain sensor/intermittent mode. The windshield wipers switch on once the vehicle speed exceeds approximately 2 mph (4 km/h) and it is raining. The higher the sensitivity of the rain sensor that is set (switch ⑥ to the right), the earlier the windshield wipers react to moisture on the windshield. You can deactivate the rain sensor mode, which switches the interval mode on. In intermittent mode, you can adjust the interval time using the switch ⑥.

► Applies to: MMI: Select on the home screen: **VEHICLE > Light & Visibility > Rain sensor.**

- ② Slow wiping
- ③ Fast wiping
- ④ Single wipe. If you hold the lever in this position longer, the wipers switch from slow wiping to fast wiping.
- ⑤ Clean the windshield . The number of wipes and afterwipes depends on how long the lever is held in position ⑤.

The wipers wipe one time after several seconds of driving to remove water droplets. You can switch this function off by moving the lever to position ⑤ within ten seconds of the afterwipe. The afterwipe function is reactivated the next time you switch the ignition on.

If you hold the lever in position ⑤ for longer than half a second, the edge wiping feature will be activated. This moves the windshield wipers closer to the edge of the windshield and performs an afterwipe to clean the residue that results from the wiping process from the edge of the windshield. The function is available when driving at speeds up to 75 mph (120 km/h).

The headlight washer system* operates only when the low beam headlights are on. If you move the lever into position ⑤, the headlights will be cleaned at fixed intervals.

- ⑦ Wipe the rear window . The number of wipes depends on the windshield wiper movement.

The rear wiper automatically switches on when the reverse gear is selected and the front windshield wipers are on and running.

- ⑧ Clean the rear window . The number of wipes depends on how long the lever is held in position ⑧.

WARNING

- The rain sensor is only intended to assist the driver. The driver may still be responsible for manually switching the wipers on based on visibility conditions.
- The windshield must not be treated with water-repelling windshield coating agents. Under unfavorable conditions, such as

wetness, darkness, and when the sun is low, these coatings can cause increased glare, which increases the risk of an accident. They can also cause wiper blade chatter.

- Properly functioning windshield wiper blades are required for a clear view and safe driving ⇒ *page 51, Cleaning/changing wiper blades.*

! Note

- If there is frost, make sure the windshield wiper blades are not frozen to the windshield. Switching on the windshield wipers when the blades are frozen to the windshield can damage the wiper blades.
- Prior to using a car wash, the windshield wiper system must be switched off (lever in position 0). This prevents the wipers from switching on unintentionally and causing damage to the windshield wiper system.

i Tips

- The windshield wipers switch off when the ignition is switched off. You can activate the windshield wipers after the ignition is switched on again by moving the windshield wiper lever to any position.
- Worn or dirty windshield wiper blades result in streaking. This can affect the rain sensor function. Check your windshield wiper blades regularly.
- The washer fluid nozzles for the windshield washer system are heated when the ignition is on if the outside temperature is low.
- When stopping temporarily, such as at a traffic light, the speed of the windshield wipers automatically reduces by one level.

Cleaning/changing wiper blades

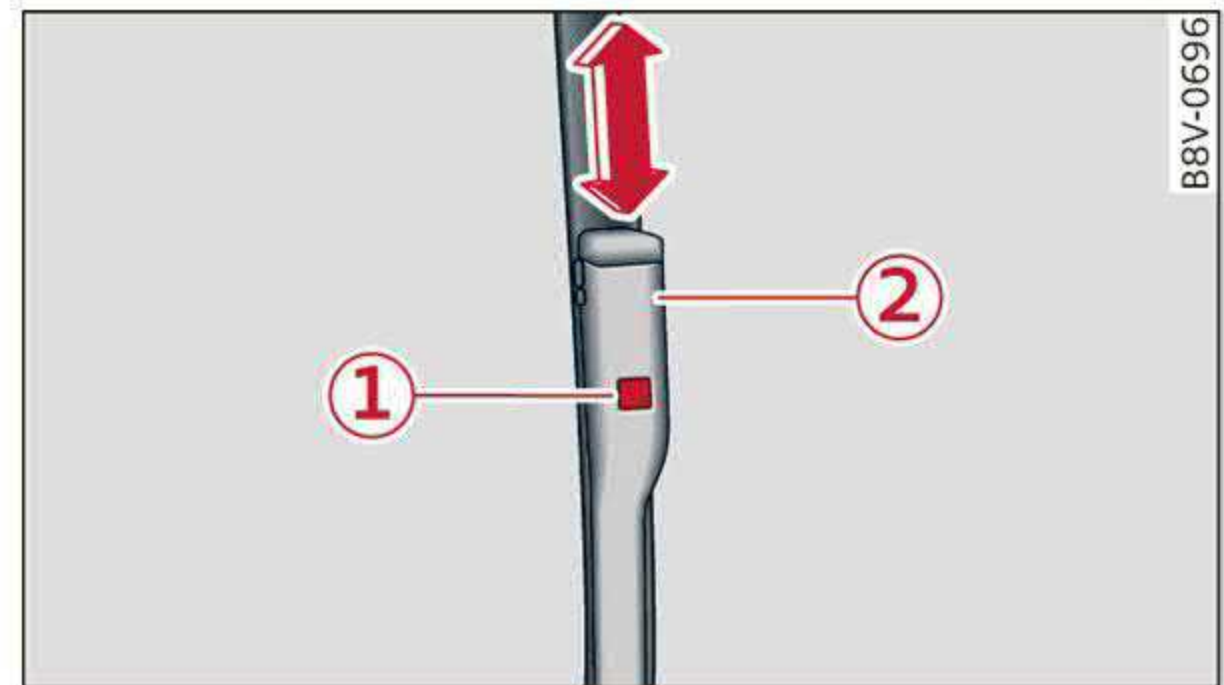

Fig. 45 Windshield wipers: changing the wiper blades

Windshield wiper service position/blade replacement position

- ▶ Switch off the ignition and hold the windshield wiper lever in position 4 ⇒ *page 50, fig. 43* until the windshield wiper moves into the service position.
- ▶ To bring the windshield wipers into the normal position, switch the ignition on and hold the windshield wiper lever in position 4 until the windshield wipers go back to the original position, or drive faster than 8 mph (12 km/h).

Applies to: MMI: You can also turn the service position on or off in the center display:

- ▶ Switch the windshield wipers off (position 0) ⇒ *page 50, fig. 43*.
- ▶ Select on the home screen: **VEHICLE > Settings & Service > Wiper position.**

Cleaning the wiper blades

Requirement: the windshield wipers must be in the service position.

- ▶ Fold the windshield wiper arm away from the windshield.
- ▶ For information on cleaning, see ⇒ *table on page 243.*

Replacing the wiper blades

Requirement: the windshield wipers must be in the service position.

- ▶ Fold the windshield wiper arm away from the windshield.
- ▶ Press the locking knob 1 on the wiper blade. Hold the wiper blade firmly.

- ▶ Remove the wiper blade from the windshield wiper arm mount ②.
- ▶ Insert the new wiper blade into the mount on the wiper arm until it clicks into place.
- ▶ Place the wiper arm back on the windshield.
- ▶ Exit the service position.

WARNING

- For safety reasons, the windshield wiper blades should be replaced once or twice each year.
- Dirty windshield wiper blades can impair vision, which increases the risk of an accident.

Note

- The windshield wipers must only be folded up when in the service position! Otherwise, you risk damaging the paint on the hood or the windshield wiper motor.
- You should not move your vehicle or press the windshield wiper lever when the wiper arms are folded up from the windshield. The windshield wipers would move back into their original position and could damage the hood and windshield.

Tips

- You can also use the service position, for example, if you want to protect the windshield from icing by using a cover.
- You cannot activate the service position when the hood is open.

Cleaning/changing the rear wiper blade



Fig. 46 Rear window wiper: installing the wiper blade

Cleaning the wiper blades

- ▶ Fold the wiper arm away from the rear window.
- ▶ For information on cleaning, see ⇨ *table on page 243*.

Removing the wiper blade

- ▶ Fold the wiper arm away from the rear window.
- ▶ Remove the wiper blade from its holder.

Installing the wiper blade

- ▶ Press the wiper blade mount into the retainer.
- ▶ Fold the window wiper arm back onto the rear window.

WARNING

- For safety reasons, the windshield wiper blades should be replaced once or twice each year.

Messages

If the  indicator light turns on, then there is a windshield wiper malfunction. The message that is also displayed indicates the cause and possible solutions. If one of the messages does not turn off, drive immediately to an authorized Audi dealer or authorized Audi Service Facility to have the malfunction repaired.

Automatic wipers: malfunction! See owner's manual

The light/rain sensor is malfunctioning. You can still control all functions that are not controlled by the rain sensor using the windshield wiper lever. Drive immediately to an authorized Audi dealer or authorized Audi Service Facility to have the malfunction repaired.

Digital compass

Switching the compass on and off

Applies to: vehicles with digital compass

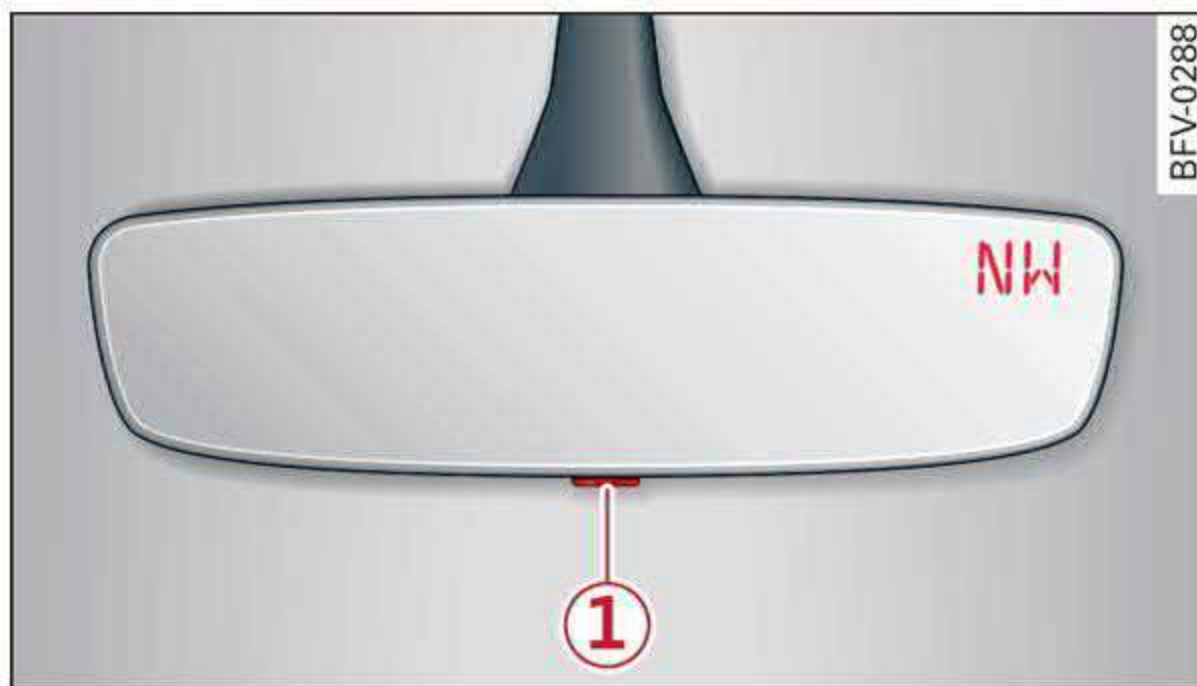

Fig. 47 Rearview mirror: digital compass is switched on

- ▶ To turn the compass on or off, press the button **1** until the compass display in the mirror turns on or off.

The digital compass only works when the ignition is turned on. The directions are indicated with abbreviations: **N** (north), **NE** (northeast), **E** (east), **SE** (southeast), **S** (south), **SW** (southwest), **W** (west), **NW** (northwest).

i Tips

To prevent inaccurate compass readings, do not bring any remote controls, electrical devices or metallic objects near the mirror.

Adjusting the magnetic zone

Applies to: vehicles with digital compass

The magnetic zone must be adjusted correctly for the compass to read accurately.

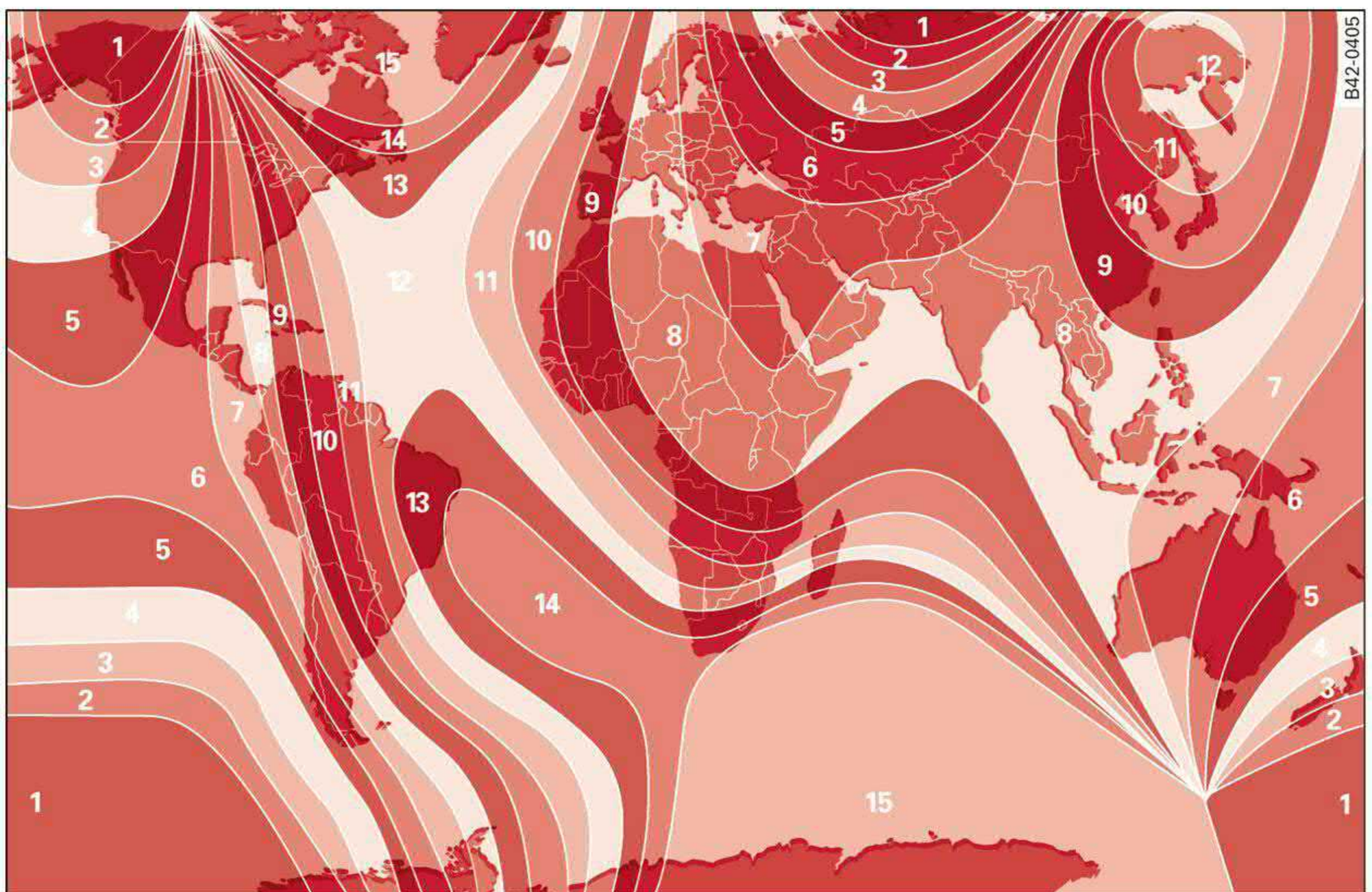

Fig. 48 Magnetic zone map

- ▶ Press and hold the button **1** ⇒ page 53, fig. 47 until the number of the magnetic zone appears in the interior rearview mirror.
- ▶ Press the button **1** repeatedly to select the correct magnetic zone. The selection mode turns off after a few seconds.

Calibrating the compass

Applies to: vehicles with digital compass

You must recalibrate the compass if it does not display the correct direction.

- ▶ Press and hold the button **1** until a **C**
⇒ *page 53, fig. 47* appears in the rearview mirror.
- ▶ Drive in a circle at about 6 mph (10 km/h) until a direction is displayed in the rearview mirror.

WARNING

To reduce the risk to yourself and other drivers, calibrate the compass in an area where there is no traffic.

Sitting correctly and safely

Correct passenger seating position

General information

As the driver, you are responsible for making sure every passenger is sitting correctly in their seat and maintaining this seating position while driving. Make sure that:

- Every passenger in the vehicle has adjusted his or her seat correctly ⇒ *page 55*
- The steering wheel is adjusted correctly ⇒ *page 58*
- The mirrors are adjusted so that there is a sufficient view of the area around the vehicle ⇒ *page 48*
- Every passenger in the vehicle has his or her head restraint adjusted correctly ⇒ *page 59*
- Every passenger in the vehicle has his or her safety belt fastened correctly ⇒ *page 60*
- The activation status of the front passenger's airbag is suitable for the passenger in the front passenger's seat ⇒ *page 66*
- Children are secured in suitable child safety seats that are secured to appropriate vehicle seats ⇒ *page 68*. Read and observe the important safety information pertaining to the use of child safety seats on the front passenger's seat ⇒  *in General information on page 68*.

Examples of incorrect seating positions

Safety belts can only provide its optimal protection when they are routed correctly. Incorrect seating positions significantly reduce the protective functions of the safety belts and increase the risk of injury due to incorrect belt routing.

The following list includes examples of seating positions that could be dangerous for all vehicle occupants. This is not a complete list. The purpose is to provide examples to increase your awareness of the topic. The following points apply when the vehicle is in motion:

- Never stand inside the vehicle.
- Never stand on the seats.

- Never kneel on the seats.
- Never tilt your backrest too far back.
- Never lean against the instrument panel.
- Never lie down on the rear bench seat.
- Never sit only on the front section of the seat.
- Never sit sideways on the seat.
- Never lean against the window.
- Never place your feet out of the window.
- Never place your feet on the instrument panel.
- Never place your feet on the seat cushion.
- Never ride in the footwell.
- Never sit on the armrests.
- Never drive or ride in a seat without fastening your safety belt.
- Never ride in the luggage compartment.

WARNING

Incorrect seating positions, failure to wear a safety belt, or being too close to an airbag increase the risk of serious or fatal injury to vehicle occupants, especially if the airbags deploy and come into contact with occupants who are not seated correctly. Note the important information and warnings in the chapters for the topics given above.

Tips

If you or other vehicle passengers have physical limitations that prevent sitting in a correct position, modifications to the vehicle may be necessary. For more information, contact an authorized Audi dealer or authorized Audi Service Facility, or call Audi customer support at 1-800-822-2834.

Front seats

General information

Make sure that:

- You can press the pedals down completely while your legs are slightly bent
- The distance between your upper body and the steering wheel or instrument panel is at least 10 inches (25 cm)
- The distance between your knees and the instrument panel is at least 4 inches (10 cm) ►

Sitting correctly and safely

- Your thighs are lightly supported by the front surface of the seat
- The backrest is in an upright position and your back is resting against it
- You have a sufficient view of the area around the vehicle
- You have a clear view of the instrument cluster and indicator lights

WARNING

- If you are too close to the steering wheel or instrument panel, the airbag system cannot provide the optimal protection, which increases the risk of injury and death.
- To reduce the risk of injury in the event of sudden braking maneuvers or accidents, never drive with the backrest reclined very far. The airbag system and seat belts can only provide optimal protection when the backrest is in an upright position and the driver is wearing the seat belt correctly. If the backrest is angled back too far, the safety belt can shift to soft areas of the body, such as the stomach, which increases the risk of injury.
- To reduce the risk of an accident, only adjust the seats when the vehicle is stationary.
- Be careful when adjusting the seat. Lack of control or attention when adjusting can result in injuries due to pinching to vehicle occupants both in the front seats and rear seats.
- Never place objects in the driver's footwell. Objects could shift and enter the area around the pedals, which could prevent you from using them. You would then be unable to use the pedals if sudden driving or braking maneuvers were needed, which increases the risk of an accident.
- Make sure that the floor mats are always securely attached.
- To reduce the risk of an accident, never place additional floor mats or other floor covers over the installed floor mats, because this reduces the pedal's range of motion and can impair pedal operation.
- To reduce the risk of injury, never place your feet on the instrument panel, out of the

window, or on the seat surfaces. This also applies to passengers in the rear seats.

Note

Applies to: vehicles with manually adjustable head restraints

To reduce the risk of damage, be very careful when adjusting the seat to make sure the head restraints do not come into contact with the headliner or the sunroof*.

Adjusting the front seats manually

Applies to: vehicles with manual adjustable seats

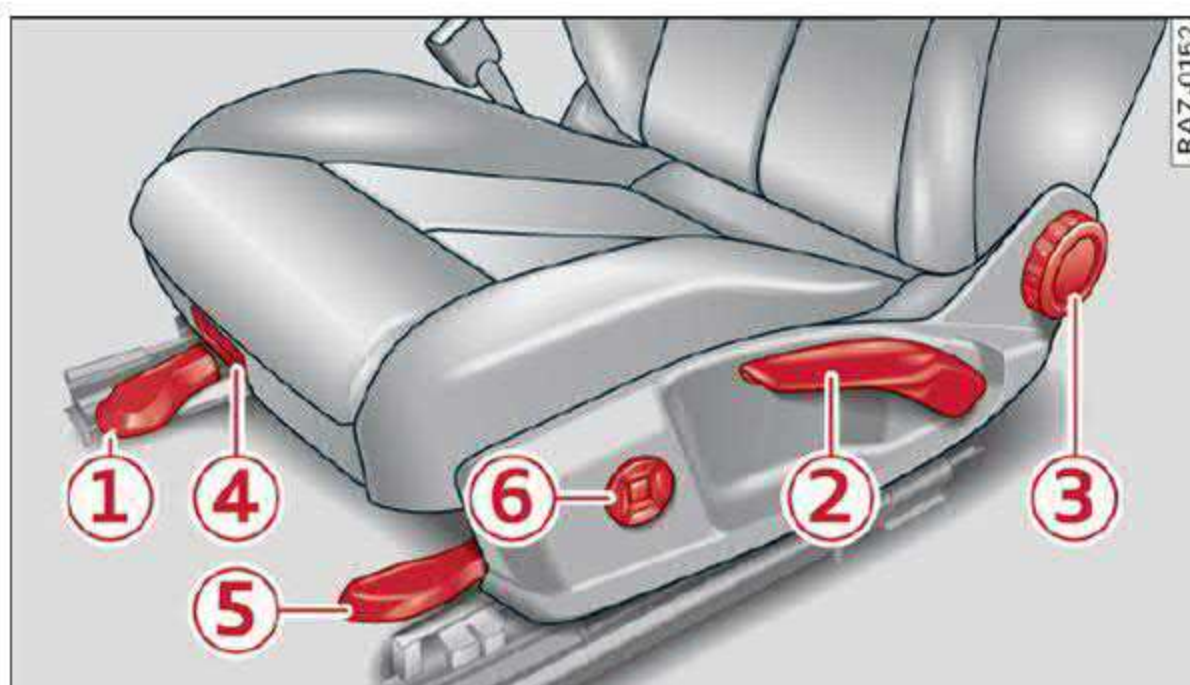

Fig. 49 Front seat: adjusting the seat

The settings depend on the vehicle equipment.

Adjusting the seat position

- ▶ To adjust the seat forward or back, pull the lever ① and slide the seat.
- ▶ To adjust the seat up or down, pull or press the lever ②.

Adjusting the backrests

- ▶ To adjust the backrest forward or back, turn the adjusting wheel ③.

Adjusting the upper thigh support

- ▶ To increase or decrease the upper thigh support, lift the handle ④ and move the upper thigh support.

Adjusting the angle of the seat surface

- ▶ To adjust the angle of the seat surface, pull or press the lever ⑤.

Adjusting the lumbar support

- ▶ To adjust the lumbar support, press the button ⑥ in the desired direction.

Adjusting the power front seats

Applies to: vehicles with power adjustable seats

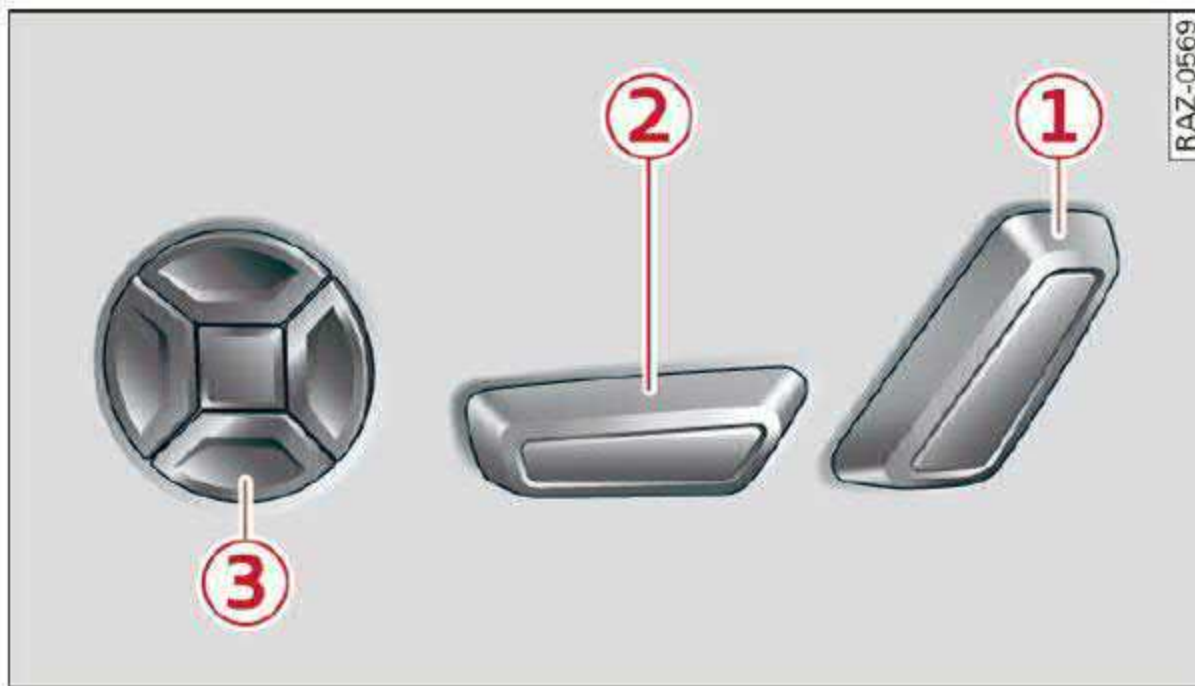

Fig. 50 Front seat: seat adjustment buttons

The settings depend on the vehicle equipment.

Adjusting the backrests

- ▶ To move the backrest forward or backward, press the button ① forward or backward.

Adjusting the seat position

- ▶ To move the seat forward or backward, push the button ② forward or backward.
- ▶ To adjust the seat upward or downward, push the rear section of the button ② upward or downward.
- ▶ To adjust the seat surface, press the front part of the button ② upward or downward.

Adjusting the lumbar support

- ▶ To adjust the lumbar support, press the button ③ in the desired direction.

Adjusting the upper thigh support

- ▶ To increase or decrease the upper thigh support, lift the handle ④ ⇒ page 56, fig. 49 and move the upper thigh support.

WARNING

The power front seats can also be adjusted when the ignition is switched off. To reduce the risk of injury, children should never be left unattended in the vehicle for this reason.

Front center armrest

Applies to: vehicles with a front center armrest

The front center armrest is located between the front seats.

Adjusting the center armrest

The settings depend on the vehicle equipment.

- ▶ To adjust the armrest forward or backward, move the armrest in the desired direction.
- ▶ To adjust the angle, raise the armrest in stages.
- ▶ To move the armrest back into the original position, raise it slightly out of the top level and fold it downward.

WARNING

In certain positions, the front center armrest can interfere with the driver's arm movement, which increases the risk of injury.

Rear seats

General information

WARNING

- To reduce the risk of an accident, only adjust the seat when the vehicle is stationary.
- Be careful when adjusting the seat. Unsupervised or careless seat adjustment could cause parts of the body to get pinched, which increases the risk of injury.
- Always pull forward on the backrest to make sure it is checked if it is correctly locked in place.

Adjusting the seats

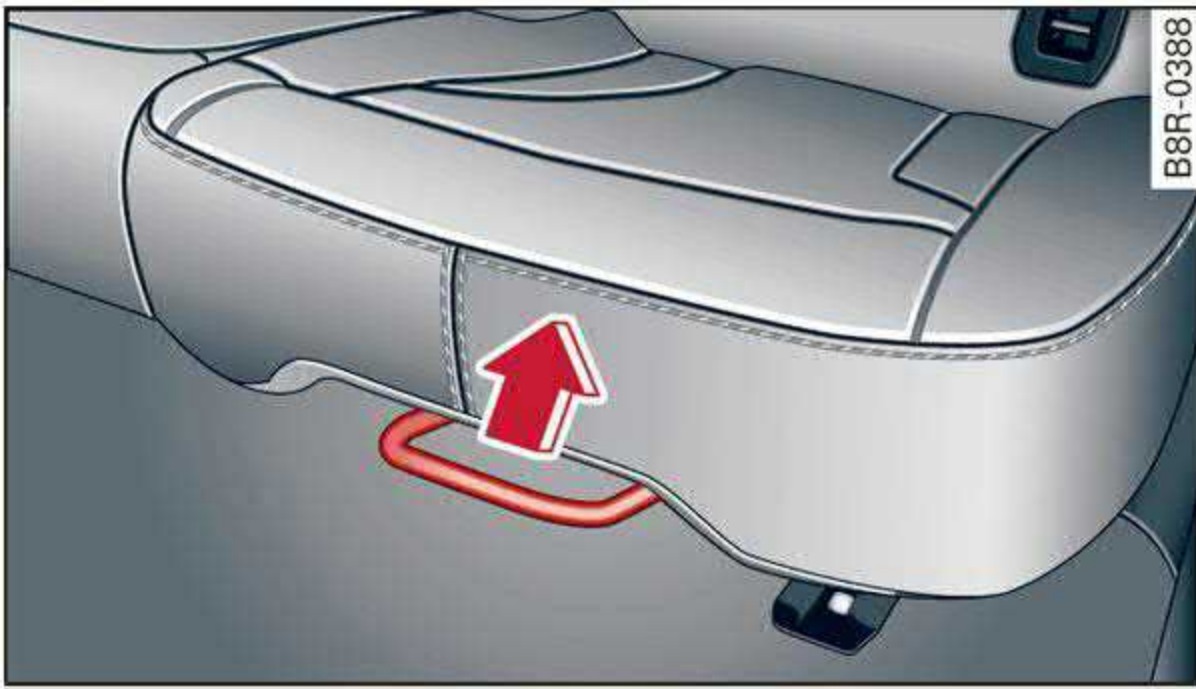

Fig. 51 Adjusting the seat position

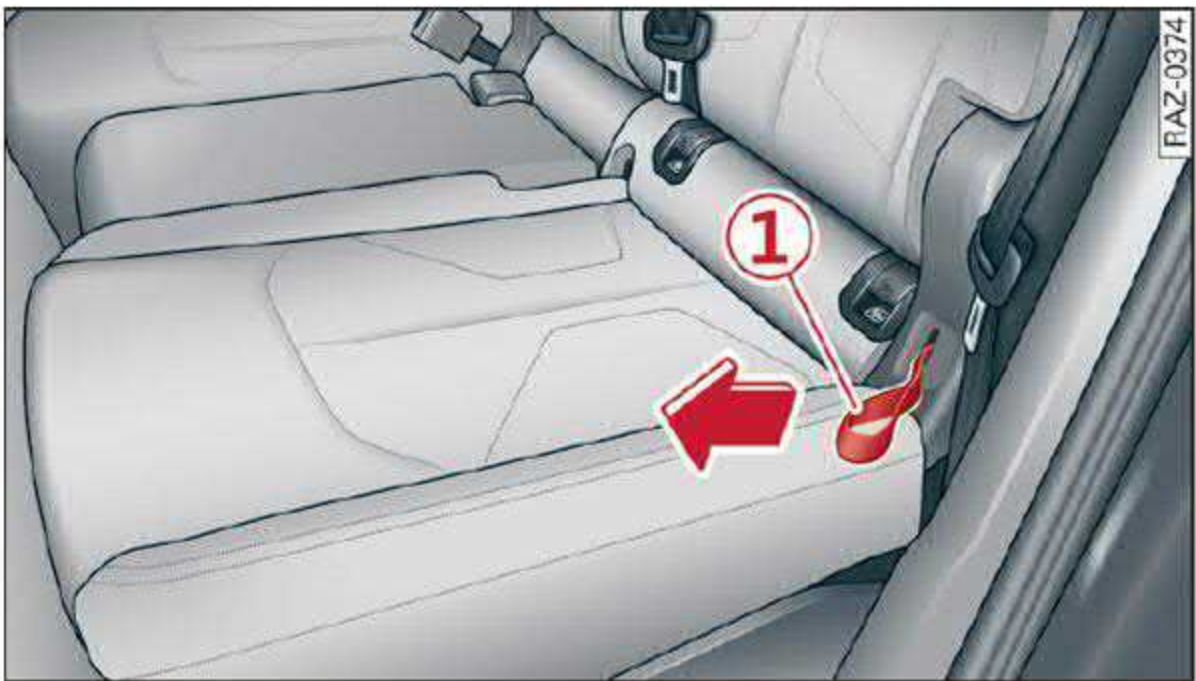

Fig. 52 Adjusting the backrests

Adjusting the seat position

- ▶ To adjust the seat forward or back, pull the handle ⇒ *fig. 51* and slide the seat.
- ▶ Release the handle and continue sliding the seat until it locks into place.

Adjusting the backrests

- ▶ Support the backrest with one hand and pull the strap ① at the same time.
- ▶ Move the backrest forward or back to the desired position.
- ▶ Release the strap and continue moving the backrest until it locks into place.

Steering wheel

General information

Make sure that:

- The distance between your upper body and the steering wheel is at least 10 inches (25 cm)
- Your arms are bent slightly at the elbows
- You have a sufficient view of the area around the vehicle and you have a clear view of the instrument cluster

- You are always holding the steering wheel with both hands on the outer edge at the sides (9:00 and 3:00 position) when driving

WARNING

- To reduce the risk of an accident, make sure the steering wheel is adjusted correctly and cannot be moved out of position before you start to drive.
- If you are too close to the steering wheel, the driver's airbag cannot provide optimal protection, which increases the risk of injury or fatality.
- Never hold the steering wheel in the 12:00 position or in any other way, such as holding the center of the steering wheel. Otherwise, your arms, hands, and head could be injured in the event that the driver's airbag deploys.

Adjusting the steering wheel position manually

Applies to: vehicles with manual steering wheel adjustment



Fig. 53 Steering column: lever for adjusting the steering wheel position

The steering wheel position is adjustable up and down and forward and back.

- ▶ Press the lever in the direction of the arrow.
- ▶ Bring the steering wheel into the desired position.
- ▶ Push the lever all the way up until it engages.

WARNING

- To reduce the risk of an accident, only adjust the steering wheel before you start driving.

- Push the lever upward firmly so that the steering wheel position does not change unintentionally while driving, which would increase the risk of an accident.

Head restraints

General information

Applies to: vehicles with adjustable head restraints

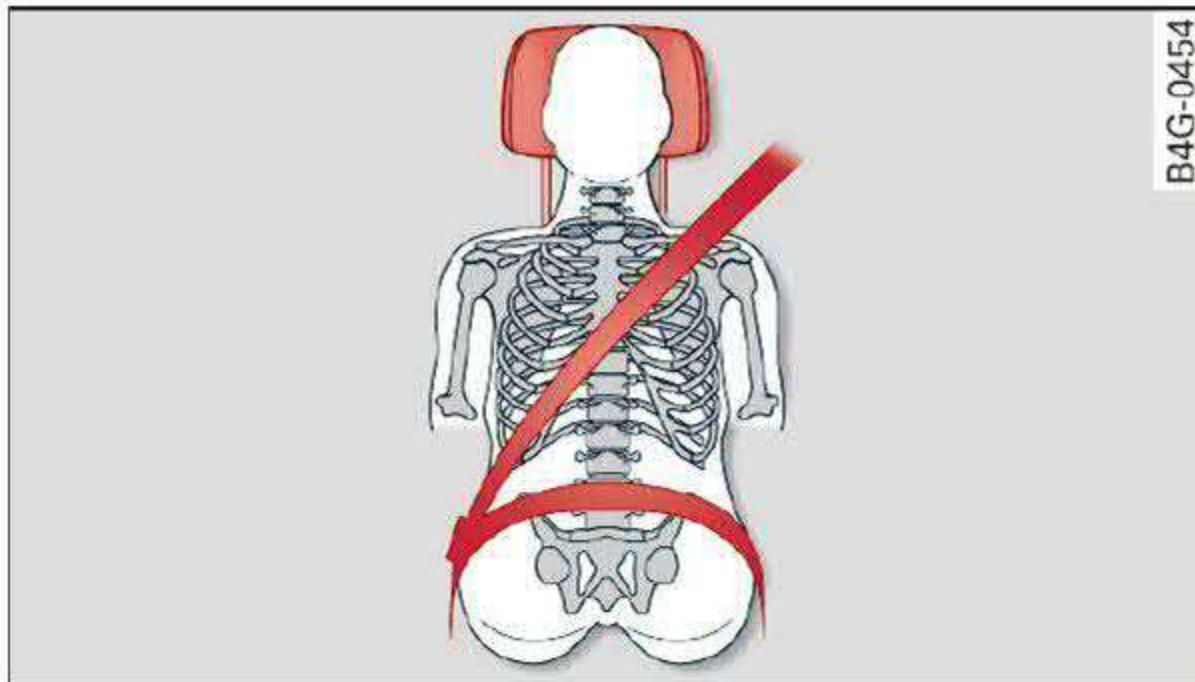

Fig. 54 Correctly-adjusted head restraint

Make sure that:

- The upper edge of the head restraint is as even as possible with the top of your head
- The head restraint is as close as possible to the back of the head
- The head restraints in any occupied rear seats are all the way up

WARNING

- There is one head restraint for each seat. All vehicle occupants must adjust the head restraint correctly before every trip. Having head restraints that are not adjusted correctly or not installed in the vehicle increases the risk of a neck injury during sudden or unexpected driving or braking maneuvers or in a collision.
- Only remove the rear seat head restraints if it is necessary to install a child safety seat ⇒ *page 68*. Stow the removed head restraints securely, for example in the luggage compartment. Reinstall the head restraints immediately once the child safety seat has been removed. Driving without head restraints increases the risk of serious neck injuries.

Front head restraints

Applies to: vehicles with adjustable head restraints

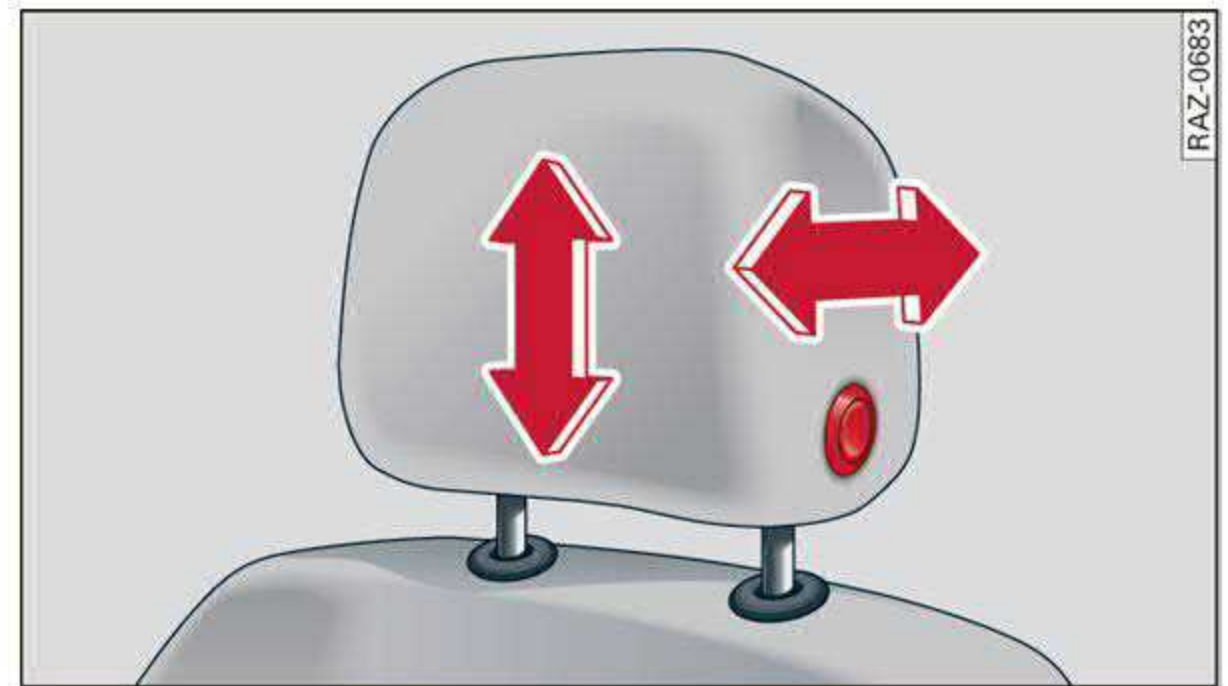

Fig. 55 Front seat: adjusting the head restraint

Adjusting the head restraints

- ▶ To adjust the head restraint upward or forward, slide it until it locks into place.
- ▶ To adjust the head restraint downward or backward, press the button on the side and slide the head restraint. Release the button and slide the head restraint farther until it locks into place.

Rear head restraints

Applies to: vehicles with adjustable head restraints

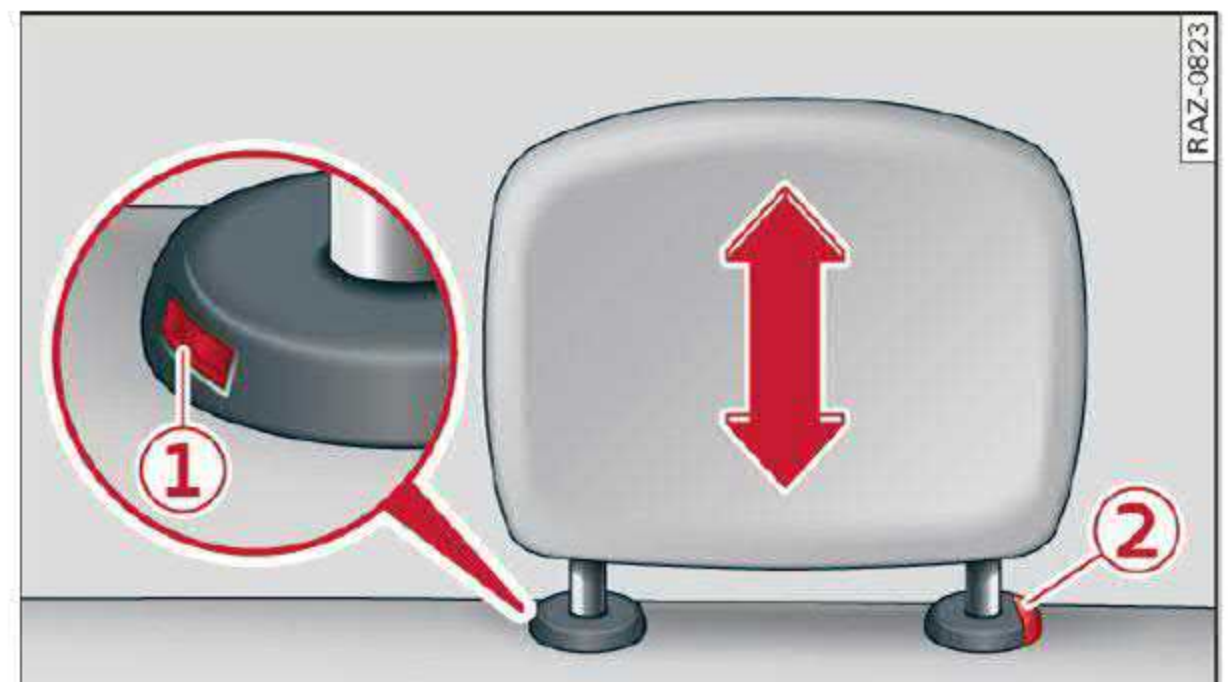

Fig. 56 Rear seat: operating the head restraints

Adjusting the head restraints

- ▶ To adjust the head restraint upward, slide it until it locks into place.
- ▶ To adjust the head restraint all the way up or down, press the button ② and slide the head restraint. Release the button and slide the head restraint farther until it locks into place.

Removing the headrests

- ▶ Fold the backrest forward slightly ⇒ *page 77*.
- ▶ Move the head restraint upward all the way.
- ▶ Insert a suitable object, such as the extended vehicle key or mechanical key, into the release

point ① ⇒ *fig. 56* on the inside or outside of the base.

- ▶ Press the button ② and pull the head restraint out of the backrest ⇒  in *General information* on page 59.

Installing the headrests

Applies to: vehicles with removable head restraints

- ▶ Fold the backrest forward slightly ⇒ *page 77*.
- ▶ Slide the posts on the head restraint down into the guides until the posts click into place.
- ▶ Press the button ② and slide the head restraint all the way down. It should not be possible to remove the head restraint from the backrest without pressing the button.

Safety belts

General information

Each seat is equipped with a three-point safety belt. Safety belts that are worn correctly are the most effective way to reduce the risk of serious or fatal injuries in a collision. Therefore, wear your safety belt correctly and make sure that all vehicle passengers are also wearing their safety belts correctly when the vehicle is moving.

Even though your vehicle is equipped with an airbag system, every vehicle passenger must still always wear the appropriate safety belt. In addition to their normal protective function, safety belts also hold vehicle occupants in the correct seating position in the event of a collision so that the airbags can deploy correctly and provide additional protection. Safety belts provide protection during collisions when the airbags do not deploy or if they have already deployed.

WARNING

The risk of serious or fatal injury increases if the safety belt is not fastened, if it is worn incorrectly, or if it is damaged.

- All vehicle occupants, including the driver, must fasten their safety belts correctly before every trip and must always keep their safety belts fastened during the trip, regardless of whether the seat is equipped with an airbag or not. This also applies to children

that are seated in a child safety seat that is appropriate for their weight and age and that is secured with a safety belt.

- In the event of a collision, vehicle occupants that are not wearing safety belts could be propelled through the vehicle interior and collide with vehicle components, such as the steering wheel, instrument panel, windshield, or doors. In some situations, vehicle occupants could also be ejected from the vehicle. Vehicle occupants in the rear seats who do not wear safety belts not only endanger themselves, but also other people in the vehicle.
- Only one person may be fastened with a safety belt at a time. Never secure more than one person, including children, with a single safety belt.
- Never allow children or infants to ride on another person's lap and be belted into the safety belt with them.
- Insert the belt buckle only in the belt latch belonging to the corresponding seat, so that the protective function is not impaired.
- To ensure the maximum protective function of the safety belts, all vehicle passengers must sit in the correct seating position ⇒ *page 55*.
- Check the condition of your vehicle's safety belts regularly ⇒ *page 243*. If you find damage to the belt webbing, the belt connections, the retractor, or the buckle, have the damaged safety belt replaced by an authorized Audi dealer or authorized Audi Service Facility.
- The safety belts must not be removed or modified in any way. Do not attempt to repair the safety belts yourself.
- Safety belts that are strained during an accident must be replaced by an authorized Audi dealer or authorized Audi Service Facility.

Correct safety belt positioning

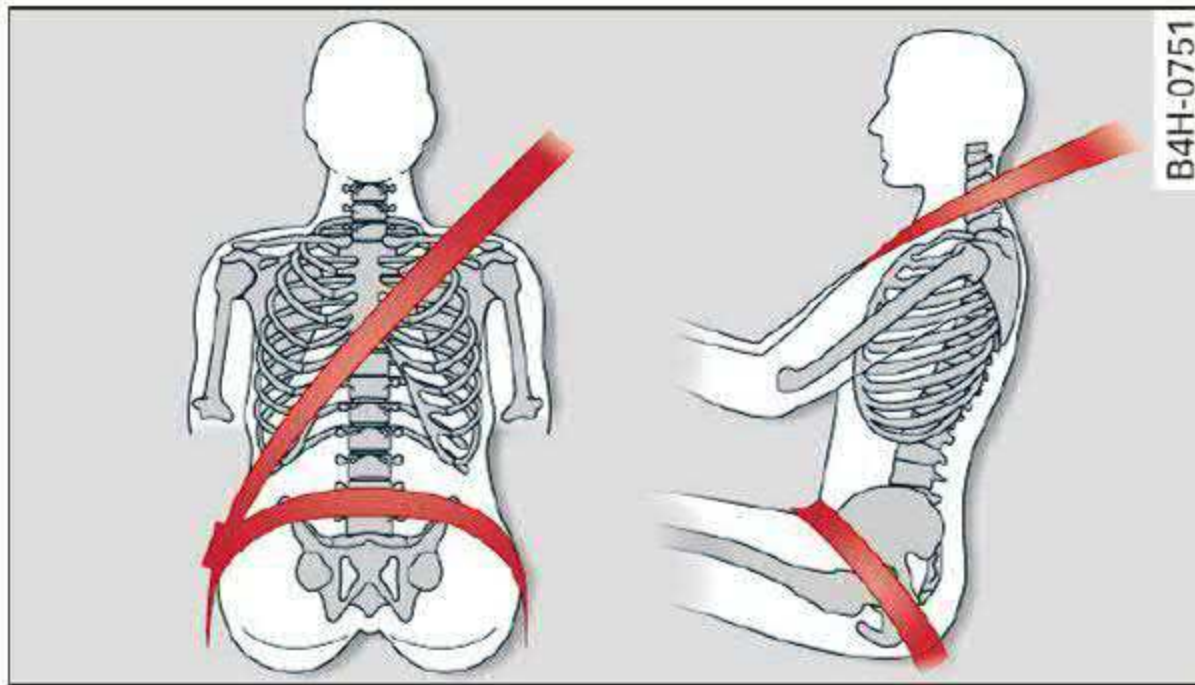

Fig. 57 Lap/shoulder belt positioning



Fig. 58 Safety belt positioning for pregnant women

Fastened safety belts only offer optimal protection during an accident and reduce the risk of serious injury or death when they are positioned correctly. Furthermore, the correct safety belt position holds the vehicle occupant in place so that a deployed airbag can provide maximum protection. Therefore, always fasten the safety belt and make sure it is positioned correctly ⇒ *fig. 57*.

To ensure the safety belt is positioned correctly, make sure of the following points:

- The lap portion of the safety belt must be located across the lap.
- The shoulder portion of the safety belt must rest over the center of the shoulder.
- The safety belt must always rest flat and securely on the body.

For pregnant women, the safety belt must rest evenly across the chest and as low and flat as possible on the lap, so that no pressure is applied to the lower abdomen. This should be done throughout the entire pregnancy ⇒ *fig. 58*.

⚠ WARNING

- Incorrect safety belt positioning can cause serious injury in the event of an accident or during sudden braking or driving maneuvers.
- Never drive with the backrest reclined extremely far. The more the backrest is tilted back, the greater the risk of injury due to the safety belt being routed incorrectly.
 - The safety belt itself or a loose safety belt can cause serious injuries if it shifts onto soft areas of the body, such as the stomach.
 - The shoulder portion of the safety belt must lie over the center of the shoulder and chest, and never under the arm, behind the back, or across the neck or face.
 - The lap portion of the safety belt must lie across the lap and never over the stomach.
 - The safety belt must lie flat and securely on the upper part of the body and the lap.
 - The belt webbing must not be pinched or twisted, or rub against sharp edges.
 - If the safety belt height is set incorrectly and/or the safety belt is routed incorrectly, then the safety belt's protective function will be impaired in the event of an accident. Make sure the safety belt is at the right height and is routed correctly for the passenger using it.
 - A safety belt that is too loose may lead to injuries during an accident, because your body will move farther forward due to kinetic energy and will be stopped abruptly by the belt.
 - Heavily bulky, loose clothing (for example, a coat over a sports jacket) may prevent the seat and safety belts from functioning correctly.
 - Do not position the safety belt over hard or breakable objects (such as glasses, pens, etc.).
 - The lap belt portion of the safety belt must sit as low as possible on the lap of pregnant women and lie flat under the belly.

ⓘ Note

Make sure that there are no hook-and-loop fasteners or sharp objects such as zippers or

Sitting correctly and safely

rivets on clothing in the area where the safety belt is worn. Otherwise, the safety belt could be damaged.

Fastening and unfastening safety belts

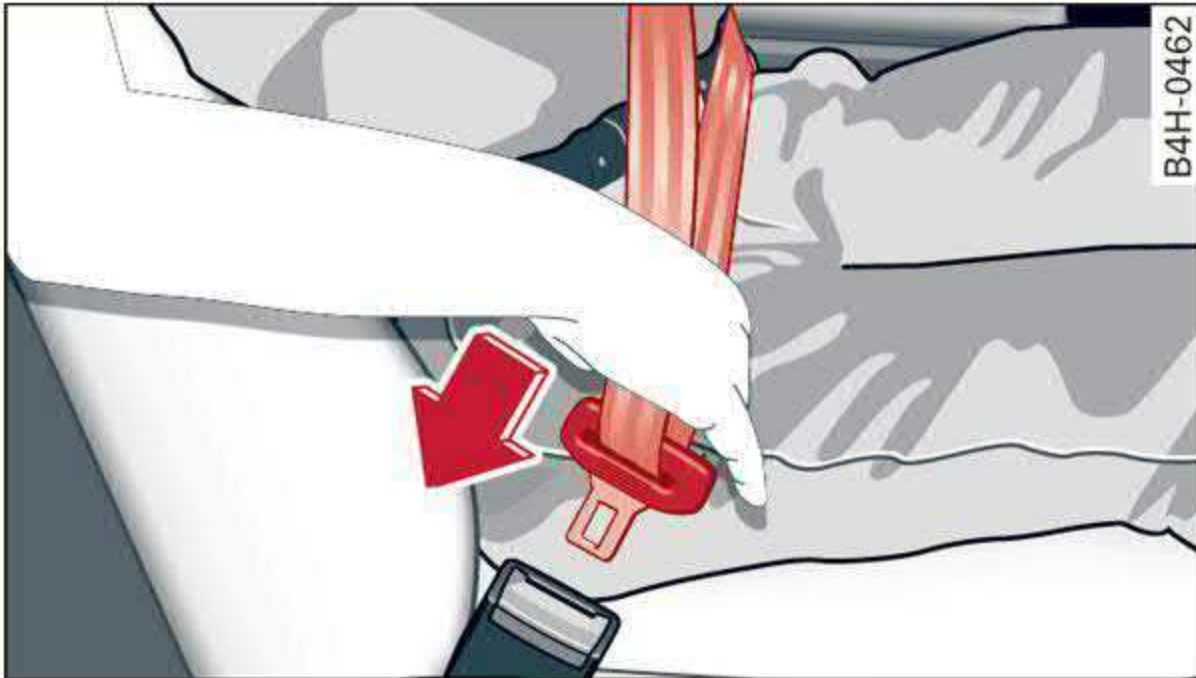

Fig. 59 Belt buckle and belt latch



Fig. 60 Releasing the belt buckle from the belt latch

Observe the safety precautions ⇒ *page 60*.

Fastening the safety belt

- ▶ Pull the safety belt by the belt buckle evenly across your chest and lap.
- ▶ Insert the belt buckle in the belt latch belonging to the seat until it audibly engages ⇒ *fig. 59*.
- ▶ Pull on the belt to make sure that the belt is securely locked in the latch.

Unfastening the safety belt

- ▶ Press the red button on the belt latch ⇒ *fig. 60*. The belt buckle will pop out.
- ▶ Guide the belt back by hand so that the safety belt can roll up more easily.

Safety belt monitoring system

 - If the indicator light turns on or flashes, a safety belt is not fastened or it has been unbuck-

led while driving. Above certain speeds, additional warning tones will sound.

Depending on the equipment, the safety belts in the rear may also be monitored using the following indicator lights:

 - If this indicator light turns on, the safety belt for the corresponding rear seat is not fastened.

 - If this indicator light turns on, the safety belt for the rear seat has been fastened.

Adjusting the height of the safety belt

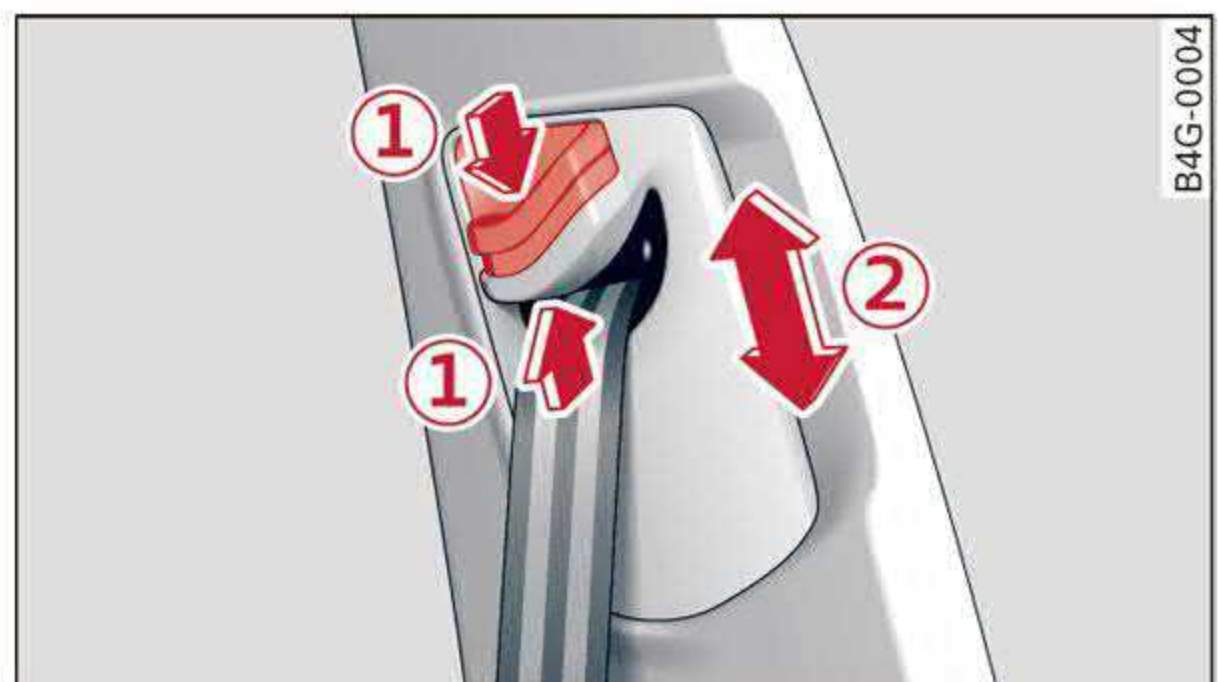

Fig. 61 Belt height adjustment for the front seats - safety belt relay

- ▶ To move the belt higher, slide the safety belt relay ② upward.
- ▶ To move the belt lower, press the release button ① and slide the safety belt relay ② downward.
- ▶ To check if the safety belt relay is securely locked in place, pull firmly on the belt.

Tips

You can also adjust the height of the front seats to change the position of the safety belts.

Additional safety belt functions

Belt retractor lock

The safety belts on the rear seats and on the front passenger seat are equipped with a belt retractor lock.

- ▶ If you secure a child safety seat with a safety belt, the belt retractor lock on the safety belt

may need to be activated. Follow the instructions from the child safety seat manufacturer.

- ▶ When a vehicle passenger has fastened a safety belt, the belt retractor lock should not be activated. If the belt retractor lock has been activated unexpectedly, deactivate it.

Deactivating or activating the belt retractor lock ⇒ *page 71*.

Safety belt retractor

The safety belts are equipped with an automatic belt retractor. This automatic retractor allows the safety belt to be pulled all the way out when the belt is pulled slowly. However, the automatic retractor locks during sudden braking maneuvers. It also locks the belts when accelerating, driving uphill, and driving around curves.

Belt force limiter

Safety belts with belt force limiters reduce the force placed on the body by the safety belts during a collision.

Safety belt pretensioners

In certain driving situations, safety belts may be tightened with reversible belt tensioners when you start driving. If the safety belt is too loose, it will be tightened so that the belt will rest closer to the body.

In some collisions, pyrotechnic belt tensioners may secure the safety belts so that they cannot loosen. This reduces forward movement by the vehicle passengers.

WARNING

The pyrotechnic system can only provide protection during one collision. If the pyrotechnic belt tensioners deploy, the pretensioning system must be replaced by an authorized Audi dealer or authorized Audi Service Facility.

Tips

Smoke may be released when pyrotechnic belt tensioners deploy. This is not a sign of a vehicle fire.

Airbag system

General information

WARNING

- If you have not fastened your safety belt, you are in an incorrect seating position, or you are too close to the airbag system, the airbag system will not be able to protect you. This increases the risk of serious or fatal injuries. Make sure that every vehicle passenger has their safety belt correctly fastened and is sitting in a correct seating position ⇒ *page 55*. This is necessary regardless of whether the seat is equipped with an airbag or not.
- Never place your feet on the instrument panel, out of the window, or on the seat surfaces. To help ensure that the airbag system can deploy correctly, never bend forward or lean on the door or the side window. Otherwise, serious and possibly fatal injuries can occur if the airbags deploy.
- People, animals, or objects between the passengers and the airbag system can interfere with the correct deployment of the airbag or can be thrown through the vehicle interior, increasing the risk of serious or fatal injuries. Make sure that nothing is located between the vehicle occupants and the airbag system. Do not secure or transport any objects within the deployment zone of the airbag systems, especially on the steering wheel, on the instrument panel, on the doors, on the windows, or in the footwell.
- Never put stickers on the airbag system covers or cover them with any objects.
- Only lightweight clothing should be hung from the garment hooks in the vehicle. Do not use clothes hangers to hang clothing. The pockets of the clothing must not contain any heavy, breakable, or sharp-edged objects. This could impair the effectiveness of the side curtain airbags.
- You must not use seat or protective covers that are not specifically approved for use on Audi seats with side airbags. Since the side airbags deploy from the seat backrest, such

covers could impair the protective function of the side airbags.

- Damage to the original seat covers in the side airbag deployment area must always be repaired by an authorized Audi dealer or authorized Audi Service Facility.
- Airbag system components are installed at various locations in your vehicle. Incorrect work or repairs on the vehicle could damage the airbag system components or impair their functionality. This may prevent the airbags from deploying or cause them to deploy incorrectly in the event of an accident, which increases the risk of serious or fatal injuries. Only have an authorized Audi dealer or authorized Audi Service Facility make repairs or modifications to a vehicle.
- The airbag system can only provide protection during one collision. If there is another collision, the airbag system will not deploy again. If the airbag system has deployed, have it replaced immediately by an authorized Audi dealer or authorized Audi Service Facility.
- Fine dust may appear if the airbags deploy. This is completely normal and does not indicate a fire in the vehicle. The fine dust can irritate the skin and mucous membranes in the eyes and can cause difficulty breathing, particularly for individuals who have or have had asthma or other health issues that af-

fect breathing. Exit the vehicle or open the windows or doors to get access to fresh air.

Tips

If you are transporting children in the vehicle, read the information and follow the safety precautions ⇒ *page 68*.

Safety systems monitoring

The  indicator light in the instrument cluster monitors the safety systems such as the airbags (including the control modules, sensor, and wiring) and the belt tensioners. It turns on when you switch the ignition on and turns off after several seconds.

If the indicator light does not turn on when the ignition is switched on, does not turn off after several seconds, or turns on or flashes while driving, there may be a malfunction in one of the safety systems. Drive to an authorized Audi dealer or authorized Audi Service Facility immediately to have the malfunction corrected.

WARNING

Have the malfunction in the safety systems inspected immediately. Otherwise, there is a risk that the systems may not activate during an accident, which increases the risk of serious or fatal injury.

Description

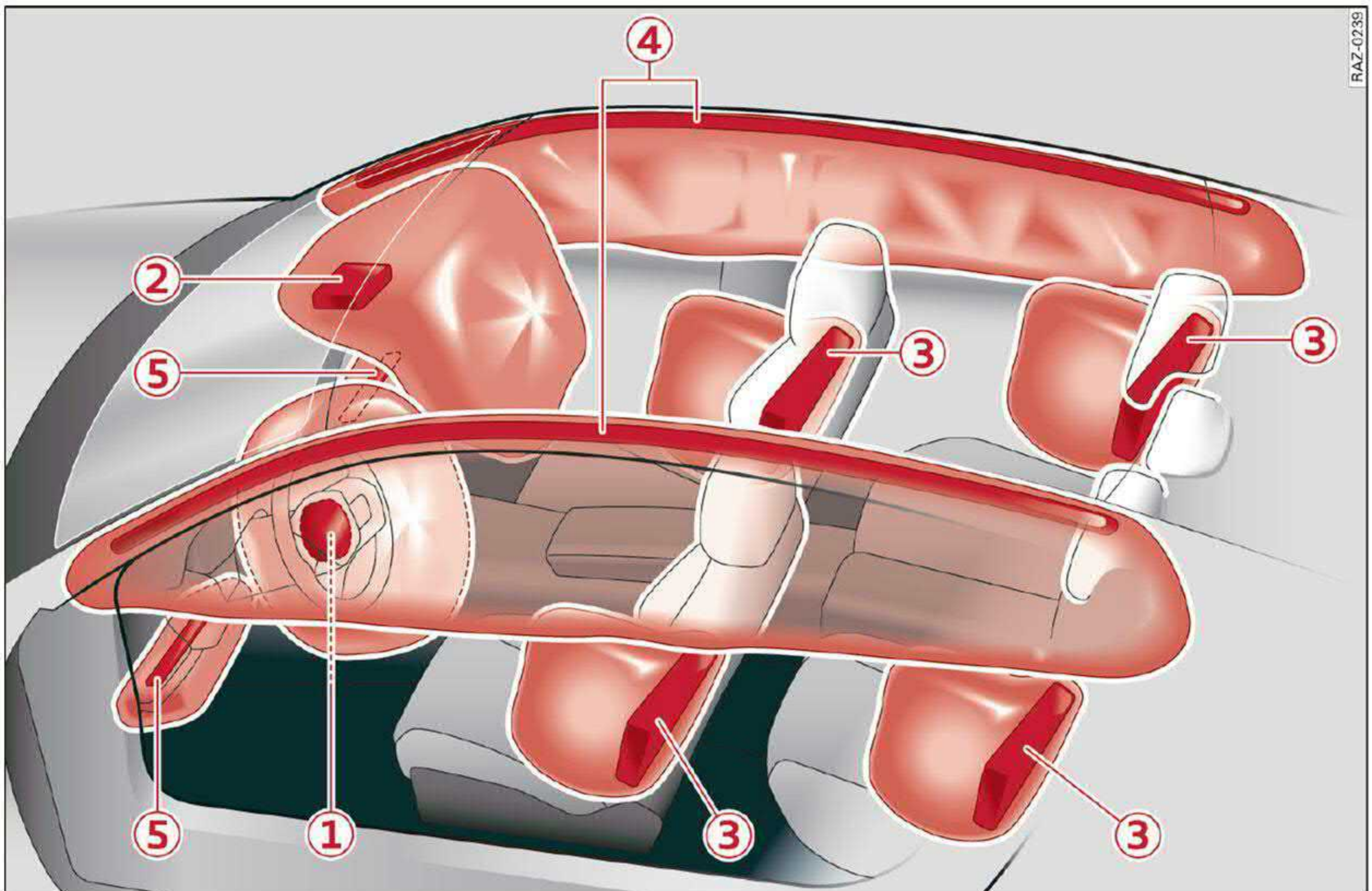

Fig. 62 Airbag overview image (enlarged section: deployed airbags)

The locations of the airbags are labeled with "AIRBAG". The following airbags are installed in your vehicle:

- ① Driver's airbag
- ② Front passenger's airbag
- ③ Front side airbags and rear, if applicable
- ④ Head curtain airbag with ejection mitigation
- ⑤ Knee airbags

Airbags offer the best possible protection in your vehicle during an accident when they are used together with safety belts that are fastened correctly, and when passengers are sitting in the correct seating position. Airbags are a supplementary restraint system and do not replace safety belts.

Airbags may deploy during front-impact, side-impact, or rollover accidents.

The deployment area for the airbag system cannot be defined for every situation, since the circumstances surrounding accidents can vary widely. Factors that play an important role include the

condition of the object that the vehicle hits (hard or soft), the angle of impact, vehicle speed, etc. The deciding factor for the deployment of the airbag system is the deceleration that occurs during an accident. Sensors in the vehicle are designed to detect the severity of an accident in conjunction with the control module, and to provide a targeted and timely deployment of the restraint system. If the vehicle deceleration that is measured during an accident is below the specified reference values in the control module, then the airbags will not deploy, even though the vehicle may be severely damaged from the accident. In these cases, the vehicle occupants will be protected by the safety belts if they are fastened and worn correctly.

The deployment of the front passenger's airbag will depend on the occupancy of the seat
⇒ page 66.

Each deployed airbag is filled with gas. When this occurs, the airbag covers open and the airbags unfold with great force into the deployment zone ►

within milliseconds. Inflated airbags reduce the movement of passengers wearing safety belts in the direction of the impact and thus help to reduce the risk of injury. They can help to protect the head, upper body, and lap, for example. However, there is the possibility that airbag deployment can cause injuries.

The airbag system only works when the ignition is turned on.

If you or other vehicle passengers have physical limitations that prevent sitting in a correct position, modifications to the vehicle may be necessary. For more information, contact an authorized Audi dealer or authorized Audi Service Facility, or call Audi customer support at 1-800-822-2834.

Tips

The side curtain airbags in your vehicle have ejection mitigation functions. This reduces the risk of being ejected from the vehicle interior during an accident, especially in the event of a vehicle rollover.

Advanced airbag system



Fig. 63 Headliner: indicator light to display the status of the front passenger's airbag



The Advanced Airbag System in your vehicle has been certified to comply with the requirements of the United States Federal Motor Vehicle Safety Standard (FMVSS) 208, as well as Canada Motor Vehicle Safety Standard (CMVSS) 208 as applicable at the time your vehicle was manufactured. According to these requirements, the front Advanced Airbag System on the passenger's side has been certified for "suppression" for infants approximately 12 months old and younger, and

for "low risk deployment" for children aged 3 to 6 years old (as defined in the standard).

The advanced airbag system will activate or deactivate the front passenger's airbag based on the occupancy of the seat. If a front airbag deploys during an accident, the deployment force will adapt to the passenger.

Components

The advanced airbag system consists of the following components:

- Front airbags in the steering wheel and in the instrument panel on the front passenger's side: these can protect the front passengers during an accident
- Passenger occupant detection sensor in the front passenger's seat: this detects if the front passenger's seat is occupied (for example, by a person or a small child in a child safety seat)
- Seat position sensors on the front seats: these determine the distance between the seat and the steering wheel or instrument panel
- Sensors in the front seat belt latch: these detect if the safety belts are fastened
- PASSENGER AIR BAG OFF  ON  indicator light in the headliner: this indicates if the front passenger's airbag is activated or deactivated
-  indicator light in the instrument cluster: this monitors the function of the Advanced Airbag System components to ensure they are functioning correctly

How the components function together

The passenger occupant detection sensor in the front passenger's seat detects if the front passenger's seat is occupied. The passenger occupant detection sensor measures the electrical capacity on the front passenger's seat. The passenger's airbag is activated or deactivated depending on the electrical capacity that is measured.

The passenger's airbag is activated if:

- The electrical capacity is higher than the threshold stored in the control module

- The electrical capacity is the same as or greater than the electrical capacity of a typical adult



The passenger's airbag is deactivated if:

- The electrical capacity is lower than the threshold stored in the control module
- The electrical capacity is the same as or less than the electrical capacity of a typical one-year-old child in a child safety seat that has been used for certification in accordance with FMVSS 208

If the front passenger's airbag is activated, the PASSENGER AIR BAG ON  indicator light will turn on. If the front passenger's airbag is deactivated, the PASSENGER AIR BAG OFF  indicator light will turn on.



The deployment force of the front airbags adapts based on whether or not the safety belt is used and the distance between the seat and the steering wheel/instrument panel. For example, if a person is too close to the front airbag, the front airbag will deploy with less force to help reduce the risk of injury.

Meaning of PASSENGER AIR BAG OFF ON indicator light





When the ignition is switched on, the system detects whether the front passenger's seat is occupied. PASSENGER AIR BAG OFF  ON  will turn on for several seconds during this process. Then it will indicate whether the front passenger's airbag is activated or deactivated.

- PASSENGER AIR BAG OFF : the front passenger's airbag is deactivated and will not deploy in the event of an accident.
- PASSENGER AIR BAG ON : the front passenger's airbag is activated and could deploy in the event of an accident.



If a change to the occupancy status of the front passenger's seat is detected

PASSENGER AIR BAG OFF  ON  will flash for several seconds and will then display the status of the front passenger's airbag.



Always make sure the indicator light corresponds to the occupancy of the front passenger's seat.

- **An adult or individual of similar size in the front passenger's seat:** the front passenger's airbag must be activated, therefore PASSENGER AIR BAG ON  must remain turned on.
- **An individual of smaller size (for example, an adolescent or small adult) in the front passenger's seat:** the front passenger's airbag must be activated, so PASSENGER AIR BAG ON  must stay on.
- **Child in a child safety seat on the front passenger's seat:** the front passenger's airbag must be deactivated, so PASSENGER AIR BAG OFF  must stay on.
- **Front passenger's seat not occupied:** the front passenger's airbag must be deactivated, so PASSENGER AIR BAG OFF  must stay on.

WARNING

- An adult or a person with a small stature (such as a young person or small adult) seated on the front passenger's seat will not be protected by the passenger's airbag in the event of a collision if the passenger's airbag is deactivated. This increases the risk of injury and death. Always make sure that PASSENGER AIR BAG ON  remains on while driving. If PASSENGER AIR BAG ON  does not turn on, make sure the front passenger is sitting correctly in the seat ⇒ *page 55* and that there is nothing covering the front passenger's seat (such as blankets or pillows). If PASSENGER AIR BAG ON  still does not turn on, the front passenger's seat must not be used. Drive to an authorized Audi dealer or authorized Audi Service Facility and have the airbag system inspected.
- A child in a child safety seat on the front passenger's seat - especially in a rear-facing child safety seat - can receive a severe impact if the front passenger's airbag deploys, which increases the risk of serious or fatal injury. Always secure child safety seats on the rear seats. If special circumstances require the use of a child safety seat on the front passenger's seat, always make sure

that PASSENGER AIR BAG OFF  stays on while driving. If

PASSENGER AIR BAG OFF  does not turn on, remove the child safety seat and install it again according to the child safety seat manufacturer instructions. If PASSENGER AIR BAG OFF  still does not turn on, the front passenger's seat must not be used. Drive to an authorized Audi dealer or authorized Audi Service Facility and have the airbag system inspected.

- Fluids, electronic devices, or mechanical damage on the front passenger's seat may cause the front passenger seat occupant detection to malfunction. The system may then incorrectly detect if the front passenger's seat is occupied. As a result, it could deploy the front passenger's airbag incorrectly or fail to deploy it, which increases the risk of serious or fatal injury. Make sure that no wet objects (such as a wet hand towel) and no fluids come into contact with the front passenger's seat cushion. If the front passenger's seat becomes wet, dry it immediately. Make sure no electronic devices (such as a laptop or a retrofitted seat heater) are on the front passenger's seat. Do not transport any objects on or under the front passenger's seat.
- Seat covers or protective covers may prevent the advanced airbag system from correctly detecting child safety seats or passengers in the front passenger's seat. You must not use seat covers or protective covers on the front passenger's seat that are not specifically approved for use on Audi seats with an advanced airbag system.

Child safety seats

General information

When installing and using child safety seats, follow the information in this Owner's Manual, the applicable state and federal regulations, and the manufacturer instructions for the child safety seat.

You can also obtain useful and current information from the following sources:

U.S. National Highway Traffic Safety Administration

<http://www.nhtsa.gov>

<http://www.safercar.gov>

National SAFE KIDS Campaign

<http://www.safekids.org>

SafetyBeltSafe U.S.A.

<http://www.carseat.org>

Transport Canada Information Centre

<http://www.tc.gc.ca/roadsafety>

Audi Customer Experience Center

<https://www.audiusa.com/help/contact-us>



<https://www.audi.ca/ca/web/en/models/layer/contact.html>

WARNING

To reduce the risk of serious or fatal injuries, children must always be secured in the vehicle with a child safety seat that is appropriate for their body size, weight, and age.

- Children ages 12 and under must be transported using the appropriate child safety seat. Note differences in regulations between states and countries.
- Child safety seats secured incorrectly in the vehicle may cause serious or fatal injuries in the event of an accident. Always secure the child safety seat according to the manufacturer instructions.
- Children or babies must not under any circumstances be held on the lap of the driver or other passengers while driving.
- Do not secure more than one child in a child safety seat.
- Never allow a child to sit in a child safety seat unsupervised.
- Never allow children to ride unsecured in the vehicle or to stand or kneel on the seats while driving. In the event of an accident, a child could be propelled through the vehicle. This can cause serious or fatal injuries for the child and passengers.
- If children use an incorrect seating position while driving, they have a higher risk of

injury during a sudden braking maneuver or accident. This especially applies to children in the front passenger's seat or children who have their head near the side airbag deployment area, if the airbag system is deployed during an accident. This incorrect seating position can cause severe or even fatal injuries.

- Make sure there is enough space in front of the child in the child safety seat. If necessary, adjust the angle and position of the seat in front of the child safety seat.
- The rear side of a forward-facing child safety seat should be positioned as close as possible to the backrest on the vehicle seat. If the head restraints make it difficult to install a child safety seat, adjust or remove them if necessary ⇒ *page 59*. Reinstall the head restraints immediately once the child safety seat has been removed.
- Always make sure that the backrest on the seat where the child safety seat is installed is securely locked in place and cannot move forward. Otherwise, the backrest where the child safety seat is secured could move forward in the event of an accident or other emergency situation.
- NEVER use a rear-facing child safety seat on a seat with an ACTIVATED FRONT AIRBAG; this could cause DEATH or SERIOUS INJURIES to a CHILD.
- Always secure child safety seats on the rear seats. If exceptional circumstances require the child safety seat to be placed on the front passenger's seat, then the front passenger's airbag must be deactivated. Always make sure that PASSENGER AIR BAG OFF  stays on while driving. If PASSENGER AIR BAG OFF  does not turn on, remove the child safety seat and install it again according to the child safety seat manufacturer instructions. If PASSENGER AIR BAG OFF  still does not turn on, the front passenger's seat must not be used. Drive to an authorized Audi dealer or authorized Audi Service

Facility and have the airbag system inspected.

- If you must use a forward-facing child safety seat on the front passenger's seat, move the seat as far back as possible so that it is as far as possible from the front passenger's airbag. While doing this, make sure the seat can be adjusted all the way. A child in a child safety seat on the front passenger's seat can receive a severe impact if the front passenger's airbag deploys, which increases the risk of serious or fatal injury.
- Replace the child safety seat after an accident because there could be damage that is not visible.
- Even if a child is not sitting in the child safety seat, the child safety seat must be secured. An unsecured child safety seat may be thrown through the vehicle interior during sudden braking maneuvers or an accident.

Correct positioning for children

Always secure children in a child safety seat designed for the body size, weight, and age of the child.

You can secure child safety seats in your vehicle using the lower LATCH anchors or the safety belts. You can also secure child safety seats to the top tether anchor. Depending on the child safety seat, it may also be necessary to secure it to the top tether anchor. In Canada, securing forward-facing child safety seats to the top tether anchors is required by law.

Always transport children in the rear seats

Accident statistics show that children that are secured correctly in the rear seats are safer than in front seats. Always transport children in suitable child safety seats secured on the rear seats.

In exceptional circumstances: transporting children in the front passenger's seat

If exceptional circumstances require the child safety seat to be placed on the front passenger's seat, then the front passenger's airbag must be deactivated. Please note the important

Sitting correctly and safely

information for this ⇒ *page 66, Advanced airbag system*. If you must secure a forward-facing child safety seat, move the front passenger's seat as far back as possible so that it is as far as possible from the front passenger's airbag. While doing this, make sure the seat can be adjusted all the way.

Only switch to a larger child safety seat when absolutely necessary

Switch to a larger child safety seat only when absolutely necessary. Secure your child using a safety belt without a child safety seat only if all of the following statements are true:

- The child is large enough to sit upright in the seat
- The child is able to sit with his or her back resting completely on the seat backrest
- The child is able to sit with his or her knees bent over the edge of the seat surface
- The child is able to sit with both of his or her feet completely touching the floor in the footwell
- The lap portion of the safety belt lies flat and securely over the hip area and never over the stomach
- The shoulder portion of the safety belt lies flat and securely over the center of the shoulder and the chest, and never under the arm, behind the back, or over the neck or face.
- The child is able to maintain this seating position throughout the entire trip

Read and follow the important information and warnings regarding the correct use of safety belts ⇒ *page 60*.

Tips

- Child safety seats can also be secured to seats with side airbags. In the event of an accident, children can also be protected by the side airbags if the child is correctly secured in a suitable child safety seat that is attached correctly.
- The lower LATCH anchors as well as the safety belt may be required to correctly install some child safety seats. Using both at the same time is permitted, provided that

the fastening systems or safety belts do not impair those in an adjacent seating position.

- All child safety seats are constructed so that they can be secured using the lap safety belt in the vehicle.
- Child safety seats with a load leg can only be secured to the outer rear seats and to the front passenger's seat.

Securing child safety seats to the lower LATCH anchors



Fig. 64 Rear bench seat: lower LATCH anchors

Observe the safety precautions ⇒ *page 68*.

In the United States and Canada, child safety seats can be secured without safety belts using the LATCH system. LATCH stands for Lower Anchors and Tethers for Children. In Canada, similar systems are called UCRA, LUAS, or UAS.

The lower LATCH anchors in your vehicle are located on the outer seats of the rear bench seat between the seat surface and the backrest. These seating locations each have two lower LATCH anchors that can be used to secure a LATCH child safety seat. Marking points with a ⇒ *fig. 64* symbol are located on the covers for the lower LATCH anchors. You can locate the LATCH anchors using the marking points.

- ▶ Applies to: vehicles with forward/back adjustable rear bench seat: Move the rear seat all the way back.
- ▶ Activate the child safety lock ⇒ *page 38*.
- ▶ Remove the cover* from both lower LATCH anchors.
- ▶ If you secure a child safety seat to the rear seat, secure any unused safety belts that are within ▶

reach of the child ⇒  in *Securing child safety seats with a safety belt* on page 72.

- ▶ Secure the child safety seat according to the child safety seat manufacturer instructions.
- ▶ Pull on the child safety seat to check if both sides are engaged correctly in the LATCH anchors.
- ▶ If possible, also secure the child safety seat to the respective top tether anchor in the vehicle ⇒ page 72.

WARNING

The LATCH anchors in the vehicle are only designed for child safety seats with the LATCH system. To reduce the risk of serious or fatal injury, never secure other child restraint systems, belts, or objects to the anchors.

Tips

The LATCH anchors are designed for a total weight (child and child safety seat combined) up to 65 lbs (29 kg). If the total weight is greater than this, the child safety seat must be secured with the vehicle safety belt.

Securing child safety seats with a safety belt

Observe the safety precautions ⇒ page 68. The front passenger's seat is a dangerous location for a child, even with an advanced airbag system. If exceptional circumstances require the child safety seat to be placed on the front passenger's seat, then the front passenger's airbag must be deactivated. Please note the important information for this ⇒ page 69, *Correct positioning for children* and ⇒ page 66, *Advanced airbag system*.

Securing child safety seats

- ▶ Applies to: vehicles with forward/back adjustable rear bench seat: Move the rear seat all the way back.
- ▶ Activate the child safety lock ⇒ page 38.
- ▶ If you secure a child safety seat to the rear seat, secure any unused safety belts that are within reach of the child ⇒ , ⇒ page 72.

- ▶ If you secure a child safety seat to the front passenger's seat, adjust the front passenger's seat to the highest position.
- ▶ Secure the child safety seat according to the child safety seat manufacturer instructions.
- ▶ If necessary, activate the belt retractor lock ⇒ page 71.
- ▶ If the child safety seat is secured on the front passenger's seat, adjust the front passenger's seat backrest until it rests flat against the child safety seat. Also make sure that the upper safety belt fixture is behind the child safety seat.
- ▶ If you secure a child safety seat on the rear seat, also secure it to the correct top tether anchor if possible ⇒ page 72.

Activating the belt retractor lock

If you secure a child safety seat using the vehicle safety belt, you must activate the belt retractor lock. Follow the child safety seat manufacturer instructions.

The belt retractor lock prevents the safety belt from becoming loose while driving, which could result in the child safety seat no longer being adequately secured.

- ▶ Secure the child safety seat according to the child safety seat manufacturer instructions. While doing so, pull out the safety belt. Insert the safety belt into the belt latch that belongs to that seat until it audibly locks.
- ▶ Pull the upper belt out completely and then allow it to retract. You will hear a clicking sound while the belt is retracting. It will not be possible to pull the safety belt out any farther.
- ▶ Push the child safety seat into the seat and allow the belt to retract more.
- ▶ Make sure that the child safety seat cannot move more than 1 inch (2.5 cm).

Deactivating the belt retractor lock

- ▶ Unbuckle the safety belt from the belt latch.
- ▶ Remove the child safety seat according to the manufacturer instructions.
- ▶ Allow the safety belt to retract completely. The belt retractor lock is deactivated. ▶

WARNING

- A safety belt that is not locked by the belt retractor lock or a locking device cannot secure a child safety seat while driving or in the event of an accident, which increases the risk of fatal injury. Always make sure the belt retractor lock on the safety belt is activated if the child safety seat manufacturer instructions require it.
- Due to the risk of fatal injury, never place a rear-facing child safety seat on the front passenger's seat when the front passenger's airbag is switched on.
- For the child safety seat to offer the maximum protection, it is especially important to route the vehicle safety belt correctly. Always follow the instructions from the child safety seat manufacturer for routing the safety belt correctly. Incorrectly fastened safety belts can cause injuries, even during minor accidents.

Additionally securing a child safety seat to the top tether anchor



Fig. 65 Rear backrest: top tether anchors to secure a child safety seat with an upper belt



Fig. 66 Rear backrest: securing the upper belt to the top tether anchor

Observe the safety precautions ⇒ page 68.

There is a top tether anchor behind every seat in the rear bench seat to additionally secure a child safety seat with an upper belt.

- ▶ Move the head restraint behind the child safety seat upward.
- ▶ Secure the child safety seat according to the child safety seat manufacturer instructions.
- ▶ Guide the upper belt on the child safety seat under the head restraint or along both sides of it and toward the rear (depending on the child safety seat model).
- ▶ Fasten the belt to the top tether anchor ⇒ fig. 66. While doing this, make sure the belt is not twisted and is not running over any sharp edges.
- ▶ Pull the belt tightly so that the child safety seat rests at the top of the seat backrest.
- ▶ If necessary, move the head restraint behind the child safety seat downward.

WARNING

The top tether anchors in the vehicle are only designed for child safety seats equipped with an upper strap. To reduce the risk of serious or fatal injury, never secure other child restraint systems, belts, or objects to the anchors.

Securing unused safety belts on the rear bench seat



Fig. 67 Rear bench seat: securing unused safety belts

If a child safety seat is used on the rear bench seat, the child must not be able to reach any safety belts that are not being used. Secure safety belts that are within reach of the child. ▶

- ▶ If you secure a child safety seat to the LATCH anchors, fasten the safety belt on the seat where the child safety seat is installed using the seat's safety belt latch.
- ▶ If you secure a child safety seat to one of the outer seats, fasten the safety belt for the center seat in its latch.
- ▶ Activate the belt retractor lock on the fastened safety belts. To do this, pull the upper belt out completely and then allow it to retract. You will hear a clicking sound while the belt is retracting. It will not be possible to pull the safety belt out any farther.
- ▶ Make sure the fastened safety belt does not block access to the LATCH anchors. Otherwise, it may not be possible to secure the child safety seat to the LATCH anchors correctly.

**WARNING**

A child in a child safety seat could play with the unused safety belts and then become entangled in them, which increases the risk of fatal injury. Always secure unused safety belts so that they are not within reach of children in child safety seats.

Storage and convenience

Power sources

When the ignition is switched on, you may be able to use multiple power sources for external devices, depending on the vehicle equipment.

12 volt sockets

You can connect electrical accessories to the 12 volt sockets. The power usage from the sockets must not exceed a total of 120 watts. Do not connect multiple devices to the sockets in the vehicle at the same time.

The 12 volt sockets are labeled with the 12V symbol. They are located in the front center console, in the rear*, and in the left floor panel in the luggage compartment*.

USB ports

Applies to: vehicles with USB port

You can charge mobile devices using the USB ports. The USB ports are labeled with the  or  symbol or CHARGE ONLY.

WARNING

- To reduce the risk of fatal injury, store all connected devices securely when driving so that they do not move around inside the vehicle when braking or in the event of an accident.
- Incorrect usage can lead to serious injuries or burns. To reduce the risk of injuries, never leave children unattended in the vehicle with the vehicle key.

Note

- Read the operating manuals for the connected devices.
- To reduce the risk of damage to the vehicle electrical system, never attempt to charge the vehicle battery by connecting accessories that provide power to the power sources.
- Do not connect any device whose network class (voltage) does not match the network class designed for the socket.

- Disconnect the connectors from the power sources carefully to reduce the risk of damaging them.

Cup holders

Applies to: vehicles with cup holders



Fig. 68 Front center console: cup holder

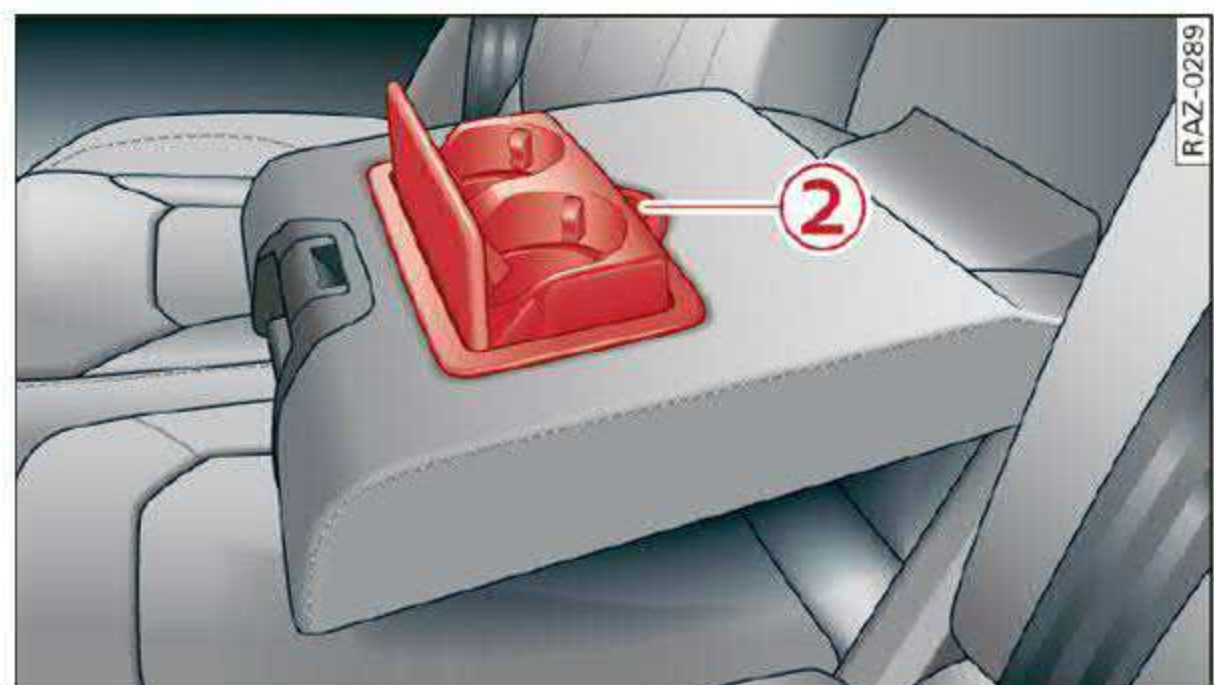

Fig. 69 Rear center armrest: cup holders

Cup holders in the front center console

- ▶ Set your beverage in the holder ①.

Cup holders in the rear center armrest

- ▶ Fold the center armrest downward.
- ▶ To open the cup holder, tap on the button ②.
- ▶ To close the cup holder, fold the cover back until it clicks into place.

WARNING

- Do not put any hot beverages in the cup holder while the vehicle is moving. Hot beverages could spill, which increases the risk of injury.
- Do not use any breakable beverage containers (for example, made out of glass or porcelain). You could be injured by them in the event of an accident.

! Note

Beverage containers in the cup holders should always have a lid. Otherwise, the liquid inside could spill and cause damage to vehicle equipment.

Storage areas and compartments

Depending on vehicle equipment, there are a variety of storage areas, compartments, and retainers, such as the glove compartment, for safely storing and securing objects.

! WARNING

- To reduce the risk of injury, make sure all storage compartments are always closed while driving.
- Loose objects can be thrown around the vehicle interior during sudden driving or braking maneuvers, which increases the risk of an accident. Store objects securely while driving.
- Only use the storage compartments in the door trim panels to store small objects that will not stick out of the compartment and impair the function of the side airbags.
- Only lightweight clothing should be hung from the garment hooks in the vehicle. The pockets of the clothing must not contain any heavy, breakable, or sharp-edged objects. Such objects endanger vehicle occupants and increase the risk of injury during sudden driving or braking maneuvers or in an accident, especially if the airbags deploy.
- Make sure your view toward the rear is not blocked, for example by hanging clothing or objects in the vehicle.

i Tips

Applies to: vehicles with Wi-Fi: Do not place any metal objects in the storage compartment* on the end of the rear center console, because they could impair the Wi-Fi antenna function.

Luggage compartment

General information

All pieces of luggage or objects must be securely fastened in the luggage compartment. Note the following to maintain good vehicle handling:

- ▶ Distribute the load evenly in the luggage compartment.
- ▶ Stow heavy luggage as far forward in the luggage compartment as possible.
- ▶ Use non-elastic cords attached to the tie-downs to secure objects.

! WARNING

- The luggage compartment cover is not a surface for storing objects. Objects placed on the cover increase the risk of injury to all vehicle occupants during sudden driving or braking maneuvers or in the event of an accident.
- The luggage compartment cover must always be securely fastened when in use to reduce the risk of an accident.
- Loose objects can be thrown around the vehicle interior during sudden driving or braking maneuvers, which increases the risk of an accident. Always stow objects securely in the luggage compartment and secure them at the tie-downs. Use straps suitable for heavy objects.
- If pieces of luggage or objects are secured to the tie-downs with unsuitable or damaged straps, this can increase the risk of injury during braking maneuvers or accidents.
- When transporting heavy objects, the vehicle characteristics will change due to the shift in the center of gravity, which increases the risk of an accident. You may need to adapt your driving style and speed to the current conditions.
- The cargo net* is only strong enough to secure light objects. Heavy objects are not adequately secured. Attempting to secure heavy objects increases the risk of injury.
- Never exceed the permitted axle and load and vehicle weight ⇒ *page 270*.

- Never secure a child safety seat to the tie-downs.
- Never leave your vehicle unattended, especially if the luggage compartment lid is open. Children could enter the luggage compartment and close the luggage compartment lid from the inside. This creates the risk of fatal injury, since the children would be locked in and may not be able to escape by themselves.
- Do not allow children to play in or on the vehicle. Close and lock the luggage compartment lid as well as all other doors when you leave the vehicle.
- Never transport passengers in the luggage compartment. Every passenger must be correctly secured with the safety belts in the vehicle ⇒ *page 60*.
- Be careful when releasing the backrest and folding it forward. To reduce the risk of being pinched, pay attention and check when folding backrests forward.
- The backrest must be securely latched so objects cannot slide forward out of the luggage compartment during sudden braking.
- The backrest must be latched securely to ensure that the safety belt is protecting the center seating position.
- Always pull forward on the backrest to make sure it is check if it is correctly locked in place.

Note

- To reduce the risk of damage, move the rear head restraints down ⇒ *page 59* before folding the rear backrests forward.
- Objects should be removed from the rear bench seat to protect the backrest from damage.
- If you move the front seat back when the rear seat backrest is folded forward, you could damage the head restraints on the rear seat.
- Make sure that the heating grid strips for the rear window defogger are not damaged by abrasive objects.

Tips

- The tire pressure must be adapted to the load ⇒ *page 233*.
- You can purchase straps at specialty stores.

Luggage compartment cover

Applies to: vehicles with luggage compartment cover

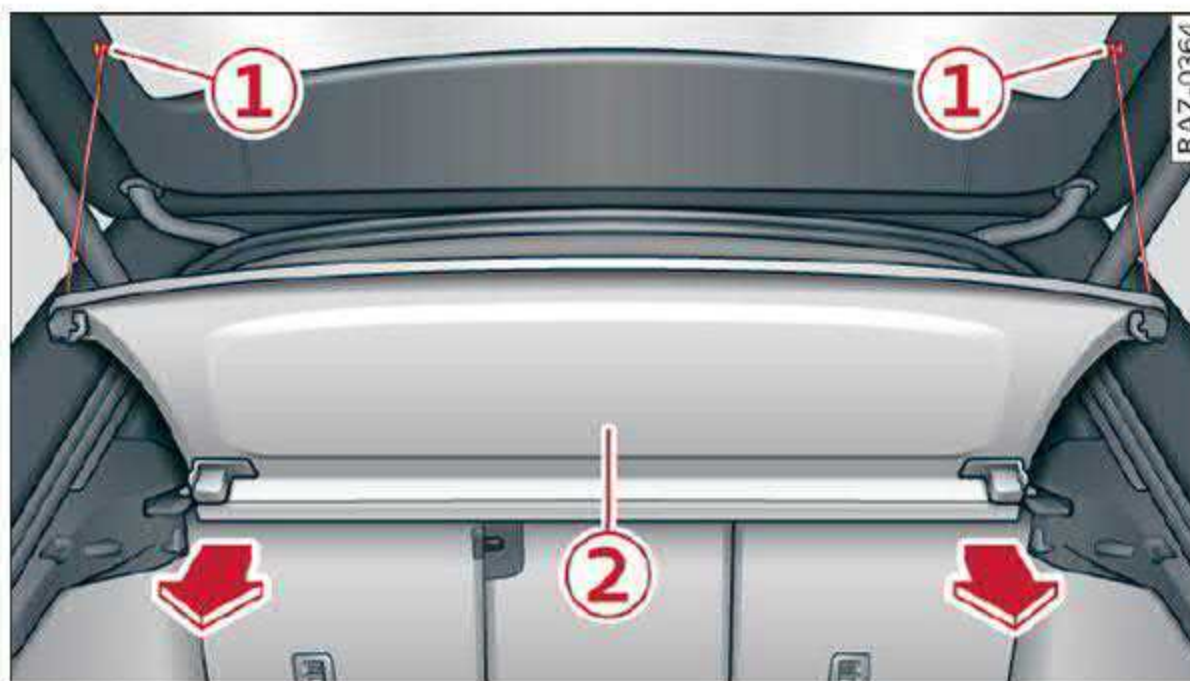

Fig. 70 Luggage compartment: cover when the luggage compartment lid is open

Observe the safety precautions ⇒ *page 75*.

- ▶ To remove the luggage compartment cover, unhook the straps ①.
- ▶ Pull the cover ② out of the retainers in the direction of the arrow.
- ▶ To install the luggage compartment cover, slide it into the retainers until it engages.
- ▶ Hook the straps ① into the luggage compartment lid.

Tips

Depending on the vehicle equipment, you may be able to store the luggage compartment cover under the double cargo floor ⇒ *page 78*. Remove the side inserts to do this.

Increasing the size of the luggage compartment

Applies to: vehicles with folding backrests

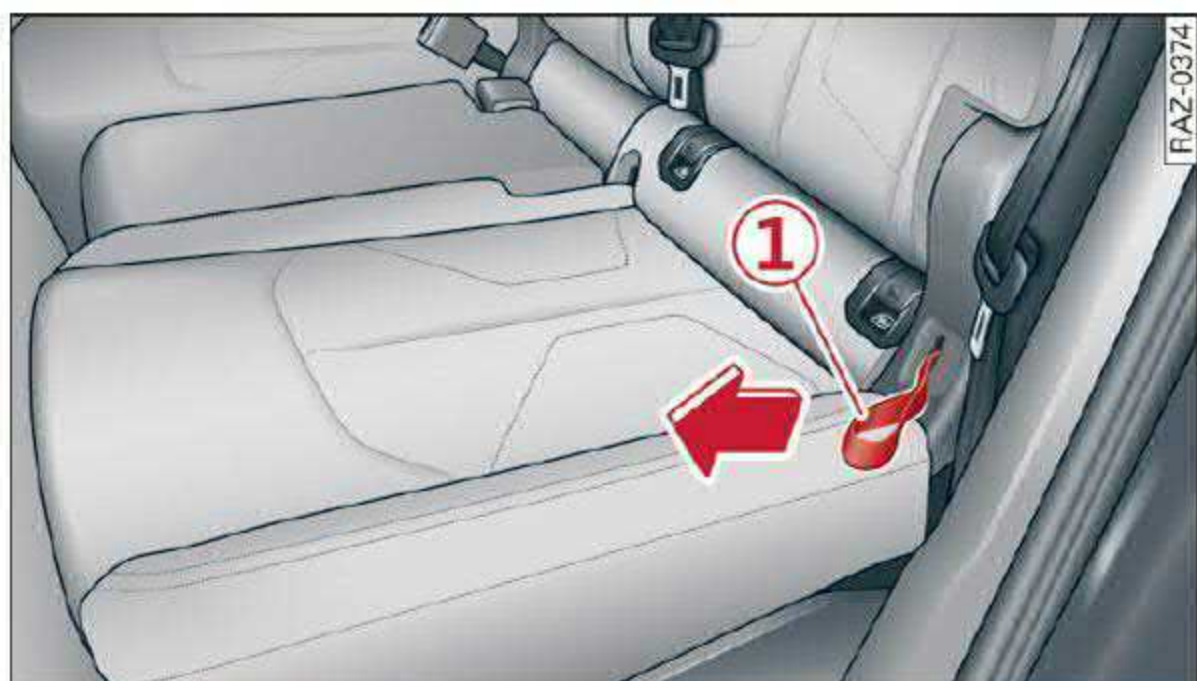

Fig. 71 Rear bench seat: loop

The rear seat backrests can be folded forward either separately or together.

Observe the safety precautions ⇒ page 75.

- ▶ If necessary, slide the rear bench seat forward ⇒ page 58.
- ▶ To fold the backrest forward, pull the strap ① in the direction of the arrow.
- ▶ Fold the backrest forward until it locks into place.
- ▶ To fold the backrest back, pull the strap ① in the direction of the arrow again.
- ▶ After the transport, fold the backrest up until it locks into place.

Pass-through

Applies to: vehicles with pass-through

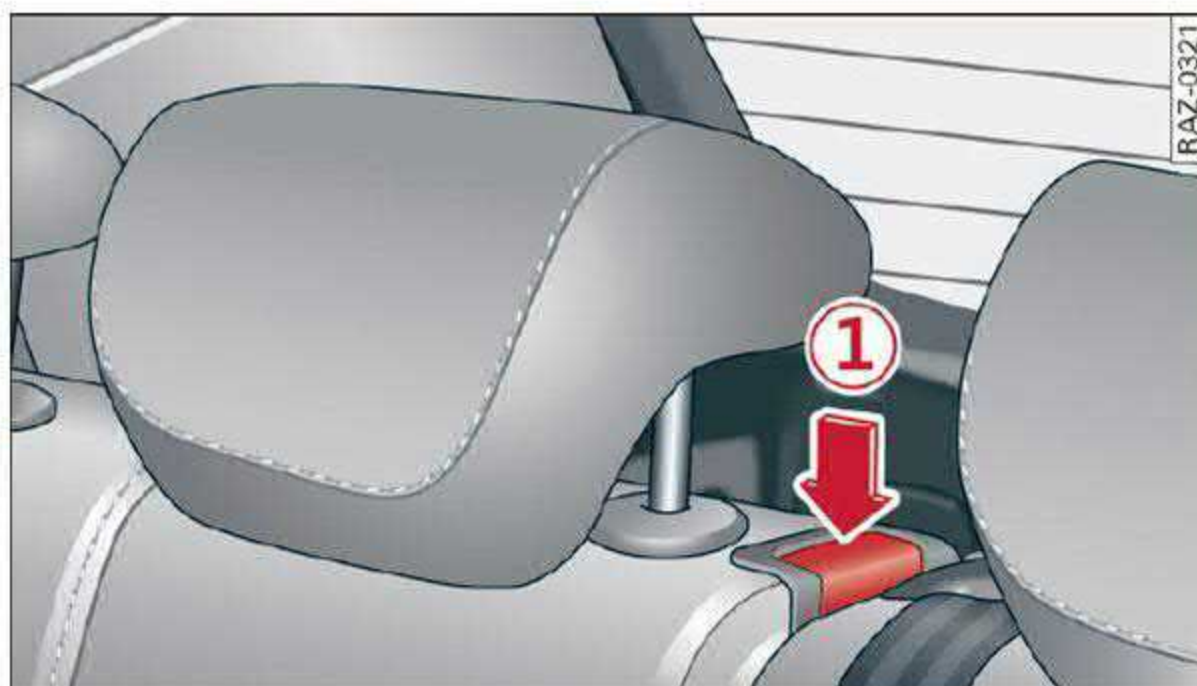

Fig. 72 Center backrest: release button

Observe the safety precautions ⇒ page 75.

- ▶ To fold the center backrest forward, press the release button ①.

- ▶ After the transport, fold the center backrest up until it locks into place.

Tie-downs and cargo net¹⁾



Fig. 73 Luggage compartment: location of the tie-downs

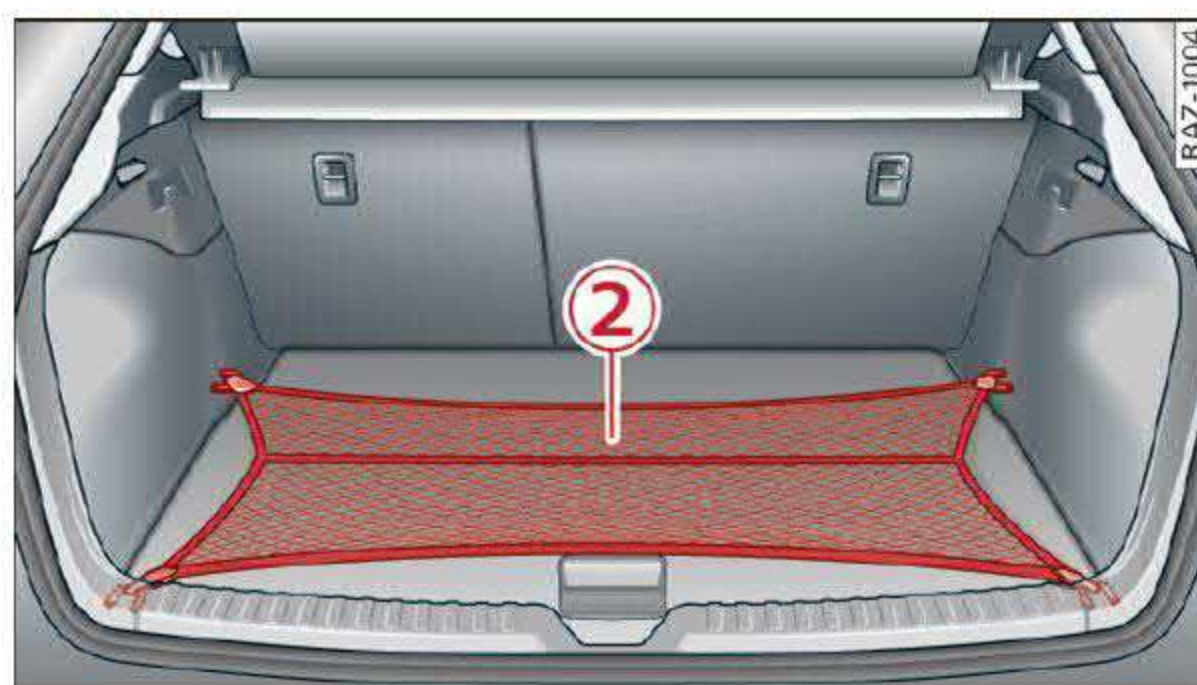

Fig. 74 Luggage compartment: luggage compartment net* stretched out

Observe the safety precautions ⇒ page 75.

Tie-downs

There are tie-downs ① in the luggage compartment to secure pieces of luggage and objects.

- ▶ Use the tie-downs to secure the cargo.

Cargo net¹⁾

Applies to: vehicles with cargo net

Use the cargo net ② to secure lighter objects in the luggage compartment

- ▶ Unfold the bracket for the front tie-downs.
- ▶ Attach the hooks for the cargo net to the tie-downs.

¹⁾ In certain countries.

Double cargo floor

Applies to: vehicles with double cargo floor

Tools or other objects can be transported under the double cargo floor.

- ▶ Lift the cargo floor up using the handle.
- ▶ Lock the cargo floor at the side mounts.
- ▶ Remove the side inserts if necessary.

Lowering the cargo floor

Applies to: vehicles with adjustable cargo floor



Fig. 75 Luggage compartment: lowering the cargo area floor

The cargo floor can lower to expand the storage area in the luggage compartment.

- ▶ To lower the cargo floor, lift it at the handle (1).
- ▶ Pull the cargo floor slightly back and then push it forward again to position (2) or (3).

Roof rack

General information

Applies to: vehicles with roof rack mount

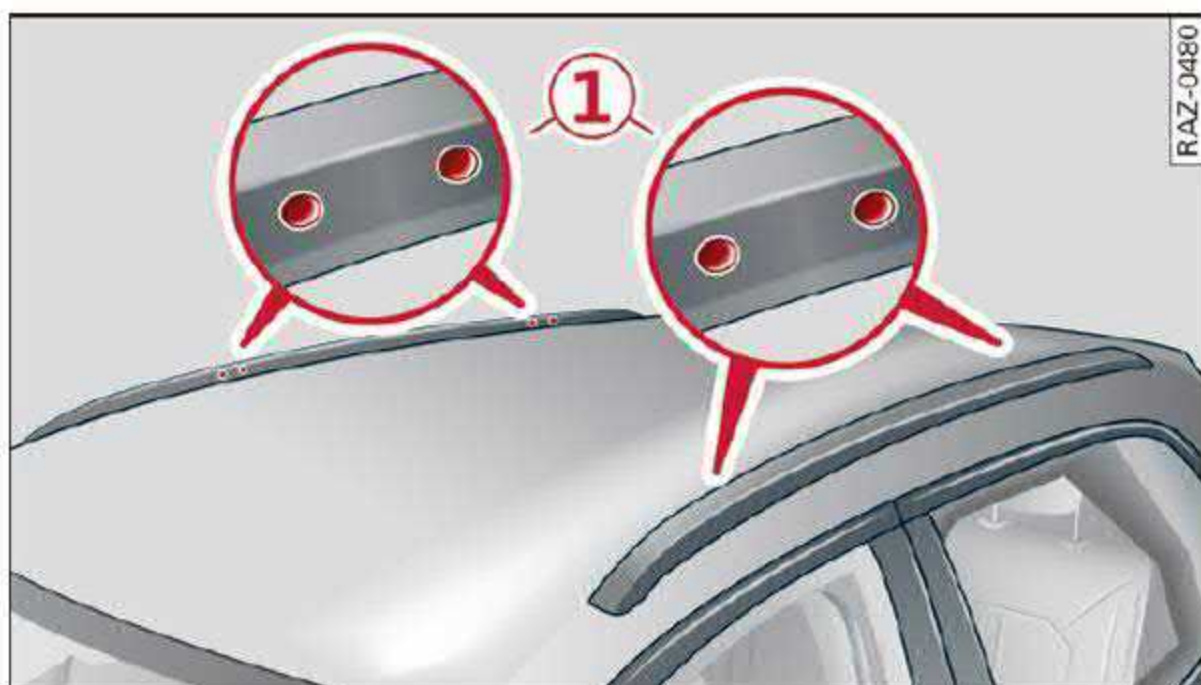

Applies to: vehicles with roof rail
Fig. 76 Roof rail: mounting points

If luggage or cargo is to be carried on the roof, you must observe the following:

- These roof racks are the basis for a complete roof rack system. Only roof racks that are suitable for your vehicle may be used. Audi recommends roof racks and attachments from the Audi Genuine Accessories program.
- Make sure the roof rack is mounted on the vehicle only at the specified locations (1).
- Note the permitted axle load, permitted total weight, and permitted roof load of your vehicle ⇒ page 270. The roof load is the total of the weight of the roof rack, the attachments and the cargo you are carrying. However, you must also note the permitted load of the carrier system being used.

⚠ WARNING

- Follow the installation instructions provided with the roof rack system. If you do not secure the roof rack system and objects on the roof correctly, they could come loose from the vehicle and cause an accident.
- The risk of an accident increases when using a roof rack system, because it changes the driving characteristics by shifting the center of gravity and/or the increasing the surface area exposed to wind. You may need to adapt your driving style and speed to the current conditions.

ⓘ Note

Make sure that the luggage compartment lid and the panoramic glass roof do not come into contact with objects on the roof when they are open.

🌳 For the sake of the environment

Energy usage will increase because of the increased wind resistance. Remove the roof rack when you are no longer using it.

Warm and cold

Climate control system

Description

One of the following options may be available, depending on vehicle equipment:

- A deluxe automatic climate control system with 2 zones to individually adjust the temperature and air distribution for the left and right front sides¹⁾
- A deluxe automatic climate control system with 3 zones where the temperature and air distribution can be set separately on the left front side, the right front side, and in the rear

The climate control system warms, cools, dehumidifies, and filters the air in the vehicle interior. It is the most effective when the windows and panoramic glass roof* are closed. If there is a build-up of heat inside the vehicle, ventilation can help to speed up the cooling process.

The deluxe climate control system automatically maintains a temperature once it has been set. In all heating mode functions except defrost, the blower only switches to a higher speed once the coolant has reached a certain temperature.

Pollutant filter

The pollutant filter removes pollutants such as dust and pollen from the air.

WARNING

- You should not use the recirculation mode for an extended period of time, because no fresh air is drawn in and the windows can fog when cooling mode is switched off. This increases the risk of an accident.

- Individuals with reduced sensitivity to pain or temperature could develop burns when using the seat heating* function. To reduce the risk of injury, these individuals should not use seat heating*.

Note

To reduce the risk of damage to the seat heating* elements, do not kneel on the seats or place heavy pressure on one area of the seat.

For the sake of the environment

Energy can be saved by switching off the A/C mode.

Tips

- To prevent interference with the heating or cooling output and to prevent the windows from fogging over, the air intake in front of the windshield must be free of ice, snow, and leaves.
- Condensation from the cooling system can drip and form a puddle of water under the vehicle. This is normal and does not mean there is a leak.
- The energy management system may temporarily switch off certain functions, such as the seat heating* or rear window defogger. These systems are available again as soon as the energy supply has been restored.
- If the front passenger's seat heating* is turned on, it will not turn on again automatically if more than 10 minutes have passed between switching the ignition off and on again.

¹⁾ In certain countries.

Deluxe automatic climate control with 2 zones¹⁾/3 zones

Operation

Applies to: vehicles with 2-zone/3-zone deluxe automatic climate control.

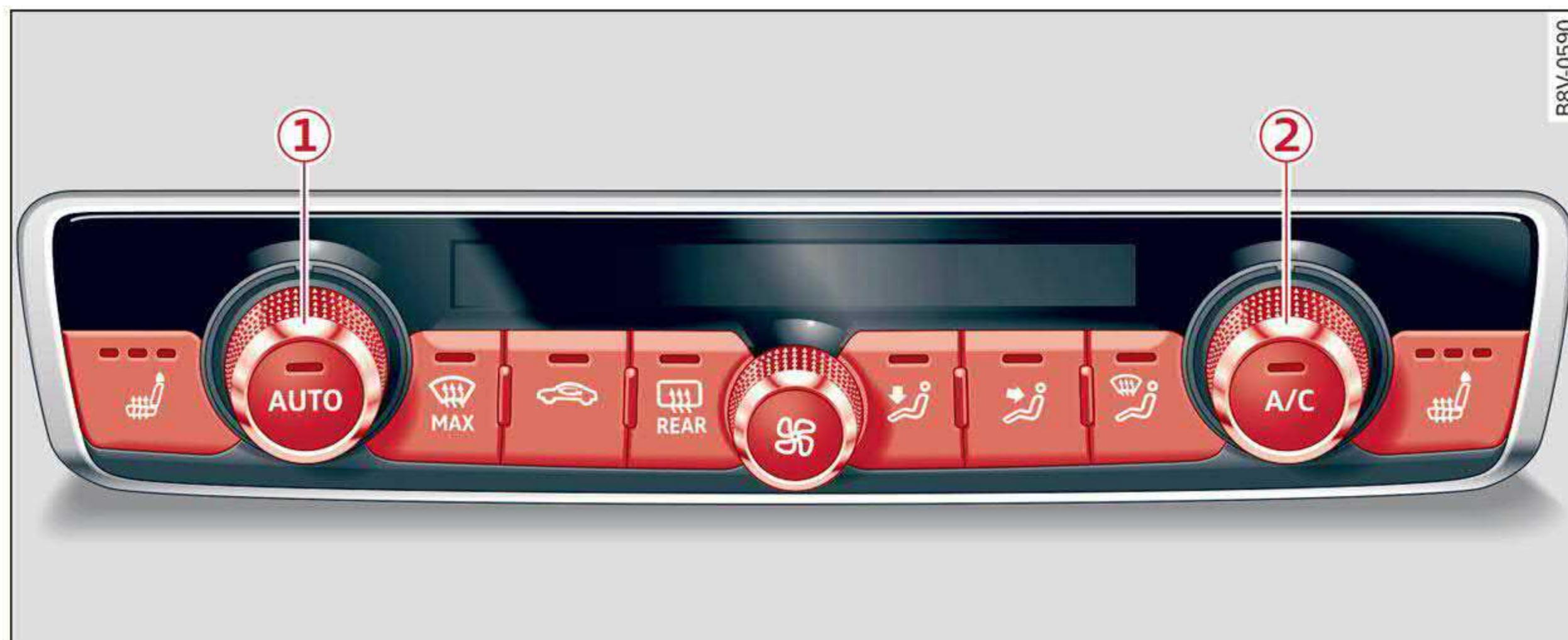

Fig. 77 Deluxe automatic climate control with 2 zones/3 zones: controls

The functions can be switched on and off by pressing the buttons or adjusted by turning the knob. When the function is switched on, the LED in the respective button or knob turns on.

Observe the safety precautions ⇒ page 79.

AUTO Automatic mode

Automatic mode maintains a constant temperature inside the vehicle. Air temperature, airflow and air distribution are controlled automatically. AUTO mode switches off once a button in the climate control system is pressed.

A/C Cooling mode

The cooling mode only functions with the blower turned on. The cooling system is turned on and off with the **A/C** button. The air is not cooled and humidity is not reduced when cooling mode is switched off. This can cause fog on the windows. The cooling mode switches off automatically at low outside temperatures.

Temperature

The temperature for the driver's and front passenger's side can be adjusted separately with the

dials ①/②. Temperatures between 60 °F (+16 °C) and 84 °F (+28 °C) can be set. If outside of this range, **LO** or **HI** will appear in the control panel display. In both settings, the climate control runs constantly at the maximum cooling or heating level. The temperature is not regulated.

Synchronization: pressing and holding the **AUTO** button for two seconds transfers the temperature setting on the driver's side to the front passenger's side. This applies a temperature change to the front passenger's side.

Blower

You can manually adjust the volume of air generated by the blower to your preference using the knob . The blower should always run at a low setting to prevent the windows from fogging and to ensure a continuous exchange of air inside the vehicle. To have the blower regulated automatically, press the **AUTO** button. If the windows are foggy, press the **MAX** button. ▶

¹⁾ In certain countries.

Air distribution

The air distribution can be adjusted with the buttons. To have the air distribution regulated automatically, press the **AUTO** button.



Defrosting

The windshield and side windows are defrosted or cleared of condensation as quickly as possible. The maximum amount of air flows mainly from the vents below the windshield. Recirculation mode switches off. The temperature should be set at 72 °F (+22 °C) or higher. The temperature is controlled automatically. Depending on the outside temperature, the A/C cooling mode may automatically switch on.

The **AUTO** button switches the defroster off.

Recirculation mode

In recirculation mode, the air inside the vehicle is circulated and filtered. This prevents the unfiltered air outside the vehicle from entering the vehicle interior ⇒  in *Description on page 79*.

Pressing the  button switches recirculation mode on or off manually. You can also switch the recirculation mode off by pressing the **AUTO** or  buttons.

Rear window defogger

The rear window defogger only operates when the engine is running. It switches off automatically after 10 to 20 minutes, depending on the outside temperature.



To prevent the rear window defogger from switching off automatically, press and hold the  button for more than two seconds. This is stored until the ignition is switched off.

Vents

You can open or close the center and rear vents in the cockpit and the vents in the rear center console using the ridged thumbwheels. The levers adjust the direction of the airflow from the vents.

Air vents are located under the front seats and on the end of the center console to heat or cool the rear of the vehicle.

Seat heating*

The seat heating temperature can be set at multiple levels. Press the  button once to switch on the highest level. Press the  button again to decrease the heat output one level at a time. The seat heating is off when all of the LEDs are off.

Operation in the rear of the vehicle

Applies to: vehicles with 3-zone deluxe automatic climate control system

Air vents are located under the front seats and on the end of the center console to heat or cool the rear of the vehicle. You can adjust the amount of air and the temperature using the thumbwheels.

Additional settings

Applies to: vehicles with 2-zone/3-zone deluxe automatic climate control

You can adjust additional settings.

- ▶ Applies to MMI: Select on the home screen: **VEHICLE > Air conditioning**.

Auto recirculation

When switched on, automatic recirculation controls the recirculation mode automatically. You must press the  button if fog forms on the windows.

Steering wheel heating

Switching on and off

Applies to: vehicles with steering wheel heating

- ▶ Press the  button on the multifunction steering wheel to switch the steering wheel heating on and off.

Messages

Applies to: vehicles with steering wheel heating

Steering wheel heating: on / Steering wheel heating: off

This message appears if you switched the steering wheel heating on or off by pressing the button on the multifunction steering wheel.







Steering wheel heating: malfunction! See owner's manual ▶

If this message appears, there is a malfunction. Drive immediately to an authorized Audi dealer or authorized Audi Service Facility to have the malfunction repaired.

Fluids in the A/C system

Refrigerant in the A/C system

The sticker in the engine compartment provides information about the type and amount of refrigerant used in the vehicle's A/C system. The sticker is located in the front section of the engine compartment or at the front or back of the hood.

Symbol	Meaning
	Warning: the A/C system must only be serviced by qualified technicians.
	Refrigerant type
	Lubricant type
	Refer to the service information (only available for authorized Audi dealers or authorized Audi Service Facilities)
	The A/C system must only be serviced by qualified technicians.
	Flammable refrigerant
	Make sure all components are disposed of correctly and never install components in the vehicle that have been removed from old vehicles or taken from recycling.

Lubricant in the A/C system

The sticker in the engine compartment provides information about the type and amount of refrigerant oil used in the vehicle's A/C system. For the refrigerant oil quantity, refer to the Technical Data ⇒ page 269.

Tips

- Never repair the A/C system evaporator with components from old vehicles or from recycling.
- New replacement evaporators for portable A/C systems must be certified and labeled as such, so that they comply with the SAE standard J2842 HFO-1234yf and R744.

WARNING

To ensure secure and safe operation, the A/C system must only be serviced by qualified technicians and certified technicians (SAE standard J2845).

Driving

Starting the vehicle

Convenience key

Applies to: vehicles with convenience key



Fig. 78 Center console: starting the engine

Requirement: the key must be in the vehicle.

Starting the engine

- ▶ Press and hold the brake pedal.
- ▶ Press the **START ENGINE STOP** button. The engine will start.

Equipment that uses a lot of electricity is switched off temporarily when you start the engine. If the engine does not start immediately, the starting procedure stops automatically after a short time. If this is the case, repeat the starting procedure after approximately 30 seconds.

Stopping the engine

- ▶ Bring the vehicle to a full stop.
- ▶ Press the **START ENGINE STOP** button. The engine will switch off.

Applies to: vehicles with steering lock: The steering is locked when you turn off the engine and open the driver's door. The steering lock helps prevent vehicle theft. "P" must be engaged on vehicles with an automatic transmission.

Stopping the engine in an emergency

If necessary in an emergency, the engine can also be stopped while driving using the emergency off function*.

- ▶ Press the **START ENGINE STOP** button twice in a row or press and hold it one time.

Switching on and off

If you would like to switch the ignition on or off without starting the engine, follow these steps:

- ▶ Press the **START ENGINE STOP** button without pressing the brake pedal.

Switching the ignition off automatically

To prevent the vehicle battery from draining, the ignition and possibly the exterior lighting may switch off automatically.

Requirements:

- The Start/Stop system must have stopped the engine.
- You must have left the vehicle for longer than 30 seconds.
- The ignition must be switched on.

Among other indicators, the system detects that you have left the vehicle based on the following factors:

- The driver's door has been opened.
- The driver's safety belt has been unbuckled.
- The brake pedal is not being pressed.

The ignition will also be switched off if the vehicle is locked from the outside.

Ignition key

Applies to: vehicles with ignition lock



Fig. 79 Steering column: ignition lock

Starting the engine

- ▶ Press the brake pedal.
- ▶ Insert the ignition key into the ignition lock.
- ▶ Turn the key briefly to position ②. The ignition key automatically returns to position ①. Do not press the accelerator pedal when doing this. ▶

- ▶ The engine will start and the vehicle will then be ready to drive.

Equipment that uses a lot of electricity is switched off temporarily when you start the engine. If the engine does not start immediately, stop the starting procedure by turning the ignition key to position ① and repeat after 30 seconds.

If it is difficult to turn the key to position ①, turn the steering wheel back and forth slightly to release the steering lock.

Stopping the engine

- ▶ Bring the vehicle to a full stop.
- ▶ Turn the key to position ①. The engine will switch off.

Activating the steering lock

Applies to: vehicles with steering lock

The steering lock helps prevent vehicle theft.

- ▶ Remove the ignition key.
- ▶ Turn the steering wheel until the steering wheel audibly locks.

Switching the ignition on or off

If you would like to switch the ignition on or off without starting the engine, follow these steps:

- ▶ Switching on: turn the key to position ①.
- ▶ Switching off: turn the key to position ①.

WARNING

Never remove the ignition key from the ignition lock while the vehicle is moving. Otherwise, the steering lock could engage and you would not be able to steer the vehicle, which increases the risk of an accident.

General information

WARNING

- To reduce the risk of asphyxiation, never allow the engine to run in confined spaces.
- Never turn off the engine before the vehicle has come to a complete stop. Switching it off before the vehicle has stopped may impair the function of the brake booster and power steering. You would then need to use

more force to steer and brake the vehicle. The fact that you cannot steer and brake as usual may increase the risk of accidents and serious injuries.

- Always select the “P” selector lever position when parking the vehicle; otherwise, the vehicle could roll away.

Note

- Avoid high engine speed, full throttle, and heavy engine load if the engine has not reached operating temperature yet. You could damage the engine.
- If the engine has been under heavy load for an extended period of time, heat builds up in the engine compartment after the engine is switched off and there is a risk of damaging the engine. For this reason, let the engine run at idle for approximately two minutes before shutting it off.

Tips

- Brief noises are normal when starting and stopping the vehicle and are no cause for concern.
- For up to 10 minutes after stopping the engine, the radiator fan may turn on again automatically or it may continue to run, even if the ignition is switched off.
- It may not be possible to start the vehicle in extremely low temperatures.
- Power will be fully available once the engine is at operating temperature.

Messages

Engine start system: malfunction! Please contact Service

There is a malfunction in the engine start system. Drive immediately to an authorized Audi dealer or authorized Audi Service Facility to have the malfunction repaired.

Remote control key: key not detected. Is the key still in the vehicle?

The vehicle key was removed from the vehicle while the engine is running. If the vehicle key is ▶

no longer in the vehicle, you cannot switch the ignition on or start the engine once you stop it. You also cannot lock the vehicle from the outside.

 **Remote control key: hold back of key against the designated area. See owner's manual**

The battery in the vehicle key may be drained or there may be a malfunction. To start the vehicle, you must also hold the vehicle key against the location shown  ⇒ page 83, fig. 78.

If the malfunction remains, drive immediately to an authorized Audi dealer or authorized Audi Service Facility to have the malfunction corrected.

When driving

Starting to drive, stopping, and parking

Starting from a stop

- ▶ Press and hold the brake pedal.
- ▶ Start the engine.
- ▶ Select a gear.
- ▶ Release the parking brake.
- ▶ Release the brake pedal. The vehicle may roll.
- ▶ Press the accelerator pedal to accelerate.

Stopping and parking

- ▶ Bring the vehicle to a full stop and press and hold the brake pedal.
- ▶ Set the parking brake.
- ▶ Select the "P" selector lever position to secure the vehicle from rolling away.
- ▶ Turn the steering wheel when parking on inclines so that the wheels will roll into the curb if the vehicle starts moving.
- ▶ Switch off the ignition before leaving the vehicle.

On hills, activate the parking brake first and then shift into the "P" selector lever position. This prevents too much stress from being placed on the locking mechanism.

WARNING

- Always set the parking brake when leaving your vehicle, even if for a short period of

time. If the parking brake is not set, the vehicle could roll away, increasing the risk of an accident.

- Do not leave your vehicle unattended while the engine is running, because this increases the risk of an accident.
- If the parking brake is set, it can release automatically when the accelerator pedal is pressed. To reduce the risk of an accident, do not inadvertently press the accelerator pedal and always shift into "P" when the vehicle is stopped.
- If you leave the vehicle, switch the ignition off and take the key with you. This is especially important when leaving persons or animals in the vehicle. Otherwise, the vehicle could start unintentionally, the parking brake could release, or electronic equipment could activate, which increases the risk of an accident.
- No persons or animals should be left in a locked vehicle. Locked doors make it more difficult for emergency workers to enter the vehicle, which puts lives at risk.
- If you do not begin driving immediately after releasing the brake pedal, your vehicle may begin to roll backward. Press the brake pedal or set the parking brake immediately.

Note

If you have to stop on an incline, always press the brake pedal to hold the vehicle in place to reduce the risk of the vehicle rolling backward. Do not try to hold the vehicle in place by pressing and holding the accelerator pedal. The transmission can overheat, which increases the risk of damage.

Hill hold assist

If you take your foot off of the brake pedal when driving on hills, the braking force will be held for several seconds. At that time, you can start driving without the vehicle rolling backward.

Requirement: the driver's door must be closed, the engine must be on, and the vehicle must be traveling uphill. ▶

- ▶ To activate hill hold assist, press and hold the brake pedal for several seconds while the vehicle is stationary.

WARNING

- If you do not begin driving immediately after releasing the brake pedal, your vehicle may begin to roll backward. Press the brake pedal or set the parking brake immediately.
- The hill hold assist cannot hold the vehicle on inclines in every scenario (for example, on slippery or icy ground).

Messages

Hill hold assist: unavailable

The hill hold assist is temporarily unavailable. Press the brake pedal to secure the vehicle from rolling away unintentionally.

Gears and driving programs

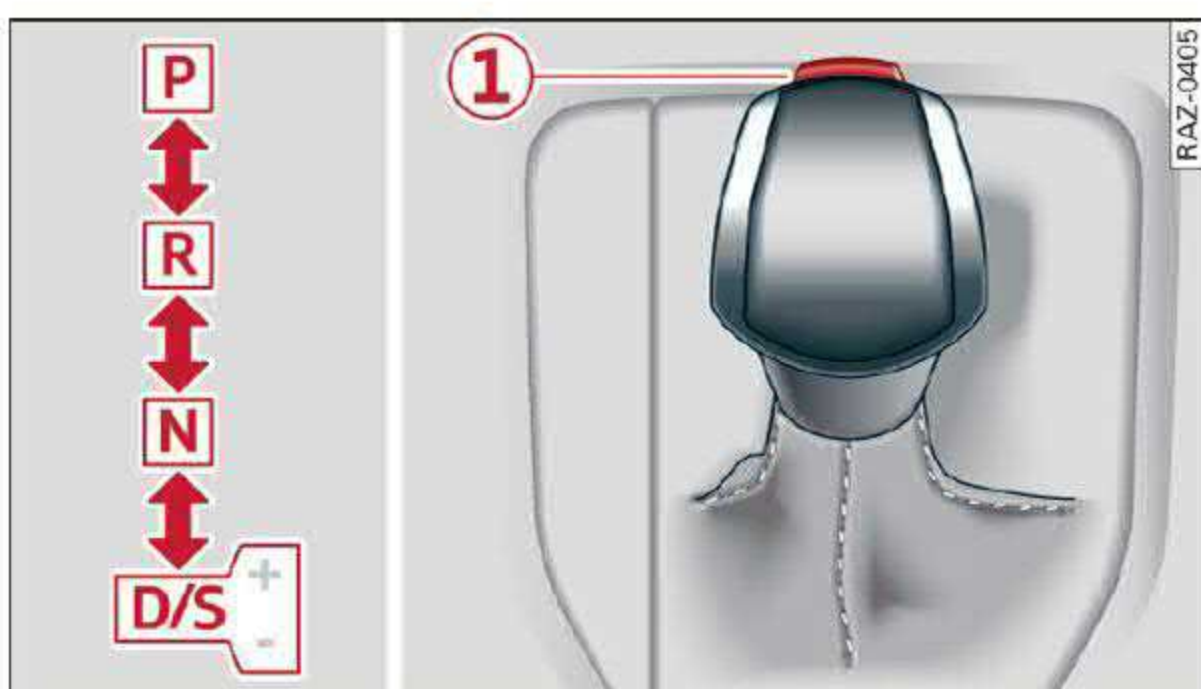

Fig. 80 Center console: selector lever

The automatic transmission shifts automatically depending on the selected gear and the current driving style. When driving with a moderate driving style, upshifting early and downshifting late will help to improve fuel economy. When driving with a sporty driving style, the transmission permits higher RPMs.

The gears are displayed next to the selector lever.

- **P** (Park)
- **R** (Reverse): driving in reverse
- **N** (Neutral): idle
- **D** (Drive)

Selecting a gear

Requirement: the ignition must be switched on.

- Bring the vehicle to a full stop and press the brake pedal.
- Press the release button **1** on the selector lever.
- To select a gear, move the selector lever into the corresponding position.
- The label next to the selector lever for the selected gear will light up.

“N” (Neutral) gear

In the “N” gear, power is not transmitted to the driving wheels. Use the “N” gear in a car wash (with conveyor belts), for example.

If you unintentionally select “N” while driving (faster than 1 mph (2 km/h)), you can also shift back to “D” without pressing the brake pedal.

For safety reasons, the vehicle cannot be locked when the transmission is in the “N” gear.

“P” (Park) gear

The vehicle is secured from rolling away by the parking lock when in the “P” gear.

If you cannot shift out of “P”, for example because the vehicle has no power, you may need to use the emergency release for the parking lock ⇒ [page 88](#).

Selecting a driving program

Various driving programs can be selected when in the “D” gear. The programs influence when the transmission shifts and how the accelerator pedal responds.

The selected driving program is displayed in the instrument cluster.

- **D** (Drive): normal driving mode
- **S** (Sport): sporty driving mode

If you select the **Dynamic** mode in Audi drive select*, the “S” driving program will be activated. When the ignition is switched off, the driving program may be reset to “D”.

To switch between the current driving program and “S”, push the selector lever toward the rear. ▶

! WARNING

- Before you start driving, check if the label for the desired selector lever position next to the selector lever is lit up.
- Always secure your vehicle from rolling away. Press the brake pedal or shift to “P”. When leaving the vehicle, also set the parking brake.
- Power is still transmitted to the wheels when the engine is running at idle. To prevent the vehicle from “creeping”, you must keep your foot on the brake in all selector lever positions (except “P” and “N”) when the engine is running.
- To reduce the risk of an accident, do not press the accelerator pedal when changing gears if the vehicle is stationary and the engine is running.
- Never select the “R” or “P” gears while driving. Doing so could cause an accident.
- The vehicle can roll even if the ignition is switched off.

i Tips

If you shift between “D” and “R” within one second, you do not need to press the brake pedal. This makes it possible to “rock” if it is stuck, for example.

Manual shifting

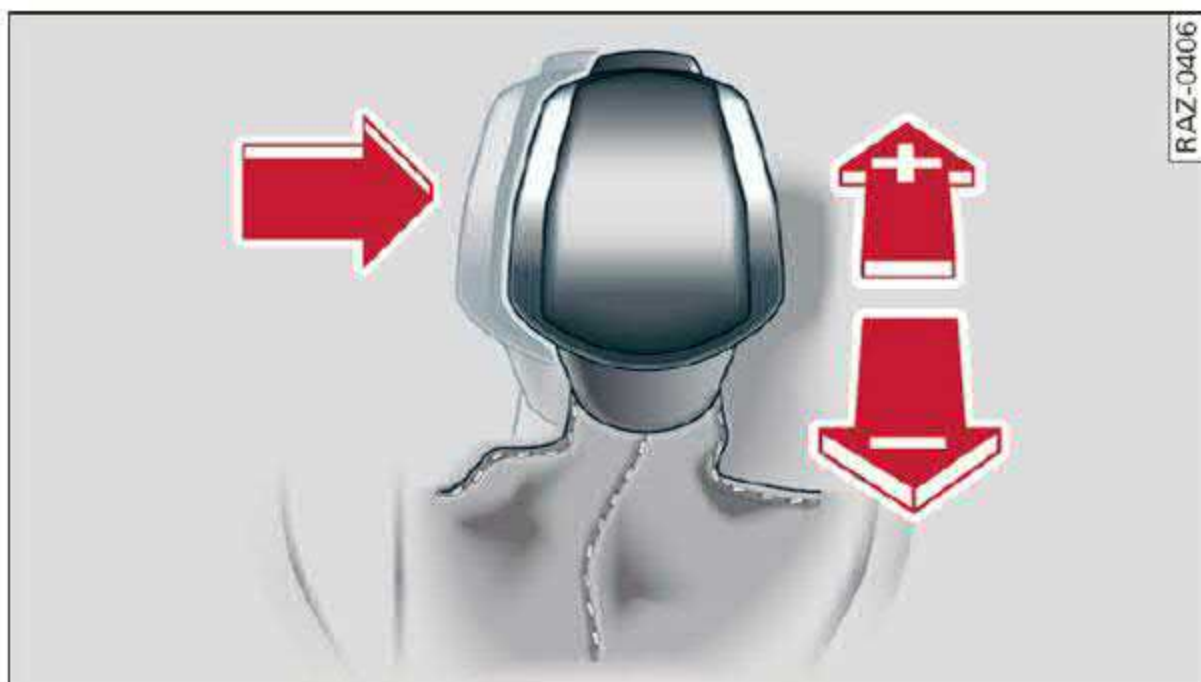

Fig. 81 Center console: shifting manually with the selector lever



Fig. 82 Steering wheel: shift paddles*

You can shift the gears manually when in “D” mode. The transmission must be in tiptronic mode.

Shifting with the selector lever

You can shift into manual shifting mode while the vehicle is stationary or while driving.

- ▶ To switch to manual shifting mode, tilt the selector lever toward the front passenger's side ⇒ *fig. 81*. “M” will be displayed in the instrument cluster.
- ▶ Upshifting: push the selector lever forward (+).
- ▶ Downshifting: push the selector lever toward the rear (-).
- ▶ To switch back to automatic mode, tilt the selector lever toward the driver's side.

Shifting with the shift paddles

Applies to: vehicles with shift paddles

- ▶ Upshifting: press the (+) shift paddle ⇒ *fig. 82*.
- ▶ Downshifting: press the (-) shift paddle.
- ▶ To switch back to automatic mode, press and hold the (+) shift paddle or push the selector lever toward the rear.

If you stop using the shift paddles temporarily, the transmission will switch back to automatic mode. To keep shifting manually, tilt the selector lever toward the front passenger's side.

i Tips

- The transmission only allows manual shifting when the engine speed is within the permitted range.
- The transmission automatically shifts up or down before critical engine speed is reached.

Accelerator pedal

You can accelerate the vehicle using the accelerator pedal. If you press the accelerator pedal all the way down, the engine's full power will be used and you will reach maximum acceleration, also called "kick-down".

WARNING

The driving wheels could spin and the vehicle could swerve on slick or slippery road surfaces when using kick-down, which increases the risk of an accident.

Manually releasing the parking lock



Fig. 83 Selector lever: removing the shifter boot

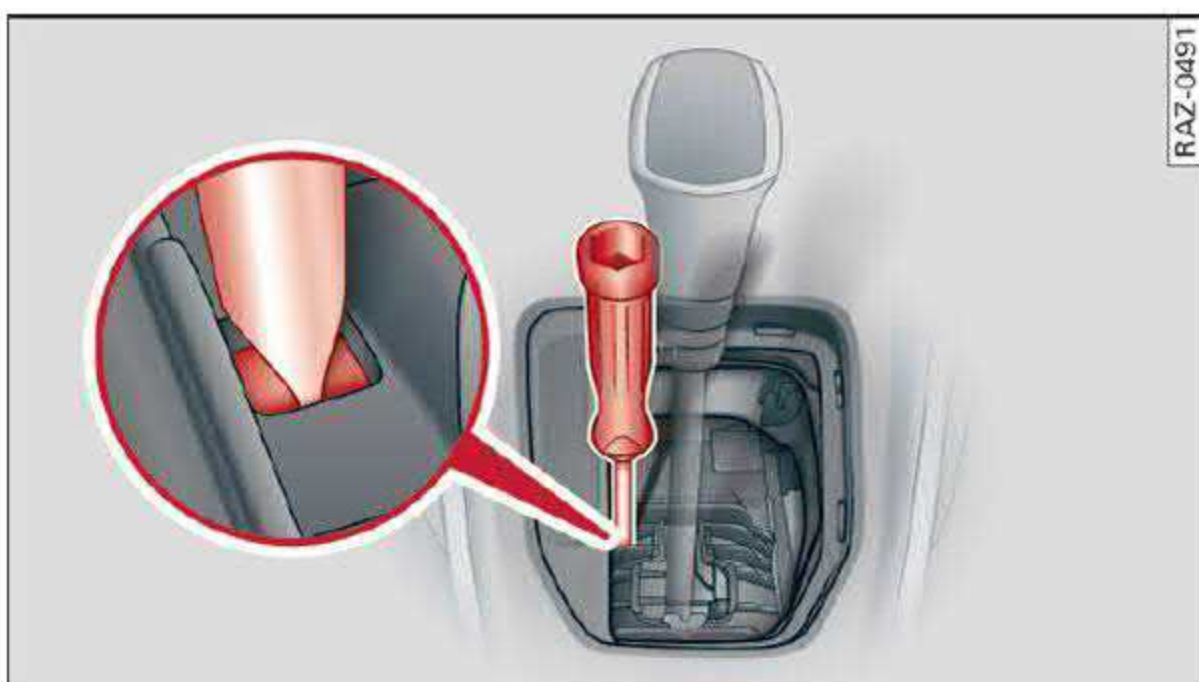

Fig. 84 Selector lever: releasing the parking lock using the emergency release

The emergency release is located under the selector lever shift gate on the left side. Using the emergency release can be complicated. See an authorized Audi dealer or authorized Audi Service Facility for assistance.

You will need the screwdriver from the vehicle tool kit to release it ⇒ *page 248*. Use the flat side of the reversible screwdriver blade.

Removing the shifter boot

- ▶ Set the parking brake to secure your vehicle from rolling away. If this is not possible, secure your vehicle from rolling using another method.
- ▶ Switch the ignition off.
- ▶ To loosen the shifter boot, carefully insert the flat side of the screwdriver sideways into the slit near the shifter boot ⇒ *fig. 83*.
- ▶ Carefully pry the shifter boot out with the screwdriver while gripping the boot at the fold with your hand and pulling it upward and out until all four corners are released ⇒ *fig. 84*.
- ▶ Fold the shifter boot up around the shifter knob.

Releasing the parking lock using the emergency release

- ▶ Use the screwdriver to press the yellow release button downward.
- ▶ At the same time, press the unlock button on the selector lever and move the selector lever to the "N" position.

Attaching the shift cover

- ▶ Clip the shift cover back into the shift gate.

WARNING

- The parking lock may only be released using the emergency release if the parking brake is set. If it is not working, secure the vehicle from rolling using the brake pedal or other suitable means, such as blocking a front and a rear wheel. An unsecured vehicle may roll, which increases the risk of an accident.
- Only activate the emergency release while on a level surface or a slight slope.
- To reduce the risk of an accident, you must not drive when the emergency release is activated.

Messages

Transmission: malfunction! Safely stop vehicle

Do not continue driving. Stop the vehicle as soon as possible in a safe location and secure it so it

does not roll. See an authorized Audi dealer or authorized Audi Service Facility for assistance.

Transmission: too hot. Please stop vehicle

Do not continue driving. Select "P" and contact an authorized Audi dealer or authorized Audi Service Facility for assistance.

Transmission: too hot. Please adapt driving style

The transmission temperature has increased significantly. Drive very cautiously or take a break from driving until the temperature returns to the normal range and the indicator light turns off.

Transmission: malfunction! You can continue driving. See owner's manual

There is a system malfunction in the transmission. You may continue driving. Drive to an authorized Audi dealer or authorized Audi Service Facility soon to have the malfunction corrected.

Transmission: malfunction! You can continue driving with limited function. Please contact Service

There is a system malfunction in the transmission. The transmission is switching to emergency mode. This mode only shifts into certain gears or may no longer shift at all. The engine may stall. Drive to an authorized Audi dealer or authorized Audi Service Facility immediately to have the malfunction corrected.

Transmission: malfunction! You can continue driving with limited function. No reverse gear

There is a system malfunction in the transmission. The transmission is switching to emergency mode. This mode only shifts into certain gears or may no longer shift at all. The engine may stall. You cannot engage the reverse gear. Drive to an authorized Audi dealer or authorized Audi Service Facility immediately to have the malfunction corrected.

Transmission: malfunction! You can continue driving in D until engine is off

There is a system malfunction in the transmission. The transmission is switching to emergency

mode. If you turn the engine off, you will not be able to select any other gears after restarting the engine. Drive to an authorized Audi dealer or authorized Audi Service Facility immediately to have the malfunction corrected.

Danger of rolling away! P not possible. Please apply parking brake

- The parking lock was released using the emergency release ⇒ *page 88*. Or
- The parking lock can no longer be engaged. Drive to an authorized Audi dealer or authorized Audi Service Facility immediately to have the malfunction corrected.

Clutch: malfunction! Please contact service

There is an ongoing malfunction in the clutch. The engine torque that can be transferred is reduced. You may continue driving. Avoid using the clutch in any way that will place a heavy load on it. Do not let the clutch rub for a long time. Drive immediately to an authorized Audi dealer or authorized Audi Service Facility to have the malfunction repaired.

Clutch: temperature too high. Adapt driving style

There is a malfunction in the clutch. The engine torque that can be transferred is reduced. You may continue driving. Avoid using the clutch in the future in any way that will place a heavy load on it. Do not let the clutch rub for a long time. The indicator light turns off once the clutch is fully operable again.

Clutch: check pedal. You can continue driving

The clutch is not transferring all of the engine torque. If necessary, remove your foot from the clutch pedal.

Drive system

Breaking in

A new vehicle must be broken in within the first 1,000 miles (1,500 km) so that all moving parts work smoothly together, which helps to increase ►

the service life of the engine and other drive components.

Do not drive higher than two-thirds of the maximum permitted engine RPM during the first 600 miles (1,000 km) and do not use full acceleration. The engine can be increased RPM gradually during the next 300 miles (500 km).

Efficient and environmentally-friendly driving

Your driving style greatly influences the amount of fuel and energy consumed, the environmental impact, and the wear on the engine, brakes, and tires. Note the following information for efficient and environmentally-conscious driving:

- Turn off electrical equipment that is not needed, for example seat heating*.
- Anticipate upcoming traffic situations while driving to avoid unnecessary acceleration and braking.
- Avoid driving at high speeds.
- Avoid adding extra weight to the vehicle if possible, for example by not leaving roof racks or bike racks installed when they are not needed.
- Make sure the tire pressure is correct.
- Have maintenance performed regularly on the vehicle.
- Do not let the engine run while the vehicle parked.
- Do not drive with winter tires during the summer.
- Use the Start/Stop system.
- Utilize the engine braking effect.
- Avoid driving short distances when possible.

Tips

The amount of noise produced by the vehicle can increase significantly when driving with a sporty style. Show respect to others around you and the environment with the way you operate your vehicle, especially at night.

Energy management

Your vehicle is equipped with an intelligent energy management system for distributing electrici-

ty. This significantly improves the starting ability and increases the vehicle battery life.

Tips

- If you drive short distances frequently, the vehicle battery may not charge enough while driving. As a result, convenience functions for electrical equipment may be temporarily unavailable.
- The vehicle battery will gradually drain if the vehicle is not driven for long periods of time, or if electrical equipment is used when the engine is not running. To ensure that the vehicle can still be started, the electrical equipment will be limited or switched off.

Messages

Drive system: malfunction! Safely stop vehicle

There is a malfunction in the drive system. The brake booster and the power steering may stop working. Stop the vehicle immediately or as soon as possible and do not continue driving. Have the problem corrected by an authorized Audi dealer or authorized Audi Service Facility.

Drive system: malfunction! Please contact Service

There is a malfunction in the drive system. Drive slowly to an authorized Audi dealer or authorized Audi Service Facility to have the malfunction corrected.

Start/Stop system

Description

Applies to: vehicles with Start/Stop system

The Start/Stop system can help increase fuel economy and reduce CO₂ emissions.

In Start/Stop mode, the engine shuts off automatically when stopped, for example at a traffic light. If certain conditions are met, the engine may stop before the vehicle has come to a complete stop. If you press the accelerator pedal

when this happens, the engine will start and driving power will be transmitted.

The ignition and important assist systems such as the brake booster will remain available during the Stop phase. The engine will restart automatically when needed.

The Start/Stop system is automatically activated once the ignition is switched on.

Basic requirements

- The driver's door and hood must be closed.
- "P", "N", or "D" must be engaged.
- The steering wheel must not be turned far in either direction.
- The vehicle must have driven faster than 2 mph (3 km/h) since the last time it stopped.
- The vehicle is not in trailer mode.

Note

Always switch the Start/Stop system off when driving through water ⇒ page 92.

Tips

- Depending on the driving situation, the engine may already stop when **coasting** before the vehicle has come to a complete stop.
- If you select the "D" position after shifting into reverse, the vehicle must be driven faster than 6 mph (10 km/h) in order for the Start/Stop system to become active again. This makes it possible to maneuver without stopping the engine.

Stopping and starting the engine

Applies to: vehicles with Start/Stop system

- ▶ Press and hold the brake pedal until the vehicle has stopped. The  indicator light appears in the instrument cluster once the engine stops automatically.
- ▶ The engine starts again when you remove your foot from the brake pedal. The indicator light turns off.

If the parking brake is set, the engine will only start again when the accelerator pedal is pressed.

Tips

- Press the brake pedal during a Stop phase to keep the vehicle from rolling.
- The ignition will turn off if you press the **START ENGINE STOP** button during a Stop phase.
- If you leave the vehicle briefly during a Stop phase and then enter again, the driver's door must be closed and the safety belt must be fastened in order for the engine to be able to restart.
- You can control if the engine will stop or not by reducing or increasing the amount of force you use to press the brake pedal. For example, if you only lightly press on the brake pedal in stop-and-go traffic or when turning, the engine will not switch off when the vehicle is stationary. If you press the brake pedal harder, the engine will switch off.

Starting and stopping the engine automatically

Applies to: vehicles with Start/Stop system

The system checks if certain conditions are met before and during the Stop phase, and determines if the engine stops and how long it remains stopped. For example, if power usage is high, the engine will not be stopped. Along with other conditions, the following factors influence the automatic engine start or stop:

- Environmental conditions (slopes, inclines, elevation, temperature)
- Battery (charge status, temperature, power usage)
- Engine temperature
- Assist systems
- Driving behavior

Depending on the engine, the  indicator light may appear if the engine is not stopped.

Manually switching the Start/Stop system off and on

Applies to: vehicles with Start/Stop system

The  button is located above the selector lever in the center console.

- ▶ Press  to switch the system on or off. The LED in the button turns on when the function is switched off.

Tips

If you switch the system off during a Stop phase, the engine will start again automatically.

Messages

Applies to: vehicles with Start/Stop system

Drive system: please start the vehicle manually

This message appears when specific conditions are not met during a Stop phase. The Start/Stop system will not be able to restart the engine. The engine must be started with the  button.

Vehicle starting system: malfunction! Please contact Service

There is a malfunction in the Start/Stop system. Drive the vehicle to an authorized Audi dealer or authorized Service Facility as soon as possible to have the malfunction corrected.

Brakes

General information

You can apply the vehicle's brakes using the brake pedal.

Operating noise

Noises may occur when braking depending on the speed, braking force, and outside conditions such as temperature and humidity.

Braking effect

The response time from the brakes depends on the weather and environmental conditions. To ensure the optimal braking effect, the brake system is cleaned at regular intervals. This is done

by applying the brake pads to the brake rotors for a short period of time when driving at high speeds when the windshield wipers are switched on.

If the brake system becomes damp, for example after driving in heavy rain, the braking effect may be delayed. Other factors that could temporarily increase the response time of the brakes include:

- Wet conditions
- Low temperatures, ice, and snow
- Roads covered in salt
- Dirty brake pads

Corrosion

Corrosion may form on the brake rotors if there is no heavy braking, if the vehicle is not driven for long periods of time, or if the vehicle is not driven frequently or for long distances. In this case, braking heavily several times while driving at high speeds can clean the brake rotors ⇒ .

Brake pads

New brake pads do not achieve their full braking effect during the first 250 miles (400 km). They must be “broken in” first. However, you can compensate for the slightly reduced braking force by pressing firmly on the brake pedal. Avoid heavy braking during the break-in period.

Brake pad wear depends largely on the way the vehicle is driven and on operating conditions. Brake pad wear increases when driving frequently in the city or short distances or when using a very sporty driving style.

Ceramic brakes

Applies to: vehicles with ceramic brakes

Ceramic brakes provide excellent deceleration rates.

The break-in period for new ceramic brakes may be significantly longer than for standard brake rotors. Due to the properties of the material, they may cause noises at lower speeds. Ceramic brakes also absorb more moisture in wet conditions. Therefore, there will temporarily be less braking force than when the brakes are dry. You can compensate for this by pressing the brake pedal harder. ▶

 **WARNING**



- Only apply the brakes for the purpose of cleaning the brake system when road and traffic conditions permit. You must not endanger other road users and increase the risk of an accident.
- Due to the risk of injury, only have an authorized Audi dealer or authorized Audi Service Facility work on the brake system. Incorrect repairs could impair the function.
- Never let the vehicle roll while the engine is stopped because this increases the risk of an accident.
- During automatic braking maneuvers, the brake pedal may move downward automatically. To reduce the risk of injury, do not place your foot under the brake pedal.

 **Note**

- Never let the brakes “rub” by pressing the pedal lightly when braking is not actually necessary. This can cause the brakes to overheat and increases braking distance and causes wear.
- Observe the important information for driving downhill ⇒ *page 95*. This especially applies when towing a trailer.

 **Tips**

- In vehicles with an electromechanical brake booster, the resistance in the brake pedal may vary depending on the driving situation (such as if driver assistance system are active).
- If you retrofit your vehicle with a front spoiler, wheel covers or similar items, make sure that the air flow to the brakes is not obstructed. Otherwise the brake system can overheat.
- Also refer to the information about brake fluid ⇒ *page 218*.

There is a malfunction in the brake system. If  /  and  also turn on, there is a malfunction in the ABS, ESC, and braking distribution. If the brake booster is not working, you have to use much more force when braking the vehicle.

Do not continue driving. See an authorized Audi dealer or authorized Audi Service Facility for assistance. Read and follow the other safety precautions ⇒ .

BRAKE /  **Warning! No brake booster function**

If the brake booster is not working, you have to use much more force when braking the vehicle. See an authorized Audi dealer or authorized Audi Service Facility for assistance.

BRAKE /  **Brake pads: wear limit reached. You can continue driving. Please contact Service**

The brake pads are worn. Drive to an authorized Audi dealer or authorized Audi Service Facility as soon as possible to have the malfunction corrected.

Brake booster: limited functionality. You can continue driving. Please contact Service

Brake booster: limited functionality. You can continue driving. Please contact Service

If one of these two messages appears, the brake booster is limited or not available.

- If the message appears while the vehicle is stationary with the ignition switched off, there is **no** malfunction. The brake booster will be fully functional when the ignition is switched on. If you would like to exit the vehicle, secure the vehicle from rolling by selecting “P” and setting the parking brake.
- If the message appears while the vehicle is stationary with the ignition switched on, there is a malfunction. Secure the vehicle from rolling by selecting “P” and setting the parking brake. Remove your foot from the brake pedal. Switch the ignition off and back on. If the message still appears or it appears while driving, drive ►

Messages

BRAKE /  **Brakes: malfunction! Stop vehicle safely**

immediately to an authorized Audi dealer or authorized Audi Service Facility to have the malfunction corrected. The brake booster is available, but its effectiveness is reduced. The braking performance may be different compared to the usual performance.

Other indicator lights

When you switch the ignition on, the **BRAKE** /  indicator light turns on briefly to check the function. If the indicator light does not turn on, there is a system malfunction.

If **BRAKE** /  stays on, there is a malfunction in the brake system.

WARNING

If a malfunction occurs in the ABS, ESC, and braking distribution, interventions that stabilize the vehicle will no longer be available. This could cause the vehicle to swerve, which increases the risk that the vehicle will slide. Do not continue driving. See an authorized Audi dealer or authorized Audi Service Facility for assistance.



Electromechanical parking brake

Operating the parking brake

The electromechanical parking brake is used to secure the vehicle from rolling away unintentionally.

The  switch is located under the selector lever in the center console. It turns on when the parking brake is set. You can release the parking brake manually or automatically when you start to drive.

Setting and releasing the parking brake

- ▶ Setting: pull the .
- ▶ If **PARK** /  appears, the parking brake is holding the vehicle. You can remove your foot from the brake pedal.
- ▶ Releasing: when the ignition is switched on, press and hold the brake pedal and press the  button.

If the red indicator light flashes, the braking force has not built up enough or it has decreased. You can also secure the vehicle by selecting the "P" gear or pressing the brake pedal. Make sure the indicator light is off before you start driving.

Automatically releasing the parking brake when starting to drive

Requirement: the driver's door must be closed and the driver's safety belt must be fastened.

- ▶ Press the accelerator pedal to start to drive.

WARNING

- To reduce the risk of an accident, always make sure the vehicle is situated safely while stationary.
- If the parking brake is set, it can release automatically when the accelerator pedal is pressed. To reduce the risk of an accident, do not inadvertently press the accelerator pedal and always shift into "P" when the vehicle is stopped.
- If the power supply fails, you cannot set the parking brake once it is released, or release it if it is set. In this case, park the vehicle on level ground and secure it by engaging the "P" gear. Contact an authorized Audi dealer or authorized Audi Service Facility for assistance.

Tips

- On steep inclines, especially when in trailer mode, the vehicle may roll backwards unintentionally when starting to drive. To reduce the risk of this happening, pull and hold the  switch while pressing the accelerator pedal. If enough drive power has built up at the wheels and the vehicle does not roll backwards, then release the switch to start to drive.
- If you leave the vehicle when "D" or "R" are engaged, the parking brake will be set automatically.
- Noises when the parking brake is set and released are normal and are not a cause for concern.

- The parking brake goes through a self-test cycle at regular intervals when the vehicle is stopped. Any noises associated with this are normal.

Emergency braking function

Emergency braking should only be used in an emergency, if the standard brake pedal is malfunctioning or obstructed. When the emergency braking function is activated, the braking effect is similar to a heavy braking maneuver.

- ▶ Pull and hold the (P) switch while driving.
- ▶ An audio warning signal will sound and emergency braking will begin.
- ▶ If you press the accelerator pedal, emergency braking will be canceled.

WARNING

Heavy braking while driving through curves or in poor road or weather conditions can cause the vehicle to slide or the rear of the vehicle to swerve, which increases the risk of an accident.

Messages

BRAKE /  **Parking brake: malfunction! Safely stop vehicle. See owner's manual**

There is a malfunction in the parking brake. If the message appears while stationary, check if the parking brake is released and can be reset. If this is the case, switch the ignition off and back on.

If the message continues to appear, if the parking brake cannot be released, or if the message appears while driving, then stop the vehicle on level ground and shift to “P”. Do not continue driving. See an authorized Audi dealer or authorized Audi Service Facility for assistance.

BRAKE /  **Parking brake: malfunction! Please release parking brake**

There is a malfunction in the parking brake. If the message appears while stationary, check if the parking brake is released and can be reset. If this is the case, switch the ignition off and back on.

If the message continues to appear, if the parking brake cannot be released, or if the message appears while driving, then stop the vehicle on level ground and shift to “P”. Do not continue driving. See an authorized Audi dealer or authorized Audi Service Facility for assistance.

 **Parking brake: malfunction! Please contact Service**

There is a malfunction in the parking brake. Drive to an authorized Audi dealer or authorized Audi Service Facility immediately to have the malfunction corrected. Do not park the vehicle on inclines and shift to “P”.

 /  **Parking brake: warning! Vehicle parked too steep**

The braking force may not be enough to secure the vehicle from rolling away. Park the vehicle in a place with less of an incline.

 /  **Parking brake: applied**

The parking brake is set. Press and hold the brake pedal to release the parking brake.

Special driving situations

Driving uphill and downhill

When driving uphill, downhill, or at high altitudes, note the following information:

- Drive slowly and carefully.
- Do not try to turn around if you cannot safely drive on an incline or hill. Instead, drive in reverse.
- When driving down hills, you can activate the hill descent control if you press the brake pedal while driving in “D” gear. The automatic transmission will select a gear suitable for driving down the hill and will attempt to maintain the speed at which the vehicle was traveling at the time the brake pedal was pressed. Press the brake pedal if necessary. The hill descent control will switch off once the hill levels out or you press the accelerator pedal.
- Utilize the engine braking effect when driving downhill by selecting the “S” driving program ⇒ *page 86*. This especially applies when towing a trailer. This reduces the load on the brakes. ▶

- Apply the brakes in intervals and do not press the brake pedal continuously.
- Use the hill descent assist if necessary
⇒ *page 96*

WARNING

- Only drive on inclines that your vehicle is designed to handle. Do not exceed the hill climbing ability of your vehicle. Your vehicle could tip or slide.
- Do not drive at an angle on steep inclines and hills. If your vehicle is about to tip, you must immediately start steering in the direction of the downward slope to reduce the risk of an accident.
- Always be ready to brake when using the hill descent control function.

Offroad driving

Your vehicle is not an offroad vehicle. Note the following points when driving offroad:

- Drive slowly and carefully.
- To reduce the risk of underbody damage, pay attention to the vehicle's ground clearance and drive across raised areas of the ground with the wheels on one side of the vehicle, instead of allowing the center of the vehicle to pass over the raised areas.
- To reduce the risk of becoming stuck, drive through sandy or swampy areas at a steady speed and without stopping, if possible.

If necessary, use the following functions:

- Audi drive select* **Offroad** mode ⇒ *page 98*
- Hill hold assist* ⇒ *page 96*
- Limit ESC ⇒ *page 101*

WARNING

Only drive in terrain that is suitable for the vehicle and your driving ability.

For the sake of the environment

Avoid actions that are damaging to the environment. Show respect for the natural environment and remain on marked routes.

Tips

Clean your vehicle after driving offroad. Dirt and stones falling off your vehicle can affect other road users.

Driving through water

If you must drive through water, follow these instructions:

- Check the stability of the ground, the current, and the water depth. If the ground is unstable, there is a strong current, or there are waves, the water must only reach **up to the lower edge of the body at the most**.
- Deactivate the Start/Stop system*.
- Drive carefully and no faster than at walking speeds to prevent the front of the vehicle from creating waves, because they could splash above the lower edge of the body. Oncoming vehicles could also create waves.
- Do not stop the vehicle while in the water.
- Drive in reverse.
- Do not turn the engine off.

WARNING

After driving through water, press the brake pedal carefully to dry the brakes so that the full braking effect will be restored.

Note

Vehicle components such as the engine, drive system, suspension, or electrical system can be severely damaged by driving through water.

Tips



If possible, avoid driving through salt water because it increases the risk of corrosion. Use fresh water to clean any vehicle components that come into contact with salt water.

Hill descent assist

Applies to: vehicles with hill hold assist

The  button is located above the selector lever in the center console. It lights up when the system is turned on.

Hill descent assist can assist you when driving down hills by maintaining a constant vehicle speed by automatically braking all four wheels. You can adjust the speed using the accelerator and brake pedals. The regulation depends on the hill and the vehicle speed.

- ▶ Switching on: press .
- ▶ Switching off: press  again.

Active regulation

Regulation begins shortly after you start driving and is possible at speeds up to approximately 19 mph (30 km/h) and on hills that have an approximately 10-60% grade. If these conditions are met, regulation will be activated and the  indicator light will turn on.

Ready mode

If one of the requirements for active regulation is not met, the system will be in ready mode. The  indicator light will turn on. Once the requirements are met again, the system will be able to provide active regulation again.

Applies to: vehicles without Audi drive select: If you exceed approximately 37 mph (60 km/h), the system will switch off automatically.

WARNING

- Be ready to apply the brakes at all times when using the hill hold assist.
- Always adjust the speed to the visibility, weather, road, and traffic conditions. The system cannot replace the driver's attention.
- The system cannot maintain a constant vehicle speed in all situations, for example when on smooth or slippery ground. This can increase the risk of an accident.

Tips

If you select the Audi drive select* **Offroad** mode, hill descent assist will switch on.

Driving dynamic

Audi drive select

Introduction

Applies to: vehicles with Audi drive select

Drive select makes it possible to experience different types of vehicle characteristics in one vehicle. With different driving modes, the driver can switch the setting, for example from sporty to comfortable. This allows you to adjust the settings to your personal preferences. This makes it possible to combine settings such as a sporty drivetrain setting with comfortable steering.

Selecting an Audi drive select mode

Applies to: vehicles with Audi drive select

The  button is located above the selector lever in the center console.

- ▶ Press the  button repeatedly until the desired mode appears in the instrument cluster or center display. Or:
- ▶ Select on the home screen: **VEHICLE > Audi drive select.**

You can change the driving mode when the vehicle is stationary or while driving. If traffic permits, briefly remove your foot from the accelerator pedal after changing modes so that the mode you have selected will be activated for the drive system.

The following modes may be available depending on the equipment:

Offroad – Provides assistance when driving off-road. Additionally, the Hill descent assist* will be activated. The ESC will be restricted and the hill descent assist* will be activated. The vehicle will exit this mode after the ignition is switched off.

Comfort – Provides a comfort-oriented vehicle setup and is suited for long drives on highways.

Auto - Provides an overall comfortable yet dynamic driving feel and is suited for everyday use.

Dynamic - Gives the driver a sporty driving feel and is suited to a sporty driving style. The “S”

driving program is selected on vehicles with an automatic transmission

Individual – Provides the option for personalized vehicle settings. Press  to configure the mode ⇒ *page 98, Individual settings.*

Tips

When the ignition is being switched on, individual systems, such as the drive system, will be reset to a balanced setting. Select the current mode again to attain its full configuration.

Individual settings

Applies to: vehicles with Audi drive select

The equipment in your vehicle will determine which settings you can adjust.

Drive

The drive system will react to accelerator pedal moves more quickly or in a more balanced manner. The shift points are located in higher or lower engine speed ranges on vehicles with automatic transmissions.

Depending on the equipment, certain driver assistance systems can also become more sporty or efficient.

Depending on the setting, the drive power will be distributed via the All Wheel Drive to be more sporty or moderate.

Steering

The power steering will adapt. Light steering is suitable for long trips on highways or smooth driving around curves, for example.

Suspension

The suspension adjusts to be tighter or more comfort-oriented when it comes to compensating for uneven spots on the road.

Engine sound

The engine sound adapts and can be subtle to sporty. In the automatic setting, the engine sound depends on the selected driving program.

Suspension

Adaptive dampers

Applies to: vehicles with suspension control

The adaptive dampers are an electronically-controlled damping system. The firmness of the suspension will adapt to the driving conditions and the driving situation. The settings depend on the selected Audi drive select* mode.

Ground clearance

The vehicle height and clearance can be influenced by the following factors:

- Change in temperature
- Change in load

WARNING

To reduce the risk of injury, make sure no one gets pinched when the vehicle level is changing, for example when cleaning the underbody or the wheel housings.

Note

Always make sure there is enough clearance above and below the vehicle. This is especially important for entrances with height restrictions, for example, before driving into underground garages. You could also scrape the ground when driving over the edges of curbs or on steep ramps, which could damage your vehicle.

Messages

Suspension: malfunction! You can continue driving

There is a malfunction. See an authorized Audi dealer or authorized Audi Service Facility for assistance.

Steering

Description

Electromechanical steering supports the driver's steering movements by electronically adapting the power steering depending on the vehicle

speed. The settings depend on the selected Audi drive select* mode.

Progressive steering

Applies to: vehicles with progressive steering

The driving dynamic and driving stability are increased by the steering ratio based on the steering wheel angle. The steering is very direct when the steering wheel angle is sharp, and indirect when the angle is low. This enables comfortable maneuvering and a precise steering response at higher driving speeds.

Messages

Steering: malfunction! Please stop vehicle

The power steering may have failed. Adapt your driving style immediately to compensate for the fact that it may be more difficult to turn the steering wheel, and stop your vehicle in a safe location as soon as possible. Do not continue driving. See an authorized Audi dealer or authorized Audi Service Facility for assistance.

Steering: malfunction! Please stop vehicle

There is a malfunction in the electronic steering lock. You cannot turn the ignition on. Do not tow your vehicle because it cannot be steered. See an authorized Audi dealer or authorized Audi Service Facility for assistance.

Steering: malfunction! You can continue driving

There is a malfunction in the steering system. Steering may be more difficult or more sensitive. Adapt your driving style. Have the steering system checked immediately by an authorized Audi dealer or authorized Audi Service Facility. Please note that the red indicator light may turn on after restarting the engine. Do not continue driving if it does.



Steering lock: malfunction! Please contact Service

There is a malfunction in the electronic steering lock. Drive immediately to an authorized Audi dealer or authorized Audi Service Facility to have the malfunction repaired. ▶

WARNING

Do not tow your vehicle if there is a malfunction in the electronic steering lock because this increases the risk of an accident.

Tips

If the  or  indicator light only stays on for a short time, you may continue driving.

All wheel drive (quattro)

Description

Applies to: vehicles with all wheel drive

The all-wheel drive system distributes the driving power variably to the front and rear axle to improve the driving characteristics. It works together with selective wheel torque control, which can activate when driving through curves

⇒ *page 101*.

The all-wheel drive system is designed for high engine power. Your vehicle is exceptionally powerful and has excellent driving characteristics both under normal driving conditions and on snow and ice. Always read and follow safety precautions ⇒ .

WARNING

- Even in vehicles with all wheel drive, you should adapt your driving style to the current road and traffic conditions to reduce the risk of an accident.
- The braking ability of your vehicle is limited to the traction of the wheels. In this way, it is not different from a two wheel drive vehicle. Do not drive too fast because this increases the risk of an accident.
- Note that on wet streets, the front wheels can “hydroplane” if driving at speeds that are too high. Unlike front wheel drive vehicles, the engine RPM does not increase suddenly when the vehicle begins hydroplaning. Adapt your speed to the road conditions to reduce the risk of an accident.

Messages

 **All-wheel drive: malfunction! You can continue driving. Please contact Service**

Drive immediately to an authorized Audi dealer or authorized Audi Service Facility to have the malfunction repaired.

 **All-wheel drive: too hot. Please adapt driving style. See owner's manual**

The transmission temperature has increased significantly due to the sporty driving manner. Drive in a less sporty manner until the temperature returns to the normal range and the indicator light switches of.

Electronic Stabilization Control

Description

Electronic Stabilization Control (ESC) supports driver safety. It reduces the risk of slipping and improves driving stability. ESC detects critical situations, such as if the vehicle is oversteering or understeering, or if the wheels are spinning. The brakes are applied or the engine torque is reduced in order to stabilize the vehicle.

If the  indicator light blinks while driving, the ESC is actively regulating.

If the  indicator light turns on, the system has switched the ESC off. In this case, you can switch the ignition off and then on to switch the ESC on again. The indicator light turns off when the system is fully functional.

If the  indicator light turns on, ESC was limited or switched off manually ⇒ *page 101*.

The following systems are integrated in the ESC:

Anti-lock braking system (ABS)

ABS prevents the wheels from locking when braking. The vehicle can still be steered even during hard braking. Apply steady pressure to the brake pedal. Do not pump the pedal. A pulsing in the brake pedal indicates that the system is acting to stabilize the vehicle. ▶

Brake assist

The brake assist system can decrease braking distance. It increases braking power when the driver presses the brake pedal quickly in emergency situations. You must press and hold the brake pedal until the dangerous situation is over. Depending on the activated driver assistance systems, the brake assist system may react with increased sensitivity.

Anti-Slip Regulation (ASR)

ASR reduces drive power when the wheels begin spinning and adapts the power to the road conditions. This will increase the driving stability.

Electronic Differential Lock (EDL)

The EDL applies the brakes to wheels that are slipping and transfers the drive power to the other wheels. This function is not available at higher speeds.

In extreme cases, EDL automatically switches off to keep the brake on the braked wheel from overheating. The vehicle is still functioning correctly. EDL will switch on again automatically when conditions have returned to normal.

Power steering

The ESC can also support vehicle stability through steering.

Selective wheel torque control

Selective wheel torque control is used when driving on curves. Braking is targeted toward the wheels on the inside of the curve as needed. This allows more precise driving in curves.

Automatic post-collision braking system

The automatic post-collision braking system can help to reduce the risk of sliding and of additional collisions after an accident. If the airbag control module detects a collision, the vehicle is braked by the ESC.

The vehicle does not brake automatically if one of the following occurs:

- The driver presses the accelerator pedal, or

- The braking force generated by the pressed brake pedal is greater than the braking force that would be initiated by the system
- The ESC, the brake system, or the vehicle electrical system is not functioning

WARNING

- The ESC and its integrated systems cannot overcome the limits imposed by natural physical laws. This is especially important on slippery or wet roads. If the systems begin acting to stabilize your vehicle, you should immediately alter your speed to match the road and traffic conditions. Do not let the increased safety provided tempt you into taking risks. This could increase your risk of a collision.
- Please note the risk of a collision increases when driving fast, especially through curves and on slippery or wet roads, and when driving too close to objects ahead. There is still a risk of accidents because the ESC and its integrated systems cannot always prevent collisions.
- Accelerate carefully when driving on smooth, slippery surfaces such as ice and snow. The drive wheels can spin even when these control systems are installed and this can affect driving stability and increase the risk of a collision.

Tips

- The ABS and ASR only function correctly when all four wheels have a similar wear condition. Different tire sizes can lead to a reduction in engine power.
- You may hear noises when the systems described are working.

Operation



The  button (or , depending on the model) for controlling the ESC is located in the center console, in front of the selector lever.

The ESC is automatically switched on when the ignition is switched on. It may make sense in 

some situations to limit the ESC so that the wheels can spin:



- Rocking the vehicle to free it when it is stuck
- Driving in deep snow, on unpaved ground, or with snow chains
- Driving downhill while braking on loose ground
- Driving with axle articulation

Limiting ESC (Sport*/Offroad mode)

- To limit the ESC, press the  button briefly. The  indicator light will turn on.
- To completely reactivate the ESC stabilization function, press the button again. The indicator light turns off.

Either Sport or Offroad mode will be activated depending on the selected Audi drive select mode*. Sport mode is particularly suited for driving on an even road surface. Offroad mode is designed for uneven terrain or loose ground.

Switching off ESC

- To switch off the ESC, press and hold the  button for more than three seconds. The  and **ESC OFF** indicator lights turn on.
- To completely reactivate the ESC stabilization function, press the button again. The indicator lights turn off.

WARNING

- When the ESC is switched off or limited, there will be no vehicle stabilization or it will be limited. The driving wheels could spin and the vehicle could swerve, especially on slick or slippery road surfaces, which increases the risk of an accident.
- Because of the increased risk of an accident, only drive with the ESC switched off or limited when it is necessary. Reactivate the ESC as soon as possible.

Tips

- If you select the Audi drive select* **Offroad** mode, hill descent assist will switch on.
- If the ESC is limited, switched off, or malfunctioning, systems with an automatic braking intervention function may not be fully available.

- If malfunctions occur in other systems or certain driver assist systems are active, the ESC must be switched on by the system. The ESC may switch on automatically and cannot be operated with the button.

Messages

ABS / **Stabilization control (ESC/ABS): malfunction! See owner's manual**

There is a malfunction in the ABS or EDL. This also causes the ESC to malfunction. The brakes still function with their normal power, but ABS is not active.

Drive to an authorized Audi dealer or authorized Audi Service Facility immediately to have the malfunction corrected.

Trailer towing

Driving with a trailer

General information

Your vehicle is primarily intended for transporting people and luggage. However, if you drive with a trailer, follow the technical requirements, the operation and driving tips, and the legal regulations.

Driving with a trailer affects the vehicle's energy usage, performance, and wear. It also requires higher concentration from the driver.

WARNING

Do not transport any people in a trailer due to the risk of fatal injury.

Technical requirements

Trailer hitch

Only use a trailer hitch with a removable ball hitch mount and ball hitch. The trailer hitch must be permitted for the vehicle, the trailer and the permitted total weight of the trailer being pulled. Above all, it must be securely and safely attached to the vehicle trailer.

Never mount a trailer hitch on the bumper. The trailer hitch must be mounted in a way that does not impair the function of the bumper. Do not make any changes to the exhaust system and the brake system.

Check regularly if the trailer hitch is securely mounted. Always follow the instructions given by the trailer hitch manufacturer.

Trailer brakes

If the trailer has its own brake system, then follow the manufacturer specifications. However, the brake system on the trailer must never be connected to the vehicle brake system.

Engine cooling system

Driving with a trailer means a higher load on the engine and the cooling system. The cooling system must be designed for additional load and contain enough coolant ⇒ .

WARNING

- Never mount a "weight-distributing" or "load-balancing" trailer coupler as the trailer hitch. The vehicle was not designed for these types of trailer hitches. The trailer hitch can malfunction and the trailer can break off from the vehicle.
- If the trailer is equipped with electronic brakes, these brakes cannot be activated by a factory-installed control system, which increases the risk of an accident.
- To reduce the risk of injury, always remove the ball hitch mount if no trailer is mounted.

Note

Longer inclines cannot be driven without a suitable cooling system, especially if the outside temperatures are high. Otherwise, this increases the risk of engine damage.

Operating instructions

Towing capacity

Never exceed the maximum permitted weights ⇒ *page 270*.

In some scenarios, the load in trailer mode can be reduced due to the permitted towing weight.

You can drive up larger inclines if you are not using the maximum towing capacity.

The specified towing weights only apply at elevations up to 3,200 feet (1,000 m) above sea level. As the elevation increases, the engine power decreases due to the decreasing air pressure. This reduces the hill climbing ability and towing capacity. For every additional 3,200 feet (1,000 m), the maximum permitted towing weight must be reduced by approximately 10%. The permitted towing weight is the combined weight of the (loaded) vehicle and the (loaded) trailer.

Tongue weight

The maximum permitted tongue weight of the trailer drawbar on the trailer hitch ball head must not be exceeded. ►

Trailer towing

For driving safety, Audi recommends always using the maximum permitted tongue weight, but do not exceed this weight. Distributing the cargo in the trailer correctly will help to achieve this weight. Having the tongue weight too low affects the vehicle's handling.

You can determine the tongue weight using a tongue weight scale, a bathroom scale, or a public weigh station, for example.

The permitted tongue weight of your vehicle can be found in the vehicle documentation or in ⇒ *page 270*.

Load distribution

Poor cargo load and distribution can negatively impact vehicle handling. Load the trailer based on the following criteria as much as possible:

- Store objects in the vehicle luggage compartment, if possible. The vehicle should always carry the heaviest possible load and the trailer should have the lightest possible load.
- Distribute the load in the trailer so that the heavy objects are as close to the axle as possible.
- Secure objects so that they do not slide.
- Utilize the maximum permitted tongue weight if possible.

Tires

Set the tire pressure on your vehicle for a “full load”; see the tire pressure sticker ⇒ *page 233*. If necessary, also adjust the tire pressure on the trailer according to the manufacturer's specifications.

The trailer and the vehicle should be equipped with winter tires when driving in winter temperatures.

Outside mirrors

If you cannot see the traffic behind the trailer with the standard exterior mirrors, then you must attach additional exterior mirrors. Adjust them so you have a sufficient visibility behind you.

Exterior lighting

Follow the legal regulations for lighting on your trailer that are applicable in the country where you are operating the vehicle. Contact an authorized Audi dealer or authorized Audi Service Facility for more information.

Before you start driving, check all lighting equipment on the trailer while it is hitched to the vehicle.

The headlight range control automatically adjusts the light range of the headlights.

Safety chains

Make sure the safety chains are correctly applied when pulling a trailer. The chains should hang enough so that the trailer can drive around curves. However, they must not touch the ground.

Note

Attachments retrofitted on the vehicle may cause damage, especially on the trailer hitch ball head. In cases of damage, have the function checked by an authorized Audi dealer or authorized Audi Service Facility.

Tips

- Block the wheels with chocks when parking on inclines if the trailer is loaded.
- Audi recommends having the vehicle inspected between the inspection intervals if you tow a trailer frequently.
- Avoid driving with a trailer during the vehicle break-in period.

Driving with a trailer

Driving with a trailer requires extra caution.

Speed

Adhere to the legal speed limits. Follow the legal regulations that are applicable in the country where you are operating the vehicle.

As the speed increases, the driving stability of the trailer decreases. Therefore you should not exceed the maximum legal speed limit when

there are unfavorable road, weather, and/or wind conditions. This especially applies when driving downhill.

Hill

When you start driving uphill or downhill, trailers may tilt or sway sooner than when driving on a level surface. If small swaying movements have already occurred, you can stabilize the trailer by firmly braking immediately. Never attempt to “straighten out” the trailer by accelerating.

Downshift before driving on hills to utilize the engine braking effect ⇒ .

Brakes

When using a trailer with overrun brakes, first brake gently then quickly. This reduces the risk of jerking while braking if the trailer wheels lock up.

Engine coolant temperature

Pay attention specifically to the coolant temperature display when there are high outside temperatures, and when driving on long inclines ⇒ *page 13*. Shift to a higher gear in a timely manner.

WARNING

Constant braking causes the brakes to overheat and can substantially reduce braking performance, increase braking distance, or cause complete failure of the brake system.

Assist systems

General information

Safety precautions

WARNING

- As the driver, you are always completely responsible for all driving tasks. The assist systems cannot replace the driver's attention. Give your full attention to driving the vehicle, and be ready to intervene in the traffic situation at all times.
- Activate the assist systems only if the surrounding conditions permit it. Always adapt your driving style to the current visual, weather, road, and traffic conditions.
- Loose objects can be thrown around the vehicle interior during sudden driving or braking maneuvers, which increases the risk of an accident. Store objects securely while driving.
- For the assist systems to be able to react correctly, the function of the sensors and cameras must not be restricted. Note the information on sensors and cameras
⇒ *page 107*.

Tips

- Pay attention to applicable local regulations relating to driving tasks, leaving space for emergency vehicles, vehicle distance, speed, parking location, wheel placement, etc. The driver is always responsible for following the laws that are applicable in the location where the vehicle is being operated.
- You can cancel a steering or braking intervention by the system, by braking or accelerating noticeably, steering, or deactivating the respective assist system.
- Always check the assist systems settings before driving. The settings could have been changed, for example by other drivers.

System limitations

WARNING

- The use of an assist system cannot overcome the natural laws of physics. A collision cannot be prevented in certain circumstances.
- Warnings, messages, or indicator lights may not be displayed or initiated on time or correctly, for example, if vehicles are approaching very fast.
- Corrective interventions by the assist systems, such as steering or braking interventions, may not be sufficient or they may not occur. Always be ready to intervene.

Tips

- Due to the system limitations when detecting the surrounding area, the systems may warn or intervene unexpectedly or too late in certain situations. The assist systems may also interpret a driving maneuver incorrectly and then warn the driver unexpectedly.
- The systems may not function as expected in unusual driving situations, such as driving offroad, on unpaved roads, on loose ground, on inclines, or on grooves in the road.
- The systems may not function correctly in unclear traffic situations, such as turning lanes, exit ramps, construction zones, rises or dips that obstruct visibility, intersections, toll stations, or city traffic.
- The detection of the surrounding area can be limited, for example by vehicles driving ahead or by rain, snow, heavy spray, or light shining into the camera.
- In trailer mode, some assist systems may be limited, may not react as usual, or may be unavailable. Please refer to the instructions for towing a trailer located in ⇒ *page 103*.
- The steering wheel touch recognition may be limited when you wear gloves. Steering intervention requests from the steering assist systems may occur more frequently.
- If accessories have been mounted on the steering wheel, the steering assist systems may be limited. The frequency of steering

intervention requests from the steering assist systems may vary as well.

Surrounding area detection

Sensor and camera coverage areas

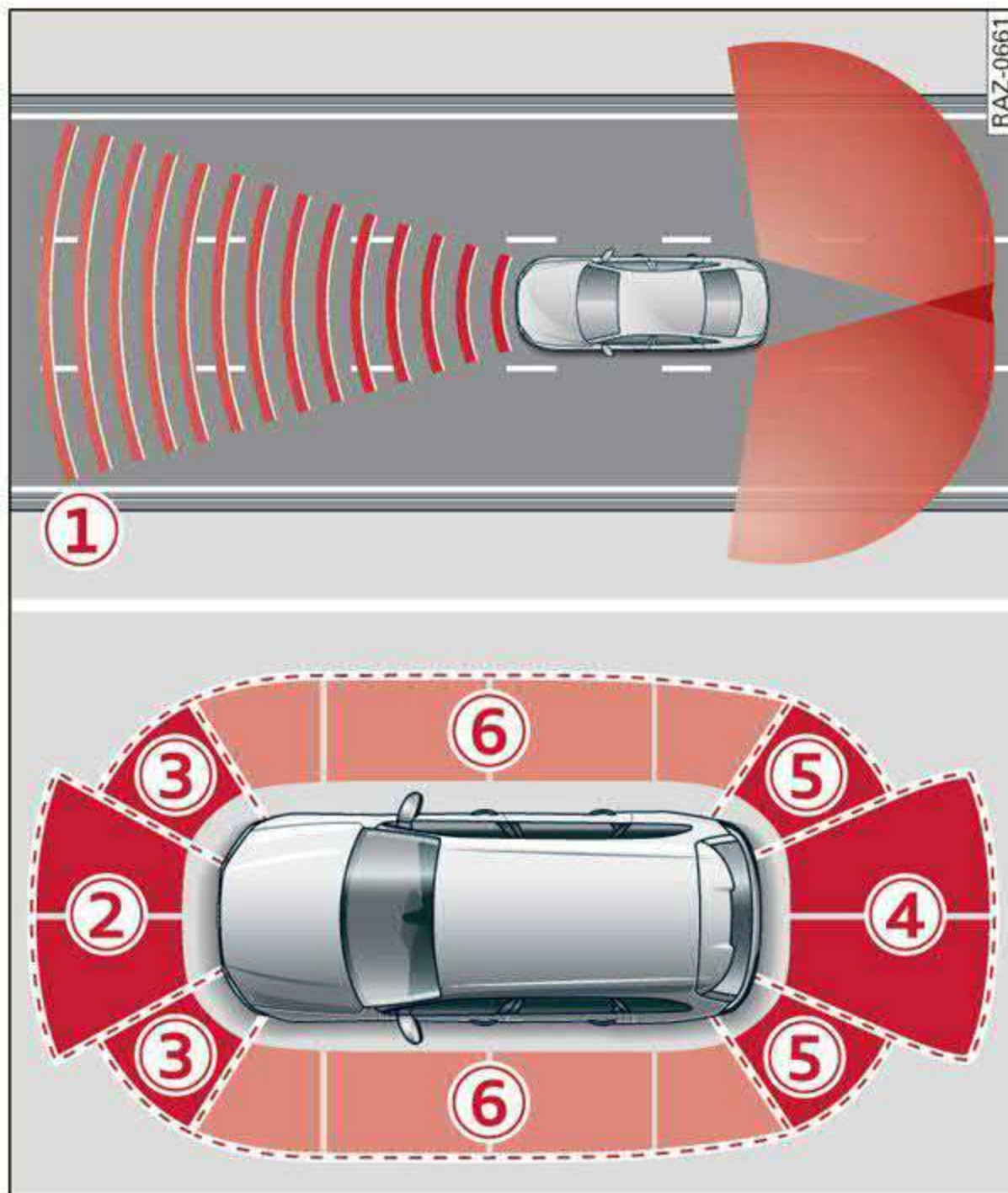

Fig. 85 Sensor coverage area

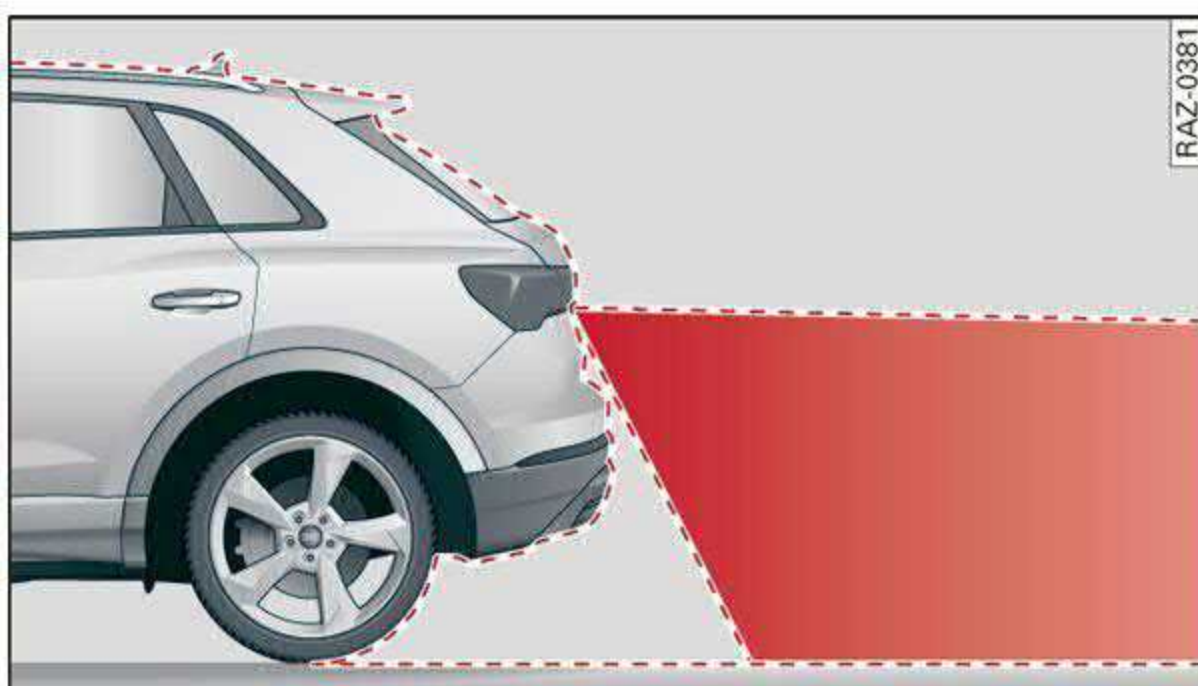

Fig. 86 Rearview camera coverage area

The assist systems analyze the data from various sensors and cameras installed in the vehicle. Do not use any assist systems if there is damage to the vehicle in an area where sensors and cameras are located or on the vehicle underbody, or if the vehicle was involved in a collision. The functionality of the sensors and cameras could be impaired, or they could malfunction. Have an authorized

Audi dealer or authorized Audi Service Facility check their function.

Radar sensors

Depending on the vehicle equipment, the area in front of and behind the vehicle may be detected ⇒ *fig. 85* ①.

The wheel sensors on the rear corners of the vehicle are positioned so that the adjacent lanes to the left and right are detected on roads with a normal lane width.

Ultrasonic sensors

Depending on vehicle equipment, various areas may be displayed in the MMI using the ultrasonic sensors ⇒ *fig. 85*.

The range of the displays depends on the location of the ultrasonic sensors:

- ② Approximately 4 feet (1.20 m)
- ③ Approximately 3 feet (0.90 m)
- ④ Approximately 5.2 feet (1.60 m)
- ⑤ Approximately 3 feet (0.90 m)
- ⑥ Approximately 3 feet (0.90 m)

The side area ⑥ is detected and evaluated when passing. There may have been changes to the surrounding area after switching the ignition off and on again, after opening the doors, or if the vehicle is left stationary for a period of time. In this case, the area will appear black until the area has been detected and evaluated.

Cameras

Use the camera image on the display to assist you only if it shows a good, clear picture. Keep in mind that the image in the display is enlarged and distorted. Under certain circumstances, objects may appear different and unclear on the display.

The rearview camera can only detect the area marked in red ⇒ *fig. 86*. Only this area is displayed on the center display ⇒ ⚠.

⚠ WARNING

Sensors and cameras have spots in which the surrounding area cannot be detected. Objects, animals, and people may only be detected

with limitations may not be detected at all. Always monitor the traffic and the vehicle's surroundings directly and do not become distracted.

! Note

- Obstacles may disappear from the measurement range when approaching them, even if they were already detected.
- In some situations, the ability of the sensors and cameras to detect and display certain objects may be limited.
 - Objects located above the coverage area, such as bumpers on parked cars, garage doors that are partially open, or objects that are hanging
 - Low obstacles
 - Narrow objects, such as barrier chains, foliage, poles, or fences
 - Projecting objects, such as trailer draw bars
 - Objects with certain surfaces and structures, such as fabric

i Tips

- The sensors and cameras and the areas around them must not be obstructed because this can impair the function of the systems that depend on them. Make sure that the sensors and cameras are free of snow, ice, and other deposits. Do not use any accessories, stickers, or other objects that extend into the range of the sensors and cameras.
- On vehicles that have factory-installed license plate brackets on the front of the vehicle, the brackets may only be replaced with ones that are the same size and made of the same material. Do not install any license plate brackets on the front of vehicles that do not have factory-installed brackets. Otherwise, the function of the system could be impaired.
- The function of the sensors and cameras may be limited when light and visibility conditions are poor, for example when driving

into a tunnel, when there is glare, or when there are reflective objects.

- External ultrasonic sensors, such as those in other vehicles, can interfere with the sensors.
- The coverage areas of the sensors ⇒ *fig. 85* and cameras ⇒ *fig. 86* are diagrams and do not represent a true-to-scale image of the sensor ranges.
- The system complies with United States FCC regulations and ISED regulations ⇒ *page 267*.

Locations of the sensors and cameras

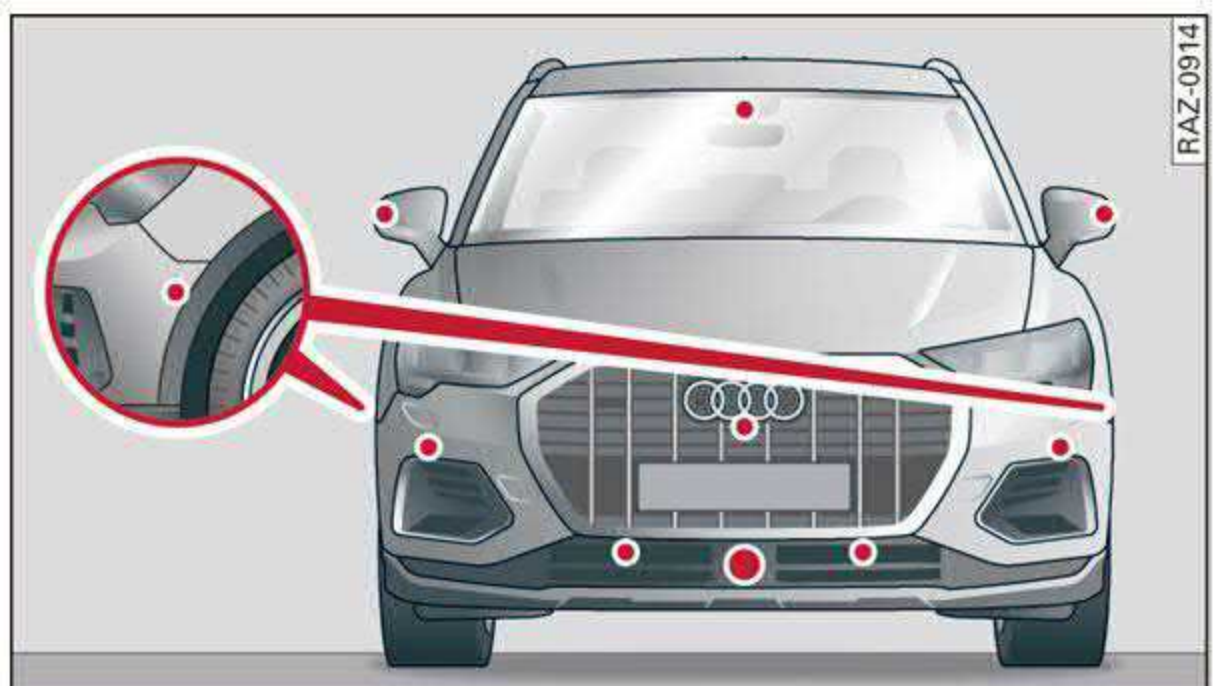

Fig. 87 Front area: sensors and cameras



Fig. 88 Rear area: sensors and cameras

Front area

Depending on the vehicle equipment, the following sensors and cameras may be installed:

- Camera behind the windshield
- Peripheral cameras on the exterior mirrors
- Front peripheral camera in the radiator grille
- Front and side ultrasonic sensors
- Front radar sensor in the center of the radiator grille

Rear area

Depending on the vehicle equipment, the following sensors and cameras may be installed:

- Rearview camera in the luggage compartment lid
- Radar sensors at the rear corners of the vehicle
- Rear and side ultrasonic sensors

Tips

- The locations of the sensors may differ slightly depending on vehicle equipment.
- Some sensors are installed under vehicle components and cannot be seen from the outside.
- The system complies with United States FCC regulations and ISED regulations
⇒ *page 267*.

Driving information

Speed warning system

Description

Applies to: vehicles with speed warning system

The speed warning system helps the driver to stay below a specified maximum speed. A warning threshold can be set for this purpose.

Once the speed slightly exceeds the stored threshold, the speed warning system will alert the driver with an indicator in the instrument cluster and a warning tone. Once the speed drops below the stored maximum speed, the indicator will turn off.

Setting a threshold is recommended if you would like to be reminded when you reach a certain maximum speed. Situations where you may want to do so include driving in a country with a general speed limit or if there is a specified maximum speed for winter tires.

Tips

Regardless of the speed warning system, you should always monitor your speed using the speedometer and make sure you are following the legal speed limit.



Setting the warning threshold

Applies to: vehicles with speed warning system

- ▶ Applies to: MMI: Select on the home screen: **VEHICLE > Driver assistance > Speed warning.**

Messages

Applies to: vehicles with speed warning system

 /  **Manually set speed limit XX mph (km/h) exceeded**

The stored speed was exceeded.

Camera-based traffic sign recognition

Description

Applies to: vehicles with camera-based traffic sign recognition

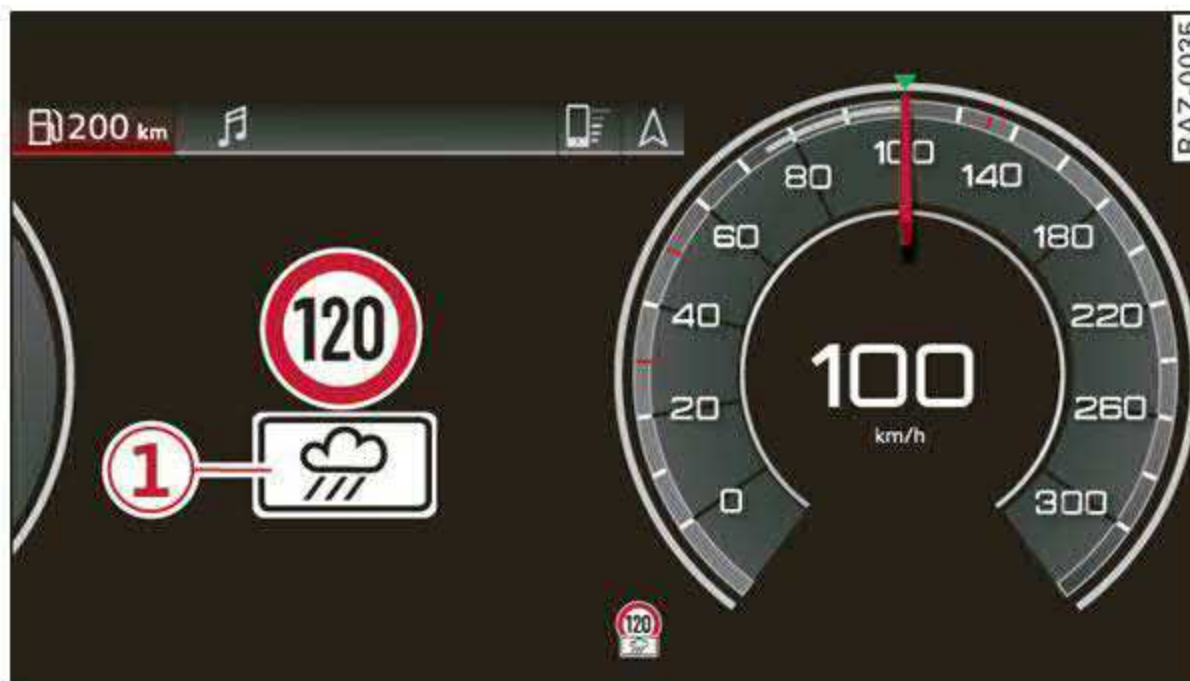







Fig. 89 Instrument cluster: traffic sign recognition

The traffic sign recognition shows the traffic signs detected by the front camera in the instrument cluster display. Data from the navigation system is also included in the display. By evaluating the data, applicable legal speed limits will also be displayed for roads that have no speed limit signs. Up to three traffic signs can be displayed at the same time. The speed limit that is currently applicable is displayed in the status line.

Within the limits of the system, restrictions  may be displayed under the following conditions:

	A speed limit applicable in wet conditions is detected and the windshield wipers are running.
	A speed limit applicable in fog is detected and the fog lights or all-weather lights are switched on.
	The detected time for a speed limit matches the time displayed in the instrument cluster.

Within the limits of the system and depending on the market, additional symbols  that indicate speed limits in school zones, highways, construction zones, or at night may be displayed.

Limitations

The traffic sign recognition is subject to certain system limitations and may be unavailable or only partially available in the following situations: ▶

- When visibility is poor, such as in snow, rain, fog, or heavy spray
- When there is glare, for example from oncoming traffic or the sun
- At high speeds
- If the camera's visual field ⇒ *page 107* is covered, for example by dirt or stickers. For information on cleaning, see ⇒ *page 242*.
- If the traffic signs are completely or partially covered, for example by trees, snow, dirt, or other vehicles
- If traffic signs do not conform to the standard format
- If traffic signs are damaged or bent
- If traffic signs are displayed on sign holders with electronic signs
- If the traffic signs or the roadways have changed, and the navigation data is no longer up-to-date

WARNING

- Observe the safety precautions and note the limits of the assist systems, sensors, and cameras ⇒ *page 106*.
- Under some circumstances, traffic sign recognition may not detect traffic signs correctly or detect them at all. As a result, the system may not display the correct speed limit or any speed limit.

Tips

- Traffic sign recognition does not adapt your vehicle's speed to match the speed limit.
- The display in the instrument cluster is based on the units of measurement used for speed in the country where the vehicle is being operated. As a result, the display **50** in the instrument cluster can mean either km/h or mph, depending on the country.

Operation

Applies to: vehicles with camera-based traffic sign recognition

Accessing traffic sign recognition

- ▶ Select in the instrument cluster: vehicle functions tab > **Traffic signs**.

Setting a traffic sign based speed warning

- ▶ Applies to: MMI: Select on the home screen: **VEHICLE > Driver assistance > Speed warning**.

You can select a warning threshold. If you exceed this, then the current detected speed limit will be shown in the display with an exclamation point for the duration that it is exceeded and it will blink for a short time.

Messages

Applies to: vehicles with camera-based traffic sign recognition

Traffic sign recognition: unavailable. Camera view limited due to environm. conditions

The camera's visual field is covered. Clean the windshield.

Traffic sign recognition: currently limited. See owner's manual

This message appears if navigation system data is not available, for example on newly-constructed roads. The speed limit display will be temporarily limited, which increases the risk of an incorrect display. If this message continues to appear, drive immediately to an authorized Audi dealer or authorized Audi Service Facility to have the malfunction repaired.

No traffic sign information available

Depending on the area, there is no valid navigation data and no speed limits were detected. This may also appear if there is a recommended speed, but no speed limit (for example when driving on and off the expressway).

Malfunction! See owner's manual

The system may not function correctly so it has been switched off. See an authorized Audi dealer or authorized Audi Service Facility for assistance.

Function currently unavailable. See owner's manual

If this message appears on vehicles without camera-based traffic sign recognition, then the traffic light information function is currently unavailable. See ⇒ *page 113*.

Traffic light information

Description

Applies to: vehicles with traffic light information

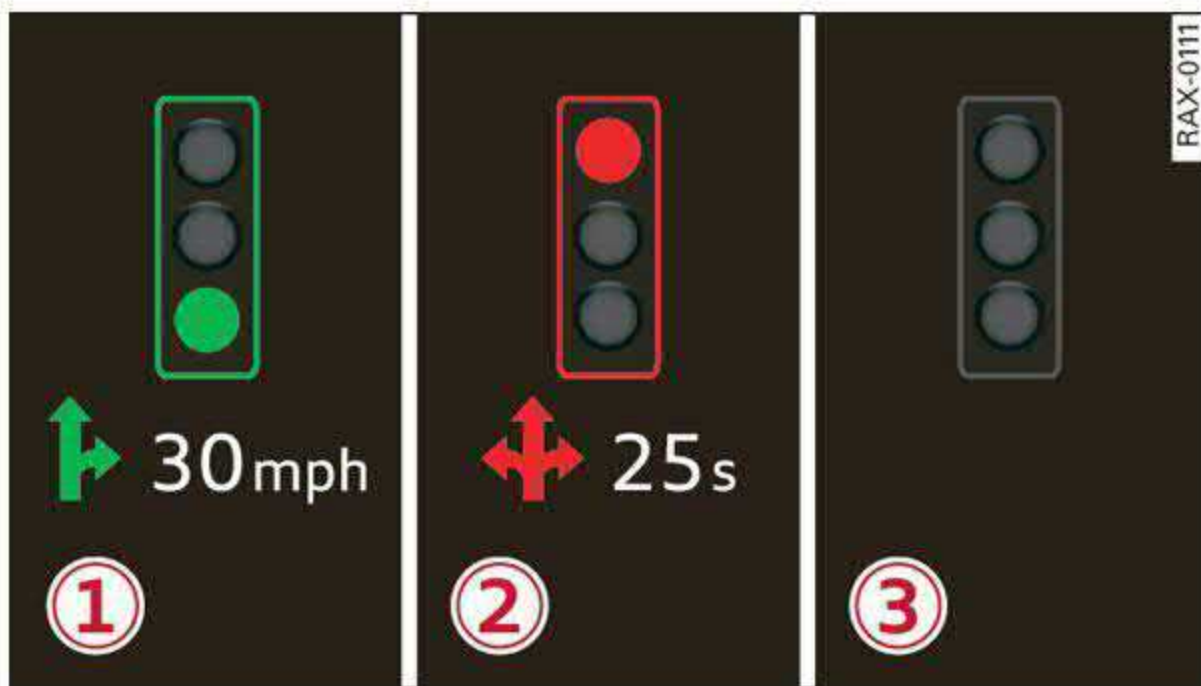

Fig. 90 Instrument cluster: traffic light information display

The traffic light information gives you a speed recommendation in order to reach the next traffic light when it is green ①, or it informs you of the wait time at the next red light ②. Once traffic light information is received, it will be displayed in the instrument cluster. If the vehicle is in an area with traffic light information but cannot receive a traffic light signal, then a gray traffic light symbol will be displayed ③.

General information

The traffic light information is subject to system limitations and may be unavailable or only partially available in the following situations:

- If the permitted speed limit is exceeded
- If driving below a certain speed limit
- If the next traffic light is less than approximately 100 feet (30 m) away
- If the estimated wait time at a red light is less than four seconds
- If there is no traffic light data available
- If emergency response vehicles or public transit systems are active
- If traffic lights are in construction zones or being serviced
- If there are warnings from the camera-based traffic sign recognition*
- If the camera-based traffic sign recognition* is malfunctioning or not available
- If the data connection has been interrupted
- If data transmission is deactivated in the privacy settings

- If the subscription has expired

If this is the case, the menu item will be grayed-out or it will not be possible to select it.

! WARNING

- When traffic light information is shown, also always pay attention to the traffic situation, the distance to other vehicles, and the area around the vehicle. The driver is always responsible for assessing the traffic situation.
- Always adapt your speed to the current weather, road and traffic conditions. The displayed information must never cause you to ignore legal traffic regulations and pose a safety risk.
- Regardless of the traffic light information, you should always monitor your speed using the speedometer and make sure you are adhering to the legal speed limit.
- The traffic light information does not adjust your vehicle's speed to the speed recommendation shown in the display.
- Observe the safety precautions and note the limits of the assist systems, sensors, and cameras ⇨ page 106.

i Tips

- Traffic light information was only available in select cities at the time this manual was printed.
- Traffic light information is not available nationwide.
- The functions depend on the navigation data* being up-to-date and correct identification by the traffic sign recognition*.
- Incorrect values from the camera-based traffic sign recognition* or outdated navigation system* map data can result in missing or incorrect display images.
- Certain traffic lights can automatically adjust to the current traffic situation. If this occurs, the display of traffic light information can change suddenly.
- The traffic signs on the road always take priority over the display. The driver is always responsible for adhering to the regulations

applicable in the country where the vehicle is being operated.

- Units of measurement and language settings are displayed based on how they were set in the MMI system settings ⇒ *page 201*.

- Traffic light information is not available in that area

Operation

Applies to: vehicles with traffic light information

Switching traffic light information on and off

- ▶ Applies to: MMI: Select on the home screen: **VEHICLE > Driver assistance > Traffic light information**.

Accessing traffic light information

- ▶ Select in the instrument cluster: vehicle functions tab > **Traffic signs**.

Tips

If another tab or another function is selected in the instrument cluster, the traffic light information will appear in the status bar on the instrument cluster.

Messages

Applies to: vehicles with traffic light information

Malfunction! See owner's manual

The system could not be configured, for example due to a network malfunction. Switch the ignition off and shut down the vehicle to restart the system. Wait several minutes until the vehicle has shut down completely and then switch the ignition back on.

Function currently unavailable. See owner's manual

There is a temporary system malfunction. Check if one or more of the following situations applies and correct the issue if necessary:

- Traffic light information is switched off
- Data transmission is deactivated
- The vehicle is not equipped with traffic sign recognition.
- There is no valid license

Driver assistance

Cruise control system

Description

Applies to: vehicles with cruise control system

The cruise control system assists the driver in maintaining a constant speed above approximately 15 mph (20 km/h). The system maintains the desired speed by braking and accelerating.

! WARNING

- Always pay attention to the traffic around your vehicle when the cruise control system is in operation. As the driver, you are always responsible for controlling your vehicle speed and the distance between your vehicle and other vehicles.
- For safety reasons, cruise control should not be used in the city, in stop-and-go traffic, on winding roads, and when road conditions are poor (such as ice, fog, gravel, heavy rain, and conditions that could lead to hydroplaning), because this increases the risk of an accident.
- Switch the cruise control off temporarily when driving in turning lanes, highway exits, or in construction zones.
- To reduce the risk of an accident, you should only resume the stored speed if it is suitable for the current traffic conditions.

! Note

Before driving downhill a long distance on a steep hill, decrease your speed and select a lower gear. This makes use of the engine braking effect and reduces the load placed on the brakes.

i Tips

The brake lights turn on when the brakes are applied automatically.

Switching the system on

Applies to: vehicles with cruise control system



Fig. 91 Operating lever: switching the system on

Requirement: the ignition must be switched on.

- ▶ To switch the system on, pull the lever toward you to position ①.

The **CRUISE** or  indicator light and the corresponding message will appear in the instrument cluster.

! WARNING



If the brakes are malfunctioning (for example, overheating) while the cruise control system is switched on, the regulating functions may shut off automatically.

Preselecting or activating a cruise control speed

Applies to: vehicles with cruise control system

When the vehicle is stationary, you can preselect the cruise control speed or activate the speed while driving.

Requirement: the system must be switched on.





- ▶ To preselect a cruise control speed when the vehicle is stationary, tap the lever toward / ⇒ page 114, fig. 91.
- ▶ To activate the cruise control speed, pull the lever toward position ① while driving.
- ▶ To set the current driving speed as the cruise control speed, press the button **A** on the lever.

The active cruise control speed is indicated with the **CRUISE** or  indicator light in the instrument cluster.

Changing the cruise control speed

Applies to: vehicles with cruise control system

Requirement: the system must be switched on.

- ▶ To increase or decrease the cruise control speed in increments, tap the lever toward / ⇒ *page 114, fig. 91.*
- ▶ To increase or decrease the cruise control speed continuously, press and hold the lever toward /.

Overriding or deactivating the cruise control speed

Applies to: vehicles with cruise control system

You can override or deactivate the cruise control system. When you deactivate the system, your cruise control speed will be stored and you can resume that speed.

Requirement: the system must be switched on and the regulated speed must be activated.

Overriding

- ▶ To temporarily override the cruise control speed, press the accelerator pedal.
- ▶ To resume the stored regulated speed, remove your foot from the accelerator pedal.

If you override the cruise control system for a long period of time, the cruise control system will be deactivated. The **CRUISE** or  indicator light will be displayed and the cruise control speed will be saved.

Deactivating

- ▶ To deactivate the cruise control speed, press the lever toward  (not locked into place) ⇒ *page 114, fig. 91, or*
- ▶ Press the brake pedal.



WARNING

Resting your foot on the accelerator pedal could override the cruise control. This will prevent braking interventions by the system.

Switching the system off

Applies to: vehicles with cruise control system

When you switch the system off, the cruise control speed will be erased.

Requirement: the system must be switched on.

- ▶ To switch the system off, press the lever toward  (locked into place) ⇒ *page 114, fig. 91, or*
- ▶ Switch the ignition off.

Message

Applies to: vehicles with cruise control system

CRUISE /  **Speed control system: currently unavailable. See owner's manual**

If the indicator light turns on and this message appears, the cruise control system has been deactivated. There is a temporary malfunction, for example the brakes are overheating. Switch the cruise control system on again later.

Adaptive cruise assist

General information

Applies to: vehicles with adaptive cruise assist

Depending on the vehicle equipment, the adaptive cruise assist may consist of the following functions:

Within the limits of the system, the **adaptive speed assist** assists the driver in controlling the speed and the set distance to the vehicle driving ahead. If the system detects a vehicle driving ahead, the adaptive speed assist can brake and accelerate your vehicle within the limits of the system. On open roads with no traffic, it functions like a cruise control system. The stored speed is maintained. When approaching a vehicle driving ahead, the adaptive speed assist automatically brakes to match that vehicle's speed and then maintains the set distance as much as possible. Once the system does not detect a vehicle driving ahead, adaptive speed assist will accelerate up to the set speed.

The additional **lane guidance** (if equipped) assists the driver with corrective steering in order to stay in the lane. You can adjust if the adaptive cruise assist will provide support with lane

guidance ⇒ *page 119, Switching lane guidance on and off.*

In **stop-and-go traffic and in traffic jams**, the vehicle may brake to a full stop and then may also start driving again automatically under certain conditions.

WARNING

Observe the safety precautions and note the limits of the assist systems, sensors, and cameras ⇒ *page 106.*

Tips

The system complies with United States FCC regulations and ISED regulations ⇒ *page 267.*

Limitations

Applies to: vehicles with adaptive cruise assist

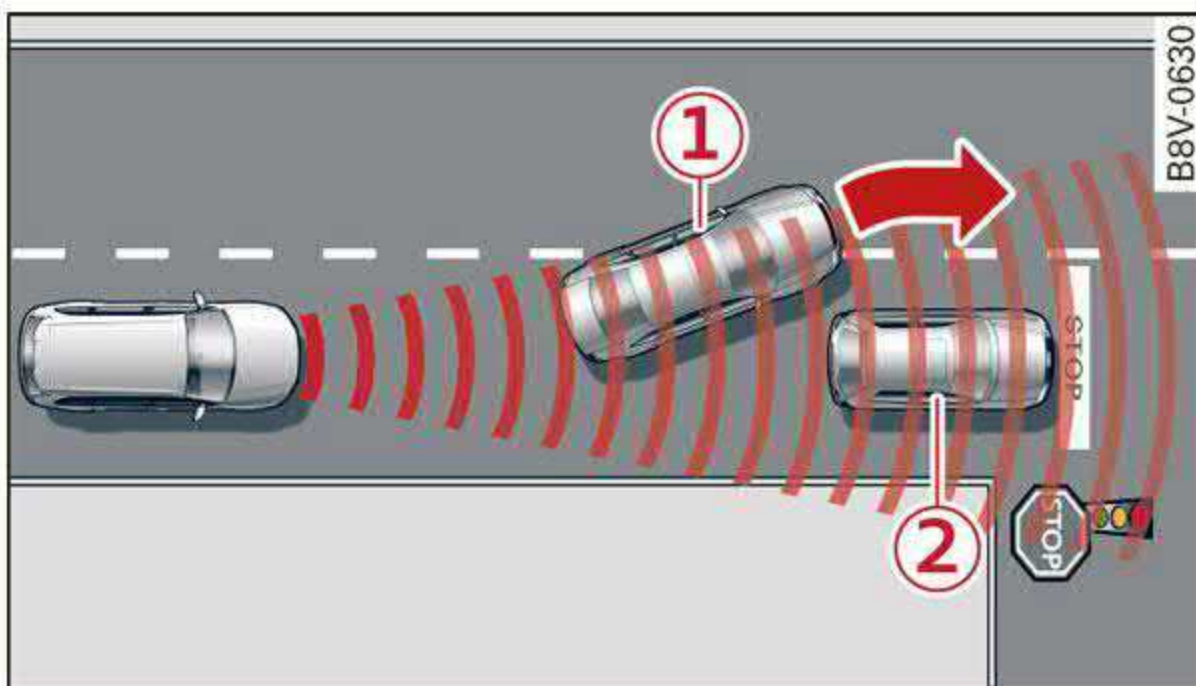

Fig. 92 Example: vehicle changing lanes and stationary vehicle

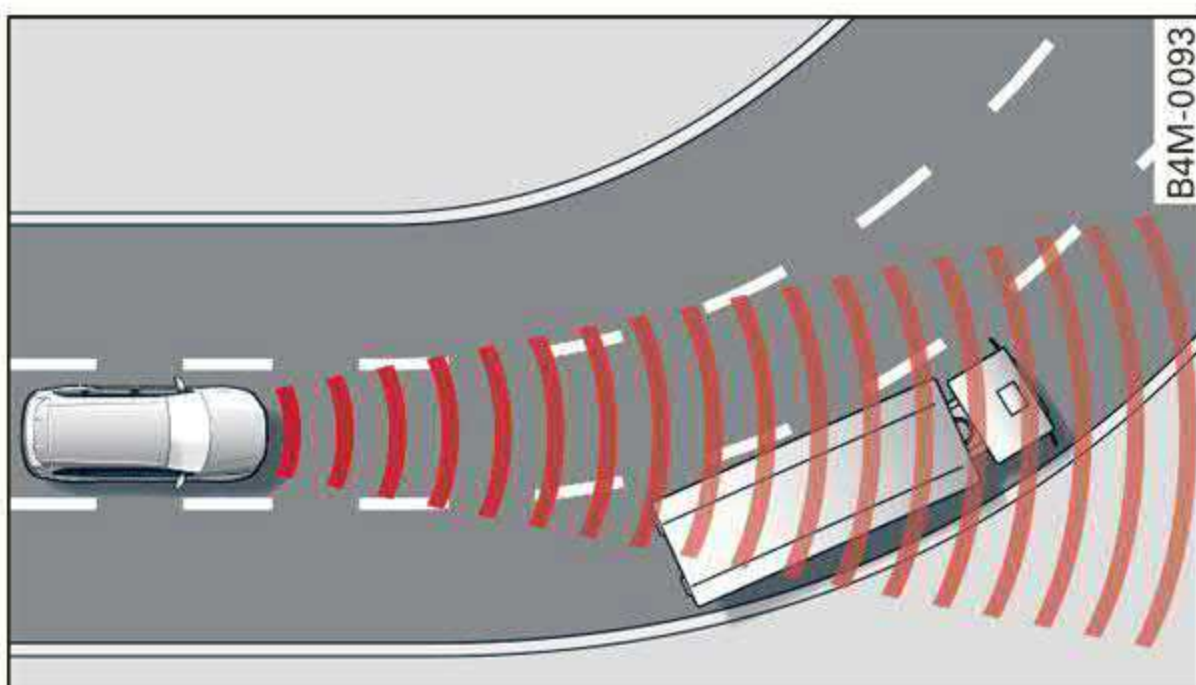

Fig. 93 Example: driving into a curve

In some situations, the adaptive cruise assist function is limited and you must assume control of the vehicle when necessary, for example by applying the brakes.

- If a vehicle that was already detected ① turns or changes lanes, the adaptive cruise assist will react to the vehicle ahead of it ②.
- When driving into a curve ⇒ *fig. 93* and out of a curve, the system may react to a vehicle in the neighboring lane and apply the brakes. You can override the system by pressing the accelerator pedal briefly.
- The system works with the various sensors and cameras in the vehicle. Vehicles can only be detected once they are within the area and range covered by the sensors ⇒ *page 107.*
- When driving around tight curves, a vehicle driving ahead that was previously detected may no longer be detected, and the adaptive cruise assist may accelerate unexpectedly.
- The system does not react to a stationary vehicle in the same lane if it expects that you can easily drive around the stationary vehicle by turning the steering wheel.
- The system cannot react to stationary objects, such as vehicles at the end of a traffic jam, especially when traveling at high speeds.
- The system has a limited ability to detect vehicles that are a short distance ahead, off to the side of your vehicle, or moving into your lane.
- Objects that are difficult to detect, such as motorcycles, vehicles with high ground clearance, or vehicles with an overhanging load, may be detected late or not detected at all.
- The system does not respond to people, animals, or objects that are crossing or approaching from the opposite direction.

WARNING

Observe the safety precautions and note the limits of the assist systems, sensors, and cameras ⇒ *page 106.*

Display overview

Applies to: vehicles with adaptive cruise assist

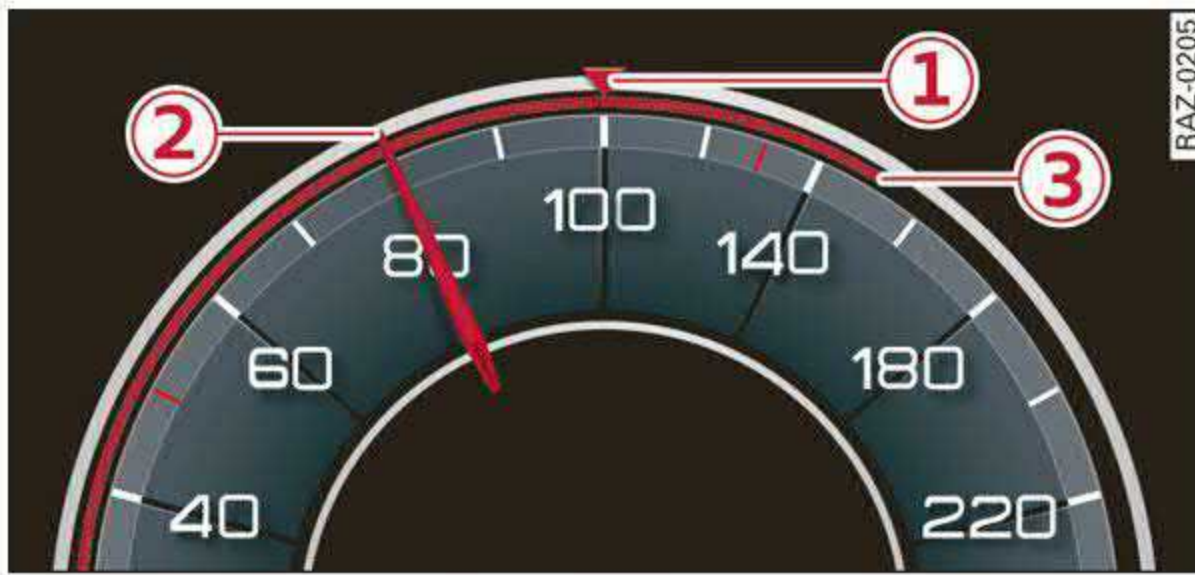

Fig. 94 Instrument cluster: display in speedometer

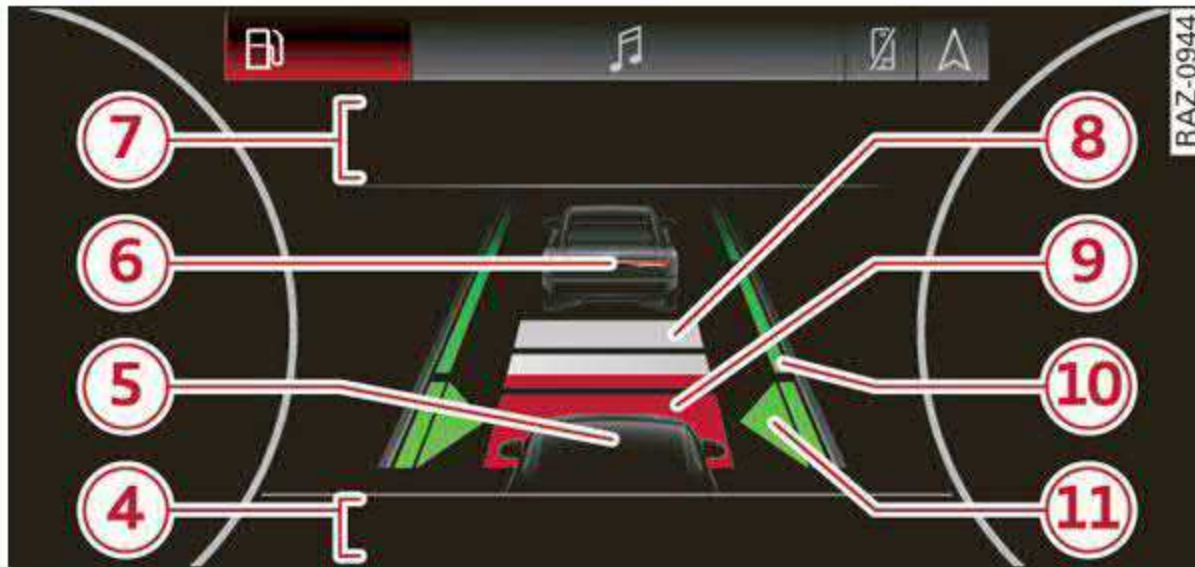

Fig. 95 Instrument cluster: driver assistance display

Indicator lights and messages in the speedometer ① - ③ inform you about the driving situation and the settings. In the **Driver assistance** display ④ - ⑪, you can find more detailed information about the system. The displays depend on the country and equipment.

Display in the speedometer

- ① Marking for the set speed
- ② Current vehicle speed
- ③ Available speed range for adaptive cruise assist (example)

Image in the Driver assistance display

The display only appears when the **Driver assistance** display is open in the on-board computer ⇒ *page 14*.

- ④ Messages and settings
- ⑤ Your vehicle
- ⑥ Detected vehicle driving ahead
- ⑦ Messages and settings
- ⑧ Set target distance
- ⑨ If you fall below the set distance, the distance bars turn red from the bottom upward.
- ⑩ Lane departure warning availability

- ⑪ Availability of lane guidance for adaptive cruise assist

Indicator lights

- The speed/distance control is active. No vehicles were detected ahead. The stored speed is maintained.
- The speed/distance control is active. A vehicle was detected ahead. The system controls the speed and distance from the vehicle driving ahead, and accelerates and brakes automatically.
- The speed/distance control is active but the vehicle is not **ready to drive**. A vehicle was detected ahead. Your vehicle is stationary and will not start driving automatically.
- The speed/distance control is active but the vehicle is not **ready to drive**. No vehicles were detected ahead. Your vehicle is stationary and will not start driving automatically.
- The automatic braking is not enough to maintain a sufficient distance from a vehicle driving ahead. You must intervene ⇒ *page 122, Driver intervention request*.
- Lane guidance is active.
- Lane guidance is switched on but not active.
- The limits of the system have been reached. Take over steering.
- / – The indicator light turns on if the steering intervention request is providing a warning. Always keep your hands on the steering wheel so you can be ready to steer at any time ⇒ *page 120*.

WARNING

Observe the safety precautions and note the limits of the assist systems, sensors, and cameras ⇒ *page 106*.

Using adaptive cruise assist

Applies to: vehicles with adaptive cruise assist



Fig. 96 Lever: using adaptive cruise assist



Fig. 97 Operating lever: changing the speed

Switching on

- ▶ To switch on the adaptive cruise assist, pull the lever up to position ① until it engages.

Storing the speed and activating regulation

If you have switched the system on, you can set the current speed as the “regulated speed” and activate regulation:

- ▶ Press the **SET** button ②. The set speed is indicated with a marking in the speedometer ① ⇒ page 117, fig. 94 and shown in the instrument cluster ⇒ ⚠.
- ▶ To save the speed while the vehicle is stationary, also hold the brake pedal down.

You can set any speed between 20 mph (30 km/h) and the maximum possible speed range ③¹⁾ ⇒ page 117, fig. 94.

Pausing cruise control

The control can be stopped at any time:

- ▶ While driving or when the vehicle is stationary: Press the lever away from you in the direction of the arrow. Or
- ▶ While driving: Press the brake pedal.

The  indicator light turns off.

Resuming regulation

The previously set speed can be resumed at any time after a pause.

- ▶ To resume cruise control while driving, pull the lever toward you in the direction of the arrow.
- ▶ To resume cruise control when stationary, pull the lever toward you in the direction of the arrow while pressing the brake pedal.

Changing the speed

- ▶ To increase or decrease the set speed in increments, tap the lever in the **+**/**-** direction.
- ▶ To increase or decrease the set speed quickly, hold the lever toward **+** or **-** until the marking in the speedometer ① ⇒ page 117, fig. 94 has reached the desired speed.

Preselecting a speed

You can also preselect the speed when adaptive cruise assist is not active by moving the lever in the desired direction **+**/**-**. Activate the previously selected speed by pulling the lever toward you in the direction of the arrow.

Switching off

If you do not want to use the adaptive cruise assist for a longer period of time, you can switch it off.

- ▶ Push the lever away from you into position ② until it clicks into place.

The indicator light and the set speed will turn off.



WARNING

- Observe the safety precautions and note the limits of the assist systems, sensors, and cameras ⇒ page 106.
- The activated adaptive cruise assist is only an assist system, and the driver is still

1) Depends on the country and engine

responsible for controlling the vehicle. The driver is especially responsible for braking, steering, starting to drive, and controlling the speed and the distance from other vehicles.

- Turn on the adaptive cruise assist only if the surrounding conditions permit it. Always adapt your driving style to the current visual, weather, road, and traffic conditions.
- Switch the adaptive cruise assist off temporarily when driving in turning lanes or highway exits. This prevents the vehicle from accelerating to the stored speed when in these situations.
- If you press the **SET** button **2** when driving at speeds below 20 mph (30 km/h), the minimum possible speed that the system can maintain will be set. If no vehicle is detected ahead of you, the vehicle will accelerate up to that speed.

i Tips

- Always keep your hands on the steering wheel so you can be ready to steer at any time. The driver is always responsible for adhering to the regulations applicable in the country where the vehicle is being operated.
- If you switch the ignition or the adaptive cruise assist off, the stored speed is erased for safety reasons.
- When the adaptive cruise assist is switched on, the ESC and the ASR are switched on automatically.
- The system cannot be switched off or it may be interrupted if the road exceeds the maximum possible grade for safe operation.

Switching lane guidance on and off

Applies to: vehicles with adaptive cruise assist and lane guidance



Fig. 98 Turn signal lever: button for lane guidance and lane departure warning

Within the limits of the system, lane guidance provides corrective steering to assist the driver with keeping the vehicle in the center of the lane as much as possible. This feature can be deactivated.

Switching lane guidance on and off

Requirement: lane guidance must be preselected in the MMI ⇒ *page 123*.

- ▶ To activate or deactivate the availability of the lane guidance, press the button on the turn signal lever ⇒ *fig. 98*.

The system will assist the driver by providing corrective steering only when adaptive cruise assist is actively regulating and availability is switched on.

Overview of displays and lane guidance limitations

The availability of lane guidance is shown with indicator lights and with arrows **11** ⇒ *page 117*, *fig. 95* in the **Driver assistance** display.



 – Lane guidance is active.

 – This indicator light turns on if the limits of the system have been reached (for example, the system's steering force is not sufficient to handle tight curves). Take over steering. ▶

If  turns white, lane guidance is switched on but is not active. This may occur due to the following system limits or situations:

- The necessary lane marker lines have not been detected (for example, in a construction zone or because the lines are obstructed by snow, dirt, water, or lighting)
- The lane is too narrow or too wide
- The curve is too narrow
- The driver's hands are not on the steering wheel
- Visibility is obstructed by a rise or dip.
- The turn signal was activated.

Steering intervention request

If no steering activity is detected or the limits of the system are reached, the driver steering intervention request will alert the driver using audio and visual signals, such as  or . Take over the steering and keep your hands on the steering wheel so that you will be ready to steer at any time. The system will become inactive after a short time and will only be active again later.

If the driver does not take over steering, the adaptive cruise assist will be switched off.

WARNING

Observe the safety precautions and note the limits of the assist systems, sensors, and cameras ⇒ *page 106*.

Tips

- Always keep your hands on the steering wheel so you can be ready to steer at any time. The driver is always responsible for adhering to the regulations applicable in the country where the vehicle is being operated.
- It is recommended to only switch on lane guidance on well-constructed roads.
- The ⇒ *fig. 98* button switches lane guidance availability and the lane departure warning on or off simultaneously, if lane guidance is preset in the adaptive cruise assist settings.



Setting the distance

Applies to: vehicles with adaptive cruise assist



Fig. 99 Operating lever: setting the distance

If you adjust the speed, you must also change the time gap to the vehicle driving ahead. The higher the speed, the greater the distance that is needed.

- ▶ Tap the rocker switch to display the distance that is currently set.
- ▶ To increase or decrease the distance in increments, tap the switch again toward  or .

The newly-set distance will be shown briefly, for example with the  indicator light. In the **Driver assistance** display, a graphic display is shown instead of the indicator lights ⇒ *page 117, fig. 95*. The display matches the functions of the indicator lights.

When approaching a vehicle driving ahead, the adaptive cruise assist brakes to the set speed and then maintains the set distance. If the vehicle driving ahead accelerates, then the adaptive cruise assist will also accelerate up to the speed that you have set.

The following distances can be set: 

Symbol	Meaning
	The time between is approximately 1 second. This setting corresponds to a distance of approximately 92 feet (100 m) when traveling at 62 mph (28 m/h).
	The time between is approximately 1.3 seconds. This setting corresponds to a distance of approximately 118 feet (100 m) when traveling at 62 mph (36 m/h).
	The time between is approximately 1.8 seconds. This setting meets the general recommendation of “half the speed shown on the speedometer”. This corresponds to a distance of approximately 164 feet (50 m) when traveling at 62 mph (100 km/h).
	The time between is approximately 2.4 seconds. This setting corresponds to a distance of approximately 219 feet (100 m) when traveling at 62 mph (67 m/h).
	The time between is approximately 3.6 seconds. This setting corresponds to a distance of approximately 328 feet (100 m) when traveling at 62 mph (100 m/h).

WARNING

Observe the safety precautions and note the limits of the assist systems, sensors, and cameras ⇒ *page 106*.

Tips

- When setting the distance, the driver is responsible for adhering to any applicable legal regulations.
- Depending on the selected driving program and distance, driving behavior when accelerating may vary from moderate to sporty ⇒ *page 123, Adjusting the adaptive cruise assist*.
- The distances provided are specified values. Depending on the driving situation and how the vehicle ahead is driving, the actual dis-

tance may be more or less than these target distances.

Overriding control

Applies to: vehicles with adaptive cruise assist



Fig. 100 Lever: overriding the control

Requirement: the adaptive cruise assist must be switched on.

Overriding control

You can completely override the control, for example when passing or if you would like to accelerate more quickly.

- ▶ To accelerate manually, pull the lever toward you in the direction of the arrow and hold it there, or press the accelerator pedal.
- ▶ To resume the usual cruise control, release the lever or remove your foot from the accelerator pedal.

When you are in the **Driver assistance** display, the message **Overridden** will appear.

WARNING

- Observe the safety precautions and note the limits of the assist systems, sensors, and cameras ⇒ *page 106*.
- Resting your foot on the accelerator pedal could override the cruise control. Braking interventions and corrective actions by the system may not occur.

Driving in stop-and-go traffic

Applies to: vehicles with adaptive cruise assist





Applies to: vehicles with safe start monitor
Fig. 101 Instrument cluster: safe start monitor

Stopping with adaptive cruise assist

The adaptive cruise assist also assists you in stop-and-go traffic. Within the limits of the system, your vehicle may brake and remain at a stop if a vehicle driving ahead stops.

Starting to drive with adaptive cruise assist



As long as the message **ready to drive** and  is displayed, your vehicle will begin driving when the vehicle ahead starts to move ⇒ .

If you are stopped for several seconds, your vehicle will no longer drive autonomously for safety reasons, and the message will turn off.

- ▶ To extend **ready to drive** for several seconds or reactivate, pull the lever briefly towards you in the direction of the arrow ⇒ *page 121, fig. 100*.
- ▶ To resume manual control of the vehicle, tap the accelerator pedal.

Safe start monitor

Applies to: vehicles with safe start monitor

The vehicle can still start to drive even if certain obstacles are detected when starting to drive ⇒ . If the surrounding area detection detects an obstacle, you will be alerted to the danger by the  indicator light.

If you are in the **Driver assistance** display, the display  ⇒ *fig. 101* and the message **Warning!** will also appear. An audio signal will also sound. Your vehicle will drive more slowly when starting. This may also occur in some situations when there is no apparent obstacle.

- ▶ Press the brake pedal to slow your vehicle down.

WARNING

- Observe the safety precautions and note the limits of the assist systems, sensors, and cameras ⇒ *page 106*.
- If the message **ready to drive** appears, your vehicle will start driving even if there is an obstacle between your vehicle and the vehicle ahead. To reduce the risk of an accident, always make sure there are no obstacles between your vehicle and the vehicle driving ahead.

Tips

For safety reasons, adaptive cruise assist is only active if:

- The driver's safety belt is fastened
- All doors and the hood are closed
- Your vehicle is not stopped for a long period of time

Driver intervention request

Applies to: vehicles with adaptive cruise assist

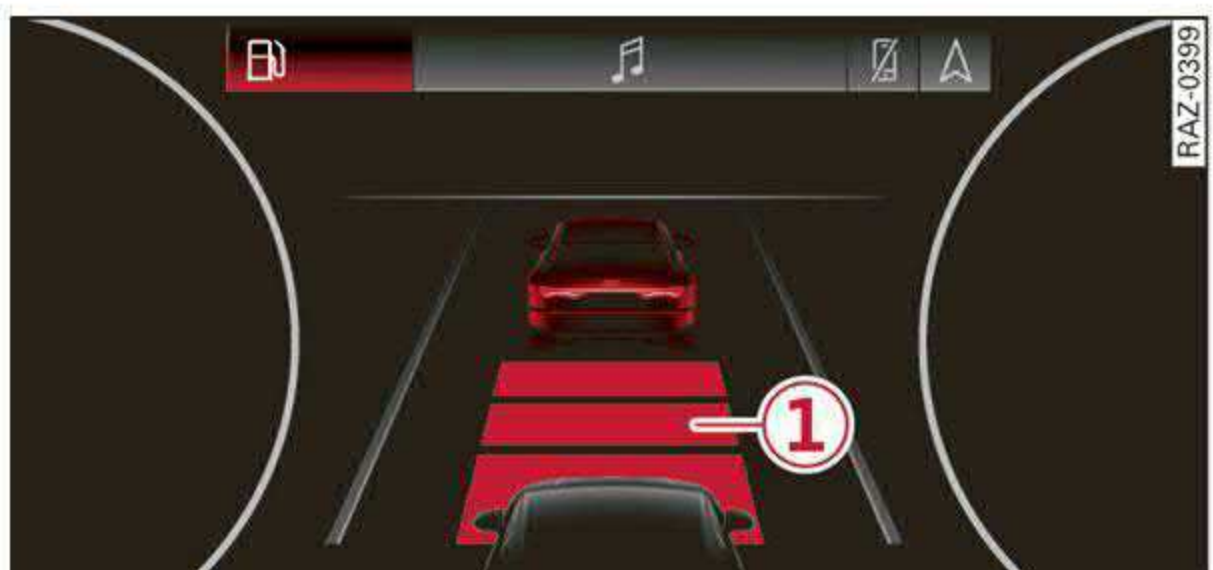



Fig. 102 Instrument cluster: request for driver intervention

The request for driver intervention instructs you to resume manual control of the vehicle if the adaptive cruise assist braking function is not able to maintain a sufficient distance to the vehicle ahead. The system will warn you of the hazard with the  indicator light and the message **Distance!**. An audio signal will also sound.

The display  only appears when the **Driver assistance** display is open in the on-board computer ⇒ *page 14*.

WARNING

Observe the safety precautions and note the limits of the assist systems, sensors, and cameras ⇒ *page 106*.

Adjusting the adaptive cruise assist

Applies to: vehicles with adaptive cruise assist

You can adjust the adaptive cruise assist to your own preferences. The settings depend on the vehicle equipment.

- ▶ Applies to: MMI: Select on the home screen: **VEHICLE > Driver assistance > Adaptive cruise assist**.

Possible settings:

Lane guidance¹⁾ – You can set if lane guidance should be on or off when when adaptive cruise assist control is active.

Applies to: vehicles without Audi drive select

Driving program – Depending on the driving program and the distance that are set, the vehicle handling will be adjusted from **Sport** to **Moderate** and the lane guidance* haptic feedback will be adjusted.



Applies to: vehicles with Audi drive select

The driving behavior and haptic feedback from the lane guidance* will be adapted based on the selected Audi drive select mode ⇒ *page 98*.

Store last distance - The last distance that was set will be stored after the ignition is switched off. If the distance is not stored, distance  (time distance of approximately 1.8 seconds) is automatically preset every time the ignition is switched on.

Messages

Applies to: vehicles with adaptive cruise assist

If  or  is displayed when there is a malfunction, the adaptive cruise assist functions may be unavailable or limited.

A message that indicates the cause and possible solution may appear with some displays. The weather conditions may be too poor or a sensor may be covered. Clean the area in front of the sensors ⇒ *page 108* and try to turn the system on again later.

If the malfunction remains, drive to an authorized Audi dealer or authorized Audi Service Facility immediately to have the malfunction corrected.

 Please take over!

This message appears if the vehicle rolls back when starting on a slight incline, even though the systems are active. Press the brake pedal to prevent the vehicle from rolling or starting to move. The message will also appear, for example if the steering power from the system is not sufficient and adaptive cruise assist is switched off.

Distance warning**Description**

Applies to: vehicles with distance warning

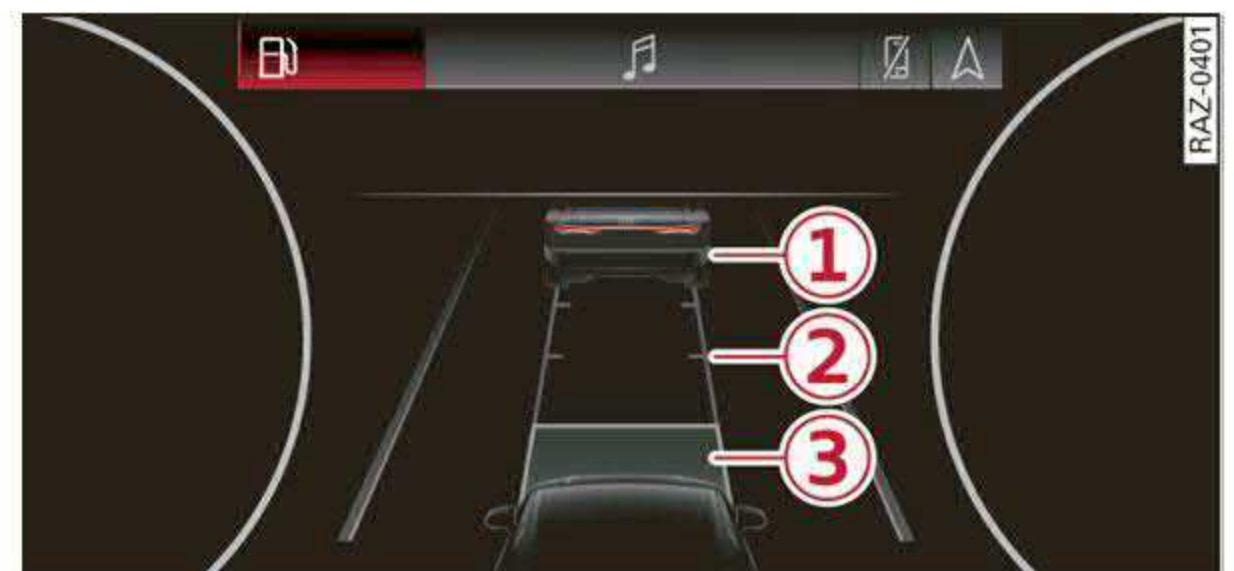

Applies to: vehicles with adaptive cruise assist

Fig. 103 Instrument cluster: display of the current distance



Applies to: vehicles with adaptive cruise assist:

Fig. 104 Instrument cluster: distance warning

¹⁾ The setting can only be accessed when lane departure warning is switched on.

General information

At speeds above approximately 40 mph (65 km/h), this function measures the distance to the vehicle ahead as time. If the distance falls below the warning threshold and remains there, the system will warn you of the hazard with the  indicator light.

Image in the Driver assistance display

Applies to: vehicles with adaptive cruise assist

The display only appears if the **Driver assistance** display is selected on the on-board computer ⇒ *page 14* and the adaptive cruise assist is not actively controlling the vehicle.



- ① Detected vehicle driving ahead
- ② Use the markings to help you estimate the distance to an obstacle. Each marking represents approximately one second.
- ③ Set warning threshold. Depending on the settings, the display will be colored in from the bottom to the top.
- ④ The actual distance is smaller than the set distance and you will be informed about the danger.

Adjusting the distance warning

The system can be switched on or off in the MMI and you can customize the distance warning threshold. The settings depend on the vehicle equipment.

– Applies to: MMI: Select on the home screen: **VEHICLE > Driver assistance > Distance warning**.

Messages

If  or  is displayed when there is a malfunction, the distance warning functions may be unavailable or may be limited.

A message that indicates the cause and possible solution may appear with some displays. The weather conditions may be too poor or a sensor may be covered. Clean the area in front of the sensors ⇒ *page 108* and try to turn the system on again later.

If the malfunction remains, drive to an authorized Audi dealer or authorized Audi Service Facili-

ty immediately to have the malfunction corrected.

WARNING

Observe the safety precautions and note the limits of the assist systems, sensors, and cameras ⇒ *page 106*.

Tips

- The driver is always responsible for adhering to the regulations applicable in the country where the vehicle is being operated.
- You may fall below the warning threshold briefly when passing or when quickly approaching a vehicle driving ahead. There is no warning in this scenario. A warning is given only if you fall below the warning threshold for an extended period of time.

Lane departure warning

General information

Applies to: vehicles with lane departure warning

The lane departure warning can detect lane marker lines within the limits of the system. If you are approaching a detected lane marker and it appears likely that you will leave the lane, the system can warn you with corrective steering and a steering wheel vibration, if necessary.

The system functions in the speed range of approximately 40 mph - 155 mph (65 km/h - 250 km/h).

WARNING

Observe the safety precautions and note the limits of the assist systems, sensors, and cameras ⇒ *page 106*.

Description

Applies to: vehicles with lane departure warning



Fig. 105 Turn signal lever: lane departure warning button

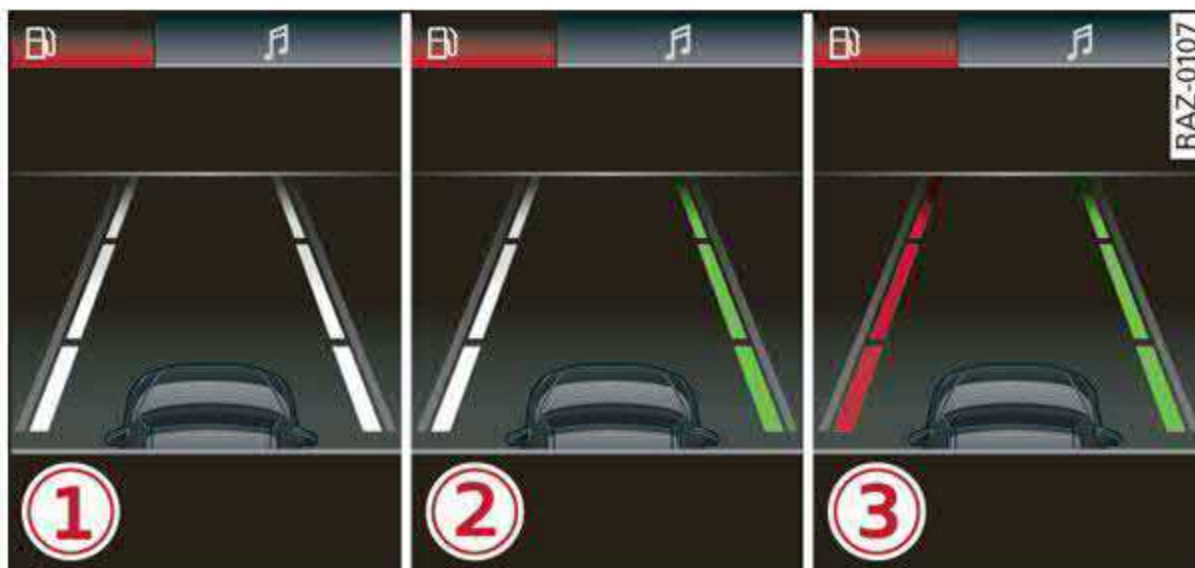



Fig. 106 Instrument cluster: driver assistance display

Switching the lane departure warning on and off

- ▶ To switch the system on or off, press the button ⇒ *fig. 105*. The respective indicator light in the instrument cluster will turn off or on.

Display and warning

The availability and readiness to provide warnings will be indicated with the    indicator lights. You can also open the **Driver assistance** display in the on-board computer ⇒ *page 14*. The display matches the functions of the indicator lights.

- ① White lines: the lane departure warning is switched on but not ready to provide warnings.
- ② Green line: the lane departure warning is ready to provide warnings on the respective side.
- ③ Corrective steering will be indicated with . If the lane departure warning must intervene for a long period of time, a message will request the driver to drive in the center of the lane. The steering wheel can also vibrate to

warn you if lane boundaries are detected during a passing maneuver.

The lane departure warning is ready to provide warnings if an object is detected on at least one side of the individual lane.

If the  indicator light turns on, the lane departure warning is not ready to provide warnings. This may occur due to the following system limits or situations:

- The necessary lane marker lines have not been detected (for example, in a construction zone or because the lines are obstructed by snow, dirt, water, or lighting)
- The speed is below the activation speed
- The lane is too narrow or too wide
- The curve is too narrow
- The driver's hands are not on the steering wheel
- Visibility is obstructed by a rise or dip.

Steering intervention request

If the lane departure warning intervenes multiple times when no steering activity is detected, the steering intervention request will provide a warning using audio and visual signals, such as . Take over the steering and keep your hands on the steering wheel so that you will be ready to steer at any time. The system may no longer be ready to provide warnings after a short time, and it will only become active again later.

If the driver does not take over steering, the lane departure warning will be switched off.

Behavior when a turn signal is active

Applies to: vehicles with side assist: The system will not warn you if you activate a turn signal before crossing the lane marker line. In this case, it assumes that you are changing lanes intentionally.

Applies to: vehicles with side assist: If the turn signal is activated, the lane departure warning is ready, and a lane change has been classified as critical by the lane departure warning due to vehicles traveling beside you or due to approaching vehicles, then a noticeable corrective steering movement will occur shortly before exiting the

lane. This will attempt to keep your vehicle in the lane.

WARNING

- Observe the safety precautions and note the limits of the assist systems, sensors, and cameras ⇒ *page 106*.
- The system warns the driver that the vehicle is leaving the lane using corrective steering. The driver is always responsible for keeping the vehicle within the lane.
- Corrective steering may not occur at all in certain situations, such as during heavy braking. Always be ready to intervene.

Tips

- Always keep your hands on the steering wheel so you can be ready to steer at any time. The driver is always responsible for adhering to the regulations applicable in the country where the vehicle is being operated.
- The system does not provide any corrective steering or steering wheel vibrations if it detects that you are passing another vehicle.

Adjusting the lane departure warning



Applies to: vehicles with lane departure warning

The additional warning using vibration in the steering wheel can be switched off or on. The settings depend on the vehicle equipment.

- Applies to: MMI: Select on the home screen: **VEHICLE > Driver assistance > Lane departure warning > Vibration warning**.

Messages

Applies to: vehicles with lane departure warning

If  or  is displayed when there is a malfunction, the lane departure warning and lane guidance functions of the adaptive cruise* functions may be unavailable or limited.

A message that indicates the cause and possible solution may appear with some displays. The weather conditions may be too poor or the camera may be covered. Clean the area in front of the

camera ⇒ *page 108, fig. 87* and try to turn on the systems again later.

If the malfunction remains, drive to an authorized Audi dealer or authorized Audi Service Facility immediately to have the malfunction corrected.

Audi pre sense

Introduction

Applies to: vehicles with Audi pre sense

Within the limits of the system, the Audi pre sense functions can initiate measures in certain driving situations to protect the vehicle occupants and other road users. Depending on the vehicle equipment, various Audi pre sense systems may be installed:

- **Audi pre sense basic** can react during emergency and dangerous braking maneuvers and unstable driving situations (such as oversteering or understeering).
- **Audi pre sense front** can detect an impending frontal impact and react with warnings, braking interventions, and preemptive safety measures for the vehicle occupants.

Audi pre sense preemptive safety measures

Applies to: vehicles with Audi pre sense

Depending on the vehicle speed and the vehicle equipment, the following functions may be initiated in certain situations:

- Visual and audio warnings
- Reversible tensioning of the front safety belts
- Closing the windows and panoramic glass roof

WARNING

Observe the safety precautions and note the limits of the assist systems, sensors, and cameras ⇒ *page 106*.

Tips

- Depending on the dangerous situation that is detected and the selected Audi drive select* mode, all preemptive safety measures may not be initiated under certain

circumstances. Certain functions can be adjusted or skipped if necessary.

- Audi pre sense may also be limited or unavailable under certain circumstances, for example if:
 - There are passengers with unfastened safety belts
 - After turning on the ignition, as long as the  indicator light is on.
 - When driving in reverse
 - The front passenger's airbag is switched off
 - There is an airbag control module malfunction
 - When ESC is restricted or switched off

Audi pre sense basic

Applies to: vehicles with Audi pre sense basic

Audi pre sense basic is automatically active at speeds of approximately 20 mph (30 km/h) and higher. Audi pre sense basic can trigger the Audi pre sense preemptive safety measures during emergency braking and dangerous braking maneuvers as well as in unstable driving situations, such as oversteering or understeering.

WARNING

Observe the safety precautions and note the limits of the assist systems, sensors, and cameras ⇒ *page 106*.

Audi pre sense front

Applies to: vehicles with Audi pre sense front

Within the limits of the system, Audi pre sense front can warn about an impending front end collision and brake the vehicle strongly, if necessary. The system uses the data from the front radar sensors and is available at speeds above approximately 3 mph (5 km/h).

Driving situations

The situations to which the system reacts depends on the vehicle speed.

Up to speeds of approximately 40 mph (65 km/h), the system may react to the following situations:

- Pedestrians¹⁾ moving across the lane
- Pedestrians¹⁾ in your lane traveling in the same direction as your vehicle

Up to speeds of approximately 50 mph (85 km/h), the system may react to the following situations:

- When approaching a stationary vehicle

Up to speeds of approximately 155 mph (250 km/h), the system may react to the following situations:

- A vehicle driving ahead clearly applies the brakes
- When approaching a vehicle ahead that is clearly traveling more slowly
- When approaching a stopped vehicle, as long as the system has already detected that this vehicle is driving in the same direction as your vehicle.

Prewarning

The system can provide warnings about detected dangers at speeds above approximately 20 mph (30 km/h). **Audi pre sense**  appears in the instrument cluster and an audio signal plays.

A brief application of the brakes

If a collision with vehicles is imminent, there may be an acute warning using a brief application of the brakes. You will also be warned about the danger by an indicator in the instrument cluster display. You may only be able to avoid a collision by swerving or braking strongly.

Braking force increase

If there is an impending collision and you are not applying the brakes enough, the braking force may be increased, depending on the situation.

Automatic braking

If you do not react to the acute warning, the system may apply the brakes with increasing braking ►

¹⁾ This is not available in some countries.

force in order to reduce the speed of impact in the event of a collision.

Take-over

If the brakes are applied until the vehicle is stationary (full deceleration),  **Please take over!** will appear in the instrument cluster and you must take over control of the vehicle.

WARNING

- Observe the safety precautions and note the limits of the assist systems, sensors, and cameras ⇒ *page 106*.
- Audi pre sense front cannot overcome natural physical laws. It is a system designed to assist and it cannot prevent a collision in every circumstance. The driver must always intervene. The driver is always responsible for braking at the correct time. Do not let the increased safety provided tempt you into taking risks. This could increase your risk of a collision.
- Among other things, Audi pre sense front does not react to cyclists, pedestrians who are stationary, stopped, crossing at an angle or traveling toward your vehicle, groups of pedestrians, animals, crossing vehicles, oncoming vehicles, or objects, such as posts, guardrails, and railway vehicles.
- Audi pre sense front may be limited or unavailable in curves or when it is dark.
- Loose objects can be thrown around the vehicle interior during sudden driving or braking maneuvers, which increases the risk of an accident. Store objects securely while driving.
- In trailer mode, the braking behavior of the trailer can be different than usual during automatic braking.

Tips

If you switch off the ESC, Audi pre sense also switches off automatically.

Adjusting Audi pre sense

Applies to: vehicles with Audi pre sense

You can adjust Audi pre sense functions to your preferences. The settings depend on the vehicle equipment.

- ▶ Applies to MMI: Select on the home screen: **VEHICLE > Driver assistance > Audi pre sense**.

Possible settings:

The system can be switched off and on.

Prewarning - The prewarning can be switched off or the Audi pre sense warning time can be set (**Early/Medium/Late**).



Set the warning time for the early warning to **Early** at first. If you feel that the prewarnings appear too early, then set the warning time to **Medium**. The **Late** warning time should only be set in special circumstances.

Tips

- If Audi pre sense is switched off, it switches on again automatically once the ignition is switched on again¹⁾.
- Switch Audi pre sense off when you are not using public streets, when loading the vehicle onto a vehicle carrier, train, ship, or other type of transportation, or when towing the vehicle. This can help to prevent an undesired intervention from the Audi pre sense system.

Messages

Applies to: vehicles with Audi pre sense

If  or  is displayed when there is a malfunction, the Audi pre sense functions may be unavailable or may be limited.

A message that indicates the cause and possible solution may appear with some displays. The weather conditions may be too poor or a sensor may be covered. Clean the area in front of the sensors ⇒ *page 108* and try to turn on the systems again later.

¹⁾ In certain countries

If the malfunction remains, drive to an authorized Audi dealer or authorized Audi Service Facility immediately to have the malfunction corrected.

Side assist

Description

Applies to: vehicles with side assist

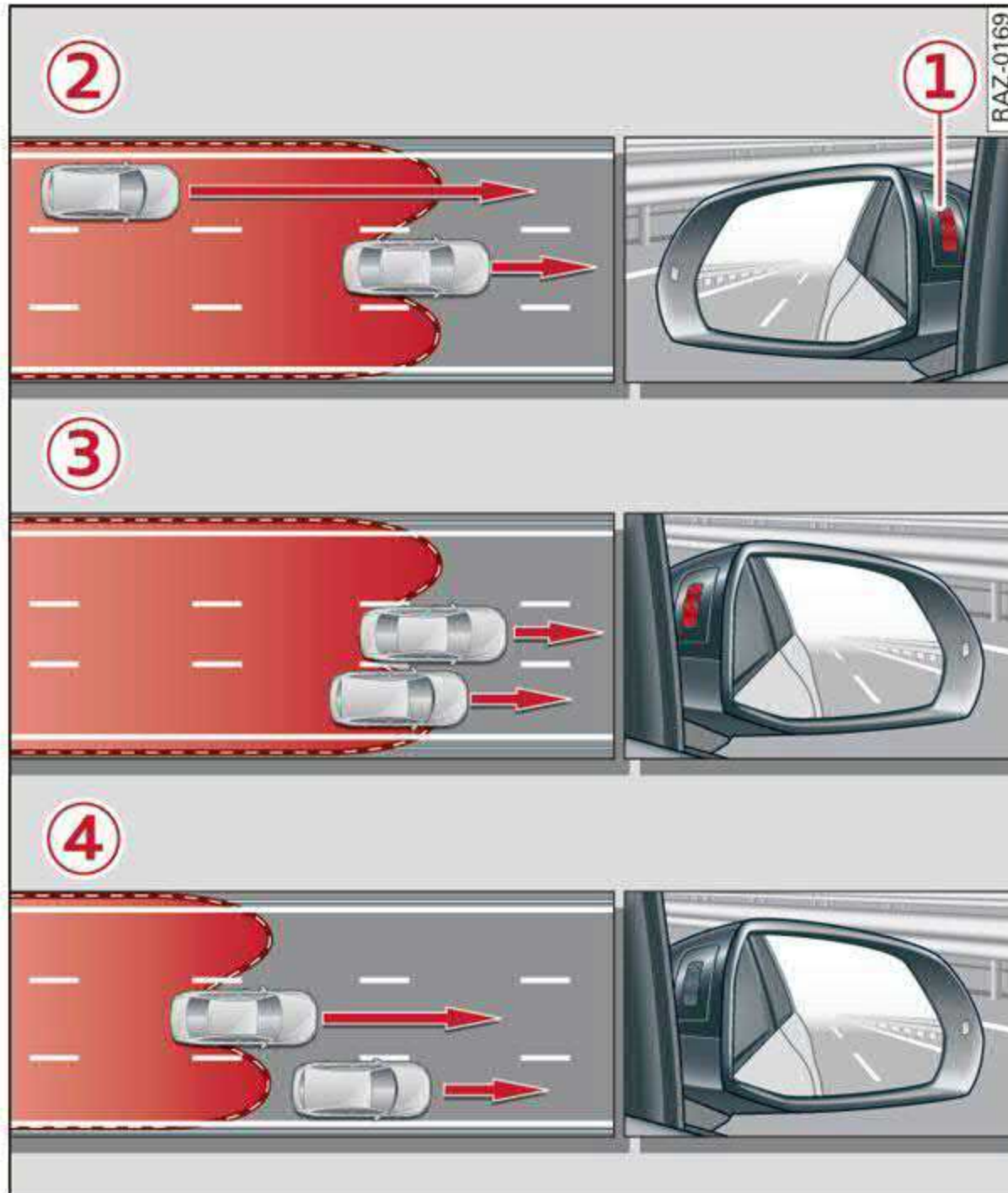

Fig. 107 Examples: driving situations and exterior mirror display

General information

Side assist monitors the blind spot and traffic behind your vehicle. Within the limits of the system, side assist can detect traffic that is approaching from behind and provide a warning when you are changing lanes. The system uses the data from the radar sensors at the rear corners of the vehicle.

The side assist is active at walking speeds and higher. If an object that is classified as critical is approaching, the display in the exterior mirror **①** on the corresponding side of the vehicle will light up.

Driving situations

The system can provide warnings about the following risks:

- ②** Approaching vehicles: a vehicle may be classified as critical in some cases, even if it is farther away. The faster a vehicle approaches, the sooner the display in the outside mirror will turn on.
- ③** Vehicles traveling in the same direction: the indicator will turn on in the outside mirror when vehicles traveling in the same direction are classified as critical. The side assist warns you of all detected vehicles when they are in the blind spot or before they reach that point.
- ④** Vehicles you are passing: if you slowly pass a vehicle that side assist has detected (the difference in speed between the vehicle and your vehicle is less than 9 mph (15 km/h)), the display in the exterior mirror will turn on when the vehicle enters your blind spot. The display will not turn on if you quickly pass a vehicle that side assist has detected (the difference in speed is greater than approximately 9 mph (15 km/h)).

Information stage

At the information level, the side assist informs you of detected objects that are classified as critical.

The display remains dim in the information stage so that you are not distracted while looking forward.

Warning stage

If the display in a mirror blinks brightly when you activate a turn signal, side assist is warning you about detected objects classified as critical.

Depending on the vehicle equipment and other driver assistance systems, the display in the mirror may also flash if you have not activated a turn signal. If you are approaching a detected lane marker line and it appears you will be leaving the lane, the display in the mirror will warn you about detected vehicles that are classified as critical. You can also be warned with corrective steering ⇒ page 124, Lane departure warning. ►

Detection range

The radar sensors are designed to detect the left and right adjacent lanes when the road lanes are the normal width. In some situations, the display in the exterior mirror may turn on even though there is no vehicle located in the area that is critical for a lane change. For example:

- If the lanes are narrow or if you are driving on the edge of your lane. If this is the case, the system may have detected a vehicle in another lane that is *not* adjacent to your current lane.
- If you are driving through a curve. Side assist may react to a vehicle that is in the same lane or one lane over from the adjacent lane.
- If side assist reacts to other objects (such as roadside structures like guard rails).

WARNING

- Observe the safety precautions and note the limits of the assist systems, sensors, and cameras ⇒ *page 106*.
- The display may not appear in time when vehicles are falling behind or approaching very quickly.

Tips

- If the window glass in the driver's door or front passenger's door has been tinted, the display in the exterior mirror may be incorrect.
- The system is not available when towing a trailer. There is no guarantee the system will switch off when using a retrofitted trailer hitch. Do not use these functions when towing a trailer.
- The coverage areas of the sensors ⇒ *fig. 107* are diagrams and do not represent a true-to-scale image of the sensor ranges.
- The system complies with United States FCC regulations and ISED regulations ⇒ *page 267*.

Adjusting side assist

Applies to: vehicles with side assist

You can adjust the side assist to your preferences. The settings depend on the vehicle equipment.

- ▶ Applies to: MMI: Select on the home screen: **VEHICLE > Driver assistance > Side assist**.



Possible settings:

The system can be switched on and off. If the system is switched on, the displays in the exterior mirrors will turn on briefly each time the ignition is switched on.

Brightness – Change the brightness only when side assist is switched on, so that the selected setting can be checked in the exterior mirror displays. Adjust the brightness to a level where the display will not interfere with your view ahead. Because the display brightness automatically adapts to the ambient light, it may have already been adjusted to the highest or lowest setting during the automatic adaptation.

Messages

Applies to: vehicles with side assist

If  or  is displayed when there is a malfunction, the side assist functions may be unavailable or may be limited.

A message that indicates the cause and possible solution may appear with some displays. The weather conditions may be too poor or a sensor may be covered. Clean the area of the sensors at the rear corners of the vehicle ⇒ *page 108, fig. 88* and try to turn the system on again later.

If the malfunction remains, drive to an authorized Audi dealer or authorized Audi Service Facility immediately to have the malfunction corrected.

Parking and maneuvering

Introduction

Depending on the vehicle equipment, various parking aids will help you when parking and maneuvering.

Parking aid

The **parking aid plus** assists you while parking using audio and visual signals to warn you about objects detected in front of, behind, and next to* the vehicle ⇒ *page 131*.

The **rearview camera** shows the area behind the vehicle in the center display. The lines in the rearview camera image help you to park and maneuver ⇒ *page 133*.

The **peripheral cameras** are an addition to the rearview camera and help you to see various areas around the vehicle while parking and maneuvering ⇒ *page 133*.

The **rear cross-traffic assist** can warn you of approaching cross traffic when driving in reverse or exiting a parking space ⇒ *page 137*.

Assisted parking

Park assist helps you to locate suitable parking spaces and to park in them and exit them. Park assist controls the steering movements when parking in free parking spaces. The driver is still responsible for accelerating, braking, and shifting gears. The driver must always monitor the area around the vehicle and supervise the parking procedure ⇒ *page 138*.

Settings options

You can adjust parking aid functions individually. The adjustment options depend on the vehicle equipment.

- **Automatic activation** ⇒ *page 131*
- **Front and rear volume** ⇒ *page 132*
- **Entertainment fader** ⇒ *page 132*.
- **Trailer view** ⇒ *page 135*
- **View** ⇒ *page 136*
- **Rear cross-traffic assist** ⇒ *page 137*

WARNING

Observe the safety precautions and note the limits of the assist systems, sensors, and cameras ⇒ *page 106*.

Tips

Practicing parking in a traffic-free location or parking lot to become familiar with the systems is recommended. Practice parking in good light and weather conditions.

Parking aid plus

Activating and deactivating

Applies to: vehicles with parking aid plus



Fig. 108 Center console: parking aid button

General information

The parking aid assists when parking and maneuvering by providing warnings about obstacles. If the ultrasonic sensors on the vehicle ⇒ *page 107* detect an obstacle, the system will provide audio and visual warnings.

Activating and deactivating

Requirement: the vehicle speed must be under approximately 6 mph (10 km/h).

- ▶ Press the **P** button in the center console. When activating, a brief tone will sound and the LED in the button will turn on.

Automatic activation

- ▶ The system activates automatically when reverse gear is engaged while the engine is running. A brief tone will sound.
- ▶ If **Automatic activation** is switched on in the MMI and if the vehicle approaches) an obstacle ▶

at speeds below approximately 6 mph (10 km/h), the parking aid will activate automatically. Audible signals will sound once the obstacle is within the sensor detection area.

- Applies to: MMI: To switch **Automatic activation** on or off, select on the home screen: **VEHICLE > Parking aid > Automatic activation**.

Automatic deactivation

The distance indicator for the parking aid plus will deactivate automatically when driving forward faster than approximately 6 mph (10 km/h).

WARNING

Observe the safety precautions and note the limits of the assist systems, sensors, and cameras ⇒ *page 106*.

Note

Keep enough distance from the curb to avoid damage to the rims.

Tips

If the parking aid is deactivated, it can only be reactivated automatically when one of the following conditions is met:

- The vehicle speed exceeds 6 mph (10 km/h)
- The ignition is switched off and back on again
- The parking brake is set and then released
- The “P” gear was engaged and released again

Warnings

Applies to: vehicles with parking aid plus

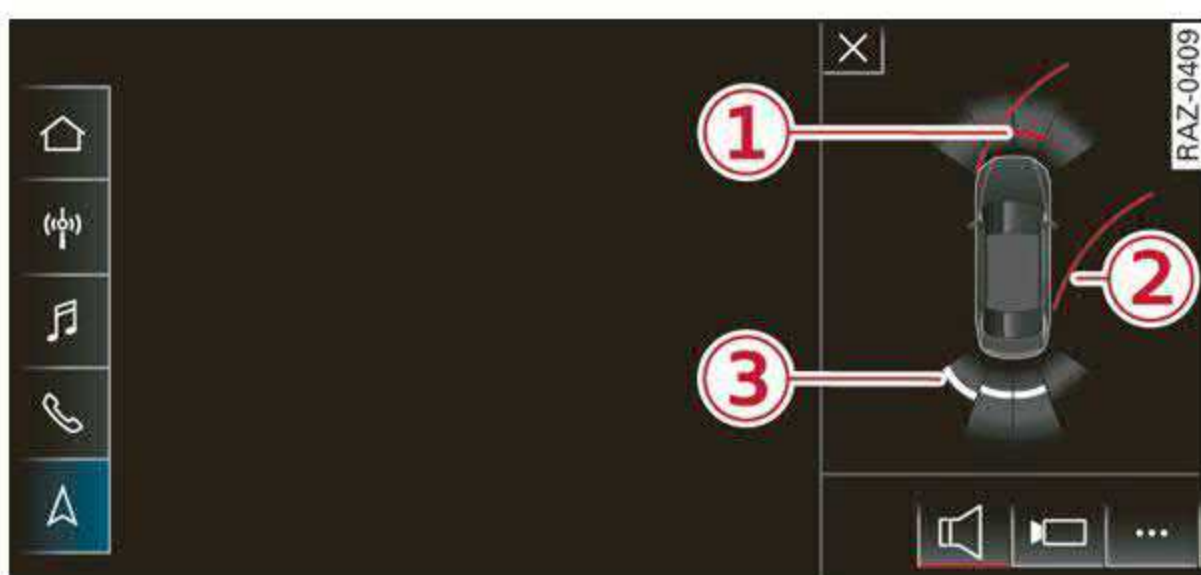

Fig. 109 Center display: distance display

If the sensors detect an obstacle, audible and visual signals will warn you.

Visual warnings

The visual warnings in the center display help you to detect the critical vehicle area and to estimate the distance to an obstacle.

Red segments ① show detected obstacles that are in your vehicle's path. The red lines ② mark the expected direction of travel based on the steering angle. A white segment ③ indicates a detected obstacle that is outside of the vehicle's path. The closer your vehicle comes to the obstacle, the closer the segments will move to the vehicle. The collision area has been reached when the next to last segment is displayed. Obstacles in the collision area, including those outside of the vehicle's path, are shown in red. Do not continue driving farther.

Audio signals

The closer your vehicle gets to a detected obstacle, the shorter the time between the audible signals. A continuous tone sounds when an obstacle is less than approximately 1 foot (0.30 m) away from the front or rear of the vehicle. A continuous tone sounds when an obstacle is less than approximately 0.7 feet (0.20 m) away from the sides* of the vehicle. Do not continue driving forward or in reverse ⇒ .

- To deactivate audio signals while parking, press  in the center display. The audio signals will be automatically activated again the next time the parking aid is activated.

Adjusting the volume

You can adjust the volume to your preferences. The settings depend on the vehicle equipment.

- Applies to MMI: Select on the home screen: **VEHICLE > Parking aid**. Or:
- Press  in the center display when the parking aid is active.

Possible settings:

Front volume - Volume for the front and side* area.



Rear volume - Volume for the rear area. ►

Entertainment fader – The volume of the audio/video source is lowered when the parking aid is activated.

The new level is demonstrated briefly* when the volume is adjusted.

Error messages

If  appears, the sensor in the respective area or the speaker is faulty. Drive immediately to an authorized Audi dealer or authorized Audi Service Facility to have the malfunction repaired. The LED in the  button may also flash when the system is activated.

If  or  is displayed when there is a malfunction, the parking aid functions may be unavailable or may be limited.

A message that indicates the cause and possible solution may appear with some displays. The weather conditions may be too poor or a sensor may be covered. Clean the area in front of the sensors ⇒ *page 108* and try to turn the system on again later.

If the malfunction remains, drive to an authorized Audi dealer or authorized Audi Service Facility immediately to have the malfunction corrected.

 **WARNING**

- Observe the safety precautions and note the limits of the assist systems, sensors, and cameras ⇒ *page 106*.
- Sensors and cameras have spots in which the surrounding area cannot be detected. Objects, animals, and people may only be detected with limitations may not be detected at all. Always monitor the traffic and the vehicle's surroundings directly and do not become distracted.

 **Note**

- Keep enough distance from the curb to avoid damage to the rims.
- Applies to: vehicles with park assist: If you park in short parking spaces using park assist, a continuous tone sounds from the parking aid when the distance to an object is

less than approximately 0.7 ft (0.20 m). Do not continue driving farther.

 **Tips**

- The segments in the side area* are detected and analyzed when passing. There may have been changes to the surrounding area after switching the ignition off and on again, after opening the doors, or if the vehicle is left stationary for a long period of time. In this scenario, the side area* will appear black until the area has been detected and evaluated.
- If the distance to an obstacle remains constant, the volume of the distance warning gradually lowers after a few seconds until it is muted (this does not apply to the continuous tone). If the obstacle comes closer than it was before the sound was muted, the tone will sound again. If the obstacle becomes farther away than it was before the sound was muted, no tone will sound. Pay attention to the vehicle's surroundings when you start to drive.
- There is no distance warning for the rear and the sides* when trailer towing mode is detected. The front sensors remain activated. The visual display switches to trailer mode. There is no guarantee the functions will be deactivated when using a retrofitted trailer hitch.

Rearview camera and peripheral cameras

Introduction

Applies to: vehicles with rearview camera/peripheral cameras

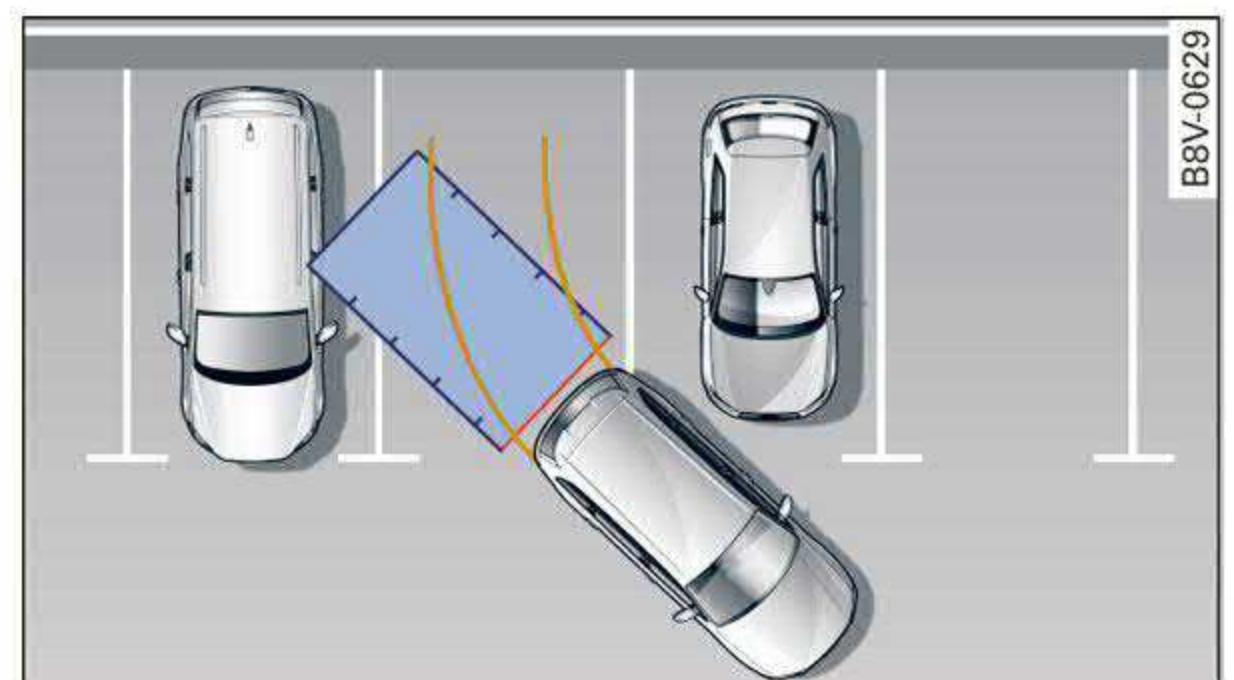

Fig. 110 Orientation line display when parking

Parking and maneuvering

Depending on the vehicle equipment, a rearview camera or multiple peripheral cameras may be available.

The **rearview camera** helps you to park or maneuver using the orientation lines.

The **peripheral cameras** expand the vehicle overview to include various views around the vehicle that can be selected.

! WARNING

Observe the safety precautions and note the limits of the assist systems, sensors, and cameras ⇒ *page 106*.

Activating and deactivating

Applies to: vehicles with rearview camera/peripheral cameras



Fig. 111 Center console: parking aid button

Activating and deactivating

- ▶ Press the **P** button in the center console. When activating, a brief tone will sound and the LED in the button will turn on. Or
- ▶ Press **▷** in the center display if the visual distance indicator is shown ⇒ *page 132, fig. 109*.

The system can be activated at low speeds, such as when maneuvering.

Automatic activation

The system activates automatically when reverse gear is engaged while the engine is running. A brief tone will sound.

Automatic deactivation

- ▶ The system will deactivate automatically once the vehicle exceeds a certain speed while driving forward.

! WARNING

Observe the safety precautions and note the limits of the assist systems, sensors, and cameras ⇒ *page 106*.

Warnings

Applies to: vehicles with rearview camera/peripheral cameras

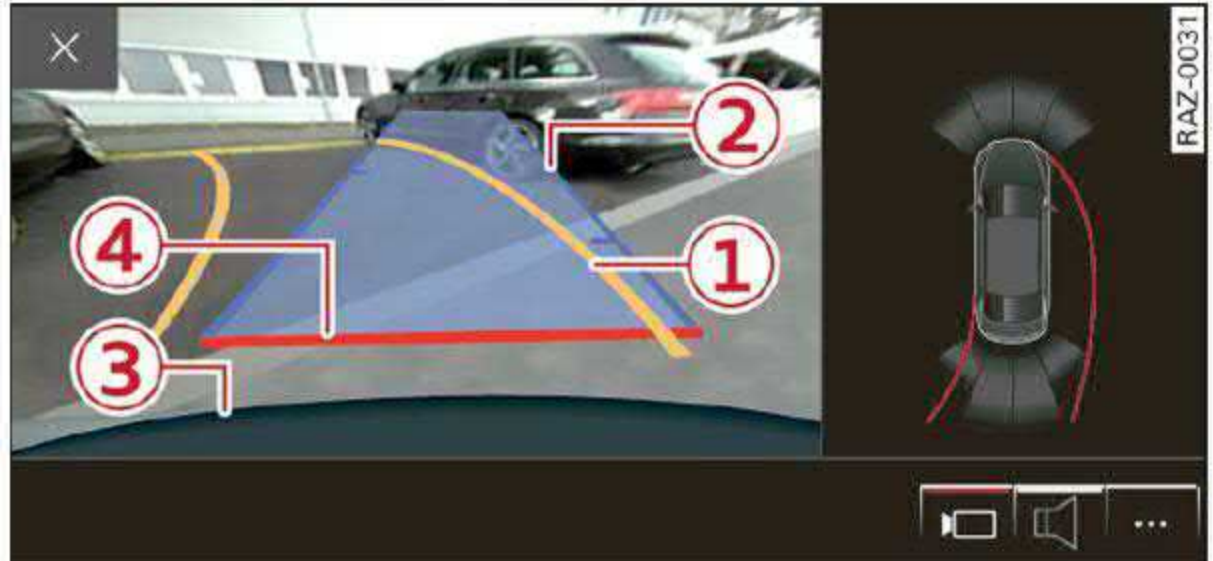
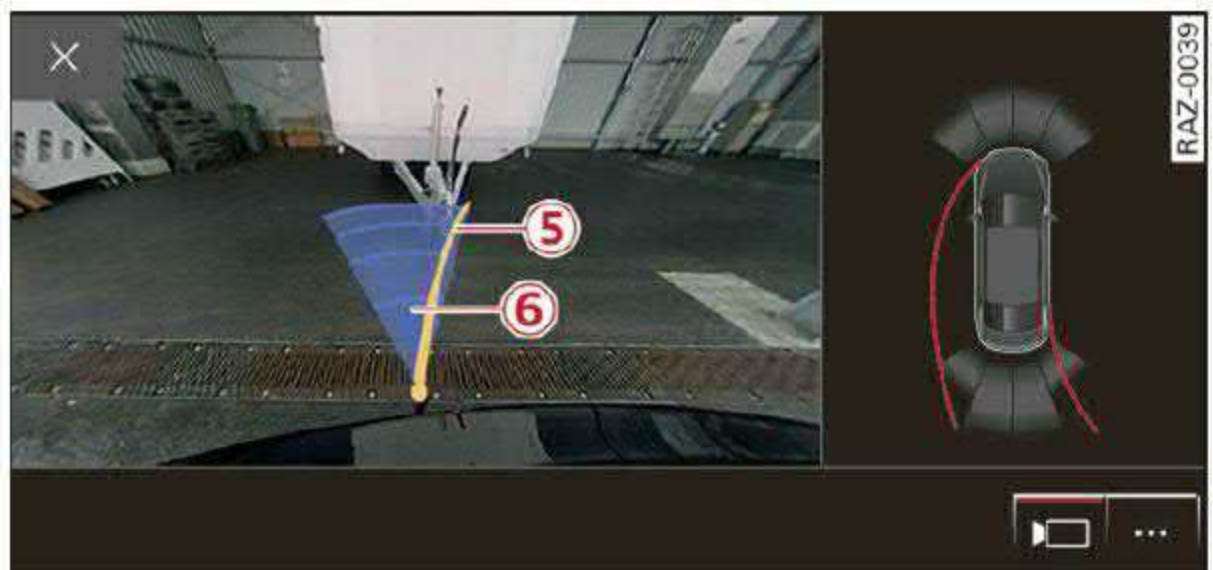

Fig. 112 Center display: aiming at a parking spot



Applies to: vehicles with trailer view

Fig. 113 Center display: trailer view

When parking with the rearview camera or peripheral camera, the parking aid plus audio and visual warnings* will also assist you ⇒ *page 132*.

Visual orientation lines



- ① The orange orientation lines show the vehicle's direction of travel ⇒ **!**. Turn the steering wheel until the orange orientation lines align with the parking space.
- ② Use the blue markings to help you estimate the distance to an obstacle. Each marking represents approximately 3 feet (1 meter). The blue area represents an extension of the vehicle's outline by approximately 16 feet (5 meters) to the rear.
- ③ You can recognize the rear bumper in the lower display.
- ④ You should stop driving in reverse when the red orientation line touches the edge of an object, at the latest.

Trailer view

Applies to: vehicles with trailer view

The trailer view ⇒ *fig. 113* assists you in positioning the vehicle in front of a trailer.

- Applies to: vehicles with peripheral cameras:
Switch to the **Rear** view ⇒ *page 136, fig. 114*.
- Select  > **Trailer view** in the center display when the parking system is active.

Now you can position your vehicle in front of the trailer. The orange orientation line  ⇒ *fig. 113* indicates the expected path toward the trailer hitch. Use the blue markings  to help you estimate the distance to the trailer hitch. Each marking represents approximately 1 foot (0.30 meters). The width of the blue surface represents the maximum steering wheel angle.

Symbols

Applies to: vehicles with peripheral cameras

If  is displayed and the display area represented by that symbol is not available, then the camera on the that side is not available. The power exterior mirrors may have been folded in or a door or the luggage compartment lid may have been opened.

If  is displayed, there is a system malfunction and the display area represented by that symbol is not available. The camera is not working in this area.

If one of the symbols continues to be displayed, drive immediately to an authorized Audi dealer or authorized Audi Service Facility to have the malfunction repaired.

WARNING

- Observe the safety precautions and note the limits of the assist systems, sensors, and cameras ⇒ *page 106*.
- Sensors and cameras have spots in which the surrounding area cannot be detected. Objects, animals, and people may only be detected with limitations may not be detected at all. Always monitor the traffic and the vehicle's surroundings directly and do not become distracted.

Note

- The orange orientation lines  show the direction the rear of the vehicle will be traveling, based on the steering wheel angle. The front of the vehicle swings out more than the rear of the vehicle. Maintain plenty of distance so that an exterior mirror or a corner of the vehicle does not collide with any obstacles.
- Keep enough distance from the curb to avoid damage to the rims.
- Only use the images provided by the camera on the rear of the vehicle when the luggage compartment lid is completely closed. Make sure any objects you may have mounted on the luggage compartment lid do not block the rearview camera.

Tips

There is no distance warning for the rear and the sides* when trailer towing mode is detected. The front sensors remain activated. The visual display switches to trailer mode. There is no guarantee the functions will be deactivated when using a retrofitted trailer hitch.

Operating the peripheral cameras

Applies to: vehicles with peripheral cameras

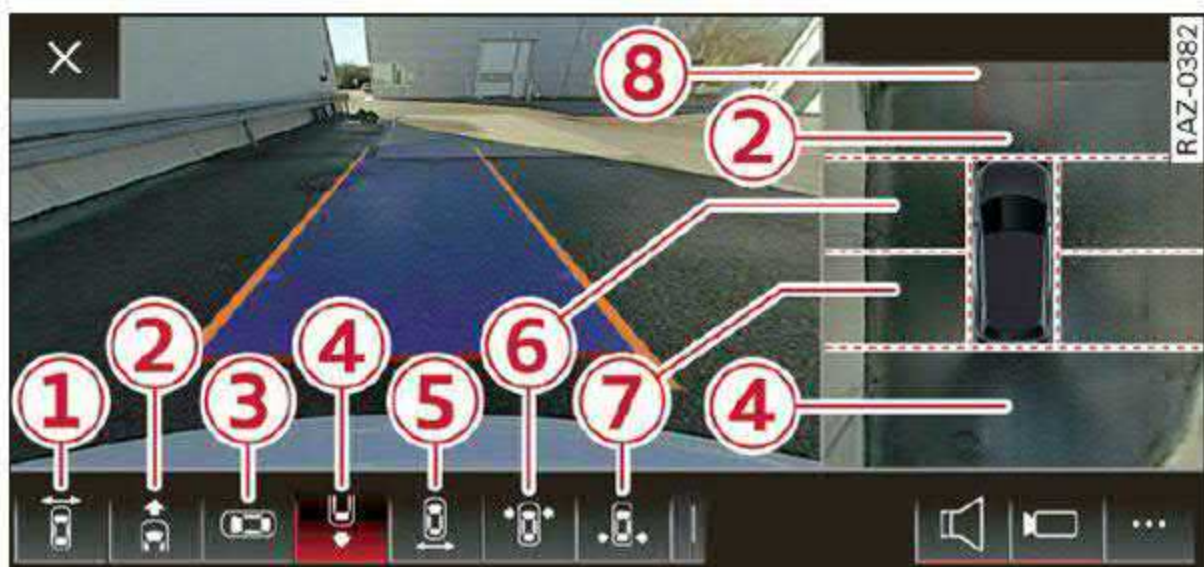

Fig. 114 Center display: peripheral cameras.

- ▶ To select a view, press ① - ⑦ in the center display or tap in an area to show the vehicle in the side view ¹⁾.

Selecting a view in the side area

The vehicle surroundings are shown in the side area of the display. You can switch between a visual display (**Graphic**) and the vehicle surroundings (**Camera**).

- ▶ Select > **View** in the center display when the parking aid is active.

On vehicles with peripheral cameras, you can select among different views.

Selecting the views

- ▶ To display the entire selection bar, tap the current view ① or swipe at the edge of the selection bar from left to right.

	Symbol/Description	Description
①	Front corner or Display selection bar	This view makes it easier to drive out of tight parking spaces or areas and intersections with poor visibility. It shows an almost 180° panorama view in front of the vehicle.
②	Front	This view assists you in using the full area for maneuvering in front of the vehicle.
③	Surroundings	This view helps you to maneuver and position the vehicle more precisely. The area around the vehicle is shown using the camera images. The vehicle image is shown by the system ⇒ .
④	Rear	This view assists you in using the full area for maneuvering behind the vehicle. This is the rearview camera image.
⑤	Rear corner	This view can assist you when driving out of tight parking spaces or areas with poor visibility. It shows an almost 180° panorama view behind the vehicle.
⑥	Front tires	This view helps you to see the distance between the front tires and the curb and the steering wheel angle when parking.
⑦	Rear tires	This view helps you to detect the distance between the rear wheels and the curb when parking.
⑧	Steering wheel angle	The red lines represent the estimated direction of travel based on the steering wheel angle ⇒ .

¹⁾ Requirement: The vehicle surroundings (**Camera**) must be selected in the **View** in the side area.

! WARNING

- Observe the safety precautions and note the limits of the assist systems, sensors, and cameras ⇒ *page 106*.
- The **Surroundings** view is created from the individual camera images. The vehicle image is shown by the system. Objects and obstacles above the camera are not displayed.

! Note

- Only use the images provided by the camera on the rear of the vehicle when the luggage compartment lid is completely closed. Make sure any objects you may have mounted on the luggage compartment lid do not block the rearview camera.
- The front of the vehicle swings out more than the rear of the vehicle. Maintain plenty of distance so that an exterior mirror or a corner of the vehicle does not collide with any obstacles.

i Tips

- Depending on the selected gear, it will automatically switch between the **Front** and **Rear** views. If you switch the view manually, the automatic front/rear camera change will be temporarily deactivated.
- When first activated while a forward gear is engaged, the **Front corner** is displayed.

Rear cross-traffic assist

Description

Applies to: vehicles with rear cross-traffic assist

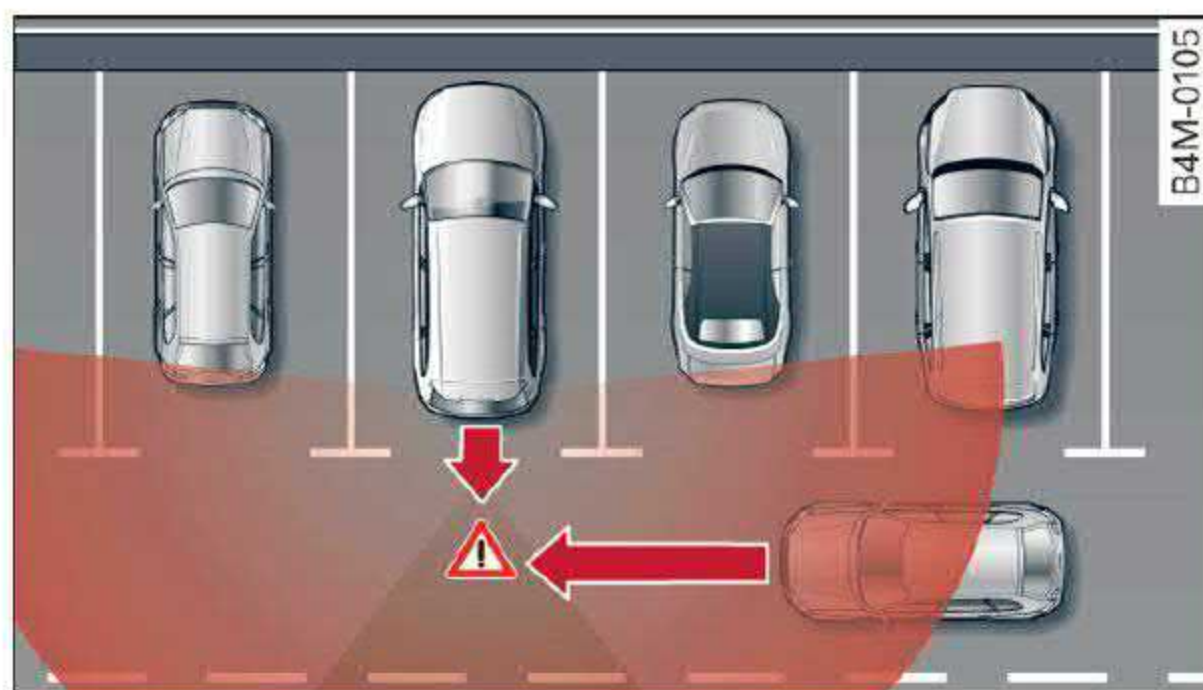

Fig. 115 Sensor detection range for rear cross-traffic assist

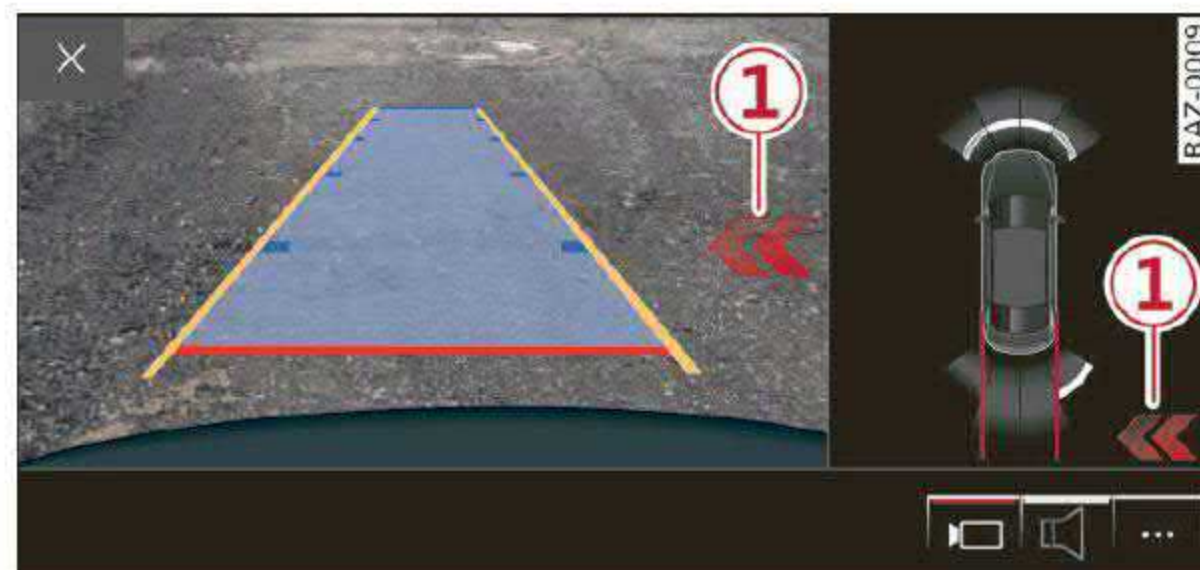

Fig. 116 Center display: rear cross-traffic assist display

General information

The rear cross-traffic assist monitors the area behind and next to the vehicle using radar sensors at the rear corners of the vehicle. The system can detect moving objects that are approaching, such as vehicles ⇒ *fig. 115*. A display in the MMI and various warnings provide assistance when exiting a parking space.

Requirements for using the rear cross-traffic assist:

- The parking system is switched on ⇒ *page 131*.
- The speed while driving backwards is not higher than approximately 6 mph (10 km/h).

Displays, warnings, and braking



- **Display:** the display ① appears only when the parking aid is active. In vehicles with peripheral cameras, the display appears in the **Rear** and **Rear corner** camera views. Arrows show the direction from which the cross traffic is approaching.
- **Audible warnings:** a continuous tone may sound as an additional warning when driving in reverse.
- **Automatic brake activation:** if you do not react to a warning, a brief braking by the system can warn you of a potential collision with an approaching object.

The audible warning signal and the automatic brake activation occur only when driving in reverse.

Switching rear cross-traffic assist on and off

- Applies to MMI: Select on the home screen: **VEHICLE > Parking aid > Rear cross-traffic assist**.
- Select **⋮ > Rear cross-traffic assist** in the center display when the parking system is active. ▶

Messages

If ,  or  is displayed when there is a malfunction, the rear cross traffic assist functions may be unavailable or may be limited.

A message that indicates the cause and possible solution may appear with some displays. The weather conditions may be too poor or a sensor may be covered. Clean the area of the sensors at the rear corners of the vehicle ⇒ *page 108*, *fig. 88* and try to turn the system on again later.

If the malfunction remains, drive to an authorized Audi dealer or authorized Audi Service Facility immediately to have the malfunction corrected.

WARNING

- Observe the safety precautions and note the limits of the assist systems, sensors, and cameras ⇒ *page 106*.
- The rear cross-traffic assist will not provide alerts about people and cannot warn you about every type of approaching objects, such as cyclists. Always monitor the traffic as well as the vehicle's surroundings with direct eye contact.
- The system may not react if objects are approaching very quickly.
- The rear cross-traffic assist will not provide alerts if your vehicle is parallel or diagonally parked or if your vehicle is pulled too far into the parking space so that it is hidden by adjacent vehicles.

Tips

- Once an automatic brake activation occurs, the system cannot brake automatically again for several seconds.
- System functions may not be available if the ESC is limited or switched off, or if there is a malfunction.
- If there is an acoustic warning signal from the rear cross-traffic assist, then the parking aid may not warn you of detected obstacles under certain circumstances.
- The system is not available when the vehicle detects that you are towing a trailer. There

is no guarantee the functions will be deactivated when using a retrofitted trailer hitch. Do not use these functions when towing a trailer.

- The system complies with United States FCC regulations and ISED regulations ⇒ *page 267*.
- The coverage areas of the sensors ⇒ *fig. 115* are diagrams and do not represent a true-to-scale image of the sensor ranges.

Assisted parking

General information

Applies to: vehicles with park assist

If your vehicle is equipped with park assist, this system helps you find suitable parking spaces. Parking spaces are measured using ultrasonic sensors on the sides of the vehicle.

If a parking space is found, the system helps you to park while the driver monitors the vehicle's surroundings with the parking aids, cameras*, and direct eye contact. The vehicle moves the steering wheel autonomously.

WARNING

Observe the safety precautions and note the limits of the assist systems, sensors, and cameras ⇒ *page 106*.

Parking options

Applies to: vehicles with park assist

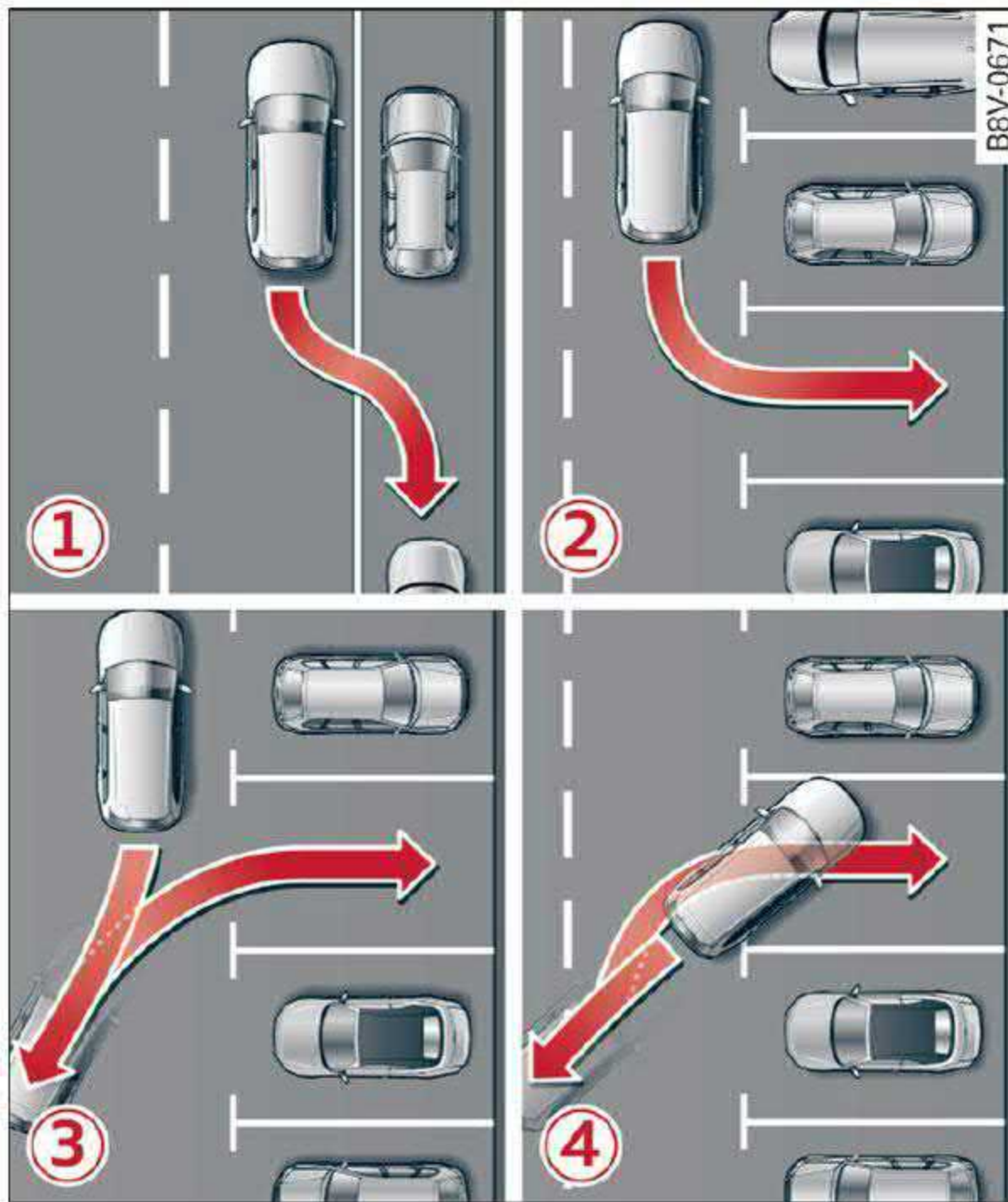

Fig. 117 Parking options overview

Parking options

- ① Backing into parallel parking spaces
- ② Backing into perpendicular parking spaces
- ③ Driving forward into perpendicular parking spaces that you have already driven past
- ④ Driving forward into perpendicular parking spaces if you have already driven to the space yourself and the front of the vehicle is already in the space

Options for exiting parking spaces

- ① Exiting parallel parking spaces

i Tips

You can also drive into a perpendicular parking space yourself and then activate the system. If this is the case, the front of the vehicle should already be in the space ④ so that the sensors can measure the space.

Parking space search

Applies to: vehicles with park assist



Fig. 118 Center console: park assist button



Fig. 119 Center display: activated parking space search

Activating the parking space search

- ▶ To activate the parking space search, press the **P** button ⇒ *fig. 118*, or
- ▶ To activate the parking space search when the parking aid is activated, press **P** in the center display.

The LED in the button will turn on and the display for finding a parking space will appear in the center display ⇒ *fig. 119*.

Searching for parking spaces

- ▶ Drive forward to the row of parking spaces at a low speed. For the best parking results, the vehicle should be approximately 3 feet (1 m) from the row of parking spaces.
- ▶ The parking space search is first done on the side of your lane. To switch the side to park on, turn on the turn signal for the other side or tap that side next to the vehicle in the center display.

Selecting the parking space

If the system finds a parking space that could be suitable for the vehicle length and width, it will ▶

be displayed. The system automatically suggests a parking option ①.

If the parking space allows different parking options, they can be selected manually. Press one of the suggested parking options ① in the center display.

Starting the parking process

As soon as the vehicle has reached the correct position, a **P** will appear in the center display above the selected parking space ③. The roof in the parking aid display ② may show the required braking or driving direction.

- ▶ Keep the vehicle as parallel as possible to the parked vehicles or to the side of the road.
- ▶ Make sure that the parking space is suitable for your vehicle ⇒ ⚠.
- ▶ Start the assisted parking process ⇒ *page 141*.

Maneuvering area

The vehicle can go off course during the parking process ⇒ ⚠. If there are obstacles within the maneuvering area that block or endanger the parking process, for example on the opposite side of the street, a message may appear. You may need to drive farther forward and stay closer to the row of parking spaces.

WARNING

- Observe the safety precautions and note the limits of the assist systems, sensors, and cameras ⇒ *page 106*.
- The driver is always responsible when entering or exiting a parking space and during similar maneuvers.
- Sensors and cameras have spots in which the surrounding area cannot be detected. Objects, animals, and people may only be detected with limitations may not be detected at all. Always monitor the traffic and the vehicle's surroundings directly and do not become distracted.

Note

- Parking spaces classified as suitable by the system may have been detected incorrectly.

The driver must decide if the parking space displayed is suitable for the vehicle.

- Certain conditions near the parking space may cause the parking process to fail, such as if the parking space is near trees or posts, or if the ground is covered, for example, with gravel, snow, or ice.

Tips

- If you did not drive past a suitable parking space too quickly, the system can also be activated afterwards by pressing **P**Ⓜ in the center display.
- The Electronic Stabilization Control (ESC) must not be switched off during the parking process. If the ESC intervenes, the parking process will be canceled.
- You can also drive into a perpendicular parking space yourself and then activate the system. If this is the case, the front of the vehicle should already be in the space ④ ⇒ *page 139, fig. 117* so that the sensors can measure the space.
- You cannot park with the parking assist systems when you are towing a trailer or have the connector inserted in the trailer socket.
- The system is not available when certain assist systems are switched on.
- If there are suitable parking spaces on both sides of the street, for example on a one-way street, you can change the side where the system is searching for parking spaces by activating the turn signal for the other side or by pressing on that side in the center display.
- The park systems do not provide support for assisted parking on tight curves.

Park assist

General information

Applies to: vehicles with park assist

The park assist helps you when parking and exiting parking spaces after the parking space search. The park assist takes over the steering of the vehicle while the driver accelerates, brakes, and monitors the vehicle's surroundings. Park assist can be interrupted at any time. ▶

! WARNING

- Observe the safety precautions and note the limits of the assist systems, sensors, and cameras ⇒ *page 106*.
- The driver is always responsible when entering or exiting a parking space and during similar maneuvers.
- Do not use this function if the vehicle cannot move freely, for example when on a vehicle jack.
- Sensors and cameras have spots in which the surrounding area cannot be detected. Objects, animals, and people may only be detected with limitations may not be detected at all. Always monitor the traffic and the vehicle's surroundings directly and do not become distracted.

! Note

- Do not use the park assist systems when transporting cargo that extends out of the vehicle, when snow chains are mounted, or when the parking space is on a hill or incline.
- Park assist guides the vehicle either away from curbs or onto them if other vehicles are parked on the curb. Make sure that your vehicle's tires and rims are not damaged. Resume control of the vehicle in time or stop the parking process if needed to prevent damage.

i Tips

Follow the legal regulations in the country where you are located when using Park assist.

Parking with the park assists

Applies to: vehicles with park assist

Requirement: a suitable parking space must be found and selected ⇒ *page 138*. The vehicle must initially be stationary.

In the center display, arrows and symbols on the vehicle roof **2** ⇒ *page 139, fig. 119* indicate what action is needed, such as applying the brakes or changing the direction. Park assist au-

tomatically steers the vehicle into the parking space while the driver presses the pedals.

- ▶ Select the reverse gear after stopping briefly.
- ▶ Remove your hands from the steering wheel.
- ▶ Pay attention to the path of the vehicle. If the traffic situation permits, accelerate carefully ⇒ **!**. The maximum parking speed is approximately 4 mph (7 km/h).
- ▶ Follow the visual instructions in the center display and the warning tones until the parking process has ended.

! WARNING

- Observe the safety precautions and note the limits of the assist systems, sensors, and cameras ⇒ *page 106*.
- The park assist is an assist system. The driver is still responsible for monitoring the vehicle's surroundings and preventing collisions when using the system.
- When using park assist to drive into or out of a parking space, the steering wheel turns quickly on its own. Reaching into the steering wheel spokes while this is happening can result in injury.

i Tips

You can also cancel the driving direction set by the system by shifting between a forward gear and reverse gear. Based on the position of the vehicle, the system then calculates the additional steering and driving directions for maneuvering.

Exiting parking spaces with park assist



Applies to: vehicles with park assist

If you parked the vehicle in a parallel parking space, park assist can help you drive out of it.

In the center display, arrows and symbols on the vehicle roof **2** ⇒ *page 139, fig. 119* indicate what action is needed, such as applying the brakes or changing the direction. Park assist automatically steers the vehicle out of the parking space while the driver presses the pedals.

- ▶ Start the engine.
- ▶ Press the **P** button ⇒ *page 139, fig. 118*.

Parking and maneuvering

- ▶ Wait until a message appears in the center display that specifies the direction of travel required to exit the parking space.
- ▶ Activate the turn signal on the desired side or press that side next to the vehicle in the center display.
- ▶ Make sure the actual direction the vehicle is traveling matches the direction indicated by the park assist.
- ▶ Remove your hands from the steering wheel.
- ▶ Pay attention to the path of the vehicle. If the traffic situation permits, accelerate carefully ⇒ . The maximum speed for exiting a parking space is 3 mph (5 km/h).
- ▶ Follow the visual instructions in the center display and the warning tones until the vehicle has finished exiting the parking space.
- ▶ The process of exiting the parking space has ended if additional corrective movements are no longer necessary and the specified steering wheel angle is sufficient to drive out of the parking space. Resume control of the steering wheel ⇒ .

WARNING

- Observe the safety precautions and note the limits of the assist systems, sensors, and cameras ⇒ *page 106*.
- The park assist is an assist system. The driver is still responsible for monitoring the vehicle's surroundings and preventing collisions when using the system.
- When using park assist to drive into or out of a parking space, the steering wheel turns quickly on its own. Reaching into the steering wheel spokes while this is happening can result in injury.

Note

Resume steering immediately after the last corrective movement and the takeover prompt, so that the specified steering wheel angle is not recentered.

Interrupting the park assists

Applies to: vehicles with park assist

Park assist will be canceled automatically in the following scenarios:

- You switch the system off.
- You start steering.
- The speed is too high.
- The time limit is exceeded.
- An obstacle is detected.
- ESC intervenes.

Resume control of the vehicle, end the parking process manually, or:



- You can resume the parking process in some situations. Press the **P** button.
- To continue exiting the parking space, switch the engine off and on. Press the **P** button.

WARNING

Observe the safety precautions and note the limits of the assist systems, sensors, and cameras ⇒ *page 106*.

Messages

Applies to: vehicles with park assist

If the  or  indicator light turns on, the park assist is not available or was interrupted.

A message that indicates the cause and possible solution may appear with some displays. The weather conditions may be too poor or a sensor may be covered. Clean the area in front of the sensors ⇒ *page 108* and try to turn the system on again later.

If the malfunction remains, drive to an authorized Audi dealer or authorized Audi Service Facility immediately to have the malfunction corrected.

Telephone

Introduction

Applies to: vehicles with telephone

You can operate various telephone functions easily through the MMI in your vehicle.

Depending on the country and the vehicle equipment, the following options may be available:

- Connecting a cell phone with Bluetooth
- Using two telephones
- Using the Audi phone box

WARNING

- Medical experts warn that mobile devices can interfere with the function of pacemakers. Always maintain a minimum distance of about 7.9 inches (20 cm) between the mobile device antennas and the pacemaker.
 - Do not carry the mobile device in a pocket directly over the pacemaker when the phone is switched on.
 - Switch the mobile device off immediately if you suspect it may be interfering with the pacemaker.
- Do not use the voice recognition system* \Rightarrow *page 24* in emergencies because your voice may change in stressful situations. The system may take longer to dial the number or may not be able to dial it at all. Dial the emergency number manually.
- Switch your mobile device off in areas where there is a risk of an explosion. These locations are not always clearly marked. This may include gas stations, fuel and chemical storage facilities or transport vehicles, or locations where fuel vapors (such as propane or gasoline vapor in vehicles or buildings), chemicals or large quantities of dust particles (such as flour, sawdust or metal) may be present in the air. This also applies to all other locations where you would normally turn your vehicle engine off.
- The demands of traffic require your full attention. Always read the chapter \Rightarrow *page 18*, *Traffic safety information*.

Note

Read the information about Audi connect, and be sure to note the connectivity costs section \Rightarrow *page 157*.

Tips

- The Bluetooth connection range is limited to inside the vehicle.
- A selection of supported Bluetooth devices can be found in the database for tested mobile devices at www.audi.com/bluetooth.

Setup

Connecting a mobile phone via Bluetooth

Applies to: vehicles with telephone

Requirement: the vehicle must be stationary and the ignition must be switched on. The Bluetooth settings must be open on your mobile device during the connection setup. The mobile device to be connected must not be actively connected to any other Bluetooth device. The MMI must only be connected to one mobile device.

Pairing a mobile device

- ▶ Enable the Bluetooth function and visibility on the MMI \Rightarrow *page 202* and the mobile phone.
- ▶ Applies to: MMI: Select on the home screen: **PHONE**.
- ▶ Follow the system instructions. The available Bluetooth devices will be displayed after several seconds.
- ▶ Press on the desired mobile device in the list of displayed Bluetooth devices.
- ▶ To update the list, press .

A PIN for a secure Bluetooth connection will be generated.

- ▶ Confirm the PIN on your mobile device, or
- ▶ Enter the PIN for connecting on your cell phone. The time allowed for entering the PIN is limited to approximately 30 seconds.
- ▶ Follow the system instructions.
- ▶ Pay attention to any other system prompts on the MMI and on your cell phone. 

After connecting successfully

Information about the connected profiles will appear. You can also change the profiles later ⇒ *page 203*.

The cell phone contacts are automatically loaded in the MMI. This process can take several minutes, depending on the number of contacts.

Depending on your cell phone and the connection type, you can use the following functions:

Handsfree

Requirement: your cell phone must be connected to the MMI via a Bluetooth Hands Free Profile (Bluetooth HFP).

You can use the hands-free system. You can make calls using the antenna on your mobile device.

Sending and receiving messages

See ⇒ *page 151*.

Note

Read the information about Audi connect, and be sure to note the connectivity costs section ⇒ *page 157*.

Tips

- You can apply additional settings to connected mobile devices under **Connected devices** ⇒ *page 202*.
- You can also search for the MMI on your mobile device using the Bluetooth device search.
- You only have to pair your device one time. Bluetooth devices that are already paired automatically connect to the MMI when the Bluetooth function is switched on, when they are within range, and when the ignition is switched on. The last connected mobile device is given first priority.
- Pay attention to any system prompts displayed on your mobile device or the MMI, for example if the system should connect automatically in the future. Depending on

the mobile device, you may also need to download contacts and confirm access to your messages separately.

- When leaving the vehicle, the Bluetooth connection to the mobile device will automatically disconnect. Depending on your mobile device, phone calls in progress may be automatically redirected from the MMI to your mobile device so that you can continue the call on your phone.
- When the car phone or data module function* is switched on, Audi connect Infotainment* is available through the embedded SIM card¹⁾²⁾.

Using two telephones

Applies to: vehicles with telephone, and Audi phone box

You can connect two mobile devices to the MMI, for example your business and your personal mobile device. You can use both mobile devices to make calls in the vehicle.

Connecting another mobile device

Requirement: a mobile device must be connected to the MMI. The vehicle must be stationary and the ignition must be switched on. The Bluetooth settings must be open on your mobile device during the connection setup. The mobile device to be connected must not be actively connected to any other Bluetooth device.

- ▶ Enable the Bluetooth function and visibility on the MMI ⇒ *page 202* and the mobile phone.
- ▶ Applies to: MMI: Select on the home screen: **PHONE** > , or
- ▶ Applies to: MMI: Select on the home screen: **SETTINGS** > **Connected devices** > **Telephone 1** or **Telephone 2** > **New connection**.
- ▶ Follow the system instructions. The available Bluetooth devices will be displayed after several seconds.
- ▶ Press on the desired mobile device in the list of displayed Bluetooth devices.
- ▶ To update the list, press .

1) SIM card installed in the vehicle at the factory.

2) Not available in all countries.

A PIN for a secure Bluetooth connection will be generated.

- ▶ Confirm the PIN on your mobile device, or
- ▶ Enter the PIN for connecting on your cell phone. The time allowed for entering the PIN is limited to approximately 30 seconds.
- ▶ Follow the system instructions.
- ▶ Pay attention to any other system prompts on the MMI and on your cell phone.

After connecting successfully

See ⇒ *page 144, After connecting successfully.*

Switching between two mobile devices

Requirement: phone 1 and phone 2 must be connected to the MMI.

- ▶ Applies to: MMI: Select on the home screen: **PHONE** > .

Disconnecting a mobile device

Applies to: vehicles with telephone

The mobile device will be disconnected from the MMI and removed from the list of paired devices.

- ▶ To disconnect a connected device, use the connection manager ⇒ *page 203.*

Using the Audi phone box

Applies to: vehicles with Audi phone box

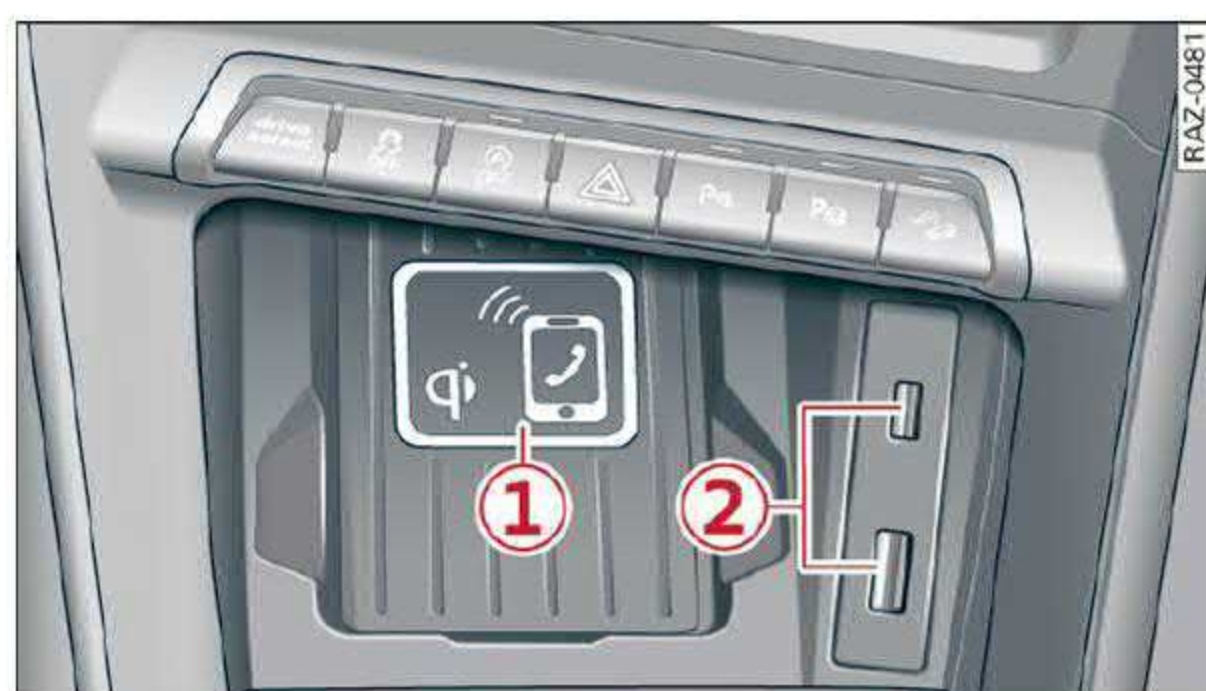



Fig. 120 Front center console: Audi phone box with connections

You can charge your mobile device battery wirelessly using the Audi phone box. You can make calls through the exterior antenna* on the vehicle. Using the external antenna* helps when there is a low signal and also provides better reception quality.

- Position the mobile device in the Audi phone box centered on the  symbol (1) with the display facing up.

Depending on the vehicle equipment, you may then be able to use the following functions:

- **Connect to the external vehicle antenna¹⁾**
- **Wirelessly charge the mobile device.** Requirement: the ignition must be switched on. The charging function must be switched on in the MMI. You must have a Qi-capable²⁾ mobile device.

You can also **charge a mobile device using the USB adapter**: connect your mobile device to the Audi music interface using a USB adapter cable (2). You can charge your mobile device using specific USB adapters ⇒ *page 190.*

Reminder signal

When the device reminder signal is switched on, you will be notified that your mobile device is still in the Audi phone box when you leave the vehicle.

Requirement

- A Qi-capable²⁾ mobile device must be in the Audi phone box, or
- Your mobile device must be connected to the Audi music interface by a USB adapter, and the Audi smartphone interface must be active, or
- Your iPhone must be connected to the MMI via Bluetooth ⇒ *page 143* and must be charging through the Audi music interface using a USB adapter.

Applies to: MMI: Select on the home screen: **SETTINGS** > **General** > **Reminder signal and mobile device wireless charging.**

1) Not available in all countries. These are additional car phone functions only in conjunction with Audi connect Infotainment*.

2) The Qi standard makes it possible to charge your mobile device wirelessly.

The following settings are available:

- **Signal tone**
- **Spoken cue***: this setting is switched on at the factory.
- **Off**
- **Mobile device charging notification***: when this function is switched on, the charge status of your mobile device is displayed. You will also be reminded not to forget your mobile device when leaving the vehicle.
- **Mobile device wireless charging***: when this function is switched on, you can charge your Qi-capable mobile device wirelessly in the Audi phone box.

WARNING

- Loose objects can be thrown around the vehicle interior during sudden driving or braking maneuvers, which increases the risk of an accident. Store objects securely while driving.
- The mobile device may become hot during wireless charging. Pay attention to the temperature of your mobile device and be careful when removing it from the Audi phone box.
- An alternating magnetic field is used for wireless charging. Maintain a minimum distance of approximately 2.4 inches (6 cm) to the Audi phone box charging plate. The thresholds for prolonged exposure at this distance comply with ICNIRP1998. Therefore, interactions such as irritation of sensory organs, malfunctions of active implants (such as pacemakers, infusion pumps, or neurostimulators) or effects on passive implants (such as prosthetic limbs) is highly unlikely. If you have an implant, consult a medical specialist if you have any questions. You can also switch the function for wireless charging in the Audi phone box on and off. You can continue to charge your mobile device using a cable connection.

Note

Applicable to U.S.A.

Operation of the Audi phone box is subject to the following requirements of the Federal Communications Commission:

- This is a CONSUMER device.
- BEFORE USE, you MUST REGISTER THIS DEVICE with your wireless provider and have your provider's consent. Most wireless providers consent to the use of signal boosters. Some providers may not consent to the use of this device on their network. If you are unsure, contact your service provider.
- You MUST operate this device with approved antennas and cables as specified by the manufacturer. Antennas MUST be installed at least 20 cm (8 inches) from any person.
- You MUST cease operating this device immediately if requested by the FCC or a licensed wireless service provider.
- WARNING: E911 location information may not be provided or may be inaccurate for calls served by using this device.

Note

Applicable to Canada

In Canada, operation of a Zone Enhancer, such as an Audi phone box, is subject to the following requirements of the Innovation, Science and Economic Development Canada (ISED):

- This is a CONSUMER device.
- BEFORE USE, you **MUST** meet all requirements set out in **CPC-2-1-05**. At the time of printing this user manual, the CPC-2-1-05 client procedures circular of ISED Canada was available at the following web page: <http://www.ic.gc.ca/eic/site/smt-gst.nsf/eng/sf08942.html>.
- You MUST operate this device with approved antennas and cables as specified by the manufacturer. Antennas **MUST NOT** be installed within 20 cm of any person.
- You MUST cease operating this device immediately if requested by ISED or a licensed wireless service provider.

– **WARNING:** E911 location information may not be provided or may be inaccurate for calls served by using this device.

i Tips

- The system complies with United States FCC regulations and ISED regulations ⇒ *page 267*.
- Only one mobile device at a time can be charged wirelessly in the Audi phone box.
- Strong transmission quality* cannot be guaranteed if more than one mobile device is in the box.
- To reduce the risk of malfunctions, make sure the mobile device is positioned correctly in the Audi phone box.
- Make sure there are no objects between the Audi phone box and the mobile device.
- Placing the mobile device in a bag or protective sleeve inside the Audi phone box can interfere with the connection to the external antenna*.
- Metallic objects in the Audi phone box block the wireless charging of your mobile device and calls made using the exterior antenna*.
- The maximum charging output is 5 W.
- The charging time and temperature will vary depending on the mobile device being used.
- You can purchase a USB adapter from an authorized Audi dealer or authorized Audi Service Facility, or at specialty stores.
- Audi recommends using Audi Genuine Accessories. Audi has verified their reliability, safety, and suitability.

Using the telephone

Accessing the telephone functions

Applies to: vehicles with telephone



Fig. 121 Center display: selection menu

Using telephone functions

Requirement: a mobile device must be connected to the MMI ⇒ *page 143*.

► Applies to: MMI: Select on the home screen: **PHONE**.

The following phone functions will be available:

① Search	
② Call list	147
③ Favorites	148
④ Contacts	148
⑤ Voicemail	149
⑥ Dial number	149
⑦ Switching between two mobile devices	153

Selected phone functions are also available in the instrument cluster ⇒ *page 155*.

Call list

Applies to: vehicles with telephone



Fig. 122 Center display: call list

Opening the call list

Requirement: the call list must contain a phone number.

► Applies to: MMI: Select on the home screen: **PHONE > Call list**.

Possible call list symbols:

① Missed calls	
② Dialed numbers	
③ Accepted calls	
④ Edit call list	
⑤ Display business card	148
⑥ Number of interactions with a contact	

Telephone

If more than one interaction with a contact or number has already taken place, the last one is always displayed in the form of an arrow ①, ② or ③.

Press and hold a contact or a phone number in the list until the **Options** menu appears. Depending on your mobile device, the following options may be available:

- **Save as a shortcut** ⇒ *page 21, Shortcuts*.
- **Edit telephone number**: edit a phone number before dialing it. Press **Dial** and start the call.
- **Show history***: Requirement: you must have already had more than one interaction with a contact. All interactions with a contact or a number are displayed.
- **Store as favorite** ⇒ *page 148*.
- **Send text message** ⇒ *page 151*.
- **Send e-mail** ⇒ *page 152*.

Managing favorites

Applies to: vehicles with telephone

You can store the desired number for a contact as a shortcut in the favorites list.

Accessing favorites

- ▶ Applies to: MMI: Select on the home screen: **PHONE > Favorites**.

Storing favorites

- ▶ Press ☆ in the business card ① ⇒ *page 148, fig. 123*, or
- ▶ Press **Store as favorite** in the options ⇒ *page 147*.

Deleting favorites

- ▶ Press ★ in the business card ① ⇒ *page 148, fig. 123*, or
- ▶ Select: **Favorites > [icon] > one or multiple favorites** or **Select all > Delete > Done**.

i Tips

If there are multiple mobile devices, you can create separate favorites in the MMI for each mobile device.

Opening contacts

Applies to: vehicles with telephone



Fig. 123 Center display: contact information

You can connect multiple mobile devices to the MMI and manage up to four private phone books in the MMI.

Accessing contacts

Requirement: a mobile device must be connected to the MMI ⇒ *page 143*. You must have at least one contact stored in your mobile device.

- ▶ Applies to: MMI: Select on the home screen: **PHONE > Contacts**.

The contacts will be displayed. You can change the sort order ⇒ *page 154, Sort order*.

Displaying a business card

The business card shows you details about a contact. To open a business card, press on a contact in the directory.

Possible options in the business card:

- | | |
|--|-----|
| ① Store/delete as a favorite | 148 |
| ② Options | |
| ③ Call | |
| ④ Send text message | 151 |
| ⑤ Start navigation | |
| ⑥ Send e-mail | 152 |

Business card options

Press ... ②.

Possible options:

- **Send contact**: you can select **Text message** or **E-mail** ⇒ *page 151*.

- **Add destination:** you can add a business or private address ⇒ *page 173, Contacts as navigation destinations.*
- **Read out name¹⁾:** the MMI automatically creates a name tag that can be read aloud for each entry ⇒ *page 24.*
- **Save as a shortcut** ⇒ *page 21, Shortcuts.*

Contact options

Press and hold a contact in the list until the **Options** menu appears.

Possible options:

- **Send contact:** you can select **Text message** or **E-mail** ⇒ *page 151.*
- **Send text message** ⇒ *page 151.*
- **Send e-mail** ⇒ *page 152.*
- **Store as favorite** ⇒ *page 148.*
- **Save as a shortcut** ⇒ *page 21, Shortcuts.*

Deleting contacts

- **Deleting all contacts:** select: **Contacts** >  > **Delete all.** All contacts are deleted only in the MMI.
- **Deleting imported contacts:** requirement: you must have imported at least one contact. Select: **Contacts** >  > *one or more contacts*, or **Select all** > **Delete imported contacts** > **Done.** The imported contacts are deleted.

Tips

- Pay attention to any synchronization prompts on your mobile device when downloading contacts.
- Only the contacts of the mobile device being actively used are displayed.
- The contacts from the mobile device may not be transferred in alphabetical order. If there are too many entries, contacts with different first letters may be missing in the MMI.
- If contacts are loaded from the mobile device into the MMI, the contacts on the SIM card will no longer be displayed in the MMI.

- The contacts in the local MMI memory are always visible and can be accessed by other users.
- After switching off the ignition and exiting the vehicle, the mobile device directory will be loaded when the MMI is started again if the mobile device is within range and the Bluetooth function is switched on in the mobile device and the MMI.
- Only the contacts in the local MMI memory can be deleted.

Listening to voicemail

Applies to: vehicles with telephone

- ▶ Applies to: MMI: Select on the home screen: **PHONE** > **Voicemail.**

Requirement: there must be no voicemail number stored.

- ▶ **Entering the voicemail number:** enter the desired number. Press **OK.**

Requirement: a voicemail number must be stored.

- ▶ **Dialing the voicemail number:** press **Voice-mail.** The call begins immediately.

Tips

This service must be set up and activated in advance by the cell phone service provider.

Dialing a telephone number

Applies to: vehicles with telephone

Depending on the vehicle equipment, you may have the following options for dialing a phone number:

- Using text input in the center display ⇒ *page 22.*
- Using voice operation ⇒ *page 24.*

Making an emergency call

Applies to: vehicles with telephone

Requirement: a mobile device must be connected to the MMI via Bluetooth. ▶

¹⁾ Not available in all languages.

- ▶ Applies to: MMI: Select on the home screen: **PHONE > Dial number > the emergency call number specific to the country (for example, 911) > Dial.**

WARNING

- Because your phone works with radio signals, a connection cannot be guaranteed under all circumstances. Do not rely on only your phone when it comes to essential communication (such as a medical emergency).
- Always follow the instructions given by the emergency personnel during an emergency call and only end the call when they instruct you to do so.

Answering/ending a call

Applies to: vehicles with telephone

Accepting or ending a call

- ▶ To accept or end a call, press the  button on the multifunction steering wheel. Operating [⇨ page 12](#) and [⇨ page 26](#).

Accepting or declining a call

You can use the following options on the MMI when there is an incoming call:

- ▶ **Answering an incoming call:** press **Answer**.
- ▶ **Declining a call:** press **Decline**.
- ▶ **Declining a call with a text message*:** press **Decline with text message**.
- ▶ **Silencing the ringtone:** press **Mute**.

Tips

The radio or media playback is muted during a phone call.

During a phone call

Applies to: vehicles with telephone

The following options may be possible during a call depending on the mobile device being used and the type of connection:

- **End call:** ends the current phone call.
- **Mute:** the other person on the call will no longer be able to hear you. You will still be able to

hear the other person. To switch the microphone back on, press **Unmute**.

- **Hold/Resume:** place your current phone call on hold and answer another.
- **Send tone sequence:** press **Numbers**. You can enter tone sequences (DTMF) and send them to the other party on the call.
- **Accepting an incoming call:** if a phone call comes in during another call, you can either **Replace** the current call with the incoming call, or use **Answer** to put the current call on hold. The incoming call will be answered.
- **Declining an incoming call:** press **Decline** to decline an incoming call.
- **Muting the incoming call:** press **Mute**.
- **Other call options:** press **More**.

Requirement: two phone calls must be in progress.

- **Conference call*:** add a call on hold and up to five active parties (depending on the cell phone service provider) to the conference call.
- **Swap call:** alternate between two phone calls while one of the calls is on hold. Press on the respective call. Selecting **End call** will end the active phone call. A call that was placed on hold stays on hold and can be taken off hold with **Resume**.
- **Accepting an incoming call:** if a phone call comes in during another call and when there is a call on hold, you can either **Replace** the current call with the incoming call, or use **Answer** to put the current call on hold. The incoming call will be answered.

Press **More**.

- **Transferring a call*:** press **Transfer call to mobile device** to transfer the existing call from the MMI to your mobile device or Bluetooth® headset*.
- **Switch to hands-free mode*:** Requirement: you must have a phone call in progress on your cell phone. Press **Switch to hands-free** to transfer the call from your cell phone back to the MMI.
- **Add call:** Select: **Call list/Contacts/Favorites > select an entry from the list** or press **Dial phone number** and enter a phone number. Then the active call will be on hold. ▶

- **Remove member***: Requirement: you must have started a conference call. You can remove conference call members individually when a conference call is active. Press on the contact you would like to remove.
- **Microphone input level**: you can adjust the microphone input level during a phone call using the slider.

Tips

- To be notified of an incoming call during a phone call, the *call waiting* function in your mobile device must be switched on when using the **Handsfree** profile.
- When leaving the vehicle, the Bluetooth connection to the mobile device will automatically disconnect. Depending on your mobile device, phone calls in progress may be automatically redirected from the MMI to your mobile device so that you can continue the call on your phone.

Messages

Text messages

Applies to: vehicles with telephone

Depending on the mobile device being used and the mobile network contract, you may be able to receive and send text messages using the MMI.

Requirement: your mobile device must be connected to the MMI via Bluetooth Message Access Profile (Bluetooth MAP) ⇒ *page 143*.

- ▶ Applies to: MMI: Select on the home screen: **MESSAGES** >  > **Text message (SIM card)*** / **text message (phone 1)** / **text message (phone 2)***.

Inboxes

- **New text message**: press on a template in the list or dictate a text message. Press **Add** and select one or more recipients from your contacts. To remove a recipient, press **Delete**. Press **Send**.
- **Inbox**: displays all received text messages.
- **Sent**: displays all sent text messages.

- **Outbox***: displays all text messages to be sent.
- **Drafts***: text messages that have not been sent yet by the mobile device are displayed on the MMI.
- **Deleted***: deleted text messages are displayed.
- **User-defined***: folders defined by the user are transferred from your mobile device.

Message options

The following options are available when you select a text message:

- **Read out*** the text message¹⁾.
- **Reply**: a reply can be sent to the selected message in the **Inbox**.
- To switch to the previous or the next message, press < or >.
- **More**: options

When you press **More**, the following options are available:

- **Call**: Requirement: a number must be stored. You can call the contact.
- **Forward**: the selected text message can be forwarded to other recipients. Text can also be added before sending.
- **Navigate**: Requirement: the contact must have a navigation address stored with it in the directory. You can start route guidance.
- **Extract numbers**: Requirement: the message must contain a number. You can extract a number from a text message.
- **Send again**: Requirement: the text message must be in the **Outbox**. The selected text message can be resent.

Press and hold an entry in the **Inbox** until the **Options** menu appears.

- **Reply**: a reply can be sent to the selected message in the **Inbox**.
- **Forward**: the selected text message can be forwarded to other recipients. Text can also be added before sending. ▶

¹⁾ Not available in all languages.

Settings

Press .

- **Automatically forward text message to mobile device¹⁾**: when this function is switched on, text messages will be automatically stored on your mobile device.
- **New text message notification**: when this function is switched on, you will be notified when new text messages are received. New text messages are indicated with an envelope  in the MMI status bar.
- **Text message center***: the number for the text message center of your cell phone service provider is displayed. If no number has been stored yet, you can enter the text message center number.
- **Delete text messages from SIM card***: if the memory capacity on the SIM card is full, an envelope with a line through it is displayed in the MMI status bar. You can continue to send text messages, but you cannot receive new text messages. To delete all sent text messages from the SIM card, select **All sent messages**. To delete all read text messages from the SIM card, select **All read messages**.

Delete text message

Select: *a mailbox* >  > *one or more text messages* > **Delete** > **Done**.

Tips

- Please note that you may have to activate the receiving and sending of text messages depending on the SIM card being used (for example, when using a multi-SIM).
- Messages that are deleted in the MMI are also deleted in the mobile device automatically.
- Only new received messages may be displayed depending on your mobile device.

E-mail

Applies to: vehicles with telephone

Depending on the type of mobile device being used, you may be able to receive and send e-mails through the MMI.

Requirement: your mobile device must be connected to the MMI via Bluetooth Message Access Profile (Bluetooth MAP) ⇒ *page 143*.

- ▶ Applies to: MMI: Select on the home screen: **MESSAGES** >  > **e-mail (phone 1)/e-mail (phone 2)***.

Inboxes

- **New e-mail**: press on a template in the list. Press **Add** and select one or more recipients from your contacts. To remove one or all recipients, press **Delete**. Press **Send**.
- **Inbox**: displays all received e-mails. To update the list, press .
- **Sent**: displays all sent e-mails.
- **Outbox**: displays all e-mails to be sent.
- **Drafts**: e-mails that have not been sent yet are displayed.
- **Deleted***: deleted e-mails are displayed.
- **User-defined***: folders defined by the user are transferred from your mobile device.

Message options

The following options are available when you select an e-mail:

- **Read out*** the e-mail²⁾.
- **Reply**: a reply can be sent to the selected e-mail in the **Inbox**.
- To switch to the previous or the next message, press **<** or **>**.
- **More**: options

When you press **More**, the following options may be displayed depending on your mobile device and the applicable mail folder:

- **Call**: Requirement: a number must be stored. You can call the contact. ▶

1) Function is not supported on all mobile devices.

2) Not available in all languages.

- **Forward:** the selected e-mail can be forwarded to other recipients. Text can also be added before sending.
- **Extract e-mail add.:** you can extract the e-mail address from an e-mail.
- **Navigate:** Requirement: the contact must have a navigation address stored with it in the directory. You can start route guidance.
- **Extract numbers:** Requirement: the text in the e-mail must contain a number. You can extract a number from an e-mail.
- **Show all recipients*:** you can display the recipients of an e-mail.
- **Show attachmts.*:** you can display a list of attachments to an e-mail.
- **Send again:** the selected e-mail in the **Outbox** and **Sent** mailboxes can be sent again.

Press and hold an entry in the **Inbox** until the **Options** menu appears.

- **Reply:** a reply can be sent to the selected e-mail.
- **Reply all:** a reply can be sent for the selected e-mail and it will be sent to all of the entered recipients.
- **Forward:** the selected e-mail can be forwarded to different recipients.

Settings

Press .

- **New e-mail notification:** when this function is switched on, you will be notified when new e-mails are received. New e-mails are indicated with an envelope  in the MMI status bar.

Deleting e-mails

Select: *a mailbox* >  > *one or more e-mails* > **Delete** > **(Done)**.

Note

Read the information about Audi connect, and be sure to note the connectivity costs section ⇒ *page 157*.

Settings

Phone settings

Applies to: vehicles with telephone

- ▶ Applies to: MMI: Select on the home screen: **PHONE** > .

Switching between two mobile devices

Requirement: phone 1 and phone 2 must be connected to the MMI.

Switch telephones: the device name of the available mobile device is displayed. You can switch the phone by pressing the button.

Declining a call with a text message*

When this function is switched on, you can decline an incoming call with a text message.

Call options*

The following options may be available depending on the mobile device:

- **Call forwarding:** you can switch the forwarding of incoming calls to your voicemail or to another phone number on and off. You can check if the function is activated or deactivated with **Status**.
- **Call waiting:** you will be alerted to an incoming call during a phone call when the function is switched on. You can check if the function is activated or deactivated with **Status**.
- **Send own number:** sending your phone number with an outgoing call can be switched on and off. With the **Net.-depen.** setting, the setting listed in the contract with the cell phone service provider is used. The settings only apply to the **PHONE** menu in the MMI. Please note that the settings on your mobile device will apply after disconnecting the Bluetooth connection. You can determine which setting is active with **Status**.

Ringtone and volume settings

- **Ringtone and message volume:** you can adjust the volume of the selected ringtone and the notification volume when a message is received by moving the position of the slider. ▶

- **Ringtone***: available ringtones are played using the **Ringtone** function. Press on an entry in the list.
- **Microphone input level**: you can adjust the microphone input level during a phone call using the slider.

Turn on car phone or data module

Applies to: vehicles with car phone/data module

When this function is switched on, you can use the car phone or data module.

As long as the car phone was **not** turned off separately the last time it was used, it will turn on automatically when the ignition is switched on.

Edit voicemail number

You can change your voicemail number.

Enable VoLTE

When this function is switched on, Voice over LTE* will be supported.

Network settings

- **Login to mobile phone network**: select to log into your cell phone service provider network automatically or manually.
- **Manual network selection**: Requirement: the data module must be switched on and **Login to mobile phone network** must be set to **Manual**. Select a network manually from the list of available networks at the present location.

Car phone serial number (IMEI):

Applies to: vehicles with car phone

The serial number (IMEI) of your car phone is displayed.

Tips

- Several mobile devices can be paired with the MMI, but only two* mobile devices can be actively connected.
- To delete all paired Bluetooth devices, the **Bluetooth** function can be reset to the factory default settings ⇒ *page 202*.

Directory settings

Applies to: vehicles with telephone

- ▶ Applies to: MMI: Select on the home screen: **PHONE > Contacts > **.

Switching between two mobile devices

Requirement: telephone 1 and telephone 2 must be connected.

Switch telephones: the device name of the available mobile device is displayed. You can switch the phone by pressing the button.

The directory for the selected phone will be displayed.

Hide grayed-out contacts

When this function is switched on, contacts that have no phone numbers stored for them will be hidden.

Sort order

You can sort the contacts by **Last name** or **First name**.

Download contacts

Requirement: a mobile device must be connected to the MMI.

To update the contacts in the MMI, you can manually download your mobile device contacts. Depending on the mobile device, you may need to disconnect and reconnect the Bluetooth connection to update the contacts.

Memory capacity

You can manage up to 23,000 contacts. You can also download up to 5,000 contacts from maximum four mobile devices. You can also import up to 3,000 contacts from a storage medium.

Importing and exporting contacts

Requirement: an SD card must be in the SD card reader* ⇒ *page 188* or a USB storage device must be connected to the Audi music interface ⇒ *page 190*.

Contacts in vCard format (.vcf) can be imported or exported from the MMI.

- Applies to: MMI: **Importing contacts from a storage medium**: Select: **Import contacts** > **Search for import data** > **SD card 1** or **USB device 1/USB device 2** > *desired contacts* or **Select all contacts** > **Start import**.
- Applies to: MMI: **Exporting contacts to a storage device**: Requirement: Only previously imported contacts can be exported. Select: **Export contacts** > **Find source for exporting** > **SD card 1** or **USB device 1/USB device 2** > *desired contacts* or **Select all contacts** > **Start export**.

Tips

- For more information about the myAudi account, visit my.audi.com.
- The imported contacts are stored in the local MMI memory.
- Contacts that were downloaded from a mobile device cannot be exported.
- There should be no other files or folders on the storage medium containing the contacts to be imported.
- Apple devices and MTP devices (such as smartphones) are not recognized as USB storage devices.

Mobile phone network settings

Applies to: vehicles with telephone

- ▶ Applies to: MMI: Select on the home screen: **SETTINGS** > **Connection settings** > **Mobile phone network**.

Do It Yourself

Applies to: vehicles with telephone

The information that follows lists some troubleshooting options. They depend on the equipment. ▶

Turn on car phone or data module

Applies to: vehicles with car phone/data module

See ⇨ *page 154*.

Instrument cluster

Telephone

Applies to: vehicles with multifunction steering wheel and telephone

In the instrument cluster display, you can control the MMI functions with the multifunction steering wheel. Operating ⇨ *page 12* and ⇨ *page 26*.

Requirement: the Telephone tab must be selected in the instrument cluster.

- ▶ Press the  button.

Possible options:

- **Call list**: Requirement: the call list must contain a phone number.
- **Favorites**: Requirement: favorites must be stored in the MMI.
- **Switch telephones**: Requirement: two cell phones must be connected to the MMI.
- **Back to call**: Requirement: there must be a call in progress.

Tips

Depending on the selected function, it may be necessary to use the MMI.

Telephone

Problem	Solution
Pairing the mobile device to the MMI failed.	Make sure the requirements for connecting a mobile phone have been met ⇒ <i>page 143</i> , or make sure you did not accidentally decline the PIN for establishing a connection on your mobile phone. If necessary, repeat the pairing process ⇒ <i>page 143</i> .
After pairing, not all contacts or no contacts have been loaded into the MMI.	Avoid using special characters in names. Avoid using contact groups on your mobile device. Check for prompts on your mobile device when connecting via Bluetooth.
Certain telephone functions are grayed out or not available.	The telephone functions depend on the mobile device service provider and the mobile device you are using.
Some telephone functions may be switched off or not available, even though the mobile device is supported.	Check if the Bluetooth settings on your cell phone are limited or individual Bluetooth settings are deactivated. This may be the case with business cell phones.
Wireless cell phone charging is not working or is interrupted.	Check if wireless charging with the Audi phone box is switched on. Check if your mobile device is Qi-capable. Check if your mobile device is positioned correctly in the Audi phone box ⇒ <i>page 145</i> and <i>no</i> other objects are between them.
The MESSAGES menu is not available.	Check if the <i>Show messages</i> option is on your mobile device and it is enabled.

Audi connect

General information

Applies to: vehicles with Audi connect

Depending on the country and the vehicle equipment, the following functions may be available:

- Audi connect Infotainment

WARNING

- To reduce the risk of an accident, only use Audi connect services and the Wi-Fi hotspot only if the traffic situation permits it. Read and follow the guidelines provided in ⇒ *page 18, Traffic safety information*.
- It is only safe to use tablets, laptops, mobile devices and other similar devices when the vehicle is stationary because, like all loose objects, they could be thrown around the inside of the vehicle in a crash and cause serious injuries. Store these types of devices securely while driving. Also read the warnings in the chapter ⇒ *page 63*.

Note

- Applies to: embedded SIM card usage: The connection costs for Audi connect Infotainment services are included in the price of Audi connect Infotainment during the subscription period with some exceptions. Please note that there may be additional charges when using some services. For example, this applies to online radio/podcasts, additional online data, or for Internet connections and services that use the Wi-Fi hotspot, such as online media sources. Depending on the country, data plans may need to be purchased for these services ⇒ *page 160*. For additional information, see my.audi.com.
- In certain situations, the Wi-Fi hotspot data connection may be established as a replacement for the SIM card on your Wi-Fi device. This feature depends on the configuration of your Wi-Fi device and operating system. This could result in fees depending on your cell phone service provider, especially if you are using this feature while abroad. A flat

rate data plan is strongly recommended. For more information, contact your cell phone service provider or refer to the owner's manual for your Wi-Fi device.

- You are responsible for all precautions taken for data protection, anti-virus protection, and protection against loss of data on mobile devices that are used, for example, to access the Internet through the Wi-Fi hotspot.
- In areas with poor GPS reception or outside the coverage range of the respective cell phone service provider, some functions and/or services may not be available, it may not be possible to send or receive data, or functionality may be limited.

Tips

- The availability of services depends on the subscription.
- Audi merely provides access to third party services through the MMI and does not assume any responsibility for the content and availability of these services.
- Use of the most up-to-date mobile network standard is not available in every country. Contact an authorized Audi dealer or authorized Audi Service Facility or your cell phone service provider for additional information.
- Availability, scope, providers, screen display, and costs of services may vary depending on the country, model, model year, end device and rates.
- All services can be modified, activated/deactivated, renamed, and enhanced without further notification.

Audi connect Infotainment

Description

Applies to: vehicles with Audi connect Infotainment

With Audi connect Infotainment services, online information is transmitted directly to the vehicle.

An Internet connection is required to use Audi connect Infotainment. Depending on the country ►

and the vehicle equipment, the following options may be available:

- Embedded SIM card

WARNING

Always follow the information found in  in *General information on page 157*.

Note

Always follow the information found in  in *General information on page 157*.

Embedded SIM card

Applies to: vehicles with Audi connect Infotainment and an embedded SIM card

The data connection for Audi connect Infotainment services is made through an embedded SIM card (eSIM card) that is installed in the vehicle. You can use the Audi connect Infotainment services immediately.

Note

Always follow the information found in  in *General information on page 157*.

Using a Wi-Fi hotspot

Applies to: vehicles with Wi-Fi hotspot

You can connect up to eight Wi-Fi devices (such as smartphones) with the MMI Wi-Fi hotspot. If the MMI is connected to the Internet  *page 157*, the connected Wi-Fi devices can also use the MMI's Internet connection.

Requirement: the ignition must be switched on.

- ▶ Applies to: MMI: Select on the home screen: **SETTINGS > Connection settings > Wi-Fi**
Switch on the Wi-Fi hotspot.
- ▶ Applies to: MMI: Select on the home screen: **SETTINGS > Connection settings > Wi-Fi > Wi-Fi hotspot settings**. The access data for the Wi-Fi hotspot is displayed. Switch on the visibility of the Wi-Fi hotspot if necessary.
- ▶ Switch the Wi-Fi function on in your mobile device and connect it to the MMI Wi-Fi hotspot using the authentication data that is shown.

- ▶ Follow any additional system prompts on your Wi-Fi device if necessary.

Your device is successfully connected with the MMI's Wi-Fi hotspot.

WARNING

Always follow the information found in  in *General information on page 157*.

Note

Always follow the information found in  in *General information on page 157*.

Tips

The system complies with United States FCC regulations and ISED regulations  *page 267*.

Audi connect Infotainment services

Configuration

Applies to: vehicles with Audi connect Infotainment

Some Audi connect Infotainment services must be configured through your personal myAudi account at my.audi.com before using them for the first time.

Tips

- For some Audi connect Infotainment services, you may also have to enter your myAudi access information when accessing services in the MMI.
- Some Audi connect Infotainment services must be activated at my.audi.com.
- You can only connect one myAudi account to your vehicle.
- Depending on the country, you may be able to use the myAudi app or my.audi.com.
- For detailed information on configuration, visit my.audi.com.

Services

Applies to: vehicles with Audi connect Infotainment

Depending on the country and the vehicle equipment, the following services may be available: ▶

Weather information

Applies to: MMI

- ▶ Press **WEATHER** on the home screen.

Editing settings: Select: **WEATHER** > .

Adding a location: select: **In a new city** > *enter the desired location*.

- ▶ To permanently set weather for a location, press on *a location*.
- ▶ To always show the weather based on the vehicle position, press on the crosshairs.

Requirement: route guidance must be active.

- ▶ To show the weather at the destination, press on .

Removing a location: select:  > *one or more locations* or **Select all** > **Delete**.

Online news

- ▶ Applies to: MMI: Select on the home screen: **NEWS**.

If you logged in to myAudi in your vehicle ⇒ *page 27*, personalized newsfeeds can be displayed.

Access to Twitter

Requirement: you must have connected your vehicle with myAudi ⇒ *page 27*. You must have connected your myAudi account with Twitter.

You can only connect one Twitter account with your myAudi account. Not all settings can be adjusted in the MMI. Some can only be adjusted through the Twitter website.

- ▶ Applies to: MMI: Select on the home screen: **NEWS** > . Press on a Twitter entry in the list.

Access to the calendar

Requirement: the myAudi app must be installed and open on your mobile device. Access to your calendar must be enabled on your mobile device. You must be logged into the myAudi app with your myAudi login data and you must have selected your vehicle. The Wi-Fi function on your mobile device and the MMI must be enabled and your mobile device must be paired to the MMI Wi-Fi hotspot ⇒ *page 160, Wi-Fi settings*.

You can display the your mobile device calendar on the MMI.

- ▶ Applies to: MMI: Select on the home screen: **CALENDAR**.

WARNING

Always follow the information found in ⇒  in *General information on page 157*.

Note

Always follow the information found in ⇒  in *General information on page 157*.

Settings

Cell phone network

- ▶ Applies to: MMI: Select on the home screen: **SETTINGS** > **Connection settings** > **Mobile phone network**.

Depending on the country, vehicle equipment, and connection type, the following functions may be available:

Data connection settings

Using the **Data connection settings** menu, you can set when the system should connect to the Internet. The Internet connection disconnects automatically once the requested Audi connect Infotainment service no longer requires any data.

- **Data roaming:** data roaming is switched off at the factory. To use a data connection outside of the country, data roaming must be switched on. The setting is stored for the current SIM card or the mobile device that is currently connected.
- **Allow MMI online services:** when this function is switched on, a data connection is automatically established in order to use Audi connect Infotainment services.
- **Allow Wi-Fi devices:** when the function is switched on, mobile devices can use the Internet connection through the Wi-Fi hotspot.

Access point

The connection is configured automatically based on the SIM card being used. The following values ▶

can be changed. You can obtain more information from your cell phone service provider.

- **Access Point Name (APN):** the access point depends on the cell phone service provider and is assigned automatically.
- **User name:** your cell phone service provider assigns the user name for your online profile.
- **Password:** your cell phone service provider assigns the password for your online profile.
- **Apply settings:** saves the changed settings.
- **Reset configuration:** resets the connection settings.

Data usage counter

Your current data usage is displayed.

- **Reset counter:** you can reset your usage statistics to zero.
- **Warning limit:** you can set a warning limit for your data usage (GB/MB).

WARNING

Always follow the information found in  in *General information on page 157*.

Note

Always follow the information found in  in *General information on page 157*.

Tips

For more information on roaming charges, contact your cell phone service provider.

Wi-Fi settings

Applies to: vehicles with Wi-Fi hotspot

Requirement: the ignition must be switched on.

- ▶ Applies to: MMI: Select on the home screen: **SETTINGS > Connection settings > Wi-Fi**

Depending on the country and the vehicle equipment, the following functions may be available:

Wi-Fi

When the function is switched on, the MMI's Wi-Fi hotspot is active and Wi-Fi devices can be connected to the hotspot.

Wi-Fi hotspot settings

The Wi-Fi connection between the MMI and your Wi-Fi device is encrypted. You can change the following information if needed.

- **Access point (SSID):** name of the Wi-Fi hotspot.
- **Password:** an initial password was set at the factory in the MMI. Audi recommends changing the initial password. Only use secure passwords that conform to the general guidelines for secure passwords. For more information, refer to reputable and current sources on password security.
- **Visible to others:** you can switch the visibility of the Wi-Fi hotspot on or off.

WARNING

Always follow the information found in  in *General information on page 157*.

Note

Always follow the information found in  in *General information on page 157*.

Data plans¹⁾

Applies to: vehicles with Audi connect

Data plans must be purchased in order to use certain services  in *General information on page 157*.

You can purchase data plans at my.audi.com.

WARNING

Always follow the information found in  in *General information on page 157*.

Note

Always follow the information found in  in *General information on page 157*.

¹⁾ Not available in every market.

Tips

- Depending on the country, applicable data plans may need to be purchased when driving in other countries.
- Depending on the country, you may be able to use the myAudi app or my.audi.com.
- Depending on the country, there may be restrictions on the use of data plans (such as

mobile phone service providers) when driving in other countries.

- If selling your vehicle, you should delete the vehicle from the customer portal for the cell phone service provider to avoid being charged for additional purchases.

Do It Yourself

Applies to: vehicles with Audi connect Infotainment

The information that follows lists some troubleshooting options. They depend on the equipment.

Problem	Solution
Audi connect Infotainment services: individual Audi connect Infotainment services are grayed out or not available.	Some Audi connect Infotainment services must be activated or configured through your personal myAudi account before using them for the first time. You can find detailed information online at my.audi.com.
Wi-Fi hotspot: it is not possible to connect through Wi-Fi.	Check if Wi-Fi is activated in the MMI ⇒ <i>page 160</i> . Delete all existing Wi-Fi connections on your mobile device and restart it.
Wi-Fi hotspot: Wi-Fi hotspot malfunction.	Remove metal objects in the storage compartment at the end of the rear center console.

Emergency call

Overview

Applies to: vehicles with emergency call function

An emergency call is a combination of data transmission and a phone call. The data transmission from your vehicle forwards important information, such as the vehicle and position data, to the emergency call center.

Depending on the country and the vehicle equipment, the following functions may be available:

With the **emergency call**, you can call for help in dangerous situations as quickly as possible. Use this function when emergency help is needed ⇒ *page 162*.

– Audi connect emergency call (TPS emergency call). This eCall system uses emergency call centers operated by third party providers.

With **online roadside assistance**, you can request assistance if there is a breakdown or a minor accident ⇒ *page 163*.

WARNING

In areas with poor GPS reception or outside the coverage range of the respective cell phone service provider, some functions and/or services may not be available, it may not be possible to send or receive data, or functionality may be limited.

Emergency call

Operation

Applies to: vehicles with emergency call function

The services are provided through a SIM card installed in the vehicle. Services are provided assuming that the cell phone network required for the installed SIM card is functioning and available for use. The services made available by Audi are only available within the mobile phone network coverage area for the mobile phone service provider selected by Audi.

Tips

– The emergency call function cannot be deactivated in the Infotainment system settings.

- The availability of the TPS emergency call is limited to certain times.
- The costs for call and data connections for TPS emergency calls is included in the price of the services.

Functions

Applies to: vehicles with emergency call function

A TPS emergency call can be made manually or automatically ⇒ *page 162*.

Making an emergency call

Applies to: vehicles with emergency call function



Fig. 124 Front headliner: cover for the emergency call button

Manual emergency call

Requirement: the ignition must be switched on.

- ▶ Tap the cover **1** to open it.
- ▶ Press and hold the emergency call button until the LED **2** blinks. The emergency call will be made.
- ▶ If the emergency call button is pressed by mistake, then press it again immediately and hold it until the LED stays on. The emergency call will be canceled.

Automatic emergency call

The vehicle electrical system initiates an automatic emergency call under certain circumstances, for example if an airbag deploys. The LED in the emergency call button **2** will blink. The emergency call will be made. The emergency call cannot be canceled.

LED status

- **Green** – The emergency call function is available.
- **Red** – There is a malfunction in the emergency call function. Contact an authorized Audi dealer or authorized Audi Service Facility. Note the messages about the availability of the emergency function ⇒ *page 163*.
- **Off** – The emergency call function is not available, perhaps because no network is available.

Warnings

If there is a critical system failure in the emergency call systems, the vehicle occupants will receive the following warning: see ⇒ *page 163, LED status* and ⇒ *page 163, Messages*.

i Tips

If the emergency call is canceled due to a poor connection, then the system automatically tries to connect again.

Messages

Applies to: vehicles with emergency call function

sos Emergency call function: malfunction! Limited availability. Please contact Service

If this indicator light turns on and this message appears, the emergency call function is restricted. For example, you cannot call the emergency call center, but data may still be transmitted under certain circumstances. Drive to an authorized Audi dealer or authorized Audi Service Facility immediately to have the malfunction corrected.

sos Emergency call function: malfunction! Function unavailable. Please contact Service

If this indicator light turns on and this message appears, you cannot make an emergency call. Drive to an authorized Audi dealer or authorized Audi Service Facility immediately to have the malfunction corrected.

Online roadside assistance

Description

Applies to: vehicles with online roadside assistance

An online roadside assistance call ¹⁾ is a combination of data transmission and a phone call. The data transmission from your vehicle forwards important information to the Audi service center, such as the vehicle and position data.

Calling online roadside assistance

Applies to: vehicles with online roadside assistance



Fig. 125 Front headliner: online roadside assistance button

Calling online roadside assistance

- ▶ Press the button **3**. The LED in the button turns red. The online roadside assistance call will be made.
- ▶ If you press the button **3** by mistake, then press it again. Or
- ▶ Applies to: MMI: Press **Cancel** or **End call**.

Audi incident assistance

A minor accident may be detected by the vehicle electrical system. You are able to select between online roadside assistance and an emergency call in the MMI.

i Tips

If the roadside assistance call is canceled due to a poor connection, then the call must be made again.

¹⁾ The availability of the services offered depends on the country and may change in the future.

Navigation

Opening navigation

Applies to: vehicles with navigation system



Fig. 126 Center display: standard map: route guidance not started

The navigation system directs you to your destination, around traffic incidents, and on alternative routes, if desired.

Opening navigation

► Applies to: MMI: Press **NAVIGATION** on the home screen.

After accessing the navigation for the first time, the map is displayed.

Opening navigation using the multifunction steering wheel

- Applies to: multifunction steering wheel: Select the Navigation tab in the instrument cluster.
- To display navigation when route guidance has started, select in the instrument cluster: the button > **Map**.

The following functions are available in the MMI:

- ① Open the **Select destination** menu
⇒ page 165, fig. 127.
- ② Open intelligent search directly ⇒ page 165.
- ③ **Switch between the map and the menu:**
press repeatedly until the desired function is displayed.

You can find additional information about the map update at ⇒ page 171, *Map operation*.

WARNING

– The demands of traffic require your full attention. Always read the chapter ⇒ page 18, *Traffic safety information*.

– The route calculated by the navigation system is a driving recommendation. Follow the traffic regulations that are applicable in the country where you are operating the vehicle. In the event that the driving directions contradict traffic regulations, always follow the traffic regulations applicable in the country where you are operating the vehicle to reduce the risk of an accident.

Note

Read the information about Audi connect, and be sure to note the connectivity costs section ⇒ in *General information on page 157*.

Tips

- Snow and obstructions on the GPS antenna or trees and large buildings can impair satellite reception and affect the system's ability to determine the vehicle position.
- Because street names sometimes change, the names stored in the MMI may in rare cases differ from the actual street name.
- Applies to: multifunction steering wheel: Depending on the selected function, operation through the center display may be required.
- Applies to: vehicles with Audi connect Infotainment: Depending on the country and vehicle equipment, additional services may be available.

myAudi navigation

Applies to: vehicles with Audi connect Infotainment

MMI navigation works seamlessly with the myAudi app.

Your destinations (favorites, last destinations) are synchronized through your myAudi account. All important destinations can be displayed in the vehicle and in the myAudi app. ►

myAudi navigation functions:

- You can send destinations and routes from the myAudi app to the vehicle ⇒ *page 168*.
- Active route guidance in the myAudi app can be continued in the MMI.
- Depending on the situation, it may be possible to continue active route guidance from the MMI in the myAudi app to continue navigating to the destination after leaving the vehicle.

Note

Read the information about Audi connect, and be sure to note the connectivity costs section ⇒ **Note** in *General information on page 157*.

Entering a destination

Select destination

Applies to: vehicles with navigation system



Fig. 127 Center display: menu: select destination

Opening a menu

Applies to: MMI

- ▶ Press **NAVIGATION** on the home screen.
- ▶ If the map is displayed, press **NAVIGATION** **1** ⇒ *page 164, fig. 126*.

The following functions are available ⇒ *fig. 127*:

1 Intelligent search	165
2 Enter address	166
3 Last destinations	166
4 Favorites	167
5 Points of interest	167
6 Contacts	168
7 Received dests. & routes	168

Intelligent search for navigation destinations

Applies to: vehicles with navigation system

Using the intelligent search, you can enter the data for a navigation destination in any order all at once (for example, 5th Avenue New York). You can search for points of interest, contacts, previous destinations, received destinations, and routes or favorites to navigate to the desired destination.

Opening a menu

- ▶ Applies to: MMI: Select on the home screen: **NAVIGATION** > **NAVIGATION**.

Intelligent search

- ▶ Enter one or more search terms into the input field. See ⇒ *page 22, Text input*.
- ▶ Press on the desired destination in the results list. The **Details** menu will be displayed.
- ▶ Press **Start**. Route guidance will be activated and the map will be displayed ⇒ *page 170, fig. 129*.

If the MMI is connected to the Internet ⇒ *page 157, Audi connect*, the **Intelligent search** automatically includes results from the Internet. See ⇒ **Note**.

Change search area

Requirement: route guidance must be active.

- ▶ Applies to: MMI: Select on the home screen: **NAVIGATION** > **NAVIGATION**.
- ▶ To change the search area, press **NAVIGATION** / **NAVIGATION** / **NAVIGATION** ⇒ *table on page 167* repeatedly until the desired search area is selected.





Online search¹⁾

Applies to: vehicles with navigation system and online search

You can use the results from a search engine provider to find a navigation destination.

Requirement: the MMI must be connected to the Internet ⇒ *page 157, Audi connect*.

¹⁾ Audi provides access to services from third party providers. Permanent availability cannot be guaranteed, because that depends on the third party provider.

- ▶ Applies to: MMI: Select on the home screen: **NAVIGATION** >  > **G**.
- ▶ Enter one or more search terms into the input field.
- ▶ The search engine provider shows suggestions  to narrow down the search.
- ▶ Press on suggestions until the desired destination appears in the results list. If necessary, use one finger to swipe upward or downward until the suggestions  or destinations  appear.
- ▶ Press on the desired destination . The **Details** menu will be displayed.
- ▶ Press **Start**.

Route guidance will be activated and the map will be displayed ⇒ *page 170, fig. 129*.

Note

Read the information about Audi connect, and be sure to note the connectivity costs section ⇒  in *General information on page 157*.

Tips

- The MMI input suggestions depend on the last navigated destinations.
- The navigation system always searches for the fastest route. You can have alternative routes displayed if necessary ⇒ *page 172*.
- If the destination cannot be found, it may not be stored in the navigation database. Check the spelling of the term that was searched or check the search area ⇒ *page 165*.

Entering an address

Applies to: vehicles with navigation system

As an alternative to the intelligent search, you can also enter an address in stages.

Opening a menu

- ▶ Applies to: MMI: Select on the home screen: **NAVIGATION** >  > **Enter address**.

Enter a destination using an address

- ▶ Press on the respective input field and enter an address.
- ▶ Press **Apply**. The **Details** menu will be displayed.

- ▶ Press **Start**.

Route guidance will be activated and the map will be displayed ⇒ *page 170, fig. 129*.

Destination entry for a street intersection

Requirement: you must have entered a street.

- ▶ Select: **Intersection** > *enter a street* > **Start**.

Loading previous destinations

Applies to: vehicles with navigation system

Your last destinations and routes can be loaded directly as a navigation destination.



As soon as you start route guidance, the destination is automatically saved in the last destinations. Your previous destinations are marked with the  symbol.

If you use myAudi navigation, your previous destinations will be synchronized with your myAudi account ⇒ *page 164*.

Accessing previous destinations

- ▶ Applies to: MMI: Select on the home screen: **NAVIGATION** >  > **Last destinations** > *select a destination* > **Start**.
- ▶ Applies to: multifunction steering wheel: Select in the instrument cluster: Navigation tab >  button > **Last destinations** > *a destination*.

Changing and loading a previous destination

- ▶ Applies to: MMI: Select on the home screen: **NAVIGATION** >  > **Last destinations** >  > *change the address* > **Use address** > **Start**.



Restore last tour

Requirement: a route with at least two stopovers must have already been canceled.

Your last route is labeled with the  symbol.

- ▶ Applies to: MMI: Select on the home screen: **NAVIGATION** >  > **Last destinations** > **Restore last tour**. Route guidance will start immediately.

Deleting previous destinations

- ▶ Applies to: MMI: Select on the home screen: **NAVIGATION** >  > **Last destinations** >  > ▶

select one or more entries or **Select all > Delete > (Done)**.

Tips



The last route will be automatically deleted from the list if you start a new route guidance after canceling the route.

Setting a favorite as the destination

Applies to: vehicles with navigation system

You can access frequent destinations in the favorites. You can quickly and easily start route guidance using the home address or business address function.

Requirement: a favorite must be stored
⇒ *page 173*.

- ▶ Applies to: MMI: Select on the home screen: **NAVIGATION** >  > **Favorites** > *select a destination* > **Start**. Or
- ▶ Applies to: multifunction steering wheel: Select in the instrument cluster: Navigation tab >  button > **Favorites** > *a destination*.



POIs (Online Points of Interest)

Applies to: vehicles with a navigation system and Audi connect Infotainment

Search for points of interest such as restaurants. If the MMI is connected to the Internet, points of interest will be automatically included in the search.

- ▶ Applies to: MMI: Select on the home screen: **NAVIGATION** >  > **Points of interest**.

The system always searches in the search area that is currently selected ⇒ *table on page 167*.

- ▶ **Searching for points of interest:** enter the name of a POI.
- ▶ **Searching for a point of interest in a specific category:** Select: *a category* (for example, restaurants) > *a point of interest*.
- ▶ **Changing the search area:** Requirement: route guidance must be active. Press // repeatedly until the desired search area ⇒ *table on page 167* is selected.

Sorting points of interest

Requirement: the MMI must be connected to the Internet ⇒ *page 157, Audi connect*. You must have a category selected.

- ▶ Press on the respective symbol for sorting until the desired sorting order is selected.

Search areas in detail

Symbol	Description
	Search nearby
	Search along the route
	Search at destination/Search at stopover

Search nearby: the points of interest will be listed starting from the immediate vicinity around the vehicle position.

Search along the route: points of interest along the route can only be selected during active route guidance. The points of interest are located directly along or in the immediate vicinity of the calculated route. You can select points of interest from various categories. For example, you can search for a hotel or parking lot along route.

Search at destination/Search at stopover: points of interest near a destination or a stopover can only be selected during active route guidance. You can select points of interest from various categories. For example, you can search for a hotel or parking lot at the destination.

Note

Read the information about Audi connect, and be sure to note the connectivity costs section ⇒  in *General information on page 157*.

Tips

Distances to points of interest are displayed as a straight-line distance from your current location. The actual distance from your current location to the point of interest is updated automatically. The list of points of interest that were found is not resorted when this happens.

Selecting contacts as destinations

Applies to: vehicles with MMI and navigation system

You can navigate directly to contacts.

Requirement: an address with navigation data or a navigation destination must already be assigned to a contact ⇒ *page 173*.

- ▶ Applies to: MMI: Select on the home screen: **NAVIGATION** > (☰) > **Contacts** > *a contact*.
- ▶ Press on an address.
- ▶ Check the address and change it, if necessary. Start navigation ⇒ *page 166, Entering an address*.

Route guidance will be activated and the map will be displayed ⇒ *page 170, fig. 129*.

Additional functions for contacts in navigation can be found under ⇒ *page 173*.

i Tips

- Addresses that have been imported from your mobile device into the MMI can also be used as a destination.
- If a contact is grayed out in the directory, this contact has neither a destination nor an address assigned to it.

Loading received destinations and routes

Applies to: vehicles with a navigation system and Audi connect Infotainment

You can search for destinations or routes in the myAudi app and send to the vehicle.

Requirement: the MMI and the mobile device must be connected to the Internet ⇒ *page 157, Audi connect*. You must have the myAudi app installed on your mobile device.

- ▶ Send a destination or route in the myAudi app to the vehicle.
- ▶ Applies to: MMI: Select on the home screen: **NAVIGATION** > (☰) > **Received dests. & routes**.
- ▶ Make sure you are logged into the vehicle and the myAudi app with the same myAudi account. The received destination and routes will be loaded automatically.
- ▶ **Navigating to a destination:** press on a destination.

- ▶ **Deleting destinations:** select:  > *one or more entries* or **Select all** > **Delete** > **(Done)**.

! Note

Read the information about Audi connect, and be sure to note the connectivity costs section ⇒  in *General information on page 157*.

i Tips

To avoid having you enter your myAudi access information in the vehicle again, you can use the automatic login ⇒ *page 27*.

Destination details

Applies to: vehicles with navigation system



Fig. 128 Center display: details

After you have selected a destination, the details will be displayed. Route guidance will not be active yet.

The functions depend on the vehicle equipment and the selected destination.

- ① **Map preview:** to zoom in on the map preview, press on the map.
- ② **Route criteria:** see ⇒ *page 178*.
- ③ **More:** see ⇒ *page 177, Options*.
- ④ **Weather:** Requirement: the MMI must be connected to the Internet ⇒ *page 157, Audi connect*. Also see ⇒ *page 158*.
- ⑤ Applies to: MMI and telephone
Call: Requirement: a mobile device must be connected to the MMI ⇒ *page 143*. You will make a direct call to the phone number that is stored for the destination.
- ⑥ **Start:** starts navigation to the displayed destination directly. The map will be displayed ⇒ *page 171, Map operation*.

- ⑦ **Parking:** press **Parking** to search for a parking space at the destination. You can use the parking space as the destination or stopover.
- ⑧ **Details:** Requirement: the MMI must be connected to the Internet ⇒ *page 157, Audi connect*.
- ⑨ **Weather at the destination:** Requirement: the MMI must be connected to the Internet ⇒ *page 157, Audi connect*.
- ⑩ **Display of distance/driving time to the destination**

! Note

Read the information about Audi connect, and be sure to note the connectivity costs section ⇒ ! in *General information on page 157*.

Selecting a destination from the map

Applies to: vehicles with navigation system

A point on the map can be used as the destination.

Opening the map

Applies to: MMI

- ▶ Press **NAVIGATION** on the home screen.
- ▶ If necessary, press  to display the map.

Adjusting the scale

- ▶ Select:  /  > *select a scale*.

Marking the destination

- ▶ Press and hold a point on the map until a marking appears ⑳ ⇒ *page 170, fig. 130*. **Or:** the address of the selected destination is displayed ⑯ ⇒ *page 170, fig. 130*.

Selecting map content (such as POIs) as the destination

Requirement: map content must be displayed ⇒ *page 177*.

- ▶ Press on map content on the map (for example, ㉒ ⇒ *page 170, fig. 130*).

Selecting the destination

- ▶ Select: ㉑ ⇒ *page 170, fig. 130*. **Or:**
- ▶ To display destination details, press on ⑯ ⇒ *page 170, fig. 130* > **Start**.

Route guidance will be activated and the map will be displayed ⇒ *page 170, fig. 129*.

Stopovers and route plan

Applies to: vehicles with navigation system

You can enter additional destinations during active route guidance.

Entering a stopover

Requirement: route guidance must be active.

- ▶ Enter a destination ⇒ *page 165*.

Displaying stopovers or the route plan

All destinations are listed in the route plan.

- ▶ Press on ⑦ ⇒ *page 170, fig. 129* on the map.



Editing stopovers

- ▶ Press on ⑦ ⇒ *page 170, fig. 129* on the map.
- ▶ **Adding a stopover:** Select: **Add destination** > *select a destination* > **Add**.
- ▶ **Moving a stopover:** press . Touch the  symbol and move the entry to the desired position. Press **Done**.
- ▶ **Deleting a stopover:** Select:  > *one or more entries* or **Select all** > **Delete** > **(Done)**.

Stopping route guidance

Applies to: vehicles with navigation system

Requirement: route guidance must be active and the map must be displayed.

- ▶ Applies to: MMI: Press  in the center display ③ ⇒ *page 170, fig. 129*. **Or:**
- ▶ Applies to: multifunction steering wheel: Select in the instrument cluster: **Navigation tab** >  button > **Cancel route guidance**.

Map

Map functions

Applies to: vehicles with navigation system



Fig. 129 Center display: principle of operation: active route guidance



Fig. 130 Center display: principle of operation: marked map object

Opening the map

Applies to: MMI

- ▶ Press **NAVIGATION** on the home screen.
- ▶ If necessary, press **▲** to display the map.

The following list gives an overview of the information displayed on the map. Press on any function (for example, alternative routes) to show additional options.

- ① Destination entry ⇒ page 165
- ② Intelligent search ⇒ page 165
- ③ Cancel route guidance ⇒ page 169
- ④ Current route
- ⑤ Request spoken prompt
- ⑥ Alternative routes ⇒ page 172
- ⑦ Display active destinations, stopovers, or route plan. The distance to the destination including the calculated arrival time is displayed. See ⇒ page 169.

- ⑧ For vehicles with trailer mode, the symbol indicates that the function is switched on. ⇒ page 178
- ⑨ Traffic information ⇒ page 176
- ⑩ Altitude
- ⑪ Displays the maximum permitted speed¹⁾: within city limits, on expressways, and on highways.
- ⑫ Current vehicle position
- ⑬ Route information ⇒ page 178
- ⑭ Name of the street on which you are currently driving
- ⑮ Start route guidance for the marked destination ⑳ ⇒ page 169, *Selecting a destination from the map*
- ⑯ Display details for the destination ⇒ page 168
- ⑰ POI search within the vicinity of a marking
- ⑱ Adjust the map orientation. See also ⇒ page 177
- ⑲ Navigation settings ⇒ page 177
- ⑳ Adjust the scale. Set scale. **Or:** Press the magnifying glass to switch automatic zoom ⇒ page 177 on or off directly on the map. The **Ⓐ** symbol appears when this function is switched on.
- ㉑ Marked destination. See ⇒ page 169, *Selecting a destination from the map*
- ㉒ Map contents (points of interest, favorites). When there are multiple map contents in the immediate vicinity, the symbols are shown stacked on the map. To display a list of individual symbols, press ⑯ ⇒ fig. 130. Press on a POI in the list.
- ㉓ Center the map to the current vehicle position

Additional possible symbols on the map

Symbol	Description
	Home address ⇒ page 173, <i>Favorites</i>
	Business address ⇒ page 173, <i>Favorites</i>

1) Only applies to vehicles without camera-based speed limit display.

Symbol	Description
★	Favorites ⇨ <i>page 173</i>
🚩	Previous destinations display

Traffic information display on the map or map preview

Color-coded markings along the route indicate the traffic flow:

Green: traffic is flowing freely.

Orange: stop-and-go traffic

Red: traffic jam or traffic obstructions.

Shaded markings indicate the length of the area with congestion.

Traffic incidents

- **Colored warning symbols:** traffic incidents ahead that are on your route.
- **Grayed out warning symbols:** traffic incidents that are not on your route.
- All traffic incidents will display in color when route guidance is inactive.
- **Warning symbols with arrow:** traffic incident that you have been routed around, for example .

You can adjust the display of colored markings for traffic information on the maps ⇨ *page 177*.

Map operation

Applies to: vehicles with navigation system

You can operate the map ⇨ *page 170, fig. 129* with the movements described in the following information.

Moving the map

- ▶ Drag your finger across the map in the desired direction.

Moving the map quickly

- ▶ Swipe your finger across the map in the desired direction and lift your finger off the map.

Zooming in on the map

- ▶ Place two fingers on the map and pull your fingers apart. **Or:** double tap on the map with one finger.

Zooming out on the map

- ▶ Place two fingers on the map and pull your fingers together. **Or:** double tap on the map with two fingers.

Rotating the map

- ▶ Rotate the map using two fingers.

Tilting the map

- ▶ Drag upward or downward with two fingers.

Tips

Certain gestures may not be available on all touch displays or in every menu.

Navigation view with route guidance started

Applies to: vehicles with navigation system and Audi virtual cockpit

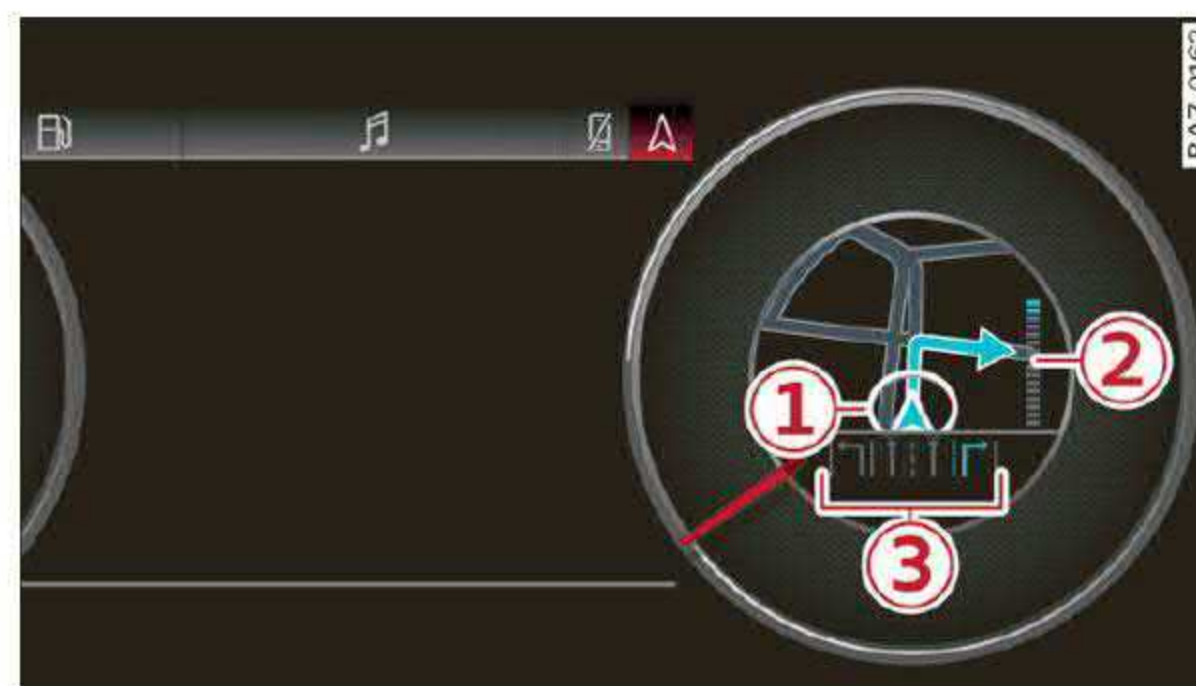

Fig. 131 Instrument cluster: default view: turning maneuver when route guidance has started

Requirement: route guidance must be on ⇨ *page 165*.

The following information will be displayed in the driver information system, if available:

- ① Current vehicle position
- ② A bar graph appears when there is an upcoming turn. The fewer the bars that are shown, the shorter the distance is until the turn. If there is no upcoming turn immediately ahead, the distance to the destination or stopover, the calculated arrival time, and a direction arrow for the upcoming maneuver will be displayed in the right speedometer. If there is no upcoming maneuver, the distance to the next maneuver will be displayed.

③ Lane recommendation

Personal route assistance

Applies to: vehicles with navigation system and personal route assistance

Your MMI can learn the routes that you drive frequently (such as your daily commute to work and back) and suggest route guidance based on the current vehicle position.

When the function is switched on, the MMI records the routes driven regardless of whether or not you are using navigation.

Without starting route guidance, your MMI can check the traffic conditions and shows possible traffic incidents for the possible routes to be driven.

Opening personal routes

Requirement: personal route assistance must be switched on ⇒ [page 178](#). Route guidance must not be active. A notification is displayed.

- ▶ The MMI displays up to three suggestions. Press on a suggestion. Route guidance will start.

Better routes

If there are major traffic incidents, the MMI will display a notification regardless of the selected menu. If the MMI has calculated a better route, you can select it as the route.

- ▶ Press on the notification.

As soon as you switch off personal route assistance, your personal routes will no longer be recorded. Routes that were already stored remain stored.

Deleting personal routes

- ▶ Applies to: MMI: Select on the home screen: **NAVIGATION** >  > **Personal route assistance** > **Delete recordings from the last 24 hours** or **Delete all personal routes and destinations**.

Tips

If personal route assistance is switched off and you press , the personal route assistance settings will be displayed ⇒ [page 178](#).

Alternative routes

Applies to: vehicles with navigation system



Fig. 132 Center display: display of alternative routes in the overview map







Opening alternative routes

Requirement: route guidance must be started ⇒ [page 165](#) and the map must be displayed ⇒ [page 171](#).

- ▶ Press  ⇒ [page 170](#), [fig. 129](#).

① Move route

You can move the route up to the next destination or stopover.

- ▶ Press . The  symbol will be displayed on the map.
- ▶ Press and hold , and use your finger to pull the route to the desired position. Repeat this step until the desired route appears.
- ▶ Press .
- ▶ To cancel, press on the current route . Or: press .

② Block route

You can block the current route for a certain distance starting from the vehicle position, for example to drive around upcoming streets or tunnel closures. The navigation system automatically calculates an alternative route and the length of the blocked route. The route to be avoided that you have entered applies only to the current route and must be set again, if needed. The areas you have selected to avoid will appear with red and white shading on the map.

► **Block route:** press ② ⇒ *fig. 132*.

► **Cancel route block:** press .

③ Current route

The distance to the destination and the calculated arrival time will be displayed for the current route.

④ Alternative route

As long as traffic information is available, the congestion along the route including the time delay will be displayed. The distance to the destination and the calculated arrival time will be displayed for the alternative route.

Select route

► Press on the information window for the applicable alternative route (for example ④ ⇒ *fig. 132*).

Additional functions

Favorites

Applies to: vehicles with navigation system

You can access frequent destinations in the favorites. You can quickly and easily start route guidance using the home address or business address function.

Accessing favorites

► Applies to: MMI: Select on the home screen: **NAVIGATION** >  > **Favorites**.

If you use myAudi navigation, your favorites will be synchronized with your myAudi account ⇒ *page 164*.

Storing favorites

► Press ☆ in the **Details** menu ⇒ *page 168, fig. 128*. **Or:** press **Store as favorite** in the options ⇒ *page 177*.

Storing a home address or business address

► Press **Home address** or **Business address**.
When accessed for the first time, you will be prompted to set the address.
► Select: **Create now** > *enter a destination* > **OK**.



Editing a home address or business address

Requirement: the favorites list must be displayed. Your home address or business address must be stored.

► Press **Home address** or **Business address** until the **Options** menu is displayed.
► Select: **Change address** > *enter a destination* > (**Set as destination**) or (*Add to address*) > **OK**.

Editing a favorite

Requirement: the favorites list must be displayed. At least one favorite must be stored.

► **Setting a favorite as a destination:** press on a favorite.
► **Rename favorite:** press on a favorite until the **Options** menu is displayed. Select: **Change name** > *select a name* > **OK**.
► **Deleting a favorite:** press ★ in the **Details** menu ⇒ *page 168, fig. 128*. **Or:** select:  > *one or more entries* or **Select all** > **Delete** > (**Done**).
► **Moving a favorite:** press . Touch the  symbol and move the entry to the desired position. Press **Done**.

Tips

- After deleting the home address or business address, only the address is deleted and the entry will still be displayed in the favorites.
- Please note when moving favorites that items 1 and 2 are reserved for the home address and business address.

Contacts as navigation destinations

Applies to: vehicles with navigation system

Two addresses (private/business) can be added as destinations for each contact. Addresses for contacts on your mobile device are displayed as a mailing address.

Accessing contacts

► Applies to: MMI: Select on the home screen: **NAVIGATION** >  > **Contacts**.



Adding a destination to a contact

Requirement: a mobile device must be connected to the MMI ⇒ *page 143*. **Or:** you must have

imported contacts ⇒ *page 154, Importing and exporting contacts*. The **Hide grayed-out contacts** option must be switched off ⇒ *page 174*. There must be no business address or private address stored for the desired contact.

- ▶ Select: *a contact* >  > **Add destination**.
- ▶ Follow the system instructions.

Settings

- ▶ Applies to: MMI: Select on the home screen: **NAVIGATION** >  > **Contacts** > .

Hide grayed-out contacts

When the function is switched on, contacts that have no address or navigation destination stored will be hidden in navigation. You can find information for additional settings under ⇒ *page 154, Directory settings*.

Tips



If you add a navigation destination to a contact, the destination will only be stored in the MMI. The MMI does not change any contacts on your phone.

On-street parking

Applies to: navigation system and on-street parking

In supported areas, you can display parking along the route.

Requirement: the **Parking** notification must be switched on ⇒ *page 20, Notification center*. The MMI must be connected to the Internet ⇒ *page 157, Audi connect*. Route guidance must be active, you must be close to your destination, and a notification must be displayed. **Or:** a point is marked on the map.

- ▶ Press on the notification. **Or:** press on  on the map.
- ▶ To navigate to a parking: space, press on a colored marking on the map.
- ▶ Select:  > **Start**.

Depending on availability, colored markings on the map indicate the probability of open parking spaces.

Color	Description
Green	High probability
Orange	Medium probability
Red	Low probability

Note

Read the information about Audi connect, and be sure to note the connectivity costs section ⇒  in *General information on page 157*.

Satellite map

Applies to: vehicles with navigation system and satellite map

You can display the navigation map with satellite images.

Requirement: the MMI must be connected to the Internet ⇒ *page 157, Audi connect*.

- ▶ Applies to: MMI: Select on the home screen: **NAVIGATION** >  > **Map settings** > **Satellite map**¹⁾.

The map view is based on data packets received from the Internet in the form of satellite images, which are then combined with the roadways from the ⇒ *page 170, fig. 129* standard map view.

Note

Read the information about Audi connect, and be sure to note the connectivity costs section ⇒  in *General information on page 157*.

Tips

- The satellite map¹⁾ is updated regularly whenever the function is opened. The process may take several seconds.
- When the satellite map display is switched on¹⁾ with the 3D position map type, the display automatically switches to the 2D map type when driving through tunnels.

¹⁾ Audi provides access to services from third party providers. Permanent availability cannot be guaranteed, because that depends on the third party provider.

- Depending on the Internet connection, the standard map may also be displayed when the satellite map is switched on ¹⁾.

Map update

Introduction

Applies to: vehicles with navigation system

You can update the map data in the MMI with a map update. The functions depend on the country and vehicle equipment:

- Map updates through **online map update** ⇒ *page 175*.
- Import map updates from the **SD card** or **USB connection** to your MMI ⇒ *page 175*.
- Map update at an authorized Audi dealer or authorized Audi Service Facility. This can result in additional costs.

Online map update

Applies to: vehicles with MMI, navigation system, and Audi connect Infotainment

Using map update online, you can update the map material in your navigation system directly from your vehicle.

Using your vehicle position, the MMI identifies regions which you are frequently in. Based on this, update data for these regions are available for your MMI.

Start map update

Applies to: MMI

Requirement: the MMI must be connected to the Internet ⇒ *page 157, Audi connect*.

- ▶ A notification for a map update will appear in the center display.
- ▶ If the option **Automatic online map update** ⇒ *page 176* is switched on, the MMI will start the map update. **Or:**
- ▶ Press on the notification. **Or:** access the notification in the notification center on ⇒ *page 20* and press on the notification.

- ▶ If the **Automatic online map update** option ⇒ *page 176* is switched off, press on **Allow once** or **Always allow**.

The MMI will start the map update. The progress of the download and installation will be shown in the center display.

When the update has ended, a notification will be displayed.

! Note

Read the information about Audi connect, and be sure to note the connectivity costs section ⇒ ! in *General information on page 157*.

i Tips

Because of the high volume of data, Audi recommends performing the map update using the USB connection ⇒ *page 175*.

Map update using an SD card or USB connection

Applies to: vehicles with MMI, navigation system, and Audi connect Infotainment

With the map update, you can update the map material in your navigation system.

Requirement: you must have created a myAudi account at my.audi.com. Your vehicle must be registered in your myAudi account.

Prepare map update

- ▶ Download the map update at my.audi.com and store it on an SD card or on a USB flash drive. For additional information, visit my.audi.com.

Start map update

- ▶ Insert the SD card in your vehicle's SD card reader ⇒ *page 188*, or
- ▶ Connect the USB flash drive to the Audi music interface ⇒ *page 190*. A notification for a map update will appear in the center display.
- ▶ Press on the notification, or

¹⁾ Audi provides access to services from third party providers. Permanent availability cannot be guaranteed, because that depends on the third party provider.

- ▶ Open the notification in the notification center on ⇒ *page 20* and press on the notification. The update package is shown.
- ▶ Press **Next**. The status of the installation is shown in the center display.
- ▶ When the update has ended, a notification will be displayed.

Map updates settings

Applies to: vehicles with a navigation system and Audi connect Infotainment

- ▶ Applies to MMI: Select on the home screen: **SETTINGS** > **System maintenance**.

Automatic online map update: when the function is switched on, map updates will be automatically downloaded and installed.

! Note

Read the information about Audi connect, and be sure to note the connectivity costs section ⇒ ! in *General information on page 157*.

Traffic incidents

Introduction

Applies to: vehicles with navigation system



Fig. 133 Center display: diagram: traffic information overview

Open traffic information

Requirement: the map must be displayed ⇒ *page 171*.

- ▶ Press 9 ⇒ *page 170, fig. 129*.

Display traffic report details

- ▶ Press on the traffic report 2 ⇒ *fig. 133*.
- ▶ To display the previous or next traffic report, press ← or →.

The following information can be displayed ⇒ *fig. 133*:

- 1 A message will appear if the MMI calculates a better route for the current route guidance. More information can be found under ⇒ *page 176*.
- 2 A traffic message is displayed. The distance to the hazardous area is calculated from the current vehicle position.
- 3 The traffic messages are only shown when route guidance is active. Press on a line to display details about it.

! Note

Read the information about Audi connect, and be sure to note the connectivity costs section ⇒ ! in *General information on page 157*.

i Tips

- Particularly critical traffic information, such as warnings about wrong-way drivers, is automatically displayed as a notification.
- Traffic information is not available in some countries.

Better route

Applies to: vehicles with navigation system

By receiving traffic, your MMI calculates a better route if available and the possible time saved compared to the current route. You can decide which route you would like to use.

A notification will appear for several seconds if your MMI calculates a better route for the current route guidance.

A message will also appear in the traffic information overview 1 ⇒ *page 176, fig. 133*.

Accept better route

Requirement: a notification about a better route must be displayed.

- ▶ Press . The better route is used for route guidance and the route is recalculated. **Or:** press the notification in the central area. The better route with the calculated arrival time is displayed ⇒ *page 172, Alternative routes*. Press ▶

on a better route (for example  ⇒ *page 172, fig. 132*).

Online traffic information

Applies to: vehicles with navigation system and online traffic information

The MMI can receive real-time online traffic information about congestion, accidents, road construction, and other incidents.

Requirement: the MMI must be connected to the Internet ⇒ *page 157, Audi connect*. Traffic information must be switched on in the MMI ⇒ *page 177*.

Traffic information will be displayed on the standard map ⇒ *page 170, fig. 129*.

Online traffic information is also displayed on the standard map ⇒ *page 174*.

Note

Read the information about Audi connect, and be sure to note the connectivity costs section ⇒  in *General information on page 157*.

Tips

- Having the **online traffic information** function switched on provides the most accurate reports of traffic situations and traffic forecasting. Your vehicle transmits and processes its anonymous, encrypted position information at regular intervals to the traffic data provider. You can switch off data transfer at any time ⇒ *page 262*.
- The **online traffic information** network is not available in all countries, and the coverage is not nationwide.

Options and settings

Options

Applies to: vehicles with navigation system

Context-specific functions and settings may be available depending on the vehicle equipment.

- ▶ Press **More**, or

- ▶ Open a list with navigation destinations (such as recent destinations) and press and hold an item until the **Options** menu is displayed.

Store as favorite

See ⇒ *page 173*.

Edit address

You can edit an address for the next destination entry and navigate to the destination. Select: **Edit address** > *enter a street* > **Use address** > **Start**. If the address is permanently stored (for example, in the favorites), the stored entry will not be changed.

Change address

See ⇒ *page 173, Favorites*.

Enter address

See ⇒ *page 173, Contacts as navigation destinations*.

Change name

See ⇒ *page 173, Favorites*.

Weather

See ⇒ *page 158, Services*.

Save as a shortcut

See ⇒ *page 21, Shortcuts*.

Settings

Applies to: vehicles with navigation system

You can adjust the navigation system settings in the instrument cluster and the center display separately. The settings depend on the country and vehicle equipment.

Accessing settings

- ▶ Applies to: MMI: Select on the home screen: **NAVIGATION** > .

Accessing settings using the multifunction steering wheel

- ▶ Applies to: multifunction steering wheel: Select in the instrument cluster: Navigation tab >  button. ▶

Please note that a setting applied to the multi-function steering wheel is only valid for the instrument cluster map.

Map settings

Satellite map: see ⇒ *page 174*.

Traffic: you can display current traffic information on the map. See ⇒ *page 171, Traffic information display on the map or map preview*

- **Free flowing traffic**
- **Traffic obstructions**
- **Traffic incidents**

Map colors

- **Automatic:** the map display adapts to the lighting conditions (for example, by changing from day to night when driving through a tunnel).
- **Day or Night**

Map orientation

- **2D map** or **2D north up:** the current vehicle position is displayed. The map is oriented in the direction of travel or to the north.
- **3D map:** the current vehicle position is shown on a three-dimensional map and is oriented in the direction of travel.
- **Overview:** the entire route from the vehicle position to the destination or the next stopover is displayed on the map. The map is oriented to the north.

Automatic zoom

- **On:** the map scale is adapted automatically depending on the type of road being traveled (expressway, highway, other roads) so that you always have an optimal overview of the road ahead. When route guidance is active, the scale is adjusted automatically for a better detailed view when there are upcoming maneuvers.
- **Intersection:** when route guidance is active, the scale is adjusted automatically for a better detailed view when there are upcoming maneuvers.
- **Off**

MMI map contents/Map content: you can switch the display of additional information (such as POIs) on the map in the center display on or off. Note the following for the 3D city model ⇒ .

Voice guidance

Voice guidance: you can adjust the navigation prompts. With the **Traffic** setting, the MMI will only give prompts if there are traffic incidents on your route.

Voice guidance during phone call

Entertainment fader during navigation: the audio playback volume is temporarily lowered when navigation prompts are active.

Route criteria

You can adjust which route criteria should be allowed or avoided for the route calculation.

HOV/carpool lanes

Highways

Toll roads

Ferries

Route information

When this function is switched on and route guidance is active, route information  ⇒ *page 170, fig. 129* is displayed. The next maneuver will be displayed at the bottom. POIs and traffic information will also be displayed. Press route information to display a preview of the next maneuver on the map. You can switch the following information on or off in route information.

- **Points of interest along the route**
- **Traffic incidents**

Personal route assistance

Personal route assistance is switched off at the factory.

Your trips are recorded and destinations are suggested by the MMI when this function is switched on ⇒ *page 172*.

Trailer mode

Trailer mode is switched off at the factory.

When the function is switched on, the maximum permitted speed for vehicles with trailers is included during route guidance and the calculated arrival time is adjusted accordingly. When the 

function is switched on, the symbol 
⇒ *page 170, fig. 129* is displayed on the map.

Presentation mode

In presentation mode, the system simulates driving on the center display along the planned route without the vehicle actually moving. You can use **Specify starting point** when you would like to calculate a route starting from a location other than the current vehicle position, for example. **Simulating route guidance:** start route guidance and press presentation mode.

Note

Read the information about Audi connect, and be sure to note the connectivity costs section
⇒  in *General information on page 157*.

Tips

You can change the volume of navigation announcements while one is playing ⇒ *page 26*.

Radio

Opening the radio



Fig. 134 Center display: station list



Fig. 135 Center display: SiriusXM station list

Depending on the vehicle equipment, the radio may support the FM, AM, and SiriusXM (satellite radio) frequency bands. Using the HD Radio receiver also allows you to receive radio stations on the FM and AM bands in digital format.

Depending on the station list, the following information may be displayed:

① Station list

Shows the station that is currently playing. The station list updates automatically.

② Stations

Depending on availability, the station name as well as program information, for example, may be displayed.

③ HD Radio technology

FM/AM stations that can be received by digital radio are marked with the HD Radio technology symbol **HD**.

If reception quality declines, the radio automatically switches to the analog FM/AM station depending on availability.

④ Additional stations

Digital HD Radio stations may contain multiple additional stations. If you lose reception,

the additional stations will be muted since they can no longer be received.

⑤ Radio ID

Your radio ID and contact data for your satellite radio provider are displayed.

⑥ Channel number

⑦ Smart Favorite



See ⇒ *page 183*.

Adjusting the radio using the MMI

- ▶ Applies to: MMI: To set a frequency band, select on the home screen: **RADIO** > **Source a frequency band**.
- ▶ Applies to: MMI: To set a station, select on the home screen: **RADIO** > **Source** > *select a station list* > *select a station*.
- ▶ To select a frequency, follow the instructions under ⇒ *page 182, Free text search*.

Adjusting the radio using the multifunction steering wheel

Requirement: radio mode must be on.

- ▶ Select the Radio/Media tab using the multifunction steering wheel.
- ▶ To switch between radio and media, select the  button > **Switch to radio/Switch to media**.
- ▶ Turn the left thumbwheel to display the station list.
- ▶ To switch to a different source, press the  button.
- ▶ To select a station or a source, turn and press the left thumbwheel.

Tips

- Contact the SiriusXM* provider if you would like to receive satellite programming.
- Buildings, tunnels, bridges, open areas, other vehicles or objects on the vehicle roof can affect reception.
- Satellite radio is not available in all regions.
- Applies to: multifunction steering wheel: Depending on the selected function, operation through the MMI may be required.

Radio functions

Overview

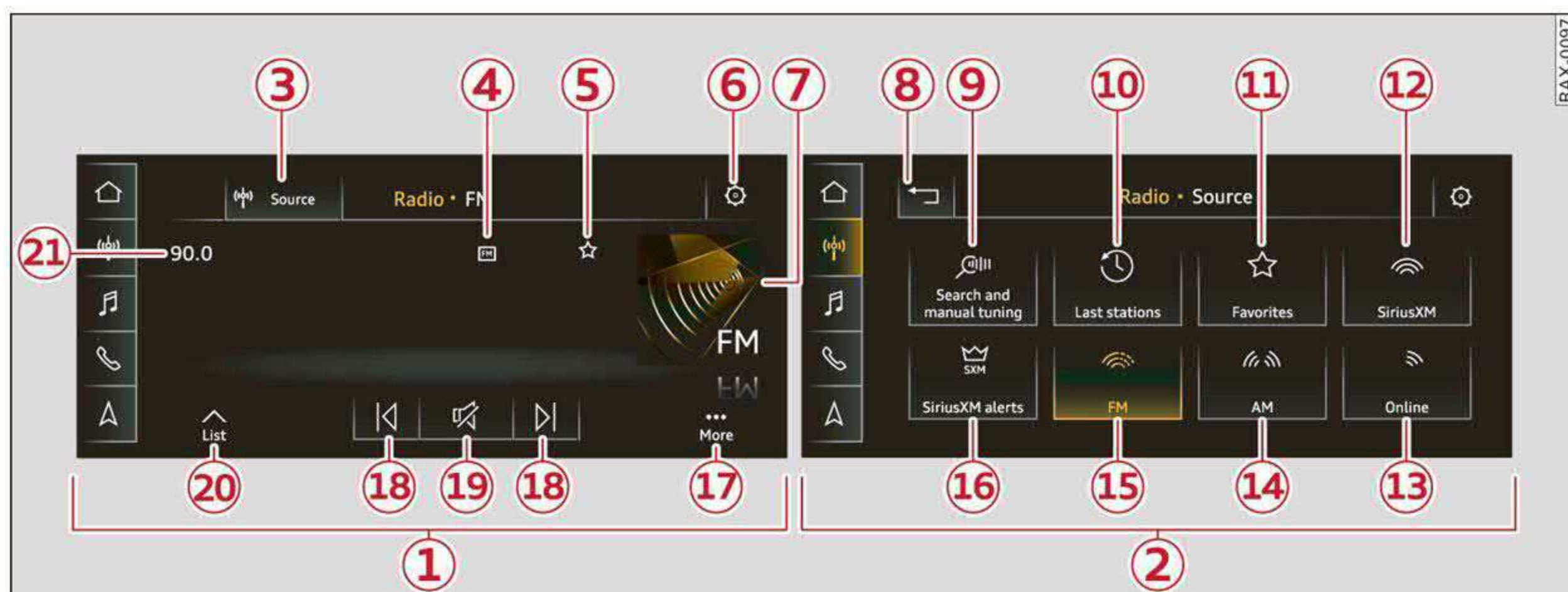

Fig. 136 Center display: left side: playback view of radio functions, right side: sources

Operating

- ▶ Applies to: MMI: To open the playback view (1), select on the home screen: **RADIO** > *select a radio station*.
- ▶ Applies to: MMI: To open the sources (2), select on the home screen: **RADIO** > **Source**.

The following functions may be available depending on the selected radio station and the vehicle equipment:

	Symbol/Description	Description
(3)	Source	Displays sources in the Radio menu.
(4)	Frequency band	Shows the current station frequency band. If a symbol with the WEB label is displayed, then the station is being streamed from online. Always follow the information found in ⇒ !.
(5)	☆/★	See ⇒ page 182.
(6)	⚙️	Settings ⇒ page 186.
(7)	Station logo	Switching between picture views: press the station logo. Use one finger to swipe to the right or left to switch between the Station logo and Cover art . Station logo: the station logo is displayed, depending on availability. Cover art: displays the album cover, if available. Always follow the information found in ⇒ !.
(8)	↩️	Go back one level.
(9)	Search	See ⇒ page 182.
(10)	Last stations	Displays the last played stations ⇒ page 182.
(11)	Presets	See ⇒ page 182.
(12)	SiriusXM station list	Displays stations from the SiriusXM frequency band.
(13)	Online	See ⇒ page 184.
(14)	AM	Displays stations from the AM frequency band.

	Symbol/Description	Description
15	FM	Displays stations from the FM frequency band.
16	SiriusXM alerts	Overview of songs, artists, or teams from the stored SiriusXM alerts being currently received ⇒ <i>page 183</i> .
17	More	Access options for the current station ⇒ <i>page 185</i> .
18	⏮/⏭	Select the previous/next station.
19	🔊/🔇	Unmutes or mutes playback.
20	List	The station list is displayed ⇒ <i>page 180</i> .
21	Info section	Depending on availability, the station name as well as program information, for example, may be displayed. Also see ⇒ <i>page 186</i> , Online additional data .

! Note

Read the information about Audi connect, and be sure to note the connectivity costs section ⇒ **!** in *General information on page 157*.

i Tips

Not all functions are available in every source and on every touch display.

Free text search

Applies to: vehicles with free text search

Using the free text search, you can select the order that the search terms are entered in the input field. Search in all frequency bands for a station name, channel number, or program type, such as **News**. You can also select the frequency.

Opening free text search

- ▶ Applies to: MMI: Select on the home screen: **RADIO > Source > Search**.

Setting the frequency

- ▶ Enter a frequency.
- ▶ Press on a frequency in the results list.

The following information may be available:

Symbol	Description
🕒	Results from the list: Last stations
☆	Results from the list: Presets
📶	Results from a Station list
For example, FM	Station frequency band

Last stations

Applies to: vehicles with last stations

You can listen to the last stations that were played in all frequency bands.

Accessing last stations

- ▶ Applies to: MMI: Select on the home screen: **RADIO > Source > Last stations**.

Listening to last stations

- ▶ Press on *a station*.

Deleting last stations

- ▶ Select: > *select one or more stations* or **Select all > Delete > (Done)**.

Presets

Applies to: vehicles with presets

You can store your favorite stations from every frequency band in the presets list.

Selecting presets using the MMI

- ▶ Applies to: MMI: Select on the home screen: **RADIO > Source > Presets > a preset**.

Storing presets

- ▶ Press ☆ **5** in the playback view ⇒ *page 181*, *fig. 136*.



Requirement: a list with radio stations must be displayed ⇒ *page 180*, *fig. 134*.

- ▶ Press and hold an entry in the list until the **Options** menu appears.
- ▶ Press **Store as preset**.

Editing a preset

- ▶ **Deleting presets:** press ★ in the playback view, or
- ▶ In the presets list, select:  > *one or more stations* or **Select all** > **Delete** > **(Done)**.

Requirement: the presets list must be displayed.

- ▶ **Moving a preset:** press .
- ▶ Touch the  symbol and move the entry to the desired position.
- ▶ Press **Done**.

Smart Favorites

Applies to: vehicles with SiriusXM

SiriusXM channels are stored in the presets as Smart Favorites with the  symbol. After switching the ignition and the MMI on, the Smart Favorites store radio programs at a specific time.

- ▶ Press on a Smart Favorite. You have the following options:
 - ▶ **Pause/Start:** press .
 - ▶ **Selecting the previous or next track:** press  or .
 - ▶ **Going to the beginning of a recording or live program:** press and hold  or .
 - ▶ **Setting the playback point:** you can adjust the playback position using the knob.
 - ▶ **Going to a live program:** press .

Radio text

Program information (for example, general text messages, artist, composer, song) is displayed in the radio text.

Requirement: the selected radio station must support the radio text function.

Opening radio text

- ▶ Applies to: MMI: Select on the home screen: **RADIO** > *select a frequency band (such as FM)* > *select a station* > **More** > **Radio text**.

Displaying previous radio text entries: drag your finger downward. The last radio text entries are displayed if they are available.

Browsing through radio text entries: drag your finger upward or downward on the screen.

If a radio text entry is displayed with a color, a phone number or a navigation destination for the station is available as radio text plus information.

Tips

The availability of radio text and RadioText Plus depends on the radio station.

SiriusXM alerts

Applies to: vehicles with SiriusXM

You can see an overview of your favorite artists, favorite songs, or teams that are currently being broadcast on a SiriusXM channel.

Accessing SiriusXM alerts

- ▶ Applies to: MMI: Select on the home screen: **RADIO** > **Source** > **SiriusXM alerts**.

After you have saved a SiriusXM alert, you can see an overview in the **SiriusXM alerts** menu of the songs, artists, or teams being currently received and can play them directly from there.

Storing a SiriusXM music alert

Requirement: an artist or song must be playing on a SiriusXM channel.

- ▶ Applies to: MMI: Select on the home screen: **RADIO** > **Source** > **SiriusXM** > *select a channel* > **More** > **Artist as SXM alert/Title as SXM alert**.

Storing a SiriusXM game alert

- ▶ Applies to: MMI: Select on the home screen: **RADIO** >  > **Manage SiriusXM alerts** > **Store SiriusXM game alerts** > *select an entry from the list*.

Playing a song/artist/team from a SiriusXM alert (option 1)

Requirement: a SiriusXM music/game alert must be stored and must be currently broadcast on a SiriusXM channel.

- ▶ Applies to: MMI: Select on the home screen: **RADIO** > **Source** > **SiriusXM alerts** > *select an entry from the list*.

Radio

Playing a song/artist/team from a SiriusXM alert (option 2)

Requirement: a SiriusXM music/game alert must have been received.

- ▶ Press on the notification, or
- ▶ Open the notification in the notification center on \Rightarrow *page 20* and press on the notification.

Managing SiriusXM alerts

Requirement: a SiriusXM alert must be stored.

- ▶ Applies to: MMI: Select on the home screen: **RADIO** >  > **Manage SiriusXM alerts** > **Selected SiriusXM music alerts/Selected SiriusXM game alerts**.

When the function is switched on , a SiriusXM alert will be received.

Deleting SiriusXM alerts

- ▶ Select: **Selected SiriusXM music alerts/Selected SiriusXM game alerts** >  > *select one or more alerts* or **Select all** > **Delete** > **(Done)**.

Online radio

General information

Applies to: vehicles with Audi connect Infotainment and on-line radio

You can listen to various radio stations or podcasts on the Internet using online radio.

Requirement: the MMI must be connected to the Internet \Rightarrow *page 157, Audi connect*.

Opening online radio using the MMI

- ▶ Applies to: MMI: Select on the home screen: **RADIO** > **Source** > **Online**.

The following functions are available:

Search

You only can search for online radio stations in this search. You can search for station names and categories.

Last played station

The station that was played last will start playing.

Top stations

Select a station from the list of popular online radio stations.

Filter list

- ▶ Select:  > *(a category)* > *a station name*.

The following categories are available:

- **Countries**
- **Genres**
- **Languages**

Note

Read the information about Audi connect, and be sure to note the connectivity costs section \Rightarrow  in *General information on page 157*.

Tips

- Depending on the Internet connection and network traffic, the connection may be lost when online radio is playing.
- Online radio reception may not be possible if Internet service is throttled.
- The use of online radio depends on the service availability of the third party provider.
- The range and screen display of online media services from third party providers in the vehicle can vary.
- Audi only provides access to online radio and does not assume any responsibility for the content of these services.

Podcasts

Applies to: vehicles with Audi connect Infotainment and on-line radio

Opening podcasts using the MMI

- ▶ Applies to: MMI: Select on the home screen: **RADIO** > **Source** > **Online** > **Podcasts**.

The following functions are available:

Listening to a podcast

- ▶ Select: *a podcast* > *a podcast episode*.

Search

- ▶ Press .

The following functions are available in the podcast playback view:

Displaying podcast episodes

- ▶ Press **List**.

Starting/stopping podcast playback

- ▶ Press **▷/||**.

Previous/next podcast

- ▶ Press **◀/▶**.

Changing the playback position

- ▶ You can adjust the playback position using the knob.

Displaying the online radio menu

- ▶ Press **☰**.

Switching to radio

- ▶ Press **Source**. The sources in the Radio menu are displayed.

Podcast favorites

You can store podcasts in the **Podcast favorites**.

Requirement: the playback view for a podcast must be displayed.

- ▶ Press **☆** **(5)** ⇒ *page 181, fig. 136*.

Requirement: a list with podcasts must be displayed.

- ▶ Press and hold an entry in the list until the **Options** menu appears.
- ▶ Press **Save podcast**.

Listening to a podcast favorite

Requirement: the podcast favorites list must be displayed. At least one podcast favorite must be stored.

- ▶ Press on the desired podcast.

Scrolling through podcast favorites

Requirement: the podcast favorites list must be displayed. At least one podcast favorite must be stored.

- ▶ Swipe to the left or right with your finger.

Displaying all podcast favorites

Requirement: the podcast favorites list must be displayed. At least one podcast favorite must be stored.

- ▶ Press **All**.

Editing podcast favorites

- ▶ **Deleting podcast favorites:** press **★** in the playback view, or
- ▶ In the podcast favorites list, select: **All** > **✎** > *one or more podcasts*, or **Select All** > **Delete** > **(Done)**.

Requirement: the podcast favorites list must be displayed.

- ▶ **Moving a podcast favorite:** Select: **All** > **✎**.
- ▶ Touch the **◆** symbol and move the entry to the desired position.
- ▶ Press **Done**.

Options and settings

Options

Requirement: the playback view **(1)** ⇒ *page 181, fig. 136* must be displayed.

- ▶ Press **More** **(17)**, or

Requirement: a list with radio stations or podcasts* must be displayed ⇒ *page 180, fig. 134*.

- ▶ Press and hold an entry in the list until the **Options** menu appears.

Depending on the selected source, the following functions may be available.

Store as preset

See ⇒ *page 182*.

Radio text

See ⇒ *page 183*.

Scan

All channels in the current channel list will be played for several seconds each.

Scan Smart Favorites

All Smart Favorites will be played for several seconds. The stored song on the smart favorite ▶

Radio

channel will be played from the beginning
⇒ *page 183*. To switch to the previous or next Smart Favorite, press the On/Off knob briefly to the left or right.

Artist as SXM alert

The artist being currently played will be stored as a SiriusXM alert ⇒ *page 183*.

Title as SXM alert

The title being currently played will be stored as a SiriusXM alert ⇒ *page 183*.

Team 1 as game alert/Team 2 as game alert

The teams currently playing will be stored as a game alert ⇒ *page 183*.

Save podcast

See ⇒ *page 185, Podcast favorites*.

Save as a shortcut

See ⇒ *page 21, Shortcuts*.

Settings

► Applies to: MMI: Select on the home screen:
RADIO > .

Depending on the vehicle equipment, the following settings may be available:

HD Radio FM/HD Radio AM

You can switch HD Radio reception on or off.

SiriusXM Tune Start

If you play a Smart Favorite when this function is switched on, the song currently playing on the channel will play from the beginning.

Manage SiriusXM alerts

See ⇒ *page 184*.

SiriusXM channel sorting

You can set how the channels are sorted in the SiriusXM channel list:

– **Channel number**: the channels are sorted in ascending order according to their channel number.

- **Channel name**: the channels are listed in alphabetical order.
- **First category, then channel number**: the channels are sorted by their category and then by their channel number.
- **First category, then channel name**: the channels are sorted by their category and then by their channel names.

SiriusXM category filter

The stations shown in the station list can be filtered by your personal preferences and by program type. The program categories that you can select depend on what is offered by your provider. When the **Unsubscribed channels** function is switched off, unsubscribed channels will be hidden.

SiriusXM subscription status

This option is available when your subscription is about to expire or has already expired. The expiration date for your license is displayed.

Call SiriusXM: the telephone number and radio ID of your satellite radio provider are displayed. To call your satellite radio provider using the MMI, press **Call SiriusXM**.

Online additional data

Requirement: the MMI must be connected to the Internet ⇒ *page 157*.

When the function is switched on, additional information (such as station logos, cover, artist, track) will be loaded depending on the availability from the different providers.

Preferred online radio data rate

You can set the data rate for online radio
⇒ *page 184*.

For optimal sound playback, press **High**. To reduce data usage, press **Low**.

Note

Read the information about Audi connect, and be sure to note the connectivity costs section
⇒  in *General information on page 157*.

i Tips

Delays may occur when switching automatically between normal frequency bands and online radio.

Do It Yourself

The information that follows lists some troubleshooting options. They depend on the equipment.

Problem	Solution
A station is no longer displayed in the station list.	Store the station as a preset in advance. Access the presets using the presets list ⇒ <i>page 182</i> .
Online radio: no playback from online radio.	Check if a suitable data plan was purchased ⇒ <i>page 160</i> .

Media

General information

There may be different media sources and connections available depending on the vehicle equipment. For example, you can play media files using the SD card reader or connect your mobile devices to the Audi music interface and operate them through the MMI.

Media and format restrictions: the MMI (including the SD card reader and the USB storage device connection) was tested with a variety of products and media on the market. However, there may be cases where individual devices or media and audio/video files may not be recognized, may play only with restrictions, or may not play at all.

Restricted functionality: reset the **Media** to the factory default settings if functionality is restricted ⇒ *page 202*.

Digital Rights Management: please note that the audio/video files are subject to copyright protection.

Files that are protected by DRM and are identified with the symbol  will not play.

Data security: never store important data on SD cards, or mobile devices. Audi is not responsible for damaged or lost files and media.

Loading times: the more files/folders/playlists there are on a storage medium, the longer it will take to load. To reduce the amount of time it takes the audio/video files to load, use a storage medium that only contains audio/video files, and create subfolders (for example, for each artist or album).

Additional information: when playing, audio files are automatically displayed with any additional information that is stored (such as the artist, track and album cover). If this information is not available on the storage medium, the MMI will check the Gracenote metadata database. However, in some cases, the additional information may not be displayed.

Note

Read the information about Audi connect, and be sure to note the connectivity costs section ⇒  in *General information on page 157*.

SD card reader

The SD card reader is located in the glove compartment.

Inserting the SD card

- ▶ The angled corner of the SD card must face toward the right front side when being inserted.
- ▶ Slide the SD card into the card reader slot until the SD card clicks into place.

The SD card reader is accessed and operated through the MMI ⇒ *page 192*.

Note

- Only use one-piece SD cards. If adapter cards (SD cards with more than one piece) are used, the card could fall out of the adapter when driving because of vibrations. Individual pieces could then become stuck in the drive and impair the functionality.
- To reduce the risk of damaging drives and data carriers, always keep data carriers in a sleeve and never expose them to direct sunlight.

Bluetooth audio player

Applies to: vehicles with Bluetooth audio player

With the Bluetooth audio player, you can play music wirelessly through the MMI from your Bluetooth-capable mobile device (such as a cell phone).

Requirement: the vehicle must be stationary and the ignition must be switched on. The Bluetooth settings will open on your mobile device during the connection setup. The Bluetooth function and visibility of the MMI ⇒ *page 202* and mobile device must be switched on. ▶

Connecting a mobile device using the center display

- ▶ Applies to: MMI: Select on the home screen: **MEDIA > Source > Connect external device > New connection**. The available Bluetooth devices will be displayed after several seconds.
- ▶ Press on the desired mobile device in the list of displayed Bluetooth devices.
- ▶ To update the list, press ↻.
- ▶ A PIN for a secure Bluetooth connection will be generated.
- ▶ Confirm the PIN on your mobile device, or:
- ▶ Enter the PIN for the connection setup on your mobile device. The time allowed for entering the PIN is limited to approximately 30 seconds.

After connecting successfully, the mobile device will be displayed in the **Connected devices** menu as a Bluetooth audio player.

Playing media ⇒ *page 191*.

Tips

- Check for any connection requests on your Bluetooth device.
- Multiple Bluetooth audio players can be paired with the MMI, but only one at a time can be active as a Bluetooth audio player ⇒ *page 202*.
- The supported media functions (such as shuffle, list view, categories, search, options) depend on the Bluetooth device being used.
- Note the volume setting on your Bluetooth device. Audi recommends setting your mobile device to the maximum volume when using it as a Bluetooth audio player.
- A selection of supported Bluetooth devices can be found in the database for tested mobile devices at www.audi.com/bluetooth.

Online media

Applies to: vehicles with Audi connect Infotainment and online media

You can play and operate various online media services, such as music streaming services, using the MMI.

Requirement: a supported online media service must be available in the country where the vehicle is being operated.

Connect online media

- ▶ Connect the MMI to the Internet ⇒ *page 157*.
- ▶ Switch on the Wi-Fi hotspot in the MMI ⇒ *page 160*.
- ▶ Applies to: MMI: Select on the home screen: **MEDIA > Source > Connect online media**.
- ▶ Switch the Wi-Fi function on in your mobile device and connect it to the MMI Wi-Fi hotspot ⇒ *page 158*.
- ▶ Install and start the myAudi app on your mobile device.
- ▶ Log in to your myAudi account in the myAudi app and select your vehicle.

Your mobile device must be connected to the MMI and must be highlighted. When you press the highlighted device, it will be disconnected.

Starting online media

- ▶ Applies to: MMI: Select on the home screen: **MEDIA > Source**. All online media services supported in your country will be displayed.
- ▶ Press on the desired online media service and follow the system instructions.

WARNING

- To reduce the risk of an accident, only use Audi connect services and the Wi-Fi hotspot only if the traffic situation permits it. Read and follow the guidelines provided in ⇒ *page 18, Traffic safety information*.
- It is only safe to use tablets, laptops, mobile devices and other similar devices when the vehicle is stationary because, like all loose objects, they could be thrown around the inside of the vehicle in a crash and cause serious injuries. Store these types of devices securely while driving. Also read the warnings in the chapter ⇒ *page 63*.

Note

- Read the information about Audi connect, and be sure to note the connectivity costs

section ⇒  in *General information on page 157*.

- There generally are additional costs when using an online media service account, especially when it is used internationally.

Tips

- Depending on the Internet connection and network traffic, the connection may be disconnected when online media sources are playing.
- Online media usage depends on the service availability of the third party provider.
- Audi simply makes the access to online media services possible through the MMI and does not take any responsibility for the content of the online media services.
- Depending on the mobile device being used, there may be interruptions during media playback and when using the myAudi app. To avoid interruptions, do not lock the screen on your mobile device and keep the myAudi app in the foreground.

Amazon Alexa

Applies to: vehicles with Amazon Alexa Integration

You can play various Amazon Alexa content using the MMI. The voice recognition system is used to operate it.

Requirement: Amazon Alexa must be activated ⇒ *page 25*.

- ▶ Start Amazon Alexa using the voice recognition system.
- ▶ Applies to: MMI: Select on the home screen: **MEDIA > Source > Amazon Alexa**.

Note

Read the information about Audi connect, and be sure to note the connectivity costs section ⇒ *page 157*.

Multimedia connections

USB adapter cable

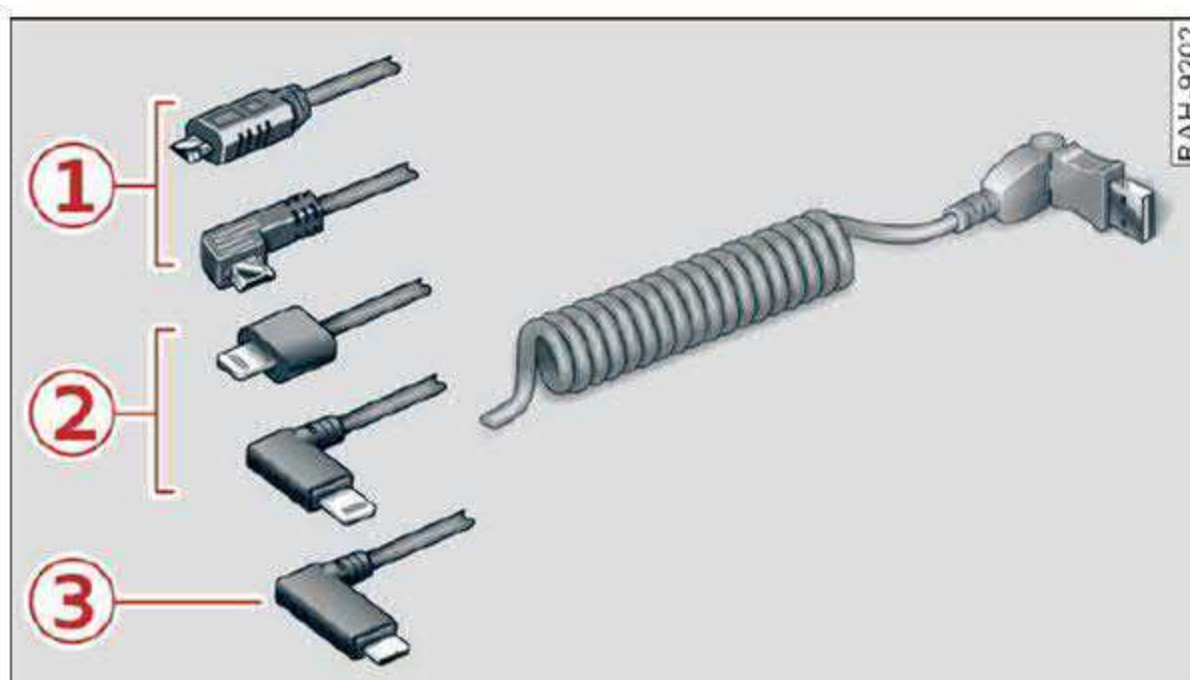

Fig. 137 Audi Genuine Accessories: USB adapter

You can connect your mobile devices through the Audi music interface to the MMI using the USB adapter and charge the battery at the same time.

You can purchase the USB adapter cable from an authorized Audi dealer or at specialty stores:

- ① USB adapter for devices with a micro USB connection
- ② USB adapter for Apple devices with a Lightning connection
- ③ USB adapter for devices with USB type C connection

Note

Handle the USB adapter carefully. Do not allow it to be pinched.

Tips

Apple devices with a dock connector can only be charged using a USB adapter designed for devices with a dock connector. Data cannot be transmitted.

Audi music interface

Applies to: vehicles with Audi music interface

Connect your mobile devices to the Audi music interface in order to operate them through the MMI and charge the batteries.

The Audi music interface USB ports are located in the center console in the front and in the rear* and are labeled with the  symbol. If multiple USB devices are connected to the USB ports (for example, a smartphone and a USB flash drive), ▶

all of these devices can be used as the playback source.

Connecting or charging mobile devices using a USB adapter

- ▶ Connect the matching USB adapter to the Audi music interface USB port and connect it to the mobile device, such as a smartphone.

The battery will charge automatically.

Mobile devices connected to the Audi music interface can be started and operated using the MMI ⇒ *page 192*.

Disconnecting a mobile device from the Audi music interface

- ▶ Remove the USB adapter cable from the Audi music interface.

WARNING

Driving requires your complete and undivided attention. As the driver, you have complete responsibility for safety in traffic. Never operate mobile devices while driving, because this increases the risk of an accident.

Note

- Pull the cable out of the Audi music interface carefully so that the USB ports are not damaged.
- Use a USB extension cable to connect devices that have an integrated USB connector (such as a USB stick) to reduce the risk of damage to your USB device and the Audi music interface.
- Extremely high or low temperatures that can occur inside vehicles can damage mobile devices and/or impair their performance. Never leave mobile devices in the vehicle in extremely high or low temperatures.

Tips

- Always follow the information found in ⇒ *page 74*.
- When you switch the ignition off, the USB ports are still supplied with power until the energy management intervenes.

- Do not use an additional adapter cable or USB extension cable to connect mobile devices to the Audi music interface that already have a cable or that must be connected with a USB adapter cable (⇒ *page 190, fig. 137*). Using an additional adapter or US extension cable may impair functionality.
- Functionality is not guaranteed for mobile devices that do not conform to the USB 2.0 specification.
- USB hubs are not supported.
- Video playback through the Audi music interface is not supported on Apple devices and MTP devices (such as smartphones).
- iPod or iPhone malfunctions also affect the operation of the MMI. Reset your mobile device in these situations.
- Audi recommends updating the iPod or iPhone software to the latest version. Refer to your mobile device owner's manual for more information.
- The USB adapter on the Audi music interface will support iPod touch or iPhone devices from the 5th generation or newer with the lightning connector.
- A selection of supported devices can be found in the database for tested mobile devices at www.audi.com/mp3.

Playing media

Media sources

The following sources can be selected depending on the vehicle equipment:

- **Amazon Alexa** ⇒ *page 190*.
- **SD card** ⇒ *page 188*.
- **USB** ⇒ *page 190*.
- **Connect external device:** you can connect external devices via Bluetooth and use the Bluetooth audio player ⇒ *page 188*, or you can connect an external device directly to the Audi music interface ⇒ *page 190*.
- **Connect online media** ⇒ *page 189*.



Accessing media

Playing media files using the center display

- ▶ Applies to: MMI: Select on the home screen: **MEDIA > Source > a source**. Depending on the connected device or online media service*, the symbol for a source may change. The device name may be displayed (for example: my-Phone).
- ▶ Select a track from the categories in the media center ⇒ *page 192*.

Playing media files using the multifunction steering wheel

Requirement: a media drive must contain media files ⇒ *page 191*.

- ▶ Select the Radio/Media tab using the multifunction steering wheel.
- ▶ Turn the left thumbwheel to display the playlist.
- ▶ To switch to a different source, press the  button.
- ▶ To select a media file or a source, turn and press the left thumbwheel.
- ▶ To switch between radio and media, select the  button > **Switch to radio/Switch to media**.

Tips

- For safety reasons, the video image is only displayed when the vehicle is stationary. Only the sound from the video plays while driving.
- Applies to: multifunction steering wheel: Depending on the selected function, operation through the center display may be required.

Media center



Fig. 138 Center display: media center

Various categories are available in the media center for selecting media files or browsing through media sources.

You can browse through your music collection using the categories in the media center, such as albums. You can browse through the active source or any available source (for example, an SD card). While browsing through the media center, the music from the active source will continue to play.

Opening the media center using the center display

- ▶ Applies to: MMI: Searching any source: select on the home screen: **MEDIA > Source > a source > a category**.
- ▶ Searching through the active source: select in the playback view ⇒ *page 194*:  > *a category*.

Opening the media center using the multifunction steering wheel

Requirement: a media drive must contain media files ⇒ *page 191*.

- ▶ Select the Radio/Media tab using the multifunction steering wheel.
- ▶ Turn the left thumbwheel to display the playlist.
- ▶ To switch to a different source, press the  button.
- ▶ To select a media file or a source, turn and press the left thumbwheel.
- ▶ Select and confirm a category.

① Source symbol

The system will display the symbol for the source that is currently being searched. Depending on the connected device or online media service*, the symbol for a source may change. As an example, a USB stick is shown connected to the Audi music interface.

② Source device name

The system will display the device name of the source that is currently being searched.

③ Categories

The media center will display categories depending on the connected device, the selected source ▶

content, and the connection type. The search is limited to the active source.

Search

If a source supports the search, then the category is displayed ⇒ *page 195*.

Last played tracks

The last played media file will be played.

Artists

All available artists are displayed.

▶ Select: *an artist > an album > a song*.

Playlists

All playlists and smart playlists in the source are displayed.

▶ Select: *a playlist > a song*.

Smart playlists

Last played tracks: the tracks that were displayed last are displayed.

Most played tracks: the tracks that are played most frequently are displayed.

Folders

The folder structure or track/chapter list is displayed.

▶ Select: *a folder > a song*.

Compilations

You can control your playlists through the MMI.

▶ Select: *a playlist > a song*.

Composers

All available composers are displayed.

▶ Select: *a composer > an album > a song*.

iTunes Radio

▶ Press on a radio station.

Audio books

You can control your audio books on the MMI.

▶ Press on an audio book.

Podcasts

You can control your podcasts through the MMI.

▶ Select: *a podcast > a podcast episode*.

Genres

All available genres are displayed.

▶ Select: *a genre > an artist > an album > a song*.

Videos

All available video files are displayed.

▶ Press on a video.

Tracks

All available tracks are displayed.

▶ Press on a track.

Albums

All available albums are displayed.

▶ Select: *an album > a track*.

Note

Applies to: vehicles with Audi connect Infotainment

- Cloud services and the iTunes radio category always require an Internet connection.
- Read the information about Audi connect, and be sure to note the connectivity costs section ⇒  in *General information on page 157*.

Tips

- Only the categories supported by the medium are available.
- For safety reasons, the video image is only displayed when the vehicle is stationary. Only the sound from the video plays while driving.
- When synchronizing a portable device with Cloud services, playlists may display incorrectly in the MMI. Use the media center in the device.
- Applies to: iPod/iPhone: Note the information about the Audi music interface and the supported devices ⇒ *page 190*.

Media functions

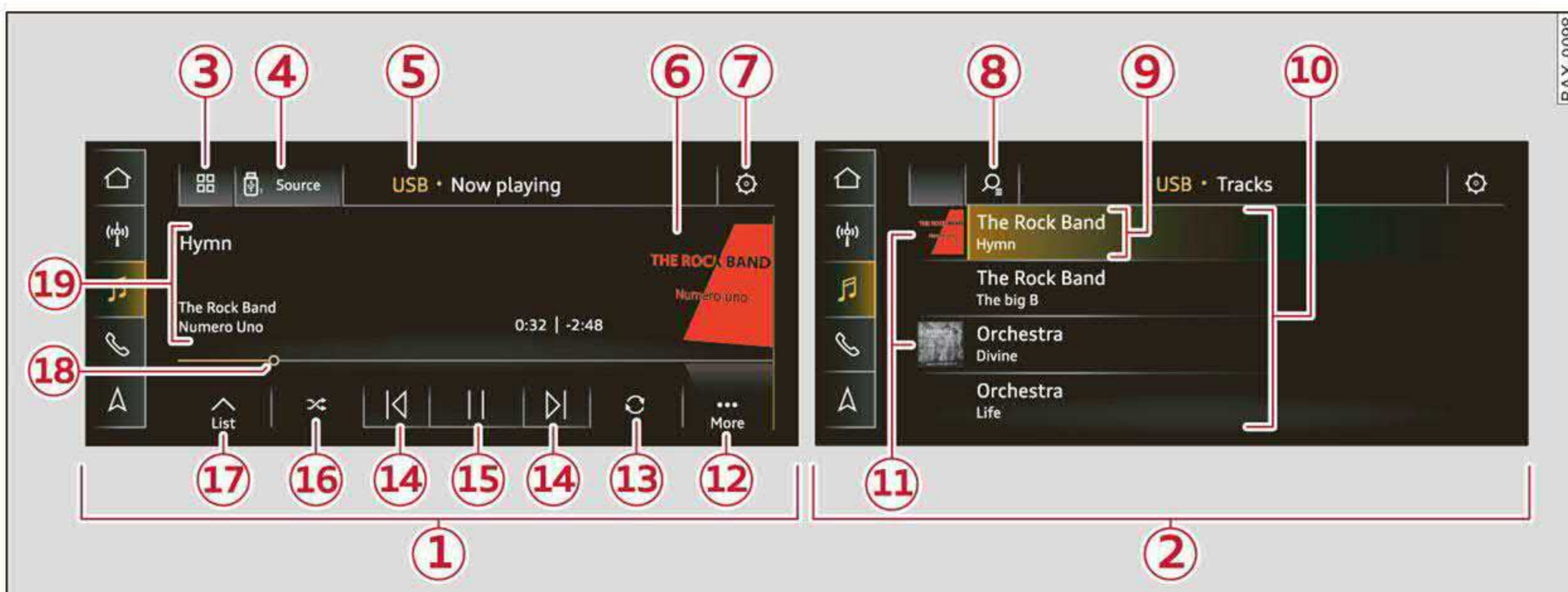

Fig. 139 Center display: left side: playback view; right side: playlist

Operating

► Applies to: MMI: To open the playback view (1), select on the home screen: **MEDIA** > **Source** > *select a source* > *select a category* (for example, *artists* > *Album*) > *select a track*.

► To open the playlist (2), select **List** in the playback view (17).

The following functions may be available depending on the selected media source and the vehicle equipment:

	Symbol/Description	Description
(3)		The media center categories are displayed based on the active source ⇒ <i>page 192</i> .
(4)	Source	Displays sources in the Media menu.
(5)	Source/device name	Applies to: playback view: Device name of the source that is currently playing. Applies to: media center view: Source that you are currently browsing ⇒ <i>page 192</i> .
(6)	Album cover in the playback view	Requirement: a media source with album covers must be selected or the covers must be available online ⇒ <i>page 196</i> , Online additional data . Displays the current album cover. Display the playlist: press on the cover.
(7)		Settings ⇒ <i>page 196</i> .
(8)		Filtering the current list.
(9)	Current track information	Display of Track and Artist . Highlights the track that is currently playing.
(10)	List	Browsing in the list: drag your finger upward or downward.
(11)	Album cover in the playlist	Requirement: a media source with album covers must be selected or the covers must be available online ⇒ <i>page 196</i> , Online additional data . Displays the current album cover. For tracks belonging to one album, the album cover is displayed one time.
(12)	More	Opens options ⇒ <i>page 195</i> .

	Symbol/Description	Description
13	Off	Switching between off/playlist/track: press 13.
	Playlist	The tracks in the current playlist will repeat continuously in a loop.
	Track	The current track will repeat continuously in a loop.
14	K/D	Selecting the previous/next track (or station/chapter): press K or D. Jumping to the beginning of a track: press on K after the first ten seconds of play time.
15	D/II	Start or stop playback
16	D	When this function is switched on, all files in the playlist will play in random order.
17	List	The playlist 2 is displayed.
18	Playback position	You can adjust the playback position using the knob.
19	Info section	Display of Track , Artist , and Album .

Tips

Not all functions are available in every source and on every touch display.

Free text search

Applies to: vehicles with free text search

You can search in all active sources, for example for tracks and video files.

Opening the search

Requirement: the selected source must support the search function. The media center is displayed ⇒ *page 192*.

► Press **Search**.

Entries that contain the entered search term are listed in the results list. Each result is marked with the symbol for a category in the media center ⇒ *page 192*.

You can search for the following categories:

- Artists
- Albums
- Tracks
- Genres
- Videos

Tips

Only files in the active source will be searched.

Options and settings

Options

Context-dependent functions and settings may be available depending on the selected source, the connected mobile device, and the connection type.

Requirement: the playback view must be displayed 1 ⇒ *page 194, fig. 139*.

► Press **More** 12, or

Requirement: a list (for example, a playlist 2 ⇒ *page 194, fig. 139*) must be displayed.

► Press and hold an element until the **Options** menu is displayed.

Play more like this

The track currently playing is quickly analyzed for features such as artist, genres, mood, and beat, and a smart playlist with similar tracks will be shown.

More from this album

Based on the track that is currently playing, an intelligent playlist with other tracks from this album will be displayed. ►

More from this artist

Based on the track that is currently playing, an intelligent playlist with other tracks from this artist will be displayed. The system will search for artists in the source that is currently playing.

More from this genre

Based on the track that is currently playing, an intelligent playlist with other tracks from this genre will be displayed.

Save as a shortcut

See ⇒ *page 21, Shortcuts*.

Play

The selected track or all tracks in the folder will be displayed.

Aspect ratio

Audi recommends the **Auto** setting for the picture format. If you press on an aspect ratio, you will see a preview of the setting on the screen. Press **OK** to apply the selected aspect ratio.

The following table gives an overview of the aspect ratios. The possible aspect ratios depend on the source or video file being played.

Aspect ratio	Description
Auto	The MMI detects the picture format of the source and displays the image in the optimal ratio.
4:3, 16:9	The image is fixed in the corresponding ratio. Select one of these options if the image is distorted or a section of the image is cut off or blurry when Auto is selected.

Aspect ratio	Description
Zoom	The image is enlarged to fill the entire display.
Original	The image is displayed in the ratio of the source format. Select this option if the image is distorted or a section of the image is cut off or blurry when Auto is selected.

Settings

- Applies to: MMI: Select on the home screen: **MEDIA** > ⚙️.

Depending on the vehicle equipment, the following settings may be available:

Online additional data

Requirement: the MMI must be connected to the Internet ⇒ *page 157*.

If available, various information about the track currently playing (such as the cover) will be loaded from the Internet when this function is switched on.

Supported media and file formats

Overview

The SD card reader and the USB storage device connection support the following media file properties:

	Audio files						Video files		
Supported media	SD/SDHC/SDXC/MMC memory cards: with a capacity up to 256 GB; Audi music interface: mobile devices ⇒ <i>page 190</i> (for example, iPhone, MTP player, USB storage devices in “USB Device Subclass 1 and 6” that conform to USB 2.0: USB sticks, USB MP3 player (Plug-and-Play-capable), external USB flash drive and hard drives).								
File system	Memory cards: exFAT, FAT, FAT32, NTFS. USB storage devices: FAT, FAT32, NTFS USB mass storage device partitions (primary/logical*): two per USB connection								
Metadata	Album cover: GIF, JPG, PNG with max. 800x800 px. The album cover from the medium or from Grace-note* is displayed, depending on availability.								
Format	MPEG 1/2 Layer 3	Windows Media Audio 9 and 10	MPEG 2/4	Opus	FLAC	ALAC	MPEG 1/2	MPEG4 AVC (H.264)	Windows Media Video 9
File extension	.mp3	.wma	.m4a; .m4b; .aac	.opus; .ogg; .oga	.flac	.m4a	.mpg; .mpeg	.mp4; .m4v; .mov; .avi	.wmv; .asf
Playlists	.M3U; .PLS; .WPL; .M3U8; .ASX								
Characteristics	up to maximum 320 kbit/s and 48 kHz sampling frequencies			48 kHz sampling frequency		up to maximum 10 Mbit/s and 1920x1080 px at maximum 30 fps			
Number of files	USB mass storage device and memory cards: max. 50,000 files per medium; max. 1,000 files per playlist/folder								

Tips

- The media sources do not support the Windows Media Audio 9 Voice format.
- For compressing MP3 files, Audi recommends a bit rate of at least 160 kbit/s. The display showing the remaining play time may differ for audio files with variable bit rate.
- Special characters (such as those in ID3 tag information) may display differently or may

not always display, depending on the system language.

- The manufacturer of the storage device can provide information about its “USB Device Subclass”.
- Some MTP player functions are not supported, such as rating music tracks and video playback.

Do It Yourself

The information that follows lists some troubleshooting options. They depend on the equipment. ►

Problem	Solution
Audi music interface/Bluetooth audio player: the mobile device is not supported.	Read the instructions in the chapter ⇒ <i>page 190, Multimedia connections/</i> ⇒ <i>page 188, Bluetooth audio player.</i>
Audi music interface: the mobile device is not recognized as a source.	For many mobile phones or mobile devices, playback is not possible when the battery level is too low (less than 5% charge level). The mobile device will only be recognized as a media source in the MMI after connecting if the battery charge level is sufficient.
Audi music interface: malfunctions during audio playback through an iPod/iPhone.	The Bluetooth audio player function is switched on. Switch this function off ⇒ <i>page 202</i> when you are not using the Bluetooth audio player .
Audi music interface: audio playback through the connected mobile device is not possible.	Make sure the USB mode <i>MTP</i> is selected in the settings on your mobile device.
Bluetooth audio player: interference with track display and audio playback.	Playback interference can occur when using the Bluetooth audio player if a music player app from a third party provider is open. Audi recommends using the integrated media player on your Bluetooth device (such as a smartphone).
Online media: connection failed between the MMI and the myAudi app.	To establish a connection to the MMI, the MMI connection switch must be switched on in the myAudi app status screen.
Online media: no playback of online media.	Check if a suitable data plan has been purchased.
Wi-Fi hotspot: your Wi-Fi device is disconnected from the Wi-Fi hotspot.	Make sure the network optimization functions are switched off in the Wi-Fi settings or in the network settings for your Wi-Fi device. For additional information, refer to the user guide for your Wi-Fi device.

Audi smartphone interface

Setup

Applies to: vehicles with Audi smartphone interface

You can connect your smartphone to the MMI with a cable or wirelessly* using the Audi smartphone interface. Certain content on your smartphone is adapted in the MMI while driving and can be operated through the MMI.

Requirement: the vehicle must be stationary and the ignition must be switched on. iPhone generation 5 or higher with Lightning connector and iOS 7.1.2 operating system or higher, or smartphone with Android Auto app and Android 5.0 Lollipop operating system or higher.

- ▶ Applies to: MMI: Select on the home screen: **SETTINGS > Connected devices > Audi smartphone interface > New connection.**
- ▶ Connect your smartphone to the Audi music interface ⇒ *page 190* using a USB adapter ⇒ *page 190, fig. 137*, or
- ▶ To connect your iPhone wireless*, switch on the Bluetooth function and Wi-Fi on your iPhone. Open the Apple CarPlay settings in your iPhone. In the MMI, press on your iPhone in the list of displayed devices.
- ▶ To update the list, press ↻.
- ▶ Follow the system instructions.
- ▶ Pay attention to any additional system prompts on your smartphone, if applicable.
- ▶ Applies to: MMI: If you declined use of Apple CarPlay or Android Auto the first time you connected your smartphone, then select on the home screen: **SETTINGS > Connected devices > Audi smartphone interface > a smartphone.**
- ▶ Follow the system instructions.

WARNING

Driving requires your complete and undivided attention. As the driver, you have complete responsibility for safety in traffic. Never operate mobile devices while driving, because this increases the risk of an accident.

Note

Read the information about Audi connect, and be sure to note the connectivity costs section ⇒ *page 157*.

Tips

- The functions that can be used depend on the following factors, among others:
 - The brand of your smartphone
 - The version of the operating system in your smartphone
 - The software version of the app used
 - The USB adapter cable and correct connection
 - Your cell phone service provider
 - The customized settings on your smartphone
- One of the factors above or a combination of any of them could cause your smartphone to be incompatible with the Audi smartphone interface. Compatibility cannot be guaranteed for all types of smartphones. For more information and assistance, refer to the user guide and the manufacturer of your smartphone.
- Please note that you can only connect your smartphone via the front Audi music interface in order to use the Audi smartphone interface.
- Wireless Apple CarPlay* is not available in all countries.
- Wireless Apple CarPlay* is only possible in vehicles without a navigation system if the following requirement is met: the embedded SIM card for the vehicle must be logged into the mobile phone network ⇒ *page 157*. Make sure the function ⇒ *page 154*, **Turn on car phone or data module** is switched on.
- If the connected smartphone has voice control, you can operate your smartphone using the external voice recognition system ⇒ *page 25*.
- The menu language shown in the MMI is based on the settings in your smartphone.
- Some MMI functions are not available when there is an active Audi smartphone interface connection.

Audi smartphone interface

- You cannot connect any mobile devices via Bluetooth when an Audi smartphone interface connection is active.
- Usage of the Audi smartphone interface depends on the availability of services through third party providers.

- Audi merely provides access to third party services through the MMI and does not assume any responsibility for the content of these services.

Do It Yourself

Applies to: vehicles with Audi smartphone interface

The information that follows lists some troubleshooting options. They depend on the equipment.

Problem	Solution
Audi smartphone interface cannot be opened.	Check the battery charge level on your smartphone. Check the USB cable and use a different one if necessary. Check if Android Auto or Apple CarPlay is available in the country where the vehicle is being operated.
	Android Auto: check if the Android Auto app is installed on your smartphone.
Connecting the smartphone to the MMI failed.	Make sure that you are using the correct USB adapter and check if the USB adapter is connected correctly to your smartphone and the Audi music interface ⇒ <i>page 190</i> .
	Apple CarPlay: check if Apple CarPlay is activated on your iPhone.
	Android Auto: check in the Android Auto app if Android Auto permits new vehicles.
	Wireless connection: open the settings for Bluetooth and Apple CarPlay on your iPhone. Remove your vehicle. Open the connection manager in the MMI ⇒ <i>page 202</i> . Delete your iPhone in the Telephone 1 and Audi smartphone interface submenus. Repeat the connection process. Restart the MMI ⇒ <i>page 18</i> . Restart your iPhone.
The smartphone is not automatically detected.	Make sure that you are using the correct USB adapter and check if the USB adapter is connected correctly to your smartphone and the Audi music interface ⇒ <i>page 190</i> .
	Check if the requirements needed to connect a smartphone have been met.

Additional settings

System settings

Introduction

General settings are described in this chapter. You can find specific settings in the chapters about those settings. The available settings depend on the vehicle equipment.

Date and time

► Applies to: MMI: Select on the home screen: **SETTINGS > General > Date & time.**

Possible settings:

- Automatically set date and time
- Date
- Time
- Date format
- Use 24h time format
- Automatic time zone
- Time zone
- Automatic daylight saving time
- Manual daylight saving time

Measurement units

► Applies to: MMI: Select on the home screen: **SETTINGS > General > Measurement units.**

Possible settings:

- Speed
- Distance
- Temperature
- Pressure
- Consumption (engine)
- Volume

Language and keyboard

► Applies to MMI: Select on the home screen: **SETTINGS > Language & keyboard.**

Language

You can change the languages for the display, navigation announcements, and the voice recognition system.

Keyboard

See ⇒ page 22.

Sound

Requirement: an audio source must be active.

► Applies to MMI: Select on the home screen: **SETTINGS > Sound.**

Possible settings:

- Treble
- Bass
- Balance/fader
- Speed-dependent volume control
- Subwoofer
- Surround Level

Focus

You can optimize the sound distribution for various locations in the vehicle.

3D effect

You can adjust the intensity of the 3D effect. With the **Medium** setting, you will hear an optimal 3D effect for all sources.

Announcements and tones

► Applies to: MMI: Select on the home screen: **SETTINGS > Announcements & tone.**

Possible settings:

- Announcement volume
- Welcome sound



WARNING

Adjust the volume of the audio system so that signals from outside the vehicle, such as police and fire sirens, can be heard easily at all times.



Tips

The volume is automatically adjusted to a pre-set level when the MMI is switched on.

Bluetooth

Applies to: vehicles with Bluetooth

- ▶ Applies to MMI: Select on the home screen:
SETTINGS > Connection settings > Bluetooth

Bluetooth

You can select a setting for visibility of the MMI to other Bluetooth devices. To connect a new Bluetooth device, the **Visible** setting must be selected. If **Invisible** is selected, a Bluetooth connection will only be possible with paired devices. If **Off** is selected, no Bluetooth device can be connected.

Bluetooth audio player

When this function is switched on, the profile will load automatically when your Bluetooth audio player is within range.

Bluetooth name

The MMI's Bluetooth name is displayed and can be changed.

Software update

- ▶ Applies to: MMI: Select on the home screen:
SETTINGS > System maintenance > Software update.
- ▶ If necessary, insert a storage medium with the update data into the corresponding drive
⇒ *page 196.*
- ▶ Press **Search for updates.**
- ▶ Press on the desired update.
- ▶ Press **Next.**
- ▶ Follow the system instructions.

WARNING

- Perform the installation only when the vehicle is stationary. Otherwise, this increases the risk of an accident
- If the installation fails, contact an authorized Audi dealer or authorized Audi Service Facility immediately to have the malfunction corrected.

Note

The connection costs for the software update are included in the Audi connect pricing.

Tips

The length of the process depends on the size of the update.

Factory default settings

Restore factory settings

- ▶ Applies to MMI: Select on the home screen:
SETTINGS > System maintenance > Restore factory settings.
- ▶ Select the desired functions individually, or
- ▶ Select the option **Select all.**
- ▶ Press **Apply.** The settings will be reset.
- ▶ To completely delete a smartphone that is paired with the Audi smartphone interface, reset **Audi smartphone interface** and **Bluetooth.**

Tips

- Make sure that not only the settings were deleted but also the stored data, if necessary.
- The system may restart when the settings are reset. This may take a few minutes.

Connected devices

Connection manager

Requirement: the vehicle must be stationary and the ignition must be switched on.

- ▶ Applies to: MMI: Select on the home screen:
SETTINGS > Connected devices.

Possible menu items:

- **Telephone 1**
- **Telephone 2**
- **Audio player**
- **Wi-Fi hotspot**
- **Headset**

myAudi app

This function is available if the myAudi app is installed on your mobile device and started, and if ▶

the mobile device is connected with the vehicle's Wi-Fi hotspot.

Audi smartphone interface

You can connect your smartphone to the MMI ⇒ *page 199*.

Note

Read the information about Audi connect, and be sure to note the connectivity costs section ⇒ *page 157*.

Connection options

Requirement: the connected devices menu must be displayed ⇒ *page 202*.

Connecting a device

Requirement: Bluetooth visibility must be activated in the MMI ⇒ *page 202* and mobile device.

- ▶ Press on a menu item, such as **Telephone 1**.
- ▶ To search for and connect your mobile device, press **New connection** ⇒ *page 143*.

Selecting a connected device

- ▶ Press on a menu item, such as **Telephone 1**.
- ▶ Press on the desired mobile device in the list of displayed devices. The connection will be made.

Disconnecting a connected device

- ▶ Press on a menu item, such as **Telephone 1**.
- ▶ Press on the connected mobile device. The selected mobile device will be disconnected from the MMI.

Deleting a device

- ▶ Press on a menu item, such as **Telephone 1**.
- ▶ Press and hold an element until the **Options** menu is displayed.
- ▶ Press **Delete**.

If a device is listed multiple times, it will be deleted from all menu items.

Additional options

Depending on the selected function, additional options may be available.

Requirement: the connected devices menu must be displayed ⇒ *page 202*.

- ▶ Press on a menu item, such as **Telephone 1**.
- ▶ Press and hold an element until the **Options** menu is displayed.

Bluetooth profiles

You can switch desired profiles on or off separately in the MMI.

Favorite

To set a paired mobile device as the default phone, activate this function in the MMI.

When the mobile device is in range and the Bluetooth function on the mobile device and in the MMI is switched on, the default phone will be given priority over the other Bluetooth devices and will be connected directly to the MMI.

Legal information

General information

Information on the software licenses can be found online at www.audi.com/softwareinfo.

Multi Media Interface

Accessing information in the MMI

– Applies to: MMI: Select on the home screen: **SETTINGS > General**.

Subscriptions

Version information

Legal notes

Possible options:

- **Software information**
- **About Audi connect**

Audi smartphone interface

Applies to: vehicles with Audi smartphone interface

Requirement: a smartphone must be connected to the MMI ⇒ *page 199*.

- ▶ Applies to: MMI: Select on the home screen: **SETTINGS > Connected devices > Audi smartphone interface**.

Additional settings

- ▶ Press and hold an element until the **Options** menu is displayed.
- ▶ Press **Legal notes**.

Instrument cluster

Requirement: the vehicle must be stationary and the ignition must be switched on.

- ▶ Select in the instrument cluster: vehicle functions tab ⇒ *page 12*.
- ▶ Press and hold the  button on the multifunction steering wheel until the display appears.

Possible options:

- **Engine code**
- **Software information**
- **Version information**

Additional information

Brands and licenses

This manual does not contain any symbols, such as ® or ™, to identify trademarks or registered trademarks. However, the absence of these symbols does not constitute a waiver of any rights associated with these names.

Apple, iPhone, iPod touch, Apple CarPlay, AirPlay, Lightning, and iTunes Radio are trademarks of Apple Inc.

IOS is a trademark or, in the USA and other countries, a registered trademark of Cisco and is used under license.

Other product and manufacturer names may be trademarks of their respective owners.

Checking and Filling

Fuel

Types of gasoline

The correct gasoline grade is stated on the inside of the fuel filler door.

The vehicle is equipped with a catalytic converter and must only be driven with **unleaded gasoline**.

Audi recommends using TOP TIER Detergent Gasoline. For additional information on TOP TIER Detergent Gasoline, visit www.toptiergas.com.

The individual gasoline grades are differentiated by **octane ratings**. This value is given with (R+M)/2 equating to AKI or in RON.

The headings below match the sticker in the fuel filler door (examples):

UNLEADED FUEL ONLY MIN. (R+M)/2 87 Regular / MIN. RON 91 Regular

Use regular gasoline with minimum 87 AKI / 91 RON ⇒ ⚠.

Audi recommends using premium gasoline with minimum 91 AKI / 95 RON to achieve the rated horsepower and torque.

UNLEADED FUEL ONLY PREMIUM MIN. (R+M)/2 91 / SUPER MIN. RON 95

Using premium gasoline with minimum 91 AKI / 95 RON is recommended.

If premium gasoline is not available, you can also use regular gasoline 87 AKI / 91 RON. However this does reduce the engine power slightly.

UNLEADED FUEL ONLY PREMIUM MIN. (R+M)/2 93 / SUPER PLUS MIN. RON 98

Using premium plus gasoline with at least 93 AKI / 98 RON is recommended.

If no premium plus gasoline is available, you can also use premium gasoline with 91 AKI / 95 RON. However this does reduce the engine power slightly.

⚠ Note

- Filling the tank just one time with leaded fuel or other metallic additives will cause permanent deterioration to the catalytic converter function.
- When gasoline with an octane rating that is too low is used, high speeds or heavy engine load can lead to engine damage.

ℹ Tips

The vehicle may be filled with fuel that has a higher octane rating than what is required by the engine.

Gasoline mixture

Gasoline with alcohol or MTBE (Methyl-Tert-Butyl-Ether)

You can use unleaded gasoline mixed with alcohol or MTBE (generally labeled as oxygenated compounds) as long as the fuel meets the following conditions:

Gasoline with methanol content (methyl alcohol or methanol)

- Anti-Knock Index is at least 87 AKI
- No more than 3% methanol
- More than 2% solvent

Gasoline with ethanol content (ethyl alcohol or ethanol)

- Anti-Knock Index is at least 87 AKI
- No more than 15% ethanol

Gasoline with MTBE content

- Anti-Knock Index is at least 87 AKI
- No more than 15% MTBE

Gasoline adapted to the season

Many gasoline fuels are adapted to the seasons. When the season changes, refueling at high-traffic gas stations is recommended. It is more likely that the gasoline will be suitable for the season there.

⚠ Note

- Gasoline with methanol content that does not meet the specified conditions may cause

corrosion damage and damage to plastic or rubber components in the fuel system.

- Do not use gasoline that does not meet the specifications.
- If you are unable to find out if a specific gasoline mixture meets the specifications, ask the gas station operator or their fuel supplier.
- Do not use any gasoline mixture whose composition cannot be identified.
- Audi does not assume any responsibility for damage to the fuel system or for performance problems caused by using gasoline mixtures different from those specified. This type of damage also does not fall under the New Vehicle Limited Warranty or under the emissions control system warranty.
- If you notice a higher fuel consumption or poor handling or performance problems due to such gasoline mixtures, Audi recommends fueling with unblended gasoline.

Gasoline additives

An important issue for many automobile manufacturers is combustion residue in the engine that results from the use of certain fuels.

Although types of gasoline differ depending on the manufacturer, there are similarities. Certain substances in the gasoline may cause deposits in the engine. Additives in the gasoline that should keep the engine and fuel system clean do not all function equally.

Audi recommends using TOP TIER Detergent Gasoline. For additional information on TOP TIER Detergent Gasoline, visit www.toptiergas.com.

If you use incorrect fuels over a long period of time, the maximum engine performance may be impaired by combustion residue.

! Note

- Damage or malfunctions caused by the use of incorrect types of gasoline are not covered by the New Vehicle Limited Warranty.
- Only gasoline additives that have been approved by Audi may be used.

Refueling

Fueling procedure



Fig. 140 Right rear side of the vehicle: opening the fuel filler door



Fig. 141 Fuel filler door with attached fuel cap

The fuel filler door is unlocked or locked by the central locking system.

- ▶ Unlock the vehicle if necessary.
- ▶ Press on the left side of the fuel filler door to open it ⇒ *fig. 140*.
- ▶ Unscrew the tank cap counterclockwise.
- ▶ Place the cap from above on the open fuel filler door ⇒ *fig. 141*.
- ▶ Insert the fuel pump nozzle all the way into the fuel filler neck.
- ▶ Begin fueling. Once the fuel pump nozzle turns off the first time, the fuel tank is full. Do not continue fueling, or else the expansion space in the tank will be filled with fuel.
- ▶ After the fuel pump has switched off, wait five seconds before removing the nozzle to allow the rest of the fuel to finish dripping into the fuel tank.
- ▶ Turn the fuel cap clockwise until it clicks into place.
- ▶ Close the fuel filler door and then press on the left side until it latches.

Checking and Filling

The correct fuel type for your vehicle can be found on a label located on the inside of the fuel filler door. For additional information on fuel, see ⇒ *page 206*.

For the tank capacity in your vehicle, refer to the Technical Data ⇒ *page 269*.

To reduce the risk of fuel leaking out or vapors escaping, make sure that the fuel tank is closed correctly. Otherwise the ¹⁾ indicator light will turn on.

Messages

Tank system: malfunction! Please contact Service

There is a malfunction in the fuel tank system. Drive to an authorized Audi dealer or authorized Audi Service Facility immediately to have the malfunction corrected.

WARNING

Improper fueling procedures and improper handling of fuel can lead to explosions, fires, severe burns, and other injuries.

- Do not smoke. Keep away from open flames.
- The ignition must be switched off when refueling.
- Mobile devices, radio devices, and other radio equipment should always be switched off when refueling. Electromagnetic rays could cause sparks and start a fire.
- If you do not insert the fuel pump nozzle all the way into the filler tube, then fuel can leak out. Spilled fuel can ignite and start a fire.
- Never get into the vehicle when refueling. If there is an exceptional situation where you must enter the vehicle, close the door and touch a metal surface before touching the fuel pump nozzle again. This will reduce the risk of electrostatic discharge that can cause flying sparks. Sparks can start a fire when refueling.

WARNING

Audi does not recommend transporting fuel containers inside the vehicle. Fuel could leak out of the container and ignite, especially during an accident. This can cause explosions, fires, and injuries.

- If you must transport fuel in a fuel container, note the following:
 - Always place the fuel container on the ground before filling. Never fill the fuel container with fuel while it is inside or on the vehicle. Electrostatic discharge can occur while refueling and the fuel vapors could ignite.
 - When using fuel containers made of metal, the fuel pump nozzle must always remain in contact with the container to reduce the risk of static charge.
 - Insert the fuel pump nozzle as far as possible into the filler opening while refueling.
 - Follow the applicable legal regulations in the country where you are driving when using, storing and transporting fuel containers.
 - Make sure that the fuel container meets the industry standards, for example ANSI or ASTM F852-86.

Note

- Remove fuel that has overflowed onto any vehicle components immediately to reduce the risk of damage to the vehicle.
- Never drive until the fuel tank is completely empty. The irregular supply of fuel that results from that can cause engine misfires. Uncombusted fuel may enter the exhaust system and increase the risk of damage to the catalytic converter.

For the sake of the environment

- Do not overfill the fuel tank, or fuel could leak out when the vehicle is warming up.
- Fuel should never enter the sewer system or come into contact with the ground.

¹⁾ Depending on the engine and country

i Tips

The fuel filler door on your vehicle does not lock if you lock the vehicle from the inside using the central locking switch.

Fuel filler door emergency release

Applies to: vehicles with manual fuel filler door release

If the central locking system malfunctions, the fuel filler door can be unlocked manually.

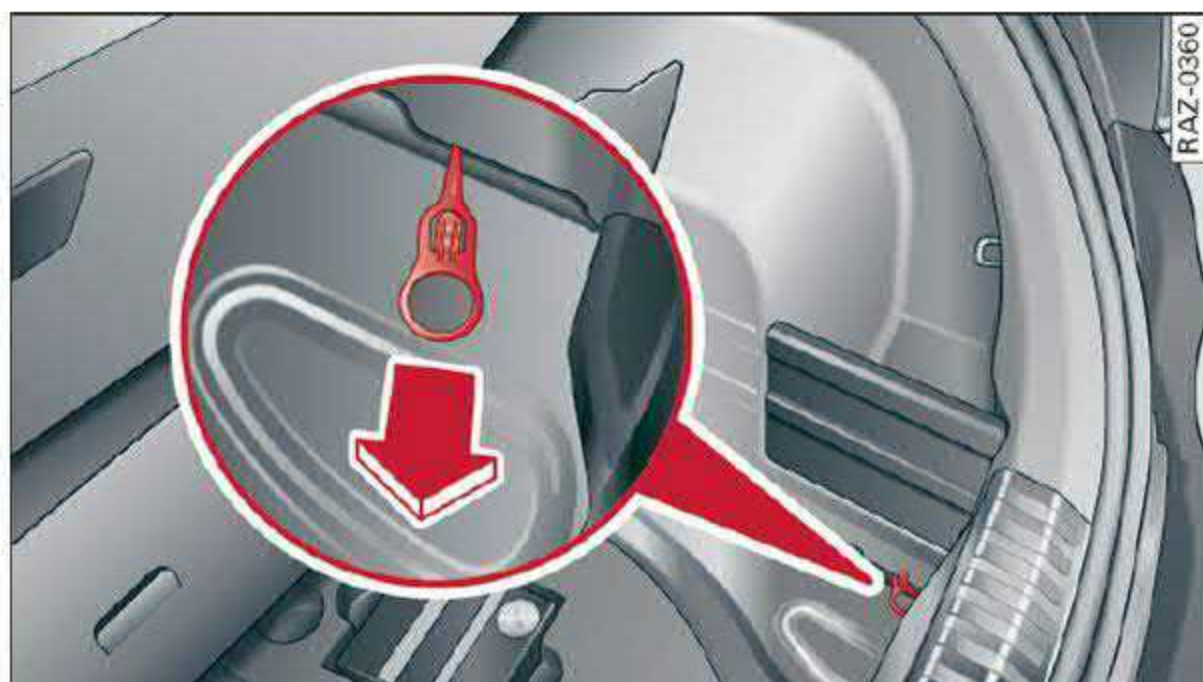



Fig. 142 Luggage compartment: fuel filler door emergency release

The emergency release mechanism is located under the cargo floor in the luggage compartment.

- ▶ Lift up the cargo floor until it engages at the top.
- ▶ Lift up the cloth cover.
- ▶ To unlock the fuel filler door, loosen the red loop from the retainer and then pull on the loop carefully ⇒ *fig. 142* ⇒ .
- ▶ Press on the left side of the fuel filler door to open it ⇒ *page 207, fig. 140*.

! Note

Only pull on the loop until you feel resistance. You will not hear it release. If you continue to pull, you could damage the emergency release mechanism.

Emissions control system**General information****! WARNING**

The temperature of the exhaust system is high, both when driving and after stopping the engine.

- Never touch the exhaust tail pipes once they have become hot. This could result in burns.
- Do not park your vehicle over flammable materials such as grass or leaves because the high temperature of the emissions system could start a fire.
- Do not apply underbody protectant in the exhaust system area, because this increases the risk of fire.

Catalytic converter

Observe the safety precautions ⇒ *page 209, General information*.

The vehicle may only be driven with unleaded gasoline, or the catalytic converter will be destroyed.

Never drive until the tank is completely empty. The irregular supply of fuel that results from that can cause engine misfires. Uncombusted fuel could enter the exhaust system, which could cause overheating and damage to the catalytic converter.

Malfunction Indicator Lamp (MIL)

If the  indicator light blinks or turns on, there is a malfunction that is causing poor emissions quality and that could damage the catalytic converter. Drive slowly to an authorized Audi dealer or authorized Audi Service Facility to have the malfunction corrected.

The indicator light can also turn on if the fuel filler cap is not closed correctly ⇒ *page 207*¹⁾.

¹⁾ Depending on the engine and country





Engine compartment

General information

Special care is required if you are working in the engine compartment

For work in the engine compartment, such as checking and filling fluids, there is a risk of injury, scalding, accidents, and burns. For this reason, follow all the warnings and general safety precautions provided in the following information. The engine compartment is a dangerous area in the vehicle. ⇨ ⚠.

Explanation of warnings (sticker in the engine compartment):

	Hot engine components! Rotating parts!
	The radiator fan can switch on at any time!
	High voltage! Switch off the engine before coming into contact with any ignition system components!
	The catalytic converter can be damaged if the oil level is too high!
	Always follow the instructions in the operating manual.

⚠ WARNING

- Turn the engine off.
- Switch the ignition off.
- Set the parking brake.
- Select the “P” (Park) selector lever position.
- Allow the engine to cool.
- Keep children away from the engine compartment.
- Never spill fluids on a hot engine. These fluids (such as the freeze protection contained in the coolant) can catch fire.
- Avoid short circuits in the electrical system.
- Never reach into the radiator fan. The fan is temperature-controlled and can turn on suddenly, even when the ignition is switched off.
- Never open the hood when there is steam or coolant escaping from the engine compartment, because there is a risk that you could

- be burned. Wait until no steam or coolant is escaping.
- The cap on the coolant expansion tank must never be opened when the coolant is hot. The cooling system is under pressure. There is a risk of burns
- To protect your face, hands, and arms from hot steam or coolant, cover the cap with a thick cloth when opening.
- Do not remove the engine cover under any circumstances. This increases the risk of burns.
- Due to the risk of electric shock, never touch the ignition cable or other components in the electronic high-voltage ignition system when the engine is running or is starting.
- If a gear is engaged while the vehicle is stationary and the engine is running, do not press the accelerator pedal inadvertently. Pressing the accelerator pedal will cause the vehicle to move, and this could result in an accident.
- If inspections or repairs must be performed while the engine is running, moving components (such as the ribbed belt, generator, and radiator fan) pose an additional risk.
 - Set the parking brake first and select the “P” (Park) selector lever position.
 - Always make sure that no parts of the body, jewelry, ties, loose clothing, and long hair can be caught in moving engine components. Before any work, always remove any jewelry and/or ties, tie back long hair, and make sure all clothing fits close to the body to reduce the risk of anything becoming caught in engine components.
- Pay attention to the following warnings listed when work on the fuel system or on the electrical equipment is required.
 - Do not smoke.
 - Never work near open flames.
 - Always have a working fire extinguisher nearby.
- All work on the battery or electrical system in your vehicle can result in injuries, chemical burns, accidents, or burns. Because of this, all work must be performed **only** by an

authorized Audi dealer or authorized Audi Service Facility.

- Limit your exposure to exhaust and chemicals to as short a time as possible.

! WARNING

California Proposition 65 Warning:

- Engine exhaust, some of its constituents, and certain vehicle components contain or emit chemicals known to the State of California to cause cancer and birth defects and reproductive harm. In addition, certain fluids contained in vehicles and certain products of component wear contain or emit chemicals known to the State of California to cause cancer and birth defects or other reproductive harm.
- Battery posts, terminals and related accessories contain lead and lead compounds, chemicals known to the State of California to cause cancer and reproductive harms. Wash hands after handling.

! Note

When filling fluids, be sure not to add any fluids to the wrong reservoirs. Otherwise severe malfunctions and engine damage will occur.

🌳 For the sake of the environment

You should regularly check the ground under your vehicle in order to detect leaks quickly. If there are visible spots from oil or other fluids, bring your vehicle to an authorized Audi dealer or authorized Audi Service Facility to be checked.

Opening and closing the hood

The hood is released from inside the vehicle.



Fig. 143 Footwell: release lever

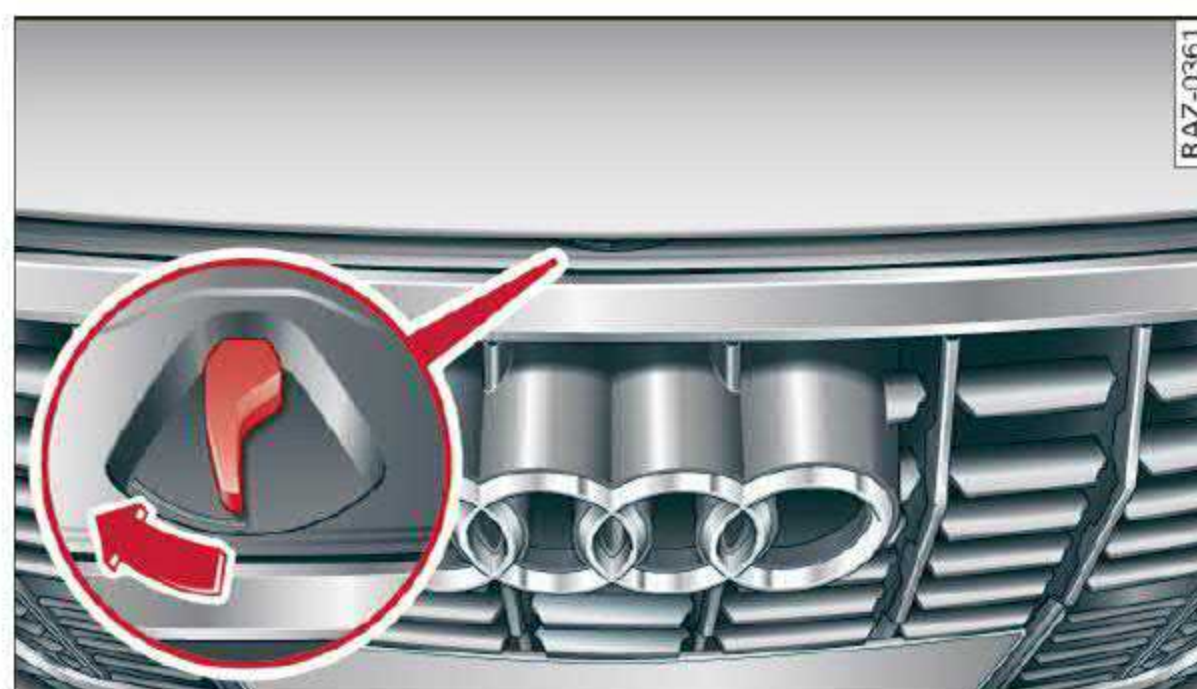





Fig. 144 Unlocked hood: lever

Make sure the wiper arms are not raised up from the windshield. Otherwise the paint could be damaged.

Opening the hood

- ▶ With the door open, pull the lever ¹⁾ below the instrument panel in the direction of the arrow ⇒ fig. 143.
- ▶ Raise the hood slightly ⇒ .
- ▶ Press the lever ⇒ fig. 144 in the direction of the arrow. This releases the hooks.
- ▶ Open the hood.

Closing the hood

- ▶ Push the hood down until you override the force of the strut.
- ▶ Let the hood fall lightly into the latch. *Do not press it in.* ⇒ .

Message

 **Warning! Hood is not locked. Stop vehicle and check the lock**

¹⁾ The  symbol is not available in all countries.

Checking and Filling

The hood latch is not locked correctly. Stop immediately and close the hood.

WARNING

- Never open the hood when there is steam or coolant escaping from the engine compartment, because there is a risk that you could be burned. Wait until no steam or coolant is escaping.
- For safety reasons, the hood must always be latched securely while driving. Because of

this, always check the hood after closing it to make sure it is latched correctly. The hood is latched if the front corners cannot be lifted.

- If you notice that the hood is not latched while you are driving, stop immediately and close it, because driving when the hood is not latched increases the risk of an accident.

Engine compartment overview

The most important check points.

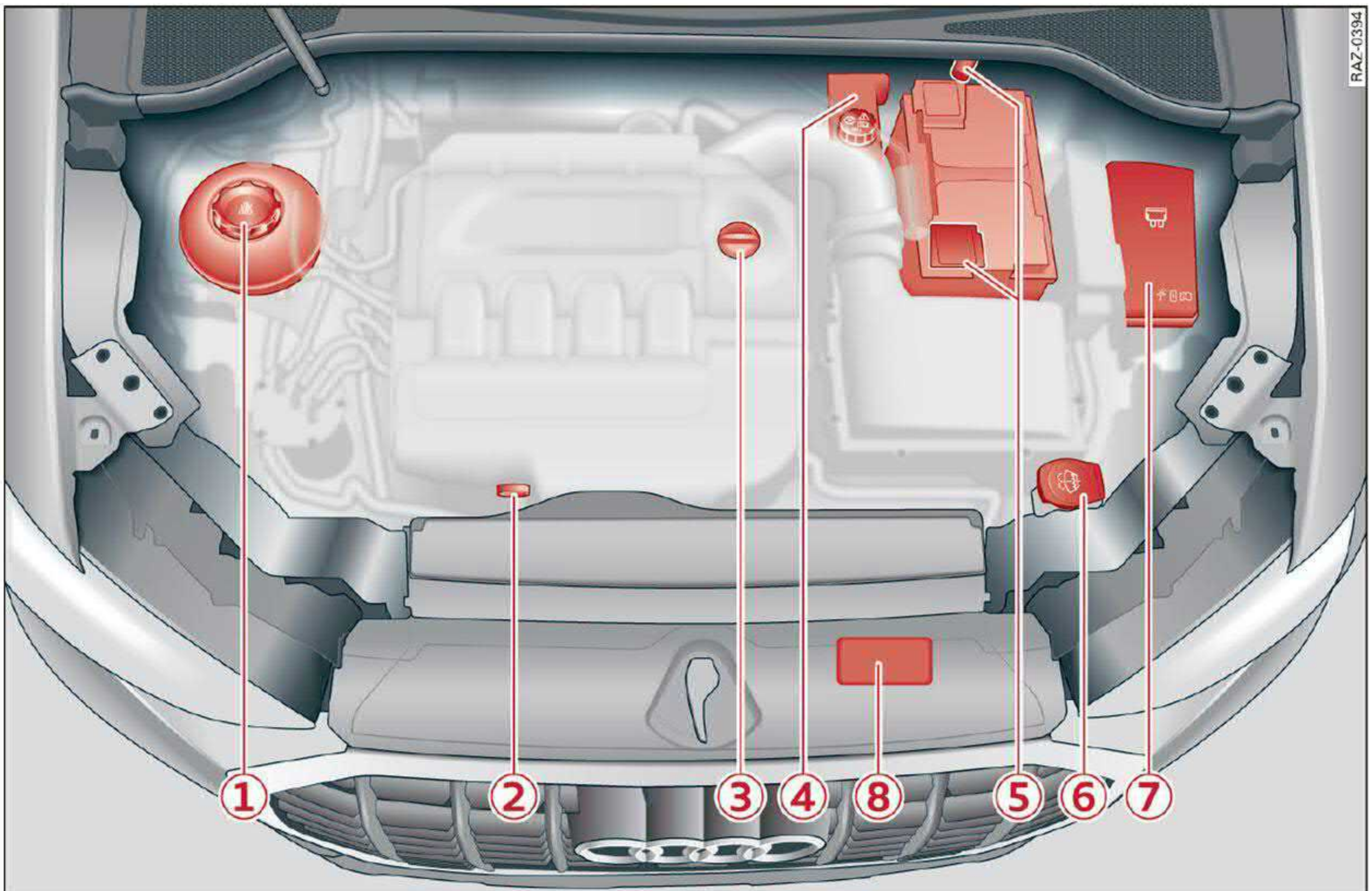

Fig. 145 Engine compartment overview: diagram

Observe the safety precautions ⇒ page 210.

- ① Coolant expansion tank (📏) ⇒ page 217
- ② Engine oil dipstick ⇒ page 214
- ③ Engine oil filler opening (🛢️) ⇒ page 215
- ④ Brake fluid reservoir (🅆) ⇒ page 218
- ⑤ Vehicle battery (+) and ground point (-) ⇒ page 221, *Charging the 12 Volt vehicle battery*, ⇒ page 252, *Jump starting*

- ⑥ Washer fluid reservoir (🚿) ⇒ page 222
- ⑦ Fuse housing ⇒ page 257
- ⑧ Sticker* for engine oil specifications ⇒ page 213

The engine oil dipstick and the engine oil filling opening may be located in different places within the engine compartment, depending on the engine version.

Engine oil

If the engine oil level is too low

If you need to add engine oil, use an oil that is listed on the sticker. The sticker is located at the front of the engine compartment ⇒ *page 212, fig. 145*. When using the engine oil listed on the sticker, you can adjust the oil level as often as needed.

If engine oil that meets the recommended specification is not available, **in an emergency** you may add a maximum of 1 quart (1 liter) of ACEA C3 or API SN engine oil **one time** until the next oil change.

For more information on the correct engine oil for your vehicle, contact an authorized Audi dealer or authorized Audi Service Facility. Have the oil changed by an authorized Audi dealer or authorized Service Facility.

Tips

Audi recommends using engine oils provided by Audi Genuine Parts.

Messages

Engine oil pressure

Turn off engine. Oil pressure too low

Stop driving and switch the engine off. Check the engine oil level ⇒ *page 214*.

- If the engine oil level is too low, add engine oil ⇒ *page 215*. Only continue driving once the indicator light turns off.
- If the engine oil level is correct and the indicator light still turns on, turn the engine off and do not continue driving. See an authorized Audi dealer or authorized Audi Service Facility for assistance.

Engine oil level

Applies to: vehicles with oil level warning

Please check oil level

- You may continue driving for the time being. Check the engine oil level as soon as possible ⇒ *page 214, Checking the engine oil level*.

- If the engine oil level is correct and the indicator light still turns on, drive at low engine speed to an authorized Audi dealer or authorized Audi Service Facility.

Engine oil sensor

Oil level sensor: oil change necessary. Please contact Service

Fuel has entered the engine oil. This will cause the engine oil level to rise slowly and the engine oil quality to decrease. Do not extract engine oil to reduce the level, because this will increase the risk of engine damage. Drive to an authorized Audi dealer or authorized Audi Service Facility immediately to have engine oil extracted.

Oil level system: malfunction! Please contact Service

The sensor that checks the engine oil level has malfunctioned. Drive immediately to an authorized Audi dealer or authorized Audi Service Facility to have the malfunction repaired.

Oil pressure sensor: malfunction! Please contact Service

The sensor that checks the engine oil pressure has malfunctioned. Drive immediately to an authorized Audi dealer or authorized Audi Service Facility to have the malfunction repaired.

Engine warm-up request

Please drive to warm up engine

Fuel has entered the engine oil, either due to low outside temperatures or frequent short drives. Drive until the engine is warm so that the fuel in the engine oil will evaporate. Avoid high engine speeds, full accelerating, and heavy engine loads when doing this.

Tips

The oil pressure warning  is not an oil level indicator. Always check the oil level regularly.

Checking the engine oil level

The engine oil dipstick varies depending on the engine type.

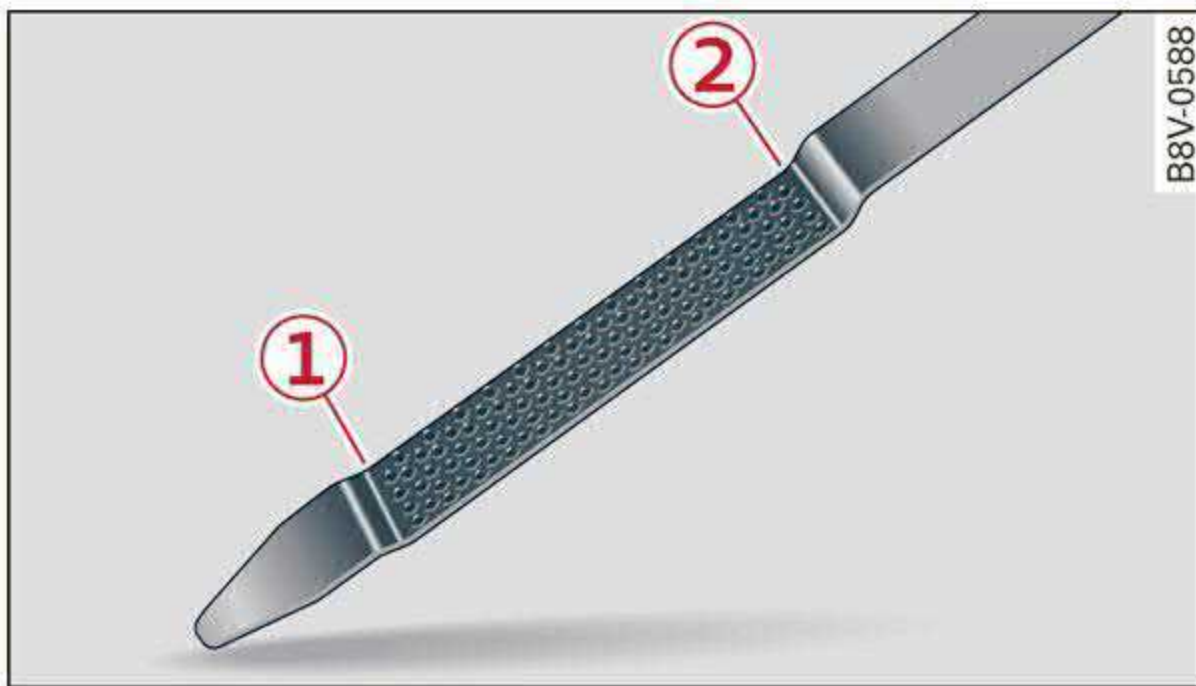

Fig. 146 Oil dipstick (example): checking the engine oil level

Observe the safety precautions ⇒ ⚠ in *General information on page 210*.

- ▶ Park the vehicle on a level surface.
- ▶ Shut the engine off when it is warm.
- ▶ Wait approximately two minutes.
- ▶ Open the hood ⇒ *page 211*.
- ▶ Remove the oil dipstick ⇒ *page 212, fig. 145*, wipe it off with a clean cloth and insert it all the way in again.
- ▶ Remove the oil dipstick again and then read the oil level ⇒ *table on page 214*.
- ▶ Slide the oil dipstick all the way in until it stops.
- ▶ Add engine oil if necessary ⇒ *page 215*.

Areas on the oil dipstick ⇒ *fig. 146*.

- | | |
|----------|---|
| 1 | If the engine oil level is just before the marking 1 , then engine oil must be added. See ⇒ ⚠. |
| 2 | Do not add engine oil. |

! Note

- The engine oil level must not be below the marking **1**, because this increases the risk of engine damage.
- After adding engine oil, the oil level must not be above the marking **2** ⇒ *fig. 146*, because this increases the risk of catalytic converter and/or engine damage. If the oil level is above the marking **2**, drive to an authorized Audi dealer or authorized Audi Service Facility immediately to have any engine oil

extracted. Avoid high engine speeds, full acceleration, and heavy engine loads.

i Tips

- The engine oil consumption may be up to 0.5 quart/600 miles (0.5 liter/1,000 km), depending on driving style and operating conditions. Consumption may be higher during the first 3,000 miles (5,000 km). The engine oil level must be checked regularly. It is best to check each time you refuel your vehicle and before long drives.
- Because of the lubrication and cooling of the engine, combustion engines consume oil. The oil consumption varies depending on the engine and may change during the service life of the engine. Engines generally consume more oil at the beginning during the break-in period. Then oil consumption stabilizes after the break-in period.
- Under normal conditions, oil consumption depends on the quality and viscosity of the oil, the engine RPM, the climate conditions, and the road conditions. The dilution of oil from condensation or fuel residue as well as the age of the oil also play a role. Because engine wear increases with mileage, oil consumption will increase again over time until it may be necessary to replace worn components.
- Because all these variables play a role, it is not possible to define an oil consumption standard. Therefore, the oil level must be checked regularly.
- If you believe that your engine has increased its oil consumption, contact an authorized Audi dealer or authorized Audi Service Facility to determine the cause. Please note that an exact oil consumption measurement must be done with the necessary care and accuracy and may take time. An authorized Audi dealer or authorized Audi Service Facility is trained in accurately measuring the oil consumption.
- You can find information on engine oil and engine oil capacities for the USA at www.audiusa.com/help/maintenance, or for Canada at www.audi.ca/ca/web/en/

customer-area/care-and-maintenance/audi-service-schedules.html, or call 800-822-2834.

Adding engine oil



B8K-2120

Fig. 147 Engine compartment: engine oil filler opening cover

Observe the safety precautions ⇒ *page 210, General information.*

- ▶ Turn the engine off.
- ▶ Open the hood ⇒ *page 211.*
- ▶ Unscrew the cap  for the engine oil filler opening ⇒ *fig. 147.*
- ▶ Carefully add 0.5 quart (0.5 liter) of the correct oil ⇒ *page 213.*
- ▶ Check the oil level again after two minutes ⇒ *page 214, Checking the engine oil level.*
- ▶ Applies to: using engine oil that meets the recommended specification: Add some more engine oil again if necessary.
- ▶ Close the engine oil filler cap and push the dipstick all the way in.
- ▶ Close the hood ⇒ *page 211.*

WARNING

- When adding oil, do not let oil drip onto hot engine components. This increases the risk of a fire.
- You must close the cap on the oil filler opening correctly so that oil does not leak out onto the hot engine and exhaust system when the engine is running, because this is a fire hazard.
- Always clean skin thoroughly if it comes into contact with engine oil.
- Engine oil is poisonous and must be kept out of reach of children.

- Store the engine oil securely in the original container.

Note

- The New Vehicle Limited Warranty does not cover damage or malfunctions if the recommended intended use of the vehicle and maintenance measures listed in the Audi Owner's Manual and the Warranty & Maintenance Booklet were not followed.
- Only use high-grade engine oil that explicitly meets the Audi oil quality standard for your vehicle. Using another oil may cause severe vehicle damage.
- Do not mix any additives with the engine oil. Additives may cause engine damage that is not covered by your New Vehicle Limited Warranty.

For the sake of the environment

- Oil should never enter the sewer system or come into contact with the ground.
- Follow the legal regulations in the country where you are located when disposing of empty oil containers.

Changing engine oil

Audi recommends having the oil changed at an authorized Audi dealer or authorized Audi Service Facility.

Observe the safety precautions ⇒ *page 210, General information.*

The engine oil must be changed at the intervals specified in the Warranty & Maintenance Booklet. This is very important because the lubrication function of the oil gradually declines during regular vehicle operation.

The engine oil should be changed more frequently under certain circumstances. Have the oil changed more frequently if you often drive short distances, your vehicle is predominantly in stop-and-go traffic situations, is in very dusty environments, or is operated for long periods of time in temperatures below zero.

Cleansing additives in the oil make fresh oil appear darker after the engine has run briefly. This is normal and no reason to change the engine oil more frequently than recommended.

Because correctly disposing of engine oil is difficult and special tools and technical knowledge are needed for an oil change, Audi recommends having your engine oil changed by an authorized Audi dealer or authorized Audi Service Facility.

If you change the engine oil yourself, please note the following important information:

WARNING

If you change the engine oil on the vehicle yourself, the following precautions must be followed:

- Wear protective eyewear.
- Due to the risk of scalding, allow the engine to cool down sufficiently.
- Maintain enough distance when you are removing the oil drain plug. While doing this, keep your forearm parallel to the ground to reduce the risk of hot oil dripping down your arm.
- Drain the oil into a container designed for this purpose that is large enough to hold the full amount of oil in your engine.
- Engine oil is poisonous. Always store out of reach of children.
- Prolonged contact of used engine oil with the skin may cause skin damage. Always wash oil off immediately with soap and water to protect your skin.

Note

Do not mix any additives with the engine oil. Additives may cause engine damage that is not covered by your New Vehicle Limited Warranty.

For the sake of the environment

- Before changing the engine oil, make sure you can dispose of the used engine oil correctly.
- Engine oil must always be disposed of correctly. Do not dump it in the yard, in the for-

est, or in open water, river channels, or sewers.

- Have your used engine oil recycled by bringing it to a used oil collection site or contact a gas station.

Cooling system

Coolant

The engine cooling system is filled with a mixture of purified water and coolant additive at the factory. This coolant must not be not changed.

The coolant level is monitored using the  indicator light. However, occasionally checking the coolant level is recommended.

Messages

 **Turn off engine and check coolant level. See owner's manual**

The coolant level is too low.

Stop driving and switch the engine off. Check the coolant level ⇒ *page 217*.

- If the coolant level is too low, add coolant ⇒ *page 217*. Only continue driving once the indicator light turns off.

 **Coolant temperature: too high. Please let engine run while vehicle is stationary**

Let the engine run at idle for a few minutes to cool off, until the indicator light turns off.

- If the indicator light does not turn off, do not continue driving the vehicle. See an authorized Audi dealer or authorized Audi Service Facility for assistance.

 **Coolant system: malfunction! Please turn off engine**

Do not continue driving, shut the engine off, and switch the ignition off.

- See an authorized Audi dealer or authorized Audi Service Facility for assistance.

Coolant additive

The coolant additive is made of anti-freezing and corrosion protection agents. Only add the

following coolant additives mixed with distilled water.

Coolant additive	Specification
G12evo	TL 774 L

The amount of coolant additive that needs to be mixed with water depends on the climate where the vehicle will be operated. If the coolant additive percentage is too low, the coolant can freeze and damage the engine.

	Coolant additive	Freeze protection
Warm regions	min. 40% max. 45%	min. -13 °F (-25 °C)
Cold regions	min. 50% max. 55%	max. -40 °F (-40 °C)

! Note

- Before the start of winter, have an authorized Audi dealer or authorized Audi Service Facility check if the coolant additive in your vehicle matches the percentage appropriate for the climate. This is especially important when driving in colder climates.
- If the G12evo coolant additive is not available in an emergency, do not add any other additive. You could damage the engine. If this happens, only use distilled water and restore the correct mixture ratio with the specified coolant additive as soon as possible.
- Only refill with new coolant.
- Radiator sealant must not be mixed with the coolant.
- You can continue driving if the permitted G12evo coolant additive was not added. However, go to an authorized Audi dealer or authorized Audi Service Facility immediately to have the coolant replaced to reduce the risk of engine damage.
- Due to the risk of engine damage, the cooling system should only be refilled by an authorized Audi dealer or authorized Audi Service Facility. An authorized Audi dealer or authorized Audi Service Facility can also provide you with important information about the recommended coolant additive.

Checking coolant

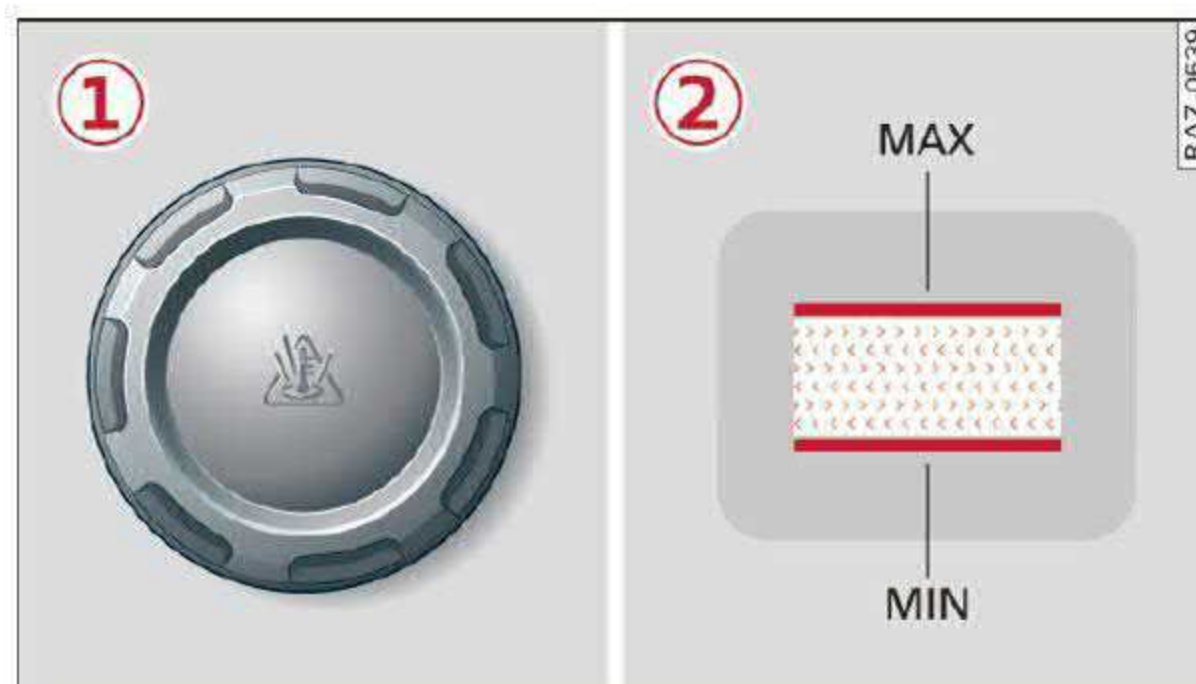

Fig. 148 Engine compartment - coolant expansion tank (diagram): ① cover; ② markings

Observe the safety precautions ⇒ *page 210, General information*.

Checking the coolant level

- ▶ Park the vehicle on a level surface.
- ▶ Switch the ignition off.
- ▶ Open the hood ⇒ *page 211*.
- ▶ Check the coolant level in the coolant expansion tank ⇒ *page 212, fig. 145* using the outer markings ② ⇒ *fig. 148*. The coolant level must be between the markings ② when the engine is cold. When the engine is warm it can be slightly above the upper marking.

Adding coolant

Requirement: there must be a residual amount of coolant in the expansion tank ⇒ !.

If you must add coolant, use a mixture of water and coolant additive. Audi recommends mixing the coolant additive with distilled water.

- ▶ Allow the engine to cool.
- ▶ Place a large, thick towel on the coolant expansion tank cap.
- ▶ Remove the cover ① ⇒ *fig. 148* carefully to the left ⇒ ⚠.
- ▶ Add the correct mixture ratio of coolant ⇒ *page 216* up to the upper marking ② ⇒ *fig. 148*.
- ▶ Make sure that the fluid level remains stable. Add more coolant if necessary.
- ▶ Screw on the cap securely to the right.

Coolant loss usually indicates that there is a leak. Immediately drive your vehicle to an authorized ►

Audi dealer or authorized Audi Service Facility and have the cooling system inspected. If the cooling system is not leaking, coolant loss can result from the coolant boiling due overheating and then being forced out of the cooling system.

WARNING

- The engine compartment in any vehicle is a potentially dangerous area. Stop the engine and allow it to cool before working in the engine compartment. Always follow the information found in ⇒ *page 210, General information*.
- Never open the hood if you can see or hear steam or coolant escaping from the engine compartment. This increases the risk of burns. The cooling system is under pressure. When you no longer see or hear steam or coolant escaping, you may open the engine compartment with caution.
- When working in the engine compartment, remember that the radiator fan can switch on even if the ignition is switched off, which increases the risk of injury.
- Coolant additive and coolant can be dangerous to your health. For this reason, store the coolant in the original container and away from children. There is a risk of poisoning.

Note

Do not continue driving if the coolant expansion tank is empty. Do not add any coolant, because air could enter the cooling system and damage the engine. See an authorized Audi dealer or authorized Audi Service Facility for assistance.

Brake fluid



Fig. 149 Engine compartment: cap on brake fluid reservoir

Observe the safety precautions ⇒ *page 210, General information*.

Checking the brake fluid level

Read the brake fluid level on the brake fluid reservoir ⇒ *page 212, fig. 145*. The brake fluid level must be between the MIN and MAX markings ⇒ .

The brake fluid level is monitored automatically.

Message

BRAKE /  **Brakes: stop vehicle and check brake fluid level**

Stop the vehicle and check the brake fluid level. See an authorized Audi dealer or authorized Audi Service Facility for assistance.

Changing the brake fluid

Brake fluid should be changed at regular intervals. Have the brake fluid changed by an authorized Audi dealer or authorized Audi Service Facility. The authorized Audi dealer or authorized Audi Service Facility will inform you of the replacement intervals.

WARNING

- If the brake fluid level is below the MIN marking, it can impair the braking effect and driving safety, which increase the risk of an accident. Do not continue driving. See an authorized Audi dealer or authorized Audi Service Facility for assistance.
- If the brake fluid is old, bubbles may form in the brake system during heavy braking. This



could impair braking performance and driving safety, which increases the risk of an accident.

- The brake fluid in your vehicle must meet the standard VW 501 14 and is available at an authorized Audi dealer or authorized Audi Service Facility. If this brake fluid is not available, another high-grade brake fluid of equivalent quality may be used, and it must meet the U.S. Federal Motor Vehicle Standard (FMVSS) 116 DOT 4, Class 6.

 **Note**

- If the brake fluid level is above the MAX marking, brake fluid may leak out over the edge of the reservoir and result in damage to the vehicle.
- Do not allow any brake fluid to come into contact with the vehicle paint, because it will corrode the paint.

Electrical system

If the  or  indicator light turns on, there is a malfunction in the generator, the battery, or the vehicle electrical system.

 **Electrical system: malfunction! Safely stop vehicle**

Do not continue driving and switch the engine off ⇒ . See an authorized Audi dealer or authorized Audi Service Facility for assistance.

 **Electrical system: malfunction! Restart not possible. Please contact Service**

It will not be possible to restart the engine once you turn it off. Vehicle functions or driving stability may be limited. Drive to an authorized Audi dealer or authorized Audi Service Facility immediately.

 **Electrical system: malfunction! Please contact Service**

Switch off all electrical equipment that is not needed. Vehicle functions or driving stability may be limited. Drive to an authorized Audi dealer or authorized Audi Service Facility immediately.

 **Electrical system: low battery charge. Battery will be charged while driving**

The starting ability may be impaired.

If this message turns off after a little while, the vehicle battery has charged enough while driving.

If this message does not turn off, drive immediately to an authorized Audi dealer or authorized Audi Service Facility.

 **WARNING**

When there is an electrical system malfunction, vehicle functions may not work and driving stability may be limited, which increases the risk of an accident. Stop driving and switch the engine off. See an authorized Audi dealer or authorized Audi Service Facility for assistance.

Battery

Battery general information

Because of the complex power supply, all work on batteries such as disconnecting, replacing, etc., should **only** be performed by an authorized Audi dealer or authorized Audi Service Facility ⇒ .

Multiple batteries with different technologies may be installed in your vehicle:

- Vehicle battery (for example, for starting the engine, basic power supply) ⇒ *page 220, 12 Volt vehicle battery* or ⇒ *page 220, Other battery types*
- Auxiliary battery (for example, for recuperation or optional equipment) ⇒ *page 220, Other battery types*

Not running the vehicle for long periods of time

The battery will gradually drain if the vehicle does not run for long periods of time. To ensure that the vehicle can still be started, the electrical equipment will be limited or switched off. Some convenience functions, such as interior lighting or power seat adjustment, may not be available under certain circumstances. The convenience functions will be available again when you start the engine.

Checking and Filling

Even when electrical equipment is switched off, the equipment can still drain the battery if the vehicle is not driven for long periods of time. Deep draining results in a chemical reaction that destroys the inside of the battery. The battery must be charged every month to prevent this ⇒ *page 221*. Contact an authorized Audi dealer or authorized Audi Service Facility for more information.

Winter operation

Cold weather places higher demands on the battery. This results in reduced starting ability. Have the battery checked by an authorized Audi dealer or authorized Audi Service Facility before cold weather begins.

WARNING

All work on the battery or electrical system in your vehicle can result in injuries, chemical burns, accidents, or burns. Because of this, all work must be performed **only** by an authorized Audi dealer or authorized Audi Service Facility.

WARNING

California Proposition 65 Warning:
 – Battery posts, terminals and related accessories contain lead and lead compounds, chemicals known to the State of California to cause cancer and reproductive harms. Wash hands after handling.







Note

- If the vehicle will be parked for long periods of time, protect the battery against the cold so that it will not be destroyed by “freezing” ⇒ *page 221, Charging the 12 Volt vehicle battery*.
- There are electrical components under the cargo floor behind a trim panel that warm up during operation. To reduce the risk of the components overheating, do not store objects such as blankets under the cargo floor. If the components overheat, they will switch off temporarily. This will be indicated by a message that will be displayed in the



instrument cluster until the temperature returns to normal.

12 Volt vehicle battery

Explanation of warnings:



	Always wear eye protection.
	Battery acid is highly corrosive. Always wear protective gloves and eye protection.
	Fire, sparks, open flame, and smoking are forbidden.
	A highly explosive mixture of gases can form when charging batteries.
	Always keep children away from battery acid and the battery.
	Always follow the instructions in the operating manual.

For the sake of the environment

  Lead-acid batteries must be disposed of using methods that will not harm the environment. Do not dispose of them in household trash. They contain harmful substances, such as sulfuric acid and lead, and also recyclable raw materials. Contact an authorized Audi dealer or authorized Audi Service Facility for more information.

Other battery types

Explanation of warnings:

	Fire, sparks, open flame, and smoking are forbidden.
	Always keep children away from battery acid and the battery.
	Always follow the instructions in the operating manual.

WARNING

All work on the batteries must **only** be performed by an authorized Audi dealer or authorized Audi Service Facility.
 – Gases that escape from these different battery types can be poisonous or flammable.

– The contents of these battery types can be corrosive. If any battery contents come into contact with the skin, flush the affected area for at least 15 minutes with clean water. Then wash the affected area with soap. Have the affected area examined by a medical professional.

! Note

Components must not be connected to the battery terminals and wires on these battery types because this increases the risk of damage, for example due to overvoltage.

🌱 For the sake of the environment

♻️ These types of batteries must be disposed of using methods that will not harm the environment. Do not dispose of them in household trash. They contain harmful substances and recyclable raw materials. Contact an authorized Audi dealer or authorized Audi Service Facility for more information.

Charging the 12 Volt vehicle battery



Fig. 150 Engine compartment with battery: connections for charger and jump start cable

Observe the safety precautions ⇒ *page 210, General information*, ⇒ ⚠️ in *Battery general information on page 220* and ⇒ ⚠️.

Requirement: only use chargers with a **maximum charging current of 14.8 volts**. The battery cables remain connected.

The battery is located in the engine compartment. The ground point ⊖ is always located on the vehicle body.

- ▶ Switch off the ignition and all electrical equipment.
- ▶ Open the hood ⇒ *page 211*.
- ▶ Open the cover on the positive terminal ⇒ *fig. 150*.
- ▶ Clamp the terminal clamps on the charger correctly onto the ground point ⊖ and the positive terminal ⊕.
- ▶ Insert the power cable for the charging device into the socket and switch the device on.
- ▶ At the end of the charging process, switch the charger off and pull the power cable out of the socket.
- ▶ Remove the charging device terminal clamps.
- ▶ Close the cover on the positive terminal.
- ▶ Close the hood ⇒ *page 211*.

⚠️ WARNING

- A highly explosive mixture of gases can form when charging batteries. Only charge the battery in well-ventilated areas.
- A drained battery can freeze at temperatures around 32 °F (0 °C). Do not charge or use a frozen or thawed battery. If ice forms, the battery housing can crack and battery electrolyte can leak out, which increases the risk of an explosion and chemical burns. Contact an authorized Audi dealer or authorized Audi Service Facility for more information.
- Do not connect or disconnect the charging cable while charging because this increases the risk of an explosion.

i Tips

- Only charge the battery through the connections in the engine compartment.
- Read all of the manufacturer's instructions for the charger before charging the battery.

Windshield washer system



Fig. 151 Engine compartment: washer fluid reservoir cap

Observe the safety precautions ⇒ *page 210, General information.*

The windshield washer fluid reservoir  contains the cleaning solution for the windshield and the headlight washer system ⇒ *fig. 151, ⇒ page 212.* The reservoir capacity can be found in ⇒ *page 269.*

To reduce the risk of lime scale deposits on the spray nozzles, use clean water with low amounts of calcium. Always add window cleaner to the water. When the outside temperatures are cold, an anti-freezing agent should be added to the water so that it does not freeze.

Messages

Please add washer fluid

Fill the washer fluid for the windshield washer system and the headlight washer system* when the ignition is switched off.

Note

- The concentration of anti-freezing agent must be adjusted to the vehicle operating conditions and the climate. A concentration that is too high can lead to vehicle damage.
- Never add radiator anti-freeze or other additives to the washer fluid.
- Do not use a glass cleaner that contains paint solvents, because this could damage the paint.

Service interval display

The service interval display detects when your vehicle is due for service.

The service interval display works in two stages:

- **Inspection or oil change reminder:** after driving a certain distance, a message appears in the instrument cluster display each time the ignition is switched on or off. The remaining distance or time is displayed briefly.
- **Inspection or oil change due:** if your vehicle has reached an inspection or oil change interval or both intervals at the same time, the message **Inspection due!** or **Oil change due!** or **Oil change and inspection due!** appears briefly after switching the ignition on or off.

Checking service intervals

You can check the remaining distance or time until the next oil change or next inspection in the Infotainment system.

Select on the home screen: **VEHICLE > Settings & Service > Service intervals.**

Resetting the indicator

An authorized Audi dealer or authorized Audi Service Facility will reset the service interval display after performing service.

If you have changed the oil yourself, you must reset the oil change interval.

To reset the display, select on the home screen: **VEHICLE > Settings & Service > Service intervals > Reset oil change interval.**

Note

- Only reset the oil change indicator if the oil was changed.
- Following the service intervals is critical to maintaining the service life and value of your vehicle, especially the engine. Even if the mileage on the vehicle is low, do not exceed the time for the next service.

Wheels

Wheels and Tires

General information

- ▶ Check your tires regularly for damage, such as punctures, cuts, cracks, and bulges. Remove foreign objects from the tire tread.
- ▶ If driving over curbs or similar obstacles, drive slowly and approach the curb at an angle.
- ▶ Have faulty tires or rims replaced immediately.
- ▶ Protect your tires from oil, grease, and fuel.
- ▶ Mark tires before removing them so that the same running direction can be maintained if they are reinstalled.
- ▶ Lay tires flat when storing and store them in a cool, dry location with as little exposure to light as possible.



WARNING

–Never drive faster than the maximum permitted speed for your tires. This could cause the tires to heat up too much. This increases the risk of an accident because it can cause the tire to burst.

–Always adapt your driving to the road and traffic conditions. Drive carefully and reduce your speed on icy or slippery roads. Even winter tires can lose traction on black ice.



Note

–Please note that summer and winter tires are designed for the conditions that are typical in those seasons. Audi recommends winter tires during the winter months. Low temperatures significantly decrease the elasticity of summer tires, which affects traction and braking ability. If summer tires are used in very cold temperatures, cracks can form on the tread bars, resulting in permanent tire damage that can cause loud driving noise and unbalanced tires.

–Burnished, polished or chromed rims must not be used in winter driving conditions. The surface of the rims does not have sufficient corrosion protection for this and could be permanently damaged by road salt or similar substances.

Tire designations

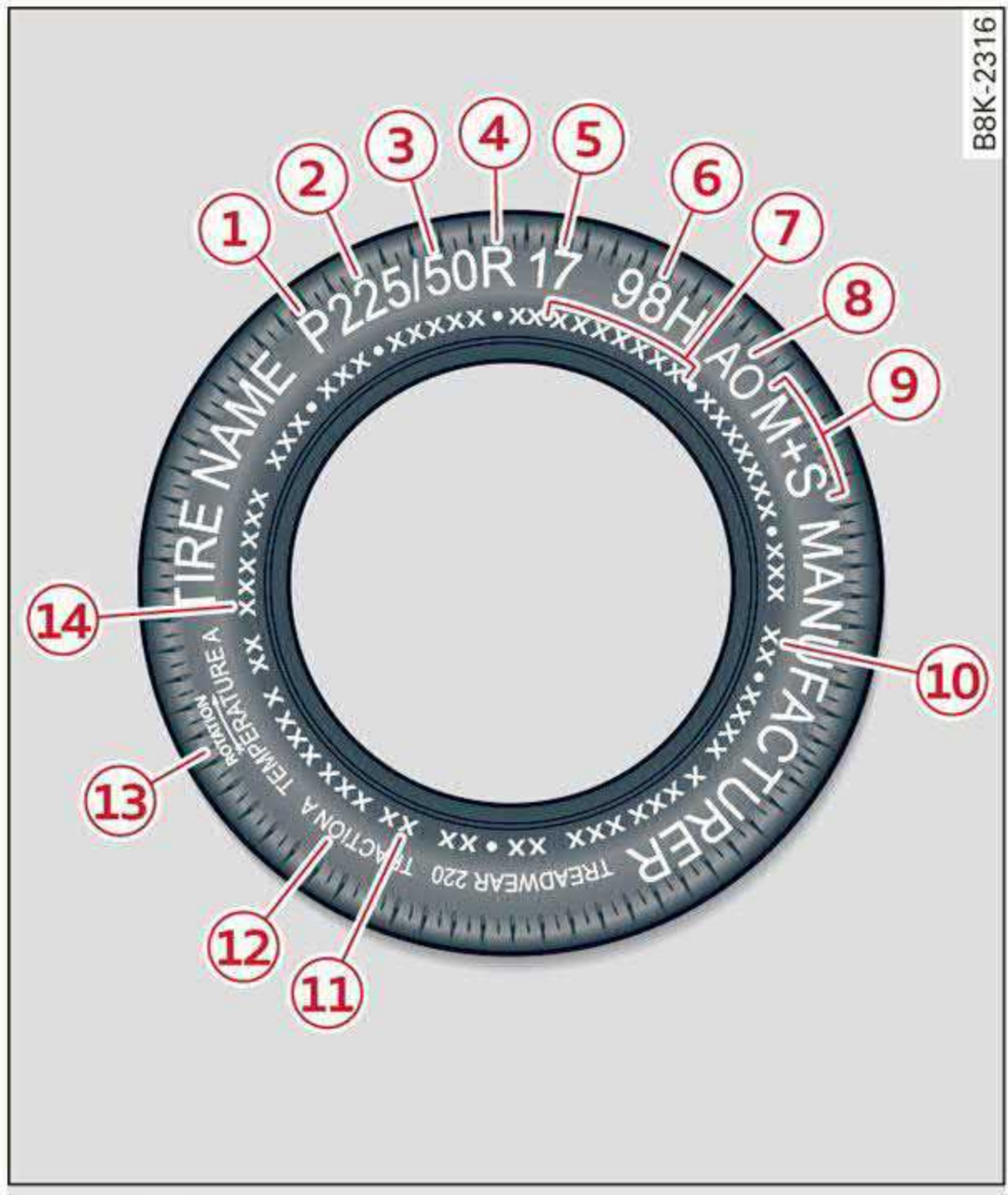

Fig. 152 Tire designations on the sidewall

① Tires for passenger vehicles (if applicable)

“P” indicates a tire for a passenger vehicle. “T” indicates a tire designated for temporary use.

② Nominal width

Nominal width of the tire between the sidewalls in millimeters. In general: the larger the number, the wider the tire.

③ Aspect ratio

Height/width ratio expressed as a percentage.

④ Tire construction

“R” indicates a radial tire.

⑤ Rim diameter

Size of the rim diameter in inches.

⑥ Load index and speed rating

The load index indicates the tire's load-carrying capacity.

The speed rating indicates the maximum permitted speed. Also see ⇒ **Δ** in *General information on page 223*.

“EXTRA LOAD”, “xl” or “RF” indicates that the tire is reinforced or is an Extra Load tire.

Speed rating	Maximum permitted speed
P	up to 93 mph (150 km/h)
Q	up to 99 mph (160 km/h)
R	up to 106 mph (170 km/h)
S	up to 110 mph (180 km/h)
T	up to 118 mph (190 km/h)
U	up to 124 mph (200 km/h)
H	up to 130 mph (210 km/h)
V	up to 149 mph (240 km/h) ^{a)}
Z	above 149 mph (240 km/h) ^{a)}
W	up to 168 mph (270 km/h) ^{a)}
Y	up to 186 mph (300 km/h) ^{a)}

^{a)} For tires above 149 mph (240 km/h), tire manufacturers sometimes use the code “ZR”.

⑦ US DOT number (TIN) and manufacture date

The manufacture date is listed on the tire sidewall (it may only appear on the inner side of the tire):

DOT ... 2220 ...

means, for example, that the tire was produced in the 22nd week of the year 2020.

⑧ Audi Original Tires

Audi Original equipment tires with the designation “AO” have been specially matched to your Audi. When used correctly, these tires meet the highest standards for safety and handling. An authorized Audi dealer or authorized Audi Service Facility will be able to provide you with more information.

⑨ Mud and snow capability

“M/S” or “M+S” indicates the tire is suitable for driving on mud and snow.  indicates a winter tire.

⑩ Composition of the tire cord and materials

The number of plies indicates the number of rubberized fabric layers in the tire. In general: the more layers, the more weight a tire can carry. Tire manufacturers

must also specify the materials used in the tire. These include steel, nylon, polyester and other materials.

⑪ Maximum permitted load

This number indicates the maximum load in kilograms and pounds that the tire can carry.

⑫ Uniform tire quality grade standards for treadwear, traction and temperature resistance

Treadwear, traction, and temperature ranges ⇒ *page 239*.

⑬ Running direction

The arrows indicate the running direction of unidirectional tires. You must always follow the specified running direction ⇒ *page 251*.

⑭ Maximum permitted inflation pressure

This number indicates the maximum pressure to which a tire can be inflated under normal operating conditions.

Glossary of tire and loading terminology

Accessory weight

means the combined weight (in excess of those standard items which may be replaced) of automatic transmission, power steering, power brakes, power windows, power seats, radio, and heater, to the extent that these items are available as factory-installed equipment (whether installed or not).

Aspect ratio

means the ratio of the height to the width of the tire in percent. Numbers of 55 or lower indicate a low sidewall for improved steering response and better overall handling on dry pavement.

Bead

means the part of the tire that is made of steel wires, wrapped or reinforced by ply cords and that is shaped to fit the rim.

Bead separation

means a breakdown of the bond between components in the bead.

Cord

means the strands forming the plies in the tire.

Cold tire inflation pressure

means the tire pressure recommended by the vehicle manufacturer for a tire of a designated size that has not been driven for more than a couple of miles (kilometers) at low speeds in the three hour period before the tire pressure is measured or adjusted.

Curb weight

means the weight of a motor vehicle with standard equipment including the maximum capacity of fuel, oil, and coolant, air conditioning and additional weight of optional equipment.

Extra load tire

means a tire designed to operate at higher loads and at higher inflation pressures than the corresponding standard tire. Extra load tires may be identified as “XL”, “xl”, “EXTRA LOAD”, or “RF” on the sidewall. ▶

Gross Axle Weight Rating (“GAWR”)

means the load-carrying capacity of a single axle system, measured at the tire-ground interfaces.

Gross Vehicle Weight Rating (“GVWR”)

means the maximum total loaded weight of the vehicle.

Groove

means the space between two adjacent tread ribs.

Load rating (code)

means the maximum load that a tire is rated to carry for a given inflation pressure. You may not find this information on all tires because it is not required by law.

Maximum load rating

means the load rating for a tire at the maximum permissible inflation pressure for that tire.

Maximum loaded vehicle weight

means the sum of:

- (a) Curb weight
- (b) Accessory weight
- (c) Vehicle capacity weight, and
- (d) Production options weight

Maximum (permissible) inflation pressure

means the maximum cold inflation pressure to which a tire may be inflated. Also called “maximum inflation pressure.”

Normal occupant weight

means 150 lbs. (68 kilograms) times the number of occupants seated in the vehicle up to the total seating capacity of your vehicle.

Occupant distribution

means distribution of occupants in a vehicle.

Outer diameter

means the overall diameter of an inflated new tire.

Overall width

means the linear distance between the exteriors of the sidewalls of an inflated tire, including elevations due to labeling, decorations, or protective bands or ribs.

Ply

means a layer of rubber-coated parallel cords. ▶

Production options weight

means the combined weight of those installed regular production options weighing over 5 lbs.

(2.3 kg) in excess of those standard items which they replace, not previously considered in curb weight or accessory weight, including heavy duty brakes, ride levelers, roof rack, heavy duty battery, and special trim.

Radial ply tire

means a pneumatic tire in which the ply cords that extend to the beads are laid at substantially 90 degrees to the centerline of the tread.

Recommended inflation pressure

see ⇒ *page 226, Cold tire inflation pressure.*

Reinforced tire

means a tire designed to operate at higher loads and at higher inflation pressures than the corresponding standard tire. Reinforced tires may be identified as “XL”, “xl”, “EXTRA LOAD”, or “RF” on the sidewall.

Rim

means a metal support for a tire or a tire and tube assembly upon which the tire beads are seated.

Rim diameter

means nominal diameter of the bead seat. If you change your wheel size, you will have to purchase new tires to match the new rim diameter.

Rim size designation

means rim diameter and width.

Rim width

means nominal distance between rim flanges.

Sidewall

means that portion of a tire between the tread and bead.

Speed rating (letter code)

means the speed at which a tire is designed to be driven for extended periods of time. The ratings range from 93 mph (150 km/h) to 186 mph (298 km/h) ⇒ *table on page 224*. You may not find this information on all tires because it is not required by law.

The speed rating letter code, where applicable, is molded on the tire sidewall and indicates the ►

maximum permissible road speeds. See also ⇒  in *General information on page 223*.

Tire pressure monitoring system

means a system that detects when one or more of a vehicle's tires are underinflated and illuminates a low tire pressure warning telltale.

Tread

means that portion of a tire that comes into contact with the road.

Tread separation

means pulling away of the tread from the tire carcass.

Treadwear indicators (TWI)

means the projections within the principal grooves designed to give a visual indication of the degrees of wear of the tread. See ⇒ *page 232, Treadwear indicator* for more information on measuring tire wear.

Uniform Tire Quality Grading

is a tire information system developed by the United States National Highway Traffic Safety Administration (NHTSA) that is designed to help buyers make relative com-

parisons among tires. The UTQG is not a safety rating and not a guarantee that a tire will last for a prescribed number of miles (kilometers) or perform in a certain way. It simply gives tire buyers additional information to combine with other considerations, such as price, brand loyalty and dealer recommendations. Under UTQG, tires are graded by the tire manufacturers in three areas: treadwear, traction, and temperature resistance. The UTQG information on the tires, molded into the sidewalls.

U.S. DOT Tire Identification Number (TIN)

This is the tire's "serial number". It begins with the letters "DOT" and indicates that the tire meets all federal standards. The next two numbers or letters indicate the plant where it was manufactured, and the last four numbers represent the week and year of manufacture. For example,

DOT ... 2220 ...

means that the tire was produced in the 22nd week of 2020. The other numbers are marketing codes that may or may not be used ►

by the tire manufacturer. This information is used to contact consumers if a tire defect requires a recall.

Vehicle capacity weight

means the rated cargo and luggage load plus 150 lbs. (68 kilograms) times the vehicle's designated seating capacity.

Vehicle maximum load on the tire

means that load on an individual tire that is determined by distributing to each axle its share of the maximum loaded vehicle weight and dividing by two.

Vehicle normal load on the tire

means that load on an individual tire that is determined by distributing to each axle its share of the curb weight, accessory weight, and normal occupant weight (distributed in accordance with ⇒ *table on page 235*) and dividing by two.

Occupant loading and distribution for vehicle normal load for various designated seating capacities

Refer to the tire inflation pressure label ⇒ *page 233, fig. 155* for the

number of seating positions. Refer to the table ⇒ *table on page 235* for the number of people that correspond to the vehicle normal load.

New tires or wheels

Audi recommends having all work on tires or wheels performed by an authorized Audi dealer or authorized Audi Service Facility. These facilities have the proper knowledge and are equipped with the required tools and replacement parts.

- ▶ New tires do not yet have the optimal gripping properties. Drive carefully and at moderate speeds for the first 350 miles (500 km) with new tires.
- ▶ Only use tires with the same design, size (rolling circumference), and as close to the same tread pattern as possible on all four wheels.
- ▶ Do not replace tires individually. At least replace both tires on the same axle at the same time.
- ▶ Audi recommends using Audi Genuine Tires. If you would like to use different tires, please note that the tires may perform ▶

differently even if they are the same size ⇒ ⚠.

- ▶ If you would like to equip your vehicle with a tire and rim combination that is different from what was installed at the factory, consult with an authorized Audi dealer or authorized Audi Service Facility before making a purchase ⇒ ⚠.

Because the spare tire* is different from the regular tires installed on the vehicle (such as winter tires or wide tires), only use the spare tire* temporarily in case of emergency and drive carefully while it is in use. It should be replaced with a regular tire as soon as possible.

Applies to: vehicles with all wheel drive: All four wheels must be equipped with tires that are the same brand and have the same construction and tread pattern so that the drive system is not damaged by different wheel speeds. For this reason, in case of emergency, only use a spare tire* that is the same circumference as the regular tires.



WARNING

- Only use tire/rim combinations and suitable wheel bolts that have been approved by Audi. Otherwise, damage to the vehicle and an accident could result.
- For technical reasons, it is not possible to use tires from other vehicles. In some cases, you cannot even use tires from the same vehicle model.
- Make sure that the tires you select have enough clearance to the vehicle. Replacement tires should not be chosen simply based on the nominal size, because tires with a different construction can differ greatly even if they are the same size. If there is not enough clearance, the tires or the vehicle can be damaged and this can reduce driving safety and increase the risk of an accident.
- Only use tires that are more than six years old when absolutely necessary and drive carefully when doing so.
- Do not use run-flat tires on your vehicle. Using them when

not permitted can lead to vehicle damage or accidents.

- If you install wheel covers on the vehicle, make sure they allow enough air circulation to cool the brake system. If they do not, this could increase the risk of an accident.

Tire wear and damage

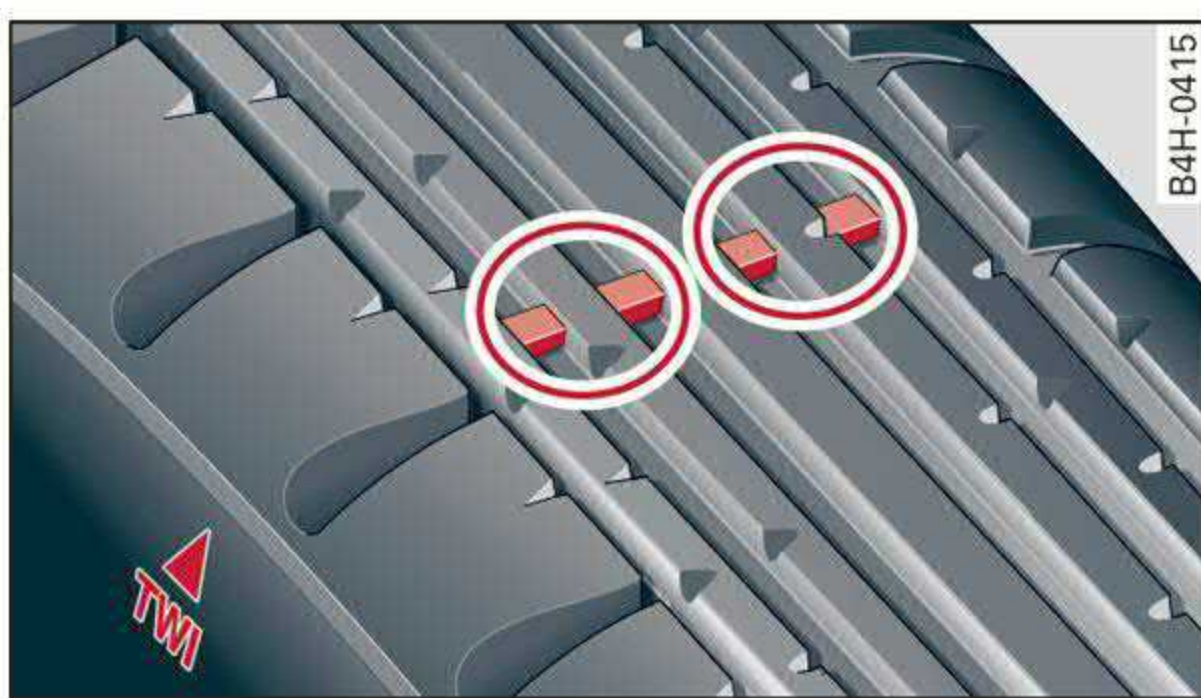

Fig. 153 Tire profile: treadwear indicator

Tire wear

Check the tires regularly for wear.

- Inflation pressure that is too low or high can increase tire wear considerably.
- Driving quickly through curves, rapid acceleration, and heavy braking increase tire wear.
- Have an authorized Audi dealer or authorized Audi Service Facili-

ty check the wheel alignment if there is unusual wear.

- Have the wheels rebalanced if an imbalance is causing noticeable vibration in the steering wheel. If you do not, the tires and other vehicle components could wear more quickly.

Treadwear indicator

Original equipment tires contain treadwear indicators in the tread pattern, which are bars that are 1/16 inch (1.6 mm) high and are spaced evenly around the tire perpendicular to the running direction ⇒ *fig. 153*. The letters “TWI” or triangles on the tire sidewall indicate the location of the treadwear indicators.

The tires have reached the minimum tread depth ¹⁾ when they have worn down to the treadwear indicators. Replace the tires with new ones ⇒ .

Tire rotation

Rotating the tires regularly is recommended to ensure the tires wear evenly. To rotate the tires, ►

¹⁾ Obey any applicable regulations in the country where the vehicle is being operated.

install the tires from the rear axle on the front axle and vice versa. This will allow the tires to have approximately the same length of service life.

For unidirectional tires, make sure the tires are installed according to the running direction indicated on the tire sidewall ⇒ *page 251*.

Hidden damage

Damage to tires and rims can often occur in locations that are hidden. Unusual vibrations in the vehicle or pulling to one side may indicate that there is tire damage. Reduce your speed immediately. Check the tires for damage. If no damage is visible from the outside, drive slowly and carefully to the nearest authorized Audi dealer or authorized Audi Service Facility to have the vehicle inspected.



WARNING

Tread that has worn too low or uneven tread depths on the tires can reduce driving safety. This can increase the risk of an accident because it has a negative effect on handling, driving through curves, and braking,

and because it increases the risk of hydroplaning when driving through deep puddles.

Tire pressure

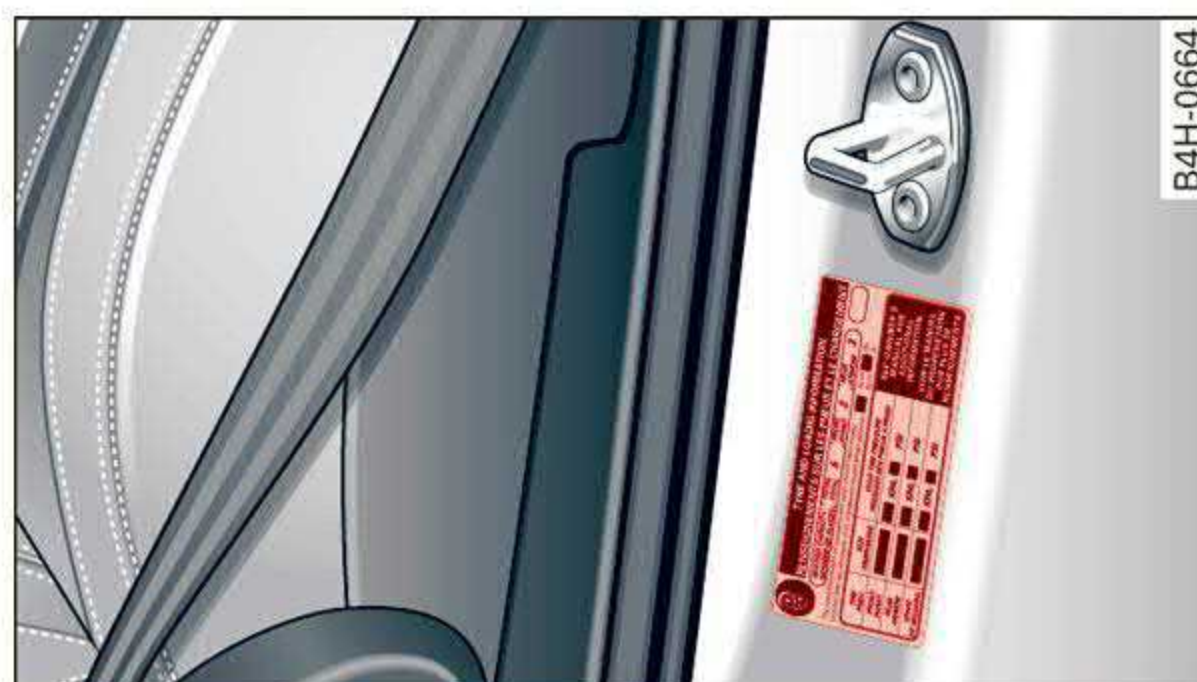

Fig. 154 Driver's side B-pillar: tire pressure label

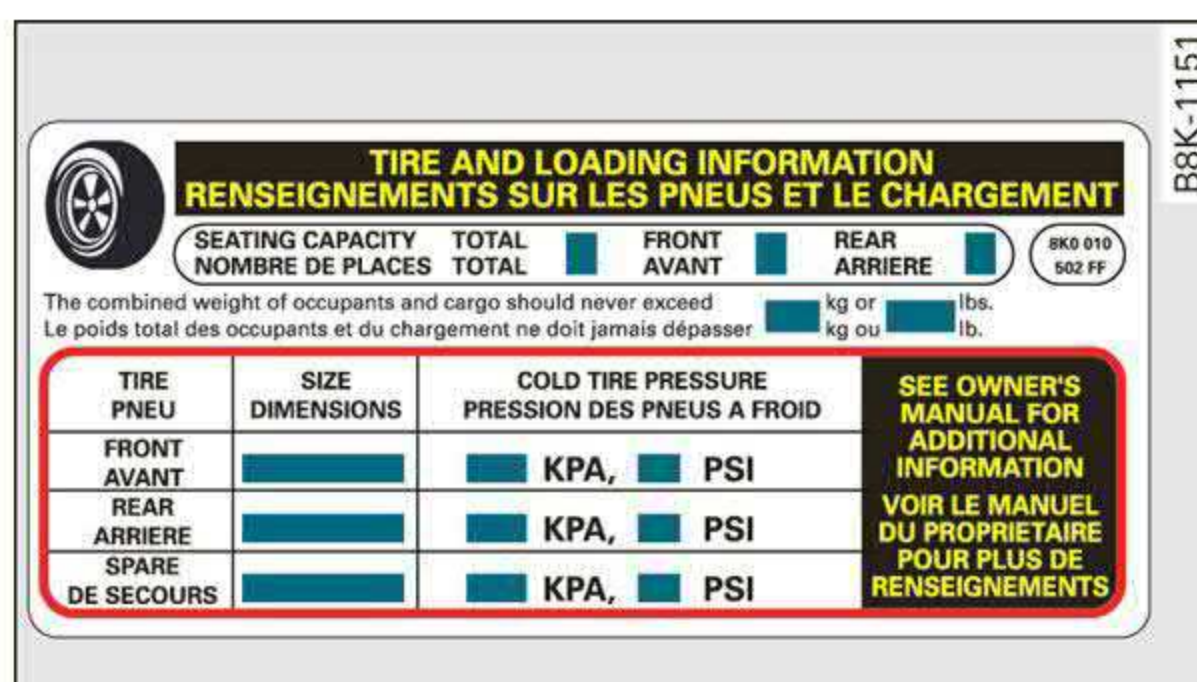

Fig. 155 Tire pressure label

The correct tire pressure for tires installed at the factory is listed on a label. The label is located on the B-pillar (driver's side) ⇒ *fig. 154*, ⇒ *fig. 155*.

Use the tire pressure specified for a normal vehicle load when the vehicle is partially loaded ⇒ *table on page 235*. If driving the vehicle when fully loaded, you must

increase the tire pressure to the maximum specified pressure ⇒ ⚠.

Checking and correcting tire pressure

- ▶ Check the tire pressure at least once per month and also check it before every long drive.
- ▶ Always check the tire pressure when the tires are *cold*. Do not reduce the pressure if it increases when the tires are warm.
- ▶ Refer to the sticker ⇒ *fig. 155* for the correct tire pressure.
- ▶ Correct the tire pressure if necessary.
- ▶ Save the changed tire pressure ⇒ *page 241*.
- ▶ Check the pressure in the spare tire (compact spare tire)*. Always maintain the maximum temperature that is specified for the tire.



WARNING

Always adapt the tire pressure to your driving style and the vehicle load.

–Overloading can lead to loss of vehicle control and increase

the risk of an accident. Read and follow the important safety precautions in ⇒ *page 235*.

- The tire must flex more if the tire pressure is too low or if the vehicle speed or load are too high. This heats the tire up too much. This increases the risk of an accident because it can cause the tire to burst and result in loss of vehicle control.
- Incorrect tire pressure increases tire wear and has a negative effect on driving and braking behavior, which increases the risk of an accident.



Note

Replace lost valve caps to reduce the risk of damage to the tire valves.



For the sake of the environment

Tire pressure that is too low increases fuel consumption.

Tire pressure table

Please note that the information contained in the following table was correct at the time of printing, and the information is subject to change. If there are any differences, you should always follow the tire pressure sticker ⇒ *page 233, fig. 154*.

Make sure that the tire designation on your tire matches the designation on the tire pressure label and the tire pressure table.

The following table lists recommended tire pressures in cold tires according to the load and the size of the tires installed.

Model/ Engine	Tire designation	Tire pressure							
		Normal load (up to 3 people) ^{a)}				Maximum load			
		Front		Rear		Front		Rear	
		PSI	kPA	PSI	kPA	PSI	kPA	PSI	kPA
Q3: 2.0L 4-cylinder	215/65 R17 99H	38	260	38	260	38	260	38	260
	235/55 R18 100H	33	230	33	230	38	260	38	260
	235/55 R18 100V	33	230	33	230	38	260	38	260
	235/50 R19 99H	33	230	33	230	38	260	38	260
	235/50 R19 99V	33	230	33	230	38	260	38	260
	255/45 R19 104Y	33	230	33	230	38	260	38	260
	255/40 R20 101Y	33	230	33	230	38	260	38	260

a) Two people in the front, one person in the rear



WARNING

Please note the important safety precautions regarding tire pressure ⇒ *page 233* and load limits ⇒ *page 235*.

Tires and vehicle load limits

There are limits to the amount of load or weight that any vehicle and any tire can carry. A vehicle that is overloaded will not handle

well and is more difficult to stop. Overloading can not only lead to loss of vehicle control, but can also damage important parts of the vehicle and can lead to sudden tire failure, including a blowout and sudden deflation that can cause the vehicle to crash.

Your safety and that of your passengers also depends on making sure that load limits are not exceeded. Vehicle load includes

everybody and everything in and on the vehicle. These load limits are technically referred to as the vehicle's **Gross Vehicle Weight Rating** ("GVWR").

The "GVWR" includes the weight of the basic vehicle, all factory installed accessories, a full tank of fuel, oil, coolant and other fluids plus maximum load. The maximum load includes the number of passengers that the vehicle is intended to carry ("seating capacity") with an assumed weight of 150 lbs. (68 kg) for each passenger at a designated seating position and the total weight of any luggage in the vehicle. If you tow a trailer, the weight of the trailer hitch and the tongue weight of the loaded trailer must be included as part of the vehicle load.

The **Gross Axle Weight Rating** ("GAWR") is the maximum load that can be applied at each of the vehicle's two axles.

The fact that there is an upper limit to your vehicle's Gross Vehicle Weight Rating means that the total weight of whatever is being carried in the vehicle (including the weight of a trailer hitch and

the tongue weight of the loaded trailer) is limited. The more passengers in the vehicle or passengers who are heavier than the standard weights assumed mean that less weight can be carried as luggage.

The Gross Vehicle Weight Rating and the Gross Axle Weight Rating are listed on the safety compliance sticker label located on the driver's side B-pillar.



WARNING

- Overloading a vehicle can cause loss of vehicle control, a crash or other accident, serious personal injury, and even death.
- Carrying more weight than your vehicle was designed to carry will prevent the vehicle from handling properly and increase the risk of the loss of vehicle control.
 - The brakes on a vehicle that has been overloaded may not be able to stop the vehicle within a safe distance.
 - Tires on a vehicle that has been overloaded can fail suddenly, including a blowout and sudden deflation, causing loss of control and a crash.

–Always make sure that the total load being transported – including the weight of a trailer hitch and the tongue weight of a loaded trailer – does not make the vehicle heavier than the vehicle’s Gross Vehicle Weight Rating.

Determining correct load limit

Use the example below to calculate the total weight of the passengers and luggage or other things that you plan to transport so that you can make sure that your vehicle will not be overloaded.

Steps for Determining Correct Load Limit

1. Locate the statement “THE COMBINED WEIGHT OF OCCUPANTS AND CARGO SHOULD NEVER EXCEED XXX KG OR XXX LBS” on your vehicle’s placard (tire inflation pressure label) ⇒ *page 233, fig. 155.*
2. Determine the combined weight of the driver and passengers that will be riding in your vehicle.
3. Subtract the combined weight of the driver and passengers from “XXX” kilograms or “XXX” pounds shown on the sticker ⇒ *page 233, fig. 155.*
4. The resulting figure equals the available amount of cargo and luggage load capacity. For example, if the “XXX” amount equals 1400 lbs. and there will be five 150 lbs. passengers in your vehicle, the amount of available cargo and luggage load capacity is 650 lbs. (1400-750 (5 x 150) = 650 lbs.)
5. Determine the combined weight of luggage and cargo being loaded on the vehicle. That weight may not safely exceed the available cargo and luggage load capacity calculated in Step 4.
6. If your vehicle will be towing a trailer, load from your trailer will be transferred to your vehicle. Consult this manual to determine how this reduces the available cargo and luggage load capacity of your vehicle. ►

- ▶ Check the tire sidewall (⇒ *page 224, fig. 152*) to determine the designated load rating for a specific tire.

Wheel bolts and rims

Wheel bolts

Wheel bolts must be clean and loosen/tighten easily.

Rims

Rims with a bolted rim ring* or with bolted wheel covers* consist of multiple pieces. These components were bolted together using special bolts and a special procedure. You must not repair or disassemble them ⇒ ⚠.

⚠ WARNING

Wheel bolts that are tightened or repaired incorrectly can become loose and result in loss of vehicle control, which increases the risk of an accident. For the correct tightening specification, see ⇒ *page 251, Finishing*.

- Always keep the wheel bolts and the threads in the wheel hub clean and free of grease.
- Only use wheel bolts that fit the rim.
- Always have damaged rims repaired by an authorized Audi dealer or authorized Audi Service Facility. Never repair or disassemble rims yourself, because this increases the risk of an accident.

Winter tires

Winter tires significantly improve the vehicle's handling when driving in winter conditions. Because of their construction (width, compound, tread pattern), summer tires provide less traction on ice and snow.

- ▶ Use winter tires on all four wheels.
- ▶ Only use winter tires that are approved for your vehicle.
- ▶ Please note that the maximum permitted speed may be lower with winter tires ⇒ ⚠ in *General information on page 223*. An author-

ized Audi dealer or authorized Audi Service Facility can inform you about the maximum permitted speed for your tires.

- ▶ Check the tire pressure after installing wheels ⇒ *page 233*.

The effectiveness of winter tires is reduced greatly when the tread is worn down to a depth of 0.16 in (4 mm). The characteristics of winter tires also decrease greatly as the tire ages, regardless of the remaining tread.



For the sake of the environment

Reinstall summer tires at the appropriate time, because they provide better handling when roads are free of snow and ice. Summer tires cause less road noise, tire wear, and fuel consumption.



Tips

You can also use all season tires instead of winter tires. Please note that in some countries where winter tires are required, only winter tires with the ⚠ symbol may be permitted.

Snow chains

Snow chains improve both driving and braking in winter road conditions.

- ▶ Only install snow chains on the front wheels.
- ▶ Check and correct the seating of the snow chains after driving a few feet, if necessary. Follow the instructions from the manufacturer.
- ▶ Note the maximum speed of 30 mph (50 km/h). Observe the local regulations.

Use of snow chains is only permitted with certain rim/tire combinations due to technical reasons. Check with an authorized Audi dealer or authorized Audi Service Facility to see if you may use snow chains.

Use **fine-mesh snow chains**. They must not add more than 0.40 inch (10.5 mm) in height, including the chain lock.

You must remove the snow chains on roads without snow. Otherwise, you could impair driving ability and damage the tires.

! WARNING

Using incorrect snow chains or installing snow chains incorrectly can result in loss of vehicle control, which increases the risk of an accident.

! Note

Snow chains can damage the rims and wheel covers* if the chains come into direct contact with them. Remove the wheel covers* first. Use coated snow chains.

i Tips

When using snow chains, it may be advisable to limit the ESC ⇒ *page 101*.

Low-profile tires

Applies to: vehicles with low-profile tires

Compared to other tire/rim combinations, low-profile tires offer a wider tread surface and a larger rim diameter with shorter tire sidewalls. This results in an agile driving style. However, it may reduce the level of comfort and increase road noise when driving on roads in poor condition.

Low-profile tires can become damaged more quickly than standard tires when driving over large bumps, potholes, manhole covers, and curbs. Therefore, it is particularly important to maintain the correct tire pressure ⇒ *page 233*.

To reduce the risk of damage to the tires and rims, drive very carefully on poor roads.

Check your wheels regularly every 2,000 mi (3,000 km) for damage. For example, check for bulges/cracks on the tires or deformations/cracks on the rims.

After a heavy impact or damage, have the tires and rims inspected or replaced immediately by an authorized Audi dealer or authorized Audi Service Facility.

Low-profile tires can wear out faster than standard tires.

Uniform tire quality grading

- Tread wear
- Traction AA A B C
- Temperature A B C

Quality grades can be found where applicable on the tire side wall between tread shoulder and maximum section width ⇒ *page 224, fig. 152*.

For example: Tread wear **200**, Traction **AA**, Temperature **A**.

All passenger car tires must conform to Federal Safety Requirements in addition to these grades.

Tread wear

The *tread wear* grade is a comparative rating based on the wear rate of the tire when tested under controlled conditions on a specified government test course.

For example, a tire graded 150 would wear one and one half (1 1/2) times as well on the government course as a tire graded 100.

The relative performance of tires depends upon the actual conditions of their use, however, and may depart significantly from the norm due to variations in driving habits, service practices and differences in road characteristics and climate.

Traction

The *traction* grades, from highest to lowest, are AA, A, B and C. Those grades represent the tire's ability to stop on wet pavement as measured under controlled conditions on specified government test surfaces of asphalt and concrete. A tire marked C may have poor traction performance ⇒ .

Temperature

The *temperature* grades are A (the highest), B, and C, representing the tire's resistance to the generation of heat and its ability to dissipate heat when tested under controlled conditions on a specified indoor laboratory test wheel.

Sustained high temperature can cause the material of the tire to degenerate and reduce tire life, and excessive temperature can lead to sudden tire failure ⇒ .

The grade C corresponds to a level of performance which all passenger car tires must meet under the Federal Motor Vehicle Safety Standard No. 109. Grades B and A represent higher levels of performance on the laboratory test wheel than the minimum required by law.

WARNING

The traction grade assigned to this tire is based on straight-ahead braking traction tests, and does not include acceleration, cornering, hydroplaning or peak traction characteristics.

WARNING

The temperature grade for this tire is established for a tire that is properly inflated and not overloaded. Excessive speed, underinflation, or excessive loading, either separately or in combination, can cause heat buildup and possible tire failure.

WARNING

Temperature grades apply to tires that are properly inflated and not over or underinflated.

Tire pressure monitoring system

General notes

Each tire, including the spare (if provided), should be checked monthly when cold and inflated to the inflation pressure recommended by the vehicle manufacturer on the vehicle placard or tire inflation pressure label. (If your vehicle has tires of a different size than the size indicated on the vehicle placard or tire inflation pressure label, you should determine the proper tire inflation pressure for those tires).

As an added safety feature, your vehicle has been equipped with a tire pressure monitoring system (TPMS) that illuminates a low tire pressure telltale when one or more of your tires is significantly under-inflated. Accordingly, when the low tire pressure telltale illuminates, you should stop and

check your tires as soon as possible, and inflate them to the proper pressure. Driving on a significantly under-inflated tire causes the tire to overheat and can lead to tire failure. Under-inflation also reduces fuel efficiency and tire tread life, and may affect the vehicle's handling and stopping ability.

Please note that the TPMS is not a substitute for proper tire maintenance, and it is the driver's responsibility to maintain correct tire pressure, even if under-inflation has not reached the level to trigger illumination of the TPMS low tire pressure telltale.

Your vehicle has also been equipped with a TPMS malfunction indicator to indicate when the system is not operating properly. The TPMS malfunction indicator is combined with the low tire pressure telltale. When the system detects a malfunction, the telltale will flash for approximately one minute and then remain continuously illuminated. This sequence will continue upon subsequent vehicle start-ups as long as the malfunction exists.

When the malfunction indicator is illuminated, the system may not be able to detect or signal low tire pressure as intended. TPMS malfunctions may occur for a variety of reasons, including the installation of replacement or alternate tires or wheels on the vehicle that prevent the TPMS from functioning properly. Always check the TPMS malfunction telltale after replacing one or more tires or wheels on your vehicle to ensure that the replacement or alternate tires and wheels allow the TPMS to continue to function properly.

If the tire pressure monitoring indicator appears

The tire pressure indicator in the instrument cluster informs you if the tire pressure is too low or if there is a system malfunction.

Using the ABS sensors, the tire pressure monitoring system compares the tire tread circumference and vibration characteristics of the individual tires. If the pressure changes in one or more tires, this is indicated in the instrument cluster ►



display with an indicator light  and a message. If only one tire is affected, the location of that tire will be indicated.

The tire pressures must be stored again each time you change the pressures (switching between partial and full load pressure) or after changing or replacing a tire on your vehicle ⇒ *page 241*. The tire pressure monitoring system only monitors the tire pressure you have stored. Refer to the tire pressure label for the recommended tire pressure for your vehicle ⇒ *page 233, fig. 155*.

Tire tread circumference and vibration characteristics can change and cause a tire pressure warning if:

- The tire pressure in one or more tires is too low
- The tires have structural damage
- The tire was replaced or the tire pressure was changed and it was not stored ⇒ *page 241*
- Tires that are only partially used are replaced with new tires

Indicator lights

If the  indicator light turns on, there is a loss of pressure in at least one tire. ⇒  Check the tires and replace or repair if necessary. Check and correct the pressures of all four tires and store the pressure again ⇒ *page 241*.

TPMS Tire pressure: malfunction! See owner's manual

If **TPMS** appears after switching the ignition on or while driving and the  indicator light in the instrument cluster blinks for approximately one minute and then stays on, there is system malfunction. Try to store the correct tire pressures ⇒ *page 241*. In some cases, you must drive for several minutes after storing the pressures until the indicator light turns off. If the indicator light does turn off or turns on again after a short period of time, drive to an authorized Audi dealer or authorized Audi Service Facility immediately to have the malfunction corrected.

WARNING

- If the tire pressure indicator appears in the display, reduce your speed immediately and

avoid any hard steering or braking maneuvers. Stop as soon as possible and check the tires and their pressure.

- The driver is responsible for maintaining the correct tire pressure. You must check the tire pressure regularly.
- Under certain conditions (such as a sporty driving style, winter conditions, or unpaved roads), the tire pressure monitoring system indicator may be delayed.

Tips

- The tire pressure monitoring system can also stop working when there is an ESC malfunction.
- Using snow chains may result in a system malfunction.
- The tire pressure monitoring system in your Audi was calibrated with “Audi Original Tires” ⇒ *page 230*. Audi recommends using these tires.

Storing tire pressures

If the tire pressure changes or a tire is replaced, it must be confirmed in the system.

- ▶ Before storing the tire pressures, make sure the tire pressures in all four tires meet the specified values and are adapted to the load ⇒ *page 233*.
- ▶ Switch the ignition on.
- ▶ Applies to MMI: Select on the home screen: **VEHICLE > Settings & Service > Tire pressure monitoring > Store tire pressure > Yes, store now**.

Tips

Do not store the tire pressures if snow chains are installed.

Care and cleaning

General information

Regular, proper care helps to maintain your vehicle's value. It can also be a requirement when submitting warranty claims for corrosion damage and paint defects on the body.

The required cleaning and care products can be obtained from an authorized Audi dealer or authorized Service Facility. Read and follow the instructions for use on the packaging.

WARNING

- Using cleaning and care products incorrectly can be dangerous to your health.
- Always store cleaning and care products out of reach of children to reduce the risk of poisoning.

For the sake of the environment

- Purchase environmentally-friendly cleaning products if possible.
- Do not dispose of cleaning and care products with household trash.

Car washes

The longer that deposits such as insects, bird droppings, tree sap or road salt remain on the vehicle, the more the surface can be damaged. High temperatures such as those caused by sunlight increase the damaging effect.

Before washing, rinse off heavy deposits with plenty of water.

Stubborn deposits such as bird droppings or tree sap are best removed with plenty of water and a microfiber cloth.

Also, wash the underside of your vehicle once road salt stops being used for the season.

Pressure washers

When washing your vehicle with a pressure washer, always follow the operating instructions provided with the pressure washer. This is especially important in regard to the pressure and spraying distance. Do not aim the spray directly at the

seals on the side windows, doors, lids or the sun-roof* or at tires, rubber hoses, insulating material, sensors* or camera lenses*. Keep a distance of at least 16 inches (40 cm).

Do not remove snow and ice with a pressure washer.

Never use cone nozzles or high pressure nozzles.

The water temperature must not be above 140 °F (60 °C).

Automatic car wash

Spray off the vehicle before washing.

Make sure that the windows and roof* are closed and the windshield wipers are off. Make sure that the vehicle is still able to roll during the washing process in the car wash. Follow instructions from the car wash operator, especially if there are accessories attached to your vehicle.

If possible, use car washes that do not have brushes.

Washing by hand

Clean the vehicle starting from the top and working downward using a soft sponge or cleaning brush. Use solvent-free cleaning products.

Washing vehicles with matte finish paint by hand

To reduce the risk of damaging the paint when washing, first remove dust and large particles from your vehicle. Insects, grease spots, and fingerprints are best removed with a special cleaner for matte finish paint.

Apply the product using a microfiber cloth. To reduce the risk of damaging the paint surface, do not use too much pressure.

Rinse the vehicle thoroughly with water. Then clean using a neutral shampoo and a soft microfiber cloth.

Rinse the vehicle thoroughly again and let it air dry. Remove any water residue using a chamois.

WARNING

- To reduce the risk of accidents, only wash the vehicle when the ignition is off and

- follow the instructions from the car wash operator.
- To reduce the risk of cuts, protect yourself from sharp metal components when washing the underbody or the inside of the wheel housings.
 - After washing the vehicle, the braking effect may be delayed due to moisture on the brake rotors or ice in the winter. This increases the risk of an accident. The brakes must be dried with a few careful brake applications.

Note

- If you wash the vehicle in an automatic car wash, you must fold the exterior mirrors in to reduce the risk of damage to the mirrors. Power folding exterior mirrors* must only be folded in and out using the power folding function.
- To reduce the risk of damage to the rims and tires, compare the width between the wheels on your vehicle with the distance between the guide rails in the car wash.
- To reduce the risk of damage, compare the height and width of your vehicle with the height and width of the inside of the car wash.

- To reduce the risk of paint damage, do not wash the vehicle in direct sunlight.
- To reduce the risk of damage, do not wash decorative decals* with a pressure washer.
- To reduce the risk of damage to the surface, do not use insect removing sponges, kitchen sponges, or similar items.
- When washing matte finish painted vehicle components:
 - To reduce the risk of damage to the surface, do not use polishing agents or hard wax.
 - Never use protective wax. It can destroy the matte finish effect.
 - Do not place any stickers or magnetic signs on vehicle components painted with matte finish paint. The paint could be damaged when the stickers or magnets are removed.



For the sake of the environment

Only wash the vehicle in facilities specially designed for that purpose. This will reduce the risk of dirty water contaminated with oil from entering the sewer system.

Cleaning and care information

When cleaning and caring for individual vehicle components, refer to the following tables. The information contained there is simply recommendations. For questions or for components that

are not listed, consult an authorized Audi dealer or authorized Audi Service Facility. Also follow the information found in .

Exterior cleaning

Component	Situation	Solution
Windshield wiper blades	Deposits	Soft cloth with glass cleaner,  page 51
Headlights/ tail lights	Deposits	Soft sponge with a mild soap solution ^{a)}
Sensors/ camera lenses	Deposits	Sensors: soft cloth with a solvent-free cleaning product Camera lenses: soft cloth with an alcohol-free cleaning solution
	Snow/ice	Hand brush/solvent-free de-icing spray

Care and cleaning

Component	Situation	Solution
Wheels	Road salt	Water
	Brake dust	Acid-free special cleaning solution
Exhaust tail pipes	Road salt	Water, cleaning solution suitable for stainless steel, if necessary
Decorative parts and trim	Deposits	Mild soap solution ^{a)} , a cleaning solution suitable for stainless steel, if necessary
Paint	Paint damage	Repair with touch-up paint
	Spilled fuel	Rinse with water immediately
	Surface rust	Rust remover, then treat with hard wax; for questions, consult an authorized Audi dealer or authorized Audi Service Facility.
	Corrosion	Have it removed by an authorized Audi dealer or authorized Audi Service Facility.
	Water no longer beads on the surface of clean paint	Treat with hard wax (at least twice per year)
	No shine even though paint has been protected/paint looks poor	Treat with suitable polish; then apply paint protectant if the polish that was used does not contain any protectant
	Deposits such as insects, bird droppings, tree sap, and road salt	Dampen with water immediately and remove with a micro-fiber cloth
	Grease-based contaminants such as cosmetics or sunblock	Remove immediately with a mild soap solution ^{a)} and a soft cloth
Carbon components	Deposits	clean the same way as painted parts ⇒ <i>page 242</i>
Decorative decals	Deposits	Soft sponge with a mild soap solution ^{a)}

^{a)} Mild soap solution: maximum two tablespoons of neutral soap in 1 quart (1 liter) of water

Interior cleaning

Component	Situation	Solution
Window glass	Deposits	Glass cleaner, then wipe dry
Decorative parts and trim	Deposits	Mild soap solution ^{a)}
Plastic parts	Deposits	Damp cloth
	Heavier deposits	Mild soap solution ^{a)} , detergent-free plastic cleaning solution, if necessary

Component	Situation	Solution
Displays/instrument cluster	Deposits	Soft cloth with LCD cleaner; dust in the lower area of the instrument cluster can be removed using a soft brush.
Controls	Deposits	Soft brush, then a soft cloth with a mild soap solution ^{a)}
Safety belts	Deposits	Mild soap solution ^{a)} , allow to dry before letting them retract
Textiles, artificial leather, Alcantara	Deposits adhering to the surface	Vacuum cleaner
	Water-based deposits such as coffee, tea, blood, etc.	Absorbent cloth and mild soap solution ^{a)}
	Oil-based deposits such as oil, make-up, etc.	Apply a mild soap solution ^{a)} , blot away the dissolved oil or dye, treat afterward with water, if necessary
	Certain types of deposits such as ink, nail polish, latex paint, shoe polish, etc.	Special stain remover, blot with absorbent material, treat afterward with mild soap solution, if necessary ^{a)}
Natural leather	Fresh stains	Cotton cloth with a mild soap solution ^{a)}
	Water-based deposits such as coffee, tea, blood, etc.	Fresh stains: absorbent cloth dried stains: stain remover suitable for leather
	Oil-based deposits such as oil, make-up, etc.	Fresh stains: absorbent cloth and stain remover suitable for leather dried stains: oil cleaning spray
	Certain types of deposits such as ink, nail polish, latex paint, shoe polish, etc.	Spot remover suitable for leather
	Care	Regularly apply conditioning cream that protects from light and penetrates into the material. Use special colored conditioning cream, if necessary.
Carbon components	Deposits	Clean the same way as plastic components

^{a)} Mild soap solution: maximum two tablespoons of neutral soap in 1 quart (1 liter) of water

WARNING

The windshield must not be treated with water-repelling windshield coating agents. Under unfavorable conditions, such as wetness, darkness, and when the sun is low, these coatings can cause increased glare, which increases

es the risk of an accident. They can also cause wiper blade chatter.

Note

– **Headlights and tail lights**

- Never clean the headlights or tail lights with a dry cloth or sponge because the lights could be damaged.
- Do not use any cleaning products that contain alcohol, because they could cause cracks to form.
- **Wheels**
 - Never use any paint polish or other abrasive materials.
 - Damage to the protective layer on the rims, such as stone chips or scratches, must be repaired immediately.
- **Camera lenses**
 - Never use warm or hot water to remove snow or ice from the camera lens. This could cause the lens to crack.
 - Never use abrasive cleaning materials or alcohol to clean the camera lens. This could cause scratches and cracks.
- **Door windows**
 - Remove snow and ice on windows and exterior mirrors with a plastic scraper. To reduce the risk of scratches, move the scraper only in one direction and not back and forth.
 - Never remove snow or ice from door windows and mirrors using warm or hot water because this could cause cracks to form.
 - To reduce the risk of damage to the rear window defogger, do not apply any stickers on the heating wires on the inside of the window.
- **Decorative parts and trim**
 - Never use chrome care or cleaning products.
- **Paint**
 - To reduce the risk of scratches, the vehicle must be free of dirt and dust before polishing or waxing.
 - To prevent paint damage, do not polish or wax the vehicle in direct sunlight.
 - To reduce the risk of paint damage, do not polish away rust spots.
 - Remove cosmetics and sunscreen immediately because they could damage the paint.
- **Decorative decals**
 - To reduce the risk of damage, do not use any rough powder or abrasive cleaning products.
 - To reduce the risk of damage, do not polish decorative decals that have a matte or printed finish.
 - Due to the risk of damage, do not use an ice scraper to remove snow and ice on windows with decorative decals on them.
- **Displays and instrument cluster**
 - Make sure that the display and instrument cluster are switched off and have cooled down before cleaning. To switch off the center display, select on the MMI home screen: **SETTINGS > Display & brightness > MMI > Screen cleaning**.
 - Displays, the instrument cluster, and the trim surrounding it must not be cleaned with dry cleaning methods because they could become scratched.
 - Make sure no fluids enter the spaces between the instrument cluster and the trim, because that could cause damage.
- **Controls**
 - Make sure that no fluids enter the controls, because this could cause damage.
- **Safety belts**
 - Do not remove the safety belts to clean them.
 - Never clean safety belts or their components with chemicals or with corrosive fluids or solvents and never allow sharp objects to come into contact with the safety belts. This could cause damage to the belt webbing.
 - If there is damage to the webbing, the connections, the retractors, or the buckles, have them replaced by an authorized Audi dealer or authorized Audi Service Facility.
- **Textiles, artificial leather, and Alcantara**
 - Never treat artificial leather or Alcantara with leather care products, solvents, floor polish, shoe polish, spot remover, or similar products.
 - Have a cleaning specialist remove stubborn stains to reduce the risk of damage.

- Never use steam cleaners, brushes, hard sponges, etc. when cleaning.
- Do not turn on the seat heating* to dry the seat.
- Objects with sharp edges, such as zippers or rivets on clothing or belts, can cause damage to the surface.
- Open hook and loop fasteners, for example on clothing, can damage seat covers. Make sure hook and loop fasteners are closed.
- **Natural leather**
 - Never treat leather with solvents, floor polish, shoe polish, spot remover or similar products.
 - Objects with sharp edges, such as zippers or rivets on clothing or belts, can cause damage to the surface.
 - Never use steam cleaners, brushes, hard sponges, etc. when cleaning.
 - Do not turn on the seat heating* to dry the seat.
 - To help prevent the leather from fading, do not leave the vehicle in direct sunlight for long periods of time. If leaving the vehicle parked for long periods of time, you should cover the leather to protect it from direct sunlight.

ing the vehicle out of service (duration, location, etc.).

Tips

- Insects are easier to remove from paint that has been freshly waxed.
- Regular waxing can prevent rust spots from forming.
- Decorative decals can age due to environmental conditions, which can result in damage such as brittleness. The color may fade if exposed to excessive sunlight.

Taking your vehicle out of service

If you would like to take your vehicle out of service for a long period of time, contact an authorized Audi dealer or authorized Audi Service Facility. You can receive information about the measures to take depending on the conditions for tak-

Emergency assistance

General information

- ▶ Park the vehicle as far as possible from moving traffic in the event of a breakdown. In the event of a flat tire, park the vehicle on a level surface. If you are on a steep hill, be especially careful.
- ▶ Set the parking brake.
- ▶ Switch the emergency flashers on.
- ▶ Have the passengers exit the vehicle. They should move to a safe place, for example behind a guard rail.

WARNING

Follow the steps given above. This is for your protection and the for the safety of others on the road.

Equipment

Vehicle tool kit/vehicle jack

Applies to: vehicles with the vehicle tool kit and vehicle jack



Fig. 156 Luggage compartment: cargo floor cover

The vehicle tools and vehicle jack* are stored in the luggage compartment under the floor cover.

- ▶ Lift up the cargo floor with the plastic handle until it is clamped behind the tabs on both side panels.
- ▶ If necessary, lift out the center floor panel.

Applies to: vehicles with spare tire/subwoofer

- ▶ Turn the handwheel counter-clockwise and remove it.
- ▶ Remove the subwoofer* ⇒ page 251.
- ▶ Remove the spare tire*.

Tips

The vehicle jack* does not require any maintenance.

Changing a tire

Preparation

You must complete the preparation before changing a tire.

- ▶ Read and follow the important safety precautions ⇒ page 248.
- ▶ Set the parking brake.
- ▶ Select the “P” position.
- ▶ When towing a trailer: disconnect the trailer from your vehicle.
- ▶ Lay out the vehicle tool kit ⇒ page 248 and the spare tire ⇒ page 251.
- ▶ Switch the ignition off.

WARNING

The vehicle must also be secured to prevent it from rolling when using the vehicle jack*. Use suitable objects to block the front and back of the wheel that is diagonal from the wheel with the flat tire.

Removing the cover



Fig. 157 Wheel: wheel bolts with caps

- ▶ Slide the plastic clip from the vehicle tool kit onto the cap until it engages ⇒ fig. 157.
- ▶ Remove the cap with the plastic clip.

Anti-theft wheel bolts

Applies to: vehicles with anti-theft wheel bolts

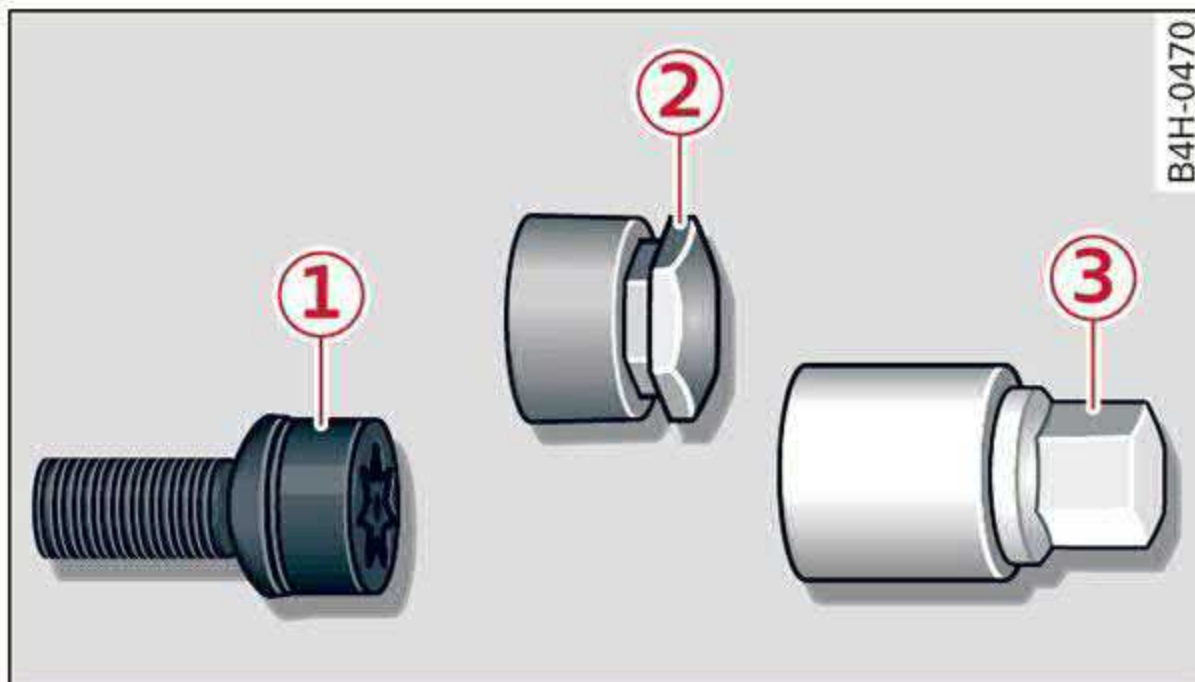

Fig. 158 Anti-theft wheel bolt with cap and adapter

You need a special adapter in the vehicle tool kit to remove the anti-theft wheel bolts.

- ▶ Remove the cap ②.
- ▶ Slide the adapter ③ all the way onto the anti-theft wheel bolt ①.
- ▶ Slide the wheel wrench* from the vehicle tool kit all the way onto the adapter ③.
- ▶ Loosen the wheel bolt ⇒ *page 249*.

i Tips

Note the code number for the wheel bolt adapter and store it in a safe place separate from the vehicle. If you need a replacement adapter, contact an authorized Audi dealer or authorized Audi Service Facility and give them the code number.

Loosening the wheel bolts



Fig. 159 Wheel: loosening the wheel bolts

- ▶ Slide the wheel wrench* from the vehicle tool kit all the way onto the wheel bolt¹⁾.
- ▶ Turn the wheel bolt approximately one turn to the left. To achieve the required torque, hold the end of the wheel wrench*. If the wheel bolt will not loosen, press carefully on the wheel wrench* with your foot. Hold onto the vehicle securely while doing this and make sure your footing is stable.

! WARNING

To reduce the risk of an accident, only loosen the wheel bolts gently one turn before raising the vehicle with the vehicle jack*.

Raising the vehicle

Applies to: vehicles with vehicle jack

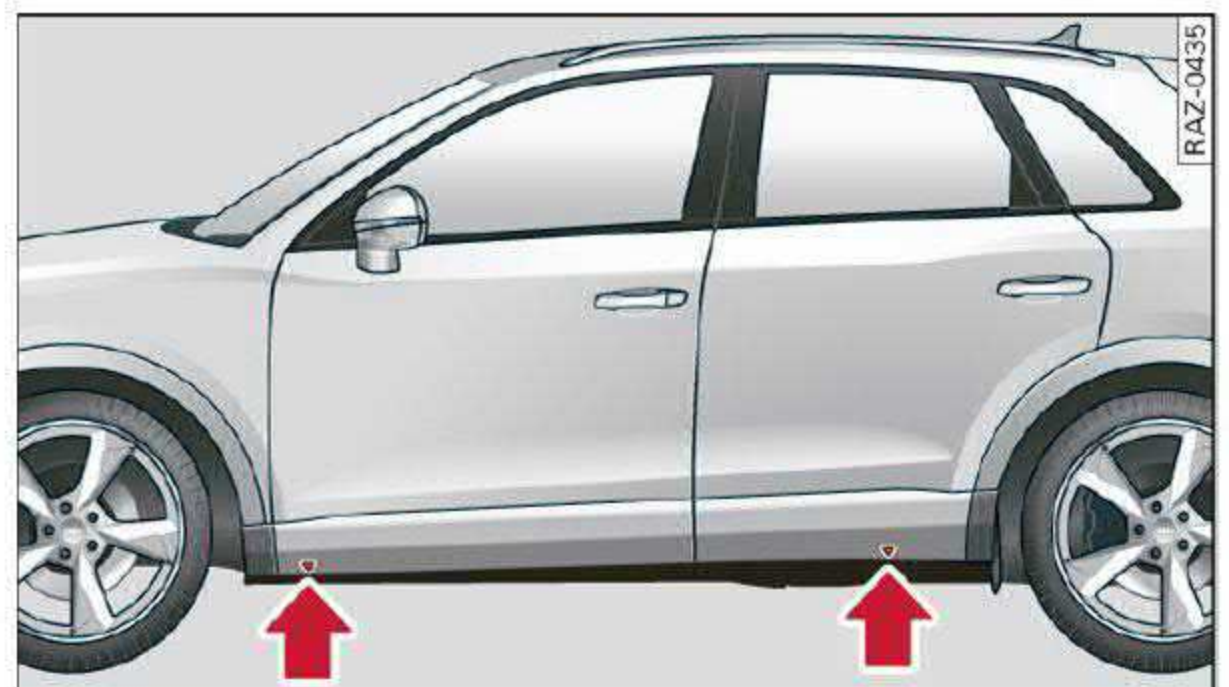

Fig. 160 Sill panels: markings

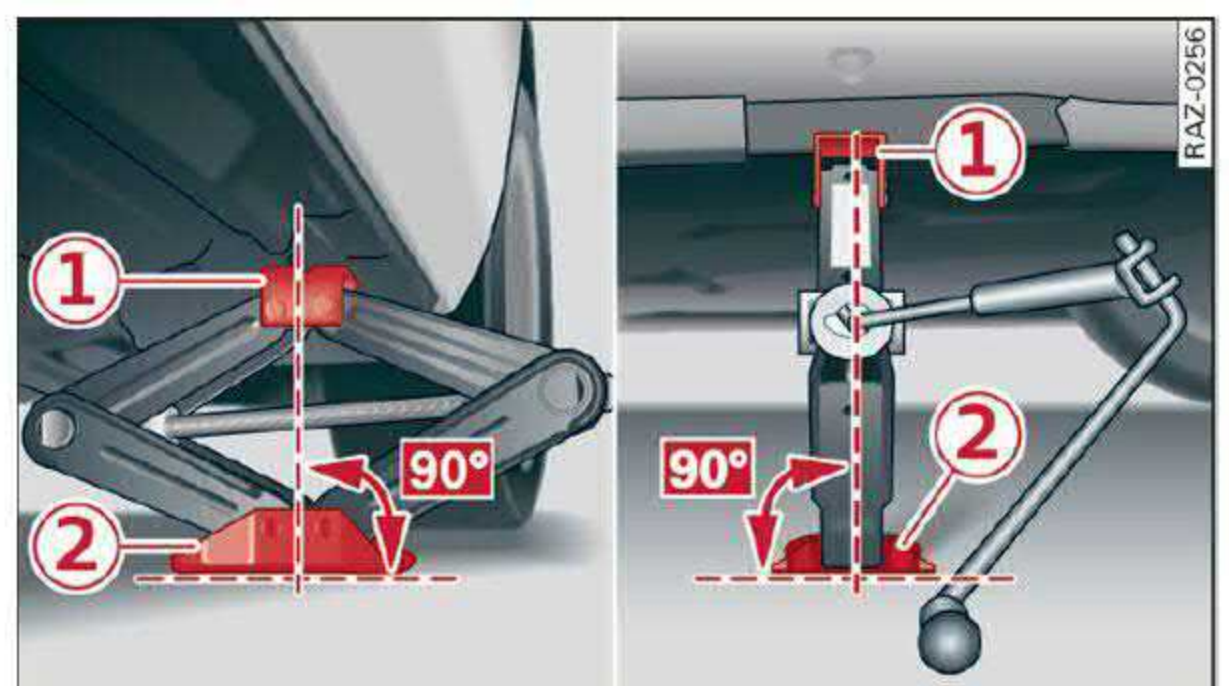

Fig. 161 Sill: positioning the vehicle jack

- ▶ Place the vehicle jack from the vehicle tool kit on a firm surface. Use a flat, stable support if necessary. On a slippery surface such as tile, you should use a non-slip pad such as a rubber mat ⇒ **!**

¹⁾ You need the matching adapter in order to loosen and tighten anti-theft wheel bolts* ⇒ *page 249*.

- ▶ Find the marking on the sill that is closest to the tire that will be changed ⇒ *fig. 160*. Behind the marking, there is a lifting point on the side sill for the vehicle jack.
- ▶ Raise the vehicle jack under the lifting point on the side sill until the bracket on the jack ① completely covers the notch on the vehicle.
- ▶ Align the vehicle jack so the bracket ① covers the notch and the base ② is flat on the ground. The base ② must be directly under the mounting point ①.
- ▶ Mount the crank on the vehicle jack: insert the crank into the opening on the handwheel. Turn the crank to the left or right to secure it.
- ▶ Continue raising the vehicle jack with the crank until the wheel lifts off the ground slightly.

WARNING

- To reduce the risk of injury, make sure no one is in the vehicle before raising it.
- Make sure the vehicle jack is stable. The risk of injury is increased when the ground is slippery or soft, because the vehicle jack could slide or sink.
- Only raise your vehicle with the vehicle jack provided by the factory. If you use a vehicle jack designed for another vehicle, your vehicle could slip and cause injury.
- Position the vehicle jack only at the designated mounting points on the side sill and align the jack. Otherwise, the vehicle jack could slip and cause an injury if it does not have sufficient hold on the vehicle.
- To reduce the risk of injury, do not raise any other vehicles or other loads using the vehicle jack provided by the factory.
- To reduce the risk of an accident, never start the engine when the vehicle is raised.
- To reduce the risk of injury, no work should be performed under the vehicle while it is raised.

Note

Do not lift the vehicle by the sill. Position the vehicle jack only at the designated mounting points on the side sill. Otherwise, your vehicle could be damaged.

Removing and installing a wheel



Fig. 162 Wheel: internal hex socket to turn the wheel bolts



Fig. 163 Wheel: alignment pin in the top hole

Removing a wheel

- ▶ Remove the top wheel bolt completely using the hex socket in the screwdriver handle from the vehicle tool kit ⇒ *fig. 162* and place it on a clean surface.
- ▶ Then install the alignment pin from the vehicle tool kit in the empty wheel bolt hole by hand ⇒ *fig. 163*.
- ▶ Remove the rest of the wheel bolts.
- ▶ Remove the wheel ⇒ . The alignment pin remains in the hole while doing this.

Installing a wheel

Read the directions on ⇒ *page 251* when installing unidirectional tires.

- ▶ Slide the wheel on over the alignment pin ⇒ .
- ▶ Install the wheel bolts and tighten them gently using the hex socket.
- ▶ Remove the alignment pin and tighten the remaining wheel bolt.
- ▶ Carefully lower the vehicle using the vehicle jack*.
- ▶ Tighten the wheel bolts in a diagonal pattern using the wheel wrench*.

The wheel bolts must be clean and loosen and tighten easily. Check the contact surfaces for the wheel and hub. Contaminants on these surfaces must be removed before installing the wheel.

WARNING

- Read and follow the important information and notes under ⇒ *page 230*.
- Never use the hex socket in the screwdriver handle to tighten the wheel bolts. Using the hex socket will not achieve the required tightening torque, which increases the risk of an accident.

Note

When removing or installing the wheel, the rim could hit the brake rotor and damage the rotor. Work carefully and have a second person help you.

Unidirectional tires

A unidirectional tire profile is identified by arrows on the tire sidewall that point in the running direction. You must always maintain the specified running direction. This is necessary to ensure the tire's optimal performance in regard to adhesion, running noise, and friction, and to reduce the risk of hydroplaning.

To benefit fully from the advantages of the unidirectional tire design, you should replace faulty tires as soon as possible and restore the correct running direction on all of the tires.

Finishing

- ▶ Reinstall the caps on the wheel bolts if necessary.
- ▶ Store the vehicle tool kit in its designated place.
- ▶ If the removed wheel does not fit in the spare wheel well, store it securely in the luggage compartment ⇒ *page 75*.
- ▶ Check the tire pressure on the installed wheel as soon as possible.
- ▶ Correct the tire pressure and store it ⇒ *page 241*.

- ▶ The wheel bolt tightening specification must be 100 ft lbs (140 Nm). Have it checked as soon as possible with a torque wrench. Drive carefully until then.
- ▶ Have the faulty wheel replaced as quickly as possible.

Spare tire

Removing the subwoofer

Applies to: vehicles with subwoofer

The subwoofer must be removed before the spare tire/temporary spare tire* can be removed.*

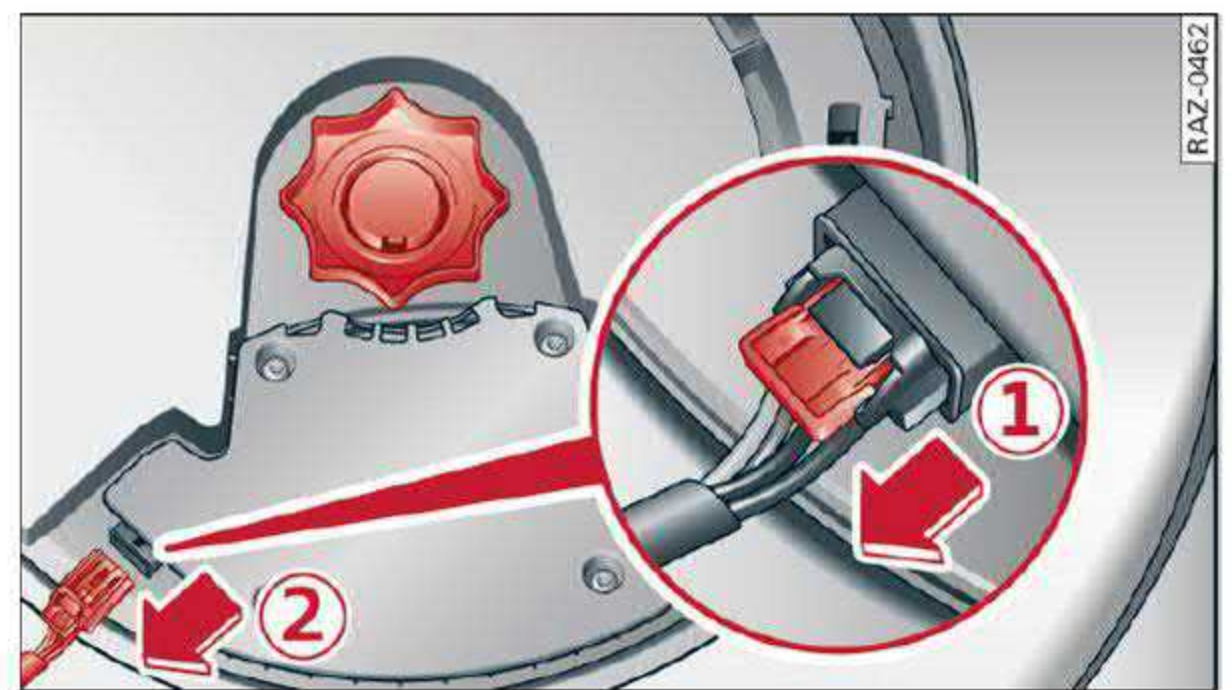

Fig. 164 Spare tire well: subwoofer

Removing the subwoofer

- ▶ Pull out the red connector lock ①.
- ▶ Remove the connector ② and set the disconnected cable aside.
- ▶ Turn the handwheel counter-clockwise and remove it.
- ▶ Carefully remove the subwoofer.

Installing the subwoofer

- ▶ Carefully place the subwoofer in the rim well. The word "FRONT" on the subwoofer must face forward.
- ▶ Insert the connector that was removed.
- ▶ Secure the subwoofer with the handle.

Space-saving spare tire

Applies to: vehicles with space-saving spare tire (compact spare tire)

The spare tire is intended for short-term use only. Have the damaged tire checked and replaced if necessary by an authorized Audi dealer or authorized Audi Service Facility as soon as possible. ▶

Emergency assistance

There are some restrictions on the use of the compact spare tire. The compact spare tire has been designed specifically for your type of vehicle. Do not replace it with the spare tire from another type of vehicle.

The compact spare tire is located in the luggage compartment under the cargo floor cover
⇒ *page 248*.

The tire pressure must be adjusted to a specified value listed on the tire pressure sticker
⇒ *page 233, fig. 155*.

Snow chains

For technical reasons, the use of snow chains on the compact spare tire is not permitted.

If you have to drive with snow chains and a front tire fails, mount the spare tire in place of a rear tire. Install the snow chains on the rear tire that you removed, and install that in place of the front tire that failed.

WARNING

- After installing a spare tire, the tire pressure must be checked as soon as possible.
- Do not drive faster than 50 mph (80 km/h) with a compact spare tire. Driving faster than that increases the risk of an accident.
- To reduce the risk of an accident, avoid hard acceleration or braking and driving fast around curves with the compact spare tire.
- To reduce the risk of an accident, never drive with more than one compact spare tire.
- Normal summer or winter tires must not be mounted on the compact spare wheel rim.

Jump starting

Preparation

You should only perform the steps that follow if you have the necessary tools and technical expertise.

If the engine does not start because the vehicle battery is drained, you can jump start your vehicle using another vehicle. Jump start cables are needed to do this.

Both vehicle batteries must have 12 V nominal voltage. The voltage capacity (Ah) of the vehicle battery that is giving power must not be less than the capacity of the drained vehicle battery.

Jump start cable

Only use a jump start cable with a large enough diameter. Note the manufacturer's specifications.

Only use a jump start cable with insulated terminal clamps.

Positive cable - usually red.

Negative cable - usually black.

WARNING

- A drained battery can freeze at temperatures around 32 °F (0 °C). If the vehicle battery is frozen, it must be thawed before connecting the jump start cables. If it is not, the risk of an explosion and chemical burns increases. After jump starting the vehicle, drive to an authorized Audi dealer or authorized Audi Service Facility immediately to have the vehicle battery checked.
- Read the warnings when working in the engine compartment ⇒ *page 210*.
- Handling the jump start cables incorrectly may cause the vehicle battery to explode and lead to serious injuries.
- To reduce the risk of chemical burns, do not bend over the vehicle battery.

Note

Jump start cables can cause considerable damage to the vehicle electrical system if they are connected incorrectly.

Tips

- There must be no contact between the vehicles, or else voltage could flow when connecting the positive terminal and drain the vehicle battery of the vehicle providing the jump start.
- The drained vehicle battery must be connected correctly to the electrical system.

- Switch off electrical equipment that is not needed.

Jump starting

Both jump start cables must be connected in the correct order.

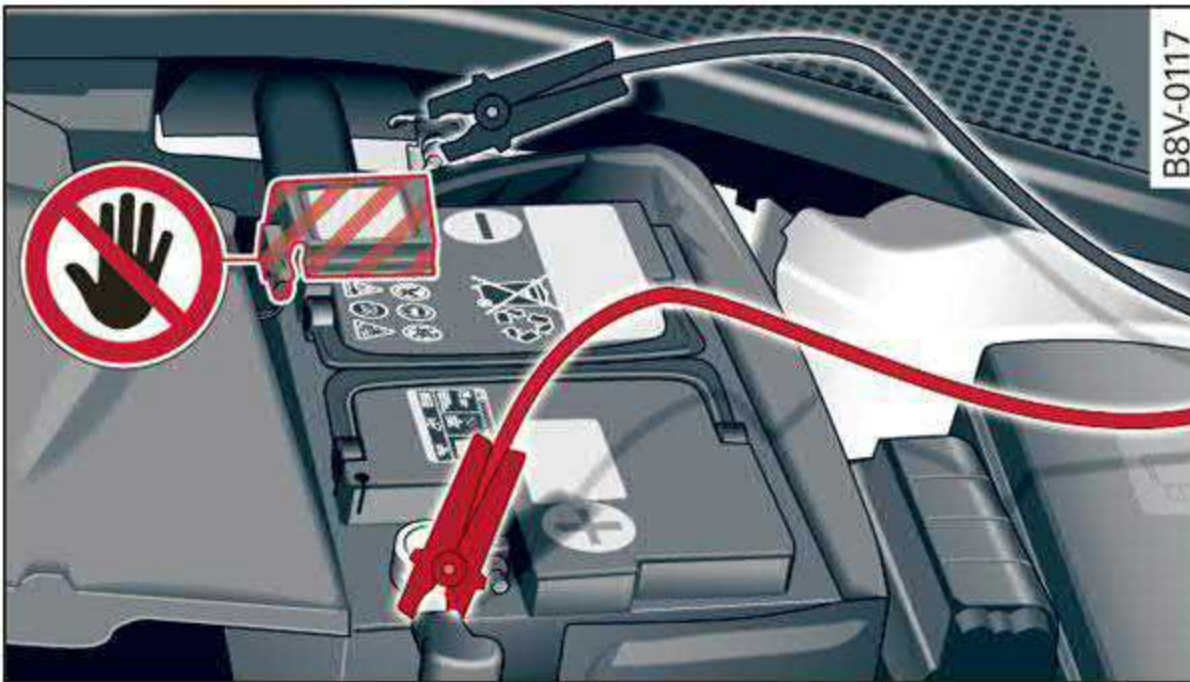

Fig. 165 Engine compartment: connectors for jump start cables or a charger

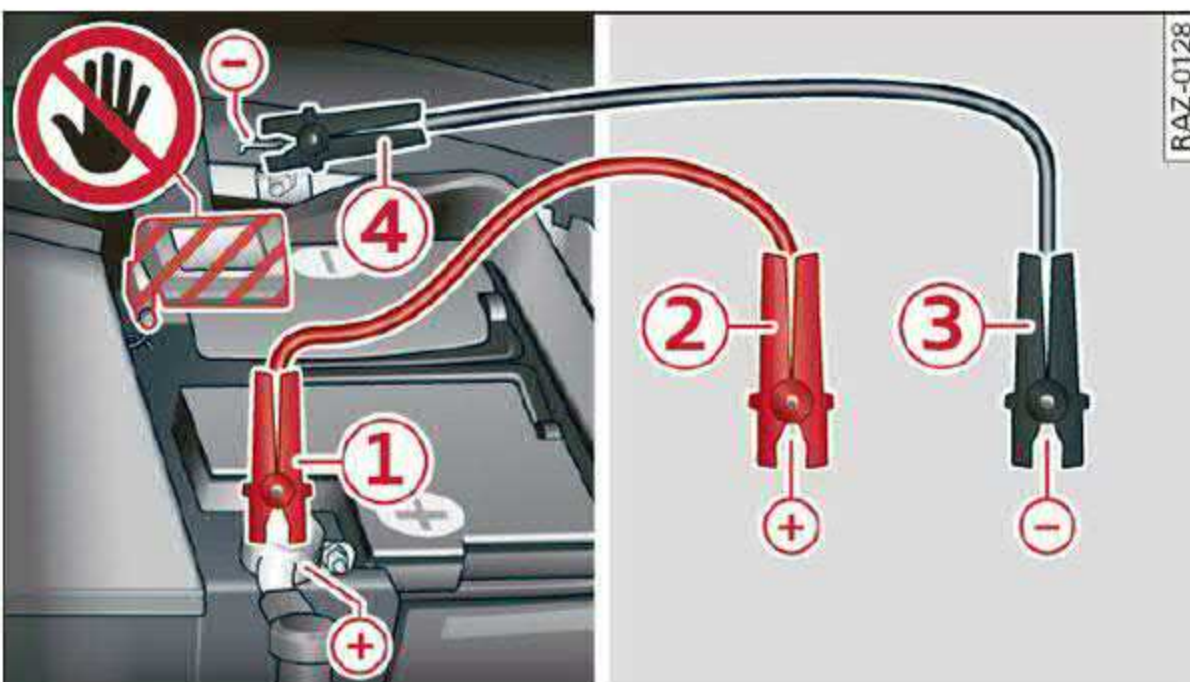

Fig. 166 Connecting the jump start cables

The jump start cable connections are located in the engine compartment.

Follow the information about the vehicle battery ⇒ page 219.

Connecting the positive cable (red) to the positive terminal

- ▶ Open the cover on the positive terminal ⇒ fig. 165.
1. Attach one end of the positive cable (red) to the positive terminal on the vehicle battery ① ⇒ fig. 166.
 2. Attach the other end of the positive cable (red) to the positive terminal ② on the power source.

Connecting the negative cable (black) to the negative terminal

3. Attach one end of the negative cable (black) to the negative terminal ③ on the power source.
4. Attach the other end of the negative cable (black) to the jump-start pin ④ on the vehicle.

Starting the engine

- ▶ Start the engine in the vehicle giving the charge and let it run at idle.
- ▶ Now start the engine in your vehicle, which has the drained battery.
- ▶ If the engine does not start, stop the starting procedure after 10 seconds and then repeat it after approximately 30 seconds.
- ▶ Turn on the rear window defogger in your vehicle in order to reduce any voltage peaks that may occur when disconnecting the jump start cables. The headlights must be switched off.
- ▶ With the engines running, remove the cables in reverse order of the way they were installed.
- ▶ Close the cover on the positive terminal.

⚠ WARNING

- Do not touch the non-insulated parts of the terminal clamps. The cable must also not come into contact with vehicle components that conduct electricity when it is connected to the positive vehicle battery terminal. This can cause a short circuit.
- The plugs on the battery cells must not be opened.
- Keep ignition sources (such as open flames, burning cigarettes, etc.) away from the vehicle batteries to reduce the risk of an explosion.
- Route the jump start cables so they cannot get caught in the moving parts in the other vehicle's engine compartment.

ⓘ Note

- Do not use the negative terminal on the vehicle battery for jump starting. A malfunction could occur in the vehicle electrical system.

- Please note that the connecting process previously described for the jump start cables is intended for when your vehicle is being jump started.

Tips

Make sure that the connected jump start cables have sufficient contact with metal.

Towing

General information

You should only perform the steps that follow if you have the necessary tools and technical expertise.

Towing requires a certain amount of practice. Audi recommends contacting a towing company to have the vehicle transported.

You should only have your vehicle towed by another vehicle when disabled in exceptional circumstances. Inexperienced drivers should not tow.

Notes on towing

When the engine is stopped, the transmission will not be sufficiently lubricated if traveling at high speeds and long distances:

- The maximum permitted towing speed is 30 mph (50 km/h).
- The maximum permitted towing distance is 30 miles (50 km).

Additional information on towing with a tow truck

The vehicle may only be towed with the front axle raised. Do not wrap any chains or cables around the brake lines.

If the vehicle should be towed with the axle raised, then the ignition must be switched off to reduce the risk of damage to the drivetrain.

Tow bar and towing cable

The vehicle can be towed with a tow bar or towing cable. Both drivers should be familiar with the special considerations when towing, especially when using a towing cable.

Always make sure the traction force does not exceed the permitted level and there are no shock loading conditions. There is always the risk of the coupling becoming overloaded when driving off-road.

For the most safety and security, drive with a tow bar. You should use a towing cable only if a tow bar is not available. Use a towing cable made of synthetic elastic cable similar elastic material.

WARNING

- Towing highly increases the risk of an accident, for example from colliding with the towing vehicle.
- To reduce the risk of an accident, do not allow anyone to remain inside the vehicle when it is being transported by a tow truck or a special transporter.

Note

- If normal towing is not possible, for example if the transmission is faulty or if the towing distance is greater than 30 miles (50 km), then transport the vehicle on a special carrier.
- If the vehicle is towed by a tow truck at the axle that is not permitted, this can cause severe damage to the transmission.
- The vehicle must not be tow started for technical reasons.

Tips

- If the power supply is interrupted, then it will not be possible to move the selector lever out of the "P" position. The parking lock must be released using the emergency release before towing the vehicle
⇒ *page 88*.
- Switch Audi pre sense* off ⇒ *page 128* when loading the vehicle onto a vehicle carrier, train, ship, or other type of transportation, or when towing the vehicle. This can prevent an undesired intervention from the pre sense* system.
- Follow the local legal regulations for towing.

Towing

Read and follow the important information under ⇒ *page 254*.

Preparations

- ▶ Only secure the towing cable or tow bar at the designated towing loops ⇒ *page 255*, ⇒ *page 256*.
- ▶ Make sure the towing cable is not twisted. Otherwise it could disconnect from the towing loop while towing.
- ▶ Switch the emergency flashers on in both vehicles ⇒ *page 46*. However, do not do this if it is prohibited by law.

Towing vehicle (front)

- ▶ Only start to drive when the towing cable is taut.
- ▶ Press the brake pedal very carefully.
- ▶ Avoid sudden braking or driving maneuvers.

Vehicle being towed (rear)

- ▶ Make sure the ignition is switched on so that the steering wheel is not locked and so that you can use the turn signals, the horn, and the windshield wipers if needed ⇒ .
- ▶ Switching it off before the vehicle has stopped may impair the function of the brake booster and power steering. You would then need to use more force to steer and brake the vehicle.
- ▶ Release the parking brake ⇒ *page 94*.
- ▶ Select the “N” selector lever position.
- ▶ Make sure the towing cable is always taut.

WARNING

- Never tow a vehicle using a tow bar or towing cable if the vehicle does not have electrical power.
- If the vehicle runs out of power while it is being towed, stop towing the vehicle immediately and consult an authorized Audi dealer or qualified repair facility.

Front towing loop



Fig. 167 Front bumper: installing the towing loop

The threaded opening for the towing loop is located on the right side of the front bumper.

- ▶ Remove the towing loop from the vehicle tool kit ⇒ *page 248*.
- ▶ Press the cap inward with brief, strong pressure ⇒ *fig. 167*. The cap will loosen from the bumper.
- ▶ Tighten the towing eye as far as it will go into the mount. Use a suitable object to tighten the towing eye completely and securely in the mount.
- ▶ After using, place the towing loop back in the vehicle tool kit.

WARNING

If the towing loop is not tightened until it stops when installing, the threads may be pulled out when towing the vehicle and result in an accident.

Tips

Depending on the model, the shape of the cap can vary.

Rear towing loop



Fig. 168 Rear bumper: installing the towing loop

The threaded opening for the towing loop is located on the right rear of the bumper.

- ▶ Remove the towing loop from the vehicle tool kit ⇒ *page 248*.
- ▶ Press the cap inward with brief, strong pressure ⇒ *fig. 168*. The cap will loosen from the bumper.
- ▶ Tighten the towing eye as far as it will go into the mount. Use a suitable object to tighten the towing eye completely and securely in the mount.
- ▶ After using, place the towing loop back in the vehicle tool kit.

WARNING

If the towing loop is not tightened until it stops when installing, the threads may be pulled out when towing the vehicle and result in an accident.

Tips

Depending on the model, the shape of the cap can vary.

Fuses and bulbs

Fuses

Replacing fuses

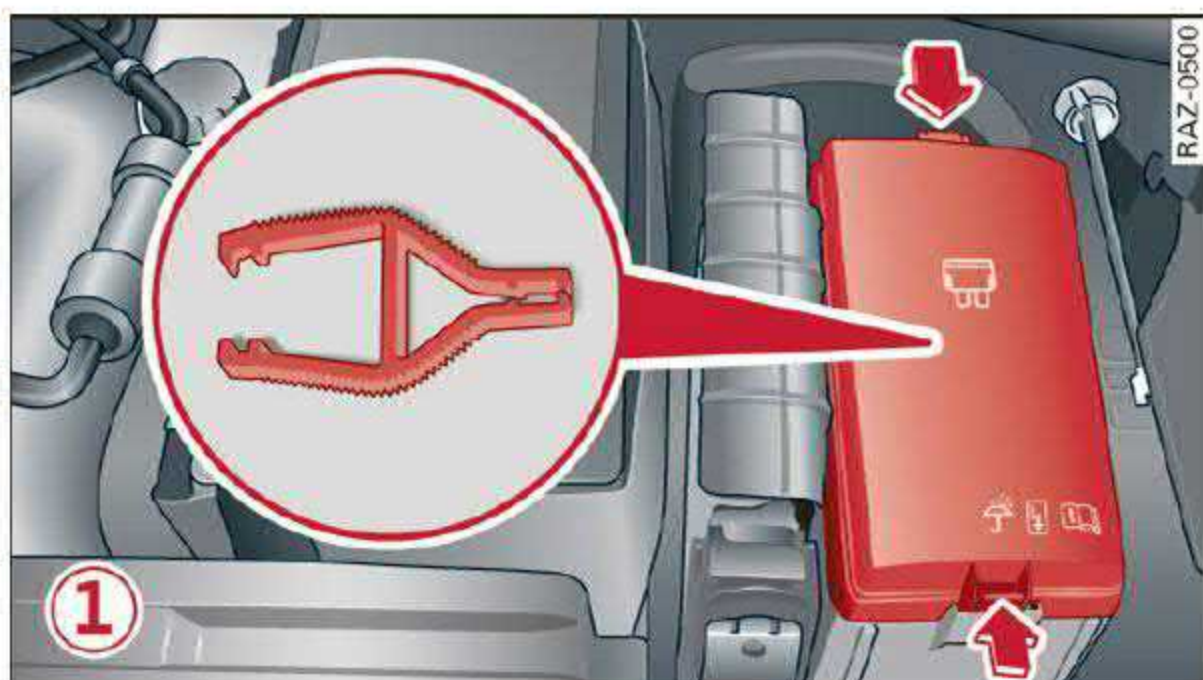

Fig. 169 Left side of the engine compartment: fuse cover ①



Fig. 170 Left side of the cockpit: storage compartment (left-hand drive) ② or storage compartment (right-hand drive) ③

A fuse that has blown will have metal strips that have burned through.

The fuses are located in the left side of the engine compartment ①, behind the storage compartment in the left side of the cockpit ② (left-hand drive vehicles), or the glove compartment ③ (right-hand drive vehicles).

- ▶ Switch the ignition and all electrical equipment off.

- ▶ Check the table that follows to see which fuse belongs to the equipment.
- ▶ Remove the screwdriver from the vehicle tool kit ⇒ page 248.
- ▶ Remove the appropriate cover.
- ▶ Remove the clamp from the rear side of the fuse cover ①.
- ▶ Remove the fuse using the clip.
- ▶ Replace the blown fuse only with a fuse that has the same amp rating.
- ▶ Install the cover.

Fuse color identification

Color	Current rating in amps
Black	1
Gray	2
Purple	3
Pink	4
Light brown	5
Brown	7.5
Red	10
Light blue	15
Yellow	20
White or transparent	25
Light green	30
Teal	35
Orange	40

⚠ WARNING

Do not repair fuses and never replace a blown fuse with one that has a higher amp rating. This can cause damage to the electrical system and increases the risk of fire.

! Note

If a new fuse burns out again shortly after you have installed it, have the electrical system checked as soon as possible by an authorized Audi dealer or authorized Audi Service Facility.

i Tips

– The following table does not list fuse locations that are not used.

Fuses and bulbs

– Some of the equipment listed in the following tables applies only to certain model versions or certain optional equipment.

Fuse assignment – Left side of engine compartment

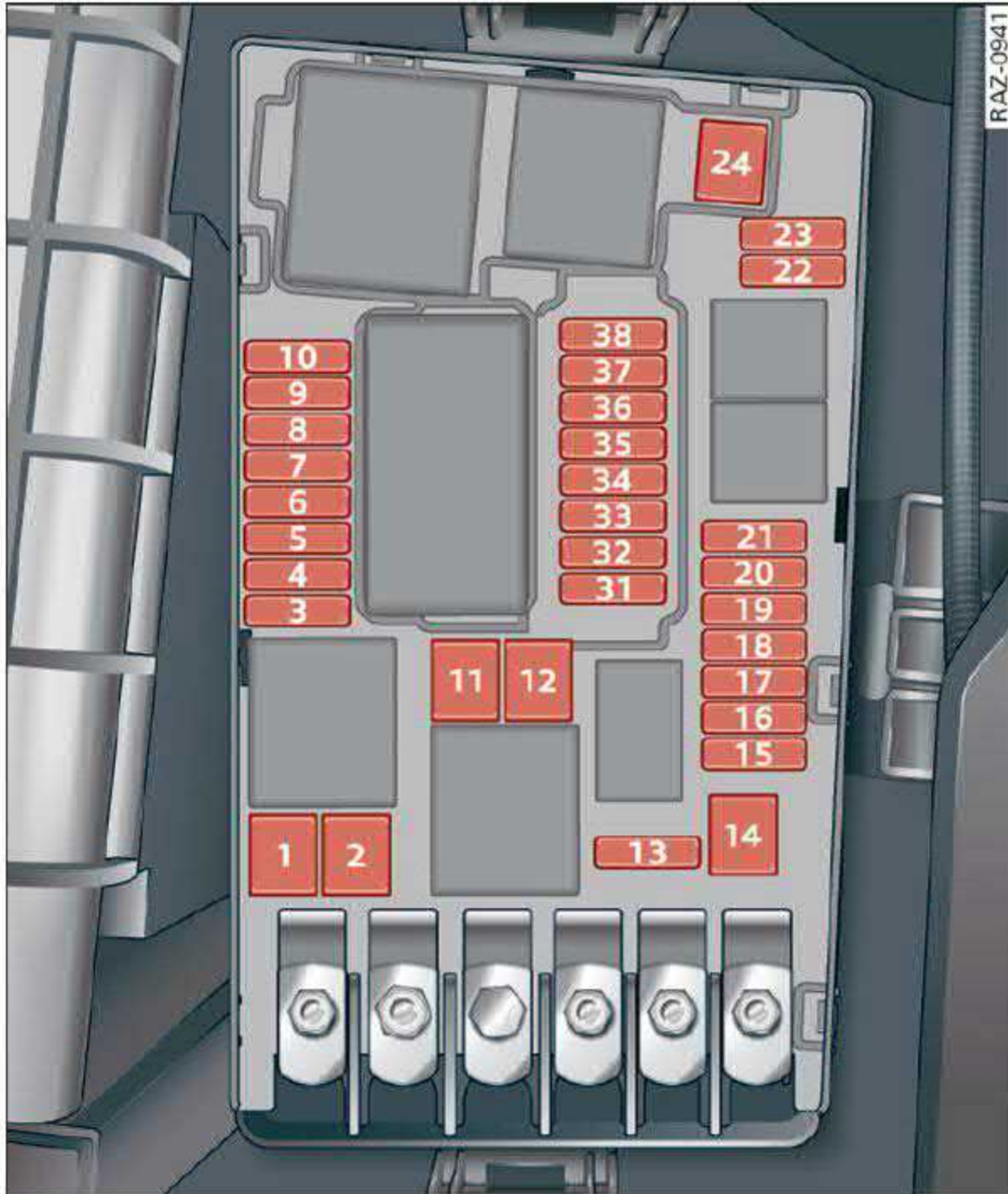

Fig. 171 Left side of engine compartment: fuse assignment

No.	Equipment
1	Electronic Stabilization Control (ESC)
2	Electronic Stabilization Control (ESC)
3	Engine control module
4	Engine components, engine start
5	Engine components
6	Brake light switch
7	Engine components
8	Heated oxygen sensors
9	Engine components
10	Fuel pump
11	Auxiliary heating, engine components
12	Auxiliary heating, brake system vacuum pump
13	Transmission fluid pump, automatic transmission
14	Engine components, ignition coils

No.	Equipment
15	Horn
16	Engine components, engine electronics
17	Electronic Stabilization Control (ESC), engine control module
18	Battery monitoring control module, diagnostic interface
19	Windshield wiper control module
20	Anti-theft alarm system, garage door opener
21	Automatic transmission
22	Engine control module
23	Engine start
24	Auxiliary heating
31	Engine components, fuel injectors
33	Transmission fluid pump
35	Climate control system
36	Left headlight
37	Parking heater
38	Right headlight

Fuse assignment - left side of cockpit

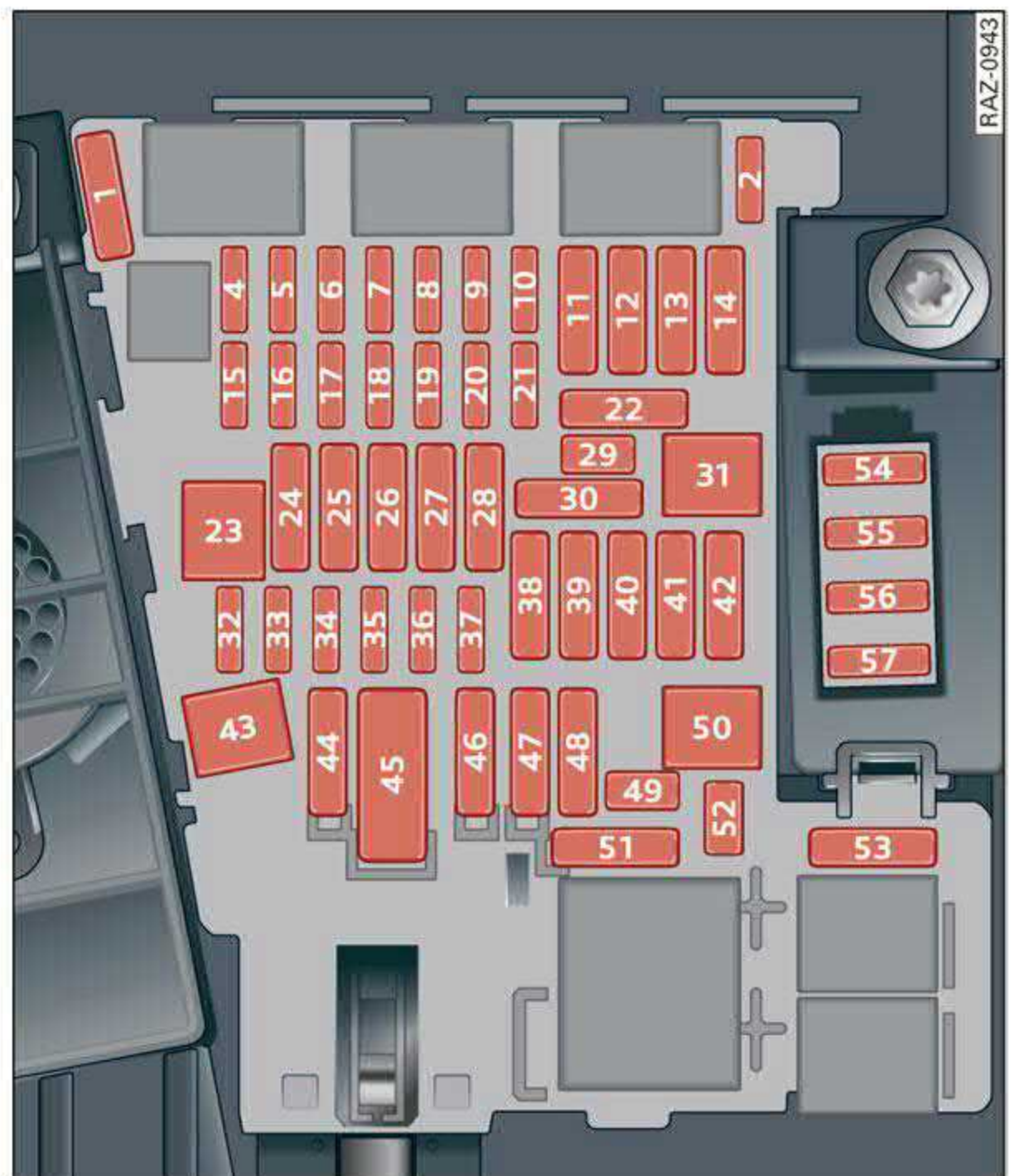

Fig. 172 Left side of cockpit: fuse assignment

No.	Equipment
1	Exhaust treatment
2	Seat electronics, front seats
4	Infotainment system, volume control
5	Diagnostic interface
6	Ignition key safety interlock, selector lever (automatic transmission)
7	Auxiliary heating, climate control system control panel, tire pressure monitoring system
8	Headlight range control, interior monitoring, ambient lighting, light switch, roof electronics control module, emergency call module, parking brake, diagnostic connector, light/rain sensor, particulate matter sensor
9	Steering column electronics
10	Infotainment system, volume control
11	Vehicle electrical system control module
12	Infotainment system
13	Driver's side safety belt tensioner, airbag control module
14	Climate control system blower
15	Electronic steering column lock
16	Audi phone box
17	Instrument cluster, emergency call module
18	Rearview camera, peripheral cameras
19	Convenience access and start authorization control module
20	Exhaust treatment, diagnosis
21	Steering column electronics
23	Panoramic glass roof
24	Vehicle electrical system control module
25	Driver side door control module, left rear window regulator motor, left rear door control module
26	Vehicle electrical system control module
27	Vehicle electrical system control module
29	Roof electronics control module, vehicle electrical system control module
30	Auxiliary battery control module

No.	Equipment
31	Luggage compartment lid lock
32	Driver assistance systems, camera systems
33	Front passenger's seat electronics, roof electronics control module
34	A/C system components, parking brake, reverse lights, interior sound generator
35	A/C system components, diagnostic connector, center console switch module, rearview mirror, headlight range control, instrument illumination
39	Passenger side door control module, right rear window regulator motor, right rear door control module
40	Sockets
41	Passenger's side safety belt tensioner
42	Vehicle electrical system control module
43	Sound-amplifier
44	All wheel drive control module
45	Driver's seat electronics
47	Rear window wiper
48	Exterior sound generator
49	Engine start, clutch position sensor
52	Suspension control
53	Rear window defogger
54	Left trailer hitch light
55	Trailer detection control module
56	Right trailer hitch light
57	Trailer hitch socket

Bulbs

Changing bulbs

Audi recommends having bulbs replaced by an authorized Audi dealer or authorized Audi Service Facility in cases of doubt. These facilities have the correct tools and replacement parts as well as the required technical knowledge.

LED lights*

Your vehicle is equipped with maintenance-free headlights and tail lights. However, if a light bulb ►

needs to be replaced, please contact an authorized Audi dealer or authorized Audi Service Facility.

WARNING

If you still would like to try replacing the bulbs in your vehicle yourself, read the warnings regarding working in the engine compartment ⇒  in *General information on page 210*.

Note

Make sure the covers are fitted correctly on the headlights and tail lights so that no water will leak in from the outside and the light function will not be impaired.

Data privacy

Privacy notice

You can find information about responsibility for data protection in the MMI.

Applies to: MMI: Select on the home screen: **SETTINGS > General > Legal notes > About Audi connect.**

Image recording

Surrounding area monitoring

Applies to: vehicles with surrounding area monitoring

Some vehicle functions require the vehicle's path to be detected and evaluated. This is done by cameras installed permanently on the vehicle that detect objects in the vehicle's surroundings (such as obstacles or guard rails). The live images from the cameras are transmitted to the applicable control module.

The camera images are transferred to the responsible control module for processing and may be stored, depending on vehicle equipment. The control module analyzes the current camera image using image evaluation software. This image evaluation software detects anonymized technical measurements, such as distances to objects. The control module evaluates these technical measurements and makes it possible for the assist systems to control the vehicle, if necessary.

Data memories

Vehicle control modules

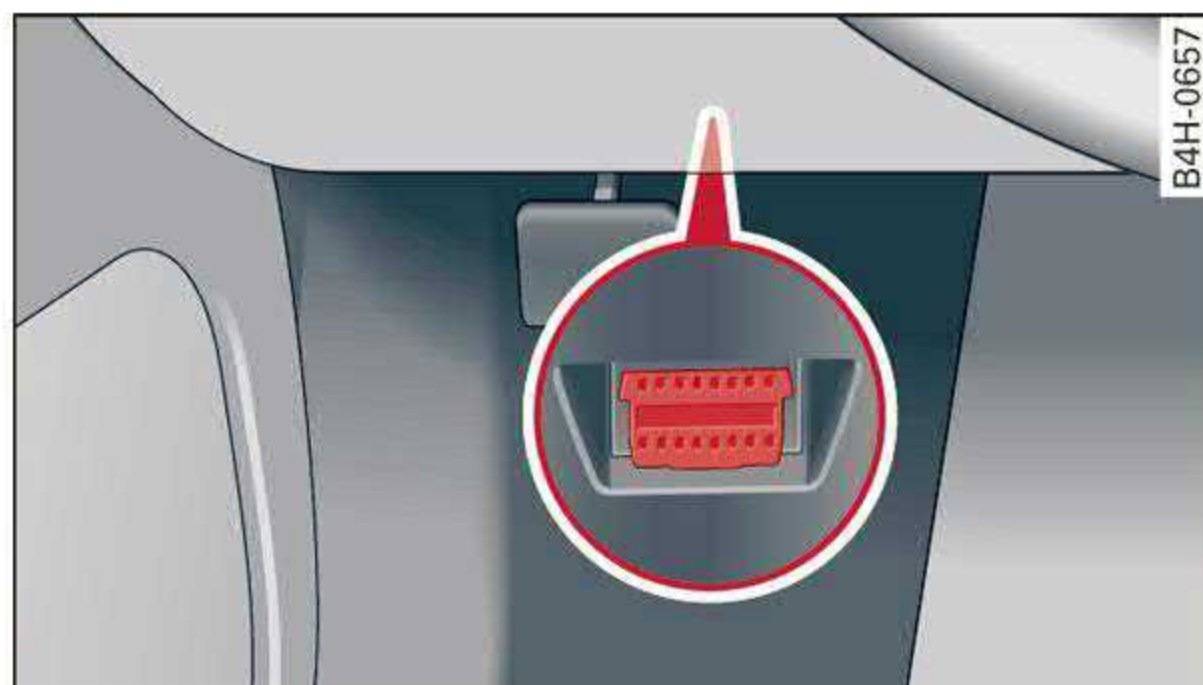

Fig. 173 Driver's side footwell: connection port for the On Board Diagnostic System (OBD)

Your vehicle is equipped with electronic control modules for various vehicle systems such as the airbags. These vehicle control modules store data while driving normally that is required by an authorized Audi dealer or authorized Audi Service Facility for diagnosis and repair purposes. Only certain types of data are recorded for a very short period of time if a control module has detected a system event. No noises, conversations, or images will be recorded in the vehicle.

The data may include information such as the vehicle speed, the direction of travel, and information about the brake system, or also the behavior of the restraint system in the event of an accident. The stored data can be exported and downloaded with special devices, which must be connected directly to the vehicle.

On Board Diagnostic System (OBD)

There is a diagnostic connector socket in the driver's side footwell to read out the various control modules and the event data recorder. Data regarding the function and condition of the electronic control modules is stored in the event memory. Only have an authorized Audi dealer or authorized Audi Service Facility read out and delete the event memory.

WARNING

- Incorrect use of the connection port for the On Board Diagnostic System can cause malfunctions, which can then result in accidents and serious injuries.
- Only allow an authorized Audi dealer or authorized Audi Service Facility to read out the engine data.

Crash data recorder

Event Data Recorder

This vehicle is equipped with an Event Data Recorder (EDR). The main purpose of an EDR is to record, in certain crash or near crash-like situations, such as an airbag deployment or hitting a road obstacle, data that will assist in understanding how a vehicle's system performed. The EDR is designed to record data related to vehicle dynamics and safety systems for a short period of time, ►

typically 30 seconds or less. The EDR in this vehicle is designed to record such data as:

- How various systems in your vehicle were operating;
- Whether or not the driver and passenger safety belts were buckled/fastened;
- How far (if at all) the driver was depressing the accelerator and/or brake pedal; and,
- How fast the vehicle was traveling.

These data can help provide a better understanding of the circumstances in which crashes and injuries occur. NOTE: EDR data are recorded by your vehicle only if a non-trivial crash situation occurs; no data are recorded by the EDR under normal driving conditions and no personal data (e.g. name, gender, age, and crash location) are recorded. However, other parties, such as law enforcement, could combine the EDR data with the type of personally identifying data routinely acquired during a crash investigation.

To read data recorded by an EDR, special equipment is required, and access to the vehicle or the EDR is needed. In addition to the vehicle manufacturer, other parties, such as law enforcement, that have the special equipment, can read the information if they have access to the vehicle or the EDR.

Assist system monitor

This vehicle is equipped with an Assist System Monitor (ASM). The ASM collects data that is not stored by the EDR in the event of an accident. The main task of the ASM is to make it possible to understand the role and the behavior of the assist systems in these accident situations. In addition to the data that the EDR stores, the ASM records data related to the assist systems starting several seconds before the accident or near-accident. The data collected by ASM depends on the equipment and may include the following information: status information of the assist systems (for example, if they are switched on or off, system events, etc.), control interventions (for example, by ESC, ABS, Audi pre sense*, etc.), and assist systems settings (such as speed settings).

Special devices and access to the vehicle or to the ASM are necessary in order to read the data from

the ASM memory. In addition to the vehicle manufacturer, third parties such as law enforcement authorities can also read and analyze the stored data if they have access to the vehicle or to the ASM.

Data usage

Audi can read out the information stored in the data memories or similar data, or give this information to third parties, especially in the following situations:

- If the vehicle owner or lessee agrees
- If there is an official request from the police
- If a court or authorities request it

If legally permitted, Audi can also use the data for analysis of vehicle operation and safety performance or provide this data to third parties for research purposes.

Transmitted information

Privacy settings

Applies to: vehicles with Audi connect

- ▶ Applies to MMI: Select on the home screen: **SETTINGS > Privacy settings.**

Data is transmitted from the vehicle when using Audi connect services.

- ▶ To display additional information about the privacy settings and the associated symbols in the status bar, press ⓘ in the MMI.

Requirement: the ignition must be switched on.

Setting the maximum privacy settings

When the **Activate privacy mode** function is switched on, the data connection is deactivated or sending of data is restricted, but all safety-related, legal, or contractually required Audi connect services remain activated. The majority of the Audi connect services are deactivated.

When the function is switched off, the data connection will be available in order to use Audi connect services.

Adjusting individual privacy settings

In the MMI, you can adjust individually which data should be transmitted from the vehicle. If you ▶

switch on a data category, the data will be transmitted.

Note

You are responsible for all precautions taken for data protection, anti-virus protection, and protection against loss of data on mobile devices that are used to access the Internet through the Wi-Fi hotspot.

Tips

- The following interfaces are not affected by changes to the privacy settings: Bluetooth, Bluetooth Low Energy (BLE), Wi-Fi, Audi smartphone interface (ASI), Near Field Communication (NFC), charging communication (high-voltage system), Electronic Toll Collect (ETC), On-Board Diagnostic System (OBD) if equipped.
- If the maximum privacy settings are switched on, your vehicle may not receive security updates and certificates for establishing an encrypted connection, depending on vehicle equipment. In order to receive security updates and certificates, switch the maximum privacy settings off for at least ten minutes every six months. Make sure that your vehicle is connected to the Internet. A symbol in the MMI status bar indicates if the required data connection is available ⇒ *page 20*.
- If the transmission of data is limited, it will have the following effects on the exchange of data for Audi connect services and emergency calls, if equipped:
 - The emergency call function will remain available without restrictions and will continue to transmit data.
 - If an online roadside assistance call is initiated, no data will be transmitted, but a call will be made.
 - Stored destinations (favorites, last destinations) are only stored in the vehicle. If you allow transmission of data again, these destinations will be synchronized via the myAudi account. To prevent synchronization of destinations, delete the destinations before you allow data to be transmitted again.

Audi connect

Applies to: vehicles with Audi connect Infotainment

Audi collects, uses, stores and shares your personal information, such as contact data, vehicle data, usage data, driving data and precise geolocation, in order to provide you with the products and services you have purchased or requested, and for a number of other purposes, for example, to track quality issues, to performance and safety, to meet our internal compliance or legal requirements and to market to customers and potential customers. For a more complete list of the data we collect, how we use it and with whom we share it, please visit your Audi national/sales region website at www.audi.com.

The collection, use and sharing may vary depending on your model and model year, your subscription status, or the service offering. For example, collection, use and sharing may vary between Audi connect services, if you have designated a key user, or if you are driving a model equipped with persistent data logging. Please review the complete Privacy Statement to understand our data handling practices with respect to a particular service.

You can find additional information about our data privacy practices in your MMI.

- ▶ Applies to: MMI: On the home screen, select: **SETTINGS > General > Legal notes > About Audi connect**.

Information about our privacy practices in conjunction with the mobile Audi connect application can be found in the Application's Privacy Statement.

For additional information about the privacy practices relating to Audi connect, myAudi, or other websites, applications or online services as well as your obligations with respect to using these services, and for additional information regarding Audi connect terms and conditions, please visit your Audi national/sales region website at www.audi.com.

Accessories and technical changes

Warranty

Your vehicle is covered by various warranties:

- New Vehicle Limited Warranty
- Limited Warranty Against Corrosion Perforation
- Emissions Control System Warranties: *Federal Emissions Control System Defect Warranty, Federal Emissions Performance Warranty*
- Applies to: USA models: Kansas Safety Belt Limited Warranty
- Applies to: USA models: California Emissions Control Warranties: *Short-term Emissions Defects Warranty, Long-term Emissions Defects Warranty, TZEV models Emissions Defects Warranty, California Emissions Performance Warranty*

You can find detailed information in your Warranty & Maintenance Booklet and in the California Emissions Booklet*.

Audi Literature Shop

Service information is made available as soon as possible after a model is introduced and can be ordered in the Audi Literature Shop: <http://literature.audiusa.com>

Driving in other countries

Government regulations in the United States and Canada require motor vehicles to comply with emissions regulations and safety standards. Therefore, vehicles that were produced for the U.S. and Canadian markets are different from vehicles produced for other countries.

If you plan to use your vehicle outside of the United States or Canada, it is possible that:

- Fuel may have a significantly lower octane rating. Unsuitable fuels can cause engine damage.
- Proper maintenance and repair work may not be possible because special service equipment, tools, or measuring devices needed for your vehicle may not be available.

- Replacement parts may not always be available.
- Navigation systems for vehicles built for the U.S.A. and Canada will not necessarily work in Europe, and may not work in other countries.

Note

Audi is not liable for damage to the vehicle resulting from these country-specific differences.

Maintenance, repairs, and technical modifications

Observe the safety precautions ⇒ *page 210, General information* and ⇒ *page 249, Raising the vehicle*.

General information

Due to the increasing complexity of technology in these vehicles, as well as the safety and environmental standards that apply, you can only perform a very limited amount of repairs and modifications to the vehicle yourself.

Proof of maintenance work may be required to submit a claim within the warranty period.

We recommend that you have your vehicle serviced by an authorized Audi dealer or authorized Audi Service Facility and that Audi Genuine Parts and Audi Genuine Accessories are used. This helps to ensure that your vehicle's functionality, performance, and safety are not impaired.

Maintenance and repairs

Your vehicle was designed to help keep maintenance requirements to a minimum. Some regular maintenance is required to help ensure that your vehicle runs in a safe, economical, and reliable manner. Please refer to your Warranty & Maintenance Booklet for more detailed information about vehicle maintenance.

When operating the vehicle under more extreme operating conditions, for example when outside temperatures are very low or in very dusty environments, certain maintenance should be performed between the specified intervals. ►

Usually maintenance and repair work requires special tools, measuring devices, and other equipment that is available to trained vehicle technicians in order to help ensure that your vehicle and all of its systems operate correctly, reliably, and safely. Performing work on the vehicle incorrectly can impair the operation and reliability of your vehicle and may void one or more of your vehicle's warranties.

Technical Modifications

Interference with electronic components, their software, the wiring, and data transfer may cause malfunctions. Because of the way electronic components are interconnected, such malfunctions can also impair systems that are not directly involved. This means that you risk both a substantial reduction in the operational safety of your vehicle and increased wear of vehicle components.

Some convenience functions, such as the convenience turn signal function, individual door opening function, and displays, can be reprogrammed using special workshop equipment. If functions are reprogrammed, the information and descriptions about these functions in this Owner's Manual may no longer apply to the changed functions. Audi recommends that an authorized Audi dealer or authorized Audi Service Facility perform and verify any reprogramming procedures.

WARNING

Maintenance work, repairs, or technical modifications to the vehicle (such as installing additional equipment) that is not performed correctly can cause serious injuries and increase the risk of an accident.

WARNING

The engine compartment in any motor vehicle is a potentially dangerous area and can cause serious personal injury.

- Always use extreme caution when doing any work in the engine compartment. Always follow commonly accepted safety practices and use common sense. Never risk personal injury.

- Never perform any work in the engine compartment unless you know exactly how to carry out the job and have the correct technical information and the correct tools.
- If you are uncertain about what to do, have the work performed by an authorized Audi dealer, an authorized Audi Service Facility, or another qualified workshop. Serious personal injury may result from improperly performed work.

Note

- Maintenance work, repairs, or technical modifications to the vehicle (such as installing additional equipment) that is not performed correctly can cause vehicle damage.
- If emergency repairs must be performed, take your vehicle to an authorized Audi dealer or authorized Audi Service Facility as soon as possible.
- Audi is not liable for damage to the vehicle resulting from failure to comply with these guidelines.

For the sake of the environment

- Regular maintenance can help protect the environment.
- Technical modifications to the vehicle can have a negative impact on fuel consumption and vehicle emissions.

For the sake of the environment

Certain components in your vehicle such as undeployed airbag modules, pretensioners and remote control batteries may contain Perchlorate Material – special handling may apply, See www.dtsc.ca.gov/hazardouswaste/perchlorate. When the vehicle or parts of the restraint system including airbag modules and safety belts with pretensioners are scrapped, all applicable laws and regulations must be observed. Your authorized Audi dealer is familiar with these requirements and we recommend that you have your dealer perform this service for you.

Tips

Because of your vehicle's aluminum body design, all service and repair procedures affecting the body should be performed by an authorized Audi dealer or authorized Audi Service Facility, who will perform the work according to Audi factory specifications. Only Audi Genuine Parts are used when Audi experts perform repair or service procedures. Failure to use Audi Genuine Parts or Audi Genuine Accessories or performing repairs incorrectly may result in severe vehicle damage, such as corrosion.

Accessories and parts

Consult with an authorized Audi dealer or authorized Audi Service Facility before purchasing accessories or replacement parts. Audi recommends having your vehicle serviced by an authorized Audi dealer or authorized Audi Service Facility and using Audi Genuine Parts and Audi Genuine Accessories.

Audi does not endorse the use of products and accessories that it has not evaluated, even if the product is approved by a certified testing agency or government agency.

WARNING

- Installing unapproved accessories or incorrect replacement parts can cause vehicle damage and can increase the risk of an accident.
- Never attach accessories, such as telephone holders or cup holders, to the airbag covers or within the airbag deployment zone, because this increases the risk of injury if the airbag deploys.
- On vehicles that have factory-installed license plate brackets on the front of the vehicle, the brackets may only be replaced with ones that are the same size and made of the same material. Do not install any license plate brackets on the front of vehicles that do not have factory-installed brackets. Otherwise, the function of the system could be impaired.

Note

A correctly-installed exterior antenna is required for operating radio equipment in the vehicle. Otherwise, the increased electromagnetic waves can cause malfunctions in the vehicle. Observe the regulations in the country where the vehicle is being operated and the instructions from the radio equipment manufacturer.

Reporting Safety Defects Applicable to U.S.A.

If you believe that your vehicle has a defect which could cause a crash or could cause injury or death, you should immediately inform the National Highway Traffic Safety Administration (NHTSA) in addition to notifying

Audi of America, Inc.
2200 Ferdinand Porsche Drive
Herndon, VA 20171

If NHTSA receives similar complaints, it may open an investigation, and if it finds that a safety defect exists in a group of vehicles, it may order a recall and remedy campaign. However, NHTSA cannot become involved in individual problems between you, your dealer, or Audi of America, Inc. 

To contact NHTSA, you may call the Vehicle Safety Hotline toll-free at 1-888-327-4236 (TTY: 1-800-424-9153); go to <http://www.safercar.gov>;

or write to:

Administrator NHTSA
1200 New Jersey Ave.,
S.E. West Building
Washington, DC
20590.

You can also obtain other information about motor vehicle safety from <http://www.safercar.gov>.

Applicable to Canada

If you live in Canada and you believe that your vehicle has a defect that could cause a crash, injury or death, you should immediately inform Transport Canada, Defect Investigations and Recalls. You should also notify Audi Canada.

Canadian customers who wish to report a safety-related defect to Transport Canada, Defect Investigations and Recalls, may either call Transport Canada toll-free at:

Tel.: 1-800-333-0510 or
Tel.: 1-819-994-3328 (Ottawa region and from other countries)
TTY for hearing impaired:
1-888-675-6863

or contact Transport Canada by mail at:

Transport Canada
Motor Vehicle Safety Investigations Laboratory
80 Noel Street
Gatineau, QC
J8Z 0A1

For additional road safety information, please visit the Road Safety website at:

English:

<http://www.tc.gc.ca/eng/motorvehiclesafety/menu.htm>

French:

<http://www.tc.gc.ca/fra/securiteautomobile/menu.htm>

Declaration of compliance for telecommunications equipment and electronic systems

The manufacturer is not liable for radio malfunctions that are caused by unauthorized changes to the equipment.

FCC Part 15.19

This device complies with part 15 of the FCC Rules. Operation is subject to the following two conditions: (1) This device may not cause harmful interference, and (2) this device must accept any ►

interference received, including interference that may cause undesired operation.

FCC Part 15.21

Changes or modifications not expressly approved by the party responsible for compliance could void the user's authority to operate the equipment.

RSS-Gen

This device contains licence-exempt transmitter(s)/receiver(s) that comply with Innovation, Science and Economic Development Canada's licence-exempt RSS(s). Operation is subject to the following two conditions:

- (1) This device may not cause interference; and
- (2) This device must accept any interference, including interference that may cause undesired operation of the device.

Tips

Additional information or supplements about the radio systems based on the vehicle equipment and country can be found on the following website: www.audi.com/generalinfo

Technical data

Identification data

Vehicle data label

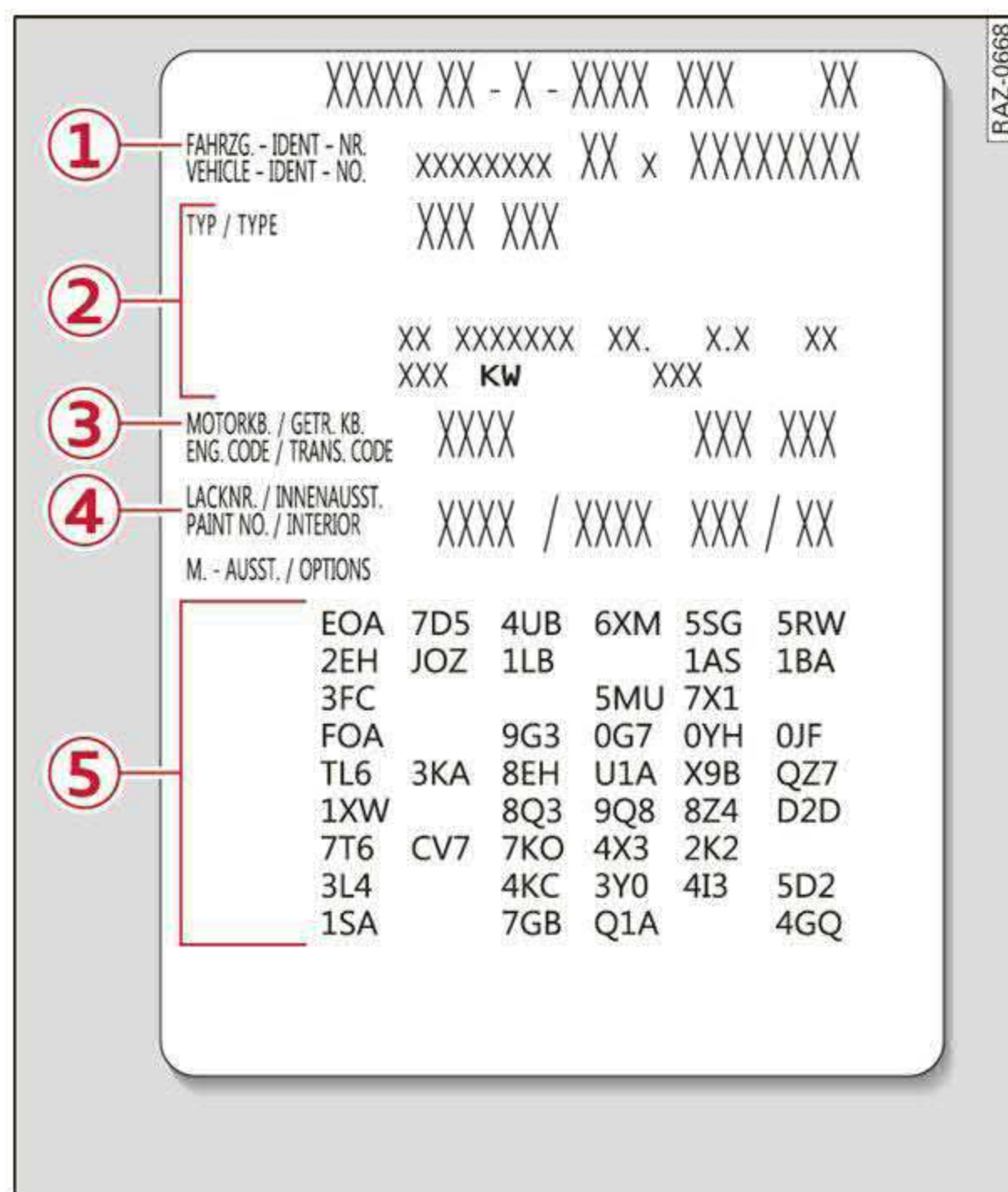

Fig. 174 Vehicle identification label

The vehicle identification label ⇒ *fig. 174* is located in the luggage compartment under the cargo floor cover.

The vehicle identification label information can also be found in the Warranty & Maintenance booklet.

The sticker contains the following vehicle data:

- ① Vehicle Identification Number (VIN)
- ② Vehicle type, engine output, transmission
- ③ Engine and transmission codes
- ④ Paint and interior codes
- ⑤ Optional equipment numbers

Vehicle identification number (VIN)

The VIN is located in the following areas:

- Select on the home screen: **VEHICLE > Settings & Service > Vehicle information.**
- On the vehicle identification label
- At the front behind the windshield*
- In the right front footwell under the carpet

Notes about technical data

The values may vary based on special equipment as well as market-specific equipment and measuring methods.

Please note that the specifications listed in the vehicle documentation always take precedence.

i Tips

Any technical data that is missing was not available at the time of printing.

Vehicle data

Dimensions

	Length (in (mm))	Width (in (mm))	Width across the mirrors (in (mm))	Height at curb weight (in (mm))
Q3	176.6 (4,485)	72.8 (1,849)	79.7 (2,024)	62.9 (1,598)

Capacities

	Approximate capacities
Fuel tank	15.9 gal (60 L)
Windshield and headlight washer system*	4.9 qt (4.6 L)

A/C system refrigerant oil

The exact type and amount of refrigerant oil in the A/C system is specified on the sticker on the refrigerant compressor.

	Approximate capacities	Tolerance
Refrigerant oil	75 / 80 / 110 g ^{a)}	+/- 10 g

a) The specifications depend on vehicle equipment.

Weights



Fig. 175 Safety certificate

Gross Vehicle Weight Rating (GVWR)

The maximum permitted total weight **1** of the vehicle is listed on the safety certificate on the side area of the door or on the driver's door pillar.

Trailer load

Trailer with brakes up to 12% incline	Tongue weight on trailer ball hitch	Permitted trailer weight
1,500 lbs (680 kg)	154 lbs (70 kg)	6,022 lbs (2,730 kg)

Gross Axle Weight Rating (GAWR)

The maximum permitted load on the front axle **2** or the rear axle **3** is listed on the safety certificate on the side area of the door or on the driver's door pillar.

Load

The maximum permitted load is listed on the tire pressure label on the driver's door pillar.

Roof load

The maximum permissible roof load is 165 lbs (75 kg).

Numbers and Symbols

- 2-zone deluxe automatic climate control 80
- 3-zone deluxe automatic climate control 80
- A**
- A/C cooling mode 80
- A/C system refrigerant oil 270
- Accelerator pedal 88
also refer to Accelerator pedal 88
- Accessories 266
- Active lane assist
refer to Lane departure warning 124
refer to Lane guidance 124
- Adaptive cruise assist 115
 Cleaning the sensors 243
- Adaptive dampers 99
- Adaptive speed assist 115
also refer to Adaptive cruise assist 115
- Adjusting the air distribution 81
- Adjusting the brightness 48
- Adjusting the sound 201
- Adjusting the temperature 80
- Adjusting the volume 26
- Adjusting the volume (announcements) 201
- Adjusting the welcome sound 201
- Airbag system 63
- Alarm system
refer to Anti-theft alarm system 31
- Alignment pin (changing the wheel) 248
- All-weather lights 44
- All season tires 238
- All wheel drive
refer to quattro 100
- Amazon Alexa integration
 Media playback 190
 Operation 25
- AMI
refer to Audi music interface 190
- Android Auto
refer to Audi smartphone interface 199
- Anti-lock braking system 100
- Anti-Slip Regulation 101
- Anti-theft alarm system 31
- Anti-theft wheel bolts 249
- Apple CarPlay
refer to Audi smartphone interface 199
- Aspect ratio (video) 194, 195
- ASR
refer to Anti-Slip Regulation 100
- Audi adaptive light 44
- Audi connect
refer to connect 157
- Audi drive select 98
- Audi music interface 190
- Audio files 192
- Audi phone box 145
- Audi pre sense 126
 Messages 128
- Audi pre sense front 127
- Audi side assist
refer to Side assist 129
- Audi smartphone interface 199
 Legal information 203
- Audi virtual cockpit
refer to Instrument cluster 11
- AUTO
 Automatic headlights 44
 Climate control system 80
- Auto Lock (central locking) 28
- Automatic luggage compartment lid 36, 37
- Automatic transmission 86
- Automatic wipe/wash system 50
- Average consumption 14
- Average speed 14
- B**
- Bag hooks 75
- Battery 219
 Charging (12 Volt vehicle battery) 221
 Winter operation (12 Volt vehicle battery) 220
- Block route 172
- Blower 80
- Bluetooth
 Audio player 188
 Connecting a mobile phone 143
 Deleting a device 203
 Device overview 202
 Disconnecting a device 203
 Displaying profiles 203

Index

- Searching for a device 203
- Selecting a device 203
- Specifying a favorite 203
- Brake fluid
 - Checking the brake fluid level 218
- Brakes 92
 - Brake assist 101
 - Brake fluid 218
 - Emergency braking function 95
 - Hot 95
 - New brake pads 92
- Brands 205
- Break-in security feature 31
- Breaking in
 - New brake pads 92
 - New tires 230
- Browser
 - refer to* Media center 192
- Bulb change 259
- Business address 173
- C**
- California Proposition 65 Warning 211
 - Battery specific 220
- Call list 147
- Cameras
 - Coverage areas 107
 - Locations 108
- Capacities
 - Fuel tank 269
 - Washer fluid reservoir 269
- Cargo floor 78
- Cargo net 77
- Car key 32
- Car phone
 - Serial number (IMEI) 154
 - Switching on 154
- Car wash 242
- Catalytic converter 209
- Cell phone
 - refer to* Telephone 143
- Cell phone compartment
 - refer to* Audi phone box 145
- Central locking 28
 - Auto Lock 28
 - Convenience key 33
 - Convenience opening and closing 39
- Luggage compartment lid 35
- Mechanically unlocking and locking 30
- Messages 30
- Remote control key 33
- Setting 29
- Vehicle key 33
- Central locking switch 30
- Ceramic brakes 92
- Certification 267
- Changing bulbs 259
- Charging
 - refer to* Power sources 74
- Charging the battery (mobile devices) 145, 190
- Child safety lock
 - Power windows 38
 - Rear doors 38
- Child safety seats 68
 - Securing to the top tether anchor 72
 - Securing with a safety belt 71
 - Securing with LATCH 70
- Cleaning 242
 - Cleaning Alcantara 245
 - Cleaning artificial leather 245
 - Cleaning carbon components 244, 245
 - Cleaning controls 245
 - Cleaning decorative parts and trim 244
 - Cleaning exhaust tail pipes 244
 - Cleaning plastic parts 244
 - Cleaning textiles 245
- Climate control system 79
- Closing
 - Automatic luggage compartment lid 36
 - Convenience closing 39
 - Hood 211
 - Luggage compartment lid 35
 - Luggage compartment lid with foot motion 37
 - Panoramic glass roof 40
 - Sunshade (roof) 40
 - Windows 39
- Cockpit dimming 48
- Cockpit (overview) 6
- Color code 269
- Compact spare tire 251
- Compartments 75
- Compass in the mirror 53

Compliance	267	Defrosting (windows)	81
Configuration wizard	18	DEF (instrument cluster)	11
connect	157	Demo mode	
Data plans	160	<i>refer to</i> Presentation mode	177
Data Privacy	263	Destination on the map	169
Emergency call	162	Details	168
Infotainment	157	Determining correct load limit	237
Infotainment services	158	Digital compass	53
Online roadside assistance	163	Dimensions	269
Connected devices		Dimming the exterior mirrors	49
Device overview	202	Dimming the rearview mirror	49
Connections		Directory	
<i>refer to</i> Media	188, 192	Settings	154
Consumer information	264	<i>also refer to</i> Contacts	148
Consumption		Display	
Reducing	90	Cleaning	245
Consumption (fuel)	14	Displaying tool tips	18
Contacts		Disposal	264
Add destination	173	Distance	14
Importing and exporting	154	Distance warning	123
Memory capacity	154	Doors	
Opening (business card)	148	Child safety lock	38
Updating in the MMI	154	Door contact switch	47
Convenience key	28	Mechanically unlocking and locking	30
Convenience closing	39	Driver information system	12
<i>also refer to</i> Vehicle key	32	Drives	
Convenience opening and closing		<i>refer to</i> Media	188, 192
Windows or roof	39	Drive select	
Coolant temperature display	13	<i>refer to</i> Audi drive select	98
Cooling mode	80	Drive system	89
Cooling system		Audi drive select	98
Adding coolant	217	Drive system (message)	92
Checking the coolant level	217	Driving down hills	95
Coolant	216	Driving program	123
Cornering light	44	Driving through water	96
Cruise control system	114	Driving time	14
Cup holders	74	Driving tips	
Current consumption	14	Driving through water	96
		Efficient driving	90
D		Offroad driving	96
Data plans	160	Uphill and downhill	95
Data Privacy	263	Driving up hills	95
Date	14		
Setting	201		
Daytime running lights	44		
Declaration of compliance	267		

E	
E-mail	
Message options	152
Settings	152
eco mode (climate control system)	80
EDL	
<i>refer to</i> Electronic Differential Lock	100
EDR	
<i>refer to</i> Event Data Recorder (EDR)	261
Electrical system	219
Electromechanical parking brake	94
Electronic Differential Lock	101
Electronic immobilizer	32
Electronic Stabilization Control	100
Embedded SIM card	158
Emergency assistance	248
Emergency braking function	95
Emergency call	149, 162
Emergency flashers	46
Emergency mode	88
Emergency operation	
Doors	30
Fuel filler door	209
Luggage compartment lid	37
Panoramic glass roof	40
Emissions control system	209
Energy consumers	15
Energy management	90
Engine	
Breaking in	89
Coolant	216
Emergency stop	83
Jump starting	252
Start/Stop system	90
Starting/stopping	83
Engine compartment	
Opening and closing the hood	211
Overview	212
Safety precautions	210
Engine oil	
Adding	213
Changing	215
Checking oil level	213
Consumption	213
Indicator light	213
Replacement interval	222
Temperature display	14
Engine sound	
Audi drive select	98
Engine Start/Stop mode	
<i>refer to</i> Start/Stop system	90, 92
Engine start system	84
Engine stop	
<i>refer to</i> Start/Stop system	90, 92
Entry/exit lighting	46
Environment	
Unleaded gasoline	206
ESC	
<i>refer to</i> Electronic Stabilization Control	100, 101
eSIM	
<i>refer to</i> Embedded SIM card	158
Event Data Recorder (EDR)	261
Exterior lighting	44
Exterior mirrors	48
Folding settings	29
External voice operation	25
F	
Factory default settings	
Multi Media Interface	202
Fast route	165
Favorites	
Bluetooth	203
Navigation	167
Telephone	148
Federal Communications Commission (FCC)	267
File formats (media drives)	196
Folding the rear seats	77
For the sake of the environment	
Disposing of engine oil	215
Fueling	207
Leaks	211
Forward gear	
<i>refer to</i> Gears	86
Free text search	
Media	195
Radio	182
<i>also refer to</i> Intelligent search	165

Freeze protection			
Coolant	216		
Windshield washer system	222		
Front center armrest	57		
Front collision warning			
<i>refer to Audi pre sense front</i>	126		
Front wiper blades			
Changing	51		
Cleaning	51		
Fuel	206		
Additives	207		
Current consumption	14		
Fuel display	11		
Fuel tank capacity	269		
Gasoline	206		
Reducing fuel consumption	90		
Fueling			
Fuel filler door	207		
Fuel filler door emergency release	209		
Fuel tank capacity	269		
Fuse assignment	258		
G			
Garage door opener	40		
Garment hooks	75		
Gasoline	206		
Additives	207		
Gasoline mixture	206		
GAWR			
<i>refer to Gross Axle Weight Rating (GAWR)</i>	270		
Gears	86		
Glossary of tire and loading terminology	226		
Glove compartment	75		
Gross Axle Weight Rating (GAWR)	270		
Gross Vehicle Weight Rating (GVWR)	270		
GVWR			
<i>refer to Gross Vehicle Weight Rating (GVWR)</i>	270		
H			
Handsfree	144		
Hands Free Profile	144		
Headlight range control	44		
Headlights			
Cleaning	243		
Headlight range control	44		
Washer system	50		
Washer system (filling washer fluid)	222		
Head restraints			
Adjusting	59		
Removing and installing	59		
Heated rear window	81		
Heated steering wheel	81		
Heater			
<i>refer to Climate control system</i>	79		
HFP			
<i>refer to Hands Free Profile</i>	143		
High beams			
High beam assistant	45		
Highway lights	44		
Hill descent assist	96		
Hill descent control	95		
Hill hold assist	85		
Home			
<i>refer to Home address</i>	173		
Home address	173		
HomeLink			
<i>refer to Garage door opener</i>	40		
Home screen	17		
Horn	6		
Hotspot			
<i>refer to Wi-Fi</i>	160		
I			
Idle			
<i>refer to Gears</i>	86		
Ignition			
Switching on and off	83		
Imbalance (wheels)	232		
Immobilizer			
<i>refer to Electronic immobilizer</i>	32		
Indicator lights	7		
Inspection interval	222		
Instrument cluster	11		
Adjusting the layout	12		
Cleaning	245		
Engine code	204		
Failure	11		
On-board computer	14		
Operating	12		
Service interval display	222		
Software information	204		

- MAP
refer to Message Access Profile 151
- Map preview 168
- Map update 175
 Online 175
 SD card/USB connection 175
- Media 188, 192
 Supported formats 196
- Media center 192
- Memory card
 SD card reader (MMI) 188
 Supported types and formats 196
- Menu language
refer to Setting the language 201
- Menu paths 17
- Message Access Profile 151
- Messages 151
- Mirror compass 53
- Mirrors
 Adjusting exterior mirrors 48
 Dimming 49
 Vanity mirror 50
- MMI Navigation plus
refer to Multi Media Interface 18
- MMI Radio plus
refer to Multi Media Interface 18
- Mobile device
refer to Telephone 143
- Mobile phone network
 Connection settings 155
- Mountain passes 95
- Mountain roads 95
- Multifunction steering wheel
 Buttons 12, 26
 Operating 12
 Programming buttons 26
 Voice recognition system 24
- Multi Media Interface 18
 Menus and symbols 19
 Operating 16, 19
 Switching on or off 18
- Muting 26
- myAudi 27, 158
 Automatic login 27
- myAudi navigation 164, 168
- N**
- Natural leather care and cleaning 245
- Navigation 164
 Better route 176
 Calling 168
 Changing the scale 168
also refer to Map 170
- Navigation database
 Version information 203
- Navigation (instrument cluster) 171
- NHTSA 266
- Notification center 20
- O**
- Octane rating (gasoline) 206
- Odometer 14
 Resetting 14
- Office address
refer to Business address 173
- Offroad
refer to Offroad driving 96
- Offroad driving 96
- Oil
refer to Engine oil 213
- On-board computer 14
- On Board Diagnostic System (OBD) 209, 261
- Online destination
refer to Online Points of Interest 167
- Online map
refer to Satellite map 174
- Online media 189
- Online Points of Interest 167
- Online radio 184
also refer to Online radio 184
- Online roadside assistance 163
- Online services
refer to connect 157
- Online system update 202
- Opening 28
 Automatic luggage compartment lid 36
 Convenience opening 39
 Fuel filler door 207
 Hood 211
 Luggage compartment lid 35
 Luggage compartment lid with foot motion 37

Panoramic glass roof	40	Parking system	
Sunshade (roof)	40	Switching rear cross-traffic assist on and	
Windows	39	off	137
Opening and closing		Pass-through	77
<i>refer to</i> Unlocking and locking	28, 33	Password	
Operating		myAudi automatic login	27
Instrument cluster	12	Pedals	88
Multifunction steering wheel	12	Perchlorate	264
Multi Media Interface	16, 19	Peripheral cameras	133
Text input	22	Personal route assistance	172
Touch display	16	Phone	
Optional equipment number	269	Answering/ending a call	150
Options		Connecting a second mobile device	144
Media	195	Disconnecting a mobile device	145
Navigation	177	Settings	153
Radio	185	Phonebook	
Overview (cockpit)	6	<i>refer to</i> Contacts	148
P		Playback (media)	192
Paint code	269	Podcast	
Paint damage	244	<i>refer to</i> Online radio	184
PANIC button	32	POI	167
PANIC function	32	Point of interest	
Panoramic glass roof	40	<i>refer to</i> Online Points of Interest	167
Convenience opening and closing	39	Polishing	244
Emergency closing	40	Pollutant filter	79
Quick opening	40	Power sources	74, 190
Park assist	140	Power windows	39
Parking aid	131	Malfunction	39
Adjusting the volume	132	Power windows malfunction	39
Cleaning the sensors and camera	243	pre sense	
Park assist	140	<i>refer to</i> Audi pre sense	126
Parking aid plus	131	Presentation mode	179
Parking space search	138	Presets	
Peripheral cameras	133	Radio	182
Rearview camera	133	Presets list	
Trailer view	135	<i>refer to</i> Presets	182
Parking and maneuvering	131	Pressure	
Parking brake		Tire pressure monitoring system	240
<i>refer to</i> Electromechanical parking brake	94	Tires	233
Parking lights	44	Progressive steering	99
Parking lock		Protecting	244
Manually releasing	88	Pyrotechnic elements	264
<i>also refer to</i> Gears	86	Q	
		quattro	100
		Selective wheel torque control	101

- R**
- Radio 180
 - Radio text 183
 - Station list 180
 - Radio communications equipment 266
 - Radio equipment 266
 - Radio Standards Specification (RSS) 267
 - Rain/light sensor
 - Headlights 44
 - Intermittent mode (windshield wipers) 50
 - Random
 - refer to* Shuffle 194
 - Range (fuel level) 14
 - Reading lights 47
 - Rear cross-traffic assist 137
 - Rear lid
 - refer to* Luggage compartment lid 35
 - Rear seats 57
 - Rearview camera 133
 - Rear window defogger 81
 - Rear wiper blades
 - Changing 52
 - Cleaning 52
 - Reception range 180
 - Recirculation mode 81
 - Recuperation 15
 - Refrigerant oil 270
 - Refueling 207
 - Remote control
 - Garage door opener 40
 - Remote control key 32
 - Remote control key 32
 - Convenience opening and closing 39
 - Key replacement 32
 - LED 34
 - PANIC function 32
 - Replacing the battery 34
 - Synchronization 34
 - Unlocking and locking 33
 - also refer to* Vehicle key 32
 - Removing the caps (wheel bolts) 248
 - Repairs 264
 - Repeat 194
 - Replacement key 32
 - Replacement parts 266
 - Replacing fuses 257
 - Reporting Safety Defects 266
 - Reverse gear
 - refer to* Gears 86
 - Rims 238
 - Cleaning 244
 - Rolling ability
 - Electromechanical parking brake 94
 - Transmission idle 86
 - Roof
 - refer to* Panoramic glass roof 40
 - Roof load 270
 - Roof rack 78
 - also refer to* Roof rack 78
 - Route guidance
 - Stopping 169
 - also refer to* Navigation 164
 - Running direction (tires) 251
- S**
- Safety belts 60
 - Cleaning 245
 - Locking 71
 - Securing child safety seats 71
 - Satellite map 174
 - Saving fuel
 - Energy consumers 15
 - Recuperation 15
 - Screen
 - refer to* Touch display 16
 - Screwdriver 248
 - SD card reader (MMI) 188
 - Search area (POI) 167
 - Search function
 - refer to* Free text search 195
 - Seat heating 81
 - Seats
 - Adjusting 56
 - Adjusting the front seats 57
 - Adjusting the rear seats 57
 - Cleaning 245
 - Folding 77
 - Head restraints 59
 - Selecting a source (media) 192
 - Selector lever 86

Index

- Self-learning navigation
 - refer to* Personal route assistance 172
- Sensors
 - Coverage areas 107
 - Locations 108
- Service interval display 222
- Setting measurement units 201
- Settings 201
 - Announcements and tones 201
 - Bluetooth 202
 - Date and time 201
 - Language 201
 - Measurement units 201
 - Media 196
 - Navigation 177
 - Radio 186
 - Sound 201
 - System 201
 - Time zone 201
 - Wi-Fi hotspot 160
- Setting the language 201
- Setting the time 201
- Shift paddles 87
- Shortcut
 - refer to* Shortcuts 21
- Shortcuts 21
- Shuffle 194
- Side assist 129
 - Cleaning the sensors 243
- SIM card 158
- SiriusXM alert notifications 183
- Sliding/tilting sunroof
 - refer to* Panoramic glass roof 40
- Smart Favorites 183
- Smartphone
 - Wireless charging 145
 - also refer to* Telephone 143
- Snow chains 238
- Socket
 - refer to* Power sources 74
- Software
 - Update 202
- Software information
 - Legal information 203
- Software version (MMI)
 - Version information 203
- Sound
 - refer to* Adjusting the sound 201
- Space-saving spare tire (compact spare tire) 251
- Spare tire 251
- Speed limit information
 - refer to* Traffic sign recognition 110
- Speed limits
 - refer to* Traffic sign recognition 110
- Speedometer 11
- Speed warning system 110
- Sport mode
 - refer to* Electronic Stabilization Control 100, 101
- Start/Stop system 90
 - Switching off and on 92
- Starting to drive 85
- Starting (engine) 91
- Steering 99
 - Audi drive select 98
 - also refer to* Steering 99
- Steering lock 83, 84, 99
- Steering wheel
 - Adjusting 58
 - Adjusting manually 58
 - Shift paddles 87
 - Steering wheel heating 81
 - also refer to* Multifunction steering wheel 12
- Steps for determining correct load limit 237
- Stopover (navigation) 169
- Stopping (engine) 91
- Storage areas 75
- Stored stations
 - refer to* Presets 182
- Streaming
 - refer to* Online media 189
- Subwoofer 251
- Sunshade
 - Roof 40
 - also refer to* Panoramic glass roof 40
- Sun visors 49
- Suspension 99
 - Audi drive select 98
- Swap call 150

- Symbols
 Navigation 170
 Traffic 176
also refer to Indicator lights 7
- Synchronization (climate control system) 80
- System settings 201
- T**
- Tachometer 11, 13
- Tail lights
 Cleaning 243
- Technical data 269
- Technical modifications 264
- Telephone 143
 Audi phone box 145
 Connecting a mobile phone 143
 Dialing a number 149
 Options during a phone call 150
 Playing music 188
- Temperature display (outside temperature) . . 14
- Temperature gauge
 Coolant 11
- Text input 22
- Text messages
 Settings 151
 Text messaging settings 151
also refer to Text messages 151
- Tie-downs 77
- Tightening specification
 Wheel bolts 251
- Tightening specification (wheel bolts) 251
- Time 14
- tiptronic
refer to Manual shifting 87
- Tires 223
 Changing 248
 Low-profile tires 239
 Service life 232
 Tire pressure 233
 Tire pressure monitoring system 240
 Tire pressure table 235
 Tire pressure (trailer mode) 103
 Treadwear indicators 232
 Unidirectional 225, 251
 Uniform tire quality grading 239
- Tires and wheels
 Glossary of tire and loading terminology . . 226
 Tires and vehicle load limits 235
- Tool 248
- Top tether anchor (securing the child safety seat) 72
- Touch display
 Adjusting the brightness 18
 Operating 16
- Towing 254
- Towing loop 255, 256
- Towing protection monitoring 31
- TPMS
 Tire pressure monitoring system 240
- Traffic information 176, 177
- Traffic light information 112
- Traffic sign recognition 110
- Traffic signs 113
- Trailer load 270
- Trailer mode
 Trailer mode (navigation) 178
- Trailer towing 103
 Tongue weight 103
 Trailer load 103
- Trailer view 135
- Turn signals 45
- U**
- Uniform tire quality grading 239
- Unlocking and locking 28
 By remote control 33
 Using the lock cylinder 30
 With the central locking switch 30
 With the convenience key 33
- Update (software) 202
- Updating stations (radio) 180
- USB
 Adapter 145
- USB charging port 74
- USB stick
refer to Audi music interface 190
- V**
- Vanity mirror 50

Vehicle			
Care/cleaning	242		
Dimensions	269		
Identification data	269		
Out of service	247		
Raising	249		
Starting	83		
Unlocking and locking	33		
Vehicle care	242		
Vehicle data label	269		
Vehicle identification number	269		
Vehicle jack	248		
Lifting points	249		
Vehicle key	28, 32		
Vehicle starting system	92		
Vehicle tool kit	248		
Ventilation	79		
VIEW button	12		
Voicemail	149		
Voice recognition system			
External	25		
Operating	24		
W			
Warning lights			
<i>refer to</i> Indicator lights	7		
Washing matte finish paint	242		
Weights	270		
Wheel bolts	238		
Changing a tire	248		
Wheels	223		
Cleaning	244		
Glossary of tire and loading terminology	226		
Replacing	248		
Tire pressure monitoring system	240		
Tires and vehicle load limits	235		
Wheel wrench	248		
Wi-Fi			
Hotspot settings	160		
Online media	189		
Using a hotspot	158		
Windows			
Child safety lock	38		
Cleaning and removing ice	244		
Convenience opening and closing	39		
Defogging	81		
Defrosting	80, 81		
Opening and closing	39		
Power windows	39		
Windshield			
Cleaning	50		
<i>also refer to</i> Windshield	50		
Windshield washer system	50, 222		
Reservoir capacity	269		
Windshield wipers	50		
Winter operation			
Car washes	242		
Cooling system	216		
Defrosting windows	81		
Rear window defogger	81		
Removing ice from windows	244		
Seat heating	81		
Snow chains	238		
Steering wheel heating	81		
Tires	238		
Vehicle battery (12 Volt)	220		
Windshield washer system	222		
Winter tires	238		
Wireless Apple CarPlay			
<i>refer to</i> Audi smartphone interface	199		
Wireless charging			
Audi phone box	145		

These instructions may not be reproduced or translated in whole or in part without written consent of AUDI AG. All rights reserved by AUDI AG.



For the sake of the environment

Printed on eco-friendly paper (bleached without chlorine, recyclable).

Owner's Manual
English North America 07.2020
83A012721BD



83A012721BD

www.audi.com