

INSIGNIA™

Full HD Dual Camera Dash Cam

NS-DCDCHH2



Before using your new product, please read these instructions to prevent any damage.



Contents

Introduction	2
IMPORTANT SAFEGUARDS	2
Features	2
Package contents	3
Components	3
Installing your dash cam	4
Using your dash cam	5
Formatting a MicroSD memory card	5
Manually turning your dash cam off and on	5
Understanding loop recording	5
Recording an emergency video	5
Taking photos	5
Downloading files to a computer	6
Menu options and settings	6
On-screen displays	8
Navigating in the on-screen display (OSD)	13
Troubleshooting	13
Specifications	14
ONE-YEAR LIMITED WARRANTY	15

Introduction

Congratulations on your purchase of a high-quality Insignia product. Your NS-DCDCHH2 represents the state of the art in dash cam design and is designed for reliable and trouble-free performance.

IMPORTANT SAFEGUARDS

- Always read the safety instructions and online *User Guide* carefully.
- Do not drop or allow forceful impacts to your dash cam, or install it in locations exposed to heavy vibrations.
- Do not disassemble or modify your dash cam in any way. Disassembly or modification may not only void the warranty, but may also cause damage.
- Do not use or store your dash cam in damp locations. Liquid entering your dash cam may cause damage or lead to fires or electric shock.
- Do not operate in extreme heat conditions. If your vehicle is parked in a hot sunny climate, let your vehicle cool down before using your dash cam.

Features

- 1080p resolution on front and rear-facing cameras
- 148-degree wide-angle lens
- 2.0" LCD display
- G-force sensor automatically starts recording on impact
- Built-in microphone to capture audio
- Loop recording overwrites the oldest footage and prevents you from running out of storage
- Enhanced night vision
- MicroSD card expandable to 256 GB (card is not included)

Package contents

- Full HD Dual Camera Dash Cam
- USB cable (11.8 ft. (3.6 m))
- Vehicle power adapter
- Mounting bracket with suction cup
- *Quick Setup Guide*

Components

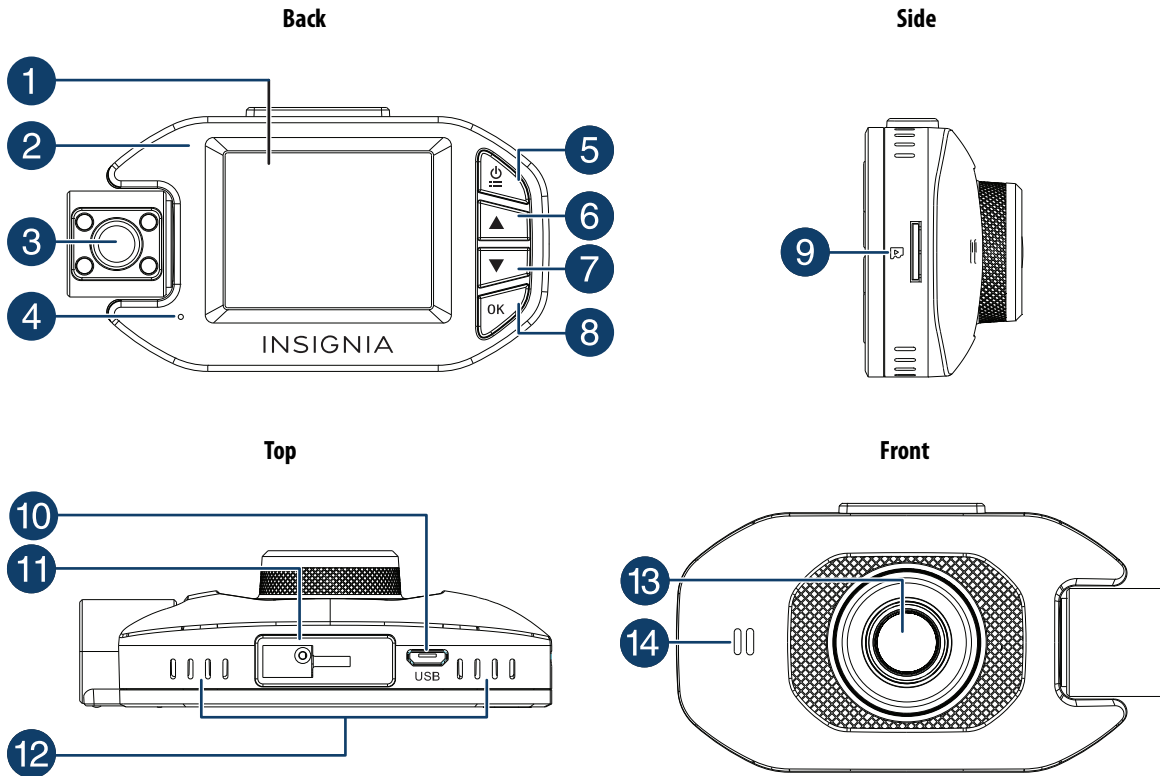

#	ITEM	DESCRIPTION
1	Screen	2.0-inch screen
2	Indicator LED	<ul style="list-style-type: none"> • Lights solid blue when you turn on your dash cam. • Blinks red when recording video.
3	Rear lens	HD camera
4	Microphone	Captures audio when turned on.
5	⏻ (power/set button)	<ul style="list-style-type: none"> • Press to manually turn your dash cam on. Press and hold for two seconds to turn your dash cam off. Note: Your dash cam automatically turns on when you start your vehicle. • When your dash cam is not recording, press to go to the <i>System Setting</i> screen. • In recording mode, press to start an emergency recording.?
6	▲ (up) button	<ul style="list-style-type: none"> • In menu mode, press to move up. • When your dash cam is either recording or not recording, press to enter camera mode, then press again to take a photo. • In the playlist, press to move up. • In playback mode, press to delete a video or photo.
7	▼ (down) button	<ul style="list-style-type: none"> • When your dash cam is recording, press to mute the audio. • In menu mode, press to move down. • In playback mode, press to select a playback file. • When your dash cam is not recording, press to open a list of the files on your memory card. • In playback mode, press to view the previous video or photo.

#	ITEM	DESCRIPTION
8	OK button	<ul style="list-style-type: none"> In live camera mode, press to start or stop recording. In playback mode, press to start or stop playback. In playback mode, press q to open a list of files on your memory card. Select a file for playback, then press OK to start playback. On the Formatting screen, press to start formatting the microSD card. In menu mode, press to confirm a selection. In emergency video mode, press to exit. On the <i>Restore Default Settings</i> screen, press to restore all settings to the factory settings.
9	MicroSD card slot	Insert a MicroSD card (8 GB to 256 GB) (not included) in this slot to store video files and photos. You must have a formatted card inserted to record or playback. See Formatting a MicroSD memory card on page 5.
10	Micro USB jack	Connect a micro USB cable to this jack to power the dash cam or to download files to a computer.
11	Suction cup mount	Attach the dash cam to this mount.
12	Ventilation openings	Let air into your dash cam to keep it cool. Do not block.
13	Front lens	HD camera
14	Speaker	Plays sound from your dash cam.

Installing your dash cam

Note: Use a card with 8 GB to 256 GB of memory. We recommend using a card with the highest memory capacity available. Higher memory capacity lets you record more.

- 1 Insert a MicroSD memory card (8 GB to 256 GB memory capacity) (not included) in the MicroSD card slot.

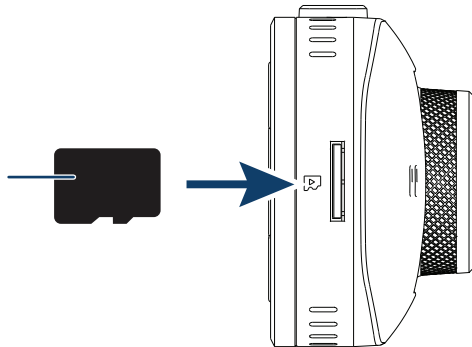

- 2 Clean and thoroughly dry the windshield area where you want to mount your dash cam.
- 3 Insert and slide the mounting bracket on the suction cup into the mounting slot on the top of your dash cam.
- 4 Peel the protective film from the mounting bracket and the dash cam lenses.
- 5 Position the suction cup on the center of the windshield, below the rear view mirror, then move the mounting bracket switch clockwise until you hear a click.



- 6 Connect the provided USB cable to the USB jack on your dash cam, then thread the cable from your dash cam, around the outer edge of the windshield, and to a 12V vehicle power socket.

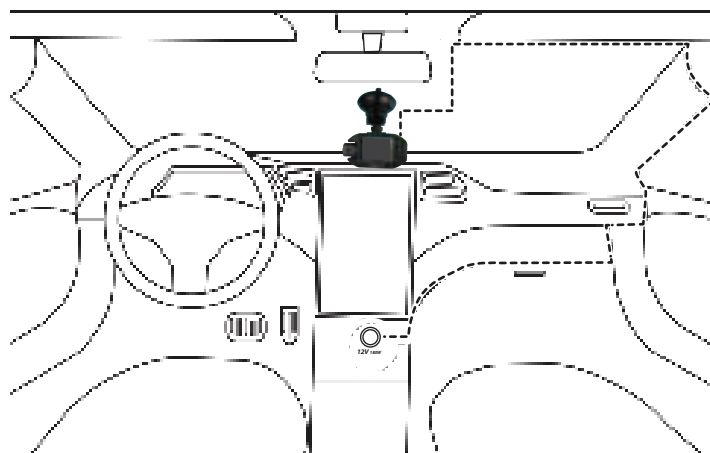

- 7 Plug the cable into the vehicle power adapter, then plug the adapter into the power socket and turn on your vehicle. Your dash cam starts automatically.

- 8 Rotate the mounting bracket to adjust the viewing angle as needed.

- 9 Follow the on-screen prompts to set up your dash cam. Make sure that you format the memory card during setup. If the card is not formatted, it may not record or play back. See [Formatting a MicroSD memory card](#) on page 5.

When you turn on your dash cam for the first time, you are prompted to enter basic setup information, such as Language, Year, Month, Day. See [Menu options and settings](#) on page 6.

Your dash cam uses this information when creating file names and when displaying time stamps. Subsequent startups go directly to the video screen.

Using your dash cam

Formatting a MicroSD memory card



You must format a memory card before you can use it in your dash cam. If the card isn't formatted, your dash cam may not be able to record or save.

Note: The first time you insert a new SD card into your dash cam, the screen will prompt you with one of the following error messages if there is an issue with the card:

- **CARD ERROR Replace SD Card** - indicates that the new card is not available to your dash cam (the card may be incompatible or damaged). Remove the SD card and replace it with another. Only SD cards between 8 and 256 GB should be used.

or

- **CARD ERROR FORMAT Card in Camera** - indicates that the formatting on the new card is not compatible with your dash cam. Use the Format tool to format the card. This will delete all of the information on your dash cam, so please save your files first.

- 1 Make sure that your dash cam is turned on and not in recording mode.
- 2 Press the  (power/set) button. The on-screen display opens.
- 3 Press the  (up) or  (down) button to select **Format**, then press the **OK** button,



CAUTION: When you format a memory card, it erases all the data on the card. Make sure that you backup any recordings you want to save. See [Downloading files to a computer](#) on page 6.

Manually turning your dash cam off and on

Your dash cam turns on automatically when you turn on your vehicle. You can manually turn your dash cam off, then turn it back on.

- Press and hold the  (power/set) button to turn your dash cam off. Press this button again to turn it back on.

Understanding loop recording

When the MicroSD memory card is full, your dash cam continuously overwrites the oldest footage recorded. To protect a specific video clip against being overwritten, press the  (power/set) button. The  (emergency recording) icon appears on the screen. You can also protect files on the playback screen in video playback mode.

Recording an emergency video

An emergency recording automatically starts when the G-Sensor registers an impact. Emergency recordings create protected (locked) files that are not overwritten by continuous loop recording. In addition, to make sure that important footage isn't lost surrounding an incident, adjacent video clips are locked if the incident happens within 30 seconds of the beginning or end of a clip.

You can manually start and stop an emergency video.

- When your dash cam is turned on, press the **OK** button to start recording. Press this button again to stop recording.

Taking photos

- Press the ▲ (up) button to enter camera mode. Press the ▲ button or the camera icon to take a photo.

Downloading files to a computer



You can transfer files from your dash cam to a computer.

- 1 Remove the MicroSD memory card from your dash cam and insert it into a card reader on your computer. The memory card appears as a mobile hard disk device in your list of files.
- 2 Download the files to your computer into a directory you can easily find.
- 3 On your computer, right-click the device, then select **Eject** from the option list that appears.
- 4 Remove the card and put it back in your dash cam.

Note: You can also connect the USB cable from the dash cam directly to your computer and access the MicroSD card files.

Menu options and settings











MENU	OPTION	SETTING
Menu Set	Resolution	Selects the camera resolution. You can select: <ul style="list-style-type: none"> • 1080p Front / 1080p Rear • 1080p Front / 720p Rear • 720p Front / 720p Rear
	Screen display	Sets what is displayed on-screen. You can select: <ul style="list-style-type: none"> • Front to display the video outside your vehicle. • Rear to display the video inside your vehicle. • PIP (picture-in-picture) to display the front video with a small window that displays the rear video. PIP is the default setting.
	Loop recording	Sets the time when the recording loop ends. You can select 1 min, 3 mins, or 5 mins . When the memory card is full, your dash cam deletes the oldest recordings to make room for new recordings. Your dash cam does not automatically delete emergency recordings. You must delete these recordings manually.
	Microphone setup	Turns the microphone On or Off .
	Exposure	Sets the white balance according to the available light. You can select a setting between -2.0 and +2.0. The default setting is +0 .
	Infrared lamp	Illuminates images in dark environments, such as night or low light situations. You can select On, Off, or Auto .
	Stamp setup	Turns the date and time stamp On or Off . If you select On , the date and time appear on the bottom of the screen. You can also turn on the input feature and enter identifying information, such as name, nickname, or make and model of a vehicle.
	Language	Sets the OSD language. You can select English, Français, or Español .
	Time setup	Sets the current date and time. Use the ▲ and ▼ buttons to select a number, then press the OK button to lock your selection and move to the next number field. When you finish, press the OK button to save your entry. The date and time is part of the file name for each recording.
	Driver ID setting	Lets you enter the vehicle license plate number. Use the ▲ and ▼ buttons to select a number, then press the OK button to lock your selection and move to the next number field. When you finish, press the OK button to save your entry. This information is stored as part of the time stamp.

MENU	OPTION	SETTING
Menu Set (continued)	Button beep	Each time you press a button, a beep sounds. You can turn the beep On or Off .
	LCD auto off	Sets the amount of time before the screen saver turns on. You can select 1 min , 3 mins , or Off .
	Volume setting	Sets beep and speaker playback volume. You can select MUTE , Low , Medium , or High .
	WDR	(Wide Dynamic Range) Automatically adjusts the camera exposure. You can select On or Off .
	Frequency	Light source frequency. You can select 50Hz or 60Hz .
	Format Memory Card	Formats the memory card. Press the OK button to start formatting. CAUTION: When you format a memory card, it erases all the data on the card. Make sure that you backup any recordings you want to save. See Downloading files to a computer on page 6.
	Default settings	Resets all dash cam settings to the factory defaults. Press the OK button to reset.
	Version Info	Displays the system software version.
Feature	Driver fatigue alarm	Displays the  icon and beeps once to remind you to rest. You can select 1h , 2h , 4h , or Off . If you do not stop for a break, the alarm is repeated every 30 minutes.
	Remind lights	If your dash cam detects a low light situation when you turn on your vehicle, displays the  icon to remind you to turn on your headlights. You can select On or Off .
	Motion detect	When Motion detect is turned on, your dash cam automatically starts recording when it detects movement within 10 ft. (3 m), such as people walking. If no additional motion is detected in 10 seconds, recording stops. Both cameras support motion detection. You can select On or Off .
	G-sensor sensitivity	When the G-Sensor detects an impact, it automatically starts an emergency recording to save the recorded images in a locked file. An emergency file cannot be overwritten by the loop recording. The G-sensor sensitivity option lets you adjust the G-sensor sensitivity. You can select High , Medium , or Low .



On-screen displays

Video recording screen



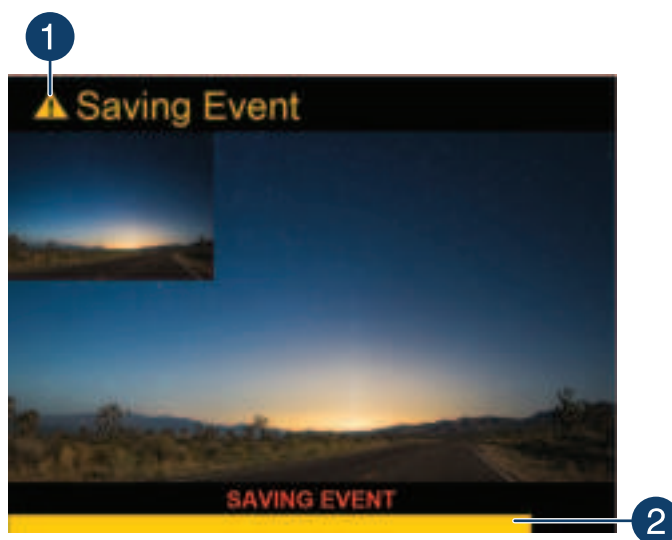





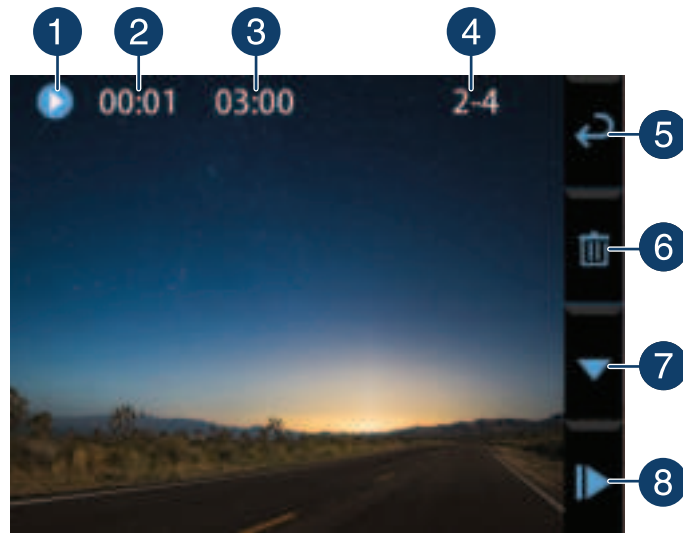

#	ICON	NAME	DESCRIPTION
1		Recording in progress	Lights when your dash cam is recording.
2		Recording time	Shows how long your dash cam has been recording.
3		Resolution	Shows the video resolution.
4		Loop video time	Shows the number of minutes for the loop recording.
5		Voice recording state	Shows whether the voice recording feature is on or off.
6		Motion detection	Lights when the motion detection feature is on.
7		IR on	Lights when the IR lamp is in use.
8		Emergency recording	Press to start an emergency recording.
9		Photo	Press to enter camera mode.
10		Voice recording	Press to mute the audio or to start recording sound.
11		Stop a recording	When recording, press to stop recording.
12		Time	Displays the current date and time.

Emergency video screen







#	ICON	NAME	DESCRIPTION
1		Emergency recording	Lights while your dash cam is capturing an emergency recording.
2		Emergency video progress bar	Shows the elapsed recording time.

Playback screens



#	ICON	NAME	DESCRIPTION
1		Playback icon	Lights when your dash cam is playing a file.
2	00:01	Playback time	Shows the amount of time a file has been playing.
3	03:00	File time	Shows the total file time.
4	2-4	Number of pages	Shows the current and total number of playback pages.
5		Return	Press to go to the previous playback page.
6		Delete	Press to delete the currently selected file.
7		Select file	Press to select the next video file.
8		Play and pause	Press the  (play) icon to start video playback. The icon changes to the  (pause) icon. Press the  icon to pause playback.



#	ICON	NAME	DESCRIPTION
1	00:30:00	Memory remaining	Shows the amount of recording time left on the memory card.
2		Settings	Press to open the <i>Settings</i> menu.
3		Camera	Press to enter camera mode.
4		Play and pause	Press the  (play) icon to start video playback. The icon changes to the  (pause) icon. Press the  icon to pause playback.
5		Start recording	Press to start a video recording.

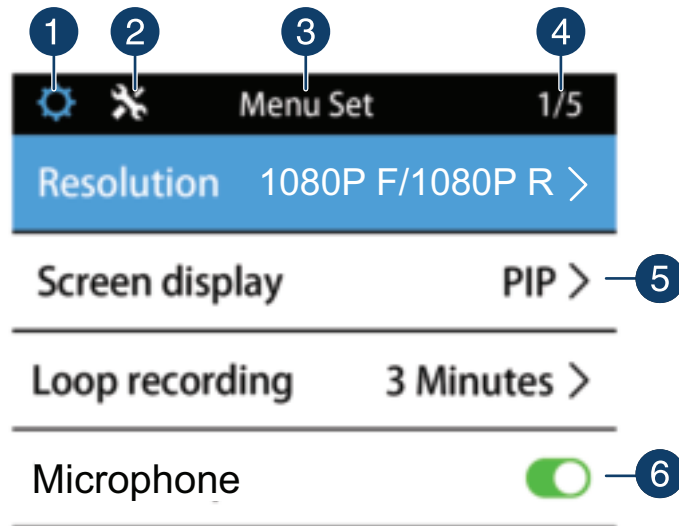

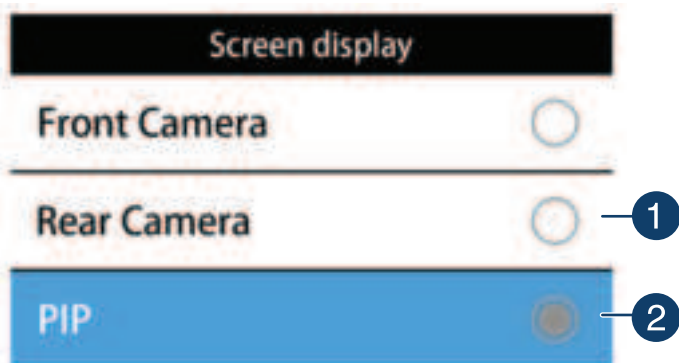

#	ICON	NAME	DESCRIPTION
1		System settings	Press to open the <i>Settings</i> menu.
2		Function settings	Press to open the <i>Function</i> menu.
3	MENU SET	Menu name	Shows the current menu name.
4	1/5	Menu page	Shows the current and total number of menu pages.
5		Open the list of settings	When multiple settings are available, press to see the settings.
6		Function switch	When the settings for an option are on and off, press to toggle the settings.



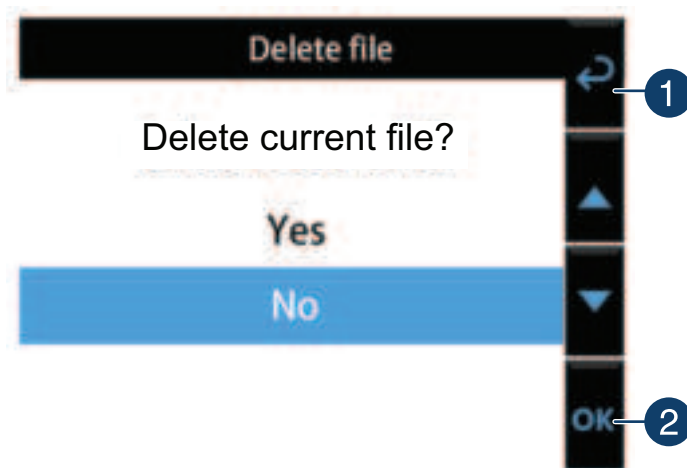





#	ICON	NAME	DESCRIPTION
1		Not selected	Shows that a setting is not selected. Touch the icon to select the setting.
2		Selected	Shows that a setting is currently selected. If you select a different setting, this icon changes to the "not selected" icon.





#	ICON	NAME	DESCRIPTION
1		Return	Press to return to the previous screen.
2		OK	Press to confirm you selection.

Navigating in the on-screen display (OSD)

- 1 Make sure that your dash cam is turned on and not in recording mode.
- 2 Press the  (power/set) button. The *Menu Set* screen opens.
- 3 Press the  (up) or  (down) button to select an option.
- 4 If the option has multiple settings, press the  button to see the available settings.
- 5 Press the  (up) or  (down) button to select a setting, then press the **OK** button to confirm your selection.
- 6 To return to the previous menu, press the  (power/set) button.

Troubleshooting

PROBLEM	SOLUTION
My dash cam won't turn on.	<ul style="list-style-type: none"> • Make sure that your vehicle is turned on. Some vehicles don't power the power socket if the vehicle is turned off. • Make sure that your vehicle's power socket is clean and free of corrosion. • Make sure that the USB cable is securely connected to your dash cam and the power adapter. • Make sure that the power adapter is firmly seated in your vehicle's power socket and that the status LED is on. • Make sure that the memory card is formatted. If the card is not formatted, it can't record or save. See Formatting a MicroSD memory card on page 5.
My dash cam seems to be stalled or "hung up."	<ul style="list-style-type: none"> • Press and hold the  (power/set) button to turn your dash cam off, then press and hold the button again to turn it back on. • Unplug the USB cable, then plug it back in.
The time isn't correct.	<ul style="list-style-type: none"> • Your dash cam can remember the time for seven days at room temperature. If you have used your dash cam for an extended time, you may need to reset the time. When your dash cam isn't recording, press the  (power/set) button to open the menu, then select the Time setup option. For more information, see Time setup on page 6.
My pictures and video are blurry.	<ul style="list-style-type: none"> • Clean the lens with a lens cloth.
The video quality is poor.	<ul style="list-style-type: none"> • Make sure that you set your dash cam to the 1080p resolution. A higher resolution makes the image clearer, sharper, more defined, and more detailed.

PROBLEM	SOLUTION
I don't want some of my videos overwritten.	<ul style="list-style-type: none"> In recording mode, press  to manually activate the emergency video mode. Files recorded in this mode are protected and aren't overwritten. Copy recordings to a computer.
The mounting bracket won't firmly mount to the windshield.	<ul style="list-style-type: none"> Make sure that the glass is not dirty or wet. Make sure that you removed the protective film on the back of mounting bracket.
Videos don't have sound or I don't want videos to have sound.	<ul style="list-style-type: none"> Turn the Volume Set option on the <i>Menu Set</i> screen On or Off.
I can't transfer videos or photos to a computer.	<ul style="list-style-type: none"> We recommend that you remove the memory card and insert it into a card reader on your computer. If you are using a USB cable, make sure that you use the provided cable. Some USB cables are only for charging and can't transfer files.

Specifications

Specifications are subject to change without notice.

Dimensions (H × W × D)	2 × 3.7 × 1.2 in. (5.2 × 9.5 × 3.1 cm) These measurements do not include the mounting bracket or suction cup.
Weight	2.6 oz. (75 g)
Temperature	Operating temperature: -4° ~ 149° F (-20° ~ 65° C) Storage temperature: -22° ~ 176° F (-30° ~ 80° C)
Resolution	720p (1280 × 720) 1080p (1920 × 1080)
Frame rate	30 fps
Image format	Photo: JPG Recording: MOV
Display	2.0-in. LCD
Lens angle	Front: 148° Rear: 110°
MicroSD card capacity	8 GB ~ 256 GB
OSD languages	English, Spanish, and French

ONE-YEAR LIMITED WARRANTY

Definitions:

The Distributor* of Insignia branded products warrants to you, the original purchaser of this new Insignia-branded product ("Product"), that the Product shall be free of defects in the original manufacture of the material or workmanship for a period of one (1) year from the date of your purchase of the Product ("Warranty Period").

For this warranty to apply, your Product must be purchased in the United States or Canada from a Best Buy branded retail store or online at www.bestbuy.com or www.bestbuy.ca and is packaged with this warranty statement.

How long does the coverage last?

The Warranty Period lasts for 1 year (365 days) from the date you purchased the Product. Your purchase date is printed on the receipt you received with the Product.

What does this warranty cover?

During the Warranty Period, if the original manufacture of the material or workmanship of the Product is determined to be defective by an authorized Insignia repair center or store personnel, Insignia will (at its sole option): (1) repair the Product with new or rebuilt parts; or (2) replace the Product at no charge with new or rebuilt comparable products or parts. Products and parts replaced under this warranty become the property of Insignia and are not returned to you. If service of Products or parts are required after the Warranty Period expires, you must pay all labor and parts charges. This warranty lasts as long as you own your Insignia Product during the Warranty Period. Warranty coverage terminates if you sell or otherwise transfer the Product.

How to obtain warranty service?

If you purchased the Product at a Best Buy retail store location or from a Best Buy online website (www.bestbuy.com or www.bestbuy.ca), please take your original receipt and the Product to any Best Buy store. Make sure that you place the Product in its original packaging or packaging that provides the same amount of protection as the original packaging.

To obtain warranty service, in the United States and Canada call 1-877-467-4289. Call agents may diagnose and correct the issue over the phone.

Where is the warranty valid?

This warranty is valid only in the United States and Canada at Best Buy branded retail stores or websites to the original purchaser of the product in the country where the original purchase was made.

What does the warranty not cover?

This warranty does not cover:

- Customer instruction/education
- Installation
- Set up adjustments
- Cosmetic damage
- Damage due to weather, lightning, and other acts of God, such as power surges
- Accidental damage
- Misuse
- Abuse
- Negligence
- Commercial purposes/use, including but not limited to use in a place of business or in communal areas of a multiple dwelling condominium or apartment complex, or otherwise used in a place of other than a private home.
- Modification of any part of the Product, including the antenna
- Display panel damaged by static (non-moving) images applied for lengthy periods (burn-in).
- Damage due to incorrect operation or maintenance
- Connection to an incorrect voltage or power supply
- Attempted repair by any person not authorized by Insignia to service the Product
- Products sold "as is" or "with all faults"
- Consumables, including but not limited to batteries (i.e. AA, AAA, C etc.)
- Products where the factory applied serial number has been altered or removed
- Loss or Theft of this product or any part of the product
- Display panels containing up to three (3) pixel failures (dots that are dark or incorrectly illuminated) grouped in an area smaller than one tenth (1/10) of the display size or up to five (5) pixel failures throughout the display. (Pixel based displays may contain a limited number of pixels that may not function normally.)
- Failures or Damage caused by any contact including but not limited to liquids, gels or pastes.

REPAIR REPLACEMENT AS PROVIDED UNDER THIS WARRANTY IS YOUR EXCLUSIVE REMEDY FOR BREACH OF WARRANTY. INSIGNIA SHALL NOT BE LIABLE FOR ANY INCIDENTAL OR CONSEQUENTIAL DAMAGES FOR THE BREACH OF ANY EXPRESS OR IMPLIED WARRANTY ON THIS PRODUCT, INCLUDING, BUT NOT LIMITED TO, LOST DATA, LOSS OF USE OF YOUR PRODUCT, LOST BUSINESS OR LOST PROFITS. INSIGNIA PRODUCTS MAKES NO OTHER EXPRESS WARRANTIES WITH RESPECT TO THE PRODUCT, ALL EXPRESS AND IMPLIED WARRANTIES FOR THE PRODUCT, INCLUDING BUT NOT LIMITED TO ANY IMPLIED WARRANTIES OF AND CONDITIONS OF MERCHANTABILITY AND FITNESS FOR A PARTICULAR PURPOSE, ARE LIMITED IN DURATION TO THE WARRANTY PERIOD SET FORTH ABOVE AND NO WARRANTIES, WHETHER EXPRESS OR IMPLIED, WILL APPLY AFTER THE WARRANTY PERIOD. SOME STATES, PROVINCES AND JURISDICTIONS DO NOT ALLOW LIMITATIONS ON HOW LONG AN IMPLIED WARRANTY LASTS, SO THE ABOVE LIMITATION MAY NOT APPLY TO YOU. THIS WARRANTY GIVES YOU SPECIFIC LEGAL RIGHTS, AND YOU MAY ALSO HAVE OTHER RIGHTS, WHICH VARY FROM STATE TO STATE OR PROVINCE TO PROVINCE.

Contact Insignia:

1-877-467-4289

www.insigniaproducts.com

INSIGNIA is a trademark of Best Buy and its affiliated companies.

*Distributed by Best Buy Purchasing, LLC

7601 Penn Ave South, Richfield, MN 55423 U.S.A.

©2020 Best Buy. All rights reserved.

INSIGNIA™

For product inquiries, please contact us with the information below:

1-877-467-4289

www.insigniaproducts.com

INSIGNIA is a trademark of Best Buy and its affiliated companies.

Distributed by Best Buy Purchasing, LLC

7601 Penn Ave South, Richfield, MN 55423 U.S.A.

©2020 Best Buy. All rights reserved.

V2 ENGLISH
20-0355