



BAR 500MK2



OWNER'S MANUAL



IMPORTANT SAFETY INSTRUCTIONS

Verify Line Voltage Before Use

The JBL BAR 500MK2 has been designed for use with 100-240 volt, 50/60 Hz AC current. Connection to a line voltage other than that for which your product is intended can create a safety and fire hazard and may damage the unit. If you have any questions about the voltage requirements for your specific model or about the line voltage in your area, contact your retailer or customer service representative before plugging the unit into a wall outlet.

Do Not Use Extension Cords

To avoid safety hazards, use only the power cord supplied with your unit. We do not recommend that extension cords be used with this product. As with all electrical devices, do not run power cords under rugs or carpets, or place heavy objects on them. Damaged power cords should be replaced immediately by an authorized service center with a cord that meets factory specifications.

Handle the AC Power Cord Gently

When disconnecting the power cord from an AC outlet, always pull the plug; never pull the cord. If you do not intend to use this speaker for any considerable length of time, disconnect the plug from the AC outlet.

Do Not Open the Cabinet

There are no user-serviceable components inside this product. Opening the cabinet may present a shock hazard, and any modification to the product will void your warranty. If water accidentally falls inside the unit, disconnect it from the AC power source immediately, and consult an authorized service center.

TABLE OF CONTENTS

IMPORTANT SAFETY INSTRUCTIONS 2

1. INTRODUCTION 4

2. WHAT'S IN THE BOX 5

3. PRODUCT OVERVIEW 6

- 3.1 Soundbar 6
 - 3.2 Subwoofer 7
 - 3.3 Remote control 7
-

4. PLACE 8

- 4.1 Desktop placement 8
 - 4.2 Wall-mounting 9
-

5. CONNECT 9

- 5.1 Connect with your TV and digital devices 9
 - 5.2 Connect to your Bluetooth device 10
 - 5.3 Connect to your home network 11
-

6. SETUP 12

- 6.1 Connect power 12
 - 6.2 3D surround sound 12
-

7. PLAY 14

- 7.1 Power-on/Auto standby/Auto wakeup 14
- 7.2 Play from the TV source 14
- 7.3 Play from the HDMI IN source 15
- 7.4 Play from the Bluetooth source 15
- 7.5 Play over your home network 15
- 7.6 Multi-room playback 16

8. ADVANCED USAGE 17

- 8.1 Sound settings (Audio sync) 17
 - 8.2 Factory reset 17
 - 8.3 Software update 17
-

9. RE-CONNECT THE SUBWOOFER 18

10. PRODUCT SPECIFICATIONS 19

11. TROUBLESHOOTING 20

12. TRADEMARKS 22

13. OPEN SOURCE LICENSE NOTICE 23

1. INTRODUCTION

Thank you for purchasing the JBL BAR 500MK2 which is designed to bring an extraordinary 3D sound experience to your home entertainment system. We encourage you to take a few minutes to read through this manual, which describes the product and includes step-by-step instructions for setting up and getting started.

To make the most of product features and support, you may need to update the product software through the Internet in the future. Refer to the software update section in this manual to ensure that your product has the latest software.

Designs and specifications are subject to change without notice. If you have any questions about the soundbar, installation or operation, please contact your retailer or customer service representative, or visit our website: www.jbl.com.

JBL One app

With the JBL One app, you can

- easily complete product setup;
- connect *music streaming services;
- discover new music with integrated music services;
- access software updates when they are available;
- personalize audio settings;
- access additional features.

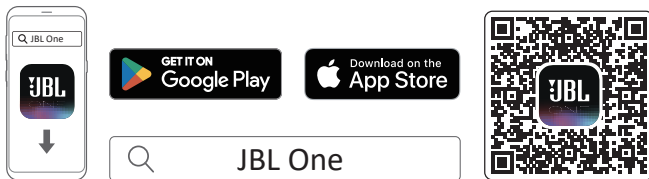

For more information, see “[5.3 Connect to your home network](#)” and “[7.5 Play over your home network](#)”.

NOTES:

- *Subscription may be needed and not provided by the JBL One app.
- App screens in this Owner’s Manual may vary due to software updates. Always follow the app instructions.

2. WHAT'S IN THE BOX

Unpack the box carefully and ensure that the following parts are included. If any part is damaged or missing, do not use it and contact your retailer or customer service representative.

Soundbar



Subwoofer

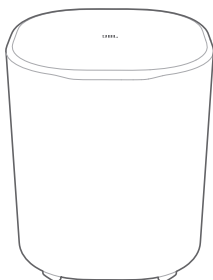

Remote control (with 2 AAA batteries)

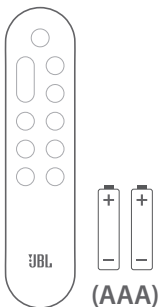

Power cord*

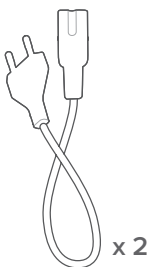

x 2

* Power cord quantity and plug type vary by regions.

HDMI cable (1.2m / 3.9 ft)

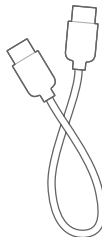

Wall-mounting kit



Product information & wall-mounting template

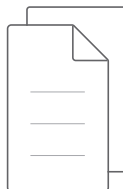

3. PRODUCT OVERVIEW

3.1 Soundbar

3.1.1 Front panel & Top panel

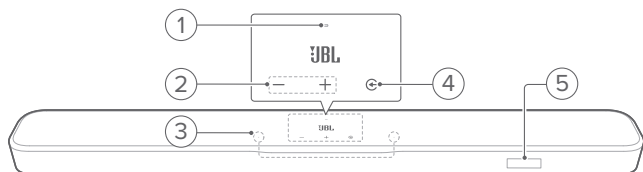

1) Status indicator

System:		
	Regular pulsing (white)	System startup
	Fast pulsing (white)	Software updating in progress
	Solid (amber)	Restoring factory settings
Network connection:		
	Slow pulsing (white)	Wi-Fi setup mode, or network disconnected
	Solid (white)	Network connected
	Solid (yellow)	Weak Wi-Fi connection

2) - / + (Volume)

- Switch on.
- Decrease or increase the volume.
- Press the two buttons together to mute or unmute.
- Hold the two buttons together for more than 10 seconds to enter Wi-Fi setup mode.

3) Microphone

- For sound calibration

4) ⏪ (Source)

- Switch on.
- Select a sound source: **TV** (default, for audio input from TV connection where the **HDMI OUT / HDMI OUT** connector is prioritized over the **OPTICAL / OPTICAL** connector), Bluetooth or **HDMI IN**.
- Hold for more than 3 seconds to enter Bluetooth pairing mode.

5) Status display

3.1.2 Back panel

Americas version (excluding Brazil)

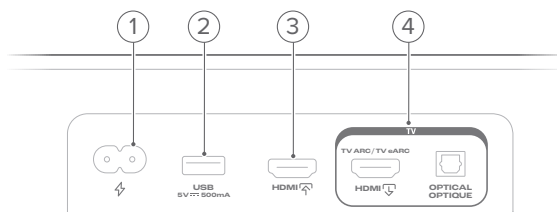

All other versions

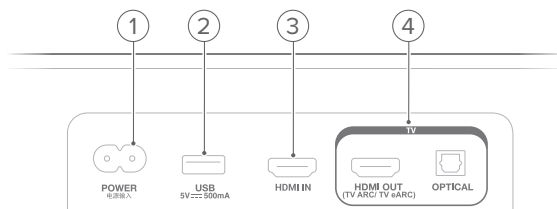

1) ⚡ / POWER

- Connect to power (with the supplied power cord).

2) USB

- USB connector for software update (for service only).
- Connect to USB storage device for MP3 file playback (for US version only).

3) HDMI IN

- Connect to the HDMI output on your digital device.

4) TV connectors

HDMI OUT / HDMI OUT

- Connect to the HDMI ARC / HDMI eARC input on your TV.

OPTICAL / OPTICAL

- Connect to the optical output on your TV or digital device.

3.2 Subwoofer

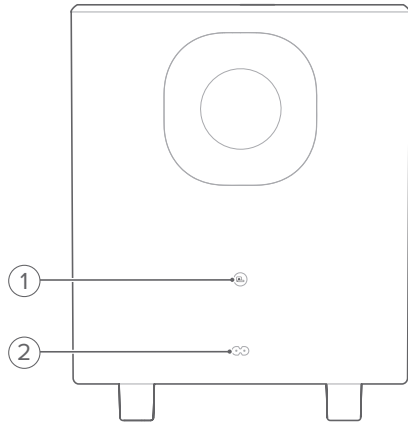

1)

- Connection status indicator

	Solid (white)	Connected to the soundbar
	Fast flashing (white)	Pairing mode
	Regular flashing (white)	Reconnecting mode
	Solid (amber)	Standby mode

2) Power connector

- Connect to power (with the supplied power cord).

3.3 Remote control

Americas version
(excluding Brazil)

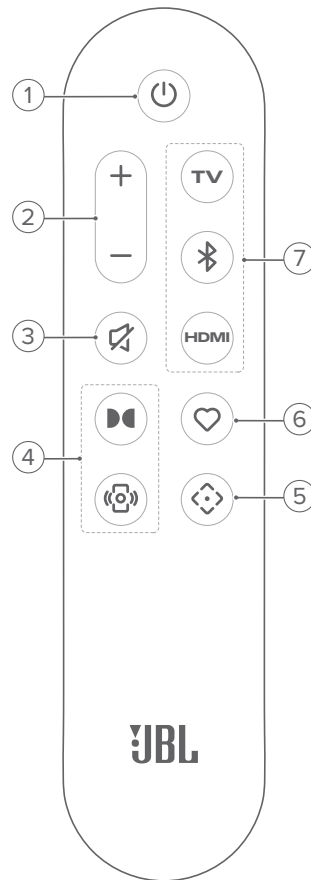

All other versions

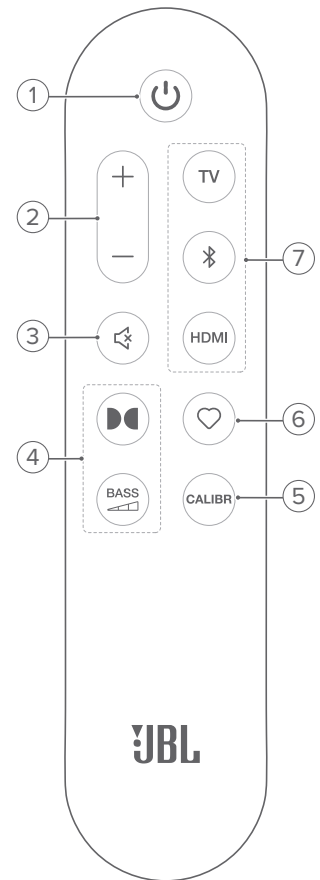

1)

- Switch on or to standby.

2)

- Press to increase or decrease the volume.
- Hold to increase or decrease the volume continuously.

3) (Mute)

- Mute / unmute.

4) Sound effect buttons



- Switch the virtual Dolby Atmos® sound effects on or off (Default: on).

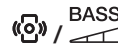

- Select the bass level: 1/2/3 (default)/4/5.

5) / CALIBR

- Start sound calibration.

6) (Moment)

- Press to directly access the playlist or speaker settings that you have personalized in the JBL One app.

7) Source selectors

TV

- Select the **TV** source (default, for audio input from TV connection where the **HDMI OUT** / **HDMI OUT** connector is prioritized over the **OPTIQUE** / **OPTICAL** connector).

📶 (Bluetooth)

- Press to select the Bluetooth source.
- Hold for more than 3 seconds to enter Bluetooth pairing mode.

HDMI

- Select the **HDMI IN** source.

4. PLACE

4.1 Desktop placement

Place the product on a flat and stable surface. Refer to the recommended distance in the following diagram.

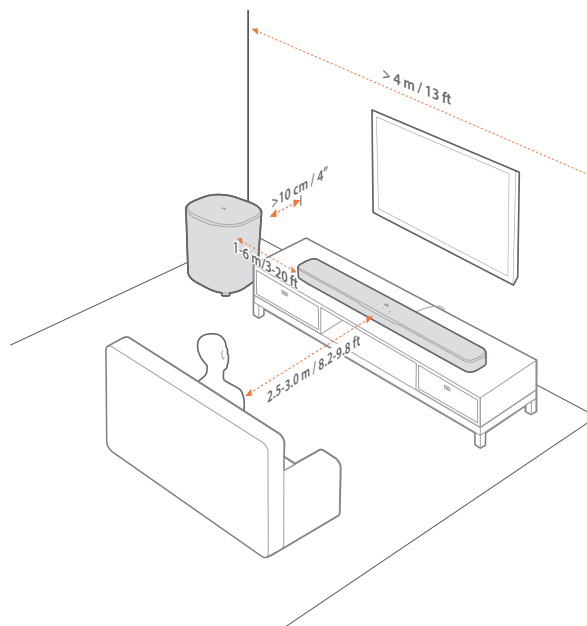

NOTES:

- The power cord shall be properly connected to power.
- Do not place any objects on the top of the product.

4.2 Wall-mounting

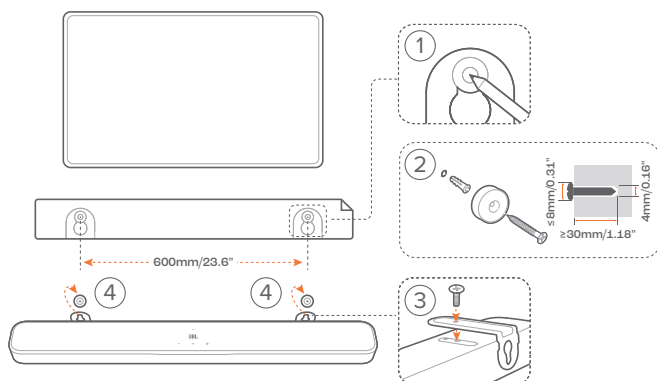

1. Preparation:

- Stick the supplied wall-mounting template to a wall by using adhesive tapes.
- Use your ballpen tip to mark the screw holder location. Remove the template.
- On the marked location, drill a 4 mm / 0.16" hole.

2. Install the support for wall-mounting bracket.

- With the screw, fasten the wall-mounting bracket onto the bottom of the soundbar.

4. Mount the soundbar.

NOTES:

- Make sure that the wall can support the weight of the soundbar.
- Install on a vertical wall only.
- Avoid a location under high temperature or humidity.
- Before wall-mounting, make sure that cables can be properly connected between the soundbar and external devices.
- Before wall-mounting, make sure that the soundbar is unplugged from power. Otherwise, it may cause an electric shock.

5. CONNECT

5.1 Connect with your TV and digital devices

For audio playback through the soundbar, connect the soundbar with your TV through the supplied HDMI cable or an optical cable (sold separately).

An HDMI connection supports digital audio and video with a single connection. HDMI connectivity is the best option for your soundbar.

NOTES:

- When both HDMI and optical cables are connected to the soundbar for audio input from TV connection, the HDMI connection is prioritized.
- Full compatibility with all HDMI-CEC devices is not guaranteed.
- * The HDMI cable (for digital device connection) and the optical cable are sold separately.

5.1.1 TV (HDMI eARC)

(Recommended connection for the best Dolby Atmos experience)

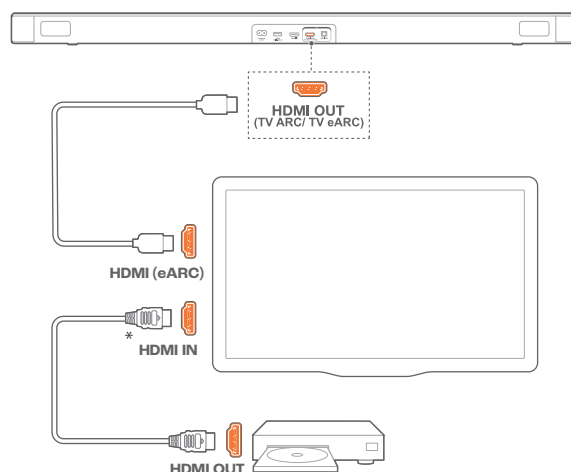

- Connect the soundbar with the **HDMI IN (eARC)** connector on your TV by using the supplied HDMI cable.
 - On your TV, check that HDMI-CEC and HDMI eARC have been enabled. Refer to the owner's manual of your TV for more information.
- Use an HDMI cable (V2.0 or later) to connect your TV with your digital device, such as a streaming device, set-top box, DVD/Blu-ray player or game console.
 - On your digital device, check that HDMI-CEC has been enabled. Refer to the owner's manual of your digital device for more information.
 - On your TV and digital device, select "Bitstream" or "Raw data" in the audio output settings for the best Dolby Atmos experience.

NOTES:

- To play audio from the digital device connected to your TV, select the **TV** source (See “7.2 Play from the TV source”).
- With the Virtual Dolby Atmos design, the Dolby surround upmixer of the soundbar can expand the legacy channel-based audio of Dolby Digital format, including 5.1 and 7.1 content, and provide an immersive 3D Atmos experience.

5.1.2 TV (HDMI ARC)

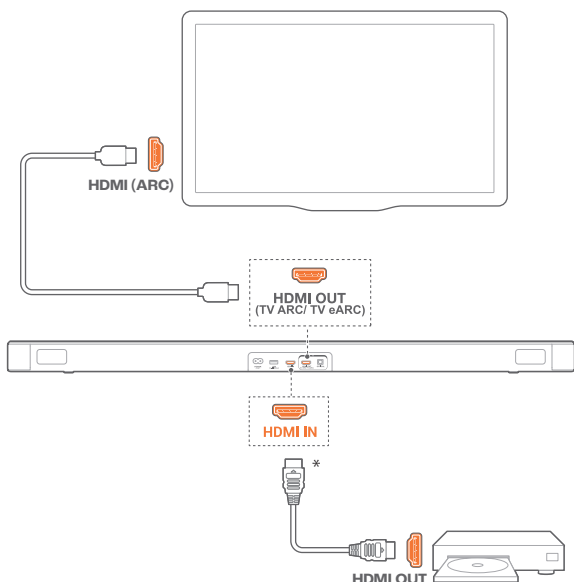

1. Connect the soundbar with the **HDMI IN (ARC)** connector on your TV by using the supplied HDMI cable.
 - On your TV, check that HDMI-CEC and HDMI ARC have been enabled. Refer to the owner's manual of your TV for more information.
2. Use an HDMI cable (V2.0 or later) to connect the soundbar with your digital device, such as a set-top box, DVD/Blu-ray player or game console.
 - On your digital device, check that HDMI-CEC has been enabled. Refer to the owner's manual of your digital device for more information.
 - On your digital device, select “Bitstream” or “Raw data” in the audio output settings for the best Dolby Atmos experience.

NOTES:

- To play audio from the digital device connected to the soundbar, select the **HDMI IN** source (See “7.3 Play from the HDMI IN source”).
- If your TV does not support HDMI eARC, make sure that you connect your digital device through the **HDMI IN / HDMI IN** connector on the soundbar instead of your TV. Otherwise, the Dolby Atmos information cannot pass through the HDMI (ARC) connectors to the soundbar.

5.1.3 OPTICAL

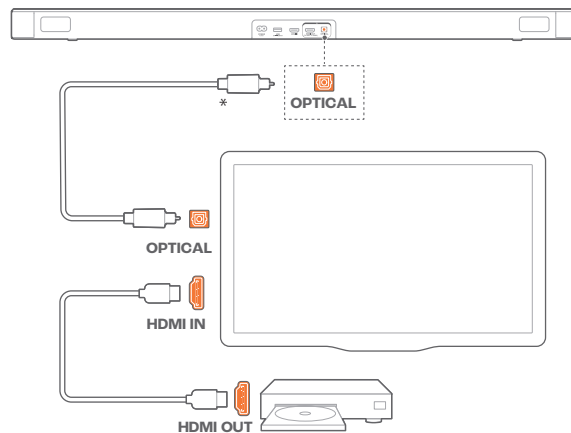

1. Connect the soundbar with your TV by using an optical cable.
2. Use an HDMI cable (V2.0 or later) to connect your TV with your digital device, such as a streaming device, set-top box, DVD/Blu-ray player or game console.

NOTE:

- To play audio through the optical cable, select the **TV** source (See “7.2 Play from the TV source”).

5.2 Connect to your Bluetooth device

Through Bluetooth, connect the soundbar with your Bluetooth device, such as a smartphone, tablet and laptop.

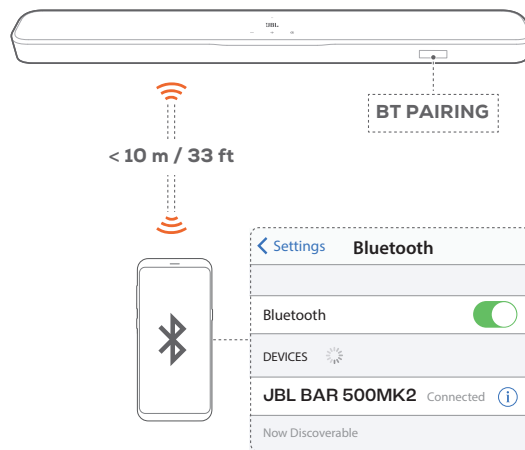

5.2.1 Connect a Bluetooth device

1. To select Bluetooth source, press **⏮** on the soundbar or **⏮** on the remote control.
 - “**BT PAIRING**”: Ready for Bluetooth pairing
2. On your Bluetooth device, enable Bluetooth and search for “**JBL BAR 500MK2**” within three minutes.
 - “**BT CONNECTED**”: Successful connection. A confirmation tone is heard.

5.2.2 Reconnect the last paired device

Your Bluetooth device is retained as a paired device when the soundbar goes to standby mode. Next time you switch to the Bluetooth source, the soundbar reconnects the last paired device automatically.

5.2.3 Connect to another Bluetooth device

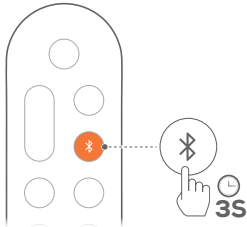

1. In the Bluetooth source, hold **C** on the soundbar or **BT** on the remote control until **"BT PAIRING"** is displayed.
→ The soundbar enters the Bluetooth pairing mode.
2. Follow the Step 2 under ["5.2.1 Connect a Bluetooth device"](#).
 - If the device has ever been paired with the soundbar, first unpair **"JBL BAR 500MK2"** on the device.

NOTES:

- The Bluetooth connection will be lost if the distance between the soundbar and Bluetooth device exceeds 10 m / 33 ft.
- Electronic devices may cause radio interference. Devices that generate electromagnetic waves must be kept away from the soundbar, such as microwaves and wireless LAN devices.

5.3 Connect to your home network

With the JBL One app and the supported streaming services (Google Cast, AirPlay, and Spotify Connect), the soundbar allows you to stream audio from smartphones or tablets.

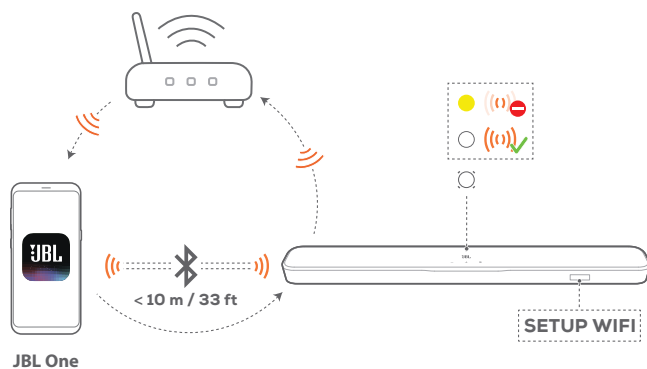

1. On the soundbar, enter the Wi-Fi setup mode:
 - Press any button to wake up the soundbar (See ["7.1 Power-on/Auto standby/Auto wakeup"](#)).
 - If the soundbar has not been connected to a network, the screen shows **"HELLO"** and then, **"SETUP WIFI"**.

2. Connect your Android™ or iOS device to your home Wi-Fi network. Download the JBL One app.
3. Launch the JBL One app. Follow the app instructions to complete Wi-Fi setup.

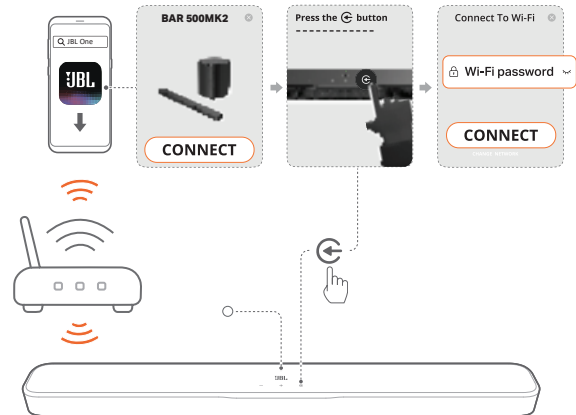

- ○ (Solid white): The soundbar is connected to your home network.
- You can stream music from the JBL One app or the streaming services you have enabled in the JBL One app (See ["7.5 Play over your home network"](#)).

NOTES:

- If your soundbar is not discovered by the JBL One app, hold **–** and **+** together for more than 10 seconds to re-enter the Wi-Fi setup mode.
- On your Android or iOS device, you can rename the soundbar in the JBL One app.
- On your iOS device, add the soundbar to the Apple Home app and manage it together with other AirPlay-compatible speakers.
- On your iOS device, if the soundbar has been added to your home Wi-Fi network, you can start AirPlay streaming from an AirPlay-compatible app (See ["7.5.2 Play through AirPlay"](#)).
- Availability of online music streaming services varies by country.
- Some features require subscriptions or services not available in all countries.

6. SETUP

6.1 Connect power

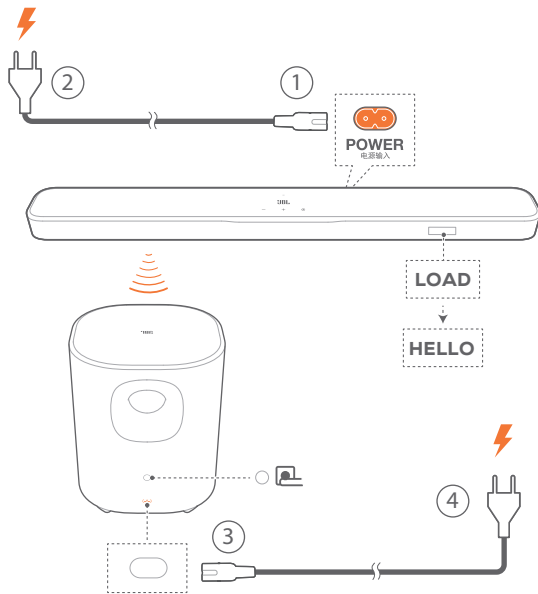

1. Connect the soundbar to power by using the supplied power cord.
→ The screen on the soundbar shows “LOAD” and then, “HELLO”.
2. Connect the subwoofer to power by using the supplied power cord.
→ The subwoofer is connected to the soundbar automatically. **Connected:** turns solid white.

NOTES:

- Use the supplied power cord only.
- Before connecting to power, make sure that you have completed all other connections (See “[5.1 Connect with your TV and digital devices](#)”).

6.2 3D surround sound

6.2.1 Sound calibration

Optimize your 3D surround sound experience for your unique listening environment.

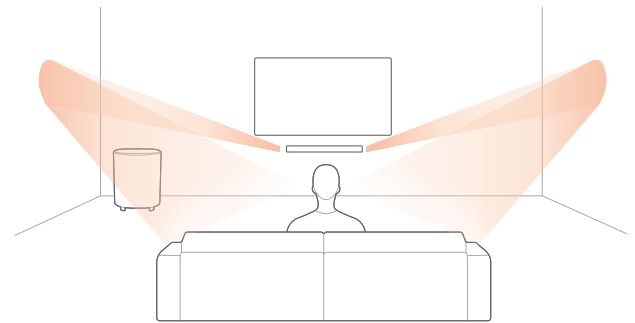

1. On the remote control, press / CALIBR to start calibration.
→ “CALIBRATION” is displayed on the soundbar.

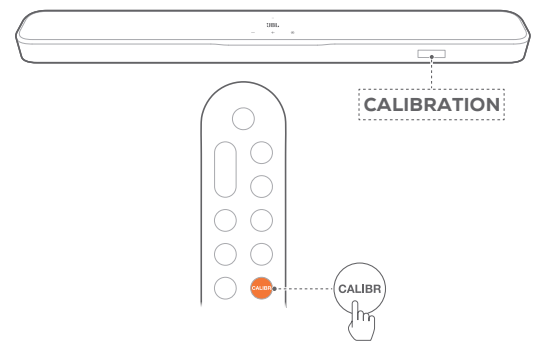

2. When “PRESS AGAIN TO CONFIRM” is displayed, press / CALIBR again.

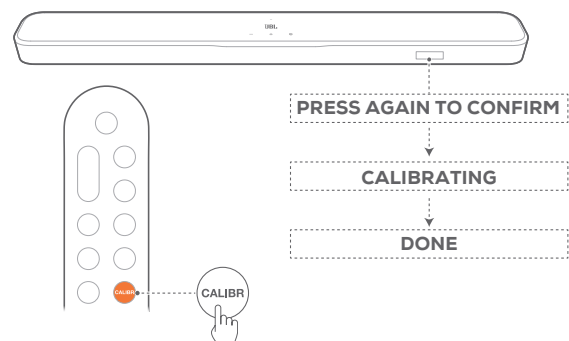

- Countdown starts from 5 to 1.
- Calibration tone is heard. Audio calibration starts.
“CALIBRATING”: Calibration in progress
“DONE”: Calibration completed successfully

NOTES:

- During sound calibration, all buttons on the remote control are disabled except for .
- During sound calibration, environmental sound will be recorded. Hold / CALIBR for more than 10 seconds, then press / to play the recorded audio (for US version only).

6.2.2 Dolby Atmos

With the virtual Dolby Atmos, enjoy height sound effects when you play movies in the **TV / HDMI IN** source.

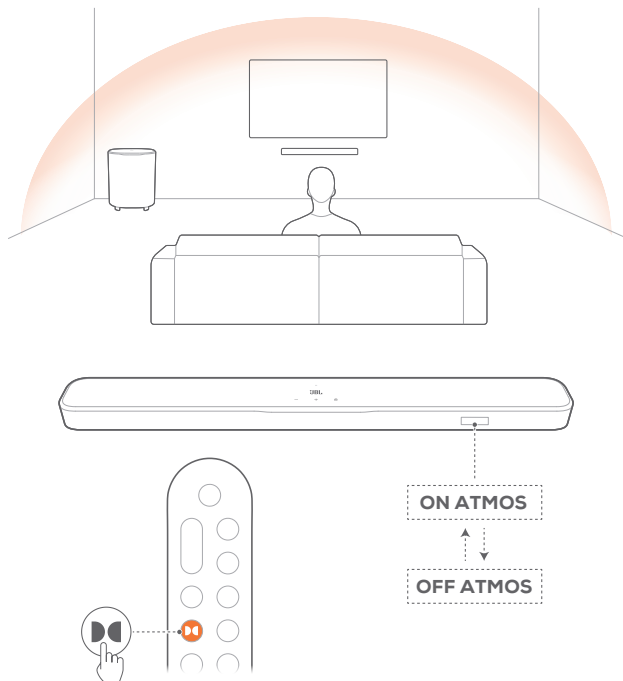

1. Connect and play your Blu-ray player or streaming device as described under [“5.1 Connect with your TV and digital devices”](#).
2. Press  on the remote control to switch the height sound effects on or off (Default: on).

NOTES:

- If you prefer not to have any height sound effects during your viewing or listening, switch off the Dolby Atmos sound effects.
- The Dolby Atmos sound effects apply only to Dolby Atmos audio content.

6.2.3 Bass adjustment

You can make bass adjustment as needed.

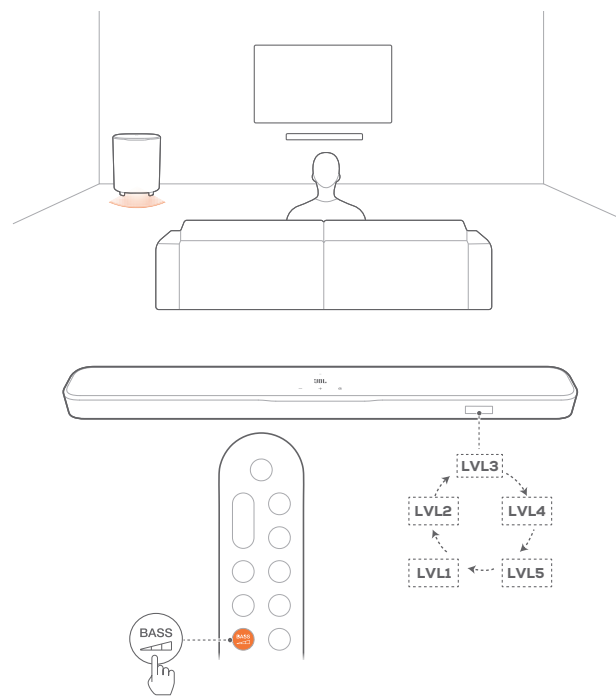

- On the remote control, press  /  to switch between bass levels.
→ “LVL1” to “LVL5” is displayed (Default: “LVL3”).

7. PLAY

7.1 Power-on/Auto standby/Auto wakeup

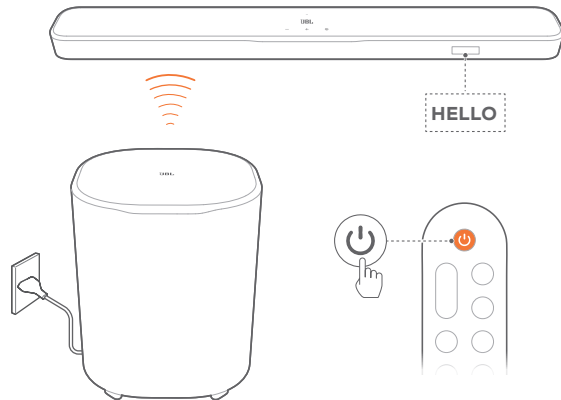

7.1.1 Switch on

To switch on, press any button on the soundbar, or  on the remote control.

→ The subwoofer is reconnected to the soundbar automatically.

Connected:  turns solid white.

7.1.2 Auto standby

If the soundbar is inactive for more than 10 minutes, it will switch to standby mode automatically. **"STDBY"** is displayed. Next time you switch on the soundbar, it returns to the last selected source.

→ The subwoofer also goes to standby, and  turns solid amber.

7.1.3 Auto wakeup

In standby mode, the soundbar will wake up automatically when

- the soundbar is connected to your TV through the HDMI eARC/ARC connection and your TV is switched on;
- the soundbar is connected to your TV and digital device such as a set-top box, DVD / Blu-ray player or game console through HDMI cables, and your digital device is switched on;
- the soundbar is connected to your home network and audio is streamed to the soundbar through the music streaming services.

7.2 Play from the TV source

With the soundbar connected, you can enjoy TV audio from the soundbar.

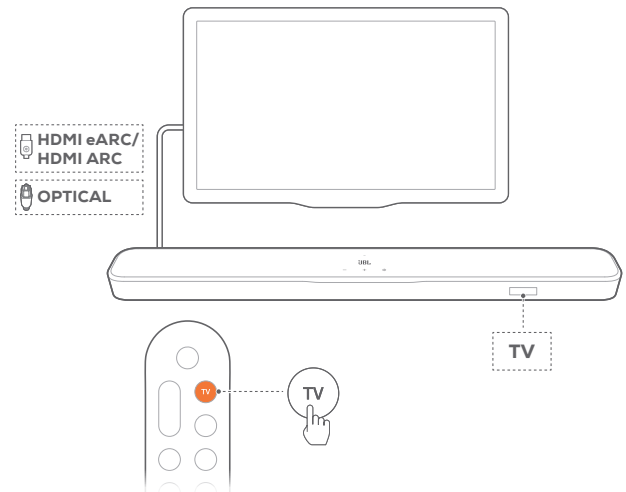

1. Make sure that your TV is set to support external speakers and the built-in TV speakers are muted. Refer to the owner's manual of your TV for more information.
2. Make sure that the soundbar has been properly connected to your TV (See ["5.1 Connect with your TV and digital devices"](#)).
3. To select the **TV** source, press  on the soundbar or **TV** on the remote control.
 - **"TV"**: The TV source is selected.
 - In the factory settings, the TV source is selected by default.

NOTE:

- If the soundbar is connected to your TV through both an HDMI cable and an optical cable, the HDMI cable source is selected for the TV connection.

7.2.1 TV remote control setup



To use your TV remote control for both your TV and the soundbar, check that your TV supports HDMI-CEC. If your TV does not support HDMI-CEC, follow the steps under ["TV remote control IR learning"](#).

HDMI-CEC

If your TV supports HDMI-CEC, enable the functions as instructed in your TV user manual. You can control the "volume +/-, mute/unmute, and power on/standby" functions on your soundbar through the TV remote control.

TV remote control IR learning

Through IR learning, you can program the soundbar to accept IR commands from your TV remote control, and then use your TV remote control for simple commands.

1. On the soundbar, hold  and  until **"LEARNING"** is displayed.
 - The soundbar enters the TV remote control learning mode.

2. Point your TV remote control at the soundbar. Follow the screen instructions to operate the buttons on your TV remote control:

- When any one of **“POWER”**, **“VOL+”**, **“VOL-”**, or **“MUTE”** is displayed on the soundbar, press the desired button on your TV remote control.
 - **“DONE”**: These commands are learned by the soundbar.
 - The soundbar returns to the last selected source.
- To exit the TV remote control learning mode, hold **⏪** and **+** on the soundbar until **“EXIT LEARNING”** is displayed.
 - The learnt functions are discarded.

NOTE:

- The soundbar will automatically exit the TV remote control learning mode if no action is taken for 30 seconds. The learnt functions are discarded.

7.3 Play from the HDMI IN source

With the soundbar connected as shown, your digital device can play video on your TV and audio from the soundbar.

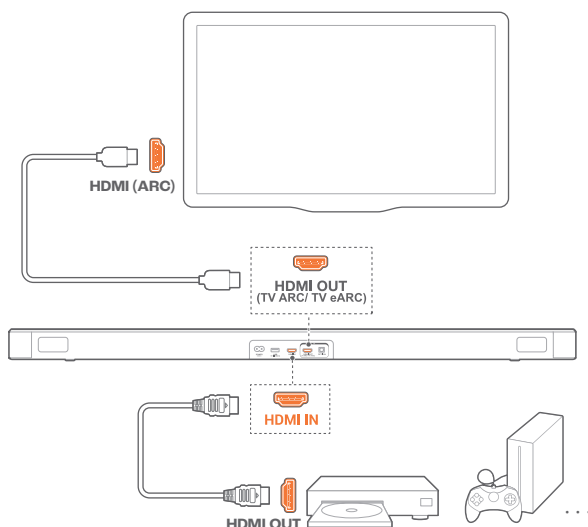

1. Make sure that the soundbar has been properly connected to your TV and digital device (See [“5.1 Connect with your TV and digital devices”](#)).
2. Switch on your digital device.
 - Your TV and the soundbar wake up from standby mode and switch to the input source automatically.
 - To select the **HDMI IN** source on the soundbar, press **⏪** on the soundbar or **HDMI** on the remote control.

NOTE:

- Full compatibility with all HDMI-CEC devices is not guaranteed.

7.4 Play from the Bluetooth source

Through Bluetooth, stream audio play on your Bluetooth device to the soundbar.

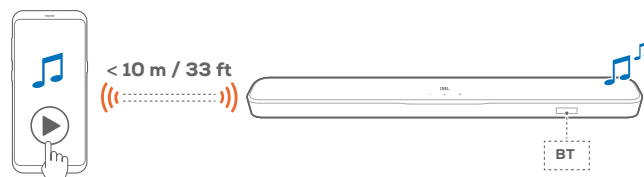

1. To select the Bluetooth source, press **⏪** on the soundbar or **⏪** on the remote control.
2. Check that the soundbar has been properly connected to your Bluetooth device (See [“5.2 Connect to your Bluetooth device”](#)).
3. Start audio play on your Bluetooth device.
4. Adjust the volume on the soundbar, remote control or your Bluetooth device.

7.5 Play over your home network

NOTES:

- The soundbar can support audio streaming, but not video streaming.
- During Wi-Fi music streaming, music playback will pause on the currently connected device when you start music playback on a second connected device.

Before you start, make sure that:

- your Android or iOS device is connected to the same Wi-Fi network as your soundbar (See [“5.3 Connect to your home network”](#)).

7.5.1 Play with Google Cast

With Google Cast, stream audio on your Android or iOS device to the soundbar.

On your Android or iOS device:

1. Launch the JBL One app, and check that you have enabled Google Cast.

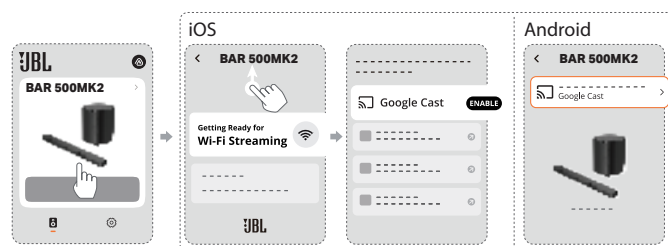

- On a Google Cast-enabled app, play music, tap the cast icon  and select the connected soundbar.



7.5.2 Play through AirPlay

Through AirPlay, stream audio on your iOS device to the soundbar.

On your iOS device:

- Swipe down from the upper right corner to enter the Control Center.
- Tap  to select the connected soundbar and then start audio streaming from an app.

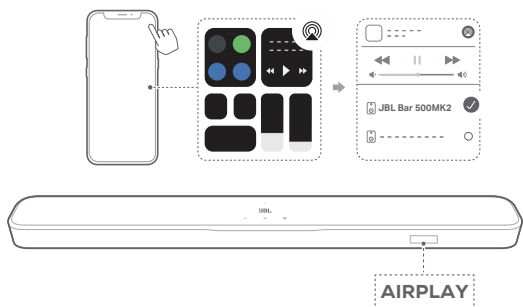

7.5.3 Play through the JBL One app

Through the JBL One app, stream audio from enabled music services to the soundbar.

On your Android or iOS device,

- Launch the JBL One app, browse the available *music streaming services to select music, and then start music streaming to the connected soundbar.

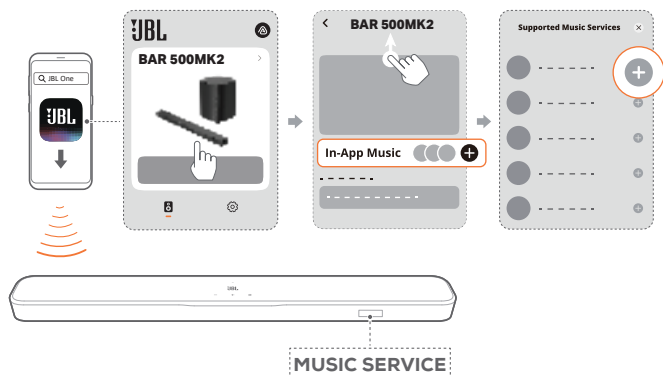



NOTE:

- *Subscription may be needed and not provided by the JBL One app.

Access your presets with the (Moment) button

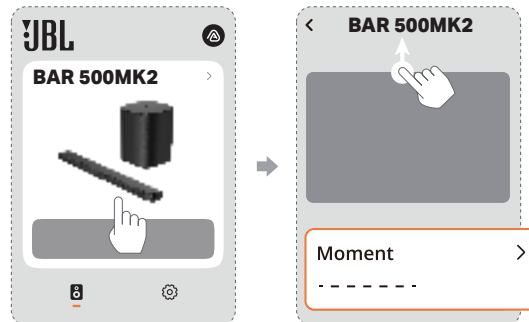
- On the JBL One app,
 - Personalize the  (Moment) feature.



- On the soundbar,
 - Press  on the remote control to access the personalized playlist and soundbar settings.

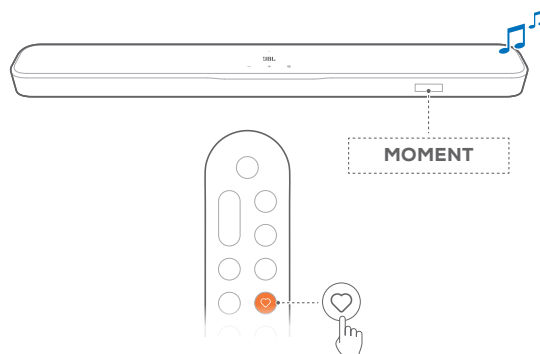

7.6 Multi-room playback

With the multi-room playback, you can stream music on your Android or iOS device to multiple Google Cast / AirPlay-enabled soundbars.

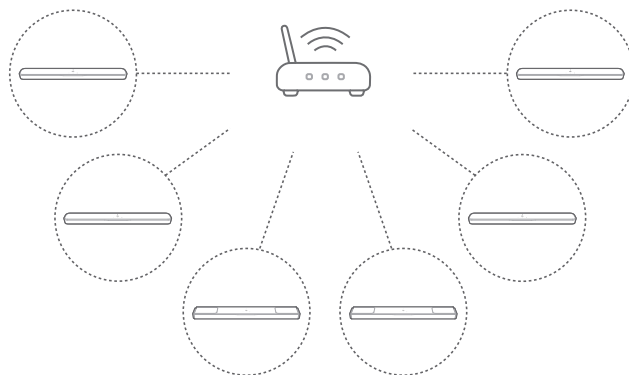

7.6.1 Google Cast

1. Through the Google Home app, connect multiple Google Cast-enabled soundbars to the same network, assign them to multiple rooms, and create groups as needed.
2. Run a Google Cast-enabled app on your smartphone or tablet.
3. Play music. Press  and select the grouped speakers.

NOTES:

- To create a multi-room speaker group in the Google Home app, make sure that you have connected all the soundbars to the same home network and have used the same Google login account. Refer to the Google Home app for more details.
- Depending on the bandwidth of your local network, you can stream music to up to 6 Google Cast-enabled soundbars.

7.6.2 AirPlay

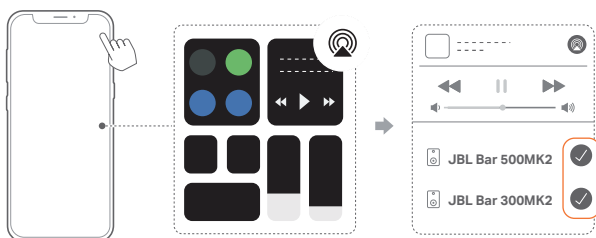

1. On an iOS device, enter the Control Center.
2. Tap  to select multiple connected speakers as needed.
3. Start music streaming from an app.

8. ADVANCED USAGE

8.1 Sound settings (Audio sync)

With the audio sync function, you can synchronize audio and video to make sure that no delay is heard from your video content.

1. On the remote control, hold **TV** for more than 3 seconds and then press **+**.
 - **“SYNC”** is displayed.
2. Within 5 seconds, press **+** or **-** on the remote control to adjust the audio delay and match with video.
 - The audio sync timing is displayed.

NOTE:

- You can also adjust the audio delay through the JBL One app.

8.2 Factory reset

To restore the factory settings, hold , **+** and **-** for more than 5 seconds.

- **“RESET”** is displayed.
- When the factory reset is complete, the soundbar will automatically restart.

8.3 Software update



Connect the soundbar to your home network. Online updates will be performed automatically when software updates are available.



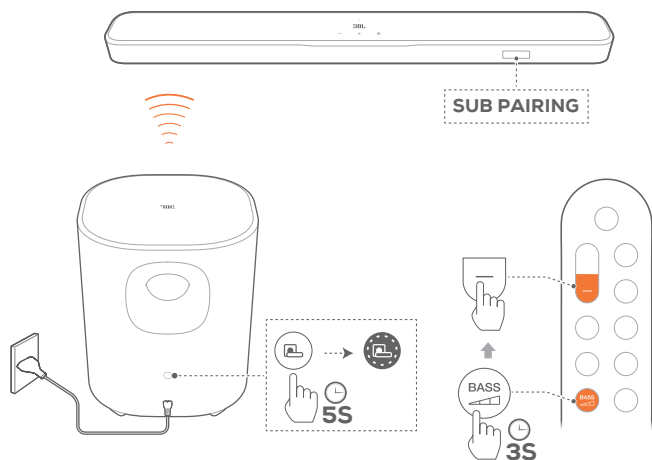

- **“WAIT”**: Software updating in progress
- **“DONE”**: Software updating completed

9. RE-CONNECT THE SUBWOOFER



The soundbar and subwoofer are paired at the factory. After power-on, they are paired and connected automatically. In some special cases, you may need to pair them again.



To re-enter the subwoofer pairing mode

1. On the rear panel of subwoofer, hold  until it turns fast flashing white.
2. To enter the subwoofer pairing mode on the soundbar, hold  /  on the remote control for more than 3 seconds, and then press  on the remote control.
 - “SUB PAIRING”: The subwoofer is ready for pairing.
 - “SUB PAIRED”: The subwoofer is connected.

NOTE:

- If pairing is not completed within 3 minutes, the subwoofer will exit pairing mode and enter standby.  turns from fast flashing white to off. To return to the pairing mode, press .

10. PRODUCT SPECIFICATIONS

General specification:

- Model: BAR 500MK2 (soundbar unit)
BAR 500MK2 SUB (subwoofer unit)
- Sound system: 5.1 channel
- Power supply: 100 - 240 V AC, ~ 50/60 Hz
- Total speaker power output* (Max. @THD 1%): 750 W
- Soundbar output power** (Max. @THD 1%): 450 W
- Subwoofer output power*** (Max. @THD 1%): 300 W
- Soundbar transducer: 5 x (42 x 80) mm racetrack drivers, 4 x 0.75" (20 mm) tweeters
- Subwoofer transducer: 10" (260 mm)
- Networked standby power: <2.0 W
- Operating temperature: 0 °C - 45 °C

HDMI specification

- HDMI video input: 1
- HDMI video output (with Enhanced Audio Return Channel, eARC): 1
- HDMI HDCP version: 2.3
- HDR pass through: HDR10+, Dolby Vision

Audio specification

- Frequency response: 40 Hz - 20 kHz (-6 dB)
- Audio inputs: Optical, Bluetooth, USB (USB playback is available in US version. For other versions, USB is for Service only.)

USB specification (Audio playback is for US version only):

- USB port: Type A
- USB rating: 5 V DC, 0.5 A
- Supporting file formats: mp3
- MP3 codec: MPEG 1 Layer 2/3, MPEG 2 Layer 3, MPEG 2.5 Layer 3
- MP3 sampling rate: 16 - 48 kHz
- MP3 bitrate: 80 - 320 kbps

Wireless specification

- Bluetooth version: v5.3
- Bluetooth profile: A2DP v1.3, AVRCP v1.5
- Bluetooth transmitter frequency range: 2400 MHz - 2483.5 MHz
- Bluetooth transmitter power: <15 dBm (EIRP)
- Wi-Fi network: IEEE 802.11 a/b/g/n/ac/ax (2.4 GHz / 5 GHz)
- 2.4G Wi-Fi transmitter frequency range: 2412 - 2472 MHz (2.4 GHz ISM Band, USA 11 Channels, Europe and others 13 Channels)
- 2.4G Wi-Fi transmitter power: < 20 dBm (EIRP)
- 2.4G wireless transmitter frequency range: 2406 - 2474 MHz
- 2.4G wireless transmitter power: <10 dBm (EIRP)
- 5G Wi-Fi transmitter frequency range: 5.15 - 5.35 GHz, 5.470 - 5.725 GHz, 5.725 - 5.825 GHz

- 5G Wi-Fi transmitter power: 5.15 - 5.25 GHz <23 dBm, 5.25 - 5.35 GHz & 5.470 - 5.725 GHz <20 dBm, 5.725 - 5.825 GHz <14 dBm (EIRP)
Note: Band 5.6 - 5.64 GHz will be disabled when shipped to Australia / New Zealand.

Dimensions

- Main soundbar dimensions (W x H x D): 940 x 50.5 x 104 mm / 37" x 2.0" x 4.1"
- Subwoofer dimensions (W x H x D): 325 x 400 x 325 mm / 12.8" x 15.7" x 12.8"
- Soundbar weight: 2.9 kg / 6.5 lbs
- Subwoofer weight: 8.1 kg / 17.8 lbs
- Packaging dimensions (W x H x D): 1020 x 395 x 490 mm / 40.2" x 15.6" x 19.3"
- Packaging weight: 18.0 kg / 39.68 lbs (EMEA/UK/AU/NZ); 15.86 kg / 34.97 lbs (Others)

* RMS @THD 1%: 375 W

** RMS @THD 1%: 225 W

*** RMS @THD 1%: 150 W

11. TROUBLESHOOTING

Never try to repair the product yourself. If you have problems using this product, check the following points before you request services.

System

The unit will not turn on.

- Check if the power cord is plugged into power and the soundbar.

The soundbar has no response to button presses.

- Restore the soundbar to factory settings (See "[8.2 Factory reset](#)").

Sound

No sound from soundbar

- Make sure that the soundbar is not muted.
- Select the correct audio input source on the remote control.
- Connect the soundbar to your TV or other devices properly
- Restore the soundbar to factory settings (See "[8.2 Factory reset](#)").

Distorted sound or echo

- If you play audio from your TV through the soundbar, make sure that your TV is muted or the built-in TV speaker is disabled.

Audio and video are not synchronized.

- Enable the audio sync function to synchronize audio and video (See "[8.1 Sound settings \(Audio sync\)](#)").

No height sound effects of Dolby Atmos

- If your TV supports HDMI ARC only, make sure that you have connected your digital device to the soundbar through the **HDMI / HDMI IN** connector on the soundbar (See "[5.1.2 TV \(HDMI ARC\)](#)").
- Enjoy the sound effects of Dolby Atmos when you play movies from the TV / HDMI source. For audio streaming over Bluetooth or casting apps (enabled by Google Cast or AirPlay), Dolby Atmos is not supported.

Bluetooth

A device cannot be connected with the soundbar.

- Check if you have enabled Bluetooth on the device.
- If the soundbar has been paired with another Bluetooth device, reset Bluetooth (See "[5.2.3 Connect to another Bluetooth device](#)").
- If your Bluetooth device has ever been paired with the soundbar, reset Bluetooth on the soundbar, unpair the soundbar on the Bluetooth device, and then pair the Bluetooth device with the soundbar again (See "[5.2.3 Connect to another Bluetooth device](#)").

Poor audio quality from a connected Bluetooth device

- The Bluetooth reception is poor. Move the source device closer to the soundbar, or remove any obstacle between the source device and the soundbar.

The connected Bluetooth device connects and disconnects constantly.

- The Bluetooth reception is poor. Move the source device closer to the soundbar, or remove any obstacle between the source device and the soundbar.

Wi-Fi

Failed to connect to Wi-Fi

- Make sure that Wi-Fi is turned on.
- Make sure that you have selected the right network and entered the correct password.
- Make sure that your router or modem is turned on and within the range.
- In your router settings, make sure that you have set the security type to WPA2 or auto.
- Make sure that your soundbar is connected to the same wireless LAN as your smartphone or tablet.
- If you have difficulties in setting up Wi-Fi, re-enter the Wi-Fi setup mode by holding **+** and **-** on the soundbar until "**SETUP WIFI**" is displayed.

Playback

AirPlay cannot find the soundbar as an AirPlay speaker for music streaming.

- On your Apple device, update the software to the latest version: iOS 13.4 and later, macOS 10.15.4 and later, or tvOS 14.3.
- Make sure that your Apple device has been connected to the same network as the soundbar.
- For a PC running iTunes for Windows, you can stream music from your PC to the soundbar through Bluetooth.

Music playback does not work smoothly when the sound source switches from Bluetooth to Google Cast or AirPlay.

- The quality of audio casting and playback are dependent on the traffic and coverage of the network that connects the soundbar and your casting devices, such as phones, tablets and PCs.

Music playback does not resume when the sound source switches from Bluetooth to TV / HDMI IN, and then back to Bluetooth.

- The music playback in the Bluetooth device stops when the sound source switches from Bluetooth to TV / HDMI IN. When you switch back to the Bluetooth source, start music playback in the Bluetooth device again.

Remote control

The remote control does not work.

- Check if the batteries are drained. If so, replace them with new ones.
- Reduce the distance and angle between the remote control and the main unit.

Failed to complete the TV remote control learning

- Check if you are using an infra-red TV remote control. The IR learning is not supported by a Bluetooth TV remote control.

12. TRADEMARKS



The Bluetooth® word mark and logos are registered trademarks owned by Bluetooth SIG, Inc. and any use of such marks by HARMAN International Industries, Incorporated is under license. Other trademarks and trade names are those of their respective owners.



The terms HDMI, HDMI High-Definition Multimedia Interface, HDMI trade dress and the HDMI Logos are trademarks or registered trademarks of HDMI Licensing Administrator, Inc.



The Wi-Fi CERTIFIED™ Logo is a registered trademark of Wi-Fi Alliance®.

COMPATIBLE WITH



Dolby, Dolby Vision, Dolby Atmos, and the double-D symbol are registered trademarks of Dolby Laboratories Licensing Corporation. Manufactured under license from Dolby Laboratories. Confidential unpublished works. Copyright © 2012–2024 Dolby Laboratories. All rights reserved.



Google, Android, Google Home, Google Cast and other marks are trademarks of Google LLC.

Google Assistant is not available in certain languages and countries. Availability and performance of certain features, services, and applications are device and network dependent and may not be available in all areas.



Use of the Works with Apple badge means that an accessory has been designed to work specifically with the technology identified in the badge and has been certified by the developer to meet Apple performance standards.

Apple, and AirPlay are trademarks of Apple Inc., registered in the U.S. and other countries and regions.

To use AirPlay with JBL Bar 500MK2, the latest version of iOS, iPadOS, or macOS is recommended.



Use your phone, tablet or computer as a remote control for Spotify. Go to spotify.com/connect to learn how.

The Spotify Software is subject to third party licenses found here: <https://www.spotify.com/connect/third-party-licenses>.

ROON READY

Being Roon Ready means that HARMAN uses Roon streaming technology, for an incredible user interface, simple setup, rock-solid daily reliability, and the highest levels of audio performance, without compromise.



Manufactured under license from DTS, Inc. and/or its affiliates. For patents, see <https://xperi.com/dts-patents/>. DTS, the DTS logo, DTS:X, the DTS:X logo, Virtual:X, and the DTS Virtual:X logo are trademarks or registered trademarks of DTS, Inc. and/or its affiliates in the U.S. and/or other countries. © DTS, Inc. and/or its affiliates. All rights reserved.



13. OPEN SOURCE LICENSE NOTICE

This product contains open source software licensed under GPL. For your convenience, the source code and relevant build instruction are also available at https://harman-webpages.s3.amazonaws.com/Harman_One_OS_C_package_license_list.htm.

Please feel free to contact us at:

Harman Deutschland GmbH

ATT: Open Source, Gregor Krapf-Gunther, Parkring 3
85748 Garching bei Munchen, Germany

or OpenSourceSupport@Harman.com if you have additional question regarding the open source software in the product.



HARMAN International Industries,
Incorporated 8500 Balboa Boulevard,
Northridge, CA 91329 USA
www.jbl.com

© 2025 HARMAN International Industries, Incorporated.

All rights reserved.

JBL is a trademark of HARMAN International Industries, Incorporated, registered in the United States and/or other countries. Features, specifications and appearance are subject to change without notice.