

SNAPTAIN 

SP510

Foldable GPS Drone

USER MANUAL

Please read this manual carefully before flying and keep it well for future reference.

14⁺
FOR AGES

CONTENTS

DISCLAIMER AND SAFETY GUIDELINES.....	01
MAINTENANCE AND CARE.....	03
PRODUCT OVERVIEW.....	04
FLIGHT PREPARATION.....	06
FLIGHT OPERATION GUIDE.....	09
Remote Operation Guide.....	09
Pair the Remote with the Drone.....	09
Flight Calibration.....	10
Compass Calibration.....	10
Gyro Calibration.....	12
GPS Satellites Searching.....	12
Flight Instructions.....	13
Take-off.....	13
Flight Directions.....	14
Photo / Video.....	15
Speed Switch.....	16
Headless Mode.....	16
Point of Interest (POI).....	17
Attitude(ATTI) Mode.....	18
Flight Trimming.....	19

Return-to-Home (RTH).....	20
Smart RTH	20
Failsafe RTH.....	22
Low Battery RTH	22
Landing.....	23
Emergency Stop.....	24
App Operation Guide.....	24
Download and Install the App.....	24
Launch the App.....	25
Function Overview of the App.....	26
Settings.....	27
Take-off.....	28
Follow Me.....	29
Mark and Track.....	30
Waypoints.....	31
Photo / Video.....	31
Gestures for Photo / Video.....	32
Smart RTH.....	32
Landing.....	32
TRUBLESHOOTING.....	33
SPECIFICATIONS.....	34

DISCLAIMER AND SAFETY GUIDELINES

Please read the disclaimer carefully before using this product. By using it, you hereby agree to this disclaimer and signify that you have read them thoroughly.

- 01 Before flying, please make some practice with a simulator or seek for the instruction from a professional.
- 02 DO NOT fly above or near obstacles, crowds, open water, public road, high voltage power lines or trees.



- 03 DO NOT use the drone in severe weather conditions, such as a rainy day or windy day (wind speed is more than 5.5m/s), snow, hail, lightning, tornadoes, hurricanes, etc.



- 04 DO NOT fly the drone in the magnetic interference area, radio interference area, and government regulated no-fly zones.



- 05 The fast rotating motors and propellers are a potential hazard to cause serious damage and injury. A safe distance of 5m must be maintained from the drone at all times while it is operational. Fly with responsibility.



- 06 Please maintain line-of-sight of your drone at all times after it is powered up.
Do not rely on the camera image to control your drone.



- 07 This product is not a toy and not recommended for users under age 14.



- 08 This product is not intended for professional aerial drone photography.



- 09 All parts must be kept out of the reach of children to avoid CHOKE HAZARD.



- 10 **CAUTION:** Dispose of drone and batteries in accordance with local regulations. **DO NOT** treat it as household waste.



- 11 Be sure to observe all local regulations, obtain appropriate authorizations and understand risks. Please note it is solely your responsibility to comply with all flight regulations.

SNAPTAIN accepts no liability for damage, injury or any legal responsibility incurred directly or indirectly from the use of this product. The user shall observe safe and lawful practices including, but not limited to, those set forth in these Disclaimer and Safety Guidelines. SNAPTAIN reserves the right to update this user manual.



» MAINTENANCE AND CARE

- 01 Thoroughly check the drone after crash or violent impact.
- 02 Do not use or store the battery near fire.
- 03 Do not charge the battery if it is hot. Let it cool down first.
- 04 Do not charge the battery next to inflammable materials, such as bed, carpet, wood floors etc., or on surfaces that are electrically conductive. Do not leave the battery unattended while charging.
- 05 ONLY use the original USB cable provided. Unplug the charger once the battery is fully charged.
- 06 Remove the battery from the drone if it will not be used for a long time.
- 07 Store the drone and remote in a cool, dry place away from direct sunlight.
- 08 Be sure to clean off your drone with a dry cloth to prevent any moisture from getting onto the electronics.
- 09 Some parts of the drone and the remote are coated with lubricant, which may overflow during use, please use a cloth to clean it.
- 10 Do not try to disassemble or repair the product by yourself. Please contact SNAPTAIN for more help.
- 11 Please use the original battery provided. Use an incorrect type of battery may lead to fire hazards.
- 12 Do not dispose of the battery in fire or a hot oven, cut or mechanically crush the battery, as this may cause explosions.
- 13 Do not leave the battery in an extremely high-temperature environment that can result in an explosion or the leakage of flammable liquid or gas.
- 14 Do not expose the battery to the extremely low air pressure, as this may result in an explosion or the leakage of flammable liquid or gas.



» PRODUCT OVERVIEW

SP510 Drone

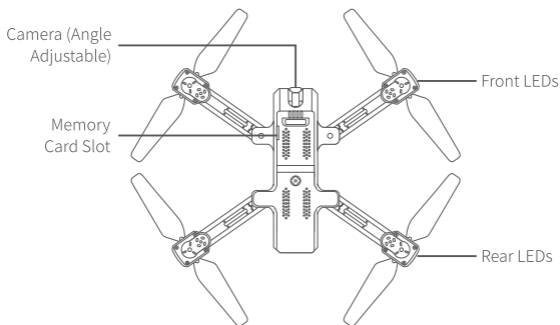
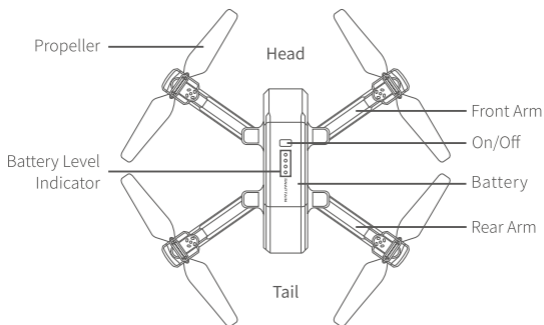

Note:

Please don't manually adjust the camera angle to avoid damage to it.



Remote

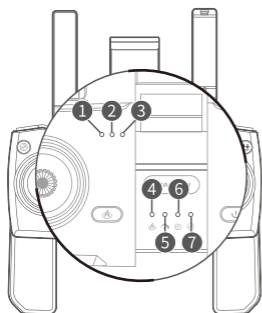
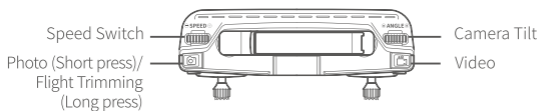
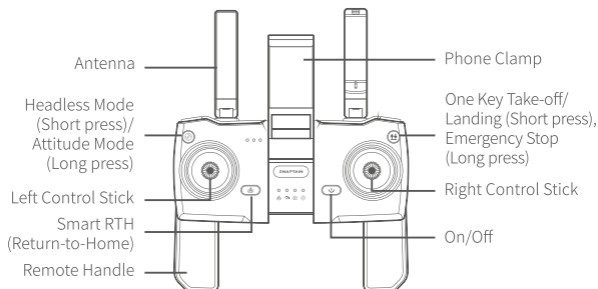

- 1 Fully Charged Indicator
- 2 Charging Indicator
- 3 Power Indicator
- 4 Smart RTH Indicator
- 5 Speed Indicator
- 6 Photo/Video Indicator
- 7 Headless Mode Indicator/
Flight Trimming Indicator



» FLIGHT PREPARATION

- 01 Charge the battery, then install it into the drone after it's fully charged.

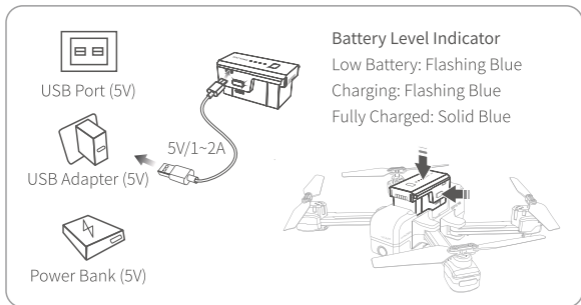

Notes:

- 01 Please use the original battery and USB cable provided.
- 02 Keep the battery away from any sharp objects that could puncture into the battery to avoid risks of explosion and fire.
- 03 It's not recommended to charge the battery from the USB port of PC.
- 04 Flight time may be reduced when flying in low-temperature environments.
- 05 To extend the battery's lifespan, recharge it at least once every three months if not using it for long periods of time.

- 02 Unfold the rear arms, then the front arms.

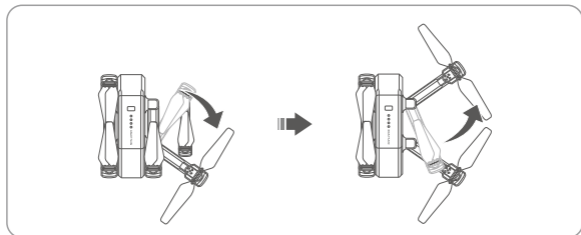

03 Insert a memory card (not included) into the drone.(Optional)

- * FAT 32 format of the memory card is required.
- * Support up to 128G.

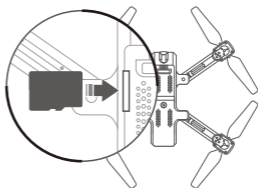

04 Charge the remote.

- Fully Charged Indicator: Green
- Charging Indicator: Red

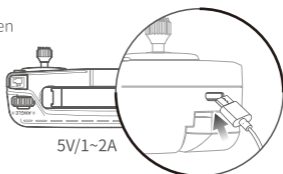

05 Unfold the **Remote Handle** and **Antenna**.

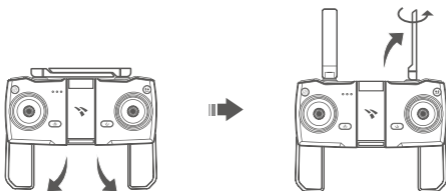

- 06 Unfold the **Phone Clamp** to see more indicators. Mount your mobile device when using it to fly the drone.

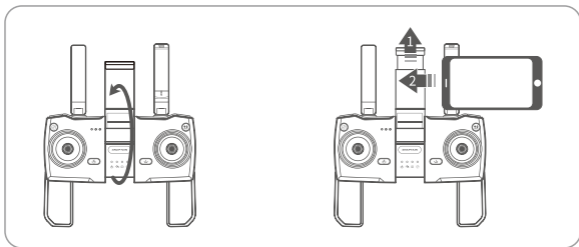

- 07 Replace the propeller when it's needed. (Optional)

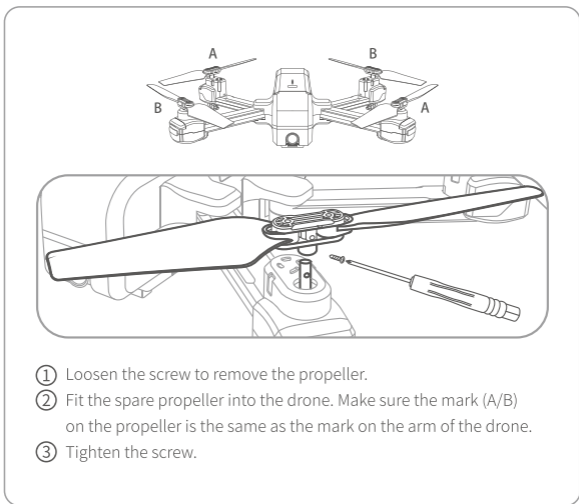

- ① Loosen the screw to remove the propeller.
- ② Fit the spare propeller into the drone. Make sure the mark (A/B) on the propeller is the same as the mark on the arm of the drone.
- ③ Tighten the screw.

» FLIGHT OPERATION GUIDE

IMPORTANT:

- 1 Make sure you power on the drone first, then the remote in each flight.
- 2 Do repeat the pairing and calibration procedure each time the drone or remote is restarted.
- 3 For all flight functions and modes, the operator and tail of the drone must be aligned.
- 4 We recommend flying in the open air and within the control range for beginners.
- 5 Use the remote and App simultaneously to fly the drone for better flying experience.
- 6 The maximum flight distance (the maximum distance between the drone and the last recorded **Home Point**) is set to 30m by default and you can reset it in **Settings** of App.

Remote Operation Guide

Pair the Remote with the Drone

Step 1:

Turn on the drone by pressing and holding the **On/Off** button for 3s until the four indicators on the battery light up, then place it on a flat surface with the head forward. LEDs on the arms of the drone flash red slowly.

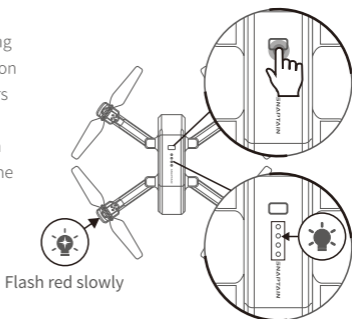

Step 2:

Short press the **On/Off** button on the remote to turn on it and there is one beep from the remote. Push the **Left Control Stick** forward to the top, then pull it backward to the bottom. Pairing is completed when the front LEDs of the drone flash white slowly and the rear LEDs of the drone flash blue slowly.

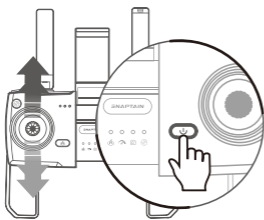

Flash white slowly

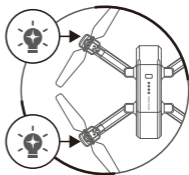

Flash blue slowly

Tips:

- 1 Short press the **On/Off** button on the remote, then press and hold it for 2s until you hear a beep sound to turn it off.
- 2 The drone and remote will turn off automatically after 10 minutes of inactivity.

Flight Calibration

After pairing, the LEDs on the arms of the drone will turn to flash red quickly, indicating that the drone needs to be calibrated.

Note:

If the drone often flies in the same place, its LEDs won't turn to flash red quickly after pairing, however, it's still necessary to do the calibration.

Compass Calibration

Push the **Left Control Stick** to the upper right at 45° and the **Right Control Stick** to the upper left at 45°. The front LEDs of the drone flash white and red quickly and the rear LEDs flash blue and red quickly.



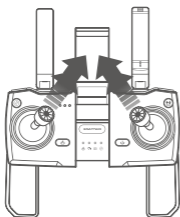

Flash white and red quickly

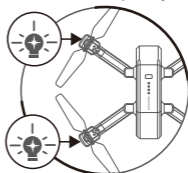

Flash blue and red quickly

Step 1:

Hold the drone horizontally, then make a 360 degrees rotation at least once until the rear LEDs of the drone turn solid blue and red, which indicates a successful horizontal calibration.

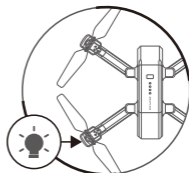
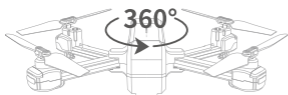

Solid blue and red

Step 2:

Hold the drone vertically with its head facing up, then make a 360 degrees rotation at least once until the front LEDs of the drone turn solid white and red, which indicates a successful vertical calibration.

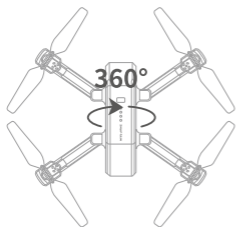

Solid white and red

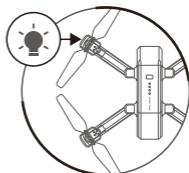

Notes:

- 1 Make sure to keep away from ferromagnetic substance and other electronic equipment when calibrating.
- 2 If the LEDs on the arms of the drone keep flashing red when calibrating, please move to another place to fly the drone.

Gyro Calibration

Place the drone on a flat surface after finishing compass calibration. Push the **Left Control Stick** to the upper left at 45° and the **Right Control Stick** to the upper right at 45° to start calibrating the gyro. Gyro calibration completes when the front LEDs (white) and the rear LEDs (blue) of the drone turn to flash slowly from flashing quickly.

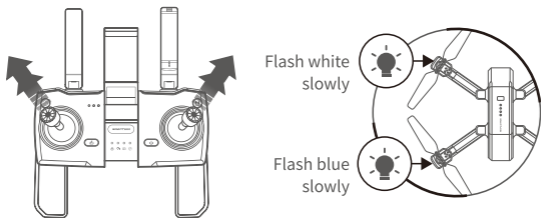

Note:

If the drone finds enough satellites, its LEDs will turn solid on after gyro calibration.

GPS Satellites Searching

Wait for the drone to search GPS satellites. You could go to **Snaptain Nova** app to check the **GPS Signal** (refer to page 24~26). When the drone finds enough satellites, the GPS signal icon on App will turn blue, and the front LEDs (white) and rear LEDs (blue) of the drone will turn solid on, indicating that the drone is ready to take off in **GPS Mode**.



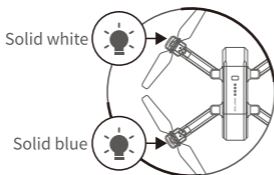

Ready to take off in GPS Mode

The drone is set in **GPS Mode** by default. In this mode, the drone can utilize the GPS module to locate itself and make a precise hovering flight. **GPS Mode** works only when the GPS signal is strong. Please fly the drone outdoors.

Notes:

- 1 We strongly recommend **GPS Mode** for beginners.
- 2 If you still want the drone to take off when **GPS Mode** is unavailable, you can switch it to **ATTI (Attitude) Mode** (refer to [Page 18](#)).

Flight Instructions

Take-off

Option 1:

Move the **Left Control Stick** to lower right at 45° and the **Right Control Stick** to lower left at 45° at the same time until the four rotor blades start rotating, then short press the  button to take off at a height around 1.5m.

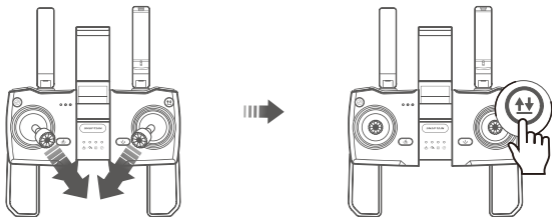

Option 2:

Move the **Left Control Stick** to lower right at 45° and the **Right Control Stick** to lower left at 45° at the same time until the four rotor blades start rotating, then slowly push the **Left Control Stick** forward to take off.

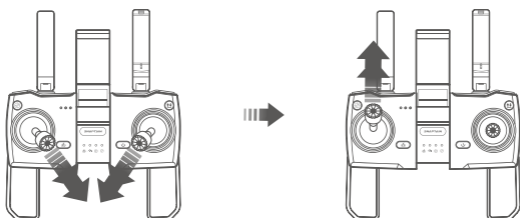

Notes:

- 1 If you don't want the drone to take off after unlocking it, push the **Left Control Stick** to lower right in 45° and the **Right Control Stick** to lower left in 45° again (👇👈) to make the four rotor blades stop rotating.
- 2 The motors will stop working if there is no operation within 20s.

Flight Directions

Left Control Stick

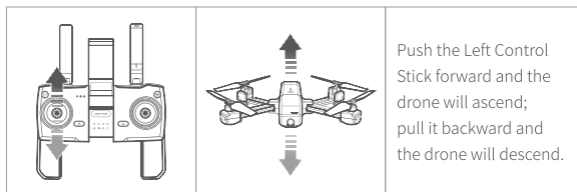

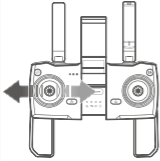
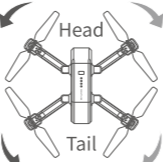
		<p>Pull the Left Control Stick leftward and the drone will rotate to the left; pull it rightward and the drone will rotate to the right.</p>
---	--	--

Right Control Stick

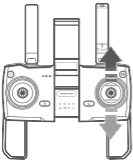
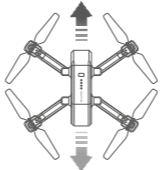
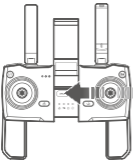
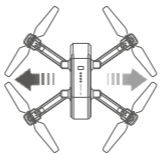
		<p>Push the Right Control Stick forward and the drone will fly forward; pull it backward and the drone will fly backward.</p>
		<p>Pull the Right Control Stick leftward and the drone will fly leftward; pull it rightward and the drone will fly rightward.</p>

Photo/Video

Short press  to take a photo.

Short press  to start recording a video, press it again to end and save the video to your mobile device and memory card if you are using **Snaptain Nova App**.



Speed Switch

The speed of the drone is set as **Medium** speed by default. Slide the **SPEED** switch rightward to turn to **High** speed, and slide it leftward to turn to **Low** speed.



Speed Indicator

Low speed: Off

Medium speed: Solid Blue

High speed: Flashing Blue

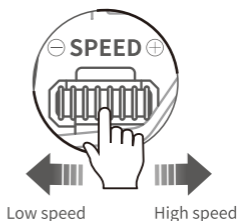

Headless Mode

Short press the  button to activate **Headless Mode**. The **Headless Mode Indicator** on the remote will be solid blue. In this mode, the drone will fly following the direction of the **Right Control Stick** regardless of the position of your drone's head or the tail. Press the same button again to cancel this mode.

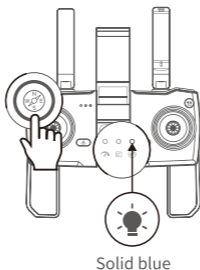

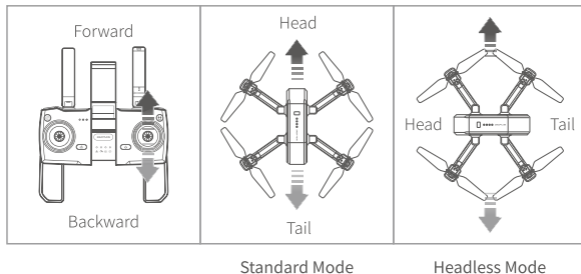

Point of Interest (POI)



POI function enables the drone to fly around a desired subject.

Step 1:

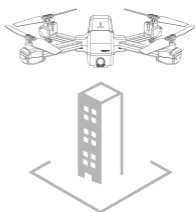
Fly the drone above the desired subject. The current point of the drone is POI.



Step 2:

Simultaneously press the  and  button on the remote to activate POI.

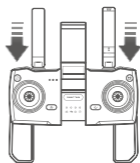

Step 3:

Move the **Right Control Stick** to set the POI Radius from 2m to 100m.

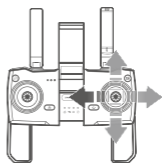

Step 4:

Simultaneously press the  and  button again, then the drone starts orbiting around POI clockwise.

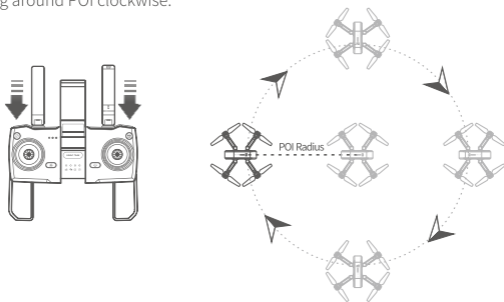

* Push the **Left Control Stick** forward or backward to adjust the flight altitude as needed.

Step 5:

Cancel POI.

Option 1:

Simultaneously press the  and  button again.

Option 2:

Move the **Right Control Stick** when the drone is orbiting around POI.

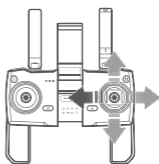
**Notes:**

- 1 The minimum POI radius is 2m. If the POI radius you set is less than 2m, the drone will automatically fly to the point where POI radius is 2m.
- 2 This function can't be activated when battery of the drone is low.

Attitude (ATTI) Mode

In **ATTI Mode**, the drone will maintain a specific flight altitude, but it will drift around in the wind.



Option 1:

Press and hold the  button for 3s to activate **ATTI Mode**.

Press and hold the  button for 3s again to cancel **ATTI Mode**.

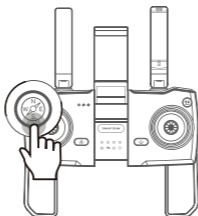

Option 2:



ATTI Mode is automatically on when GPS signal is not strong enough for the drone to fly in GPS mode during outdoor flight.

Notes:

- 1 We recommend **ATTI Mode** only when the pilot has proficient skills in operating the drone.
- 2 In **ATTI Mode**, functions based on GPS mode including **RTH**, **Follow Me**, **Waypoints** and **POI** can't be activated.

Flight Trimming

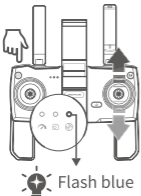
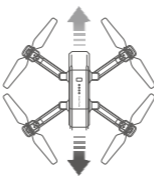
This function is only for **ATTI Mode**, in which the drone will drift around in the wind. Proper trimming can help the drone achieve a hovering flight.

 <p>Flash blue</p>		<p>If the drone drifts forward or backward when flying, press and hold , then slightly push the Right Control Stick backward or forward to adjust.</p>
---	---	---



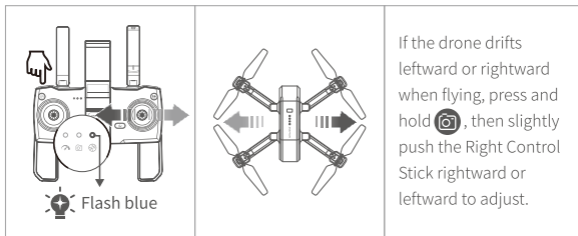

Release the  button to cancel trimming mode.

Return-to-Home (RTH)

The **Return-to-Home (RTH)** function brings the drone back to the last recorded **Home Point** where the drone took off last time. RTH works only when the GPS signal is strong and the compass works normally.

Smart RTH

Press  on the remote to initiate **Smart RTH**.

* RTH Distance:

The distance between the drone and the last recorded **Home Point** where the drone took off last time.

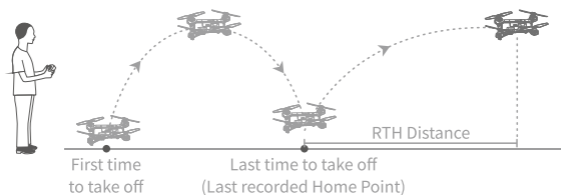

1. RTH Distance >30m

If the current flight altitude is lower than the preset RTH altitude, the drone will first ascend to the preset RTH altitude, then fly back to **Home Point** and descend to land.



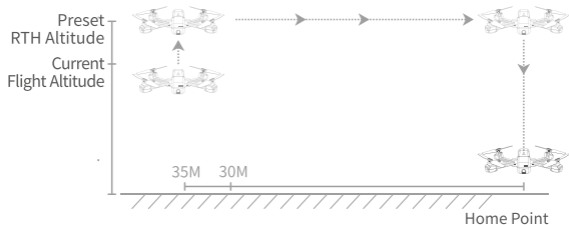

If the current flight altitude is higher than the preset RTH altitude, the drone will directly fly back to **Home Point** at its current flight altitude and land.

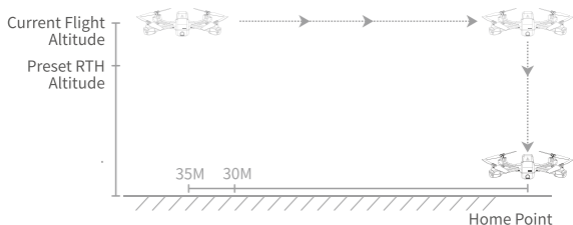

2. RTH Distance $\leq 30\text{m}$

The drone will directly fly back to **Home Point** at its current flight altitude and descend to land.

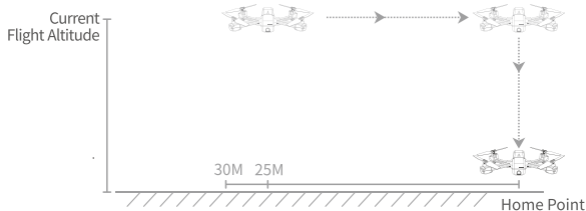

IMPORTANT

After the drone returns to **Home Point** and the rotor blades stop rotating, press  on the remote to cancel **Smart RTH**. Otherwise, you can't regain control of the drone.

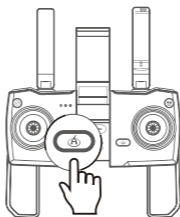

Notes:

- 1 The preset RTH altitude is 25m by default. You can reset it in the **Settings** of **Snaptain Nova App** (see on page 27). However, the preset RTH altitude can not be higher than the flight altitude when resetting.
- 2 During the path of **Smart RTH**, the remote continuously beeps and the **RTH Indicator** keeps flashing green.

Failsafe RTH

Failsafe RTH will be automatically activated when the remote disconnects with the drone for 5s. The drone will fly back to the last recorded **Home Point** under the control of the flight system itself.

If the connection between the remote and drone is re-established during **Failsafe RTH**, the pilot can regain control of the drone by pressing  to cancel the RTH process. If no operation is performed by the pilot, the RTH process will continue.

Low Battery RTH

The **Low Battery RTH** will be triggered when the drone battery is low. You can see the low battery prompt on the App.



1. RTH Distance >30m

The drone will horizontally fly back to the point where the RTH distance is 15m and hover, then the pilot regains control of the drone. The drone can't fly beyond 15m any more no matter how the pilot operates.

Please land the drone safely and timely. If the pilot doesn't land the drone, it will automatically descend from its current point to land when the battery drains.

2. RTH Distance \leq 30m

The drone will directly fly back to **Home Point** and descend to land.

Note:

The drone cannot avoid obstacles during the flight path of RTH.

Landing

Option 1:

Short press the  button to land the drone.

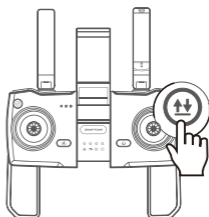

Option 2:

Slowly pull the **Left Control Stick** backward to land the drone until the propellers stop rotating.

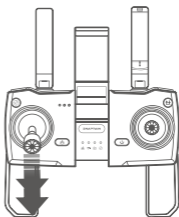

Emergency Stop

Press and hold  for 3s, the drone will stop in the air and fall.

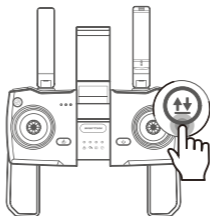

Note:

It's NOT recommended to use this function during normal flight for landing, which may result in serious damage to your drone.

App Operation Guide

Download and Install the App

Download and install **Snaptain Nova** into your mobile device from **App Store/Google Play** or by scanning the QR code below.



Android



iOS



Launch the App

Step 1:

Turn on cellular data and location service on your mobile device, then open **Snaptain Nova App**, select **SP510** and tap **Start** to enter the App.

Step 2:

Tap the **Live Map** to load the map, then tap  to have your location displayed on the center of the live map.

Step 3:

Turn off cellular data, then go to the Wifi setting of your mobile device and connect to the Wifi **Snaptain-SP510-xxxxxx**.



Notes:

- 1 If the **Snaptain-SP510-xxxxxx** Wifi is not listed in your Wifi list or the App does not show the preview image, please restart the drone and remote, then repeat the pairing and calibration procedures.
- 2 Make sure the **Snaptain-SP510-xxxxxx** Wifi is only connected to one mobile device.
- 3 The drone's Wifi has no Internet access. To prevent your mobile device from automatically switching to cellular data, it's recommended that you turn off cellular data when connecting to the drone's Wifi.

Function Overview of the App



- | | |
|----------------------------|----------------------------|
| ① Back | ⑥ Flip Image |
| ② Media Gallery | ⑦ Flight Records |
| ③ VR Mode | ⑧ Settings |
| ④ More | ⑨ GPS Signal |
| ⑤ Waypoints | ⑩ Wifi Signal |
| ① Return-to-Home (RTH) | ① Record |
| ② Follow Me | ② Remote Battery Status |
| ③ Mark and Track | ③ Drone Battery Status |
| ④ One Key Take-off | ④ Live Map |
| ⑤ One Key Landing | ⑤ D: Flight Distance |
| ⑥ Gestures for Photo/Video | ⑥ H: Flight Height |
| ⑦ Photo | ⑦ DS: Flight Speed |
| ⑧ Video | ⑧ VS: Ascent/Descent Speed |

Media Gallery:

Tap to check the photos and videos saved.

VR Mode:

Tap  to activate VR mode (VR device is not supplied).

GPS Signal:

Check the signal of the GPS satellites. When the icon turns blue, the GPS Mode is available.

Flip Image:

Tap  to flip the image 180°.

Flight Records:

Check all kinds of flight records here.

Wifi Signal:

Check the Wifi signal strength of the drone to avoid blurry and laggy video. When it shows low signal strength (), please fly the drone back immediately.

Drone Battery Status:

Check the battery status of the drone.

Remote Battery Status:

Check the battery status of the remote.

Settings

Tap  to start setting up your drone.

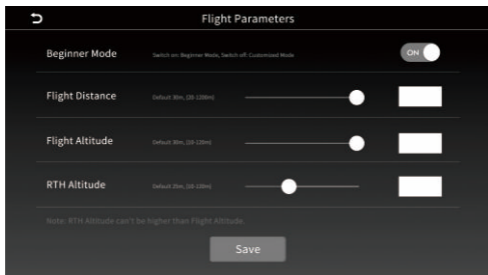

You can reset the Flight Distance, Flight Altitude and RTH Altitude as needed.

Beginner Mode:

It's **ON** by default and all the flight parameters are preset. We recommend this mode for beginners.

Flight Distance:

Tap to reset the maximum flight distance between the drone and last recorded **Home Point**.

Flight Altitude:

Tap to reset the maximum flight altitude of the drone.

RTH Altitude:

Tap to reset the RTH altitude.

Note:

RTH Altitude can't be higher than the **Flight Altitude**.

IMPORTANT

- 1 Before flying, please make sure the GPS Signal icon is blue.
- 2 The maximum flight distance (the maximum distance between the drone and the last recorded **Home Point**) is set to 30m by default and you can reset it in **Settings** of App.

Take-off**Step 1:**

Tap  to show more operation icons on the screen.

Step 2:

Simultaneously move the **Left Control Stick** to lower right at 45° and the **Right Control Stick** to lower left at 45° until the four rotor blades start rotating.

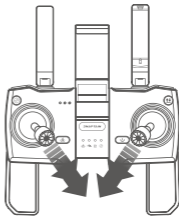





Step 3:

Tap , then tap Yes on the pop-up window to take off.



Follow Me

When **Follow Me** is enabled during the flight, the drone will fly follow your mobile device with its camera lens pointing at it. Tap  to show   behind. Tap the second  to enable **Follow Me** based on GPS, then tap **Yes** on the pop-up window.



Tap the second  again during flight to cancel this mode and regain control of the drone.



Notes:

- 1 The function of **Follow Me** may have deviation due to the GPS Signal.
Please maintain a safe distance between you and the drone when enabling this function.
- 2 Activate this function only when there are no obstacles around you in case of unexpected accidents.
- 3 This function can't be activated when the drone battery is low.

Mark and Track

Tap  and draw a precise box around the subject onscreen, then the drone's camera lens will keep pointing at the chosen subject.

Please make sure you're operating in a light-filled environment, and the box you draw precisely frames the subject.



Tap  again to cancel this mode and regain control of the drone.

Notes:

- 1 Please maintain a safe and effective distance (3~10m) between the subject and the drone when enabling this function.
- 2 This function is not working if the chosen subject is moving in a dim circumstance, blocked or out of sight, out of effective distance, etc.
- 3 This function can't be activated when the drone battery is low.

Waypoints

Waypoints function allows you to define an exact flying route on a map during flight.

Step 1:

Tap , then tap some desired waypoints on the map. Tap **DELETE ONE** or **DELETE ALL** to delete waypoint(s) if you want to reset.

Step 2:

Tap **UPLOAD** to upload waypoints.

Step 3:

Tap Yes on the pop-up window to start.

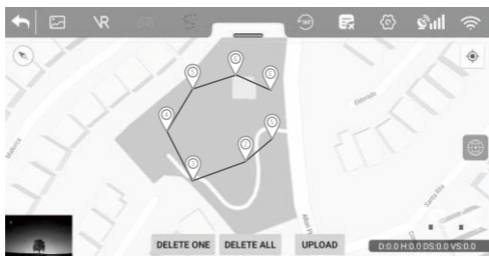

Tap  again during the flight to cancel this mode and regain control of the drone.

Notes:

- 1 Up to 16 waypoints can be set at a time.
- 2 This function can't be activated when the drone battery is low.

Photo/Video



Tap  to take a photo.

Tap  to start recording a video, then tap it again to end and save the video to your memory card and mobile device.

Tap , then tap  to record a video with the sound around your mobile device.

Go to **Media Gallery**, select the photo or video preferred and tap  to share with your friends.

Gestures for Photo/Video

Tap  to activate this function. Within 3m under light-filled circumstances, please make a  gesture with your **Right Hand** for taking a photo, a  gesture for starting and ending the recording.

Smart RTH

Tap  to activate **Smart RTH** during the flight and have the drone returned to the last recorded **Home Point**. Tap **Yes** on the pop-up window to start RTH; tap **NO** to exit this window.

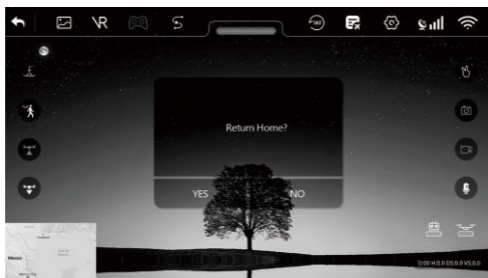

During the path of RTH, tap  again to cancel RTH and regain control.

IMPORTANT

Tap  on App to cancel **Smart RTH** after the drone lands in the **Home Point** and the rotor blades stop rotating, otherwise you can't regain control of the drone.

Landing

Tap  to land the drone during flight.



» TROUBLESHOOTING

Q1. The LEDs of the drone keep flashing red after pairing.

* Please turn off the drone and the remote, then turn on them and do the pairing again.

Q2. The image keeps shaking when I fly the drone.

* Please don't fly the drone in strong wind. If the image is still shaking in light wind, please check whether the arm of the drone is shaking; if yes, please replace the propeller of this arm.

Q3. The video is lagging.

* Please fly the drone within FPV range. If the video is still lagging when the drone flies within FPV range, please move to another place to fly.

Q4. Fail to connect to the drone's wifi after enabling wifi on my mobile device.

* Please make sure that only **ONE** device is connecting to the drone's Wifi.

Q5. Why can't I see the map after launching the App?

* Please make sure that you've installed a map App. The drone's wifi has no Internet access, please disconnect to it and turn on your cellular data to preload the map, then turn off your cellular data and connect to the drone's wifi again.

Q6. The drone can't make a precise hovering; it drifts after taking off.

* Please make sure that **GPS Mode** is available (check if the GPS signal icon is blue on App). Please fly the drone in the open air.

Q7. The FOLLOW ME function is unavailable.

* Please make sure that you've turned on location service on your mobile device, and the drone is flying in **GPS Mode**.

Q8. How can I fly the drone back when I can't tell the head or tail of the drone?

* Please make sure that you've turned on **GPS Mode**, press the  button to trigger **RTH** function, then the drone will automatically fly back home.

Q9. How to cancel Failsafe RTH?

* Press the  button to cancel **Failsafe RTH** when the remote receives the signal from the drone again.



Q10. Is it necessary to fly the drone back when the drone battery is low?

- * Please fly the drone within a distance of 30m when the battery is low. When the battery is critical low, the drone will automatically fly back and land.

» SPECIFICATIONS

Drone		
Operating Temperature	32°F to 104°F(0°C to 40°C)	
Frequency Range	Model SP510: 5150-5250 MHz	
Transmit Power (EIRP)	Model SP510: 5 GHz<18 dBm	
Remote		
Frequency Range	Model SP510R: 2405-2478 MHz	
Transmit Power (EIRP)	Model SP510R: 2.4 GHz<14 dBm	
USB Cable (5V/2A)		
	For Remote	For Drone Battery
Input	4.2V \mp 0.4A	4.2V \mp 1.2A
Rated Power	1.68W	5.04W



FCC Caution:

Any Changes or modifications not expressly approved by the party responsible for compliance could void the user's authority to operate the equipment.

This device complies with part 15 of the FCC Rules. Operation is subject to the following two conditions: (1) This device may not cause harmful interference, and (2) this device must accept any interference received, including interference that may cause undesired operation.

Note: This equipment has been tested and found to comply with the limits for a Class B digital device, pursuant to part 15 of the FCC Rules. These limits are designed to provide reasonable protection against harmful interference in a residential installation. This equipment generates, uses and can radiate radio frequency energy and, if not installed and used in accordance with the instructions, may cause harmful interference to radio communications. However, there is no guarantee that interference will not occur in a particular installation. If this equipment does cause harmful interference to radio or television reception, which can be determined by turning the equipment off and on, the user is encouraged to try to correct the interference by one or more of the following measures:

- Reorient or relocate the receiving antenna.
- Increase the separation between the equipment and receiver.
- Connect the equipment into an outlet on a circuit different from that to which the receiver is connected.
- Consult the dealer or an experienced radio/TV technician for help.

For Remote:

This equipment complies with FCC radiation exposure limits set forth for an uncontrolled environment.

For R/C QUADCOPTER:

This equipment complies with FCC radiation exposure limits set forth for an uncontrolled environment. This equipment should be installed and operated with minimum distance 20cm between the radiator & your body.

This transmitter must not be co-located or operating in conjunction with any other antenna or transmitter.

ISED Warning:

This device complies with Industry Canada licence-exempt RSS standard(s). Operation is subject to the following two conditions:

- (1) this device may not cause interference, and
- (2) this device must accept any interference, including interference that may cause undesired operation of the device.

Le présent appareil est conforme aux CNR d'Industrie Canada applicables aux appareils radio exempts de licence. L'exploitation est autorisée aux deux conditions suivantes :

- (1) l'appareil ne doit pas produire de brouillage, et
- (2) l'utilisateur de l'appareil doit accepter tout brouillage radioélectrique subi, même si le brouillage est susceptible d'en compromettre le fonctionnement.



For R/C QUADCOPTER:

The device is compliance with RF exposure guidelines, users can obtain Canadian information on RF exposure and compliance. The minimum distance from body to use the device is 20cm.

Operation of this device in the band 5150-5250 MHz is restricted to indoor use only.

L'appareil est conforme aux directives d'exposition aux RF, les utilisateurs peuvent obtenir des informations canadiennes sur l'exposition aux RF et la conformité. La distance minimale du corps pour utiliser l'appareil est de 20 cm.

Le fonctionnement de cet appareil dans la bande 5150-5250 MHz est limité à une utilisation en intérieur uniquement.

For Remote:

The device has been tested and compliance with SAR limits, users can obtain Canadian information on RF exposure and compliance.

Après examen de ce matériel aux conformité aux limites DAS et/ou aux limites d'intensité de champ RF, les utilisateurs peuvent sur l'exposition aux radiofréquences et la conformité and compliance d'acquérir les informations correspondantes.

This transmitter must not be co-located or operating in conjunction with any other antenna or transmitter.

Cet émetteur ne doit pas être colocalisé ou fonctionner en conjonction avec une autre antenne ou un autre émetteur.

CAUTION

RISK OF EXPLOSION IF BATTERY IS REPLACED BY AN INCORRECT TYPE
DISPOSE OF USED BATTERIES ACCORDING TO THE INSTRUCTIONS

 The symbol indicates DC voltage



RECYCLING

This product bears the selective sorting symbol for Waste electrical and electronic equipment (WEEE). This means that this product must be handled pursuant to European directive 2012/19/EU in order to be recycled or dismantled to minimize its impact on the environment. User has the choice to give his product to a competent recycling organization or to the retailer when he buys a new electrical or electronic equipment.

This product can be used across EU member states.

The device is low power device, it can meet the requirement of the RF exposure.

EU Compliance Statement: Shenzhen VanTop Technology & Innovation Co., Ltd. hereby declares that this device is in compliance with the essential requirements and other relevant provisions of the Directive 2014/53/EU.

A copy of the EU Declaration of Conformity is available online at <https://doc.vantop.com>.





AT	BE	CY	CZ	DK	EE	FI
FR	DE	EL	HU	IE	IT	LV
LT	LU	MT	NL	PL	PT	SK
SI	ES	SE	UK	BG	RO	HR

In all EU member states, operation of 5150-5350 MHz is restricted to indoor use only.



BATTERY MUST BE RECYCLED OR DISPOSED OF PROPERLY

Manufacturer

Shenzhen VanTop Technology & Innovation Co., Ltd.

Manufacturer address:

502, 5th Flr. BLDG 4, MinQi Technology Park, No. 65 Lishan Road, Taoyuan Street,
Nanshan District, Shenzhen, China

EC	REP
----	-----

C&E Connection E-Commerce (DE) GmbH
Zum Linnegraben 20, 65933, Frankfurt am Main, Germany
Info@ce-connection.de



SNAPTAIN SUPPORT

US : support@snaptain.com

CA : support@snaptain.com

UK : support.uk@snaptain.com



www.snaptain.com



[@snaptainofficial](https://www.facebook.com/snaptainofficial)



[@snaptain_official](https://www.instagram.com/snaptain_official)