

TOSHIBA

Carrier

SERVICE MANUAL

**AIR-CONDITIONER
(OPTION KIT)**

VRF DX-COIL INTERFACE Advance

Model name:

Dx-coil controller

TCB-IFDMR01UP-UL

(Terminal block with relay)

Dx-valve kit

RBM-A0601UPVA-UL

RBM-A1201UPVA-UL

RBM-A1921UPVA-UL

- For the outdoor unit, refer to the service manual of the Super Modular Multi System.
- For the Air Handling Unit contact the manufacturer you made the purchase.
- TOSHIBA Carrier does not take any responsibility on the local design.

CONTENTS

1. OVERVIEW	10
2. CONSTRUCTION VIEWS (EXTERNAL VIEWS).....	14
3. WIRING DIAGRAMS	16
4. REFRIGERANT CYCLE DIAGRAM	17
4-1. TC1, TC2 and TCJ sensor position on DX COIL	17
4-2. Refrigerant circuit diagram	18
4-3. Piping size and Y-joint	20
4-4. Allowable length and allowable height difference of refrigerant piping.....	21
4-5. Installation temperature sensor	22
5. PARTS RATING	23
6. CONTROL OUTLINE	25
7. INPUT AND OUTPUT PORT	35
7-1. Dx-coil controller Print Circuit Board.....	35
7-2. Test run	37
7-3. Input and Output specification	38
7-4. Method to set the AHU function DN code.....	51
7-5. Troubleshooting based on information displayed on remote controller	55
8. TROUBLESHOOTING	58
8-1. Overview	58
8-2. Troubleshooting Method	59
9. EXPLODED VIEWS AND PARTS LIST	65

Generic Denomination: Air Conditioner

Definition of Qualified Installer or Qualified Service Person

The air conditioner must be installed, maintained, repaired and removed by a qualified installer or qualified service person. When any of these jobs is to be done, ask a qualified installer or qualified service person to do them. A qualified installer or qualified service person is an agent who has the qualifications and knowledge described in the table below.

Agent	Qualifications and knowledge which the agent must have
Qualified installer	<ul style="list-style-type: none"> • The qualified installer is a person who installs, maintains, relocates and removes the air conditioners made by Manufacturer. He or she has been trained to install, maintain, relocate and remove the air conditioners made by Manufacturer or, alternatively, he or she has been instructed in such operations by an individual or individuals who have been trained and is thus thoroughly acquainted with the knowledge related to these operations. • The qualified installer who is allowed to do the electrical work involved in installation, relocation and removal has the qualifications pertaining to this electrical work as stipulated by the local laws and regulations, and he or she is a person who has been trained in matters relating to electrical work on the air conditioners made by Manufacturer or, alternatively, he or she has been instructed in such matters by an individual or individuals who have been trained and is thus thoroughly acquainted with the knowledge related to this work. • The qualified installer who is allowed to do the refrigerant handling and piping work involved in installation, relocation and removal has the qualifications pertaining to this refrigerant handling and piping work as stipulated by the local laws and regulations, and he or she is a person who has been trained in matters relating to refrigerant handling and piping work on the air conditioners made by Manufacturer or, alternatively, he or she has been instructed in such matters by an individual or individuals who have been trained and is thus thoroughly acquainted with the knowledge related to this work. • The qualified installer who is allowed to work at heights has been trained in matters relating to working at heights with the air conditioners made by Manufacturer or, alternatively, he or she has been instructed in such matters by an individual or individuals who have been trained and is thus thoroughly acquainted with the knowledge related to this work.
Qualified service person	<ul style="list-style-type: none"> • The qualified service person is a person who installs, repairs, maintains, relocates and removes the air conditioners made by Manufacturer. He or she has been trained to install, repair, maintain, relocate and remove the air conditioners made by Manufacturer or, alternatively, he or she has been instructed in such operations by an individual or individuals who have been trained and is thus thoroughly acquainted with the knowledge related to these operations. • The qualified service person who is allowed to do the electrical work involved in installation, repair, relocation and removal has the qualifications pertaining to this electrical work as stipulated by the local laws and regulations, and he or she is a person who has been trained in matters relating to electrical work on the air conditioners made by Manufacturer or, alternatively, he or she has been instructed in such matters by an individual or individuals who have been trained and is thus thoroughly acquainted with the knowledge related to this work. • The qualified service person who is allowed to do the refrigerant handling and piping work involved in installation, repair, relocation and removal has the qualifications pertaining to this refrigerant handling and piping work as stipulated by the local laws and regulations, and he or she is a person who has been trained in matters relating to refrigerant handling and piping work on the air conditioners made by Manufacturer or, alternatively, he or she has been instructed in such matters by an individual or individuals who have been trained and is thus thoroughly acquainted with the knowledge related to this work. • The qualified service person who is allowed to work at heights has been trained in matters relating to working at heights with the air conditioners made by Manufacturer or, alternatively, he or she has been instructed in such matters by an individual or individuals who have been trained and is thus thoroughly acquainted with the knowledge related to this work.

Definition of Protective Gear

When the VRF Dx-coil interface is to be transported, installed, maintained, repaired or removed, wear protective gloves and 'safety' work clothing.

In addition to such normal protective gear, wear the protective gear described below when undertaking the special work detailed in the table below.



Failure to wear the proper protective gear is dangerous because you will be more susceptible to injury, burns, electric shocks and other injuries.

Work undertaken	Protective gear worn
All types of work	Protective gloves 'Safety' working clothing
Electrical-related work	Gloves to provide protection from electric shock Insulating shoes Clothing to provide protection from electric shock
Work done at heights (20"(50 cm) or more)	Helmets for use in industry
Transportation of heavy objects	Shoes with additional protective toecap
Repair	Gloves to provide protection for electricians

The important contents concerned to the safety are described on the product itself and on this Service Manual.



Please read this Service Manual after understanding the described items thoroughly in the following contents (Indications / Illustrated marks), and keep them.

[Explanation of indications]

Indication	Explanation
 DANGER	Indicates contents assumed that an imminent danger causing a death or serious injury of the repair engineers and the third parties when an incorrect work has been executed.
 WARNING	Indicates possibilities assumed that a danger causing a death or serious injury of the repair engineers, the third parties, and the users due to troubles of the product after work when an incorrect work has been executed.
 CAUTION	Indicates contents assumed that an injury or property damage (*) may be caused on the repair engineers, the third parties, and the users due to troubles of the product after work when an incorrect work has been executed.

* Property damage: Enlarged damage concerned to property, furniture, and domestic animal / pet

[Explanation of illustrated marks]

Indication	Explanation
	Indicates prohibited items (Forbidden items to do) The sentences near an illustrated mark describe the concrete prohibited contents.
	Indicates mandatory items (Compulsory items to do) The sentences near an illustrated mark describe the concrete mandatory contents.
	Indicates cautions (Including danger / warning) The sentences or illustration near or in an illustrated mark describe the concrete cautious contents.





■ Warning indications on the Dx-coil interface unit

Warning indication	Description		
 <table border="1" style="display: inline-table; vertical-align: middle;"> <tr> <td style="text-align: center;">WARNING</td> </tr> <tr> <td>ELECTRICAL SHOCK HAZARD Disconnect all remote electric power supplies before servicing.</td> </tr> </table>	WARNING	ELECTRICAL SHOCK HAZARD Disconnect all remote electric power supplies before servicing.	<p>WARNING</p> <p>ELECTRICAL SHOCK HAZARD Disconnect all remote electric power supplies before servicing.</p>
WARNING			
ELECTRICAL SHOCK HAZARD Disconnect all remote electric power supplies before servicing.			



PRECAUTIONS FOR SAFETY







The manufacturer shall not assume any liability for the damage caused by not observing the description of this manual.







DANGER



 Turn off breaker	<p>Before carrying out the installation, maintenance, repair or removal work, be sure to set the circuit breaker to the OFF position. Otherwise, electric shocks may result.</p>
	<p>Before opening the electrical box cover, set the circuit breaker to the OFF position. Failure to set the circuit breaker to the OFF position may result in electric shocks through contact with the interior parts. Only a qualified installer or qualified service person is allowed to remove the electrical box cover</p>
	<p>When cleaning the filter (sold separately) or other parts of the indoor unit, set the circuit breaker to OFF without fail, and place a "Work in progress" sign near the circuit breaker before proceeding with the work.</p>
	<p>When you have noticed that some kind of trouble (such as when a check display has appeared, there is a smell of burning, abnormal sounds are heard, the air conditioner fails to cool or heat or water is leaking) has occurred in the air conditioner, do not touch the air conditioner yourself but set the circuit breaker to the OFF position, and contact a qualified service person. Take steps to ensure that the power will not be turned on (by marking "out of service" near the circuit breaker, for instance) until qualified service person arrives. Continuing to use the air conditioner in the trouble status may cause mechanical problems to escalate or result in electric shocks or other failure.</p>
 Electric shock hazard	<p>When you repair electric parts, wait for about five minutes after turning off the breaker. Do not start repairing immediately. Otherwise you may get electric shock by touching terminals of high-voltage capacitors. Natural discharge of the capacitor takes about five minutes.</p>
	<p>When checking the electric parts, removing the cover of the electric parts box of the VRF Dx-coil interface inevitably to determine the failure, use gloves to provide protection for electricians, insulating shoes, clothing to provide protection from electric shock and insulating tools. Be careful not to touch the live part. Electric shock may result. Only "Qualified service person" is allowed to do this work.</p>
 Prohibition	<p>Place a "Work in progress" sign near the circuit breaker while the installation, maintenance, repair or removal work is being carried out. There is a danger of electric shocks if the circuit breaker is set to ON by mistake.</p>
	<p>When checking the electric parts, removing the cover of the electric parts box of the VRF Dx-coil interface inevitably to determine the failure, put a sign "Do not enter" around the site before the work. Failure to do this may result in third person getting electric shock.</p>
	<p>Before operating the air conditioner after having completed the work, check that the electrical parts box cover of the VRF Dx-coil interface is closed, and set the circuit breaker to the ON position. You may receive an electric shock if the power is turned on without first conducting these checks.</p>
 Stay on protection	<p>If, in the course of carrying out repairs, it becomes absolutely necessary to check out the electrical parts with the electrical parts box cover of one or more the VRF Dx-coil interface removed in order to find out exactly where the trouble lies, wear insulated heat-resistant gloves, insulated boots and insulated work overalls, and take care to avoid touching any live parts. You may receive an electric shock if you fail to heed this warning. Only qualified service person is allowed to do this kind of work.</p>

 **WARNING**

 General	<p>Before starting to repair the VRF Dx-coil interface, read carefully through the Service Manual, and repair the air conditioner by following its instructions.</p>
	<p>Only qualified service person is allowed to repair the VRF Dx-coil interface. Repair of the VRF Dx-coil interface by unqualified person may give rise to a fire, electric shocks, injury, water leaks and / or other problems.</p>
	<p>Do not use any refrigerant different from the one specified for complement or replacement. Otherwise, abnormally high pressure may be generated in the refrigeration cycle, which may result in a failure or explosion of the product or an injury to your body.</p>
	<p>Only a qualified installer or qualified service person is allowed to carry out the electrical work of the VRF Dx-coil interface. Under no circumstances must this work be done by an unqualified individual since failure to carry out the work properly may result in electric shocks and / or electrical leaks.</p>
	<p>When the VRF Dx-coil interface is to be transported, installed, maintained, repaired or removed, wear protective gloves and 'safety' work clothing.</p>
	<p>To connect the electrical wires, repair the electrical parts or undertake other electrical jobs, wear gloves to provide protection for electricians, insulating shoes and clothing to provide protection from electric shocks. Failure to wear this protective gear may result in electric shocks.</p>
	<p>Electrical wiring work shall be conducted according to law and regulation in the community and installation manual. Failure to do so may result in electrocution or short circuit.</p>
	<p>Use wiring that meets the specifications in the Installation Manual and the stipulations in the local regulations and laws. Use of wiring which does not meet the specifications may give rise to electric shocks, electrical leakage, smoking and/or a fire.</p>
	<p>Only a qualified installer or qualified service person is allowed to undertake work at heights using a stand of 20"(50 cm) or more.</p>
	<p>When working at heights, use a ladder which complies with the ISO 14122 standard, and follow the procedure in the ladder's instructions. Also wear a helmet for use in industry as protective gear to undertake the work.</p>
	<p>Before working at heights, put a sign in place so that no-one will approach the work location, before proceeding with the work. Parts and other objects may fall from above, possibly injuring a person below. While carrying out the work, wear a helmet for protection from falling objects.</p>
	<p>When executing address setting, test run, or troubleshooting on the electric parts box, put on insulated gloves to provide protection from electric shock. Otherwise you may receive an electric shock.</p>
	<p>Do not climb onto or place objects on top of the VRF Dx-coil interface. You may fall or the objects may fall off of the VRF Dx-coil interface and result in injury.</p>
	<p>When transporting the VRF Dx-coil interface, wear shoes with protective toecaps, protective gloves and other protective clothing.</p>
	<p>When transporting the VRF Dx-coil interface, do not take hold of the bands around the packing carton. You may injure yourself if the bands should break.</p>
	<p>A weight, such as the compressor unit (more than 22lbs(10 kg)), please make sure to carry two persons.</p>
<p>This VRF Dx-coil interface has passed the pressure test as specified in UL 60335-2-40 Annex EE.</p>	
<p>Do not add any other devices without factory advice.</p>	
 Check earth wires.	<p>Before troubleshooting or repair work, check the earth wire is connected to the earth terminals of the main unit, otherwise an electric shock is caused when a leak occurs. If the earth wire is not correctly connected, contact an electric engineer for rework.</p>
	<p>After completing the repair or relocation work, check that the ground wires are connected properly.</p>
	<p>Be sure to connect earth wire. (Grounding work) Incomplete grounding causes an electric shock. Do not connect ground wires to gas pipes, water pipes, and lightning rods or ground wires for telephone wires.</p>

 Prohibition of modification.	<p>Do not modify the products. Do not also disassemble or modify the parts. It may cause a fire, electric shock or injury.</p>
 Use specified parts.	<p>When any of the electrical parts are to be replaced, ensure that the replacement parts satisfy the specifications given in the Service Manual (or use the parts contained on the parts list in the Service Manual). Use of any parts which do not satisfy the required specifications may give rise to electric shocks, smoking and / or a fire.</p>
 Do not bring a child close to the equipment.	<p>If, in the course of carrying out repairs, it becomes absolutely necessary to check out the electrical parts with the electrical parts box cover of one or more of the VRF Dx-coil interface removed in order to find out exactly where the trouble lies, put a sign in place so that no-one will approach the work location before proceeding with the work. Third-party individuals may enter the work site and receive electric shocks if this warning is not heeded.</p>
 Insulating measures	<p>Connect the cut-off lead wires with crimp contact, etc., put the closed end side upward and then apply a water-cut method, otherwise a leak or production of fire is caused at the users' side.</p>
 No fire	<p>When performing repairs using a gas burner, replace the refrigerant with nitrogen gas because the oil that coats the pipes may otherwise burn. When repairing the refrigerating cycle, take the following measures.</p> <ol style="list-style-type: none"> 1) Be attentive to fire around the cycle. When using a gas stove, etc., be sure to put out fire before work; otherwise the oil mixed with refrigerant gas may catch fire. 2) Do not use a welder in the closed room. When using it without ventilation, carbon monoxide poisoning may be caused. 3) Do not bring in flammables close to the refrigerant cycle, otherwise fire of the welder may catch the in flammables.
 Refrigerant	<p>The refrigerant used by this VRF Dx-coil interface is the R410A.</p> <p>Check the used refrigerant name and use tools and materials of the parts which match with it. For the products which use R410A refrigerant, the refrigerant name is indicated at a position on the outdoor unit where is easy to see. To prevent miss-charging, the route of the service port is changed from one of the former R22.</p> <p>Do not use any refrigerant different from the one specified for complement or replacement. Otherwise, abnormally high pressure may be generated in the refrigeration cycle, which may result in a failure or explosion of the product or an injury to your body.</p> <p>For an air conditioner which uses R410A, never use other refrigerant than R410A. For an air conditioner which uses other refrigerant (R22, etc.), never use R410A. If different types of refrigerant are mixed, abnormal high pressure generates in the refrigerating cycle and an injury due to breakage may be caused.</p> <p>When the VRF Dx-coil interface has been installed or relocated, follow the instructions in the Installation Manual and purge the air completely so that no gases other than the refrigerant will be mixed in the refrigerating cycle. Failure to purge the air completely may cause the air conditioner to malfunction.</p> <p>To add the refrigerant, follow the Installation Manual and Service Manual of the outdoor unit.</p> <p>When recharging the refrigerant in the refrigerating cycle, do not mix the refrigerant or air other than R410A into the specified refrigerant. If air or others is mixed with the refrigerant, abnormal high pressure generates in the refrigerating cycle resulted in cause of injury due to breakage.</p> <p>After installation work, check the refrigerant gas does not leak. If the refrigerant gas leaks in the room, poisonous gas generates when gas touches to fire such as fan heater, stove or cooking stove though the refrigerant gas itself is innocuous.</p> <p>Never recover the refrigerant into the outdoor unit. When the equipment is moved or repaired, be sure to recover the refrigerant with recovering device. The refrigerant cannot be recovered in the outdoor unit; otherwise a serious accident such as breakage or injury is caused.</p>

 Assembly / Wiring	<p>After repair work, surely assemble the disassembled parts, and connect and lead the removed wires as before. Perform the work so that the electrical box cover does not catch the inner wires. If incorrect assembly or incorrect wire connection was done, a disaster such as a leak or fire is caused at user's side.</p>
 Insulator check	<p>After the work has finished, be sure to use an insulation tester set (500 V Megger) to check the resistance is 1 MΩ or more between the charge section and the non-charge metal section (Earth position). If the resistance value is low, a disaster such as a leak or electric shock is caused at user's side.</p>
 Ventilation	<p>When the refrigerant gas leaks during work, execute ventilation. If the refrigerant gas touches to a fire, poisonous gas generates. A case of leakage of the refrigerant and the closed room full with gas is dangerous because a shortage of oxygen occurs. Be sure to execute ventilation.</p> <p>If refrigerant gas has leaked during the installation work, ventilate the room immediately. If the leaked refrigerant gas comes in contact with fire, noxious gas may generate.</p> <p>After installation work, check the refrigerant gas does not leak. If the refrigerant gas leaks in the room, poisonous gas generates when gas touches to fire such as fan heater, stove or cooking stove though the refrigerant gas itself is innocuous.</p>
 Compulsion	<p>When the refrigerant gas leaks, find up the leaked position and repair it surely. If the leaked position cannot be found up and the repair work is interrupted, reclaim and tighten the service valve, otherwise the refrigerant gas may leak into the room. The poisonous gas generates when gas touches to fire such as fan heater, stove or cooking stove though the refrigerant gas itself is innocuous. When installing equipment which includes a large amount of charged refrigerant in a sub-room, it is necessary that the concentration does not the limit even if the refrigerant leaks. If the refrigerant leaks and exceeds the limit concentration, an accident of shortage of oxygen is caused.</p> <p>Tighten the flare nut with a torque wrench in the specified manner. Excessive tighten of the flare nut may cause a crack in the flare nut after a long period, which may result in refrigerant leakage.</p> <p>Nitrogen gas must be used for the airtight test.</p> <p>The charge hose must be connected in such a way that it is not slack.</p> <p>For the installation / moving / reinstallation work, follow to the Installation Manual. If an incorrect installation is done, a trouble of the refrigerating cycle, water leak, electric shock or fire is caused.</p>
 Check after repair	<p>Once the repair work has been completed, check for refrigerant leaks, and check the insulation resistance and water drainage. Then perform a trial run to check that the air conditioner is running properly.</p> <p>After repair work has finished, check there is no trouble. If check is not executed, a fire, electric shock or injury may be caused. For a check, turn off the power breaker.</p> <p>After repair work has finished, execute a test run to check there is no generation of smoke or abnormal sound. If check is not executed, a fire or an electric shock is caused. Before test run, install the electrical box cover.</p> <p>Be sure to fix the screws back which have been removed for installation or other purposes.</p>
 Do not operate the unit with the valve closed.	<p>Check the following matters before a test run after repairing piping.</p> <ul style="list-style-type: none"> • Connect the pipes surely and there is no leak of refrigerant. • The valve is opened. <p>Running the compressor under condition that the valve closes causes an abnormal high pressure resulted in damage of the parts of the compressor and etc. and moreover if there is leak of refrigerant at connecting section of pipes, the air is sucked and causes further abnormal high pressure resulted in burst or injury.</p>
 Check after reinstallation	<p>Only a qualified installer or qualified service person is allowed to relocate the VRF Dx-coil interface. It is dangerous for the air conditioner to be relocated by an unqualified individual since a fire, electric shocks, injury, water leakage, noise and / or vibration may result.</p> <p>Check the following items after reinstallation.</p> <ol style="list-style-type: none"> 1) The earth wire is correctly connected. 2) The power cord is not caught in the product. 3) There is no inclination or unsteadiness and the installation is stable. <p>If check is not executed, a fire, an electric shock or an injury is caused.</p> <p>When carrying out the reclaim work shut down the compressor before disconnecting the refrigerant pipe. Disconnecting the refrigerant pipe with the service valve left open and the compressor still operating will cause air, etc. to be sucked in, raising the pressure inside the refrigeration cycle to an abnormally high level, and possibly resulting in reputing, injury, etc.</p>

 Cooling check	<p>When the service panel of the outdoor unit is to be opened in order for the compressor or the area around this part to be repaired immediately after the air conditioner has been shut down, set the circuit breaker to the OFF position, and then wait at least 10 minutes before opening the service panel. If you fail to heed this warning, you will run the risk of burning yourself because the compressor pipes and other parts will be very hot to the touch. In addition, before proceeding with the repair work, wear the kind of insulated heat-resistant gloves designed to protect electricians.</p>
	<p>Take care not to get burned by compressor pipes or other parts when checking the cooling cycle while running the unit as they get heated while running. Be sure to put on gloves providing protection for heat.</p>
 Installation	<p>When the service panel of the outdoor unit is to be opened in order for the fan motor, reactor, inverter or the areas around these parts to be repaired immediately after the air conditioner has been shut down, set the circuit breaker to the OFF position, and then wait at least 10 minutes before opening the service panel. If you fail to heed this warning, you will run the risk of burning yourself because the fan motor, reactor, inverter heat sink and other parts will be very hot to the touch. In addition, before proceeding with the repair work, wear the kind of insulated heat-resistant gloves designed to protect electricians.</p>
	<p>Only a qualified installer or service person is allowed to do installation work. Inappropriate installation may result in water leakage, electric shock or fire.</p>
	<p>Before starting to install the VRF Dx-coil interface, read carefully through the Installation Manual, and follow its instructions to install the VRF Dx-coil interface.</p>
	<p>Be sure to use the company-specified products for the separately purchased parts. Use of non-specified products may result in fire, electric shock, water leakage or other failure. Have the installation performed by a qualified installer.</p>
	<p>Do not supply power from the power terminal block equipped on the outdoor unit to another outdoor unit. Capacity overflow may occur on the terminal block and may result in fire.</p>
	<p>Do not install the VRF Dx-coil interface in a location that may be subject to a risk of exposure to a combustible gas. If a combustible gas leaks and becomes concentrated around the unit, a fire may occur.</p>
	<p>Install the indoor unit at least 8'2"(2.5m) above the floor level since otherwise the users may injure themselves or receive electric shocks if they poke their fingers or other objects into the indoor unit while the air conditioner is running.</p>
	<p>Install a circuit breaker that meets the specifications in the installation manual and the stipulations in the local regulations and laws.</p>
	<p>Install the circuit breaker where it can be easily accessed by the qualified service person.</p>
	<p>If you install the unit in a small room, take appropriate measures to prevent the refrigerant from exceeding the limit concentration even if it leaks. Consult the dealer from whom you purchased the air conditioner when you implement the measures. Accumulation of highly concentrated refrigerant may cause an oxygen deficiency accident.</p>
<p>Do not place any combustion appliance in a place where it is directly exposed to the wind of air conditioner, otherwise it may cause imperfect combustion.</p>	

Relocation

- Only a qualified installer or qualified service person is allowed to relocate the VRF Dx-coil interface. It is dangerous for the air conditioner to be relocated by an unqualified individual since a fire, electric shocks, injury, water leakage, noise and / or vibration may result.
- When carrying out the reclaim work shut down the compressor before disconnecting the refrigerant pipe. Disconnecting the refrigerant pipe with the service valve left open and the compressor still operating will cause air, etc. to be sucked in, raising the pressure inside the refrigeration cycle to an abnormally high level, and possibly resulting in reputing, injury, etc.

1. OVERVIEW

VRF Dx-coil interface is the product that is used with connecting the AHU with the DX COIL prepared on-site to the TOSHIBA VRF outdoor unit.

*1. DX COIL: Abbreviation of the Direct expansion coil (heat exchanger).

*2. DDC: Abbreviation of the Direct Digital Controller.

*3. AHU: Abbreviation of the Air Handling Unit.

For the installation of the air handling unit, refer to the installation manual of the air handling unit.

- Dx-coil interface (DDC type use for Supply air temperature or TF type) cannot control the room temperature.

■ Example of the system configuration

VRF Dx-coil interface can connect to SMMS-u, SMMS-e and SHRM-e
 In one cycle the outdoor unit and Dx-coil interface shall be one each for the structure.
 For the AHU prepared on-site, please design with referring to submittal of AHU.

TA type : Enables to connect 3rd party indoor unit or air handling unit as one of VRF indoor unit.
 (Return air temperature control by remote controller setting)
 Main application target – Room temperature conditioning

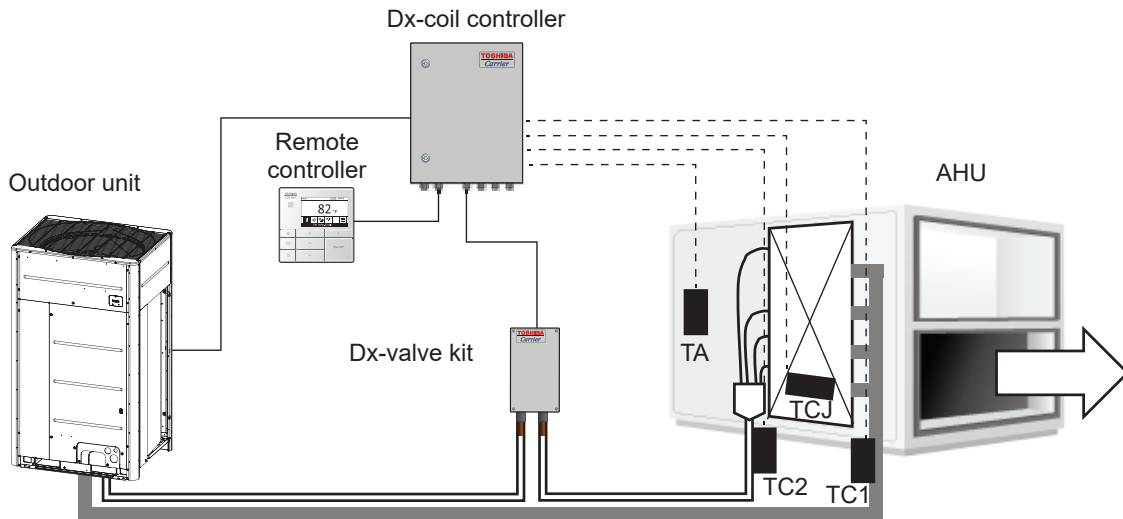

TF type : The discharge temperature is set by the remote controller to control the capacity.
 Main application target – Ventilation

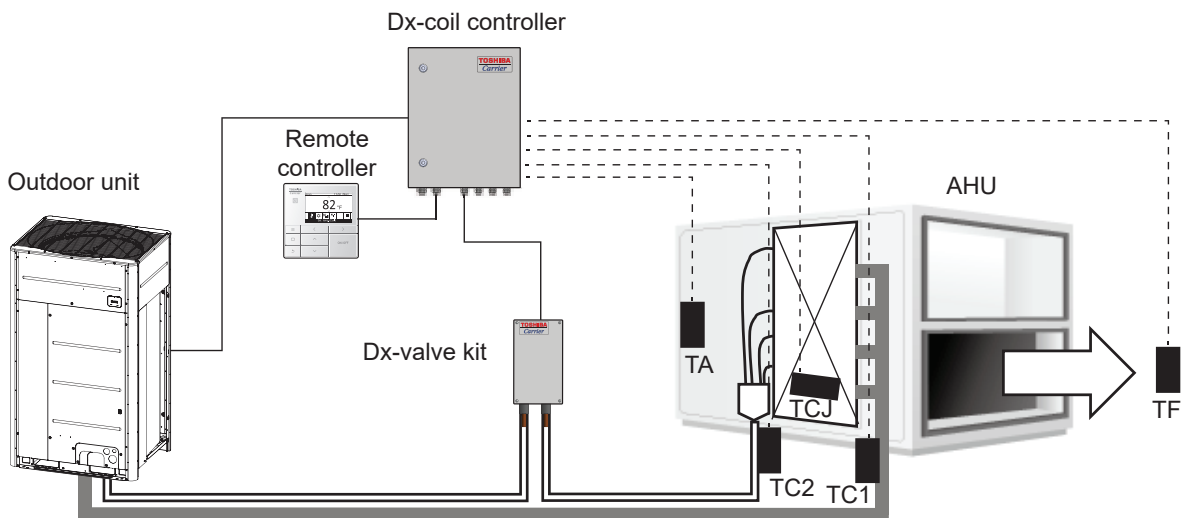

DDC type : Direct capacity control of Toshiba Carrier VRF outdoor unit by analogue input (0-10 V)
 Mainly discharge air temperature control linked AHU system.

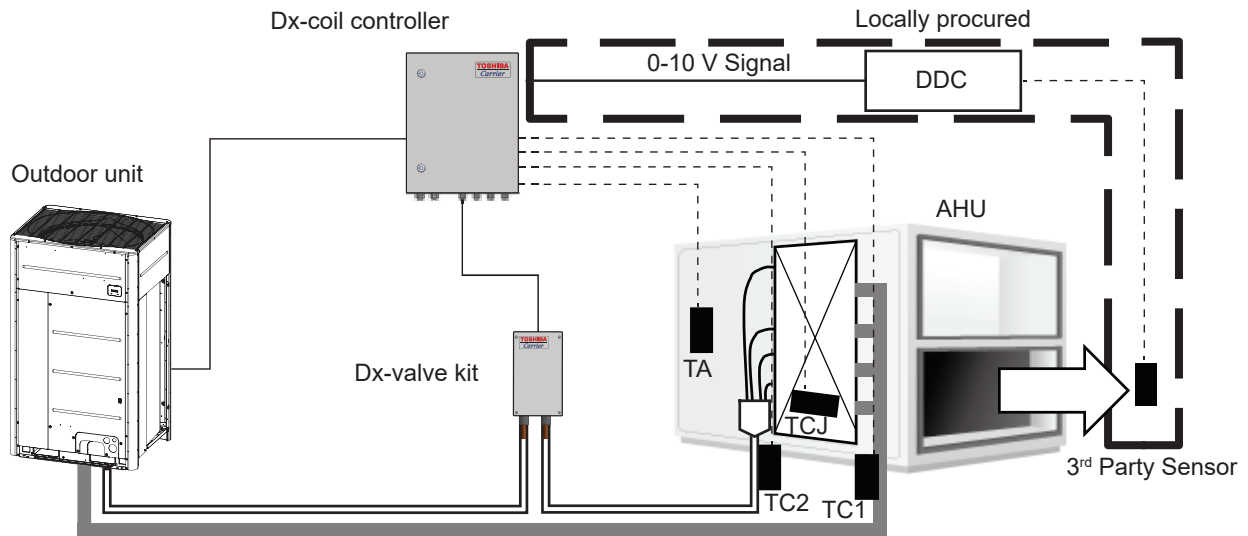

• Diversity specification

Type	SMMS-u Elite Heat	SMMS-u	SMMS-e	SHRM-e
(communication)	(TU2C-LINK or TCC LINK)		(TCC-LINK)	
TA type	80 - 110%	60 - 110%		
DDC type	80 - 100%	75 - 100%		x
TF type	80 - 100%		x	x

- SMMS-u (MMY-MUP***1HT9*P* / MMY-MUP***1HT6*P*)
- SMMS-u (Elite Heat) Heat Pump Model (MMY-MUP***H1HT9*P*)
- SMMS-e (MMY-MAP***6HT9*P* / MMY-MAP***6HT6*P*)
- SHRM-e (MMY-MAP***6FT9*P* / MMY-MAP***6FT6*P* / MMY-MAP0726FT2P*)

Dx coil type		Normal (TA, TF, DDC type)					Interfaced, Split face (TA type)				
Type		Dx-coilcontroller	Dx-valve kit			HEX number	Dx-coilcontroller	Dx-valve kit			HEX number
Model name		TCB-IFDMR01 UP-UL	RBM-A0601UPV A-UL	RBM-A1201UPV A-UL	RBM-A1921UPV A-UL		TCB-IFDMR01 UP-UL	RBM-A0601UPV A-UL	RBM-A1201UPV A-UL	RBM-A1921UPV A-UL	
Connectable Dx-coil capacity	0.6 Ton	1	1	-	-	1					
	0.8 Ton	1	1	-	-	1					
	1 Ton	1	1	-	-	1					
	1.25 Ton	1	1	-	-	1					
	1.5 Ton	1	1	-	-	1					
	2 Ton	1	1	-	-	1					
	2.25 Ton	1	1	-	-	1					
	2.5 Ton	1	1	-	-	1					
	3 Ton	1	1	-	-	1					
	4 Ton	1	1	-	-	1					
	4.5 Ton	1	1	-	-	1					
	5 Ton	1	1	-	-	1					
	6 Ton	1	-	1	-	1					
	8 Ton	1	-	1	-	1					
	10 Ton	1	-	1	-	1					
	12 Ton	1	-	-	1	1	2 (6+6)	-	2	-	2
	14 Ton	1	-	-	1	1	2 (8+6)	-	2	-	2
	16 Ton	1	-	-	1	1	2 (8+8)	-	2	-	2
	18 Ton	-	-	-	-	-	2 (10+8)	-	2	-	2
	20 Ton	1	-	2	-	1	2 (10+10)	-	2	-	2
	22 Ton	-	-	-	-	-	3 (8+8+6)	-	3	-	3
	24 Ton	1	-	-	2	1	2 (12+12)	-	-	2	2
							3 (8+8+8)	-	3	-	3
	26 Ton	-	-	-	-	-	2 (14+12)	-	-	2	2
28 Ton	1	-	-	2	1	2 (14+14)	-	-	2	2	
						3 (10+10+8)	-	3	-	3	
30 Ton	-	-	-	-	-	2 (16+14)	-	-	2	2	
						3 (10+10+10)	-	3	-	3	
32 Ton	1	-	-	2	1	2 (16+16)	-	-	2	2	
36 Ton						3 (12+12+12)	-	-	3	3	
38 Ton						3 (14+12+12)	-	-	3	3	
40 Ton						3 (14+14+12)	-	-	3	3	

- Two or more AHU below 10 Ton combination is available.
- Two or more AHU over 12 Ton combination is available.
- Combination AHU below 10 Ton with VRF FCU below 8 Ton is available.
- Combination AHU over 12 Ton with VRF FCU is prohibited.
- For the AHU prepared on-site, please design with referring to submittal of AHU.
Please refer to the design guideline for details.

■ Settings for each type (TA, TF, DDC)

Set with the SW501 switch on the control P.C. board MCC-1777.

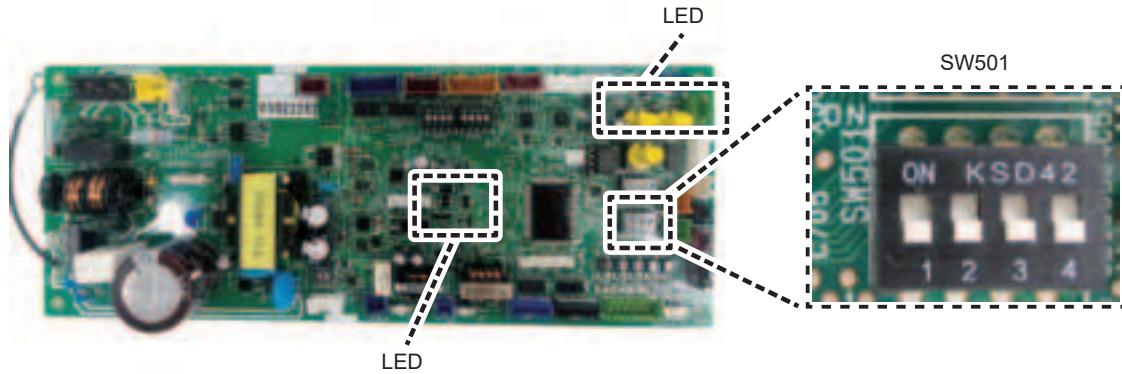

TA type: Set all SW501 to OFF.
Turn off Bit3 of SW501.

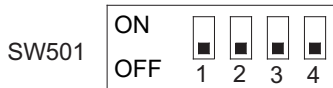

TF type: Turn on only Bit2 of SW501.
Turn off Bit3 of SW501.

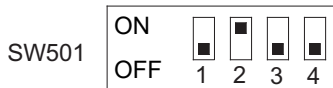

DDC type (0 - 10 V) Stepped Control: Turn on only Bit3 of SW501. (Refer to AI3 / *AI3 for details)



DDC type (0 - 10 V) Linear Control: Turn on Bit3 and Bit4 of SW501. (Refer to AI3 / *AI3 for details)

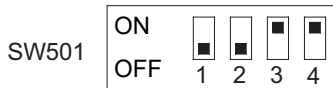

LED position and details

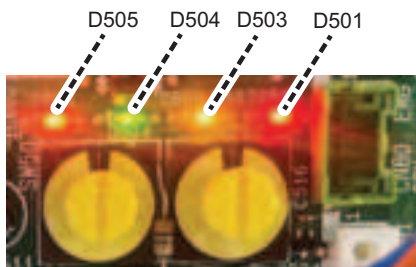

P.C. board LED	Meaning of lighting
D501	MCU power supply Lights when the power is turned on
D503	Main bus communication Flashes every 5 seconds. With central control: lighting and flashing every 5 seconds.
D504	Sub bus communication Flashes every 5 seconds. Group: lighting and flashing every 5 seconds.
D505	Mod bus communication When connected to Modbus, it lights up every 5 seconds.
D403	Sub bus power supply Sub bus lights while power is being supplied.

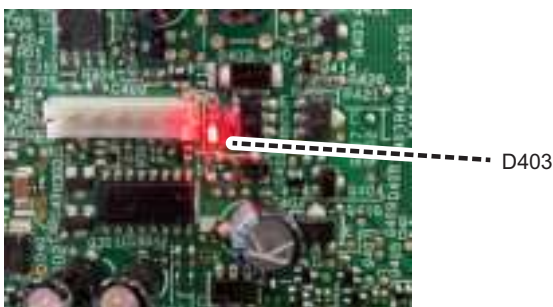

2. CONSTRUCTION VIEWS (EXTERNAL VIEWS)

TCB-IFDMR01UP-UL

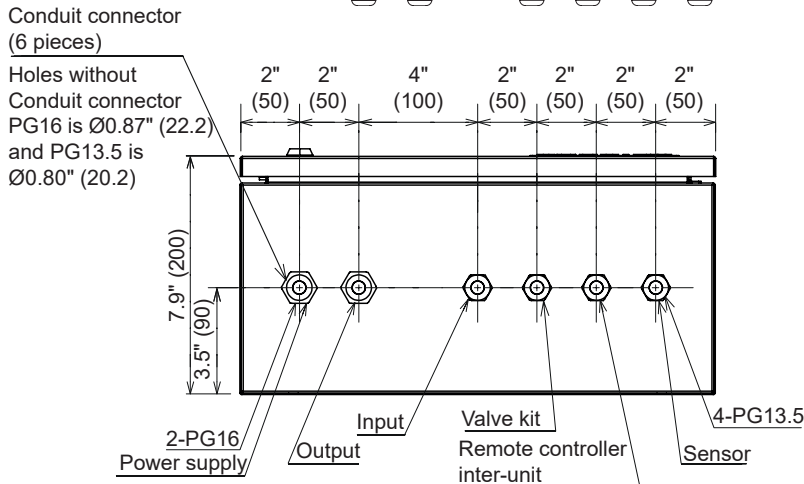
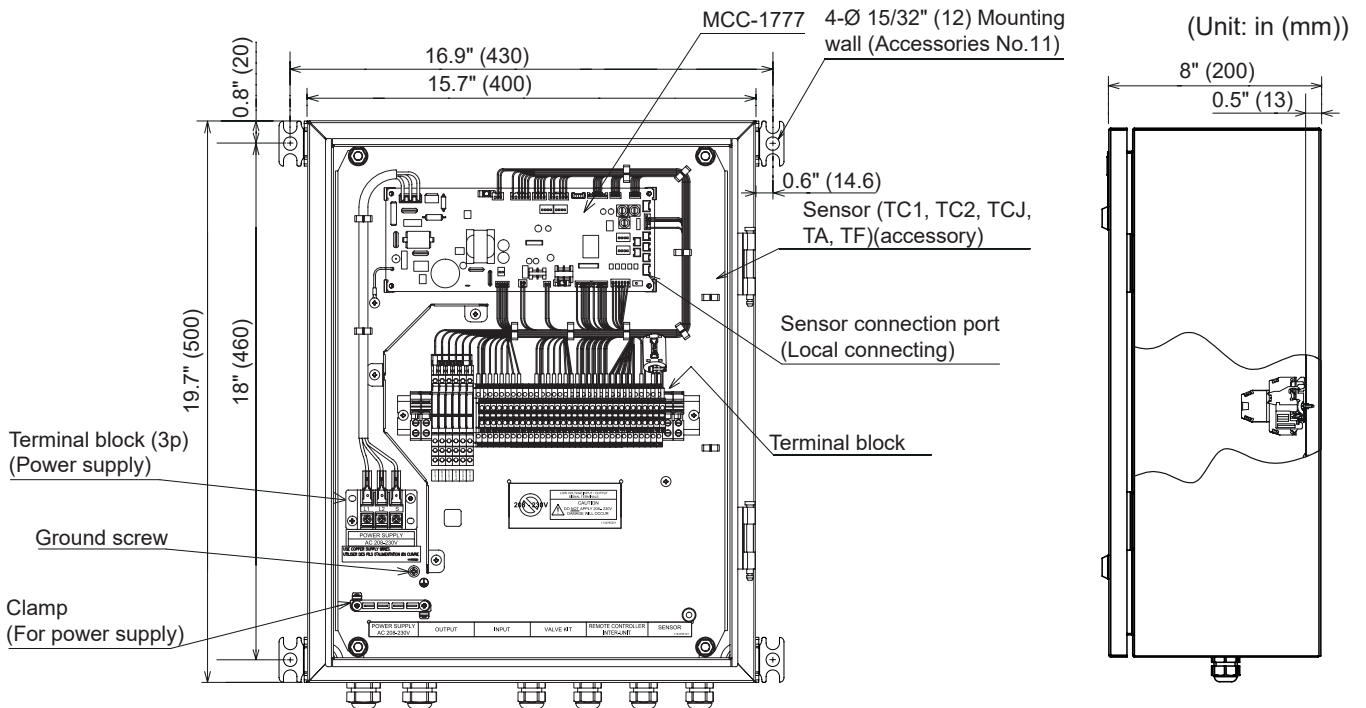

- Note)
- This product is designed for the indoor installation.
 - If the temperature sensor is short, use the Optional Sensor TCB-IFDES1001P-UL. (Temperature sensor with 32'10" (10 m) wiring length)
 - If any conduits are not use, Please apply silicone to cover the conduits (Hole).
 - Please apply silicone to the Conduit Connector after connecting the wire.
 - Before closing the conduits cover, wrap the wires harness by the heat insulation. (Accessories No.10)

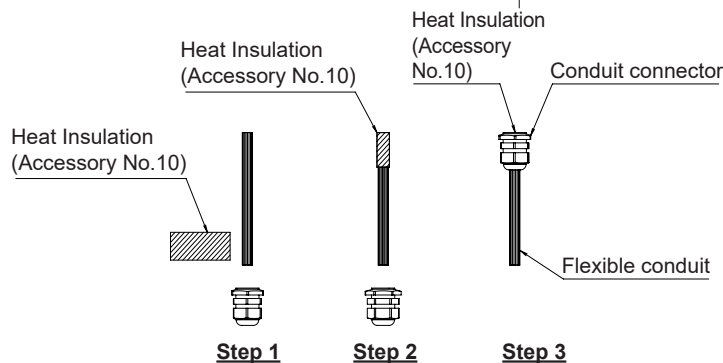
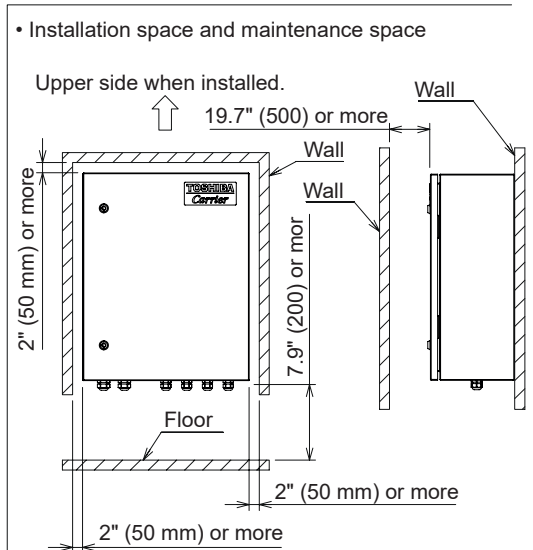

RBM-A0601UPVA-UL, RBM-A1201UPVA-UL, RBM-A1921UPVA-UL

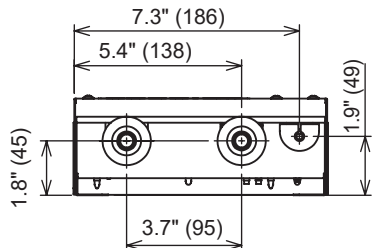
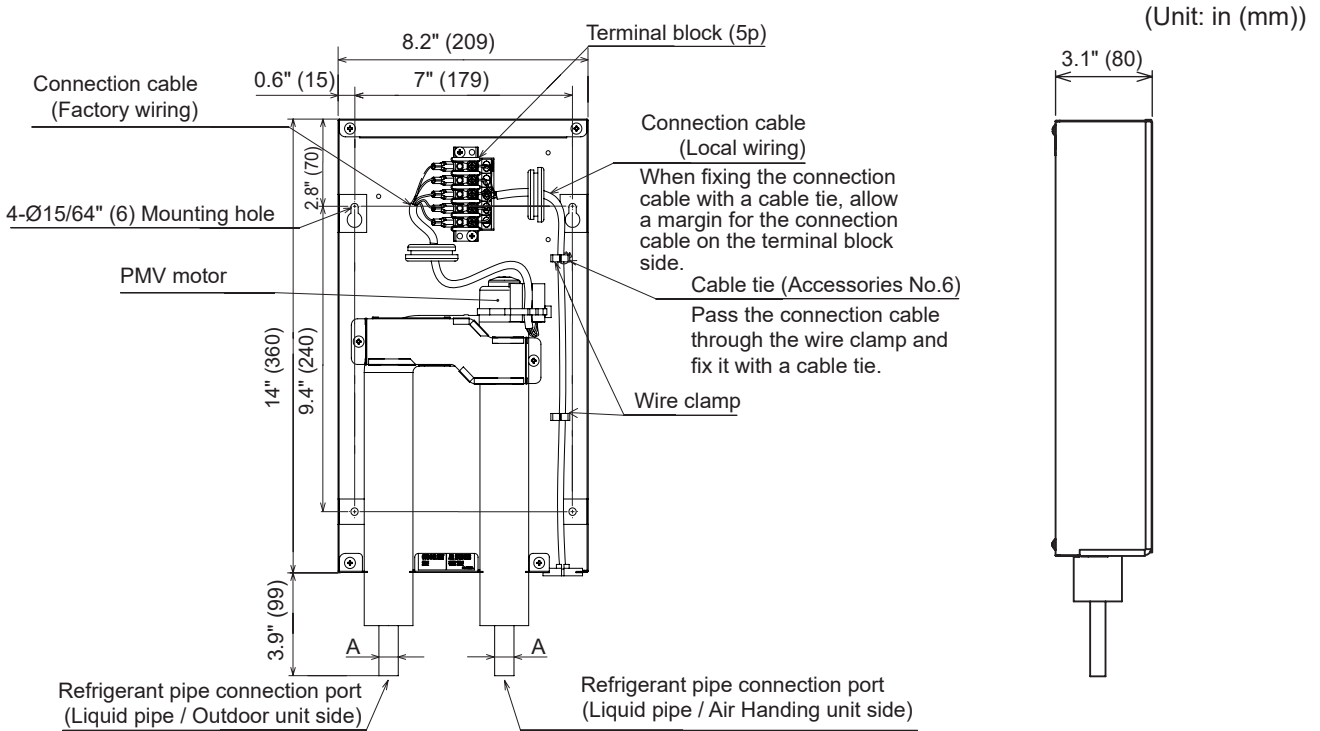

Note)
This product is designed for the indoor installation.

Model	A (Pipe)
RBM-A0601UPVA-UL	Ø3/8" (9.52)
RBM-A1201UPVA-UL	Ø1/2" (12.7)
RBM-A1921UPVA-UL	Ø5/8" (15.58)

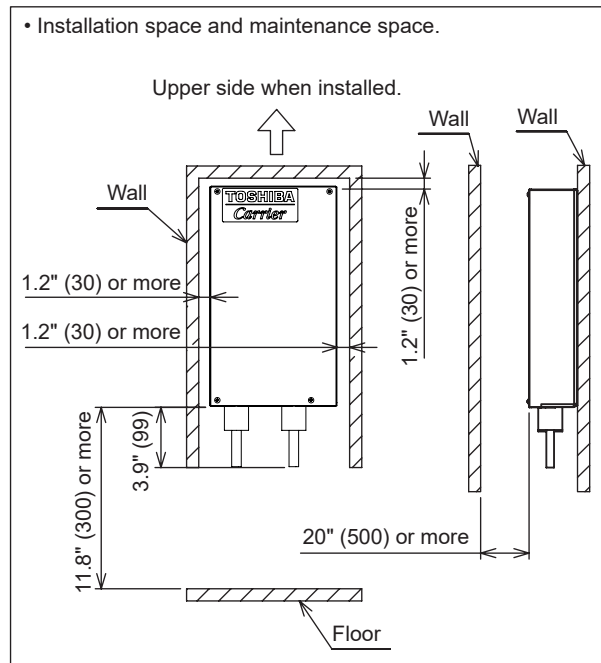

3. WIRING DIAGRAMS

TCB-IFDMR01UP-UL (Terminal block with relay)

Dx-coil controller Wiring Diagram

TCB-IFDMR01UP-UL
208/230-1-60

Notes

1. Please refer to the installation manual for wiring instruction.

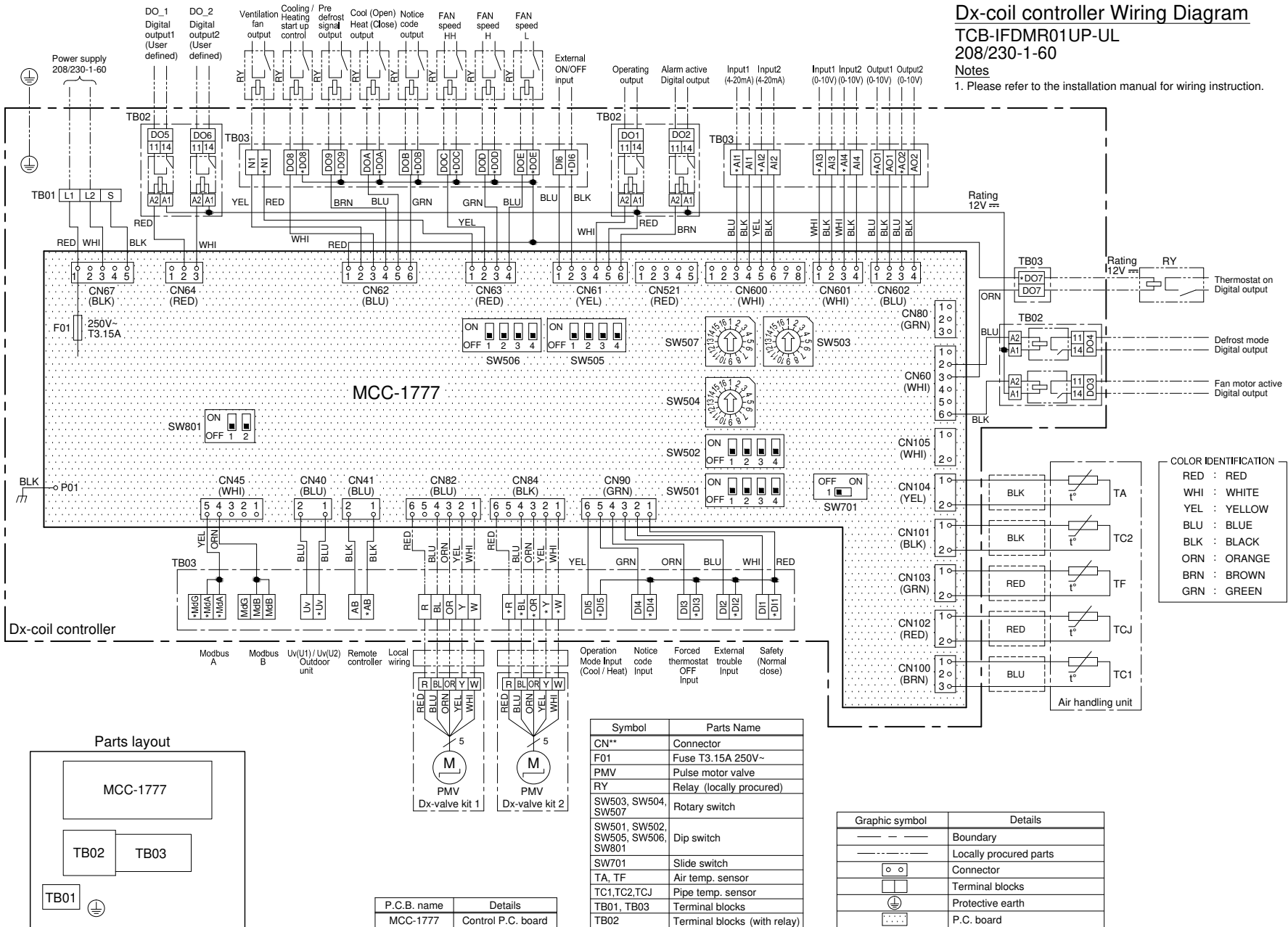

Parts layout

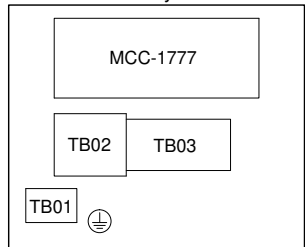

P.C.B. name	Details
MCC-1777	Control P.C. board

Symbol	Parts Name
CN**	Connector
F01	Fuse T3.15A 250V~
PMV	Pulse motor valve
RY	Relay (locally procured)
SW503, SW504, SW507	Rotary switch
SW501, SW502, SW505, SW506, SW801	Dip switch
SW701	Slide switch
TA, TF	Air temp. sensor
TC1, TC2, TCJ	Pipe temp. sensor
TB01, TB03	Terminal blocks
TB02	Terminal blocks (with relay)

Graphic symbol	Details
---	Boundary
---	Locally procured parts
○ ○	Connector
□	Terminal blocks
⊕	Protective earth
⋯	P.C. board

4. REFRIGERANT CYCLE DIAGRAM

4-1. TC1, TC2 and TCJ sensor position on DX COIL

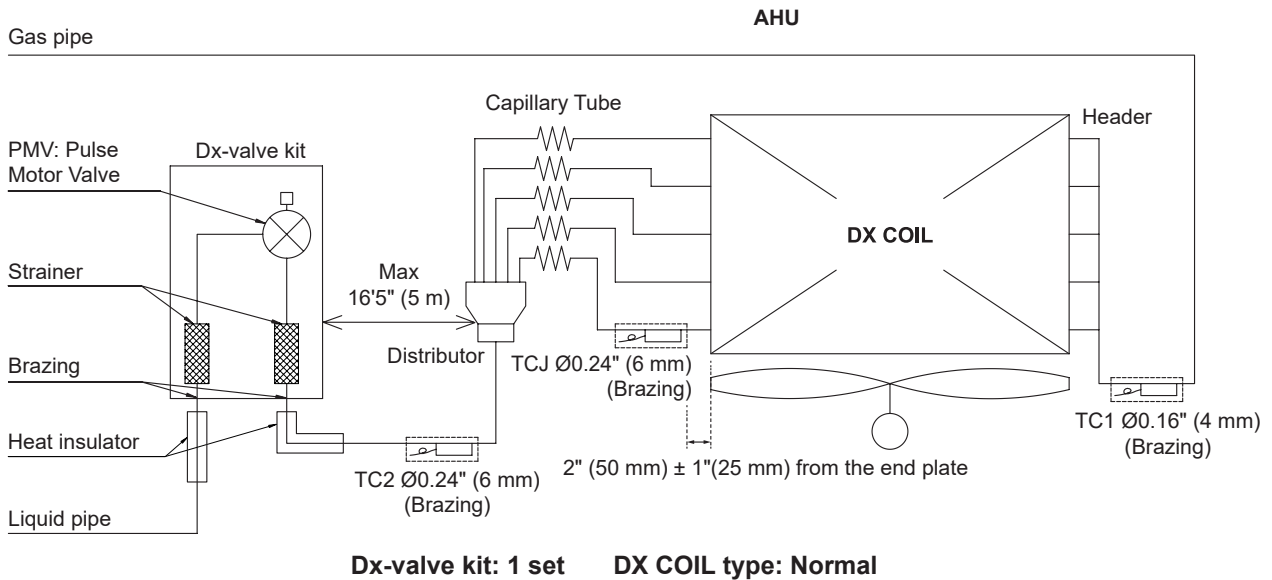

Example TA / TF*1 sensor position

1. Fresh Air Only

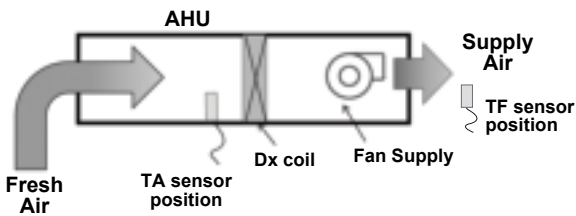

2. Outdoor Air (Fresh Air) mixed with Return Air

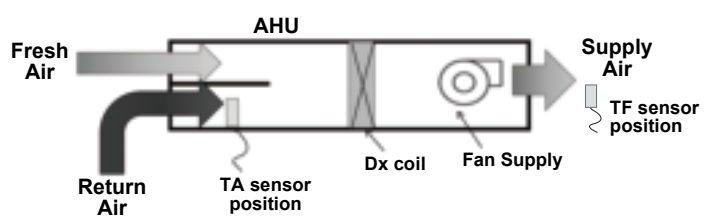

3. Outdoor Air (Fresh Air) mixed with Return Air by Heat Recovery Exchanger

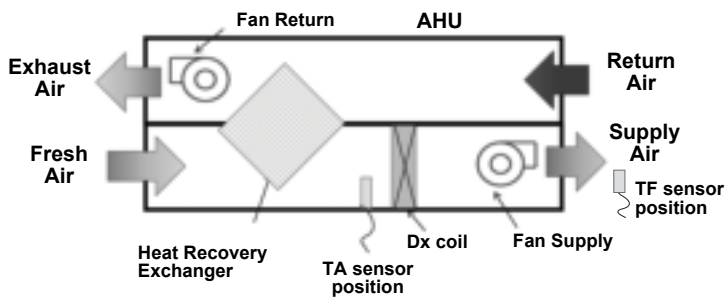

*1: TF sensor can only be used with SMMS-u.

4-2. Refrigerant circuit diagram

(1) Gas pipe

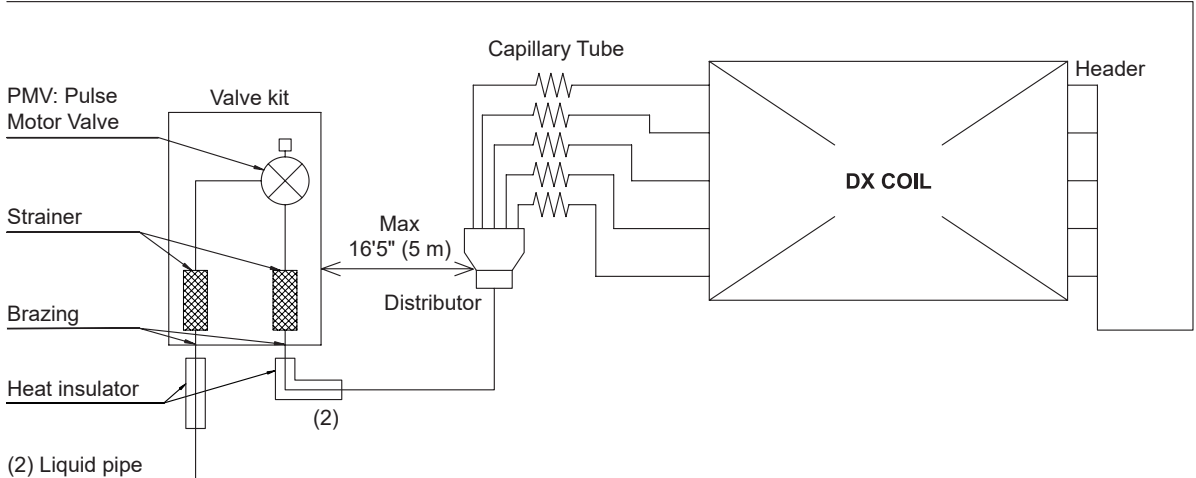

Valve kit: 1 set DX COIL type: Normal

(1) Gas pipe

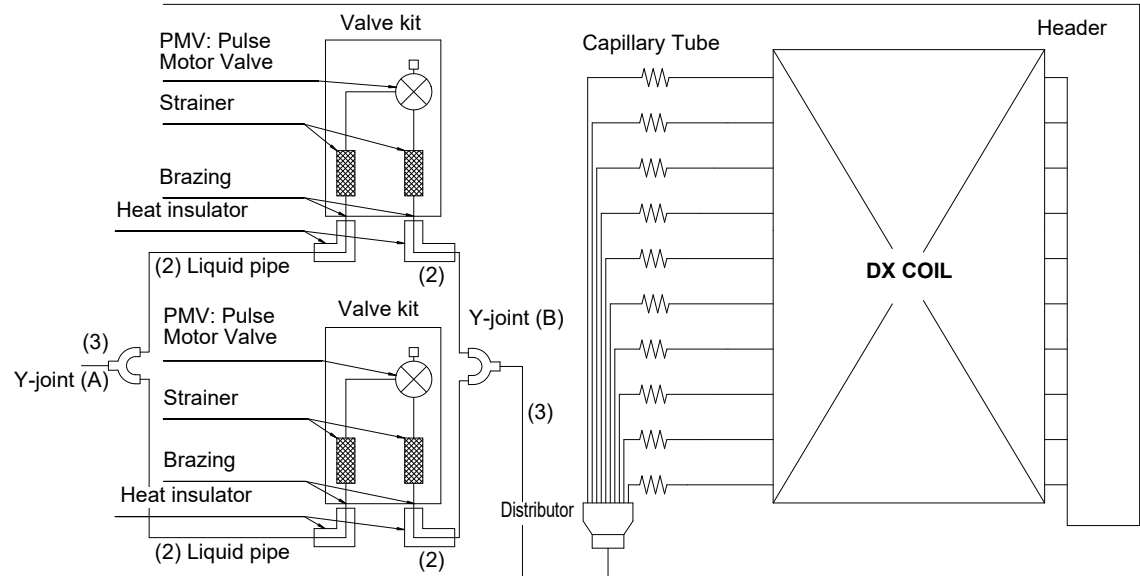

Valve kit: 2 sets DX COIL type: Normal

(1) Gas pipe

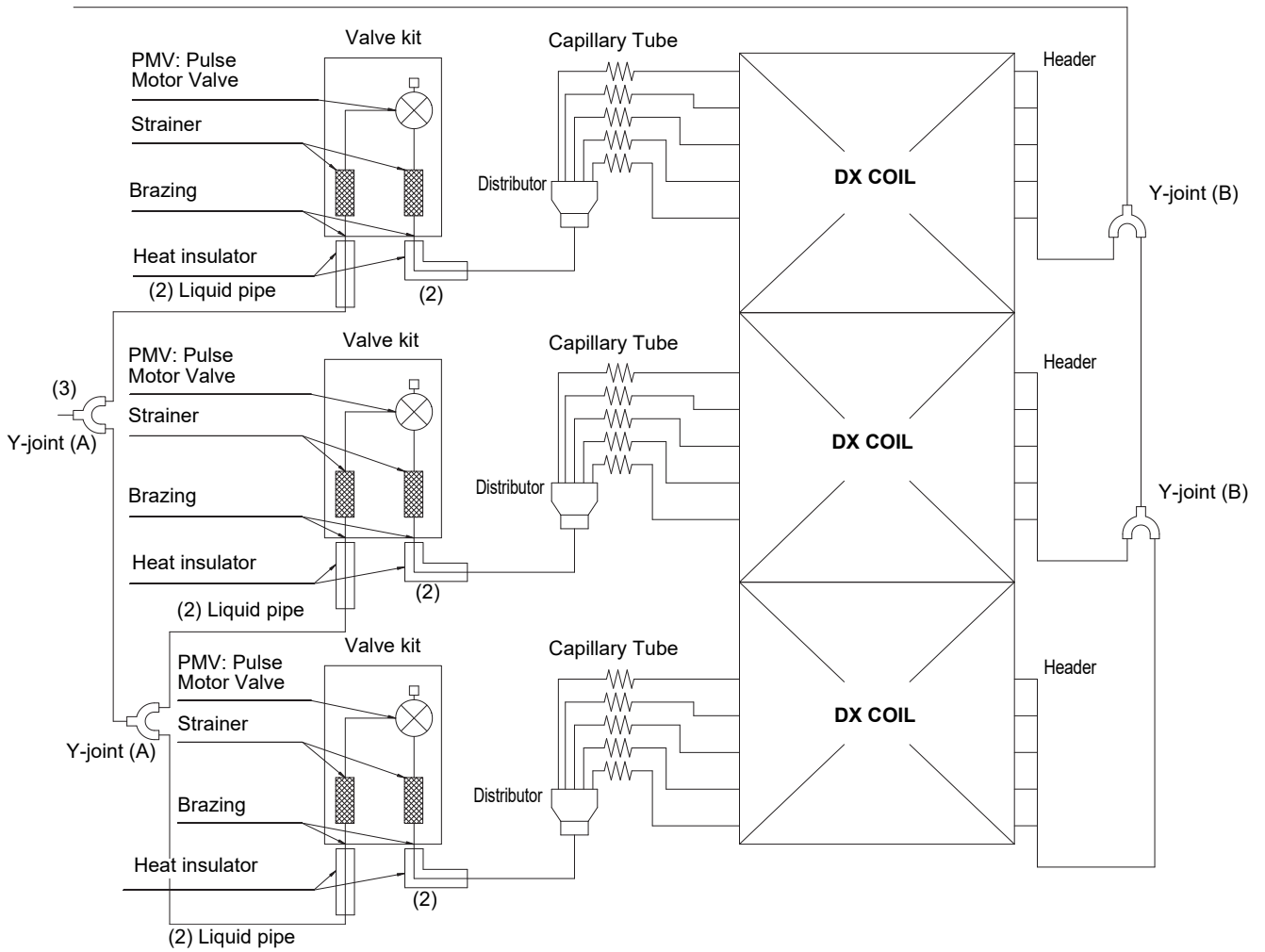

Valve kit: 3 sets DX COIL type: Interlaced, Split face

4-3. Piping size and Y-joint

Piping size and Y-joint

- Maximum real piping length between valve kit and Dx coil is up to 16'5" (5 m)

DX COIL type	Pipe diameter		
	(1) Gas pipe	(2) Liquid pipe	(3) Liquid pipe
Ton	Outer diameter		
0.6 - 1	3/8" (9.5)	1/4" (6.4)	/
1.25 - 1.5	1/2" (12.7)	1/4" (6.4)	
2 - 5	5/8" (15.9)	3/8" (9.5)	
6	3/4" (19.1)	1/2" (12.7)	
8	7/8" (22.2)		
10	1.1/8" (28.6)	5/8" (15.9)	
12 - 14			
16			
18	1.3/8" (34.9)	3/4" (19.1)	
20 - 22			
24 - 27	1.1/2" (38.1)	7/8" (22.2)	
28 - 36			
38 - 40			

DX-COIL type	Normol
Ton	Y-joint (A, B)
20	RBM-BY205E
22 ~ 50	RBM-BY305E

(Unit: in (mm))

4-4. Allowable length and allowable height difference of refrigerant piping

1) When connecting the Dx-coil interface

By the refrigerant circuit diagram, braze the sensor holder of TC1, TC2, TCJ of the valve kit and the accessory. Refer to the below table for the pipe diameter and the pipe length to use.

Item			6 Ton or more				Less than 6 Ton
			TA type		TF, DDC type		
			ft	m	ft	m	
Main pipe equivalent length			Same as piping length restriction of outdoor unit				Standard VRF outdoor unit piping limitations based on model selection apply
Total piping length			656	200	328	100	
Furthest equivalent pipe length L (real length)			427 (394)	130 (120)	328	100	
Furthest equivalent pipe length from the 1st branch			131	40	-		
Furthest equivalent pipe length between outdoor unit			Same as piping length restriction of outdoor unit		-		
Max. real length of pipes connected to indoor units			66	20	-		
Maximum equivalent between branching section			98	30	-		
Max. Height Difference	Outdoor unit - Indoor unit (Upper outdoor unit) H1		131 (40 m) or the outdoor unit spec. Whichever is shorter of outdoor unit.		131	40	
	Outdoor unit - Indoor unit (Lower outdoor unit) H2						
	H2 > 9.8 ft (3 m)						
	H2 ≤ 9.8 ft (3 m)						
Indoor unit - Indoor unit (Upper outdoor unit) H2					-		
Indoor unit - Indoor unit (Lower outdoor unit) H2					-		
Amount of additional Refrigerant			Refer to specification of outdoor unit				

4-5. Installation temperature sensor

By the refrigerant circuit diagram, braze the sensor holder of TC1, TC2, TCJ of the valve kit and the accessory. Refer to the below table for the pipe diameter and the pipe length to use.

Dx-valve kit and connection of the pipe

- Be sure to cool the strainer and PMV valve body using a wet cloth so that the body temperature does not exceed 248°F(120°C) while brazing.
- For the connection pipe, it may vibrate during the defrosting operation. Carry out the installation work so that the connection pipe does not break after a long-term use.

Sensor holders

- To ensure reliable operation, all Sensor holders must be fitted by brazing.
- Be careful of that the brazing material does not enter into the sensor holder when attaching the TC1, TC2 and TCJ sensor holder.

TC1 sensor

- Install it in the collecting part of the gas header.

TC2 sensor

- Install it in the between the liquid pipe distributor and the PMV.
(TC2 sensor is attached to the refrigerant cycle of AHU.)

TCJ sensor

- Install it in the pass where the temperature of the capillary tube is the lowest
- Keep a distance of 2" (50 mm) ± 1" (25 mm) from the end plate

TA, TF sensor

- Install the TA, TF sensor where the better of air flow.
- The TA sensor must be located in the Return Air position, prior to mixing with any fresh air.
- Install the TF sensor in a place where the discharge air temperature is uniform.

If the TC1, TC2, or TCJ sensor are easy to be subjected to the surrounding thermal effect, cover them with the heat insulator material, and fix them with the fixing band.

If the lead wires of various sensors are left over, protect them from the effects of external force, heat, and water, and fix them with a fixing band. If the lead wires of various sensors do not reach, use the Optional Sensor 32'10" (10 m) cable TCB-IFDES1001P-UL

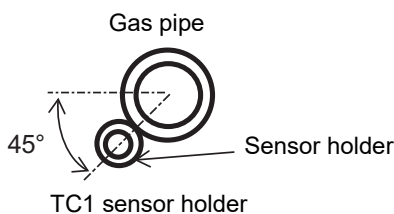

Braze the TC1 sensor on the location of the lower side 45° to detect the stable temperature.

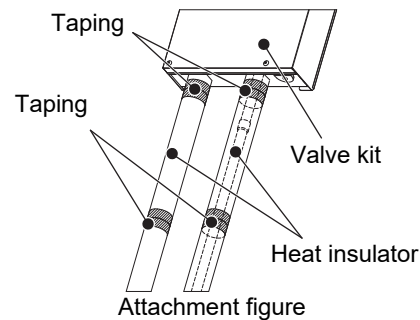

After brazing the pipe, wrap the attached heat insulator and fix it with a tape.

5. PARTS RATING

Dx-coil controller

No	part name	Model name or specification	Q'ty	
1	P.C. board	MCC-1777	1	
2	Terminal block (3P, for power supply)	JXO-3B, AC250V 20A	1	
3	Terminal block (for signal lines)	PCKK2.5-01P-11-00A(H)	32	
4	Terminal block with relay (for signal lines)	G2RV-SR700	6	
		Relay model name		G2RV-SR700-12DC
		Contact rating		250V max / 3A max (Minimum Current: 10 mA more)
		Load conditions		Resistive load
5	TA sensor	Length: 7.5 m, Connector color: Yellow	1	
6	TC1 sensor	Length: 7.5 m, Connector color: Brown	1	
7	TC2 sensor	Length: 7.5 m, Connector color: Black	1	
8	TCJ sensor	Length: 7.5 m, Connector color: Red	1	
9	TF sensor	Length: 7.5 m, Connector color: Green	1	

Dx valve kit

No	part name	Model name or specification	Q'ty RBM-A*****		
			0601UPVA-UL	1201UPVA-UL	1921UPVA-UL
1	PMV body	PAM-B60YGTF-1	1	0	0
2	PMV body	PAM-BA0YGTF-1	0	1	0
3	PMV body	PAM-BA2YGTF-1	0	0	1
4	PMV coil	PAM-MD12TF-301	1	1	0
5	PMV coil	PAM-MD12TF-306	0	0	1
6	Terminal block (5P)	JXO-B2G	1	1	1

Winding resistance of PMV coil (No.3, 4)

Measure position	Resistance value (at 20°C)	
	PAM-MD12TF-301	PAM-MD12TF-306
White - Red (COM)	180 to 220 Ω	90 to 110 Ω
Yellow - Red (COM)		
Orange - Red (COM)		
Blue - Red (COM)		

▼ Temperature sensor characteristics

TA and TF sensor

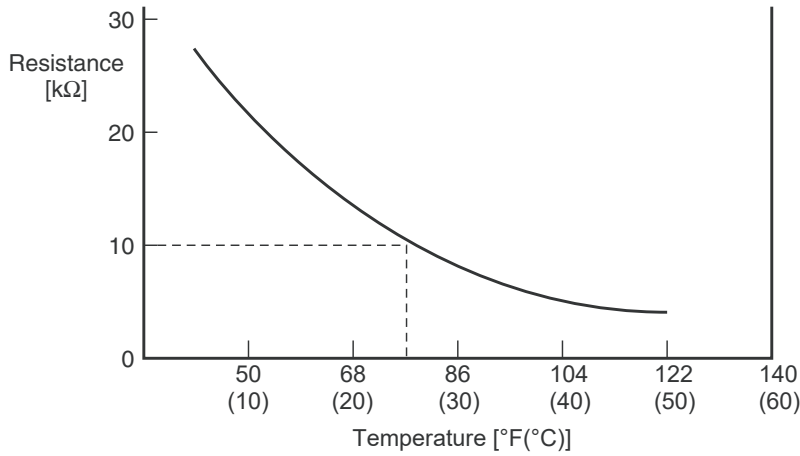

Temperature [°F(°C)]	Resistance [kΩ]
32(0)	33.9
41(5)	26.1
50(10)	20.3
59(15)	15.9
68(20)	12.6
77(25)	10.0
86(30)	8.0
95(35)	6.4
104(40)	5.2
113(45)	4.2
122(50)	3.5
131(55)	2.6
140(60)	2.4

TC1 sensor

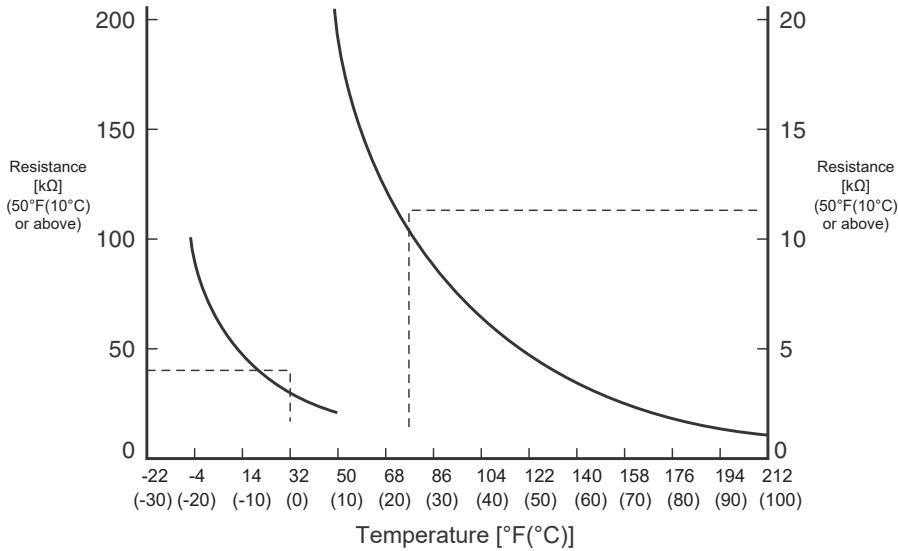

Temperature [°F(°C)]	Resistance [kΩ]
-4(-20)	99.9
5(-15)	74.1
14(-10)	55.6
23(-5)	42.2
32(0)	32.8
41(5)	25.4
50(10)	19.8
59(15)	15.6
68(20)	12.4
77(25)	10.0
86(30)	8.1
95(35)	6.5
104(40)	5.3
113(45)	4.4
122(50)	3.6
131(55)	3.0
140(60)	2.5
149(65)	2.1
158(70)	1.8
167(75)	1.5
176(80)	1.3
185(85)	1.1
194(90)	1.0
203(95)	0.8
212(100)	0.7

TC2 and TCJ sensors

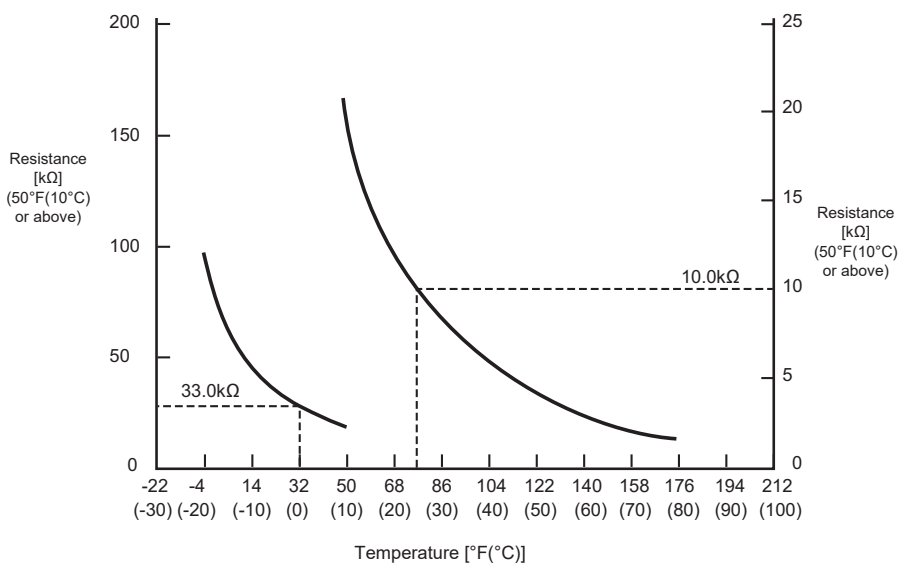

Temperature [°F(°C)]	Resistance [kΩ]
-4(-20)	101.7
5(-15)	76.3
14(-10)	57.7
23(-5)	44.0
32(0)	33.8
41(5)	26.1
50(10)	20.4
59(15)	16.0
68(20)	13.0
77(25)	10.0
86(30)	8.0
95(35)	6.4
104(40)	5.2
113(45)	4.2
122(50)	3.5
131(55)	2.8
140(60)	2.3
149(65)	1.9
158(70)	1.6
167(75)	1.4
176(80)	1.1

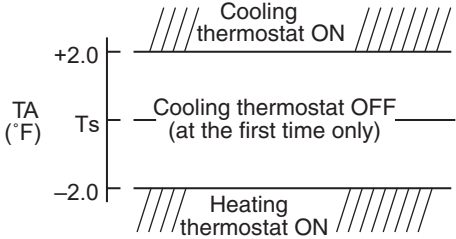

6. CONTROL OUTLINE

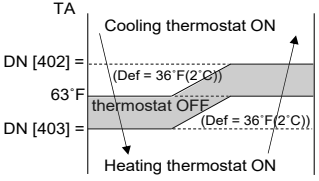
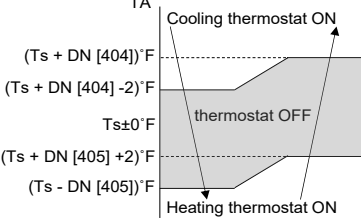
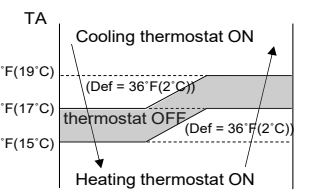
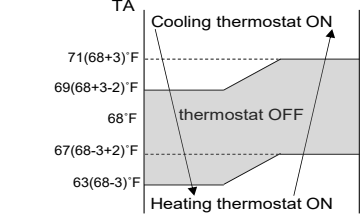
NO.	Item	Specification outline	Remarks								
1	Upon power supply reset	1) Distinction of outdoor unit When the power supply is reset, the outdoors are distinguished and the control is selected according to the distinguished result. 2) If resetting the power supply during occurrence of a trouble, the check code is once cleared. After ON/OFF button of the remote controller was pushed and the operation was resumed, if the abnormal status continues, the check code is again displayed on the remote controller.									
2	Operation selection	1. The operation mode changes in response to an operation selection command issued via the remote controller. <table border="1" data-bbox="427 584 1219 732" style="margin: 10px auto;"> <thead> <tr> <th>Remote controller command</th> <th>Control outline</th> </tr> </thead> <tbody> <tr> <td>STOP</td> <td>Air conditioner stop</td> </tr> <tr> <td>COOL</td> <td>Cooling operation</td> </tr> <tr> <td>HEAT</td> <td>Heating operation</td> </tr> </tbody> </table> <div data-bbox="427 757 1094 1328" style="border: 1px solid black; padding: 10px; margin: 10px auto;"> <p>AUTO Heat recovery system outdoor unit type (TA type)</p> <ul style="list-style-type: none"> • TA and Ts automatically select COOL/ HEAT operation mode for operation. • The operation is performed as shown in the following figure according to TA value at the first time only. (In the range of $T_s - 2 < TA < T_s + 2$, Cooling thermostat OFF (Fan) / Setup air volume operation continues.)  <p>* Heat recovery system outdoor unit type can select automatic mode.</p> </div>	Remote controller command	Control outline	STOP	Air conditioner stop	COOL	Cooling operation	HEAT	Heating operation	Ts: Temperature setting TA: Room temperature
Remote controller command	Control outline										
STOP	Air conditioner stop										
COOL	Cooling operation										
HEAT	Heating operation										

NO.	Item	Specification outline	Remarks																												
		<p>AUTO Heat recovery system outdoor unit type (TF type)</p> <p>The difference between the suction temperature and the discharge temperature and suction temperature set by the remote controller automatically switches between cooling and heating operations. If both conditions 1 and 2 are satisfied, the thermostat will be turned on.</p> <p>※For TF type, TA = Suction air temperature.</p> <p><Thermostat ON condition 1> Judgment by suction air temperature (TA)</p>  <p><Thermostat ON condition 2> Judgment by Ts</p>  <p>Example: Ts = 68°F(20°C) DN [402] = 19 / [403] = 15 / [404] = 0003 / [405] = 0003</p>   <p>* Heat recovery system outdoor unit type can select automatic mode.</p>																													
3	Remote controller temperature setting (temperature of discharge air)	<p>1. Adjustment range - remote controller temperature setting (°F)</p> <table border="1" data-bbox="427 1384 884 1464"> <thead> <tr> <th>Type</th> <th>COOL</th> <th>HEAT</th> <th>AUTO</th> </tr> </thead> <tbody> <tr> <td>TA</td> <td>64~84</td> <td>64~84</td> <td>64~84</td> </tr> <tr> <td>TF</td> <td>64~77</td> <td>64~86</td> <td>64~77</td> </tr> </tbody> </table> <p>2. In heating operation, the temperature setting may be fine-tuned via the DN code "06".</p> <table border="1" data-bbox="427 1547 1211 1615"> <thead> <tr> <th>SET DATA</th> <th>0</th> <th>2</th> <th>4</th> <th>6</th> </tr> </thead> <tbody> <tr> <td>Temperature setting adjustment</td> <td>+0 °F</td> <td>+2 °F</td> <td>+4 °F</td> <td>+6 °F</td> </tr> </tbody> </table> <p>Factory default</p> <table border="1" data-bbox="427 1682 667 1760"> <thead> <tr> <th></th> <th>SET DATA</th> </tr> </thead> <tbody> <tr> <td>TA type</td> <td>2</td> </tr> <tr> <td>TF type</td> <td>0</td> </tr> </tbody> </table>	Type	COOL	HEAT	AUTO	TA	64~84	64~84	64~84	TF	64~77	64~86	64~77	SET DATA	0	2	4	6	Temperature setting adjustment	+0 °F	+2 °F	+4 °F	+6 °F		SET DATA	TA type	2	TF type	0	<p>DDC type : Shift in heating suction temperature. Since there is no function of the room temperature control, the room temperature and the outlet temperature are not controlled even if this setting is changed.</p> <p>TF : Temperature of discharge air</p> <ul style="list-style-type: none"> If the thermostat does not turn on even in the thermostat ON area on the left, check the position of the TA sensor.
Type	COOL	HEAT	AUTO																												
TA	64~84	64~84	64~84																												
TF	64~77	64~86	64~77																												
SET DATA	0	2	4	6																											
Temperature setting adjustment	+0 °F	+2 °F	+4 °F	+6 °F																											
	SET DATA																														
TA type	2																														
TF type	0																														

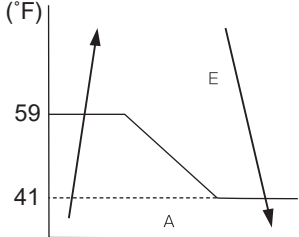
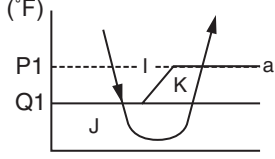
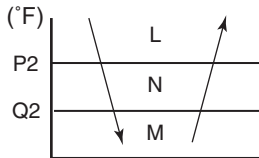
NO.	Item	Specification outline	Remarks
4	Automatic capacity control	<p>(TA type)</p> <p>Based on the difference between TA and Ts, the operation capacity is determined by the outdoor unit.</p> <div style="display: flex; justify-content: space-around; align-items: center;"> <div style="text-align: center;"> <p>COOL</p> </div> <div style="text-align: center;"> <p>HEAT</p> </div> </div> <p>(TF type)</p> <p>Based on the difference between TF and Ts, and the amount of temperature change, the operation capacity is determined by the Fresh air intake to command the operating frequency to the outdoor unit.</p> <ol style="list-style-type: none"> 1) COOL operation <ul style="list-style-type: none"> TF(n)-Ts(n) : Temperature difference n : Times of detection TF(n-1)-TF(n) : Temperature change amount 2) HEAT operation <ul style="list-style-type: none"> Ts(n)-TF(n) : Temperature difference amount n : Times of detection TF(n)-TF(n-1) : Temperature change amount <p>The Thermostat OFF will be activated only when Forced Thermostat OFF conditions are satisfied.</p>	<p>Ts: Temperature set by remote controller. TA: Room temperature.</p> <p>TF : Temperature of discharge air Ts : Temperature set by remote controller</p>
5	Forced Thermostat OFF (TF type)	<p>The Forced thermostat OFF will be activated when conditions below are satisfied.</p> <ol style="list-style-type: none"> (1) Outdoor / Suction air temp. (TA) <ul style="list-style-type: none"> • COOL . . . When $TA \leq 66^{\circ}\text{F}$ (T a c) • HEAT . . . When $TA \geq 59^{\circ}\text{F}$ (T a h) or when $TA \leq 14^{\circ}\text{F}$ (2) Outdoor / Suction air temp. (TA) and temperature set by remote controller (Ts) <ul style="list-style-type: none"> • COOL . . . When $TA \leq Ts + 37^{\circ}\text{F}$ (T β c) • HEAT . . . When $TA \geq Ts - 37^{\circ}\text{F}$ (T β h) (3) Temperature of discharge air (TF) <ul style="list-style-type: none"> • COOL . . . When $TF \leq 37^{\circ}\text{F}$ (T γ c) • HEAT . . . When $TF \geq 140^{\circ}\text{F}$ (T γ h) 	<p>CODE No. (DN) T a c : (DN) 「402」 =0019 T a h : (DN) 「403」 =0015</p> <p>T β c : (DN) 「404」 =0003 T β h : (DN) 「405」 =0003</p> <p>T γ c : (DN) 「406」 =0003 T γ h : (DN) 「407」 =0060</p>

NO.	Item	Specification outline	Remarks															
	(TF type)	<p>(1) Under HEAT operation, the higher temperature of TC2 sensor and TCJ sensor is compared with temperature of TC1 sensor then lower temperature is used to set the upper limit of the fan tap. Under defrosting operation, the control point is set to +43°F.</p>  <p>A zone : OFF E zone: follow a remote controller fan speed setup</p> <p>The TF temperature is also included in the judgment when moving from E to A zone. In addition to (1), if the TF temperature is 41°F. or less, it will move to the A zone.</p>	<p>TCJ : Temperature of Indoor heat exchange sensor</p> <ul style="list-style-type: none"> In zone A, "PRE-HEAT" is displayed. 															
8	Freeze prevention control (low temp. release)	<p>1. During cooling, the air conditioner is operated in the manner described below according to the temperature readings of the TC1, TC2 and TCJ sensors.</p> <ul style="list-style-type: none"> If zone J operation is detected for 5 minutes, the air conditioner is forced into thermostat OFF. In zone K, the timer is put on pause, with the current timer count retained. If zone I operation is detected, the timer count is cleared, and the air conditioner returns to normal operation. If continuous zone J operation forces the air conditioner into thermostat OFF, the indoor fan is operated in breeze mode until it moves into zone I. The control is terminated under the following conditions: <p>Termination conditions</p> <ol style="list-style-type: none"> TC1 ≥ 54°F, TC2 ≥ 54°F, and TCJ ≥ 54°F  <table border="1" data-bbox="737 1034 1050 1131"> <thead> <tr> <th></th> <th>TC1</th> <th>TC2, TCJ</th> </tr> </thead> <tbody> <tr> <td>P1</td> <td>50°F(41°F)</td> <td>14°F</td> </tr> <tr> <td>Q1</td> <td>32°F</td> <td>7°F</td> </tr> </tbody> </table> <ol style="list-style-type: none"> Passage of 20 minutes after stoppage <p>2. During cooling, the air conditioner is operated in the manner described below according to the temperature readings of the TC2 and TCJ sensors.</p> <ul style="list-style-type: none"> If zone M operation is detected for 45 minutes, the air conditioner is forced into thermostat OFF. In zone N, the timer is put on pause, with the current timer count retained. When the air conditioner goes back into zone M, timer count is resumed from the retained value.  <table border="1" data-bbox="737 1512 922 1608"> <thead> <tr> <th></th> <th>TC2, TCJ</th> </tr> </thead> <tbody> <tr> <td>P2</td> <td>41</td> </tr> <tr> <td>Q2</td> <td>28</td> </tr> </tbody> </table> <ul style="list-style-type: none"> If zone L operation is detected, the timer count is cleared, and the air conditioner returns to normal operation. <p>Reset conditions</p> <ol style="list-style-type: none"> TC1 ≥ 54°F, TC2 ≥ 54°F and TCJ ≥ 54°F Passage of 20 minutes after stoppage 		TC1	TC2, TCJ	P1	50°F(41°F)	14°F	Q1	32°F	7°F		TC2, TCJ	P2	41	Q2	28	<ul style="list-style-type: none"> If this control occurs frequently, check the mounting position of the temperature sensor. The TC1 sensor position may be incorrect.
	TC1	TC2, TCJ																
P1	50°F(41°F)	14°F																
Q1	32°F	7°F																
	TC2, TCJ																	
P2	41																	
Q2	28																	
9	Refrigerant (Oil) recovery control in cooling operation	<p>Indoor units during stop/thermostat OFF or FAN operation perform following controls when a refrigerant (compressor oil) recovery signal is received from outdoor unit at the cooling operation,</p> <p>(1) Opening the indoor unit PMV at constant valve opening. (For a maximum of about 4 minutes)</p>	<p>Control is performed per two hours or when the outdoor unit determines its need.(It varies depending on the indoor units connected.)</p>															

NO.	Item	Specification outline	Remarks
10	Heating refrigerant (oil) recovery control	<p>While the outdoor unit is recovering heating refrigerant (oil), the indoor units perform the following control tasks:</p> <ol style="list-style-type: none"> 1) Open the indoor PMV to a certain degree. 2) Control the indoor fan according to the operation mode. <p>[Indoor units operating in heating thermostat ON / OFF state] Let the indoor fan continue operating, but turn it off if the temperature of the indoor heat exchanger drops.</p> <p>[Indoor units operating in FAN mode] Turn off the indoor fan and display “HEATING STANDBY  ” on the remote controller.</p> <p>[Non-operational indoor units] Keep the indoor fan turned off.</p> <p>Note) For details, refer to the outdoor unit Service manual.</p>	<ul style="list-style-type: none"> • Recovery operation normally takes place roughly every hour. • The opening position of the indoor PMV depending on the type and capacity of the indoor unit.
11	Short intermittent operation compensation control	<ol style="list-style-type: none"> 1. For 5 minutes after startup, the system is forced to continue operating even if it reaches the thermostat OFF region. (For TA and DDC type. TF type is 18 minutes) 2. However, priority is given to cooling / heating selection, operation standby, and protective control, so that there is no overriding of thermostat OFF in these cases. 	
12	Elimination of residual heat	<ol style="list-style-type: none"> 1. When the air conditioner is turned off after engaging in heating operation, the indoor fan is operated for about 30 seconds in “breeze” mode. 	
13	Operation standby Heating standby	<p><Operation standby> Displayed on remote controller</p> <ol style="list-style-type: none"> 1. When any of the check codes listed below is displayed <ul style="list-style-type: none"> • “P05” - Detection of an open phase in the power supply wiring • “P10” - Detection of “Safety contact is open” in at least one indoor unit • “L30” - Detection of “External trouble Input (terminal DI2 / *DI2)” in at least one indoor unit 2. Forced thermostat OFF <ul style="list-style-type: none"> • “COOL / DRY” operation is unavailable because at least one indoor unit is operating in “HEAT” mode. • “HEAT” operation is unavailable because at least one indoor unit is operating in “COOL / DRY” mode under priority cooling setting (External trouble Input (terminal DI2 / *DI2)). 3. All indoor units not able to engage in any of the above operations stand by in thermostat OFF state. 4. The indoor fan has been turned off because the system is engaged in a heat refrigerant (oil) recovery operation. <p><Heating standby> Displayed on remote controller When stopping the fan to prevent the blowing of the cooled air when the heating operation is started or operated.</p>	<ul style="list-style-type: none"> • “OPERATION STANDBY  ” displayed No display provided on wireless remote controller • “HEATING STANDBY  ” displayed

NO.	Item	Specification outline	Remarks
14	Frequency fixed operation (Test run)	<p><In case of wired remote controller></p> <ol style="list-style-type: none"> 1) When pushing [CHK] button for 4 seconds or more, [TEST] is displayed on the display screen and the mode enters in Test run mode. 2) Push [ON/OFF] button. 3) Using [MODE] button, set the mode to [COOL] or [HEAT]. <ul style="list-style-type: none"> • Do not use other mode than [COOL]/[HEAT] mode. • During test run operation, the temperature cannot be adjusted. • An trouble is detected as usual. • A frequency fixed operation is performed. 4) After the test run, push [ON/OFF] button to stop the operation. (Display in the display part is same as the procedure in Item 1.) 5) Push [CHK] button to clear the test run mode. ([TEST] display in the display part disappears and the status returns to the normal stop status.) 	Command frequency is approximately [S7]
15	Indoor PMV Max.opening	1500 pls	
16	Safety contact (P10)	<ol style="list-style-type: none"> 1. "P10" is displayed in the following cases. <ul style="list-style-type: none"> • If detection of "Safety contact is open" at least in one indoor unit. • During the cooling dry (automatic cooling) operation, if the open is detected, the thermostat is forcibly turned off and the check code is displayed. <p>If the open is continued for 1 minute during the heating blowing operation, the thermostat is forcibly turned off and the check code is displayed after 5 minutes continuation.</p>	If this contact is not used, a bridge connection should be installed on the terminals DI1 / *DI1.
17	External trouble Input (L30)	<ol style="list-style-type: none"> 1. "L30" is displayed in the following cases. <ul style="list-style-type: none"> • Detection of "External trouble Input (terminal DI2 / *DI2)" at least in one indoor unit. • During the operation, if the short-circuit is detected, the thermostat is forcibly turned off, and the check code is displayed after 1 minute continuation. • If the check code is confirmed, only the target indoor unit stops. 	Fan trouble input is opened at shipping.
18	Auxiliary temperature sensor (Tx)	<p>The following functions can be used by connecting the Optional Sensor (TCB-IFDES1001P-E) (sold separately).</p> <p>※Prepare an Optional Sensor according to the intended use and connect it to CN105.</p> <ol style="list-style-type: none"> (1) Select the intended use of Tx. DN [4A7] = 0000: Not used / 0001: TA sensor / 0002: TF sensor (2) Select whether to use Tx as a substitute for the sensor selected in DN [4A7] or as an average. DN [4A8] = 0000: Use as an alternative. 0001: Example of averaging and using) TA' = (TA + TX) / 2 (3) The Tx sensor value is displayed on the DN [F5] of the remote controller. 	Auxiliary temperature sensor trouble is notified as a Notice code.

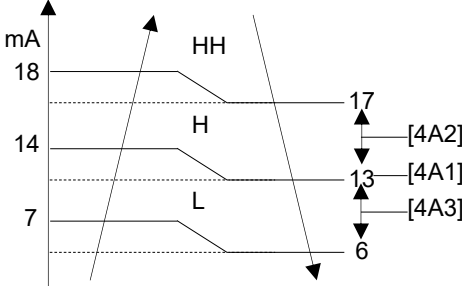
NO.	Item	Specification outline	Remarks																				
19	FAN control by external input	<p>Change the fan speed by inputting 4-20mA to the terminal * AI1 / AI1. (1) 4- 20mA upload fan speed DN [4A0] = 0000: No setting = 0001: With control (FAN control from the outside is prioritized) = 0002: With control (Priority is given to FAN control by 4 - 20mA input)</p> <p>DN [4A1] = 0014: 14mA (default) applicable range 7mA to 16mA DN [4A2] = 0004: [4A1] + 4mA (default) applicable range +1 to +11 DN [4A3] = 0007: [4A1] - 7mA (default) applicable range -1 to -12</p> 																					
20	FAN output (0-10V)	<p>The FAN speed is output at 0 - 10V from the terminal * AO1 / AO1. Each output voltage value can be changed by the DN code. * The ripple voltage of 0 - 10 V is less than ± 30 mV of the set voltage. Connect equipment that is not affected by this ripple voltage. Terminal AO2 / AO2 cannot be used.</p> <table border="1" data-bbox="438 1064 1088 1236"> <thead> <tr> <th>FAN speed</th> <th>Output (Default)</th> <th>DN code (Default)</th> <th>Applicable range</th> </tr> </thead> <tbody> <tr> <td>HH</td> <td>9V</td> <td>4A4 (0009)</td> <td>8V (0008) -10V (0010)</td> </tr> <tr> <td>H</td> <td>6V</td> <td>4A5 (0006)</td> <td>4V (0004) - 7V (0007)</td> </tr> <tr> <td>L</td> <td>2V</td> <td>4A6 (0002)</td> <td>1V (0001) - 3V (0003)</td> </tr> <tr> <td>STOP</td> <td>0V</td> <td>-</td> <td>-</td> </tr> </tbody> </table>	FAN speed	Output (Default)	DN code (Default)	Applicable range	HH	9V	4A4 (0009)	8V (0008) -10V (0010)	H	6V	4A5 (0006)	4V (0004) - 7V (0007)	L	2V	4A6 (0002)	1V (0001) - 3V (0003)	STOP	0V	-	-	
FAN speed	Output (Default)	DN code (Default)	Applicable range																				
HH	9V	4A4 (0009)	8V (0008) -10V (0010)																				
H	6V	4A5 (0006)	4V (0004) - 7V (0007)																				
L	2V	4A6 (0002)	1V (0001) - 3V (0003)																				
STOP	0V	-	-																				

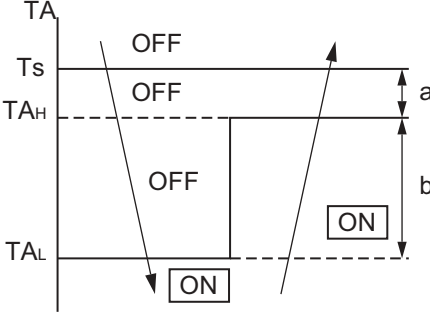
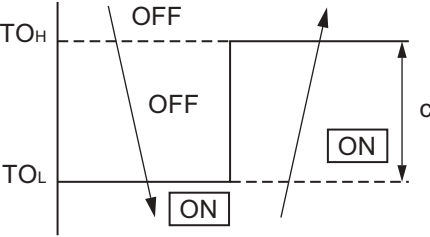
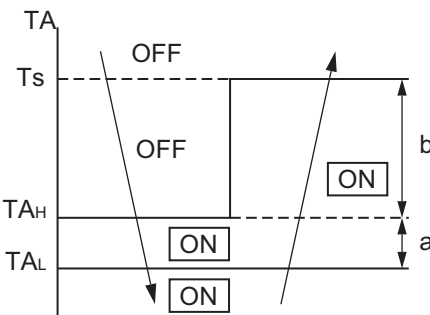
NO.	Item	Specification outline	Remarks
21	Secondary heating	<p>Secondary heating can be used while heating operations are performed.</p> <p><Control Outline (Normal Mode)></p> <ol style="list-style-type: none"> 1) If the difference between the indoor temperature and the outdoor temperature is large while the air conditioner is operating, turn ON the secondary heating. 2) This function is valid when the CODE No. (DN) [DC] is set to "0001" (0.9°F(0.5°C)) to "0010" (9°F(5.0°C)) using the wired remote controller, and the output to the external heating source will turn ON if the room temperature satisfies the condition. 3) The output will always stay ON while defrosting operations are being performed.  <p>The diagram shows a vertical axis for indoor temperature (TA) with horizontal lines for setpoint (Ts), high limit (TAH), and low limit (TAL). A sawtooth wave represents the room temperature. The secondary heating output is OFF when the room temperature is between Ts and TAH, and ON when it falls below TAL. The distance between Ts and TAH is labeled 'a', and between TAH and TAL is labeled 'b'.</p> <ol style="list-style-type: none"> 4) The output can be turned on by the outdoor temperature when CODE No. (DN) [C7] is set to "0001" (1.8°F(1°C)) to "0010" (18°F(10°C)) using the wired remote controller.  <p>The diagram shows a vertical axis for outdoor temperature (TO) with horizontal lines for setpoint (TOH) and low limit (TOL). A sawtooth wave represents the outdoor temperature. The secondary heating output is OFF when the outdoor temperature is between TOH and TOL, and ON when it falls below TOL. The distance between TOH and TOL is labeled 'c'.</p> <p><Control Outline (Flip Mode)></p> <ol style="list-style-type: none"> 1) If the difference between the room temperature and the set temperature is large while using secondary heating, run the air conditioner. 2) This function is valid when the CODE No. (DN) [C5] is set to "0001" (Flip mode) or the CODE No. (DN) [C7] is set to "0001" (1.8°F(1°C)) to "0010" (18°F(10°C)) using the wired remote controller, and when the output is switched ON when the room temperature satisfies the conditions. <p>* The outdoor temperature determination is invalid whilst this control is performed.</p>  <p>The diagram shows a vertical axis for indoor temperature (TA) with horizontal lines for setpoint (Ts), high limit (TAH), and low limit (TAL). A sawtooth wave represents the room temperature. The secondary heating output is ON when the room temperature is between Ts and TAH, and OFF when it falls below TAL. The distance between Ts and TAH is labeled 'b', and between TAH and TAL is labeled 'a'.</p>	<p>TA_H : Temp.set air high (= Ts - a) TA_L : Temp.set air low (= TA_H - b)</p> <p>TO_H : Temp.set out high TO_L : Temp.set out low (= TO_H - c)</p>

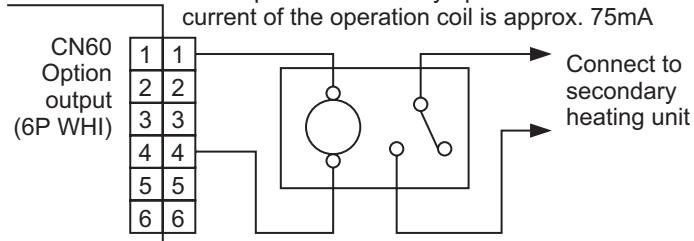
NO.	Item	Specification outline	Remarks																																									
21	Secondary heating (Continued)	<table border="1" data-bbox="549 226 1107 338"> <tr> <td data-bbox="549 226 660 259">DN [C5]</td> <td data-bbox="660 226 788 259">Data</td> <td data-bbox="788 226 1107 259">Secondary heating mode</td> </tr> <tr> <td></td> <td data-bbox="660 259 788 293">0000</td> <td data-bbox="788 259 1107 293">Normal mode (Factory default)</td> </tr> <tr> <td></td> <td data-bbox="660 293 788 338">0001</td> <td data-bbox="788 293 1107 338">Flip mode</td> </tr> </table> <table border="1" data-bbox="549 367 1107 501"> <tr> <td data-bbox="549 367 660 400">DN [C6]</td> <td data-bbox="660 367 788 400">Data</td> <td data-bbox="788 367 1107 400">TO_H: Set temp. out (high) [°F(°C)]</td> </tr> <tr> <td></td> <td data-bbox="660 400 788 501">-0015 to 0015</td> <td data-bbox="788 400 1107 501">"-0015": 5°F(-15°C) to "0015": 59°F(15°C) "0000": 32°F(0°C) (Factory default)</td> </tr> </table> <table border="1" data-bbox="549 530 1107 703"> <tr> <td data-bbox="549 530 660 564">DN [C7]</td> <td data-bbox="660 530 788 564">Data</td> <td data-bbox="788 530 1107 564">c : TO_H - TO_L [°F(°C)]</td> </tr> <tr> <td></td> <td data-bbox="660 564 788 598">0000</td> <td data-bbox="788 564 1107 598">Unavailable (Factory default)</td> </tr> <tr> <td></td> <td data-bbox="660 598 788 703">0001 to 0010</td> <td data-bbox="788 598 1107 703">0001: 1.8°F(1°C) to "0010": 18°F(10°C)</td> </tr> </table> <table border="1" data-bbox="549 732 1107 866"> <tr> <td data-bbox="549 732 660 766">DN [DB]</td> <td data-bbox="660 732 788 766">Data</td> <td data-bbox="788 732 1107 766">b : TA_H - TA_L [°F(°C)]</td> </tr> <tr> <td></td> <td data-bbox="660 766 788 866">0001 to 0010</td> <td data-bbox="788 766 1107 866">"0001": 0.9°F(0.5°C) to "0010": 9°F(5.0°C) "0006": 37.4°F(3°C) (Factory default)</td> </tr> </table> <table border="1" data-bbox="549 896 1107 1106"> <tr> <td data-bbox="549 896 660 929">DN [DC]</td> <td data-bbox="660 896 788 929">Data</td> <td data-bbox="788 896 1107 929">a : Ts - TA_H (Normal mode)[°F(°C)] TA_L - Ts (Flip mode)[°F(°C)]</td> </tr> <tr> <td></td> <td data-bbox="660 929 788 963">0000</td> <td data-bbox="788 929 1107 963">Unavailable (Factory default)</td> </tr> <tr> <td></td> <td data-bbox="660 963 788 1106">0001 to 0010</td> <td data-bbox="788 963 1107 1106">0001: 1.8°F(1°C) to "0010": 18°F(10°C)</td> </tr> </table> <p data-bbox="411 1128 517 1162"><Wiring></p> <p data-bbox="411 1162 1059 1218">1) Use ① - ④ pin (Cooling output, DC 12 V) of CN60 on indoor P.C. board for output.</p> <div data-bbox="411 1234 1107 1615"> <p data-bbox="592 1234 1107 1312">Relay (DC12V, procured locally) Corresponds to the relay up to one that the rated current of the operation coil is approx. 75mA</p>  <p data-bbox="411 1554 564 1615">Indoor control P.C. board</p> <p data-bbox="592 1532 1107 1615">Note) Determine the cable length between the indoor control P.C.board and the relay within 2m.</p> </div> <p data-bbox="411 1671 1107 1760">* The output state can be checked from "Monitor function" on the wired remote controller. The manual for the remote controller for operation methods of "Monitor function".</p> <table border="1" data-bbox="443 1771 1107 1906"> <tr> <td data-bbox="443 1771 592 1906">Monitor CODE No. E5</td> <td data-bbox="592 1771 1107 1906">Secondary heating output - - - : Unavailab 0000: OFF 0001: ON</td> </tr> </table>	DN [C5]	Data	Secondary heating mode		0000	Normal mode (Factory default)		0001	Flip mode	DN [C6]	Data	TO _H : Set temp. out (high) [°F(°C)]		-0015 to 0015	"-0015": 5°F(-15°C) to "0015": 59°F(15°C) "0000": 32°F(0°C) (Factory default)	DN [C7]	Data	c : TO _H - TO _L [°F(°C)]		0000	Unavailable (Factory default)		0001 to 0010	0001: 1.8°F(1°C) to "0010": 18°F(10°C)	DN [DB]	Data	b : TA _H - TA _L [°F(°C)]		0001 to 0010	"0001": 0.9°F(0.5°C) to "0010": 9°F(5.0°C) "0006": 37.4°F(3°C) (Factory default)	DN [DC]	Data	a : Ts - TA _H (Normal mode)[°F(°C)] TA _L - Ts (Flip mode)[°F(°C)]		0000	Unavailable (Factory default)		0001 to 0010	0001: 1.8°F(1°C) to "0010": 18°F(10°C)	Monitor CODE No. E5	Secondary heating output - - - : Unavailab 0000: OFF 0001: ON	
DN [C5]	Data	Secondary heating mode																																										
	0000	Normal mode (Factory default)																																										
	0001	Flip mode																																										
DN [C6]	Data	TO _H : Set temp. out (high) [°F(°C)]																																										
	-0015 to 0015	"-0015": 5°F(-15°C) to "0015": 59°F(15°C) "0000": 32°F(0°C) (Factory default)																																										
DN [C7]	Data	c : TO _H - TO _L [°F(°C)]																																										
	0000	Unavailable (Factory default)																																										
	0001 to 0010	0001: 1.8°F(1°C) to "0010": 18°F(10°C)																																										
DN [DB]	Data	b : TA _H - TA _L [°F(°C)]																																										
	0001 to 0010	"0001": 0.9°F(0.5°C) to "0010": 9°F(5.0°C) "0006": 37.4°F(3°C) (Factory default)																																										
DN [DC]	Data	a : Ts - TA _H (Normal mode)[°F(°C)] TA _L - Ts (Flip mode)[°F(°C)]																																										
	0000	Unavailable (Factory default)																																										
	0001 to 0010	0001: 1.8°F(1°C) to "0010": 18°F(10°C)																																										
Monitor CODE No. E5	Secondary heating output - - - : Unavailab 0000: OFF 0001: ON																																											

7. INPUT AND OUTPUT PORT

7-1. Dx-coil controller Print Circuit Board

■ MCC-1777

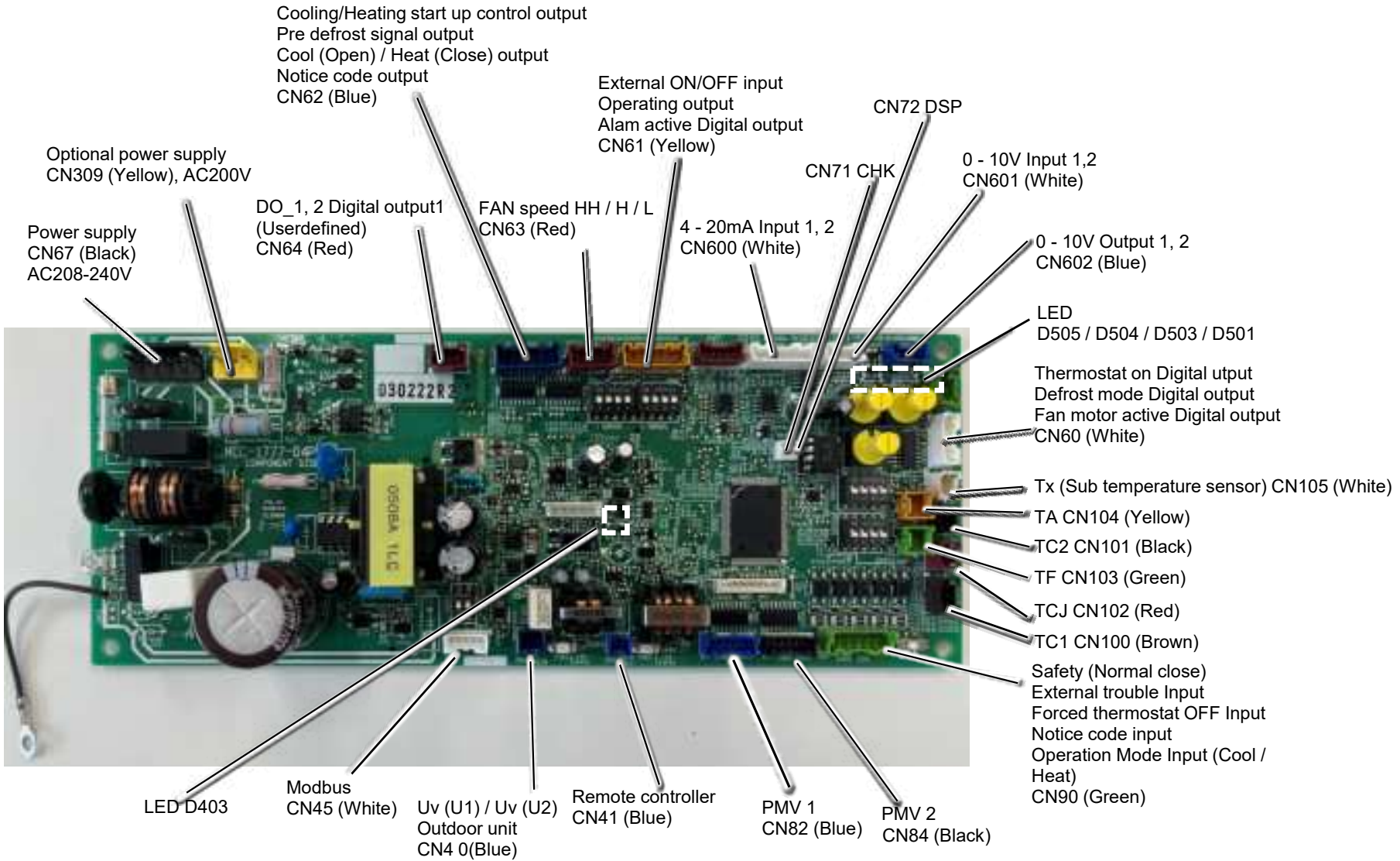

■ MCC-1777

Function	Connector No. CN	Connector color	Pin No.	Wire color	Specification
PMV 1	82	(BLU)	1	(WHI)	-
			2	(YEL)	-
			3	(ORN)	-
			4	(BLU)	-
			5	-	-
			6	(RED)	DC12V
PMV 2	84	(BLK)	1	(WHI)	-
			2	(YEL)	-
			3	(ORN)	-
			4	(BLU)	-
			5	-	-
			6	(RED)	DC12V
TC1	100	(BRN)	1	(BLU)	-
TCJ	102	(RED)	1	(RED)	-
			2		
TC2	101	(BLK)	1	(BLK)	-
			2		
TA	104	(YEL)	1	(BLK)	-
			2		
TF	103	(GRN)	1	(RED)	-
			2		
TX ^{*1}	105	(WHI)	1	-	-
			2		
Defrost mode Digital output	60	(WHI)	2	(BLU)	Output
Thermostat on Digital output	60	(WHI)	3	(ORN)	Output
	62	(BLU)	1	(RED)	12V
Fan motor active Digital output	60	(WHI)	6	(BLK)	Output
Output 1 (0-10V)	602	(BLU)	1	(BLU)	Output
			2	(BLK)	GND
Output 2 (0-10V) (No function)	602	(BLU)	3	(BLU)	Output
			4	(BLK)	GND
Input 1 (0-10V)	601	(WHI)	1	(WHI)	Input
			2	(BLK)	GND
Input 2 (0-10V) (No function)	601	(WHI)	3	(WHI)	Input
			4	(BLK)	GND
Input 1 (4-20mA)	600	(WHI)	3	(BLU)	Input
			4	(BLK)	GND
Input1(4-20mA) (No function)	600	(WHI)	5	(YEL)	Input
			6	(BLK)	GND
External ON/OFF input	61	(YEL)	1	(BLU)	5V
			2	(BLK)	GND
Operating output	61	(YEL)	4	(WHI)	Output
			5	(RED)	12V
Alarm active Digital output	61	(YEL)	6	(BRN)	Output
FAN speed HH	63	(RED)	2	(YEL)	Output
FAN speed H	63	(RED)	3	(GRN)	Output
FAN speed L	63	(RED)	4	(BLU)	Output
Cooling oil recovery / Heating refrigerant recovery control	62	(BLU)	3	(WHI)	Output
Pre defrost signal output	62	(BLU)	4	(BRN)	Output
Cool (open) / Heat (close) output	62	(BLU)	5	(BLU)	Output
Notice output	62	(BLU)	6	(GRN)	Output
Ventilation Fan output	62	(BLU)	1	(YEL)	Output
	63	(RED)	1	(RED)	12 V
Safety (Normal close)	90	(GRN)	1	(RED)	GND ^{*2}
			2	(WHI)	Input
External trouble input	90	(GRN)	3	(BLU)	Input
Forced thermostat OFF Input	90	(GRN)	4	(ORN)	Input
Notice Input	90	(GRN)	5	(GRN)	Input
Operation Mode Input (Cool / Heat)	90	(GRN)	6	(YEL)	Input
Modbus A	45	(WHI)	5	(YEL)	-
Modbus B	45	(WHI)	4	(ORN)	-
Digital output 1 (user defined)	64	(RED)	2	(RED)	Output
Digital output 2 (user defined)	64	(RED)	3	(WHI)	Output

*1 : The TX sensor can be used by connecting an Optional sensor (for Ta or TF) (sold separately).

*2 : For safety, the output will change depending on the combination with SW701. Refer to the Terminal DI1 / * DI1 page for details.

LED position and details

P.C. board LED		Meaning of lighting
D501 (Red)	MCU power supply	Lights when the power is turned on
D503 (Yellow)	Communication line (Uv(U1), Uv(U2)) (Main bus communication)	Flashes every 5 seconds. With central control: lighting and flashing every 5 seconds.
D504 (Green)	Remote controller wiring (A, B) (Sup bus communication)	Flashes every 5 seconds. Group: lighting and flashing every 5 seconds.
D505 (Orange)	Mod bus communication	When connected to Modbus, it lights up every 5 seconds.
D403 (Red)	Sub bus power supply (Remote controller wiring (A, B))	Sub bus Lights while power is being supplied.

■ Interface P.C.board function setting exchange table

When operating the SW, turn off the power before setting.

SW	Bit	Function Name	OFF (Default)	ON	Detail															
SW501	1	Model type	VRF	LC	VRF : Bit1 OFF (Default) LC : Bit1 ON															
	2	TA / TF type switching	TA type	TF type	The default is TA type. For TF type, turn on Bit2. If Bit3 is ON, the Bit2 setting is invalid.															
	3	DDC type switching	No function	DDC type	For DDC type, turn on Bit3.															
	4	DDC capacity control	Stepped	Linear	Change the capacity control method at 0 - 10 V. Refer to the functions of AI3.															
SW502	1	No function	-	-	-															
	2																			
	3																			
	4	Forced capacity control	None	Controlled	Refer to the functions of DI2 / *DI2 ~ *DI4 / DI4.															
SW503	-	Output signal selection (RSW)	-	-	Refer to the functions of DO5 / *DO5 and DO6 / *DO6.															
SW504	-		-	-																
SW505	1	DI1 input inversion	Close	Open	Refer to the functions of DI1.															
	2	No function	-	-	-															
	3																			
	4																			
SW506	1	Modbus baud rate	Refer to right table		<table border="1"> <thead> <tr> <th>Bit1</th> <th>Bit2</th> <th>Baud rate</th> </tr> </thead> <tbody> <tr> <td>OFF</td> <td>OFF</td> <td>9600</td> </tr> <tr> <td>ON</td> <td>OFF</td> <td>19200</td> </tr> <tr> <td>OFF</td> <td>ON</td> <td>38400</td> </tr> <tr> <td>ON</td> <td>ON</td> <td>57600</td> </tr> </tbody> </table>	Bit1	Bit2	Baud rate	OFF	OFF	9600	ON	OFF	19200	OFF	ON	38400	ON	ON	57600
	Bit1				Bit2	Baud rate														
	OFF	OFF	9600																	
	ON	OFF	19200																	
	OFF	ON	38400																	
ON	ON	57600																		
2																				
3	No function	-	-	-																
4	No function	-	-	-																
SW507	1	Modbus address setting (RSW)	-	-	Refer to "Modbus setting method" in this Installation Manual.															
SW701	1	Voltage / non-voltage switching SW	Voltage	Non-voltage	Refer to the functions of DI1 / *DI1.															
SW801	1	RS-485 terminating resistance setting	Open	120 ohm	Refer to "Modbus setting method" in this Installation Manual.															
	2	No function	-	-	-															

7-2. Test run

Before test run

- Before turning on the power supply, carry out the following procedure.
 1. By using an insulation tester (500 VMΩ), check that resistance of 1 MΩ or more exists between the terminal block L to N and the earth (grounding). If resistance of less than 1 MΩ is detected, do not run the unit.
 2. Check the valve of the outdoor unit being opened fully.
 - To protect the compressor at activation time, leave power-ON for 12 hours or more before operating.
 - Do not press the electromagnetic contactor to forcibly perform a test run. (This is very dangerous because the protective device does not work.)

CAUTION

Be careful of the long - time forced operation because it may result in break.
Perform the test run check with cooling/heating, and check that it is satisfactory with the whole system.

Terminal	Function	Description	
DO1	Operating output	Digital output	DC12 V
DO2	Alarm active digital output	Digital output	DC12 V
DO3	Fan motor active digital output	Digital output	DC12 V
DO4	Defrost mode digital output	Digital output	DC12 V
DO5	DO1 Digital output 1 (User defined)	Digital output	DC12 V
DO6	DO2 Digital output 2 (User defined)	Digital output	DC12 V
DO7	Thermostat ON digital output	Digital output	DC12 V
DO8	Cooling / heating start up control signal output	Digital output	DC12 V
DO9	Pre defrost signal output	Digital output	DC12 V
DOA	Cooling OPEN / heating CLOSE output	Digital output	DC12 V
DOB	Notice code output	Digital output	DC12 V
DOC	Fan high speed output	Digital output	DC12 V
DOD	Fan medium speed output	Digital output	DC12 V
DOE	Fan low speed output	Digital output	DC12 V
N1	Ventilation Fan output	Digital output	DC12 V
N2	Blank	none	-
DI1	Safety (Normal close)	Digital input	DC12 V or Dry contact
DI2	External trouble input	Digital input	DC12 V or Dry contact
DI3	Forced thermostat OFF input	Digital input	DC12 V or Dry contact
DI4	Notice code input	Digital input	DC12 V or Dry contact
DI5	Operation mode input (cool / heat)	Digital input	DC12 V or Dry contact
DI6	External ON / OFF input	Digital input	Dry contact ^(*)
AI1	Input 1 (4-20 mA)	Analog input	4 - 20 mA
AI2	Input 2 (4-20 mA)	Analog input	4 - 20 mA
AI3	Input 1 (0-10 V)	Analog input	0 - 10 V
AI4	Input 2 (0-10 V)	Analog input	0 - 10 V
AO1	Output 1 (0-10 V)	Analog output	0 - 10 V
AO2	Output 2 (0-10 V)	Analog output	0 - 10 V
R, BL, OR, Y, W	PMV 1 / PMV 2	-	R: DC12 V
MdG	Modbus G	-	-
MdA / MdB	Modbus A / Modbus B	-	-
AB	Remote Controller	-	-
Uv	Mainbus	-	-

*1: DC5V is applied to the DI6 terminal.

Terminal L(1) / N(2) / (3): Power Supply Input

- Dx-coil controller should be connected to the main power supply by means of a switch with a contact separation of at least 3 mm. If the outdoor unit is a VRF model (SMMS or SHRM series), connect it to L(1) / N(2).

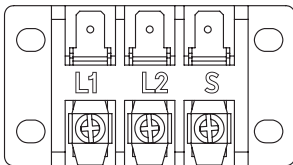

Terminal Uv(U1) / *Uv(U2): Communication line (Dx-coil controller and outdoor units)

- Details regarding the wiring can be found in the installation manual of the VRF outdoor unit.

Terminal AB / *AB: Remote controller Wiring

- At these terminals an optional wired remote controller can be attached. (Useful for installation, maintenance and Group control)

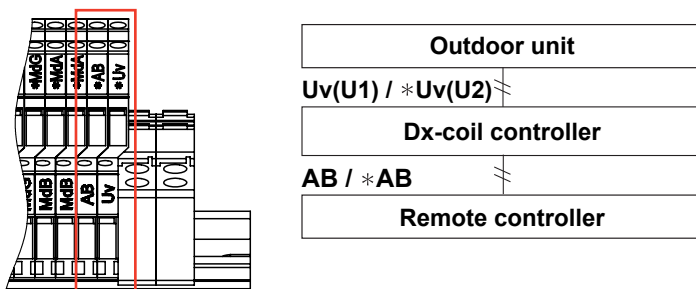

■ The specifications of Terminal DO1 to DO6

The specifications of Terminal DO1 to DO6 are as follows.

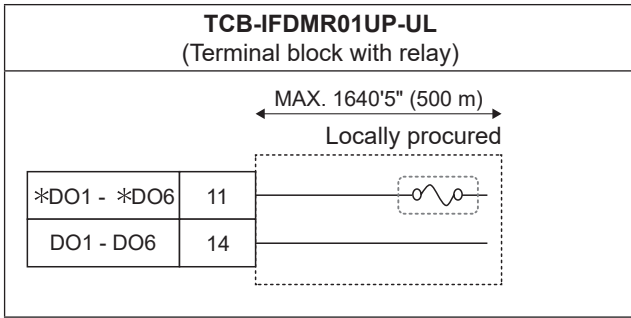

- Use the contact side of the relay terminal used in TCB-IFDMR01UP-UL according to the specifications shown in the table below.

Relay model name	Contact rating	Load conditions
G2RV-SR700-12DC	250 V max / 3 A max (Minimum Current: 10 mA more)	Resistive load

■ Function of each terminal blocks

Terminal DO1 / *DO1: Operating Output (DC12 V)

- The output is displayed when the system starts operation (output when the thermostat is on / off).

Terminal DO2 / *DO2: Alarm Active Digital Output (DC12 V)

- During Alarm operation, Alarm Active Digital Output is active.

Terminal DO3 / *DO3: Fan Motor Active Digital Output (DC12 V)

- A fan control signal is output. It is usually the ON output at the time of operating, but it is the OFF output in defrosting.

Terminal DO4 / *DO4: Defrost Mode Digital Output (DC12 V)

- During Defrost operation, Defrost Mode Output is active.

Terminal DO5 / *DO5: Digital Output 1 (DC12 V)

DO6 / *DO6: Digital Output 2 (DC12 V)

- Output function selected using rotary switches SW503 (DO5 / *DO5) & SW504 (DO6 / *DO6).

SW503, 504 Position	Output Function
1	Outdoor unit(s) operation level is lower than capacity command
2	Outdoor unit(s) operation level is higher than capacity command
3	Cooling oil recovery / Heating refrigerant recovery control
4	Cooling operation output or Secondary heating output*
5	Heating operation output
6	The suction air temperature (TA) is in the thermostat OFF range (only TF type)
7 - 15	Do not use
16	Under restriction of compressor speed due to heat sink overheating in outdoor unit (s)

Set with the SW503 or SW504 switch on the control P.C. board MCC-1777.

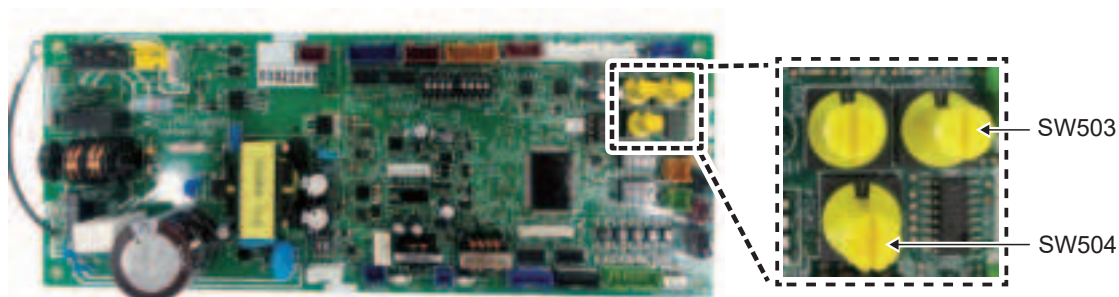

Terminal DO7 / *DO7: Thermostat on Digital output (DC12 V)

- When the thermostat of Dx-coil is ON, a signal comes out.

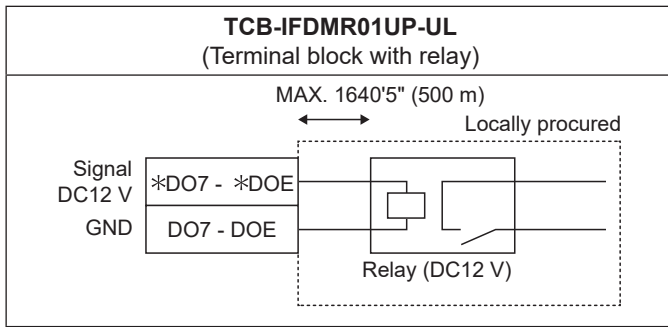

Terminal DO8 / *DO8: Cooling / heating start up control signal output

- Outputs the start control signal for cooling and heating operation.

Terminal DO9 / *DO9: Pre defrost signal

- Output just before defrosting (at least 5 minutes before).

Terminal DOA / *DOA: Cool open heat close output

- Heating mode is close, Cooling mode is open.

Terminal DOB / *DOB: Notice code output

- Issued when Notice code is output. For details, see the outdoor unit Service Manual.

Terminal DOC / *DOC, DOD / *DOD, DOE / *DOE: FAN speed output

- If select the fan output from interface, use this output. For TA and TF types, the output changes by changing the fan speed from the remote controller.
DOC = High / DOD = Mid. / DOE = Low

Terminal N1 / *N1: Ventilation fan output

- The signal operation setting by FAN button on remote controller is performed on the remote controller (DN = 31)

Terminal N2 / *N2: Nothing

The specifications of Terminal DI1 to DI5 are as follows.

- You can switch between voltage and non-voltage with SW701.

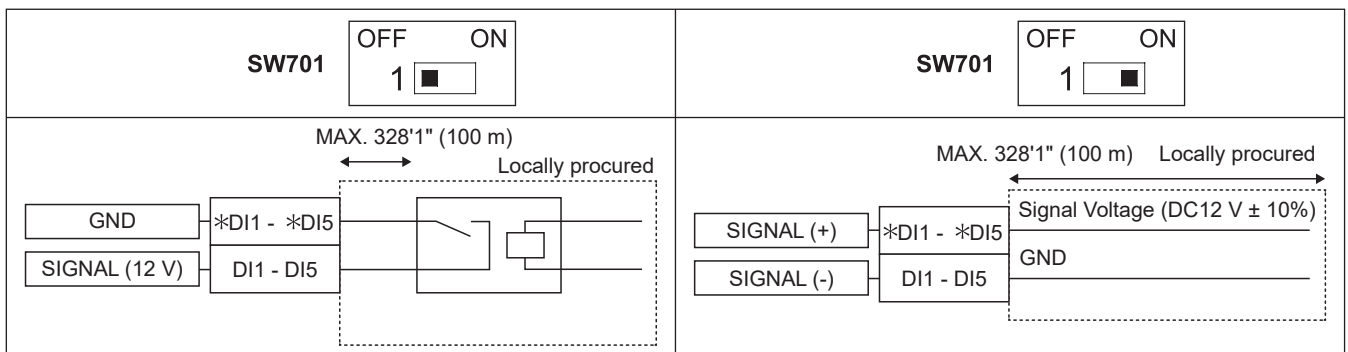
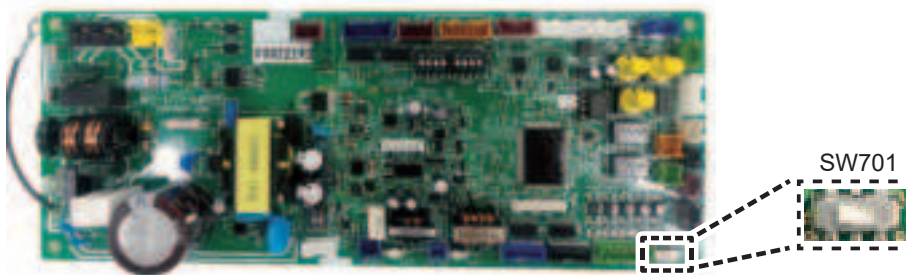

Terminal DI1 / *DI1: Safety contact (Normal close)

MODE 1 (Normally close, DC12 V) *When Bit1 of SW505 is OFF

- If this contact is open for more than 1 minute, the check code P10 is generated and the Dx-coil controller switches off automatically.

MODE 2 (Normally open, DC12 V) *When Bit1 of SW505 is ON

- If this contact is short for more than 1 minute, the check code P10 is generated and the Dx-coil controller switches off automatically.

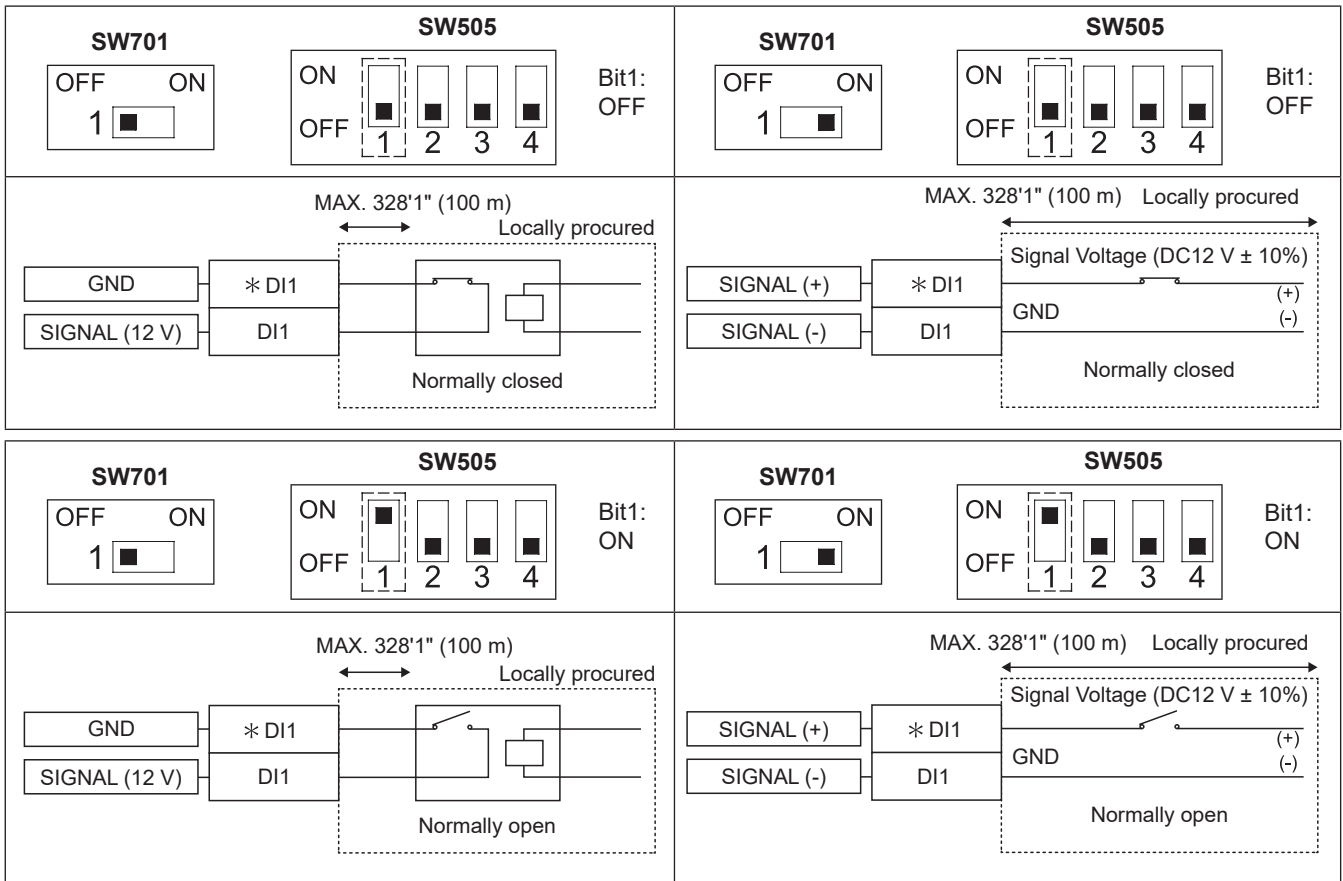
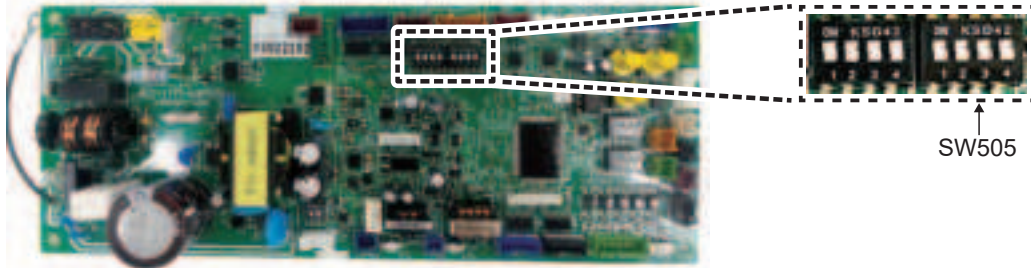

SW701	SW505	Function
OFF	OFF	The coil drive voltage is input to the relay arranged locally for DI1, and judge that the close is positive. (Default) Relay: Local arrangement
	ON	The coil drive voltage is not input to the relay arranged locally for DI1, and judge that the open is positive. Relay: Local arrangement
ON	OFF	For *DI1, short-circuit the (+) signal voltage and DI1 (-) GND with a SW or harness, and judge that the close is positive. Relay: Not required * The signal voltage is DC12 V ± 10%, and it is necessary to add a SW element to the signal line.
	ON	For *DI1, open the (+) signal voltage and DI1 (-) GND, and judge that the open is positive. Relay: Not required * The signal voltage is DC12 V ± 10%, and it is necessary to add a SW element to the signal line.

Terminal DI2 / *DI2: External trouble Input

- An AHU fan operation monitor (Field supply), could be attached at this dry contact terminal (For example, the abnormality of the fan motor). A closed contact generates the check code L30.

Terminal DI3 / *DI3: Forced thermostat OFF Input

- When signal input, AHU is in “thermostat-off” status forcibly.

Terminal DI4 / *DI4: Notice code Input

- If there is input, a spanner mark will be displayed on the remote controller. The system will not stop. Check “DN settings” for the setting method.

Terminal DI5 / *DI5: Operation Mode Input (Cool / Heat)

- Cool / Heat mode selection over a dry contact.
- If the contact is short-circuited, system changes to heat mode. If the contact is open, system changes to cool mode.
- Only cool mode and heat mode are available.

Function	Terminal	OPEN	SHORT
Mode Input Cool / Heat	DI5 / *DI5	COOL mode active	HEAT mode active

When Bit4 of SW502 is turned on in DDC type, capacity demand can be achieved by short-circuiting Terminals DI2 to DI4.

Short - circuit	Cooling step	Heating step
*DI2 - DI2	2	4
*DI3 - DI3	5	9
*DI4 - DI4	11	13

* If all are short-circuited, the DI3 function has priority.

When SW701 is ON (no voltage), apply a voltage of DC12 V ± 10% and wiring as follows.

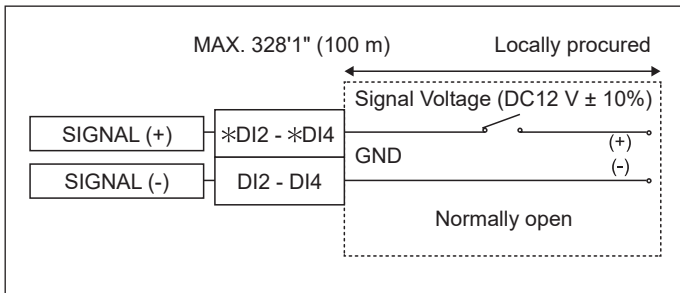

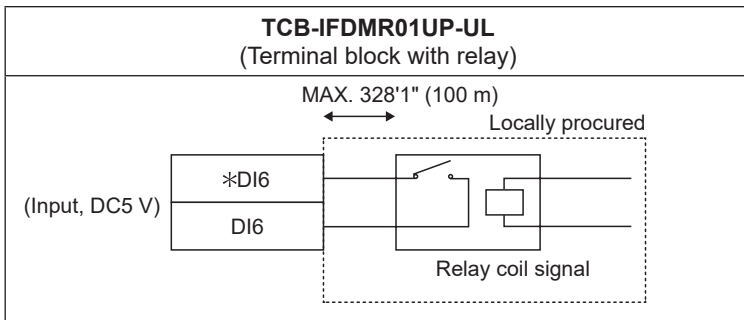

Terminal DI6 / *DI6: External ON/OFF Input

- When using with DDC, it starts by turning on this terminal

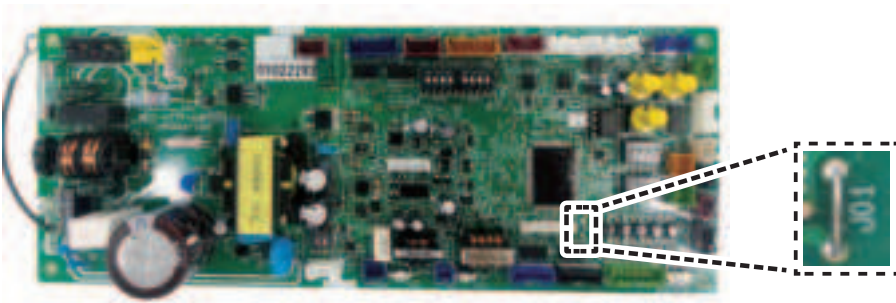

The position of J01 (MCC-1777)

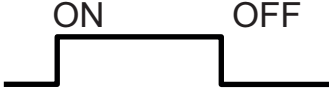

J01	Action
Connect	Pulse input (At factory setting)  Pulse width 200 to 300 ms Pulse interval 200 to 300 ms or more.
Cut	Static input 

Terminal AI1 / *AI1: 4 - 20 mA FAN interlocking control by external input

- FAN mode is switched by external 4 - 20 mA input.
- Both FAN control with 4 - 20 mA input and FAN mode change with remote controller are valid, but boost priority is given.
- The FAN priority control is switched by the DN setting of [4A0].
 0000: Default (no change in FAN mode by 4 - 20 mA input)
 0001: FAN control by 4 - 20 mA input, but priority is given to FAN control from the outdoor unit
 0002: FAN control 4 - 20 mA input with priority
- The FAN mode switching threshold value for 4 - 20 mA input can be changed in the DN setting (See the table as below).
- * Terminal AI2 / *AI2 cannot be used.
- * The change in FAN speed with 4 - 20 mA input is also reflected in the 0 - 10 V output of AO1 / *AO1.

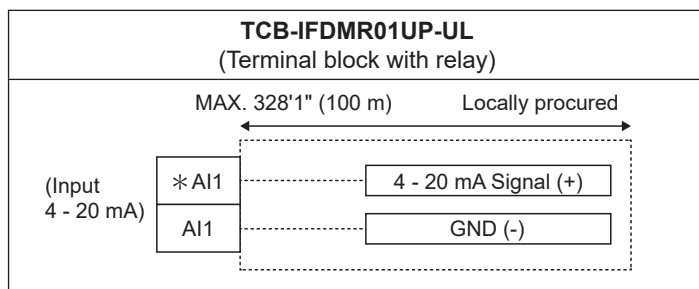
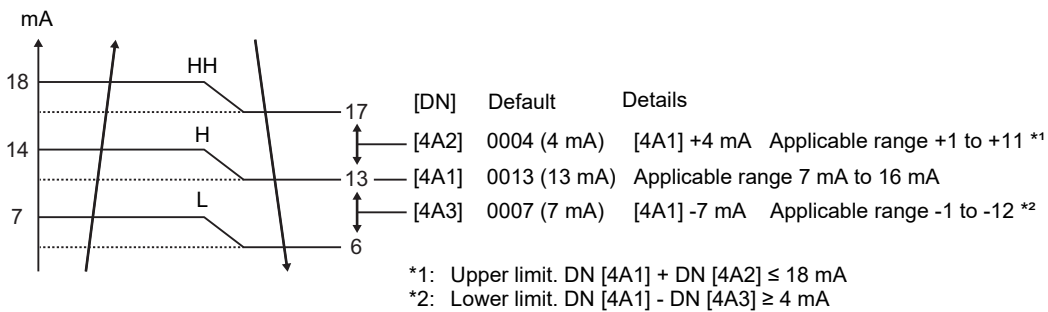

Terminal AI3 / *AI3: Analogue Input Capacity control

- Be sure not input more than DC10 V in analogue input terminal.
- To ease the integration of the DX COIL with the DDC the capacity control is able to operate with a STEPPED or LINEAR function from the analogue input.
- To select either a STEPPED (default) or LINEAR response, from the analogue input, use SW501 Bit4.
- Terminal AI4 / *AI4 cannot be used.

SW501 Bit4	Function
OFF	STEP response to analogue input
ON	LINEAR response to analogue input

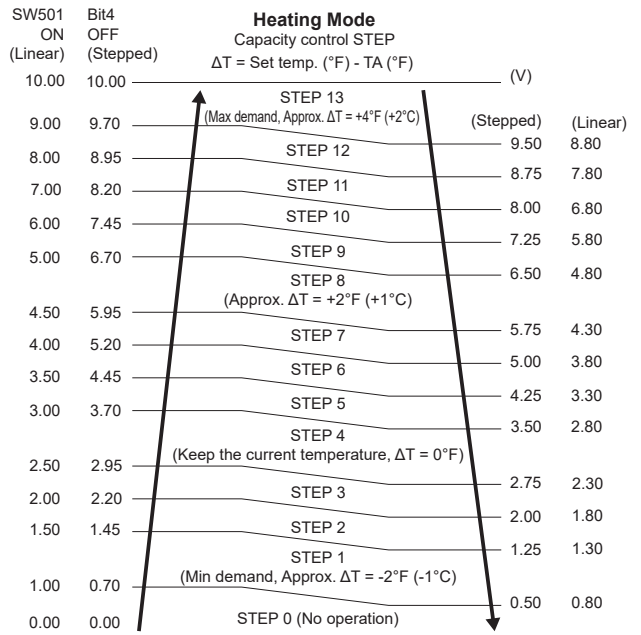
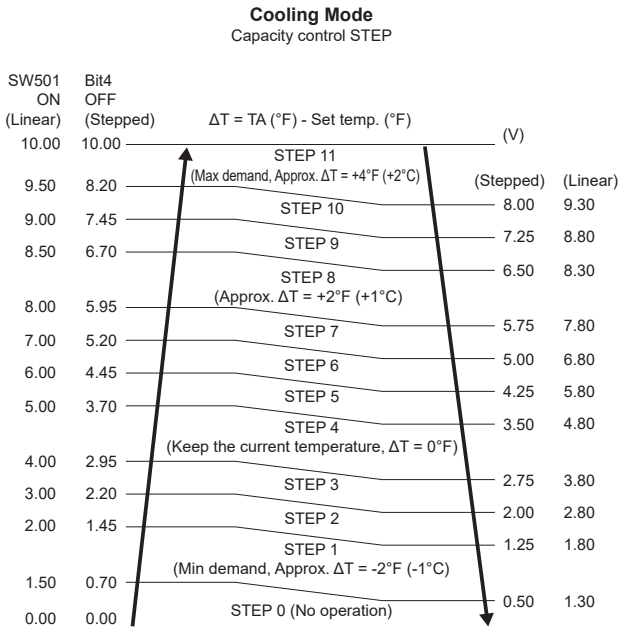
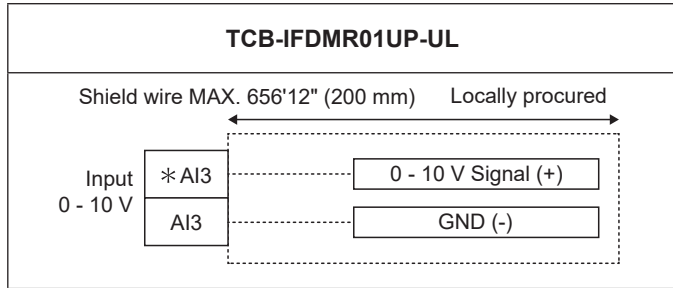

- For TA and TF type, the set temperature can be changed according to the 0 - 10 V input of AI3.
- In the set temperature with the remote controller and this control, the post-setting is prioritized.
- The set temperature can be changed only for cooling and heating operations.
- To use this control, set DN [4A9] = 1.

▼ TA type

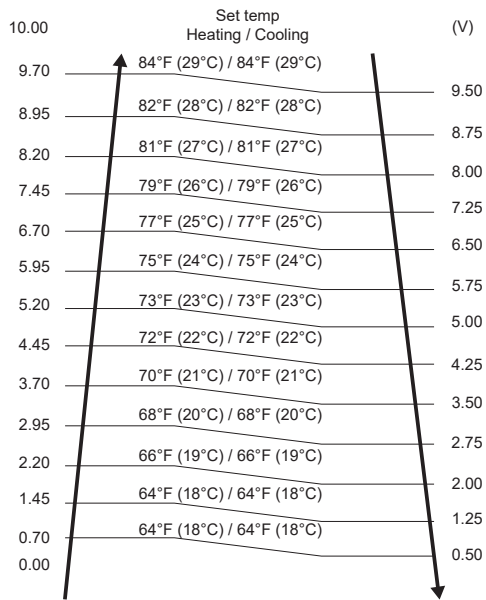

▼ TF type

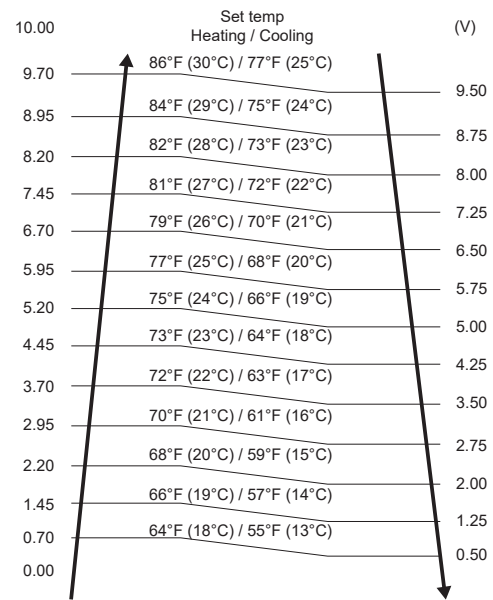

Terminal AO1 / *AO1: FAN speed 0 - 10 V output

- Each FAN speed is output at 0 - 10 V.
- The ripple voltage of 0 - 10 V is less than ± 30 mV of the set voltage. Connect equipment that is not affected by this ripple voltage.
- The output voltage can be changed by DN setting [4A4] to [4A6].
- * Terminal AO2 / *AO2 cannot be used.

FAN speed	Output (Def)	Initial (Def)	Applicable range
HH	9 V	4A4 (0009)	8 V (0008) - 10 V (0010)
H	6 V	4A5 (0006)	4 V (0004) - 7 V (0007)
L	2 V	4A6 (0002)	1 V (0001) - 3 V (0003)
STOP	0 V	-	-

CAUTION

The impedance of the device that receives the 0 - 10 V output signal shall be 10 kΩ or more.

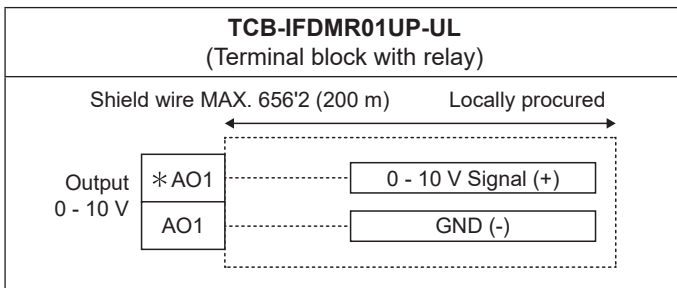

Terminal: R / BL / OR / Y / W

Dx-valve kit 1, Dx-valve kit 2 : Connect the cable from the PMV.
Match the color of the wiring of the PMV side and the controller side.

Color identification	
W:	White
Y:	Yellow
OR:	Orange
BL:	Blue
R:	Red

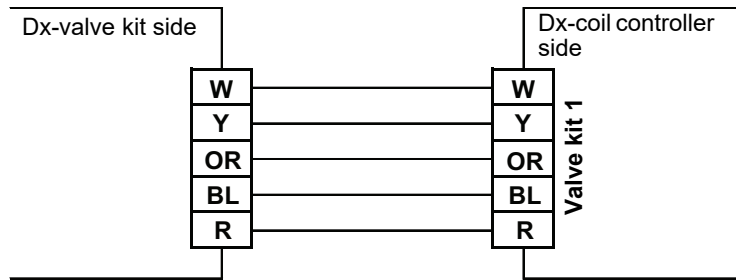

RBM-A0601UPVA-UL	0.6, 0.75, 1.0, 1.25, 1.5, 2.0, 2.25, 2.5, 3.0, 4.0, 4.5, 5.0 Ton
RBM-A1201UPVA-UL	6, 8, 10 Ton
RBM-A1921UPVA-UL	12, 14, 16 Ton

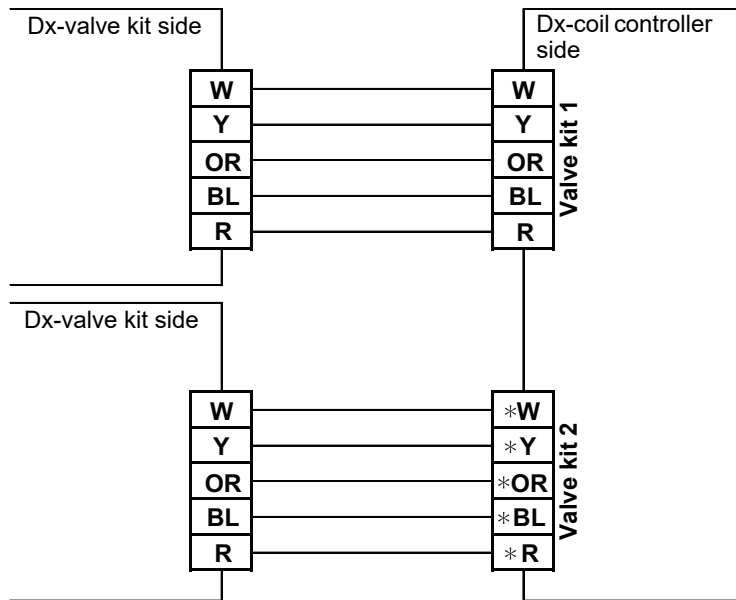

RBM-A1201UPVA-UL	20 Ton (10 Ton × 2)
RBM-A1921UPVA-UL	24 Ton (12 Ton × 2), 28 Ton (14 Ton × 2), 32 Ton (16 Ton × 2)

- For the PMV, sensor wiring, do not bundle it with the motor wiring. The wrong operation may result in.
- The PMV cable cannot be extended, it is supplied at the maximum permissible length of 16'5" (5 m).
- The PMV wiring can be extend up to 41ft with AWG18 wiring size.

■ Modbus setting method

Modbus communication is available on this model. Follow the procedure below to set.

CAUTION

Use insulation type for Modbus devices to be connected.
If it is not an insulation type, it may affect the device due to noise, etc.

1. Wiring method

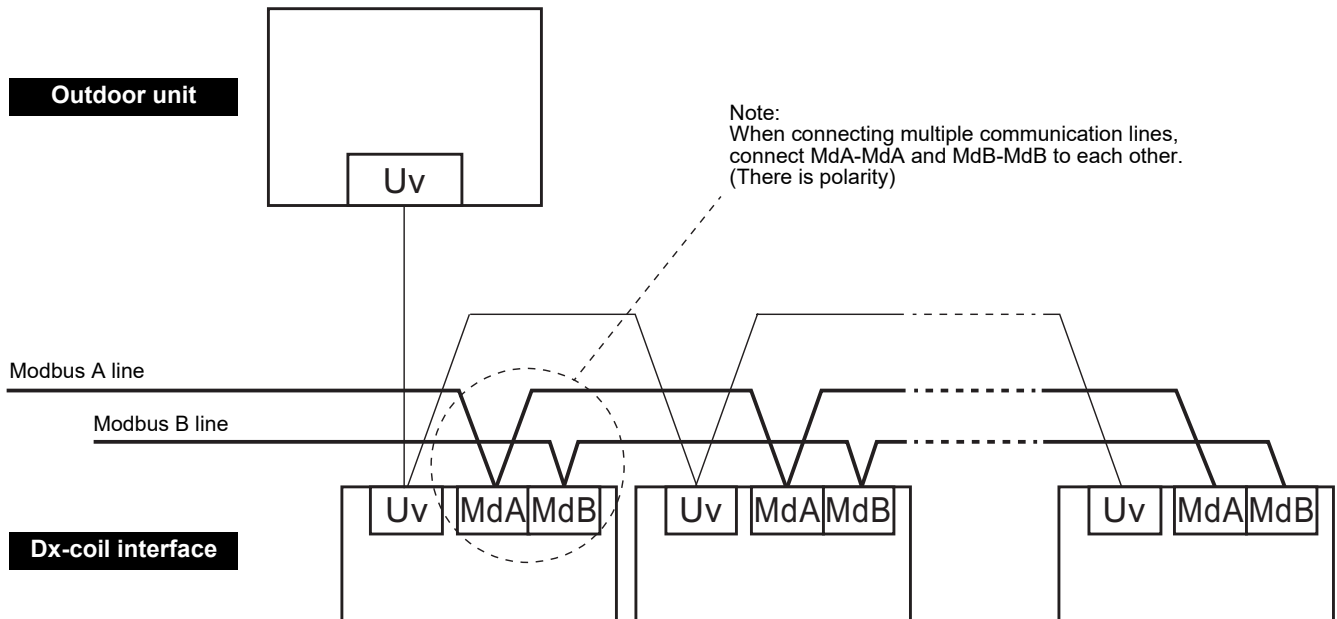

Baud Rate *1	SW506	Bit1: ON / Bit2: OFF (19200)	Bit1: ON / Bit2: OFF (19200)	...	Bit1: ON / Bit2: OFF (19200)
Address *2	SW507	1	2	...	16 (Up to 16)
Termination resistor *3	SW801	Bit1: ON	Bit1: OFF	...	Bit1: OFF

*1: Set the baud rate according to the communication device.

*2: Up to 16 addresses can be set with the rotary switch.

*3: Set the terminating resistor only for the unit with the latest address.

CAUTION

- RS-485 terminator resistor select switch SW801 (Bit1).
- For SW801 Bit1 (120 ohm), set only the Dx-interface with the latest address, and turn off Bit1 for other Dx-interfaces.

2. Function codes

Function code	Sub function code	Function name
0×03	None	Read holding register
0×04	None	Read Input register
0×06	None	White single holding register
0×08	0×00, 01, 02, 04, 0A, 0B, 0C, 0D, 0E, 0F, 11, 12, 14	Diagnostics
0×0B	None	Get Comm. Event Counter
0×0C	None	Get Comm. Event Log
0×10	None	Write multiple holding registers

3. Address assignment table

Register	address	Read / Write	Data	Byte
Holding Register	40001	R / W	Operation / stop setting	2
	40002		Operation mode setting	2
	40003		Set temperature setting	2
	40004		Automatic cooling set temperature (Dual set point) setting	2
	40005		Automatic heating set temperature (Dual set point) setting	2
	40006		Fan speed setting	2
	40007		Operation prohibition setting	2
	40008		Analogue Input Capacity Control	2
	40009 ~ 40019		Reserved	
	40020		CN90 D11 (Safety contact input)	2
	40021		CN90 D12 (External trouble input)	2
	40022		CN90 D13 (Forced Thermo OFF input)	2
	40023		CN90 D14 (Notice input)	2

Register	address	Read / Write	Data	Byte
Input Register	30001	R	Operation / stop setting	2
	30002		Operation mode setting	2
	30003		Set temperature setting	2
	30004		Automatic cooling set temperature (Dual set point) setting	2
	30005		Automatic heating set temperature (Dual set point) setting	2
	30006		Fan speed setting	2
	30007		Operation prohibition setting	2
	30008		Analogue Input Capacity Control	2
	30009 ~ 30019		Reserved	
	30020		CN90 D11 (Safety contact input)	2
	30021		CN90 D12 (External trouble input)	2
	30022		CN90 D13 (Forced Thermo OFF input)	2
	30023		CN90 D14 (Notice input)	2
	30024 ~ 30039		Reserved	
	30040		TC1	2
	30041		TC2	2
	30042		TCJ	2
	30043		TA	2
	30044		TF	2
	30045		Tx (Auxiliary temperature sensor)	2
	30046		TO	2
	30047 ~ 30059		Reserved	
	30060		Alarm Code	2
	30061		Notice code 1	2
	30062		Notice code 2	2
	30063		Notice code 3	2
	30064		Notice code 4	2
	30065		Notice code 5	2
	30066		Thermostat On Digital Output	2
	30067		Cooling operation signal output / secondary heating signal output	2
	30068		Heating operation signal output	2
	30069		Fan Motor Digital Output	2
	30070		Operating output	2
	30071		Outdoor unit(s) operation level is lower than capacity command	2
30072	Outdoor unit(s) operation level is higher than capacity command	2		

Register	address	Read / Write	Data	Byte
Input Register	30073 ~ 30078	R	Reserved	
	30079		Under restriction of compressor speed due to heat sink overheating in outdoor unit(s)	2
	30080		Cooling / heating start control output	2
	30081		Defrost Mode Digital Output	2
	30082		Pre defrost signal output	2
	30083		Cooling oil recovery / Heating ref recovery	2
	30084 ~ 30099		Reserved	
	30100		Product type setting	2
	30101		Control type	2
	30102		Operation mode range	2
	30103		Fan speed range	2
	30104		Cooling upper limit set temperature	2
	30105		Cooling lower limit set temperature	2
	30106		Heating upper limit set temperature	2
	30107		Heating lower limit set temperature	2
	30108		Dry upper limit set temperature	2
	30109		Dry lower limit set temperature	2
	30110		Automatic mode upper limit set temperature	2
	30111		Automatic mode lower limit set temperature	2
	30112		Dual Set point Function Status	2
	30113		Setting capacity	2
	30114		Modbus band rate SW state	2
	30115		Modbus Slave Address SW state	2
	30116 ~ 30199		Reserved	
	30200		Model name	16
	30201		Model name	
	30202		Model name	
	30203		Model name	
	30204		Model name	
	30205		Model name	
	30206		Model name	
	30207		Model name	
	30208 ~ 30249		Reserved	
	30250		Serial number	16
	30251		Serial number	
	30252		Serial number	
	30253		Serial number	
	30254		Serial number	
	30255		Serial number	
	30256		Serial number	
	30257		Serial number	
	30258 ~ 30299		Reserved	
	30300		Firmware Definition (Firmware control number)	4
	30301		Firmware Definition (Firmware control number)	
	30302		Software Version	2

7-4. Method to set the AHU function DN code

(When performing this task, be sure to use a wired remote controller.)

■ DN setting

Remote controller model name: RBC-AWSUS*-UL

Basic procedure

Be sure to stop the air conditioner before making settings.

(Change the setup while the air conditioner is not working.)

CAUTION

Set only the Code No. shown in the following table: Do NOT set any other Code No.

If a Code No. not listed is set, it may not be possible to operate the air conditioner or other trouble with the product may result.



1 In the “Field setting menu” screen, press [] and [] to select “DN setting”, and then press [ Set/Fix]

2 Press [] and [] to select “Indoor unit” or “Outdoor unit”, and the press [ Set/ Fix]

→If “Indoor unit” was selected, the fans and louvers of the indoor units operate.

When doing group connections:

→The fans and louvers of the selected indoor units operate.

3 Press [] to black highlight the item code (DN), and then press [] and [] to set the item code

4 Press [] to black highlight the data, and then press [] and [] to set the data

5 After finishing setting the data of the item code (DN), press [ Set/Fix]



→“Continue?” is displayed.

6 To set the data of other item codes (DN), press [ Set/Fix] To not do other settings, press [ Return]

→The changes are fixed, and the “Field setting menu” screen returns.

→“⌚” appears while data is changing.

When doing group connections:

→Press [ Return] to open the unit selection screen. In the unit selection screen, press [ Return] to briefly display “⌚”, and then return to the “Field setting menu” screen.

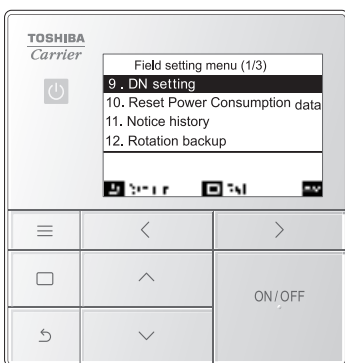

NOTE

The following changes are settings to be configured by installation and service personnel. If they are set incorrectly, trouble such as the product becoming inoperable may occur.

Set the following DN code according to the Ton of the Dx-coil interface and the model name of the Valve kit.

1. Dx-coil interface Ton

Dx-coil capacity	0.6 Ton*	0.8 Ton*	1 Ton	1.25 Ton	1.5 Ton	2 Ton	2.25 Ton
Capacity code (DN11)	0001	0003	0005	0007	0009	0011	0012

Dx-coil capacity	2.5 Ton	3 Ton	4 Ton	4.5 Ton	5 Ton
Capacity code (DN11)	0013	0015	0017	0018	0019

Dx-coil capacity	6 Ton	8 Ton	10 Ton*	12 Ton*	14 Ton	16 Ton
Capacity code (DN11)	0021	0023	0024	0026	0027	0028

Dx-coil capacity	20 Ton*	24 Ton*	28 Ton	32 Ton
Capacity code (DN11)	0031	0035	0037	0039

* Only outdoor units that support TU2C-LINK can be set.

2. valve kit type name specification (This is basically set automatically).

Valve kit model	RBM-A0601UPVA-UL	RBM-A1201UPVA-UL	RBM-A1921UPVA-UL
Code (DN) 4AE	0003	0001	0002

Notice code signal setting (Terminal DI4 / *DI4: Notice code Input)

Notice code is a function dedicated to TU2C-Link communication.

[Function]

- Enter the Notice code when you want to report an abnormality that does not stop the air conditioner from the outside
- Used by switching functions with settings of Code No. (DN Code).
- Notice code is continuously issued while input signal is ON
- 201 is displayed in the Notice code history when there is input in DI4

[Setup method]

* Set data corresponding to Notice code to be used to one of Code No. 180 to 189, in accordance with following table
In case where data other than 0000 is already set, set to other Code No. (DN Code).

Code No. (DN)	Set data	Notice code display
0180 ~ 189	0000	None (Factory default)
	0129	201 (DI4 / *DI4 Notice input ON)
	0134	206 (Tx sensor*1 trouble)

* 1: Refer to the Service Manual for support

* It may take up to ten minutes to be displayed on remote controller after Notice code is issued

Function CODE No. (DN Code) table (includes all functions needed to perform applied control on site)

DN	Item	Setting allowed			Description	At shipment
		TA	TF	DDC		
01	Filter display delay timer	Yes	Yes	Yes	0000: None 0001: 150H 0002: 2500H 0003: 5000H 0004: 10000H	0000: None
02	Dirty state of filter	Yes	Yes	Yes	0000: Standard 0001: High degree of dirt (Half of standard time)	0000: Standard
03	Central control address	Yes	Yes	Yes	0001: No.1 unit to 0064: No.64 unit ... TCC-LINK 0001: No.1 unit to 0128: No.128 unit ... TU2C-LINK 00Un: Unfixed (When using U series remote controller) 0099: Unfixed (Other than U series remote controller)	00Un/0099: Unfixed *1
04	Specific indoor unit priority	Yes	No	No	0000: No priority 0001: Priority	0000: No priority
0D	Existence of [AUTO] mode	Yes	Yes	No	0000: Provided 0001: Not provided 0001: Not provided (Automatic selection from connected outdoor unit)	0001: Not provided
10	Type	Yes	Yes	Yes	It will switch automatically depending on the SW501bit1,2 setting.	TAtype:0057 TFtype:0058 DDCtype:0059
11	Indoor unit capacity	Yes	Yes	Yes	0000: Unfixed 0001 to 0044 Refer to Indoor Unit Capacity DN code "11" list	0000: Unfixed
12	Line address	Yes	Yes	Yes	0001: No.1 unit to 0030: No.30 unit ... TCC-LINK 0001: No.1 unit to 0128: No.128 unit ... TU2C-LINK 00Un: Unfixed (When using U series remote controller) 0099: Unfixed (Other than U series remote controller)	00Un/0099: Unfixed *1
13	Indoor unit address	Yes	Yes	Yes	0001: No.1 unit to 0064: No.64 unit ... TCC-LINK 0001: No.1 unit to 0128: No.128 unit ... TU2C-LINK 00Un: Unfixed (When using U series remote controller) 0099: Unfixed (Other than U series remote controller)	00Un/0099: Unfixed *1
14	Group address	Yes	Yes	Yes	0000: Individual 0001: Header unit of group 0002: Follower unit of group 00Un: Unfixed (When using U series remote controller) 0099: Unfixed (Other than U series remote controller)	00Un/0099: Unfixed *1
28	Automatic restart of power failure	Yes	Yes	Yes	0000: None 0001: Restart	0001: Restart
31	Ventilating fan control	Yes	Yes	Yes	0000: Unavailable 0001: Available	0000: Unavailable
33	Temperature unit select	Yes	Yes	Yes	0000: °C 0001: °F	0001: °F
60	Timer setting (wired remote controller)	Yes	Yes	Yes	0000: Available 0001: Unavailable (can be performed) (cannot be performed)	0000: Available
72	Fan Control during defrost	No	Yes	No	0000: Fan ON 0001: Fan OFF	TA:0000 TF:0001 DDC:0000
92	Fan trouble Input release condition	Yes	Yes	Yes	0000: Operation stopped 0001: Release signal received	0000: Operation stopped
D0	Whether the power saving mode can be set by the remote controller	Yes	No	No	0000: Invalid 0001: Valid	TA:0001 TF:0000 DDC:0000
FC	Communication protocol *2	Yes	Yes	Yes	0000:TCC-LINK 0003:TU2C-LINK	0000: TCC-LINK
180	Effective notice code number 01	Yes	Yes	Yes	0000:None 0129:DI4/*DI4 Notice input ON (code 201) 0134:Tx sensor error (code 206)	0000: None
181	Effective notice code number 02	Yes	Yes	Yes		0000: None
182	Effective notice code number 03	Yes	Yes	Yes		0000: None
183	Effective notice code number 04	Yes	Yes	Yes		0000: None
184	Effective notice code number 05	Yes	Yes	Yes		0000: None
185	Effective notice code number 06	Yes	Yes	Yes		0000: None
186	Effective notice code number 07	Yes	Yes	Yes		0000: None
187	Effective notice code number 08	Yes	Yes	Yes		0000: None
188	Effective notice code number 09	Yes	Yes	Yes		0000: None
189	Effective notice code number 10	Yes	Yes	Yes		0000: None
1FB	Central device control state	Yes	Yes	Yes	0000: No central device control (Remote controller use is possible) 0001: Central device control (Remote controller use is impossible)	0000: No central device control
1FC	Indoor Unit terminating resistance	Yes	Yes	Yes	0000: OFF 0001: ON	0000: OFF

DN	Item	Setting allowed			Description	At shipment
		TA	TF	DDC		
402	Cooling forced thermostat OFF temp. T _{ac} (Minimum Outdoor/Suction air temp.)	No	Yes	No	0018: 64°F(18°C) ~ 0025: 77°F(25°C)	0019: 66°F(19°C)
403	Heating forced thermostat OFF temp. T _{ah} (Maximum Outdoor/Suction air temp.)	No	Yes	No	0000: 32°F(0°C) ~ 0017: 63°F(17°C)	0015: 59°F(15°C)
404	Cooling design thermostat ON/OFF temp. T _{βc} (Difference the setup temp. and Outdoor/Suction air temp.)	No	Yes	No	0000: 32°F(0°C) ~ 0010: 50°F(10°C)	0003: 37°F(3°C)
405	Heating design thermostat ON/OFF temp. T _{βh} (Difference the setup temp. and Outdoor/Suction air temp.)	No	Yes	No	0000: 32°F(0°C) ~ 0010: 50°F(10°C)	0003: 37°F(3°C)
406	Cooling forced thermostat OFF temp. T _{yc} (Minimum Discharge air temp.)	No	Yes	No	-0015: 5°F(-15°C) ~ 0060: 140°F(60°C)	0003: 37°F(3°C)
407	Heating forced thermostat OFF temp. T _{yh} (Maximum Discharge air temp.)	No	Yes	No	0000: 32°F(0°C) ~ 0060: 140°F(60°C)	0060: 140°F(60°C)
4A0	External input FAN control(4-20mA)	Yes	Yes	No	0000:None 0001:With FAN control by 4-20mA input (outdoor FAN control priority) 0002:With FAN control by 4-20mA input (priority is given to 4-20mA input)	0000: None
4A1	Analog input FAN (H) control value	Yes	Yes	No		0013: 13mA
4A2	Analog input FAN (HH) control value	Yes	Yes	No		0004: +4mA *1:Upper limit . DN[4A1] + DN[4A2] ≤ 18mA
4A3	Analog input FAN (L) control value	Yes	Yes	No		0007: -7mA *2:Lower limit. DN[4A1] - DN [4A3] ≥ 4mA
4A4	FAN speed Analog output value (HH)	Yes	Yes	No	0008: 8V ~ 0010:10V	0009:9V
4A5	FAN speed Analog output value (H)	Yes	Yes	No	0004: 4V ~ 0007:7V	0006:6V
4A6	FAN speed Analog output value (L)	Yes	Yes	No	0001: 1V ~ 0003:3V	0002:2V
4A7	TX (auxiliary temperature sensor) function selection		Yes	Yes	0000:None 0001:TA 0002:TF 0003:TCJ 0004:TC2	0000:None
4A8	TX (auxiliary temperature sensor) control method selection			Yes	0000:Used in place of the temperature sensor selected in [4A7] 0001:Use the average value of the temperature sensor selected in [4A7] for control	0000
4A9	Set temperature change function by 0-10V	Yes	Yes	No	0000:OFF 0001:ON	0000:OFF
4AA	Heating set temperature shift by 0-10V input	Yes	Yes	No	-0010: 14°F(-10°C) ~ 0010: 50°F(10°C)	0000: 32°F(0°C)
4AB	Cooling set temperature shift by 0-10V input	Yes	Yes	No	-0010: 14°F(-10°C) ~ 0010: 50°F(10°C)	0000: 32°F(0°C)
4AC	Operation prohibited from centralized equipment	Yes	Yes	Yes	0000:approval 0001:NOT approval	0000:approval
4AD	TC1 miss-attachment detection control	Yes	Yes	Yes	0000:No control 0001:With control	0000:No control
4AE	Dx-Valve kit type name	Yes	Yes	Yes	0001:6~10Ton 0002:12~16Ton 0003: 0.6~5Ton	Depends on Ton settings
4AF	Defrost signal output delay time	Yes	Yes	Yes	0000:No delay 0001:1 minute delay~ 0030:30 minute delay	0000:No delay

7-5. Troubleshooting based on information displayed on remote controller

■ Confirmation and check

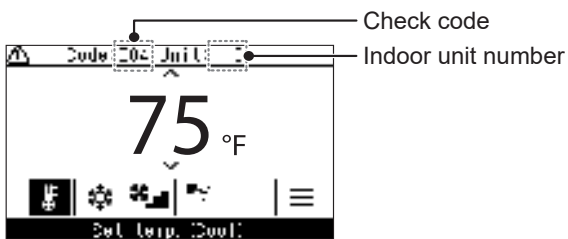

When an error occurs in the air conditioner, the check code and the indoor unit number flash on the display of the remote controller.

* The check code is only displayed during the operation.

When the check code and indoor unit number are displayed, pressing [Return] opens the “Check” screen.

In the “Check” screen, press [Set/Fix] to show the contacts. Press [Menu] to display “Model information”.



■ Confirming an alarm history

Ten check codes in the past, troubled unit, and date when trouble occurred are displayed on “Alarm history” screen.



1 In the “Field setting menu” screen, press [] and [] to select “Alarm history”, and then press [Set/Fix]

List of latest 10 alarm data is displayed.

* The oldest data are deleted in order to record the new ones.

→ The date and time when the check code occurred for the first time is displayed for the repeated alarm.

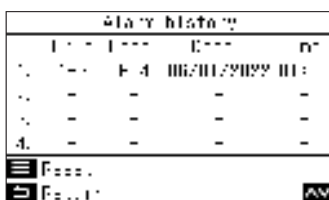

Deleting the alarm history



1 Press [Menu] while the “Alarm history” screen is displayed

→ “Reset all alarm data.” is displayed

2 Press [Set/Fix]

→ Delete the Alarm history in each remote controller when the dual remote controller system is used.

Indoor service monitor list

	Code No.	Data name	Display format	Unit	Remote controller display example
Indoor unit data	00	Room temperature (Use to control)	x1	°F	[0024]=75°F(24°C)
	01	Room temperature (Remote controller)	x1	°F	
	02	Indoor suction air temperature (TA)	x1	°F	
	03	Indoor coil temperature (TCJ)	x1	°F	
	04	Indoor coil temperature (TC2)	x1	°F	
	05	Indoor coil temperature (TC1)	x1	°F	
	06	Indoor discharge air temperature (TF) **	x1	°F	[0150]=1500pls
	08	Indoor PMV opening	x1/10	pls	
	F9	Suction temperature of air to air heat exchanger (TSA) **	x1	°F	[0024] = 75°F(24°C)
	FA	Outside air temperature (TOA) **	x1	°F	0=No output 1=Output
	D0	Outdoor unit(s) operation level is lower than capacity command	0 or 1	-	
	D1	Outdoor unit(s) operation level is higher than capacity command	0 or 1	-	
	D2	Cooling oil recovery / Heating refrigerant recovery control	0 or 1	-	
D3	Cooling operation output	0 or 1	-		
D4	Heating operation output	0 or 1	-		
D5	The suction air temperature (TA) is in the thermostat OFF range (only TF type)	0 or 1	-		
DF	Under restriction of compressor speed due to heat sink overheating in outdoor unit (s)	0 or 1	-		
F5	Tx temperature	x1	°F		
System data	0A	No. of connected indoor units	x1	unit	[0048]=48 units
	0B	Total horsepower of connected indoor units	x10	Ton	[0415]=41.5Ton
	0C	No. of connected outdoor units	x1	unit	[0003]=3 units
	0D	Total horsepower of outdoor units	x10	Ton	[0420]=42Ton

	Code No.	Data name	Display format	Unit	Remote controller display example
Indoor unit data *2	00	Room temperature (Use to control)	X1	°F	[0024]=75°F(24°C)
	01	Room temperature (Remote controller)	X1	°F	
	02	Indoor suction air temperature (TA)	X1	°F	
	03	Indoor coil temperature (TCJ)	X1	°F	
	04	Indoor coil temperature (TC2)	X1	°F	
	05	Indoor coil temperature (TC1)	X1	°F	
	06	Indoor discharge air temperature (TF) *1	X1	°F	[0100]=1000rpm
	07	Indoor fan motor number of revolutions	X10	rpm	
	08	Indoor PMV opening	X1/10	pls	
	F3	Filter sign time	X1	h	
F9	Suction exchanger (TSA) *1 temperature of air to air heat	X1	°F	[0024]=75°F(24°C)	
FA	Outside air temperature (TOA) *1	X1	°F		
System data	0A	No. of connected indoor units	X1	units	[0048]=48 units
	0B	Total horsepower of connected indoor units	X10	Ton	[0415]=41.5Ton
	0C	No. of connected outdoor units	X1	units	[0003]=3 units
	0D	Total horsepower of outdoor units	X10	Ton	[0420]=42Ton

	Code No.					Data name	Display format	Unit	Remote controller display example
	U1	U2	U3	U4	U5				
Outdoor unit individual data 1 *3	10	20	30	40	50	High-pressure sensor detection pressure(Pd)	X100	Mpa	[0123]=1.23MPa
	11	21	31	41	51	Low-pressure sensor detection pressure (Ps)	X100	Mpa	
	12	22	32	42	52	Compressor 1 discharge temperature (TD1)	X1	°F	[0024]=75°F(24°C)
	13	23	33	43	53	Compressor 2 discharge temperature (TD2)	X1	°F	
	14	24	34	44	54	Suction temperature (TS1)	X1	°F	
	15	25	35	45	55	Suction temperature (TS3)	X1	°F	
	16	26	36	46	56	Outdoor heat exchanger temperature (TE1)	X1	°F	
	17	27	37	47	57	Outdoor sub-heat exchanger temperature (TE2)	X1	°F	
	18	28	38	48	58	Outdoor sub-heat exchanger temperature (TE3)	X1	°F	
	19	29	39	49	59	Outside ambient temperature (TO)	X1	°F	
	1A	2A	3A	4A	5A	Temperature at liquid side (TL1)	X1	°F	
	1B	2B	3B	4B	5B	Suction temperature (TS2)	X1	°F	
	1C	2C	3C	4C	5C	Suction temperature (TS3)	X1	°F	
	1D	2D	3D	4D	5D	Outdoor coil temperature (TG1)	X1	°F	
	1E	2E	3E	4E	5E	Outdoor coil temperature (TG2)	X1	°F	
	1F	2F	3F	4F	5F	Outdoor coil temperature (TG3)	X1	°F	

	Code No.					Data name	Display format	Unit	Remote controller display example
	U1	U2	U3	U4	U5				
Outdoor unit individual data 2 *4	60	70	80	90	A0	Compressor oil temperature 1 (TK1)	X1	°F	[0024]=75°F(24°C)
	61	71	81	91	A1	Compressor oil temperature 2 (TK2)	X1	°F	
	62	72	82	92	A2	PMV 1 opening	X1	pls	[0500]=500pls
	63	73	83	93	A3	PMV 2 opening	X1	pls	
	64	74	84	94	A4	PMV 3 opening	X1	pls	
	65	75	85	95	A5	PMV 4 opening	X1	pls	
	66	76	86	96	A6	Compressor 1 current (I1)	X10	A	[0135]=13.5A
	67	77	87	97	A7	Compressor 2 current (I2)	X10	A	
	68	78	88	98	A8	Compressor 1 revolutions	X10	rps	[0642]=64.2rps
	69	79	89	99	A9	Compressor 2 revolutions	X10	rps	
	6A	7A	8A	9A	AA	Outdoor fan mode	X1	mode	[0058]=58 mode
	6B	7B	8B	9B	AB	Inverter of Compressor 1 heat sink temperature (TH1)	X1	°F	[0024]=75°F(24°C)
	6C	7C	8C	9C	AC	Inverter of Compressor 2 heat sink temperature (TH2)	X1	°F	
	6D	7D	8D	9D	AD	Inverter of outdoor fan 1 heat sink temperature (TH Fan1)	X1	°F	
	6E	7E	8E	9E	AE	Inverter of outdoor fan 2 heat sink temperature (TH Fan2)	X1	°F	
	6F	7F	8F	9F	AF	Outdoor unit horsepower	X1	Ton	[0016]=16Ton

	Code No.	Data name	Display format	Unit	Remote controller display example
Outdoor unit individual data 3 *5	B0	Heating/cooling recovery control	0 : Normal 1 : Recovery controlled		[0010]=Heating recovery control [0001]=Cooling recovery control
	B5	Instantaneous electric power	X1/10	W	[0090]=900W
	B6	Integrated electric power consumption	X1/100	Wh	[0090]=9000Wh
	B8	Termination resistance setting indoor unit address display	9999 : No setting 1~ : Setting address		[9999]=Case where no terminating resistance is set to any of the indoor units [0048]=Termination resistance setting Indoor unit address 48
	B9	Communications protocol	0 : TCC-LINK 1 : TU2C-LINK		[0000]=TCC-LINK [0001]=TU2C-LINK
	BA	Uv line communication speed	0 : 9600 bps 1 : 19200 bps		[0000]=9600bps [0001]=19200bps
	BB	Demand control	0 : Normally 1 : Demand control		[0000]=Normally [0001]=Demand control

*1 Only a part of indoor unit types is installed with the discharge air temperature sensor. This temperature is not displayed for other types.

*2 When the units are connected to a group, data of the header indoor unit only can be displayed.

*3 The first digit of code No. indicates the outdoor unit number.

*4 The upper digit of code No. -5 indicates the outdoor unit number.

- 1 * , 6 * ... U1 outdoor unit (Header unit)
- 2 * , 7 * ... U2 outdoor unit (Follower unit 1)
- 3 * , 8 * ... U3 outdoor unit (Follower unit 2)
- 4 * , 9 * ... U4 outdoor unit (Follower unit 3)
- 5 * , A * ... U5 outdoor unit (Follower unit 4)

*5 Only the Code No. "B * " of U1 outdoor unit (Header unit) is displayed.

8. TROUBLESHOOTING

8-1. Overview

(1) Before engaging in troubleshooting

(a) Applicable models

All Super Modular Multi System (SMMS-*) models.

(Indoor units: MM*-UP***, Outdoor units: MMY-M*P***)

(b) Tools and measuring devices required

- Screwdrivers (Phillips, flat head), spanners, long-nose pliers, nipper, pin to push reset switch, etc.
- Multimeter, thermometer, pressure gauge, etc.

(c) Things to check prior to troubleshooting (behaviors listed below are normal)

NO.	Behavior	Possible cause
1	A compressor would not start	<ul style="list-style-type: none"> • The air conditioner is being controlled by the 3-minute protective function. • It is in standby status though the room temperature has reached the setup temperature. • It is being operated in timer mode or fan mode. • It is being in initial communication.
2	An indoor fan would not start	<ul style="list-style-type: none"> • The air conditioner is being controlled by the cool air discharge preventive function in "heating"?
3	An outdoor fan would not start or would change speed for no reason	<ul style="list-style-type: none"> • The air conditioner is being operated in "cooling" under the low outside air temperature. • It is being operated in defrost operation.
4	An indoor fan would not stop	<ul style="list-style-type: none"> • The air conditioner is being controlled by function of residual heat elimination being performed as part of the air conditioner shutdown process after heating operation.
5	The air conditioner would not respond to a start/stop command from a remote controller	<ul style="list-style-type: none"> • The air conditioner is being operated under external or remote controller.

CAUTION

The cooling performance may be declining considerably when total operating capacity of cooling indoor units is less than 4 Ton while ambient temperature is below.

(2) Troubleshooting procedure

When a problem occurs, proceed with troubleshooting in accordance with the procedure shown below.

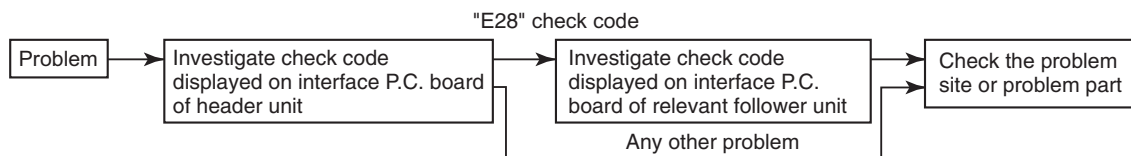

NOTE

Rather than a product trouble (see the List of Check Codes below), the problem could have been caused by a microprocessor malfunction attributable to a poor quality of the power source or an external noise. Check for possible noise sources, and shield the remote controller wiring and signal wires as necessary.

8-2. Troubleshooting Method

The remote controls (main remote control and central control remote control) and the interface P.C. board of an outdoor unit are provided with an LCD display (remote control) or a 7-segment display (outdoor interface P.C. board) to display operational status. Using this self-diagnosis feature, the problem may be identified in the event of a problem by following the method described below.

The list below summarizes check codes detected by various devices. Analyze the check code according to where it is displayed and work out the nature of the problem in consultation with the list.

- When investigating a problem on the basis of a display provided on the indoor remote control or TCC-LINK central control remote control - See the “TCC-LINK remote control or main remote control display” section of the list.
- When investigating a problem on the basis of a display provided on an outdoor unit - See the “Outdoor 7-segment display” section of the list.
- When investigating a problem on the basis of a wireless remote control-controlled indoor unit - See the “Light sensor indicator light block” section of the list.

List of Check Codes (Indoor Unit) (Check code detected by indoor unit)

IPDU: Intelligent Power Drive Unit (Inverter P.C. board)
 ○ : Lighting, ◎ : Flashing, ● : Goes off
 ALT.: Flashing is alternately when there are two flashing LED
 SIM: Simultaneous flashing when there are two flashing LED

Check code			Display of receiving unit				Typical problem site	Description of Check code
TCC-LINK central control or main remote control display	Outdoor 7-segment display		Indicator light block					
		Sub-code	Operation	Timer	Ready	Flash		
E03	-	-	◎	●	●		Indoor-remote control periodic communication trouble	Communication from remote control has been lost (so has central control communication).
E04	-	-	●	●	◎		Indoor-outdoor periodic communication trouble	Signals are not being received from outdoor unit.
E08	E08	Duplicated indoor address	◎	●	●		Duplicated indoor address	Indoor unit detects address identical to its own.
E18	-	-	◎	●	●		Trouble in periodic communication between indoor header and follower unit	Periodic communication between indoor header and follower units cannot be maintained.
F01	-	-	◎	◎	●	ALT	Indoor heat exchanger temperature sensor (TCJ) trouble	Heat exchanger temperature sensor (TCJ) has been open/short-circuited.
F02	-	-	◎	◎	●	ALT	Indoor heat exchanger temperature sensor (TC2) trouble	Heat exchanger temperature sensor (TC2) has been open/short-circuited.
F03	-	-	◎	◎	●	ALT	Indoor heat exchanger temperature sensor (TC1) trouble	Heat exchanger temperature sensor (TC1) has been open/short-circuited.
F10	-	-	◎	◎	●	ALT	Room air temperature sensor (TA/TSA) trouble	Room air temperature sensor (TA) has been open/short-circuited.
F11	-	-	◎	◎	●	ALT	Discharge air temperature sensor (TF/TFA) trouble	Discharge air temperature sensor (TF) has been open/short-circuited.
F17	-	-	◎	◎	○	ALT	Outside air suction temperature sensor (TOA) trouble	Open/Short of outside air suction temperature sensor (TOA) was detected.
F18	-	-	◎	◎	○	ALT	Indoor air suction temperature sensor (TRA) trouble	Discharge air temperature sensor (TF) has been open/short-circuited.
F29	-	-	◎	◎	●	SIM	P.C. board or other indoor check code	Indoor EEPROM is abnormal (some other trouble may be detected).
L02	-	-	◎	●	◎		Outdoor units model disagreed trouble	In case of different outdoor unit (Not corresponded to DX-COIL INTERFACE)
L03	-	-	◎	●	◎	SIM	Duplicated indoor group header unit	There is more than one header unit in group.
L07	-	-	◎	●	◎	SIM	Connection of group control cable to stand-alone indoor unit	There is at least one stand-alone indoor unit to which group control cable is connected.
L08	L08	-	◎	●	◎	SIM	Indoor group address not set	Address setting has not been performed for one or more indoor units (also detected at outdoor unit end).
L09	-	-	◎	●	◎	SIM	Indoor capacity not set	Capacity setting has not been performed for indoor unit.
L20	-	-	◎	○	◎	SIM	Duplicated central control address	There is duplication in central control address setting.
L22	-	-	◎	●	◎		Incompatible group combination of indoor units	Connection of group control between normal indoor units and Indoor (DX) unit.
L30	L30	Detected indoor unit No.	◎	○	◎	SIM	Indoor fan trouble input	Unit shutdown has been caused by fan trouble input (CN80 or CN90-pin 3).
P01	-	-	●	◎	◎	ALT	Indoor AC fan trouble	Indoor AC fan trouble is detected (activation of fan motor thermal relay).
P10	P10	Detected indoor unit No.	●	◎	◎	ALT	Safety contact input	Unit shutdown has been caused by safety contact input (CN90-pin 2).
P31	-	-	◎	●	◎	ALT	Other indoor unit trouble	Follower unit cannot be operated due to header unit alarm (E03/L03/L07/L08).

(Trouble detected by main remote control)

Check code			Display of receiving unit				Typical fault site	Description of trouble
Main remote control	Outdoor 7-segment display		Indicator light block					
		Sub-code	Operation ⏻	Timer ⌚	Ready ⊙	Flash		
E01	–	–	⊙	●	●		No master remote control, faulty remote control communication (reception)	Signals cannot be received from indoor unit; master remote control has not been set (including two remote control).
E02	–	–	⊙	●	●		Faulty remote control communication (transmission)	Signals cannot be transmitted to indoor unit.
E09	–	–	⊙	●	●		Duplicated master remote control	Both remote controls have been set as master remote control in two remote control (alarm and shutdown for header unit and continued operation for follower unit)

(Trouble detected by central control device)

Check code			Display of receiving unit				Typical fault site	Description of trouble	
TCC-LINK central control	Outdoor 7-segment display		Indicator light block						
		Sub-code	Operation ⏻	Timer ⌚	Ready ⊙	Flash			
C05	–	–					Faulty central control communication (transmission)	Central control device is unable to transmit signal due to duplication of central control device	
C06	–	–					Faulty central control communication (reception)	Central control device is unable to receive signal.	
–	–	–					Multiple network adapters	Multiple network adapters are connected to remote control communication line.	
C12	–	–					Blanket alarm for general-purpose device control interface	Device connected to general-purpose device control interface for TCC-LINK is faulty.	
P30	–	–					As per alarm unit (see above)	Group control follower unit trouble	Group follower unit is faulty (unit No. and above detail [***] displayed on main remote control)

Note: The same trouble, e.g. a communication trouble, may result in the display of different check codes depending on the device that detects it.
Moreover, check codes detected by the main remote control/central control device do not necessarily have a direct impact on air conditioner operation.

List of Check Codes (Outdoor Unit)

(Check code detected by SMMS-e outdoor interface - typical examples)

If “HELLO” is displayed on the outdoor 7-segment for 1 minute or more, turn off the power supply once and then turn on the power supply again after 30 seconds or more. When the same symptom appears, it is considered there is a possibility of I/F board trouble.

IPDU: Intelligent Power Drive Unit (Inverter P.C. board)
 ○ : Lighting, ◎ : Flashing, ● : Goes off
 ALT.: Flashing is alternately when there are two flashing LED
 SIM: Simultaneous flashing when there are two flashing LED

Check code		Display of receiving unit				Typical problem site	Description of problem																																																																																																			
Outdoor 7-segment display		TCC-LINK central control or main remote control display	Indicator light block																																																																																																							
Sub-code			Operation	Timer	Ready	Flash																																																																																																				
E06	Number of indoor units from which signal is received normally	E06	●	●	◎		Signal lack of indoor unit	Indoor unit initially communicating normally fails to return signal (reduction in number of indoor units connected).																																																																																																		
E07	–	(E04)	●	●	◎		Indoor-outdoor communication circuit trouble	Signal cannot be transmitted to indoor units (→ indoor units left without communication from outdoor unit).																																																																																																		
E08	Duplicated indoor address	(E08)	◎	●	●		Duplicated indoor address	More than one indoor unit are assigned same address (also detected at indoor unit end).																																																																																																		
E12	01: Indoor-outdoor communication 02: Outdoor-outdoor communication	E12	◎	●	●		Automatic address starting trouble	<ul style="list-style-type: none"> Indoor automatic address setting is started while automatic address setting for equipment in other refrigerant line is in progress. Outdoor automatic address setting is started while automatic address setting for indoor units is in progress. 																																																																																																		
E15	–	E15	●	●	◎		Indoor unit not found during automatic address setting	Indoor unit fails to communicate while automatic address setting for indoor units is in progress.																																																																																																		
E16	00: Overloading 01: Number of units connected	E16	●	●	◎		Too many indoor units connected/overloading	Combined capacity of indoor units is too large (more than 135% of combined capacity of outdoor units).																																																																																																		
E19	00: No header unit 02: Two or more header units	E19	●	●	◎		Trouble in number of outdoor header units	There is no or more than one outdoor header unit in one refrigerant line.																																																																																																		
E20	01: Connection of outdoor unit from other refrigerant line 02: Connection of indoor unit from other refrigerant line	E20	●	●	◎		Connection to other refrigerant line found during automatic address setting	Indoor unit from other refrigerant line is detected while indoor automatic address setting is in progress.																																																																																																		
E23	–	E23	●	●	◎		Outdoor-outdoor communication transmission trouble	Signal cannot be transmitted to other outdoor units.																																																																																																		
E25	–	E25	●	●	◎		Duplicated follower outdoor address	There is duplication in outdoor addresses set manually.																																																																																																		
E26	Address of outdoor unit from which signal is not received normally	E26	●	●	◎		Signal lack of outdoor unit	Follower outdoor unit initially communicating normally fails to do so (reduction in number of follower outdoor units connected).																																																																																																		
E28	Detected outdoor unit No.	E28	●	●	◎		Outdoor follower unit trouble	Outdoor header unit detects fault relating to follower outdoor unit (detail displayed on follower outdoor unit).																																																																																																		
E31	<table border="1"> <thead> <tr> <th rowspan="2">Sub-code</th> <th colspan="2">A3-IPDU</th> <th colspan="2">Fan-IPDU</th> <th rowspan="2">Sub-code</th> <th colspan="2">A3-IPDU</th> <th colspan="2">Fan-IPDU</th> </tr> <tr> <th>1</th> <th>2</th> <th>1</th> <th>2</th> <th>1</th> <th>2</th> <th>1</th> <th>2</th> </tr> </thead> <tbody> <tr> <td>01</td> <td>○</td> <td></td> <td></td> <td></td> <td>10</td> <td></td> <td></td> <td></td> <td>○</td> </tr> <tr> <td>02</td> <td></td> <td>○</td> <td></td> <td></td> <td>11</td> <td>○</td> <td></td> <td></td> <td>○</td> </tr> <tr> <td>03</td> <td>○</td> <td>○</td> <td></td> <td></td> <td>12</td> <td></td> <td>○</td> <td></td> <td>○</td> </tr> <tr> <td>08</td> <td></td> <td></td> <td>○</td> <td></td> <td>13</td> <td>○</td> <td>○</td> <td></td> <td>○</td> </tr> <tr> <td>09</td> <td>○</td> <td></td> <td>○</td> <td></td> <td>18</td> <td></td> <td></td> <td>○</td> <td>○</td> </tr> <tr> <td>0A</td> <td></td> <td>○</td> <td>○</td> <td></td> <td>19</td> <td>○</td> <td></td> <td>○</td> <td>○</td> </tr> <tr> <td>0B</td> <td>○</td> <td>○</td> <td>○</td> <td>○</td> <td>1A</td> <td></td> <td>○</td> <td>○</td> <td>○</td> </tr> <tr> <td></td> <td></td> <td></td> <td></td> <td></td> <td>1B</td> <td>○</td> <td>○</td> <td>○</td> <td>○</td> </tr> </tbody> </table> <p>Circle (O): Faulty IPDU 80 : Communication trouble between MCU and Sub MCU</p>	Sub-code	A3-IPDU		Fan-IPDU		Sub-code	A3-IPDU		Fan-IPDU		1	2	1	2	1	2	1	2	01	○				10				○	02		○			11	○			○	03	○	○			12		○		○	08			○		13	○	○		○	09	○		○		18			○	○	0A		○	○		19	○		○	○	0B	○	○	○	○	1A		○	○	○						1B	○	○	○	○	E31	●	●	◎		IPDU communication trouble Sub MCU communication trouble	There is no communication between IPDUs (P.C. boards) in inverter box.
Sub-code	A3-IPDU		Fan-IPDU		Sub-code	A3-IPDU		Fan-IPDU																																																																																																		
	1	2	1	2		1	2	1	2																																																																																																	
01	○				10				○																																																																																																	
02		○			11	○			○																																																																																																	
03	○	○			12		○		○																																																																																																	
08			○		13	○	○		○																																																																																																	
09	○		○		18			○	○																																																																																																	
0A		○	○		19	○		○	○																																																																																																	
0B	○	○	○	○	1A		○	○	○																																																																																																	
					1B	○	○	○	○																																																																																																	
F04	–	F04	◎	◎	○	ALT	Outdoor discharge temperature sensor (TD1) trouble	Outdoor discharge temperature sensor (TD1) has been open/short-circuited.																																																																																																		
F05	–	F05	◎	◎	○	ALT	Outdoor discharge temperature sensor (TD2) trouble	Outdoor discharge temperature sensor (TD2) has been open/short-circuited.																																																																																																		
F06	01: TE1 02: TE2	F06	◎	◎	○	ALT	Outdoor heat exchanger liquid side temperature sensor (TE1, TE2) trouble	Outdoor heat exchanger liquid side temperature sensors (TE1, TE2) have been open/short-circuited.																																																																																																		
F07	01: TL1 02: TL2 03: TL3	F07	◎	◎	○	ALT	Outdoor liquid temperature sensor (TL1, TL2, TL3) trouble	Outdoor liquid temperature sensor (TL1, TL2, TL3) has been open/short-circuited.																																																																																																		
F08	–	F08	◎	◎	○	ALT	Outdoor outside air temperature sensor (TO) trouble	Outdoor outside air temperature sensor (TO) has been open/short-circuited.																																																																																																		

Check code		Display of receiving unit				Typical problem site	Description of problem	
Outdoor 7-segment display		TCC-LINK central control or main remote control display	Indicator light block					
	Sub-code			Operation ⏻	Timer ⌚	Ready ⊗	Flash	
F09	01: TG1 02: TG2						Outdoor heat exchanger gas side temperature sensor (TG1, TG2) trouble	Outdoor heat exchanger gas side temperature sensors (TG1, TG2) have been open/-short circuited.
F12	01: TS1 03: TS3	F12	⊗	⊗	○	ALT	Outdoor suction temperature sensor (TS1,TS3) trouble	Outdoor suction temperature sensor (TS1,TS3) has been open/short-circuited.
F15	–	F15	⊗	⊗	○	ALT	Outdoor temperature sensor (TE1,TL1) wiring trouble	Wiring trouble in outdoor temperature sensors (TE1,TL1) has been detected.
F16	–	F16	⊗	⊗	○	ALT	Outdoor pressure sensor (Pd, Ps) wiring trouble	Wiring trouble in outdoor pressure sensors (Pd, Ps) has been detected.
F23	–	F23	⊗	⊗	○	ALT	Low pressure sensor (Ps) trouble	Output voltage of low pressure sensor (Ps) is zero.
F24	–	F24	⊗	⊗	○	ALT	High pressure sensor (Pd) trouble	Output voltage of high pressure sensor (Pd) is zero or provides abnormal readings when compressors have been turned off.
F31	–	F31	⊗	⊗	○	SIM	Outdoor EEPROM trouble	Outdoor EEPROM is faulty (alarm and shutdown for header unit and continued operation for follower unit)
H05	–	H05	●	⊗	●		Outdoor discharge temperature sensor (TD1) wiring trouble	Wiring/installation trouble or detachment of outdoor discharge temperature sensor (TD1) has been detected
H06	–	H06	●	⊗	●		Activation of low-pressure protection	Low pressure (Ps) sensor detects abnormally low operating pressure.
H07	–	H07	●	⊗	●		Low oil level protection	Temperature sensor for oil level detection (TK1,TK2,TK4,TK5) detects abnormally low oil level.
H08	01: TK1 sensor trouble 02: TK2 sensor trouble 04: TK4 sensor trouble 05: TK5 sensor trouble	H08	●	⊗	●		Trouble in temperature sensor for oil level detection (TK1,TK2,TK4,TK5)	Temperature sensor for oil level detection (TK1,TK2,TK4,TK5) has been open/short-circuited.
H15	–	H15	●	⊗	●		Outdoor discharge temperature sensor (TD2) wiring trouble	Wiring/installation trouble or detachment of outdoor discharge temperature sensor (TD2) has been detected.
H16	01: TK1 oil circuit trouble 02: TK2 oil circuit trouble 04: TK4 oil circuit trouble 05: TK5 oil circuit trouble	H16	●	⊗	●		Oil level detection circuit trouble	No temperature change is detected by temperature sensor for oil level detection (TK1,TK2,TK4,TK5) despite compressor having been started.
L04	–	L04	⊗	○	⊗	SIM	Duplicated outdoor refrigerant line address	Identical refrigerant line address has been assigned to outdoor units belonging to different refrigerant piping systems.
L06	Number of priority indoor units (check code L05 or L06 depending on individual unit)	L05	⊗	●	⊗	SIM	Duplicated priority indoor unit (as displayed on priority indoor unit)	More than one indoor unit have been set up as priority indoor unit.
		L06	⊗	●	⊗	SIM	Duplicated priority indoor unit (as displayed on indoor unit other than priority indoor unit)	More than one indoor unit have been set up as priority indoor unit.
L08	–	(L08)	⊗	●	⊗	SIM	Indoor group address not set	Address setting have not been performed for one or more indoor units (also detected at indoor end).
L10	–	L10	⊗	○	⊗	SIM	Outdoor capacity not set	Outdoor unit capacity has not been set (after P.C. board replacement).
L17	–	L17	⊗	○	⊗	SIM	Outdoor model incompatibility trouble	Old model outdoor unit (prior to 6 series) has been connected.
L23	–	L23	⊗	○	⊗	SIM	SW setting mistake	Bit 3 and 4 of SW17 are turning on.
L28	–	L28	⊗	○	⊗	SIM	Too many outdoor units connected	More than three outdoor units have been connected.

Check code			Display of receiving unit				Typical problem site	Description of problem																																																																																								
Outdoor 7-segment display			Indicator light block																																																																																													
Sub-code	Central control or main remote controller display	Indicator light block				Flash																																																																																										
		Operation ⏻	Timer ⌚	Ready ⊕	Flash																																																																																											
L29	<table border="1"> <thead> <tr> <th colspan="4">P.C.board</th> <th colspan="4">P.C.board</th> </tr> <tr> <th colspan="2">Compressor</th> <th colspan="2">Fan Motor</th> <th colspan="2">Compressor</th> <th colspan="2">Fan Motor</th> </tr> <tr> <th>1</th><th>2</th><th>1</th><th>2</th><th>1</th><th>2</th><th>1</th><th>2</th> </tr> </thead> <tbody> <tr><td>01</td><td>○</td><td></td><td></td><td>11</td><td>○</td><td></td><td>○</td></tr> <tr><td>02</td><td></td><td>○</td><td></td><td>12</td><td></td><td>○</td><td>○</td></tr> <tr><td>03</td><td>○</td><td>○</td><td></td><td>13</td><td>○</td><td>○</td><td>○</td></tr> <tr><td>08</td><td></td><td></td><td>○</td><td>18</td><td></td><td></td><td>○</td></tr> <tr><td>09</td><td>○</td><td></td><td>○</td><td>19</td><td>○</td><td></td><td>○</td></tr> <tr><td>0A</td><td></td><td>○</td><td>○</td><td>1A</td><td></td><td>○</td><td>○</td></tr> <tr><td>0B</td><td>○</td><td>○</td><td>○</td><td>1B</td><td>○</td><td>○</td><td>○</td></tr> <tr><td>10</td><td></td><td></td><td>○</td><td></td><td></td><td></td><td></td></tr> </tbody> </table> <p>Circle (O): Trouble P.C. board</p>	P.C.board				P.C.board				Compressor		Fan Motor		Compressor		Fan Motor		1	2	1	2	1	2	1	2	01	○			11	○		○	02		○		12		○	○	03	○	○		13	○	○	○	08			○	18			○	09	○		○	19	○		○	0A		○	○	1A		○	○	0B	○	○	○	1B	○	○	○	10			○					L29	⊙	○	⊙	SIM	Trouble in number of P.C. boards	There are insufficient number of P.C. board in inverter box.
	P.C.board				P.C.board																																																																																											
Compressor		Fan Motor		Compressor		Fan Motor																																																																																										
1	2	1	2	1	2	1	2																																																																																									
01	○			11	○		○																																																																																									
02		○		12		○	○																																																																																									
03	○	○		13	○	○	○																																																																																									
08			○	18			○																																																																																									
09	○		○	19	○		○																																																																																									
0A		○	○	1A		○	○																																																																																									
0B	○	○	○	1B	○	○	○																																																																																									
10			○																																																																																													
00	L29	⊙	○	⊙	SIM	The number of P.C. board trouble	When there is much number of an inverter P.C. board to model setting of an interface P.C. board.																																																																																									
L30	Detected indoor unit No.	(L30)	⊙	○	⊙	SIM	Indoor external trouble input (interlock)	Indoor unit has been shut down for external trouble input in one refrigerant line (detected by indoor unit).																																																																																								
P03	–	P03	⊙	●	⊙	ALT	Outdoor discharge (TD1) temperature trouble	Outdoor discharge temperature sensor (TD1) has detected abnormally high temperature.																																																																																								
P04	01: Compressor 1 02: Compressor 2	P04	⊙	●	⊙	ALT	Activation of high-pressure SW	High-pressure SW is activated.																																																																																								
P05	00: Power detection trouble 01: Open phase 02: Power supply miswiring	P05	⊙	●	⊙	ALT	Power detection trouble /Open phase detection /Power supply miswiring detection	Open phase is detected when power is turned on. Inverter DC voltage is too high (overvoltage) or too low (undervoltage).																																																																																								
P07	00 : Compressor 1 or 2 heat sink trouble 01 : Compressor 1 heat sink trouble 02 : Compressor 2 heat sink trouble	P07	⊙	●	⊙	ALT	Heat sink overheating trouble	Temperature sensor built into IPM (TH) detects overheating.																																																																																								
	04: Heat sink dewing						Heat sink dewing trouble	Outdoor liquid temperature sensor (TL2) has detected abnormally low temperature.																																																																																								
P10	Indoor unit No. detected	(P10)	●	⊙	⊙	ALT	Indoor unit overflow	Indoor unit has been shutdown in one refrigerant line due to detection of overflow (detected by indoor unit).																																																																																								
P11	–	P11	●	⊙	⊙	ALT	Outdoor heat exchanger freeze trouble	Remaining frost on outdoor heat exchanger has been detected repeatedly.																																																																																								
P13	–	P13	●	⊙	⊙	ALT	Outdoor liquid backflow detection trouble	State of refrigerant cycle circuit indicates liquid backflow operation.																																																																																								
P15	01: TS condition 02: TD condition	P15	⊙	●	⊙	ALT	Gas leak detection	Outdoor suction temperature sensor (TS1) detects sustained and repeated high temperatures that exceed standard value.																																																																																								
P17	–	P17	⊙	●	⊙	ALT	Outdoor discharge (TD2) temperature trouble	Outdoor discharge temperature sensor (TD2) detects abnormally high temperature.																																																																																								
P19	Outdoor unit No. detected	P19	⊙	●	⊙	ALT	4-way valve reversing trouble	Abnormality in refrigerating cycle is detected during heating operation.																																																																																								
P20	–	P20	⊙	●	⊙	ALT	Activation of high-pressure protection	High pressure (Pd) sensor detects high pressure that exceeds standard value.																																																																																								

MG-CTT: Magnet contactor

(Check code detected by Inverter of Compressor featuring in outdoor unit - typical examples)

Check code		Display of receiving unit				Typical problem site	Description of proplem	
Outdoor 7-segment display		Central control or main remote controller display	Indicator light block					
Sub-code			Operation	Timer	Ready	Flash		
F13	1*: Compressor 1 2*: Compressor 2	F13	⊙	⊙	○	ALT	Trouble in temperature sensor built into indoor IPM (TH)	Temperature sensor built into indoor IPM (TH) has been open/short-circuited.
H01	1*: Compressor 1 2*: Compressor 2	H01	●	⊙	●		Compressor breakdown	Inverter current (Idc) detection circuit detects overcurrent.
H02	1*: Compressor 1 2*: Compressor 2	H02	●	⊙	●		Compressor trouble (lockup)	Compressor lockup is detected
H03	1*: Compressor 1 2*: Compressor 2	H03	●	⊙	●		Current detection circuit trouble	Abnormal current is detected while inverter compressor is turned off.
H17	1*: Compressor 1 2*: Compressor 2	H17	●	⊙	●		Compressor trouble (Step-out)	Compressor is in step-out condition.
P05	1*: Compressor 1 side 2*: Compressor 2 side	P05	⊙	●	⊙	ALT	Compressor Vdc trouble	Inverter DC voltage is too high (overvoltage) or too low (undervoltage).
P07	1*: Compressor 1 side 2*: Compressor 2 side	P07	⊙	●	⊙	ALT	Heat sink overheat trouble	Temperature sensor built into IPM (TH) detects overheating.
P11	–	P11	●	⊙	⊙	ALT	Outdoor heat exchanger freeze trouble	Remaining frost on outdoor heat exchanger has been detected repeatedly.
P22	1*: Fan P.C. board 1 2*: Fan P.C. board 2	P22	⊙	●	⊙	ALT	Outdoor fan P.C. board trouble	Outdoor fan P.C. board detects trouble.
P26	1*: Compressor 1 2*: Compressor 2	P26	⊙	●	⊙	ALT	Activation of IPM, compressor short-circuit protection	Short-circuit protection for compressor motor driver circuit components is activated (momentary overcurrent).
P29	1*: Compressor 1 2*: Compressor 2	P29	⊙	●	⊙	ALT	Compressor position detection circuit trouble	Compressor motor position detection trouble is detected.

Note: The above check codes are examples only, and different check codes may be displayed depending on the outdoor unit configuration

9. EXPLODED VIEWS AND PARTS LIST

Dx-coil controller

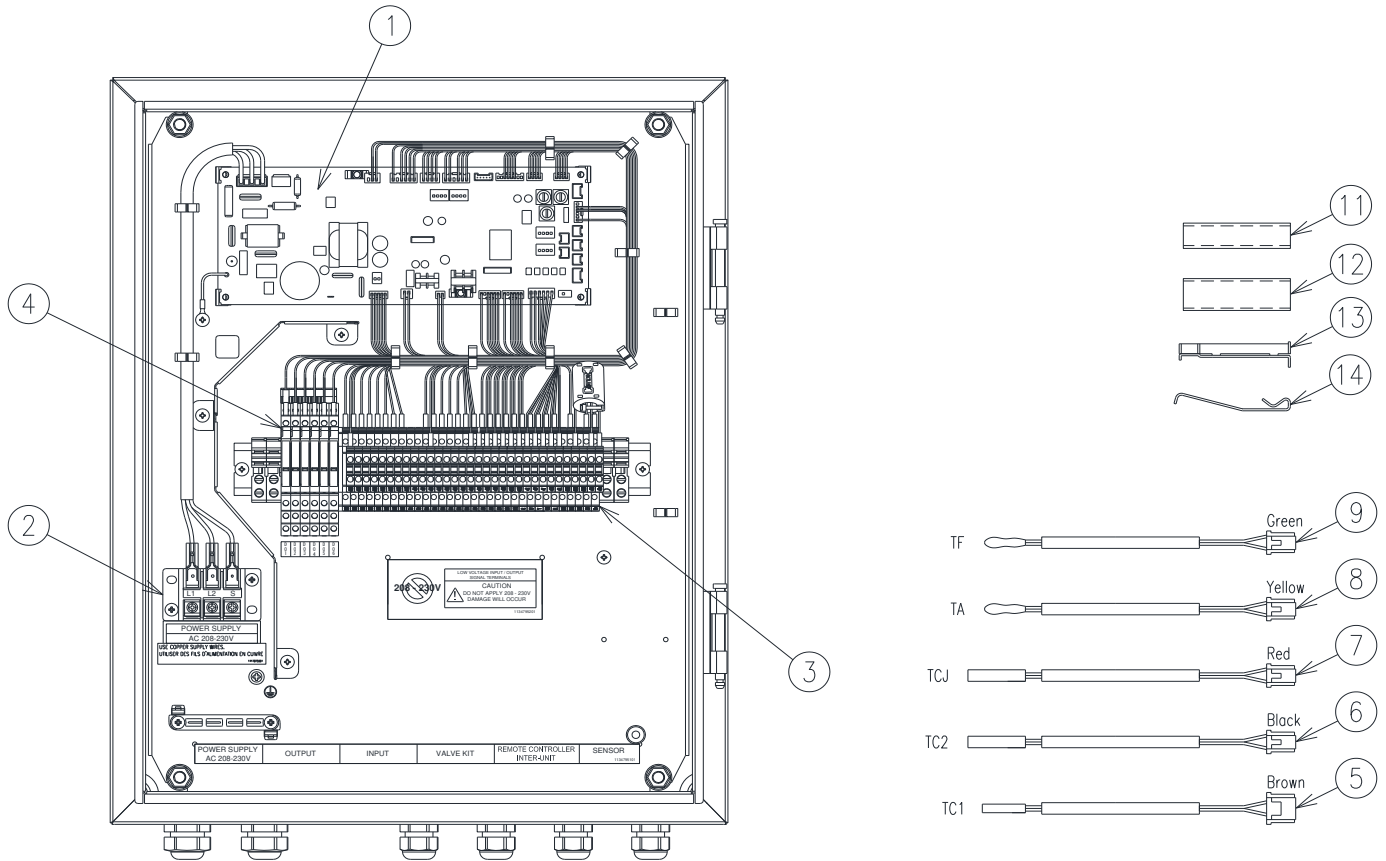

Location No.	Part No.	Description	Q'ty / Set
			TCB-IFDMR01UP-UL
1	43TNV348	PC BOARD ASSY, MCC-1777	1
2	43T60402	TERMINAL:3P	1
3	43T60591	TERMINAL, DEGSON	32
4	43T54326	TERMINAL, RELAY, OMRON	6
5	43T50425	SENSOR,TC1	1
6	43T50426	SENSOR,TC2	1
7	43T50427	SENSOR,TCJ	1
8	43T50428	SENSOR,TA	1
9	43T50429	SENSOR,TF	1
11	43T63396	HOLDER,SENSOR (TC1)	1
12	43T63397	HOLDER,SENSOR (TC2, TCJ)	2
13	43T19321	FIX-P-SENSOR (Sensor clip TC1)	1
14	43T19333	HOLDER, SENSOR (Sensor clip TC2, TCJ)	2

Toshiba Carrier (Thailand) Co., Ltd.

**144/9 MOO 5, BANGKADI INDUSTRIAL PARK, TIVANON ROAD, TAMBOL BANGKADI,
AMPHUR MUANG, PATHUMTHANI 12000, THAILAND.**