

CONTENTS

1.Important Safety Instructions	05
2.Packing List	10
3.Product Introduction	11
4.How to Use	14
5.How to Download and Connect the App	20
6.How to Use the App	25
7.Maintenance and Cleaning	30
8.Specification	41
9.Common Problems	42
10.Troubleshooting	44
11.Warranty	45
12.Disposal	47

1.Important Safety Instructions

⚠ WARNING: TO REDUCE THE RISK OF INJURY OR DAMAGE, READ THE FOLLOWING SAFETY PRECAUTIONS WHEN SETTING UP USING AND MAINTAINING YOUR ROBOT.



1.1 Range of Usage

- This product is designed for indoor floor cleaning only, do not use it outdoors (such as on an open-ended terrace), on any surface other than the ground (such as a sofa), or in any commercial or industrial environment.
- Do not use the product on burning objects (such as cigarette butts).
- Do not use the product to clean hard or sharp objects (such as decoration wastes, glass and nails). 
- Do not use the product on high pile carpets (product effectiveness may also be reduced on dark carpets).
- Do not use this product on elevated surfaces without barriers such as the floor of a loft, an open-ended terrace, or on top of furniture.
- Do not use the mopping module on carpets.
- Do not use the product when the ambient temperature is higher than 104°F (40°C), lower than 39°F (4°C), or if there are liquids or tacky substances on the floor.

1.2 About the Appliance Use

- Before using the product, move wires off the ground or place them to the side to prevent them being pulled on by the cleaner.
- To prevent blocking the product and to avoid damage to valuables, remove light-weight items (such as plastic bags) and fragile objects (such as vases) from the floor before cleaning.
- Children should be supervised to ensure that they do not play with the appliance.
- Keep hair, loose clothing, fingers, and all parts of the body away from openings and moving parts.
- This product is not intended for use by persons (including children) with reduced physical, sensory or mental capabilities, or lack of experience and knowledge, unless they have been given supervision or instruction concerning use of the product by a person responsible for their safety (CB).
- This product can be used by children aged from 8 years and above and persons with reduced physical, sensory or mental capabilities or lack of experience and knowledge if they have been given supervision or instruction concerning use of the product in a safe way and understand the hazards involved. Children shall not play with the product. Cleaning and user maintenance shall not be made by children without supervision (EU).
- Use the product according to the manual. Any loss or damage caused from improper use will be borne by the user.

1.3 About the Charging Dock Use

- Risk of electric shock, use this charging base in dry location only. 
- This device is only to be used with the charging dock provided by Laesar.
- Keep the charging dock away from heat (such as heating vents).
- Do not wipe or clean the charger prongs with wet cloth or wet hands. 
- If the power cord is damaged, stop using it immediately. It must be replaced by the manufacturer, its service agent, or similarly qualified persons to avoid a hazard. 
- If it will be not used for a long time, fully charge the appliance, turn it off and put in a cool and dry place. Charge the appliance at least once every 3 months to avoid battery damage due to over discharge.

1.4 About Storage and Maintenance

- Do not place the charging base close to heat sources (such as radiator). 
- Keep the main brush cleaning tools out of reach of children.
- Do not place any object (including children and pets) on the product, whether it is in operation or not.
- Do not carry the product by grabbing the main unit cover, or collision buffer.
- The product must be switched off and the plug must be removed from socket-outlet before cleaning or maintaining the product.

- Do not use wet cloth or liquids for cleaning the product.
- This product contains batteries that are only replaceable by skilled persons. Do not dismantle, repair or modify the battery or charging dock.
- The battery must be removed from the appliance before it is scrapped. 
- The product must be disconnected from the supply mains when removing the battery.
- The battery must be disposed of safely. Do not discard waste batteries. Leave them with a professional recycling organization.

SAVE THESE INSTRUCTIONS

FCC STATEMENT

⚠ WARNING: This device complies with Part 15 of the FCC Rules. Operation is subject to the following two conditions:

- This device may not cause harmful interference.
- This device must accept any interference received, including interference that may cause undesired operation.

⚠ CAUTION: Changes or modifications not expressly approved by the party responsible for compliance could void the user's authority to operate the equipment.





⚠ NOTE: This equipment has been tested and found to comply with the limits for a Class B digital device, pursuant to Part 15 of the FCC Rules. These limits are designed to provide reasonable protection against harmful interference in a residential installation. This equipment generates, uses, and can radiate radio frequency energy and, if not installed and used in accordance with the instructions, may cause harmful interference to radio communications. However, there is no guarantee that interference will not occur in a particular installation. If this equipment does cause harmful interference to radio or television reception, which can be determined by turning the equipment off and on, the user is encouraged to try to correct the interference by one more of the following measures:

- Reorient or relocate the receiving antenna.
- Increase the distance between the equipment and receiver.
- Connect the equipment into an outlet on a circuit different from that to which the receiver is connected.
- Consult the dealer or an experienced radio/TV technician for help.

FCC Radiation Exposure Statement:

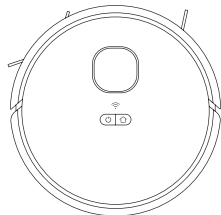
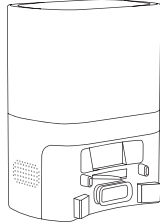
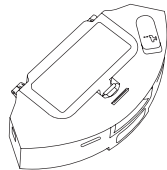
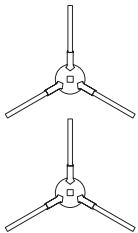
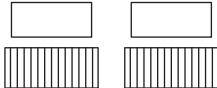
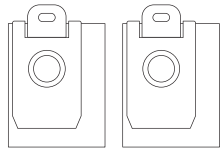
- This equipment complies with FCC radiation exposure limits set forth for an uncontrolled environment. This equipment should be installed and operated with minimum distance 20cm between the radiator & your body.

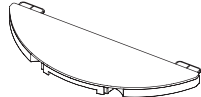
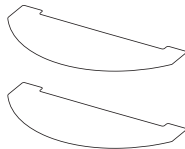
2.Packing List

 Robot Vacuum	 Dust Collection Charging Base	 2-in-1 Water Tank	 Side Brush * 2	 HEPA Filters * 2
 Dust Bag * 2	 Cleaning Tool	 Mopping Support	 Mop Cloth * 2	 User Manual

3.Product Introduction

3.1 Robot Vacuum

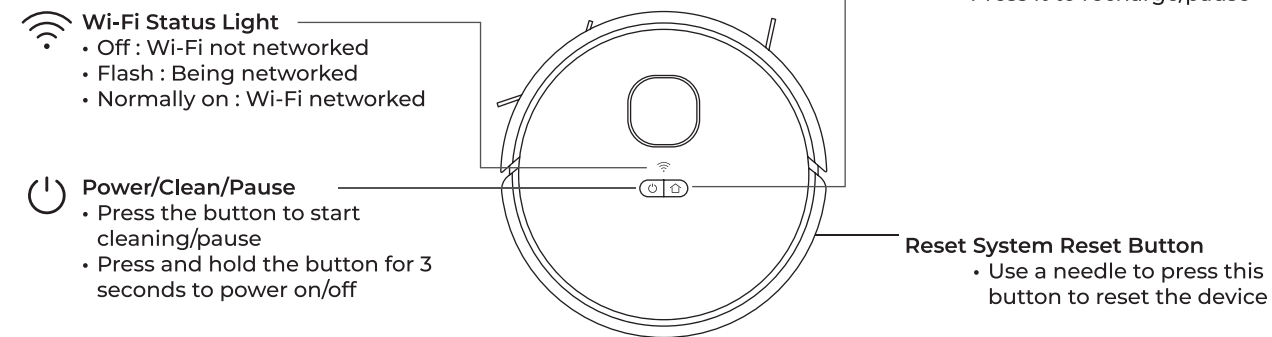

Indicator status

Status	Cleaning	Recharging	Charging	Low power	Fully charged	Alarming	Standby
Light	Blue light on	Blue light flickering quickly	Blue light flickering slowly	Red light flickering	Blue light on	Red light flickering	Off

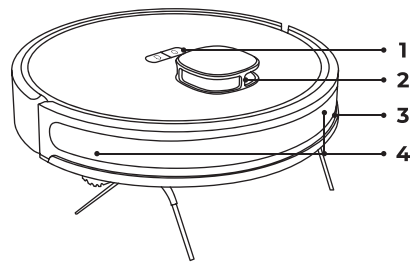

- 1. Button
- 2. Laser Radar
- 3. Bumper
- 4. Infrared Receiver Sensor

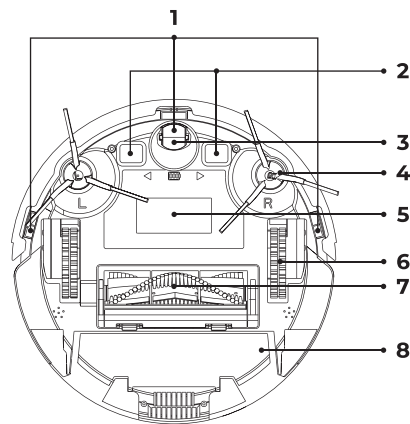

- 1. Cliff Sensor
- 2. Charging Contact
- 3. Universal Wheel
- 4. Side Brush
- 5. Battery Cover
- 6. Drive Wheel
- 7. Rolling Brush
- 8. Dust Box

3.2 Dust Collection Charging Base

Tips: One dust bag has been installed inside the dust collector.

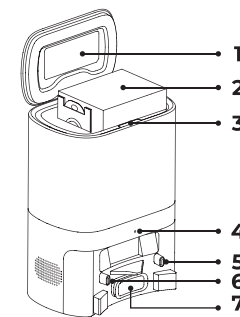

- 1. Upper Cover
- 2. Dust Bag
- 3. Opening Position
- 4. Indicator
- 5. Charging Electrode
- 6. Infrared Sensor
- 7. Vacuuming Port

3.3 2-in-1 Water Tank

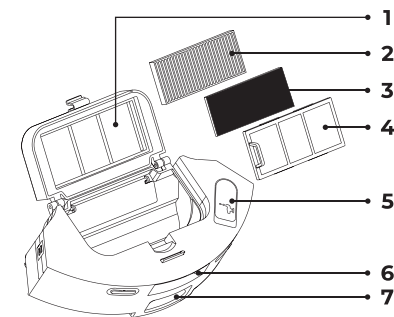

- 1. High-Efficiency Filter Cover
- 2. HEPA Filter
- 3. Sponge Filter
- 4. Primary Filter
- 5. Water Tank Plastic Plug
- 6. Dustbin Button
- 7. Dust Port

4.How to Use

4.1 Precaution

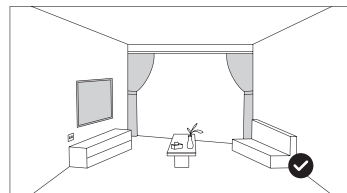
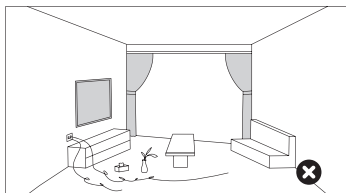

- Before starting the robot vacuum cleaner, clean up wires and sundries scattered on the ground, and remove easy-to-fall, valuable and potentially dangerous items. Avoid being entangled, stuck, dragged or knocked down by the main unit.

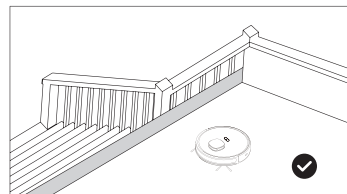
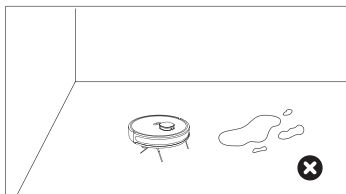

- Do not use the robot to clean the liquid.
- When used in a suspended circumstance, it shall be protected by rails to avoid accidental falling or pushing other articles from falling.

4.1.1

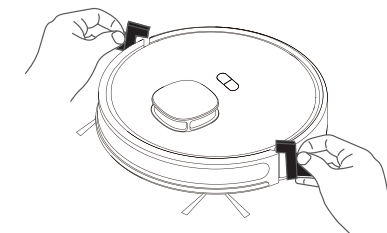

- Remove the protection material from both side of the robot.

4.1.2

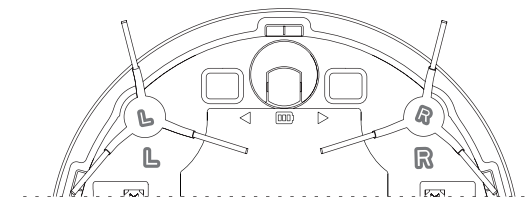

- Put the left side brush(L) and right side brush(R) against the letters L and R on the button shell respectively, press down and you will hear a “click” sound, and it means that the side brushes are installed in place.

4.1.3

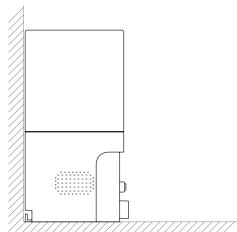

- Take out and place the dust collection charging base on a flat floor against the wall and tidy up the redundant wires.

4.1.4

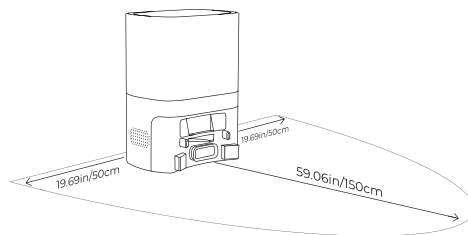

- Ensure space more than 0.5m from the left and right to the charging base and 1.5m in front of the charging base.

4.1.5

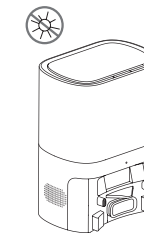

- Do not move the charging base at will, avoid direct sunlight on the charging base.

💡 Tips: The sunlight may interfere the recharging signal, which may cause the robot vacuum cleaner to fail to return to the charging base.

4.1.6

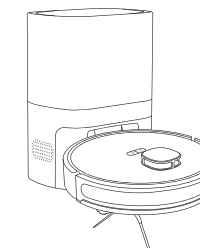

- Press and hold the  button to power on. When the indicator light is normally on, put the main unit against the charging base for charging; when you hear the voice of "Starting Charging", it means that the robot is being charged successfully.

4.2 Mopping Function

4.2.1

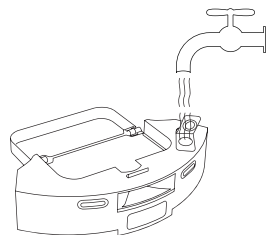

- Open the water injection cover and add appropriate amount of water and cover it up. Please do not add any detergent.

4.2.2

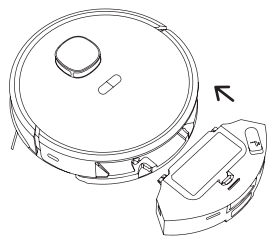

- Put the water tank back into the robot.

4.2.3

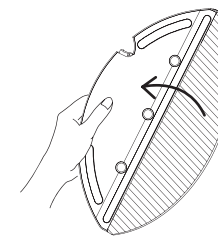

- Install the mop on the mopping support.

4.2.4

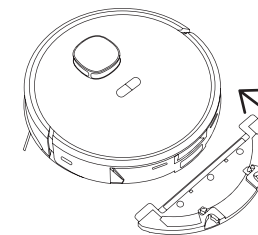

- Install the mopping support.

5.How to Download and Connect the App

5.1 Download

Scan the QR code below, download and install the App, or search for "Laresmart" App in the app store to download and install.



🍏 : Compatble with iOS 10.0 and higher.

🤖 : Compatible with Android 8.0 and higher.

5.2 Register

For the first installation, please agree to the user agreement and click "Register", and next please select "Nationality"—fill in the phone number—click" Get verification code"—"Set password"—"Finish.

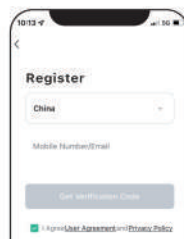

5.3 Connect to the App

(1) Choose your robot model: L6 Nex

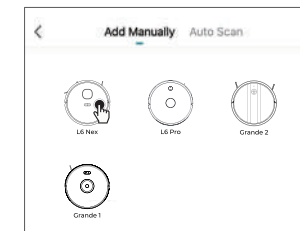

(2) Connect to 2.4GHz Wi-Fi.

💡: Make sure Wi-Fi Name and password are completely correct. Case sensitivity is required.

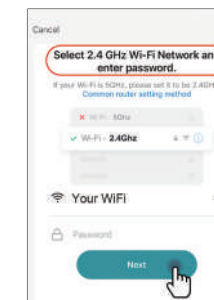

(3) Reset Wi-Fi

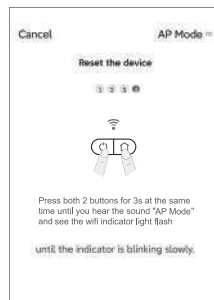

(4) Connect "Smart Life-XXXX" hotspot

💡 The Samrtlife-xxx hotspot of the robot is a virtual hotspot. After connecting, you can just directly return to the APP distribution interface and connect.

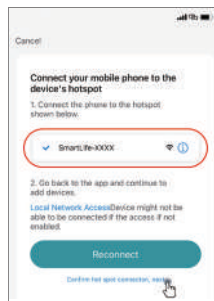

(5) Add the device

💡 For the first-time connection, it usually needs a bit longer time.

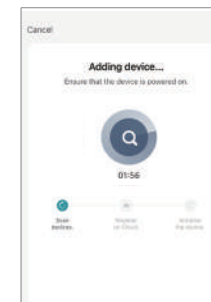

(6) Successfully connected

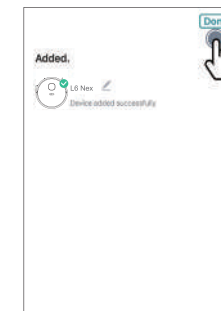

💡 Tips: You can refer to the "How to connect to App" video on Laesar Smart Cleaning Youtube channel and the product listing. Or if there is any problem, please contact us at support09@laesar.us.

Laesar Smart Cleaning Youtube Channel



6.How to Use the App

6.1 Intelligent Cleaning (Default Mode)

The robot vacuum cleaner scans the working environment, generates a map and then intelligently divides the areas. It will completely clean each area one by one by Z shape. After finishing the cleaning, the robot vacuum cleaner will return to the charging base for charging.

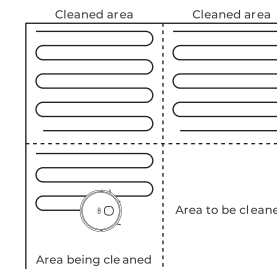

💡 Tips:

- In order to better build the map, the robot needs to start from the charging base at the first cleaning.
- Do not move the main unit randomly and frequently during operation. After moving, please put the main unit near the original place. When starting the machine again, the device will try to reposition its coordinate; after positioning successfully, it will continue to work according to the planned path; if positioning fails, the device will give up the previous task, and build a new map for cleaning, but it might fail to recharge.

6.2 Cleaning as Required

Use the Laresmart APP to select the function of cleaning as required, select a point on the map and the robot vacuum cleaner will move to the designed position and clean a 1.6m X 1.6m square area with itself as the center.

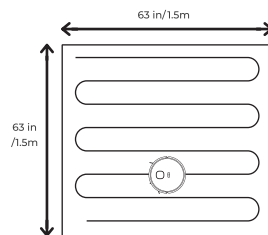

💡 Tips: Before using this function, complete building of the map for the first cleaning in the Laresmart APP.

6.3 Cleaning of Selected Area

Use the Laresmart APP to select the cleaning function of the selected area, select the area to be cleaned on the map, and the robot vacuum cleaner will clean the selected area.

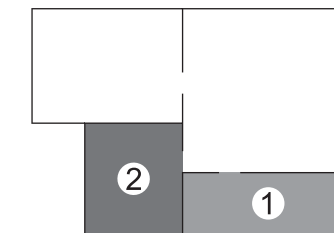

💡 Tips:

- Before using this function, complete building of the map for the first cleaning in the Laresmart APP.
- The main unit might enter the unplanned area, so please clear the obstacles on the ground around the planned area, and this area cannot play a role of safety isolation.

6.4 Cleaning of Defined Area

Use the Laresmart APP to select the function of cleaning of the defined area, select the area to be cleaned on the map, and the robot vacuum cleaner will clean the defined area.

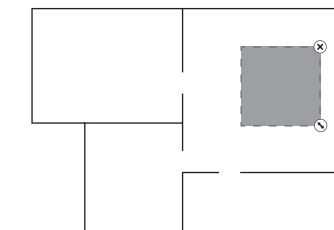

 Tips:

- Before using this function, it is needed to complete the building of the map for the first cleaning in the Laresmart APP.
- The main unit might enter the unplanned area,so please clear the obstacles on the ground around the planned area,and this area cannot play a role in safety isolation.

6.5 Restricted Area Setting

Use the Laresmart APP to select the restricted area editing function, select and set the restricted area of cleaning on the map, and the machine will not enter the set area to clean.

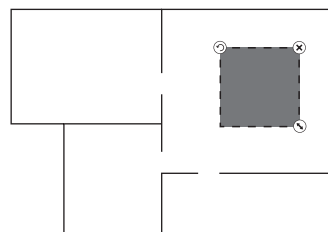

 Tips:

- Before using this function, it is needed to complete the building of the map for the first cleaning in the Laresmart APP.
- This function is only used to define the cleaning areas and cannot be used to block dangerous areas.
- When moving the robot vacuum cleaner or there are obvious changes in your home environment, the map might become ineffective and the restricted area might be lost.

6.6 Scheduled Cleaning

After the setting of scheduled cleaning takes effect, the machine will automatically start to clean at the designated time, and automatically return to the recharging base after finishing cleaning.

6.7 DND Mode

The default starting time period is 22:00-06:00, which can be modified or closed in your Laresmart APP. During the DND time period, the robot vacuum cleaner will close the functions of automatic continuous cleaning, actively playing the voice, and timing.

6.8 Other APP Functions

Remote Control	Real-time Map Updating
Look for Robot	Language Selection
Map Management	Cleaning Record Viewing
Cleaning Mode Selection	Consumables Management
Partition Area Editing	Self-Defining of Cleaning Sequence of Areas
Area Attribute Customizing	

7.Maintenance and Cleaning

7.1 Rolling Brush (Recommended cleaning frequency: once a week)

(1) Turn over the machine, press the buckle on the rolling brush cover and take out the cover plate of the rolling brush.

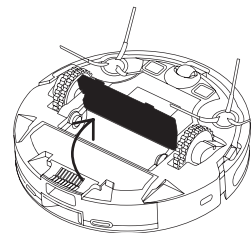

(2) Take out the rolling brush.

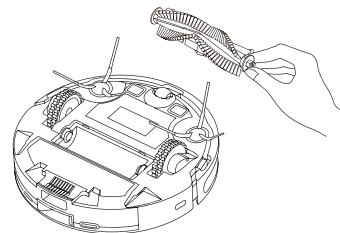

(3) Use the clean brush to remove the dust in the cavity of the main brush and rolling brush and clear the entanglements on the rolling brush.

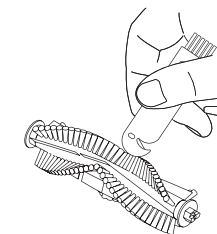

7.2 Side Brush (Recommended cleaning frequency: once a week)

(1) Turn over the machine upward and pull out the side brush vertically.

(2) Clear the entangled hairs and dirt and install back the side brush.

(3) Align shell respectively, and press them down to install back the side brush.

💡 Tips: It is recommended to replace the side brush every month to ensure cleaning effect.

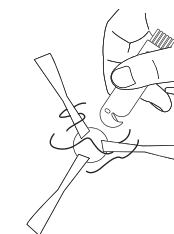
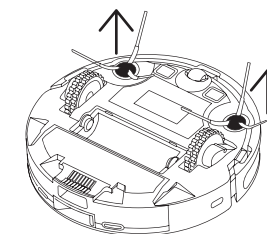

7.3 Dust Bin and Filter (Recommended cleaning frequency: after cleaning)

(1) Press the bin button and draw out the dust bin.

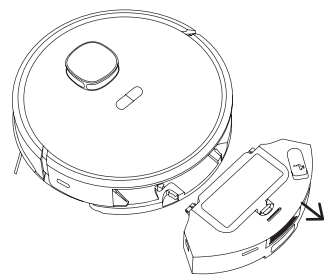

(2) Press the dust bin switch and open the dust bin to dump the rubbish.

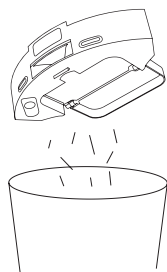

7.4 Wash the Dust Bin (Recommended cleaning frequency: once a week)

(1) After use for a long time, take down the sponge and high-efficiency filter.

(2) Flush the primary filter, dust bin, and sponge under the water tap (the high-efficiency filter cannot be washed with water)

(3) After washing, shake off the water drops, dry the filter and dust bin in the air, and they can be used only after they are completely dry.

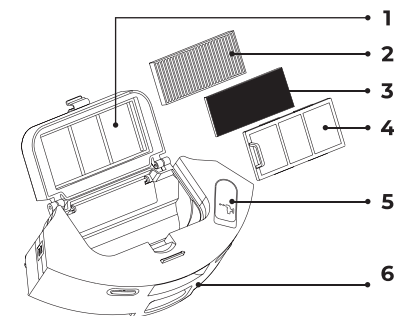

- | | |
|---------------------------------|----------------------------|
| 1. High-Efficiency Filter Cover | 4. Primary Filter |
| 2. HEPA Filter | 5. Water Tank Plastic plug |
| 3. Sponge Filter | 6. Dustbin Button |

💡 Tips:

- Wash with clear water and do not add any detergent.
- Do not use a brush but use your fingers to clean the filter.
- The filter shall be dried in the air for at least 24 hours so that it can be dried thoroughly.
- It is recommended to replace the filter every three months.

7.5 Clean the Infrared Obstacle Avoidance Sensor (Recommended cleaning frequency: once a month)

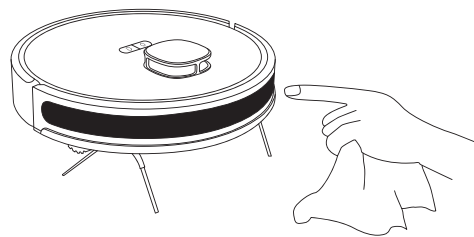

7.6 Clean the Cliff Sensor (Recommended cleaning frequency: once a month)

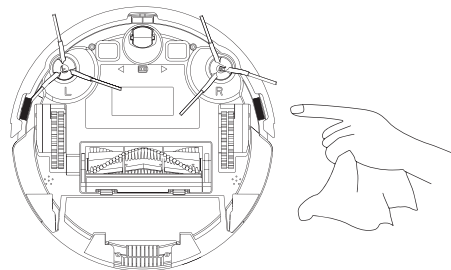

7.7 Clean the Charging Contact (Recommended cleaning frequency: once a month)

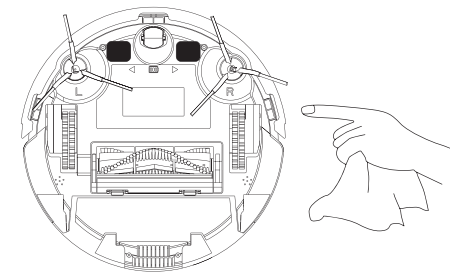

7.8 Clean the Signal Emission Region on the Auto-empty Dock (Recommended cleaning frequency: once a month)



7.9 Battery

- (1) Rechargeable high-performance lithium-ion battery pack is built in the main unit. To maintain the battery performance, please maintain the main unit in the charging state during use.
- (2) If the machine is not used for a long time, it shall be shut down for storage, and charged every three months to avoid damage to the battery due to over-discharge.

7.10 Firmware Upgrade

Enter the firmware upgrade function through the Laresmart APP. After new firmware is detected, upgrade according to the prompt guidance. The battery capacity shall not be less than 50% during the firmware upgrade. It is recommended to place the device on the charging base during the upgrade.

7.11 How to Replace the Dust Bag

- (1) Press the bin button and draw out the dust bin.



- (2) Press the bin button and draw out the dust bin.

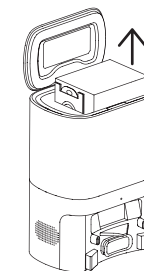

- (3) Remove the dust bag from the dock.



(4) Throw the used dust bag into the trash can.

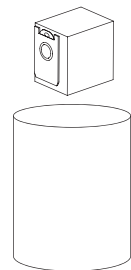

(5) Install the new dust bag into the dock and ensure that the dust bag handle is not pulled out.

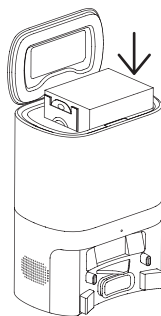

(6) After covering the Auto-empty dock, switch on the power supply.

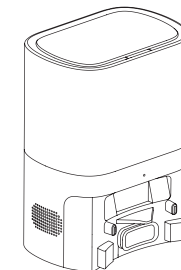

7.12 Clean the Auto-empty Dock Dust Channel

If the dock indicator blinks red after replacing the dust bag, please unplug it and reverse the dock, through the dust channel perspective window, and check whether the dust channel of the dock is blocked. If the dust channel is blocked, remove the dust channel perspective window with a screwdriver according to the following figure.

💡 Tips:

Violent disassembly is strictly prohibited. Please reinstall it after cleaning.

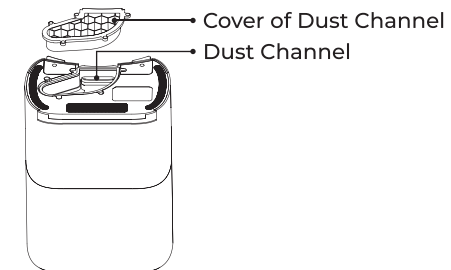

7.13 Clean the Auto-empty Dock Infrared Sensor/Charging Contact Electrodes

Gently wipe the two areas regularly with a clean, soft, dry cloth. It is recommended to clean them once a month.

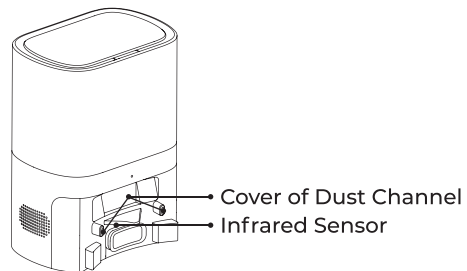

8.Specification

Robot Vacuum Cleaner Parameters

Product Name	L6 Nex Smart Robot Vacuum Cleaner
Input	19V \approx 0.6A
Rated Power	42W
Voltage	14.4V
Battery Type	Lithium ion battery pack
Battery Capacity	3200mAh
Product Dimension	320X320X93mm

Dust Collection Charging Base Parameters

Product Name	L6 Nex Dust Collection Charging Base
Output	19V \approx 1A
Rated Power	680W
Product Dimension	240X165X320mm

9.Common Problems

Problem	Solution
Failed to power on the machine	<ul style="list-style-type: none"> a. The battery power is insufficient. Please place the machine on the docking station, and align it with the charging electrode. The machine will be automatically powered on. b. The ambient temperature is below 0°C or above 40°C. Please use the machine when the ambient temperature is 0°C to 40°C
Failed to charge the machine	<ul style="list-style-type: none"> a. Move the machine away from the docking station, and check whether the indicator of the docking station is on. Make sure that both ends of the power adapter are properly connected. b. The docking station is not in proper contact with the machine. Please clean the docking station shrapnel and the charging contact on the machine or push the side brush to one side.
Failed to return to the docking station	The machine is too far away from the docking station. Try to place the machine near the docking station.
Abnormal behavior	Power off the machine and then power on again.
There is abnormal noise during cleaning job from the machine	The roller brush, side brushes, or wheels may be entangled with foreign objects. Please clean them after stopping the machine.

The cleaning performance is degraded, or ash is dropped	<ul style="list-style-type: none"> a. The filter is blocked. Clean or replace the filter. b. The dust box is full. Clean the dust box. c. The roller brush is entangled with foreign objects. Clean the roller brush
The Wi-Fi network cannot be connected.	<ul style="list-style-type: none"> a. The Wi-Fi signal is not good. Ensure that the machine is located in a place with good Wi-Fi signals. b. The Wi-Fi connection is abnormal. Reset the Wi-Fi settings, download the app of the latest version, and try to connect to the Wi-Fi network again. c. The password is incorrect. d. This machine supports only the 2.4 GHz band.
Scheduled cleaning cannot be carried out.	The power is insufficient. Scheduled cleaning will be started only when the remaining power is 15% or above.
Is any power consumed if the machine always stays at the docking station?	The power consumption is extremely low when the machine always stay at the docking station. This helps to keep the battery in the best performance.
Is it necessary to charge the battery for 16 hours when the machine is used for the first three times?	The lithium battery does not have a memory effect. It can be used instantly after it is fully charged. There is no need to wait.

10. Troubleshooting

Error	Prompt Solution
Error 1: Insert the dust bin	Cleaning is triggered when the dust bin is taken out: please reinstall the dust bin
Error 2: Put the machine on the floor before starting	You may pick up the machine or the machine is suspended: please move the machine to flat ground and start it again
Error 3: Please lay the machine flat on the ground and then start it	The machine tilts: please move the machine to flat ground and then start it
Error 4: Please check whether the front bumper is stuck	The edge or collision sensor is stuck: please push the bumper left and right to confirm that it is not stuck
Error 5: Low battery; please charge	Put the main unit on the charging base for charging
Error 6: The machine is trapped	Please move the machine to open ground and then start it
Error 7: Please check whether the wheel is stuck	The main wheel is stuck or entangled: please check the main wheel and remove the foreign objects
Error 8: Please check whether the rolling brush is stuck	The rolling brush is entangled or stuck: please check the rolling brush and remove the foreign matters
Error 9: Please check whether the side brush is stuck	The side brush is entangled or stuck: please check the side brush and remove the foreign matters

11. Warranty

The 1-Year Limited Warranty

- Your Laesar machine has a 1-year warranty against original defects in material and workmanship when used for private household purposes in accordance with the Laesar Instruction Manual.
- This warranty provides, at no extra cost to you, all labor and parts necessary to ensure your machine is in proper operating condition during the warranty period.

WHAT IS COVERED?

- According to the requirements outlined in this instruction manual, subject to the following conditions and exclusions. Only applies to purchases made from authorized retailers of Laesar.
- This warranty will only be valid if the machine is used in the country in which it was sold.

WHAT IS NOT COVERED?

Laesar shall not be liable for costs, damages, or repairs incurred as a result of:

- Machines purchased from an unauthorized dealer.
- Careless operation or handling, misuse, abuse, and/or lack of maintenance or use not in accordance with the Laesar Instruction Manual.
- The machines are used for commercial or rental purposes in addition to normal domestic use.
- Use of parts not in accordance with the Laesar Instruction Manual.

- Use of parts and accessories other than those produced or recommended by Laresar.
- External factors are unrelated to product quality and use, like accidental water damage.
- Repairs or alterations carried out by unauthorized parties or agents.
- Normal wear and tear, including Water Tank, Filter, HEPA, Main Brush, Side Brush, Power Cord (or where external damage or abuse is diagnosed), carpet or floor damage due to use not in accordance with manufacturer's.
- Instructions or failure to turn the brush roller off when necessary.
- Reduction in battery discharge time due to battery age or use.

HOW TO CLAIM?

- Please keep your proof of purchase. To make a claim under our Limited Warranty, you need to provide your original purchase receipt with the purchase date and order number on it.
- All work will be carried out by Laresar or its authorized agency.
- Any replaced defective parts will become the property of Laresar.
- Service under this warranty will not extend the period of this warranty.
- If your machine is not functioning properly, or you still have any questions after reading this manual carefully, please feel free to contact us, we will try our best to provide you with a satisfactory solution.



Email to Our Customer Service:

support09@laresar.us

Laresar is always here and waiting for you.

12. Disposal

- This product must not be disposed of as household waste. Dispose of the equipment at an authorized collection point for the recycling of electrical appliances.
- The chemicals contained in the lithium-ion battery of the product will pollute the environment. Please remove the battery before scrapping, and send it to a professional battery recycling station for centralized disposal.