

USER MANUAL

**MODEL NUMBER:
H1-(5-20)-E0**



Warning notices: Before using this product, please read this manual carefully and keep it for future reference. The design and specifications are subject to change without prior notice for product improvement. Consult with your dealer or manufacturer for details. The diagram above is just for reference. Please take the appearance of the actual product as the standard.

THANK YOU LETTER

Thank you for choosing Midea! Before using your new Midea product, please read this manual thoroughly to ensure that you know how to operate the features and functions that your new appliance offers in a safe way.

CONTENTS

THANK YOU LETTER	01
1.SAFETY PRECAUTIONS	02
2.PRODUCT INTRODUCTION	06
3.PRODUCT INSTALLATION	10
4.ELECTRICAL CONNECTION	16
5.COMMISSIONING	21
6.TROUBLE SHOOTING AND MAINTENANCE	24
7.TECHNICAL PARAMETERS	27
8.TRADEMARKS, COPYRIGHTS AND LEGAL STATEMENT	29
9.DISPOSAL AND RECYCLING	29
10.DATA PROTECTION NOTICE	30

1.SAFETY PRECAUTIONS

Outline

It describes the assembly, installation, commissioning, maintenance and failure of the energy storage system. Please read it carefully before operating.

Target Group

This document is intended for professional electrical engineers who are responsible for battery installation and commissioning, including technical support engineers, system engineers, and electrical engineers.

Symbols Used

In order to ensure the personal and property safety of users when using this product, as well as the efficient use of this product, the manual provides relevant safe operation information and highlights it with corresponding symbols. These stressed messages must be fully understood and absolutely adhered to avoid personal injury and property damage. The symbols used in this manual are listed below.

DANGER

“Danger” indicates a hazardous situation which, if not avoided, will result in death or serious injury.

WARNING

“Warning” indicates a hazardous situation which, if not avoided, could result in death or serious injury.

CAUTION

“Caution” indicates a hazardous situation which, if not avoided, could result in minor or moderate injury.

ATTENTION

“Attention” indicates there are potential risks, if fail to prevent, may lead to equipment cannot normally or property damage.

NOTE

“Note” provides additional information and tips that are valuable for the optimal operation of the product, will help you to solve a problem or save your time.

Please read the instruction carefully. Faulty operation may cause serious injury or death.

1.1 Requirement for Installation and Maintenance

The installation of the energy storage system must be in full compliance with national and local laws and regulations.

Read and understand all instructions contained in this manual and familiarize yourself with safety symbols before installing and commissioning the device.

For any maintenance or repair, please contact the nearest authorized repair center. For information about the nearest authorization center, contact your reseller. Do not repair by yourself, which may cause personal injury or property injury.

Before installing and maintaining the device, disconnect the device from the external device using the DC switch. Otherwise, the high voltage may cause serious injury.

Installation and Maintenance Personnel Requirements

The personnel responsible for installation and maintenance of the equipment for the first voyage must first receive strict training, understand various safety precautions and master correct operation methods.

- Only qualified professionals or trained personnel are allowed to install, operate, and maintain the device.
- Only qualified professionals are allowed to remove safety facilities and repair devices.
- The personnel, including the operators, trained personnel, and professional personnel, who operate the equipment should have the special operation qualification required by the local state, such as the qualification of high voltage operation, height climbing, and special equipment operation.
- Only professional or authorized personnel can replace equipment or components (including software).

NOTE

- Professional personnel: those who have the training or operation experience of equipment and are able to understand the potential sources and magnitude of hazards in the process of equipment installation, operation and maintenance.
- Trained personnel: personnel who have received the appropriate technical training and have the necessary experience are aware of the risks that may be posed to them in performing a certain operation and can take measures to minimize the risks to themselves or other personnel.
- Operators: operators who may have access to the equipment except trained and professional personnel.

Transportation Requirement

The batteries are in the good electrical and physical condition when they ship out from factory. During transport, the energy storage module must be placed in its original package or other proper package. Transportation Company should be responsible for any damage during transport period. Please check the battery thoroughly when taking delivery. If you find any packing problems that may cause the damage of battery or any visible damage, please notice the responsible transportation company immediately. You can ask your installer for help is necessary.

This product contains energy storage module through UN38.3, belongs to the ninth category of dangerous goods. Therefore, loading and unloading must comply with local laws and regulations and industry standards during transportation. Rough loading and unloading may cause short circuit or damage to batteries in containers, which may result in battery leakage, breakage, explosion, or fire.

1.2 Description of Safety Information Symbols

DANGER





High voltage of the product may be harmful to health! Only certified engineer can operate the product; Juveniles, Disable, should not use this product; Keep this product out of the reach of children;

ATTENTION

The product should be grounded in accordance to the requirements of the local electrical grid company.

Sings on the Product

The product carries a number of safety related labels. Make sure to read and understand the labels carefully before installing the device.

Symbols	Name	Description
	This is a residual voltage in the product	There is a high voltage, when the product is powered on. After the product is powered off, the internal capacitor is still charged, operator should wait for 5 minutes to ensure the capacitor is completely discharged.
	Caution of high voltage and electric shock	The product operates at high voltages. Prior to performing any work on the product, disconnect the product from voltage sources. All work on the product must be carried out by qualified persons only.
	Caution of hot surface	The product can get hot during operation. Avoid contact during operation.
	Grounding Terminal	Connect the product to the ground bar for grounding protection
	Observe the documentation	Read all documentation supplied with the product before install

2.PRODUCT INTRODUCTION

2.1 System introduction

The energy storage system is mainly composed of energy storage module and bidirectional DC/DC unit. The input and output voltages are high DC voltage. The system adopts modular design and stacked installation method. The capacity can be flexibly configured based on actual requirements. Capacity range is one stack of 5-20kWh, up to 2 stacks in parallel.

Battery system monitoring is achieved via communication with the inverter through RS485. The inverter connects to the network via Wi-Fi, enabling monitoring through the web portal and/or app.

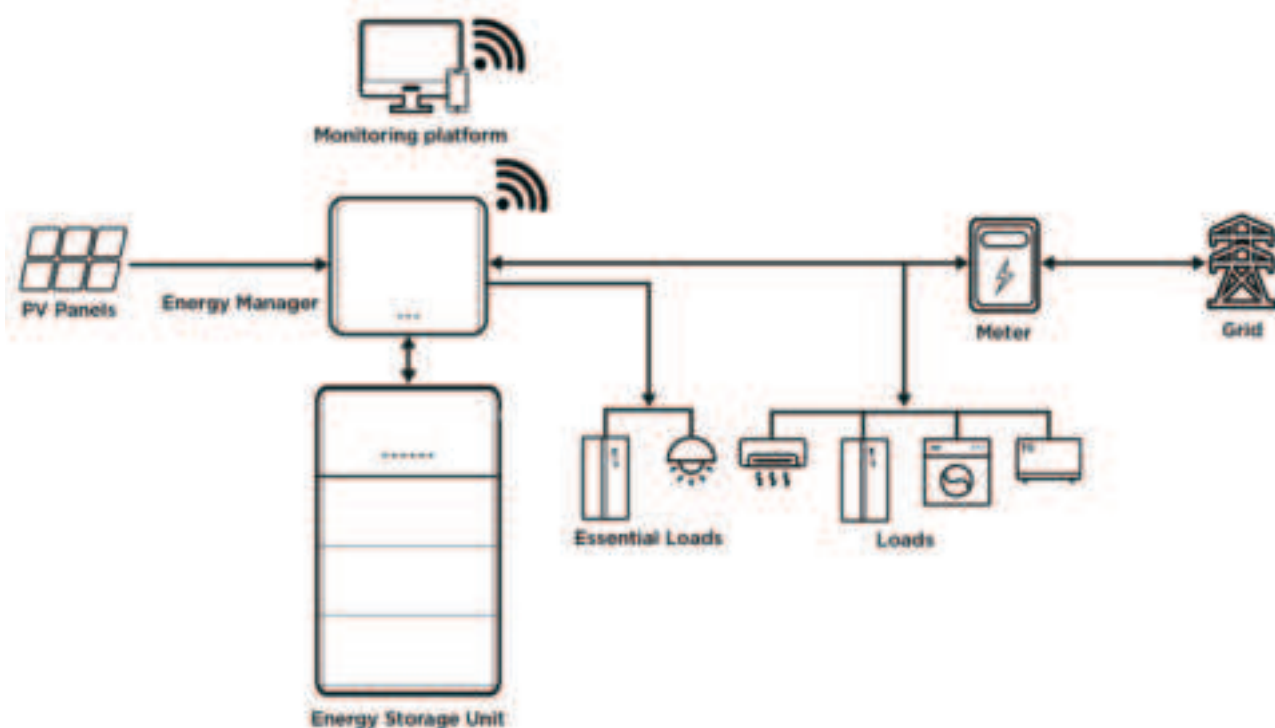
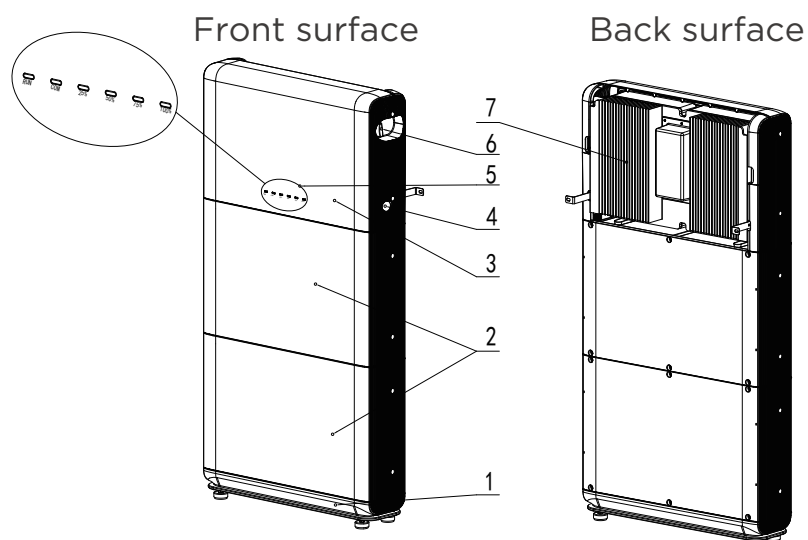

Figure.2-1 Energy storage system application principle diagram

2.2 Product Appearance

System appearance



1	Base	2	Energy storage module
3	Bidirectional DC/DC unit	4	Side cover
5	LED indicator	6	DC switch
7	Heat sink		

Bidirectional DC/DC unit appearance

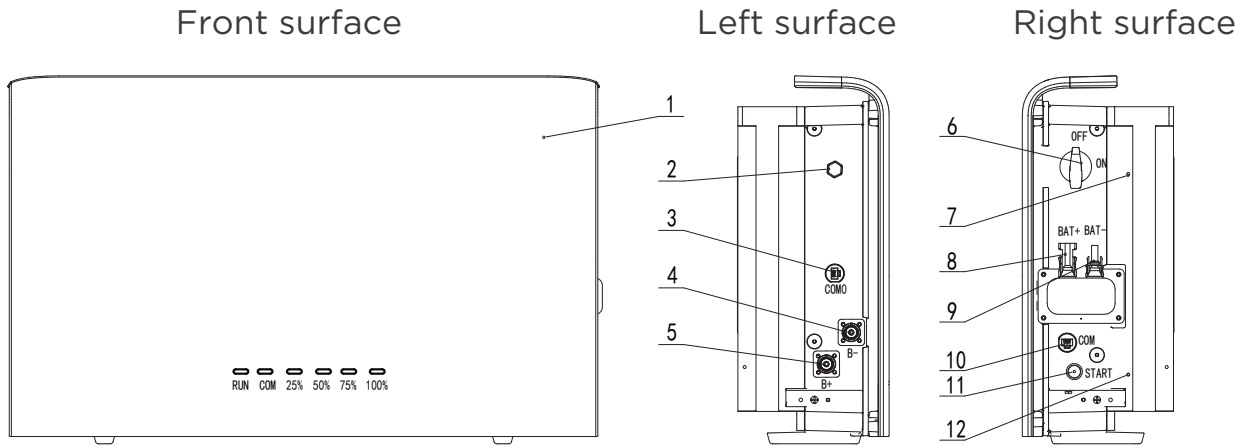

1	Bidirectional DC/DC unit	2	Ventilation valve
3	Input communications port	4	BAT cascading terminal(B-)
5	BAT cascading terminal(B+)	6	DC switch
7	Grounding hole	8	BAT output terminal(BAT+)
9	BAT output terminal(BAT-)	10	Output communications port
11	Black startup switch	12	Grounding hole

Energy storage module appearance

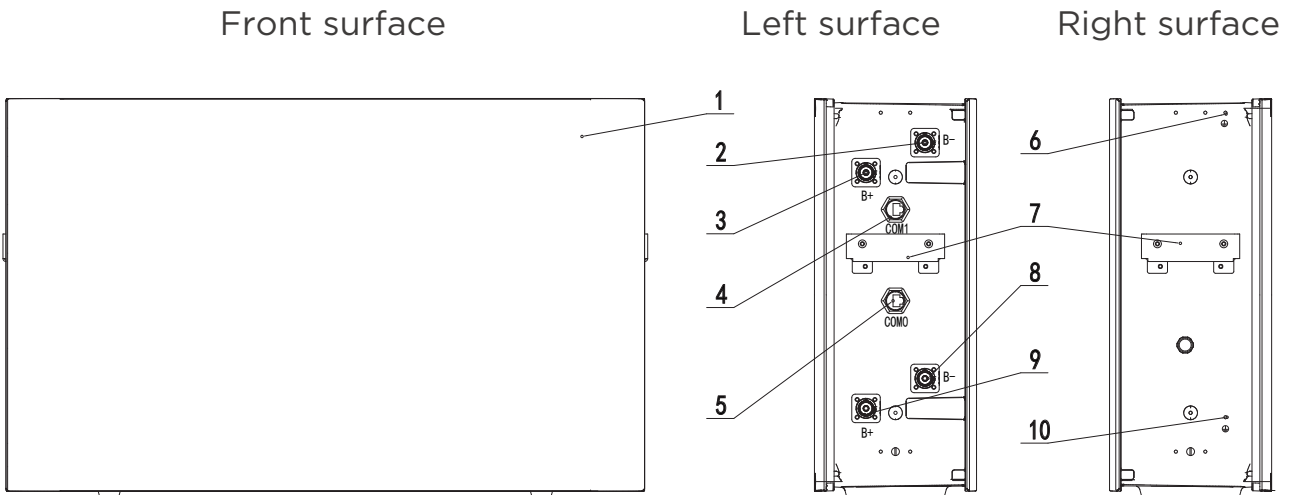

1	Energy storage module	2	BAT cascading terminal(B-)
3	BAT cascading terminal(B+)	4	Output communications port
5	Input Communications port	6	Grounding hole
7	Side handle	8	BAT cascading terminal(B-)
9	BAT cascading terminal(B+)	10	Grounding hole

2.3 Indicator lights description

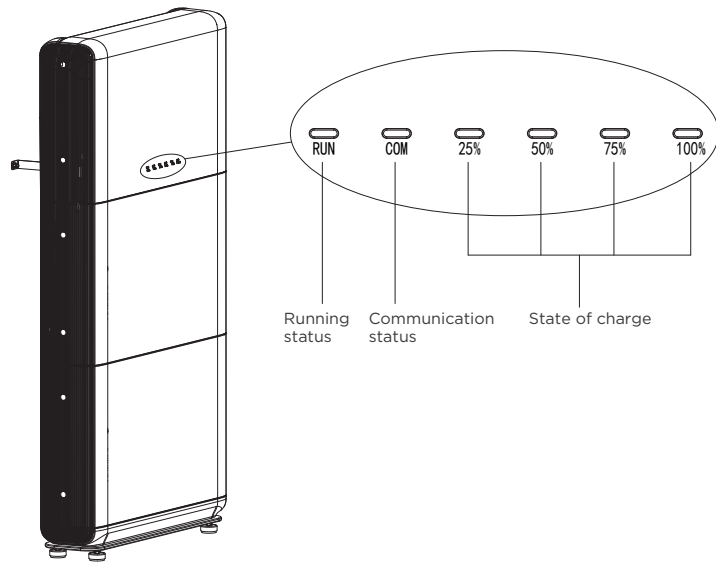
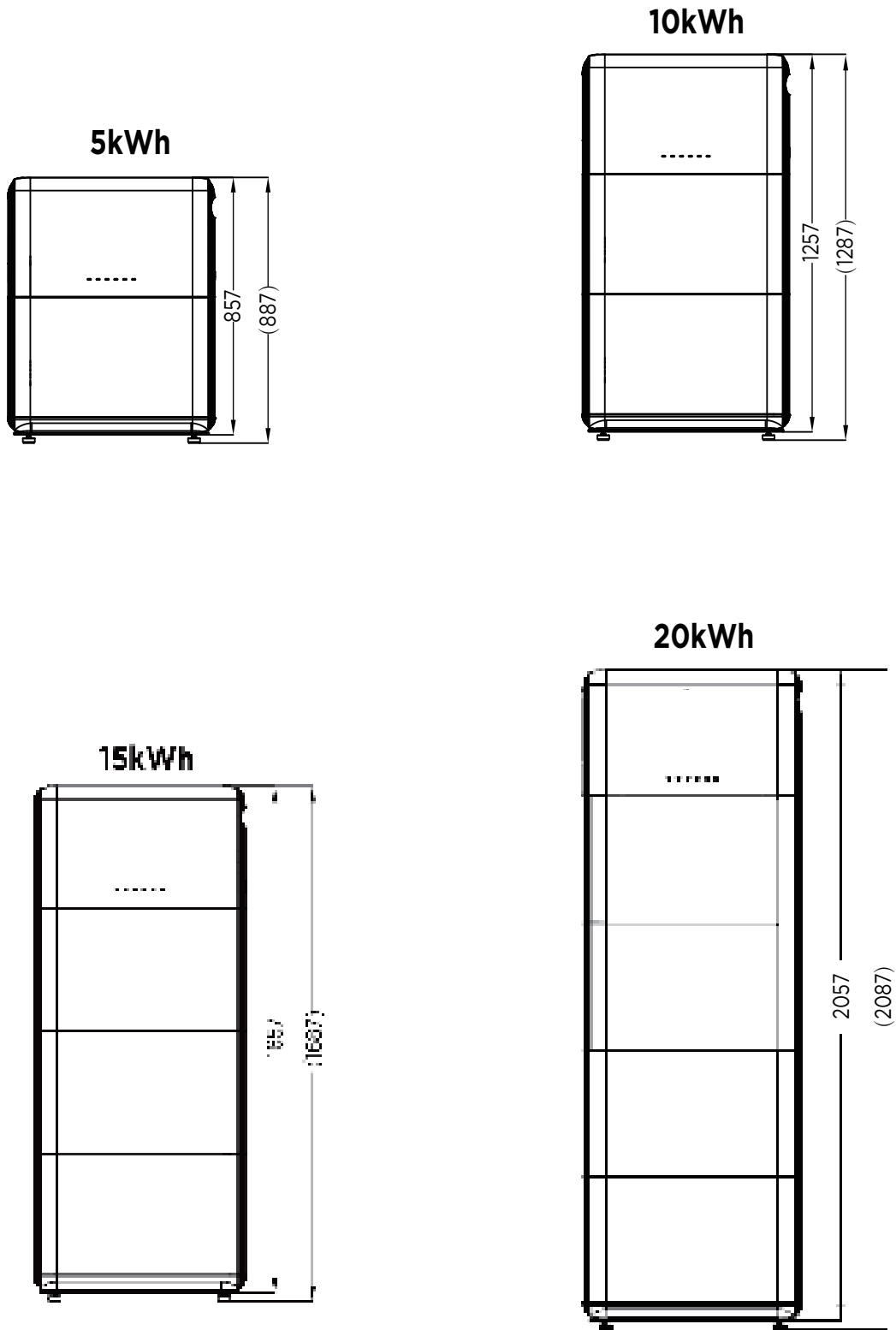

Table 2-1 LED flashing definition

INDICATOR	COLOR	STATUS	EXPLANATION
RUN	Green	Steady on	System is power-on
	Red	Steady on	Fault
	-	Off	System is power-off
COM	Green	Steady on	Communication is normal
	Green	Blinking at long intervals (on for 0.2s and then off for 0.2s)	No communication with BMS
	Green	Blinking at long intervals (on for 1s and then off for 1s)	System is power-on
	-	Off	No communication with inverter and BMS
25%/50% /75%/100%	Green	Steady on	Battery level is in this range
	Green	Blinking at long intervals (on for 0.2s and then off for 0.2s)	Battery is discharging in this range
	Green	Blinking at long intervals (on for 1s and then off for 1s)	Battery is charging in this range
	-	Off	Battery level has not reached this range

2.4 System capacity expansion description

The energy storage system supports capacity expansion. Up to four battery modules are managed by one power module. The expandable capacity of the single-cluster battery system ranges is 5kWh ~ 20kWh.



3.PRODUCT INSTALLATION

⚠ DANGER

Do not install batteries on flammable materials. Do not install batteries in places where flammable or explosive materials are stored.

⚠ CAUTION

The enclosures and fins are very hot when bidirectional DC/DC unit is operated, so do not install energy storage systems where you may inadvertently come into contact with them.

ATTENTION

Consider the weight of the energy storage module when transporting and moving it. Select suitable mounting position and surface. At least two persons are required to install energy storage modules.

💡 NOTE

Before installation, Battery Management System (BMS) enters sleep mode, and all battery terminals remain de-energized. The battery is exclusively activated by the bidirectional DC/DC unit. During the installation process, the terminals of the battery module remain in a de-energized state.

3.1 Checking Before Installation

Checking Outer Packing Materials

Packing materials and parts can be damaged in transit. Therefore, check the packing materials of the product before installing them. Check whether the outer packing materials are damaged, such as holes and cracks. If any damage is found, please do not open the package and contact the distributor as soon as possible. It is recommended that you remove packing materials within 24 hours before installation.

Checking Packing List

After the energy storage modules and bidirectional DC/DC unit are unpacked, check whether the packaging and accessories are intact. If any damage is found or any components are missing, contact the distributor.

Table 3-1 Components and mechanical parts to be delivered for energy storage modules

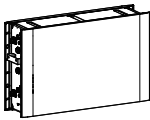
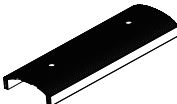
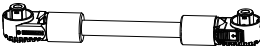
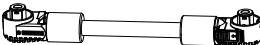
No	Pictures	Description	Quantity
1		Energy storage module	1pcs
2		Protective cover	2pcs
3		Battery power cable B+ (Red)	1pcs
4		Battery power cable B- (Black)	1pcs















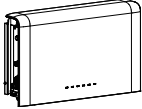

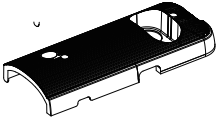

No	Pictures	Description	Quantity
5		Battery communication cable	1pcs
6		Side connector	2pcs
7		SEM screws M4*10	12pcs
8		Ground cable	1pcs
9		Warranty card	1pcs
10		Quality certificate	1pcs
11		Packing list	1pcs

Table 3-2 Components and mechanical parts to be delivered for bidirectional DC/DC unit

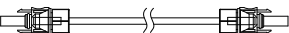
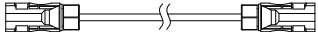
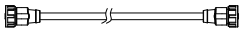
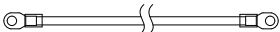

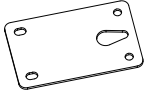

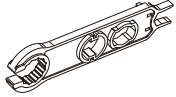

No	Pictures	Description	Quantity
1		Bidirectional DC/DC unit	1pcs
2		Left protective cover	1pcs
3		Right protective cover	1pcs
4		Base	1pcs
5		Heavy duty leveling screw leg	4pcs
6		base protective cover	2pcs
7		Y Connectors BAT+ (Optional, additional packaging)	1pcs
8		Y Connectors BAT- (Optional, additional packaging)	1pcs
9		Battery power cable BAT+ (Red)	1pcs
10		Battery power cable BAT- (Black)	1pcs
11		Battery communication cable	1pcs
12		Ground cable	1pcs
13		SEM screw M4*10	16pcs



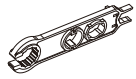

14		Expansion bolt M6*60	2pcs
15		Side connector	2pcs
16		Anti-tip bracket	2pcs
17		D4 Disassembly tool	1pcs
18		Quick guide	1pcs
19		Packing list	1pcs
20		User manual	1pcs
21		Delivery inspection report	1pcs
22		Quality certificate	1pcs
23		Warranty card	1pcs

3.2 Preparation for Installation Tools

Prepare tools for installation and electrical connections.

Table 3-3 Tools required for installation and electrical connections

NO	Tool	Model	Function
1		Hammer drill Recommend Drill @ Φ8mm	Used to drill holes on the wall
2		4mm Screw driver	Remove and install screws and wires
3		D4 Disassembly tool (Provided with the product)	Remove the output terminal of the bidirectional DC/DC unit and inverter
4		Sleeve	Install fixed support rack
5		Multi meter	Check whether the cable connection is correct, the positive and negative terminals of the battery are correct, and the grounding is reliable
6		Marker	Mark signs
7		Measuring tape	Measure distance

8		Level	Ensure that the base is level
9		ESD gloves	Installer wear when installing product
10		Safety goggle	Installer wear when drill holes
11		Mask	Installer wear when drill holes

3.3 Installation Environment

Before installation, determine the proper position for installing the energy storage system. The following requirements must be met:

- Choose a dry, clean, neat and convenient location for installation.
- Ambient temperature: $-20^{\circ}\text{C}\sim 55^{\circ}\text{C}$; recommended temperature: $-10^{\circ}\text{C}\sim 50^{\circ}\text{C}$.
- Relative humidity: 5%-95% (non-condensing).
- The product should be placed in a well-ventilated place.
- There are no inflammable and explosive objects near the installation position of the product.
- The highest altitude of the installation environment is 2000m.

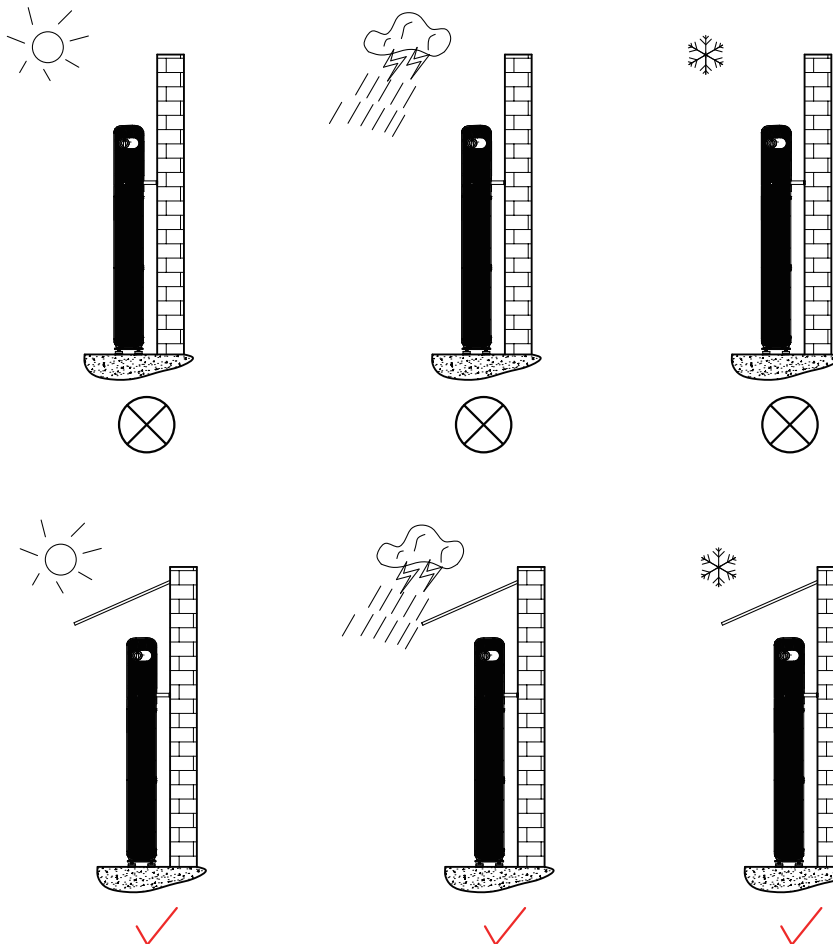

NOTE

- The operation and service life of the battery depend on the operating temperature. Install the battery at a temperature equal to the ambient temperature or in a better environment.
- The operating temperature of the battery system ranges from -20°C to $+55^{\circ}\text{C}$. If the battery system is installed in a cold environment, the built-in thermal control system starts to heat the battery to achieve better performance. The heating process consumes rechargeable power, which reduces the system energy efficiency in cold weather.
- If the battery system is stored in a cold environment (for example, 0°C) before installation, the battery system needs some time ($< 2\text{ h}$) to heat up before it can be charged. You are advised to place the battery system in a warm place before installation to facilitate commissioning.

3.4 Installation Space

To ensure sufficient space for installation and heat dissipation, reserve enough space around the energy storage system. The requirements are as follows:

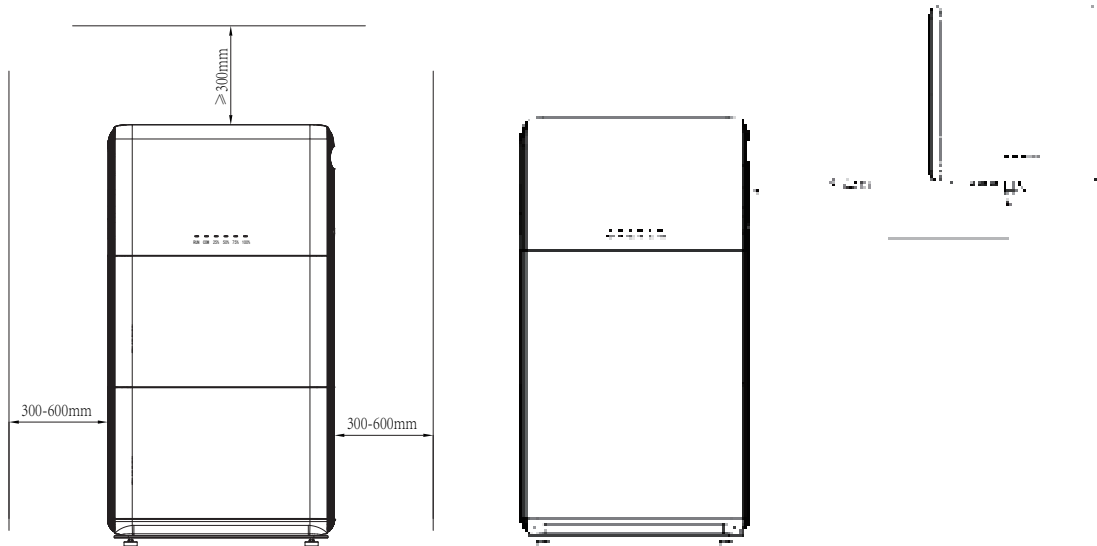

3.5 Energy Storage System Installation

Step1: Base installation

Install the four foot cups under the base, align the base with the wall, and ensure that the base is 77mm-92mm away from the wall surface. Adjust the four foot cups of the base until it is level.

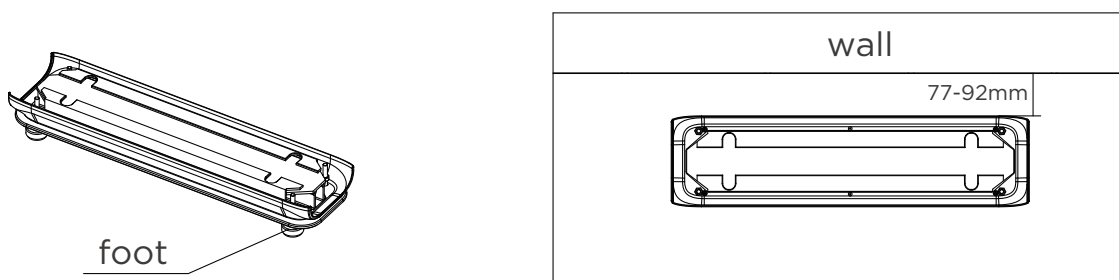
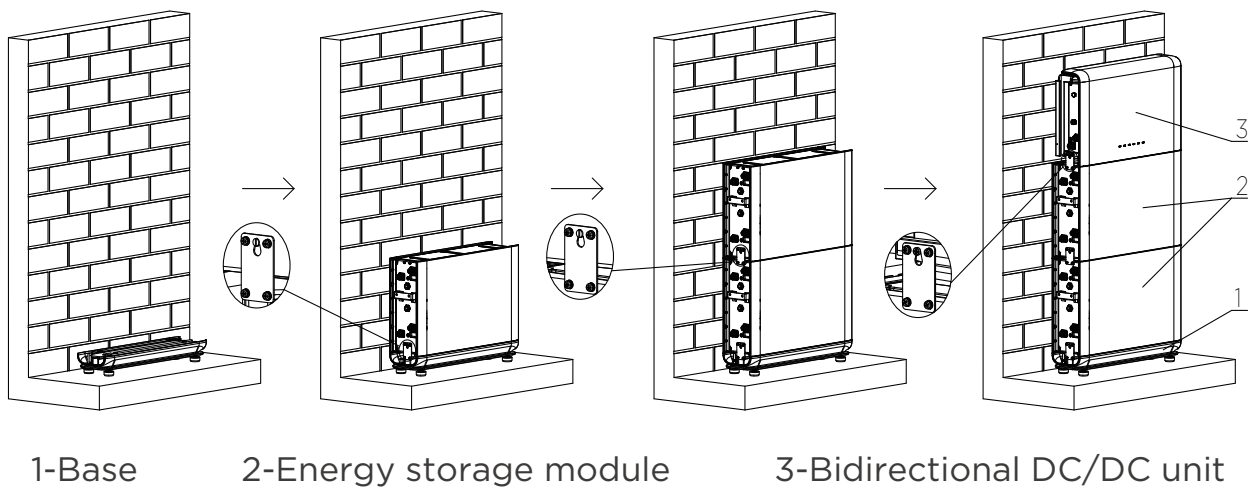

Figure. 3-1 base installation diagram

Step 2: Installing the energy storage modules and bidirectional DC/DC unit

Align the first energy storage module on the base, install the connectors on both sides, and tighten the 8 screws on both sides. Install the remaining energy storage modules and bidirectional DC/DC unit from bottom to top.



1-Base 2-Energy storage module 3-Bidirectional DC/DC unit
Figure.3-5 Installing the energy storage and bidirectional DC/DC unit diagram

STEP 3: Installing expansion bolts

Determine the drilling position according to the fixed position of the Anti-tip bracket, and mark the positions using a marker. And then drill holes and install expansion bolts.

NOTE

The expansion bolts delivered with the battery are mainly used for solid concrete walls. If other types of walls are used, ensure that the walls meet the loadbearing requirements (one energy storage module weighs 52kg) and select the bolts by yourself.

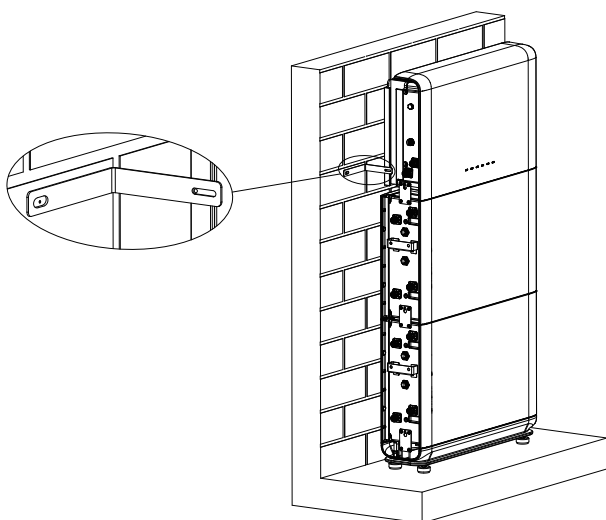

Figure.3-6 Marking the tracing position

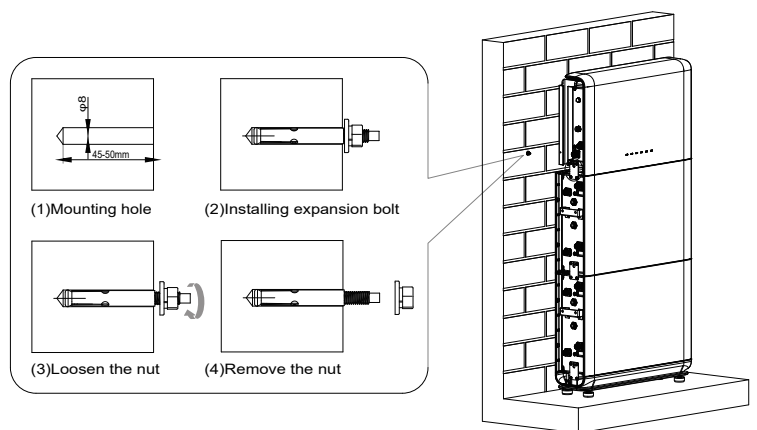
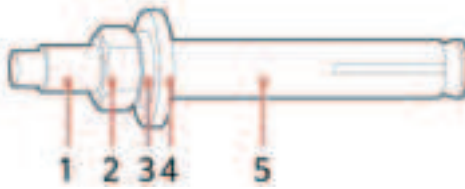

Figure.3-7 Expansion bolts installation



(1) Bolt (2) Nut (3) Spring washer (4) Flat washer (5) Expansion sleeve

Figure.3-4 M6 expansion bolt structure diagram

Step 4: Anti-tip bracket installation

Secure the bidirectional DC/DC unit to the wall.

⚠ WARNING

The bidirectional DC/DC unit must be fixed on the wall.

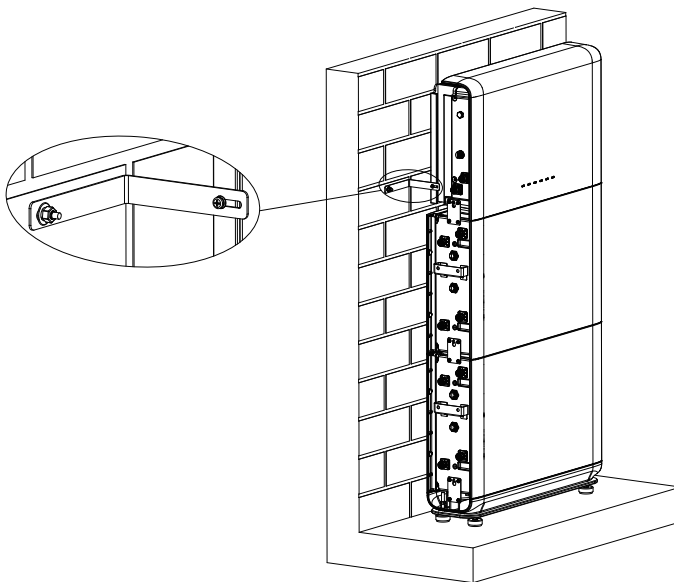

Figure.3-6 Installing the Anti-tip bracket diagram

4.ELECTRICAL CONNECTION

This product is used for battery energy storage PV system. Equipment can be damaged if not used as intended.

ATTENTION

Only professional electrical engineers can install and maintain batteries. When making electrical connections, wear rubber gloves and protective clothing. When connecting the device electrically, you must first connect the protection ground cable. When removing a device, ensure that the PGND cable is removed at last.

⚠ DANGER

Before electrical connection, ensure that the DC switch of the bidirectional DC/DC unit is OFF, the running status LED is OFF, and the energy storage module has no output voltage.

💡 NOTE

The equipment damage caused by operator's wrong wiring is not covered by the product warranty.

4.1 WIRING CONNECTION

Step1: Protection grounding cable connection

Connect the ground points of modules in sequence, and secure the ground cable using a ground screw.

⚠ DANGER

- Connect cables in accordance with local installation laws and regulations.
- Before connecting cables, ensure that the DC switch on the battery and all the switches connected to the battery are set to OFF. Otherwise, the high voltage of the battery may result in electric shocks.
- For safety consideration, it is suggested that a reliable lock be used to lock the switch. When the switch is in OFF gear, turn the switch counterclockwise to approximately 15° to the end and push the slide button towards the screw to lock the switch. The DC switch padlock needs to be prepared by the customer. Select a padlock based on the lock hole diameter ($\Phi 6$ mm) to ensure that the padlock can be installed smoothly. (Australia)

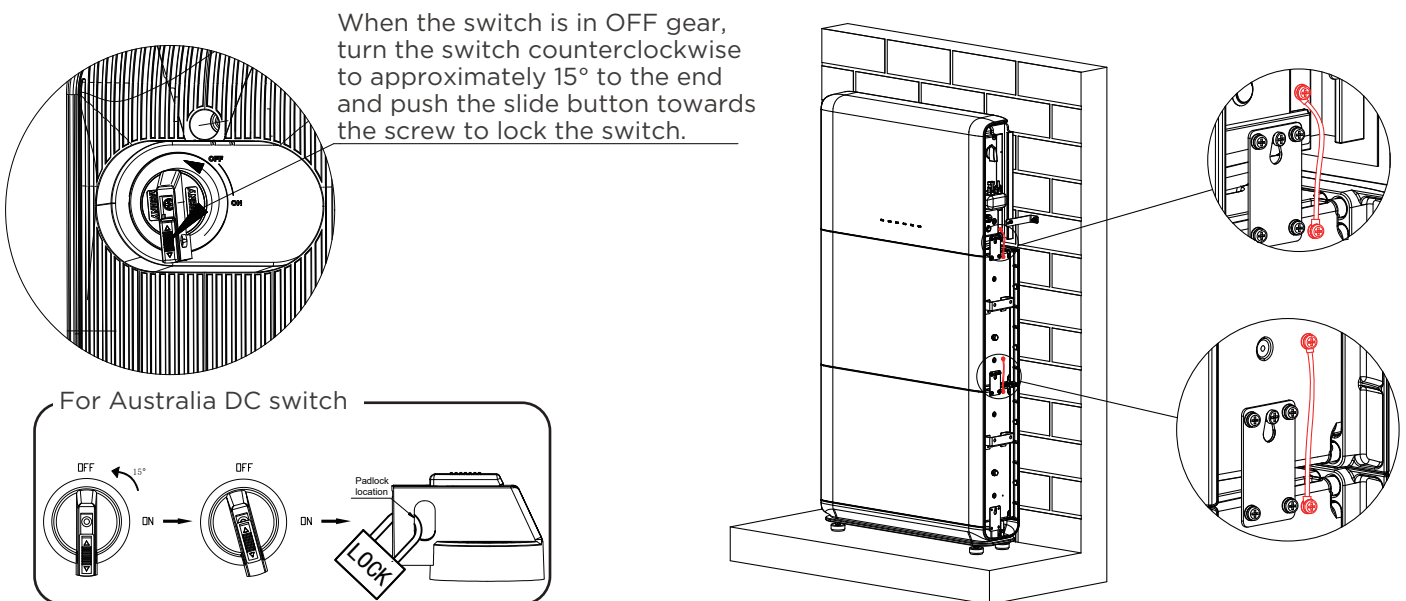

💡 NOTE

After installation, the DC switch of the bidirectional DC/DC unit can physically disconnect the DC/DC unit from the inverter, thus eliminating the risk of external electric shock through Dual-pole isolation.

Step2:Installing internal DC terminals

Insert the positive and negative connectors delivered with the battery into the positive and negative battery cascading terminals (B+ and B-).

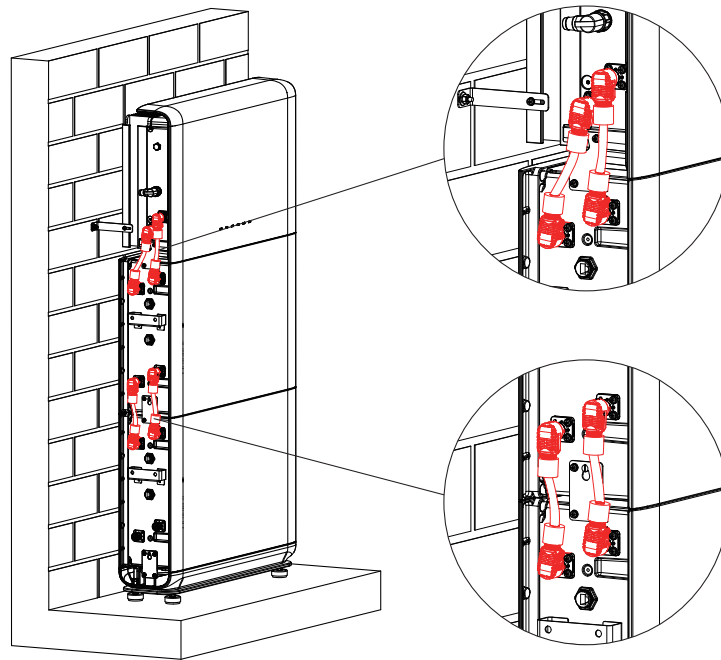

Step3:Connecting internal communication cables

Connecting communication cables between the bidirectional DC/DC unit (COM0) and energy storage modules (COM1).

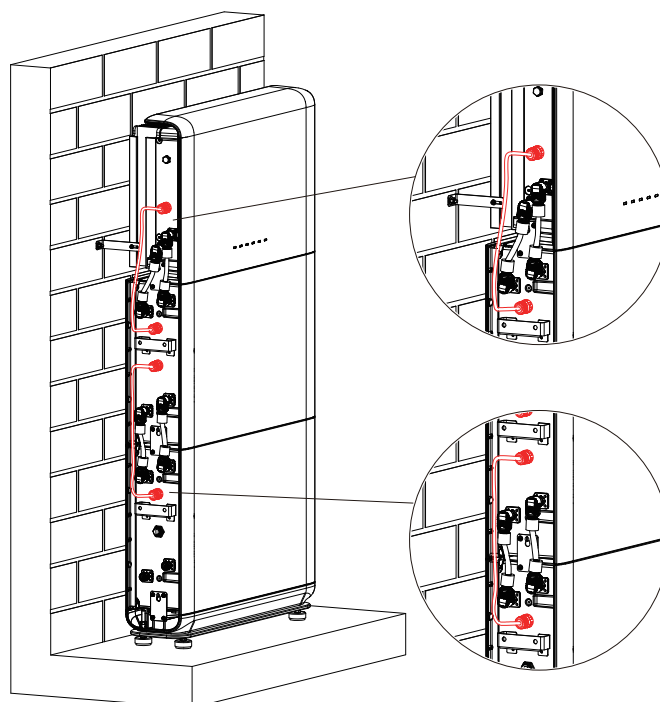

Step4: External electrical connection

Connect the bidirectional DC/DC unit Com Terminal to the inverter BMS port for communication between inverter and energy storage system. The following is an example of the storage inverter:

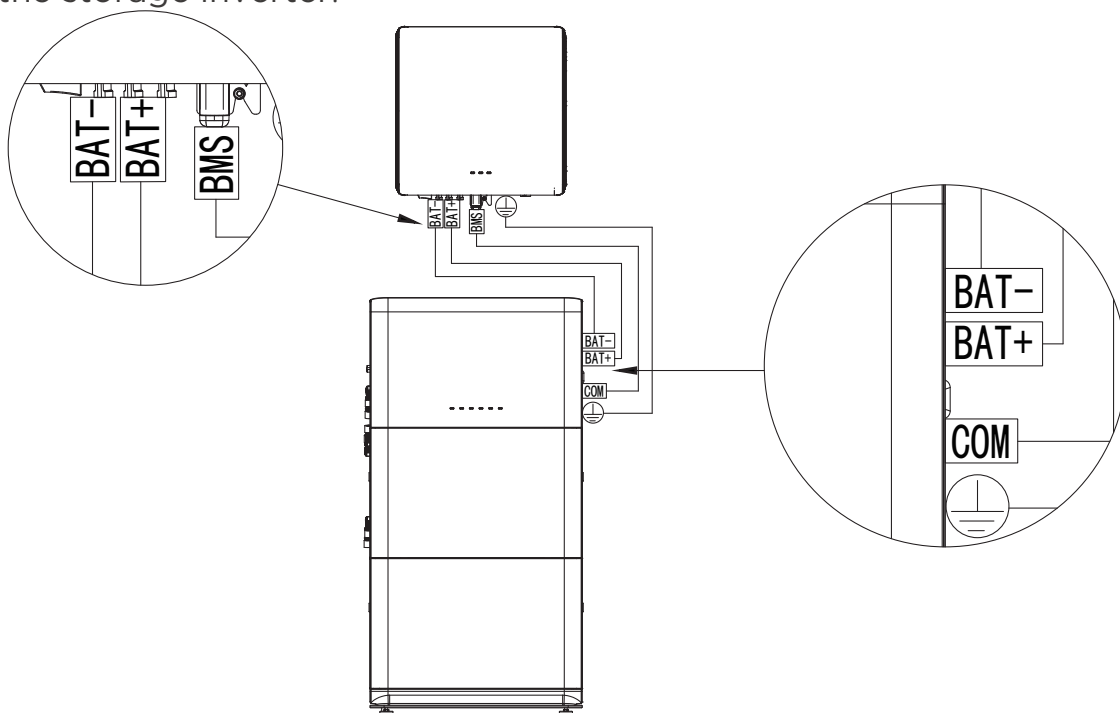

Connection of a grounding cable

1. Remove the insulation of the cable. For outside use, cables of $\geq 4\text{mm}^2$ are recommended for Grounding).

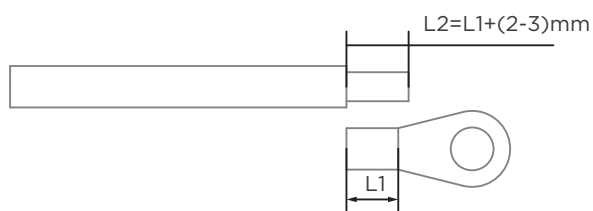

2. Crimp the cable to the ring terminal:

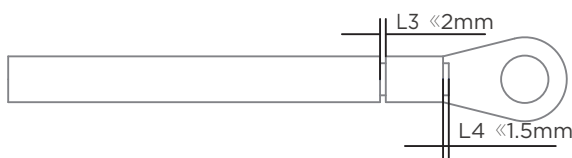

3. Install the crimped ring terminal and the washer with M4 screws and tighten these with a torque of 1.5 Nm using an Allen key.

Cascading Batteries (Optional)

Battery Cascading Cable Connection

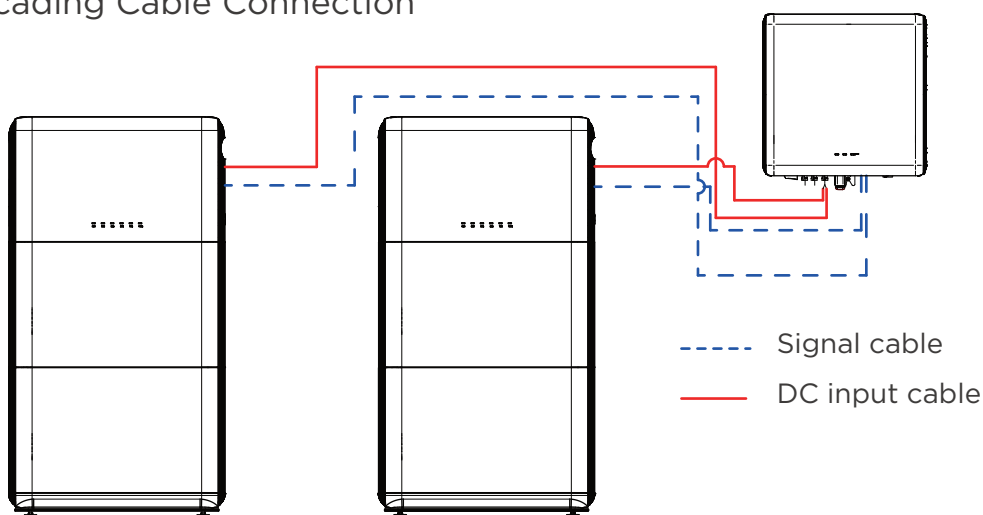

Connecting Cascading DC Input Power Cables (Cascading)

Use Y connectors to connect the DC input terminals (BAT+ and BAT-) between the power control module and the inverter.

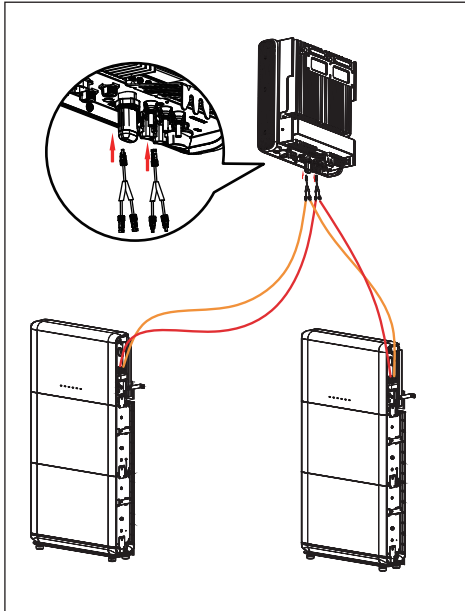

Connecting a Signal Cable

Prepare a signal cable terminal for connecting the power control module.

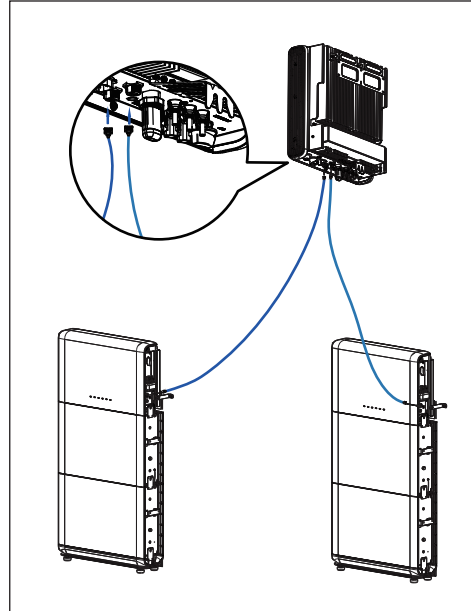

Step5: Install the protective cover

After electrical connections are complete and cable connections are correct and reliable, install the external protective cover.

- Assemble the base protective cover and battery protective cover together.
- Install protective covers on both sides of the energy storage module and the battery module.
- Tap the corners of the protective cover to ensure it is in place before locking the screws.

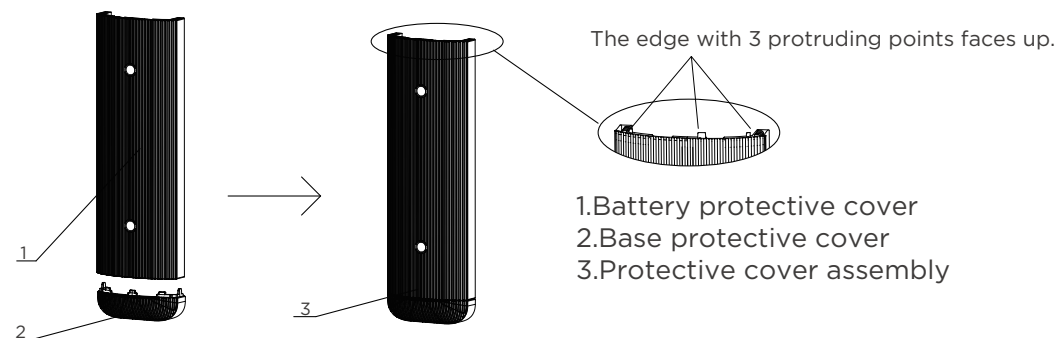

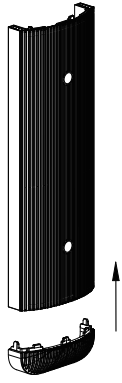

1. Assemble the base protective cover and battery protective cover together.

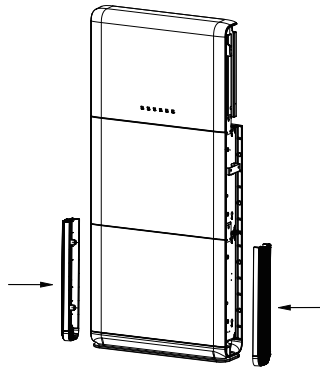

2. Install the base protective cover and battery protective cover on the battery module body.

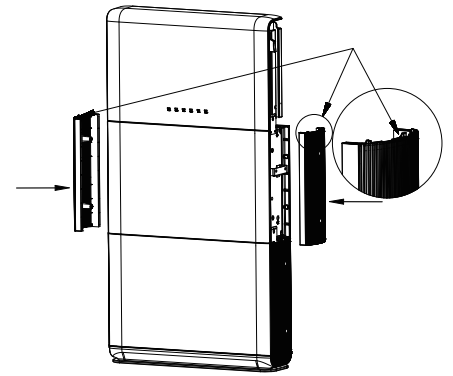

3. Install the battery protective cover on the battery module body, The edge with 3 protruding points faces up.

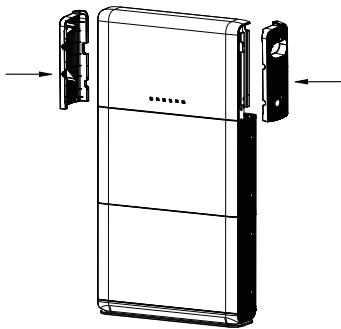

4. Install the protective cover of the energy storage module on its body.



5. Tap the corners of the protective cover to ensure it is in place before locking the screws.

5.COMMISSIONING

5.1 Double Check

Please double check the following items before running:

- Energy storage, bidirectional DC/DC unit and the base should be completely fixed. Each BAT+/BAT- line is firmly connected, the polarity is correct, and the voltage is in line with the accessible range.
- The DC switch of the bidirectional DC/DC unit is OFF, and the running status LED indicator is OFF.
- Ensure that the communication cable is firmly connected to the terminal resistor.
- Install sealing plugs on unused terminals or interfaces.
- Cable is arranged reasonably, and the cable is tidy and without damage.

5.2 Electrify for the First Time and Start up

• Make sure the device you wish to connect to is powered on. Please follow these instructions carefully to perform the four power-on steps:

Step 1 Power on the batteries. Turn the DC switch on the bidirectional DC/DC unit to ON, then press and hold the start button for 5 seconds.

Step 2 Turn the PV switch between the inverter and the PV panels to ON.

Step 3 Turn the AC switch between the inverter and the grid to ON. Observe the “COM” LED indicator on the bidirectional DC/DC unit is lighted, “DC” and “AC” LED indicator on the inverter are lighted.

Step 4 Start Operation. After power on the system, turn on the EMS by tapping "Maintenance" in the goMslar App and turning on the "EMS on/off" switch. Confirm the startup begins.

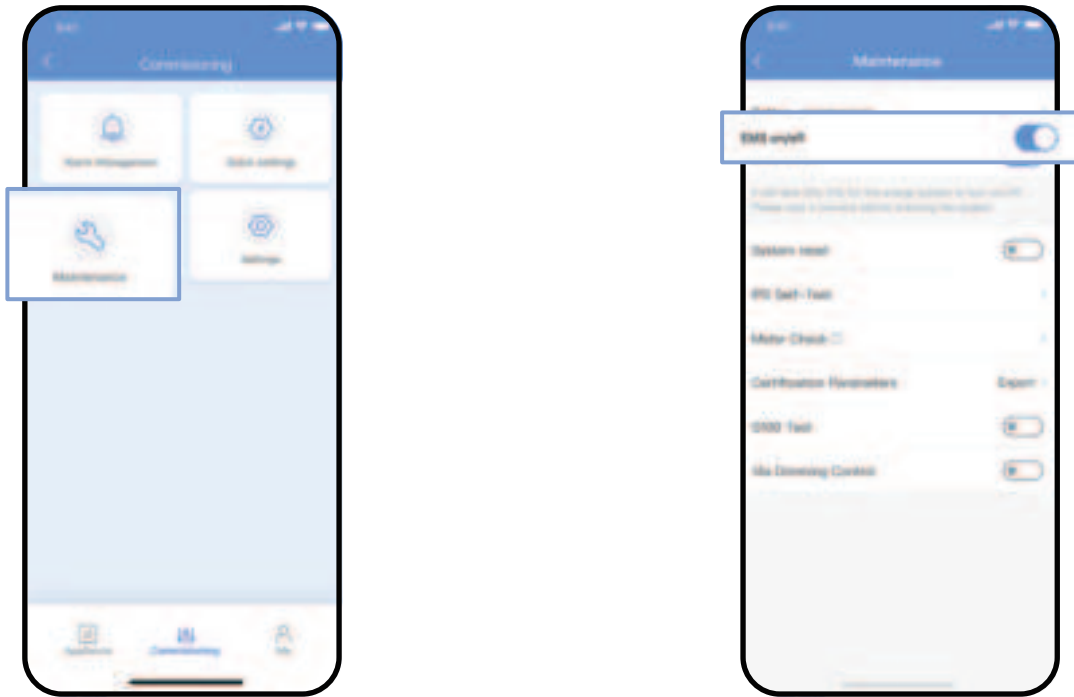

5.3 System Power Off

Power Off Inverter and Bidirectional DC/DC Unit

Step 1: Turn the PV switch between the inverter and the PV panels to OFF.

Step 2: Turn the AC switch between the inverter and the grid to OFF.

Step 3: Turn the DC switch on the bidirectional DC/DC unit to OFF.

Battery Power Off

The battery will automatically power off within 3 minutes after system power-off (when the DC switch on the bidirectional DC/DC unit is set to OFF), or by pressing the black start button on the bidirectional DC/DC unit for 30 seconds. All LED indicators on the bidirectional DC/DC unit turn off. After the system has been powered off for five minutes, ensure all residual energy in the battery is discharged before performing maintenance.

5.4 Black Start up (general)

NOTE

When the battery SOC is 0%, the battery cannot be activated by holding the black start button. The battery can be started only after both the DC and AC power supplies are connected.

It is recommended that the battery be charged to 50% SOC. Long-term storage will cause capacity loss, after a lithium battery is stored for 12 months in the recommended storage temperature, the irreversible capacity loss rate is 3%-10%.

Step 1 Connect power cables and communications cables correctly.

Step 2 Turn the DC switch on the bidirectional DC/DC unit to ON.

Step 3 Turn the AC switch between the inverter and the grid to ON.

Step 4 Turn the PV switch between the inverter and the PV panels to ON.

Step 5 Hold down the black start button for about 4s to activate the battery. The running status LED indicator turns and keeps green. The battery comprehensive LED shows the battery SOC value. Once any LED above is lighted, release the button.

Step 6 Hold down the black start button again for about 5s and release to start the system.

Step 7 Confirm the start-up begins by blink of any battery comprehensive LED.

NOTE

If the black start-up fails, the running status LED indicator turns and keeps red. Follow the next steps.

Step f1 Turn the AC switch between the inverter and the grid to OFF.

Step f2 Turn the PV switch between the inverter and the PV panels to OFF.

Step f3 Turn the DC switch on the battery power module to OFF.

Step f4 Hold down the black start button for about 34s to deactivate the battery. Once all LED indicators on the bidirectional DC/DC unit turn dark, release the button.

Step f5 Turn to follow step 1 to step 7.

6.TROUBLE SHOOTING AND MAINTENANCE

6.1 Troubleshooting

This section describes the potential errors for this product. Please read carefully for the following tips when doing the troubleshooting:

Alarm severities are defined as follows

Major: The inverter is faulty. As a result, the output power decreases or the grid-tied power generation is stopped.

Minor: Some components are faulty without affecting the grid-tied power generation.

Table6-1 List of Reported Faults of APP/Web display

Alarm ID	Alarm Name	Alarm Severity	Possible Cause	Trouble shooting
2001	Power module overtemperature	Major	<ol style="list-style-type: none"> 1. The installation position of the battery power control module is not well ventilated. 2. The ambient temperature is excessively high. 3. The battery power control module is abnormal. 	<ol style="list-style-type: none"> 1. Check the ventilation and whether the ambient temperature of the power control module exceeds the upper threshold. 2. If the ventilation is poor or the ambient temperature is excessively high, improve the ventilation and heat dissipation. 3. If the ventilation and ambient temperature are normal, contact your dealer or technical support.
2002	Low battery DC input bus voltage	Major	<ol style="list-style-type: none"> 1. The DC bus voltage of the battery is low. 2. The battery DC switch is OFF. 3. The battery cables are not correctly connected. 	<ol style="list-style-type: none"> 1. Turn off the inverter AC output switch, inverter DC input switch, and battery DC switch, and wait for 5 minutes. 2. Check the cable connections to the power control module by referring to the quick installation guide. 3. After checking that the battery power cables are correctly connected, turn on the battery DC switch, AC output switch, and inverter DC input switch in sequence. 4. If the alarm persists, contact your dealer or technical support.
2003	Battery expansion module undervoltage	Major	The voltage of a battery expansion module is low.	If the sunlight is sufficient or AC reverse charging is allowed, the battery expansion modules can be charged when the inverter is running.

6.2 Daily Maintenance of the System

To ensure that the battery can operate properly for a long term, you are advised to perform routine maintenance on it as described in this chapter.

ATTENTION

Before cleaning the system, connecting cables, and ensuring the grounding reliability, power off the system.

Check Item	Check Method	Maintenance Interval
System cleanliness	Check periodically that the heat sinks are free from obstacles and dust.	Once every 6 to 12 months
System running status	<ul style="list-style-type: none"> • Check that the battery is not damaged or deformed. • Check that the battery does not generate abnormal sound when it is in operation. • Check that the battery parameters are correctly set when the battery is running. 	Once every 6 months
Electrical connection	<ul style="list-style-type: none"> • Check that cables are secured. • Check that cables are intact, and that in particular, the parts touching the metallic surface are not scratched. • Check that unused DC input terminals, battery terminals, and COM ports are locked by watertight caps. 	The first inspection is 6 months after the initial commissioning. From then on, the interval can be 6 to 12 months.
Grounding reliability	<ul style="list-style-type: none"> • Check that ground cables are securely connected. 	The first inspection is 6 months after the initial commissioning. From then on, the interval can be 6 to 12 months.

6.3 Battery Module Storage Requirements and Power Supply

Battery Module Storage Requirements :

- Environment temperature: -10°C ~45°C
- Recommended storage temperature: 20°C ~30°C
- Storage relative humidity range: 5%~80%.
- Store in a dry, clean, and ventilated environment, away from direct sunlight.
- When storing the battery module, place it correctly. Do not put the battery module upside down or on its side.
- If the energy storage module is stored for a long time, replenish the power supply periodically.

Recharge Requirements during Normal Storage

When the battery is stored for a long time, you need to perform regular maintenance. If the storage time is close to that shown in the following table, arrange supplementary power supply in time.

Recharge conditions when in storage

Storage Environment Temperature	Relative Humidity of Storage Environment	Storage Time	SOC
< -10°C	/	Prohibit	/
-10°C ~ 25°C	5%~ 80%	≤12 months	40%≤SOC≤80%
25°C~ 35°C	5%~ 80%	≤6 months	40%≤SOC≤80%
35°C~ 45°C	5%~ 80%	≤3 months	40%≤SOC≤80%
>45°C	/	Prohibit	/

7. TECHNICAL PARAMETERS

System Parameters	H1-5-E0	H1-10-E0	H1-15-E0	H1-20-E0
Number of Bidirectional DC/DC Unit	1	1	1	1
Battery module energy	5kWh	5kWh	5kWh	5kWh
Number of Energy Storage Module	1	2	3	4
Battery usable energy ¹	5kWh	10kWh	15kWh	20kWh
Max. output power	2.5kW	5kW	5kW	5kW
Nominal voltage (three phase system)	600V			
Operating voltage range (three phase system)	600-980V			
Display	SOC status indicator, LED indicator			
Communication	RS485			
Dimension (W*H*D)	690*887*168	690*1287*168	690*1687*168	690*2087*168
	mm	mm	mm	mm
Weight (Floor stand toolkit included)	78.57kg	126.37kg	174.17kg	221.97kg
Installation	Floor stand			
Operating temperature	-20°C ~ +55°C (-4°F ~ 131°F) ³			
Max. operating altitude	2000m			
Environment	Outdoor/ Indoor ⁴			
Relative humidity	5%-95%			
Cooling	Natural convection			
Protection rating	IP 65			
Cell technology	Lithium-iron phosphate (LiFePO4)			

Bidirectional DC/DC Unit	
Rated charge and discharge power	5kW
Nominal voltage	600V
Operating voltage range(three phase system)	600-980V
Power module dimension (W*H*D)	690*407*168mm
Power module weight	25.3kg
Ingress Protection	IP65
Energy Storage Module	
Nominal Voltage	51.2V
Voltage Range	45-57.6V
Max. Continuous Current	50A
Battery usable energy ¹	5.12kWh
Battery module dimension (W*H*D)	650*400*165mm
Battery module weight	47.8kg ²
Ingress Protection	IP66
Standard	
Certificates	IEC/EN 62109-1, EN 61000-6-1, EN 61000-6-3, IEC62619, UN38.3, IEC/EN 62040-1

1. Test conditions: 100% depth of discharge(DoD), 0.2C rate charge & discharge at 25°C , at the beginning of life.
2. The weight of the battery module is subject to the actual product, with a tolerance of $\pm 3\%$.
3. Refer to battery warranty letter for conditional application.
4. Please follow the user manual during the installation, use, and maintenance of the storage system.

8. TRADEMARKS, COPYRIGHTS AND LEGAL STATEMENT

 Midea logo, word marks, trade name, trade dress and all versions thereof are valuable assets of Midea Group and/or its affiliates (“Midea”), to which Midea owns trademarks, copyrights and other intellectual property rights, and all goodwill derived from using any part of an Midea trademark. Use of Midea trademark for commercial purposes without the prior written consent of Midea may constitute trademark infringement or unfair competition in violation of relevant laws.

This manual is created by Midea and Midea reserves all copyrights thereof. No entity or individual may use, duplicate, modify, distribute in whole or in part this manual, or bundle or sell with other products without the prior written consent of Midea.

All the described functions and instructions were up to date at the time of printing this manual. However, the actual product may vary due to improved functions and designs.

9. DISPOSAL AND RECYCLING

Important instructions for environment(European Disposal Guidelines)

Compliance with the WEEE Directive and Disposing of the Waster Product:
This product complies with EU WEEE Directive. This product bears a classification symbol for waster electrical and electronic equipment (WEEE).

This symbol indicates that this product shall not be disposed with other household wastes at the end of its service life. Used device must be returned to official collection point for recycling of electrical electronic devices. To find these collection systems please contact to your local authorities or retailer where the product was purchased. Each household performs important role in recovering and recycling of old appliance. Appropriate disposal of used appliance helps prevent potential negative consequences for the environment and human health.



10.DATA PROTECTION NOTICE

For the provision of the services agreed with the customer, we agree to comply without restriction with all stipulations of applicable data protection law, in line with agreed countries within which services to the customer will be delivered, as well as, where applicable, the EU General Data Protection Regulation (GDPR).

Generally, our data processing is to fulfil our obligation under contract with you and for product safety reasons, to safeguard your rights in connection with warranty and product registration questions. In some cases, but only if appropriate data protection is ensured, personal data might be transferred to recipients located outside of the European Economic Area.

Further information are provided on request. You can contact our Data Protection Officer via **MideaDPO@midea.com**. To exercise your rights such as right to object your personal data being processed for direct marketing purposes, please contact us via **MideaDPO@midea.com**. To find further information, please follow the QR Code.

The design and specifications are subject to change without prior notice for product improvement. Consult with the sales agency or manufacturer for details. Any updates to the manual will be uploaded to the service website, please check for the latest version.



www.midea.com
© Midea 2023 all rights reserved

H1-(5-20)-E0
16114600000341
20250801