

ELURA

SOUND + PERFORMANCE

**BLACK LABEL SERIES AMPLIFIERS
OWNER'S MANUAL &
INSTALLATION GUIDE**



ELURA AMP100/6.2



**100-WATT 8 Ω 6 CHANNEL, 3 ZONE AMPLIFIER
AND**

ELURA AMP80/12

**80-WATT 8 Ω 12 CHANNEL, 6 ZONE AMPLIFIER
AND**

ELURA AMP80/16

80-WATT 8 Ω 16 CHANNEL, 8 ZONE AMPLIFIER

	CAUTION RISK OF ELECTRIC SHOCK DO NOT OPEN	ATTENTION RISQUE DE CHOC ELECTRIQUE NE PAS OUVRIR	
WARNING:			
To reduce the risk of fire or electric shock, do not expose this apparatus to rain or moisture.			
AVIS:			
Pour réduire le risque d'incendie ou de choc électrique, ne pas exposer cet appareil sous la pluie et l'humidité.			
The apparatus shall not be exposed to dripping or splashing and that no objects filled with liquids, such as vases, shall be placed on apparatus.			
<i>L'appareil ne doit pas être exposé aux écoulements ou aux éclaboussures et aucun objet ne contenant de liquide, tel qu'un vase, ne doit être placé sur l'objet.</i>			



The lightning flash with arrowhead symbol, within an equilateral triangle, is intended to alert the user to the presence of uninsulated "dangerous voltage" within the product's enclosure that may be of sufficient magnitude to constitute a risk of electric shock to persons.

Le symbole de l'éclair fléché dans un triangle équilatéral, est destiné à alerter l'utilisateur de la présence d'une "tension dangereuse" dans le boîtier du produit qui peuvent être des ampleur suffisante pour constituer un risque d'électrocution aux personnes.



This symbol is intended to alert the user to the presence of important operation and maintenance (servicing) instructions in the literature accompanying the appliance.

Ce symbole est destiné à alerter l'utilisateur de la présence d'opération et de maintenance (entretien) dans la documentation accompagnant l'appareil.

Important Safety Instructions

1. Read these Instructions.
Lisez ces instructions.
2. Keep these Instructions.
Conservez ces instructions.
3. Heed all Warnings.
Respectez tous les avertissements.
4. Follow all instructions.
Suivez toutes les instructions.
5. Do not use this apparatus near water.
Ne pas utiliser cet appareil près de l'eau.
6. Clean only with a dry cloth.
Nettoyer uniquement avec un chiffon sec.
7. Do not block any ventilation openings. Install in accordance with the manufacturer's instructions.
Ne pas bloquer les ouvertures de ventilation. Installer conformément aux instructions du fabricant.
8. Do not install near any heat sources such as radiators, heat registers, stoves, or other apparatus (including amplifiers) that produce heat.
Ne pas installer près de sources de chaleur telles que radiateurs, registres de chaleur, poêles ou autres appareils (y compris les amplificateurs) produisant de la chaleur.
9. Do not defeat the safety purpose of the polarized or grounding - type plug. polarized plug has two blades with one

wider than the other. When the provided plug does not fit into your outlet, consult an electrician for replacement of the obsolete outlet.

Ne détruisez pas la sécurité de la terre ou polarisées - fiche. Une fiche polarisée possède deux lames dont une est plus large que l'autre. Si la fiche fournie ne rentre pas dans votre prise, consultez un électricien pour remplacer la prise obsolète.

10. Protect the power cord from being walked on or pinched particularly at plugs, convenience receptacles, and the point where they exit from the apparatus.

Protégez le cordon d'alimentation d'être piétiné ou pincé, particulièrement au niveau des fiches, des prises, et le point où ils sortent de l'appareil.

11. Only use attachments/accessories specified by the manufacturer.
N'utilisez que des accessoires spécifiés par le fabricant.

12. Use only with a cart, stand, tripod, bracket, or table specified by the manufacturer, or sold with the apparatus. When a cart or rack is used, use caution when moving the cart/apparatus, combination to avoid injury from tip-over.



Utilisez uniquement un chariot, stand, trépied, support ou table spécifiés par le fabricant ou vendu avec l'appareil. Quand un panier ou rack est utilisé, faites attention lorsque vous déplacez l'ensemble chariot / appareil, pour éviter d'éventuelles blessures en cas de chute.

13. Unplug this apparatus during lightning storms or when unused for long periods of time.

Débranchez cet appareil pendant les orages ou lorsqu'il n'est pas utilisé pendant de longues périodes de temps.

14. Refer all servicing to qualified service personnel. Servicing is required when the apparatus has been damaged in any way, such as power-supply cord or plug is damaged, liquid has been spilled or objects have fallen into the apparatus, the apparatus has been exposed to rain or moisture, does not operate normally, or has been dropped.

Confiez toute réparation à un personnel qualifié. Une réparation est nécessaire lorsque l'appareil a été endommagé de quelque façon que ce cordon d'alimentation ou la fiche est endommagé, liquide a été renversé ou des objets sont tombés dans l'appareil, l'appareil a été exposé à la pluie ou à l'humidité, ne fonctionne pas normalement, ou s'il est tombé.

15. **WARNING:** The appliance coupler is used as disconnect device, the disconnect device shall remain readily operable.

AVERTISSEMENT: La fiche d'alimentation (appareil coupleur) est utilisé comme dispositif de déconnexion, le dispositif de déconnexion doit rester facilement accessible.

16. No naked flame sources, such as lighted candles, should be placed on the apparatus.

Aucune source de flamme nue, telle que des bougies allumées, ne doit être placé sur l'appareil

17. Protective earthing terminal. The apparatus should be connected to a mains socket outlet with a protective earthing connection.



Borne de terre de protection. L'appareil doit être connecté à une prise secteur avec une prise de terre.

FCC Statement

This device complies with part 15 of the FCC Rules. Operation is subject to the following two conditions: (1) This device may not cause harmful interference, and (2) this device must accept any interference received, including interference that may cause undesired operation.

Overview

Thank you for purchasing Elura amplifier products. Elura is a high performance custom installed product engineered for commercial sound installations. Each Elura product is manufactured to the highest quality standard using the state of the art components and built for years of enjoyment.

Features

- Multi-channel/multi-zone
- Digital high power amplification
- Speaker outputs of 4Ω and 8Ω
- Global BUS IN and independent channel line inputs
- All 3, 6 or 8 zones bridgeable
- SUB OUT with variable crossover on each zone
- 2U Rack mountable
- Auto-On and Trigger-On
- Front panel level controls with removable security cover
- Zone status LEDs
- BUS output for linking amplifiers
- Short circuit protected
- AC 110/220V 50-60Hz (switchable) power supply system

Contents

- Amplifier
- Power Cord
- (2) Rack Mountable Ears
- (6) Rack Ear Mount Screws
- Manual

Front & Rear Overview

1. Master Power Button & LED Indicator

The power button switch is located on the amplifier’s front panel and is used to turn the device on or off. When pushed to the “ON” position, the amplifier enters standby mode, and the LED indicator turns red. The Auto/On/Trigger selector, located at the rear, can be in either on, auto, or trigger mode. Once the LED indicator turns blue, the amplifier is fully active.

NOTE: the master power button can turn off the amplifier no matter the position of the remote turn-on switch. When the power button LED is not illuminated, the amplifier is completely off and not receiving power.

2. Zone Status LED Indicators

Each pair of channels or zones has a red and blue LED to indicate its operational status. These indicators provide quick and easy troubleshooting of the amplifier. In the event that the circuitry detects that a channel(s) must be shut down due to excessive heat or low impedance (a short), only the affected channel(s) will be turned off, forcing the zone LED to turn red. The remaining zones will continue to operate and maintain a blue LED status. Once the status has been corrected for the given zone(s), the status LED will return to blue.

NOTE: the unit is in standby mode when the power LED is red and the zone status LEDs are not illuminated or off.

3. BUS Line RCA Inputs & Outputs

The AMP100/6.2, AMP80/12 and AMP80/16 amplifiers come with a pair of BUS line inputs that can receive audio signals from standard line-level audio sources and transmit them to any or all amplifier

channels. This amplifier is also equipped with a pair of BUS line outputs for sending signal to additional amplifiers if needed. It is recommended that high-quality RCA cables with low impedance, shielding, and high-quality connectors be used for optimal performance. Please note that running “MONO” to all the channels of the amplifier can be accomplished by utilizing the BUS INPUTS/OUTPUTS in conjunction. More information of outputting a mono signal is discussed further in this manual.

4. Individual Line RCA Inputs

All channels have their own dedicated line RCA inputs that allow for the connection of audio sources in addition to the common BUS line inputs.

5. Input Selector

Each channel can receive a source signal from multiple inputs. The primary inputs are BUS 1, BUS 2, and LINE IN. Use the input selection switch for the

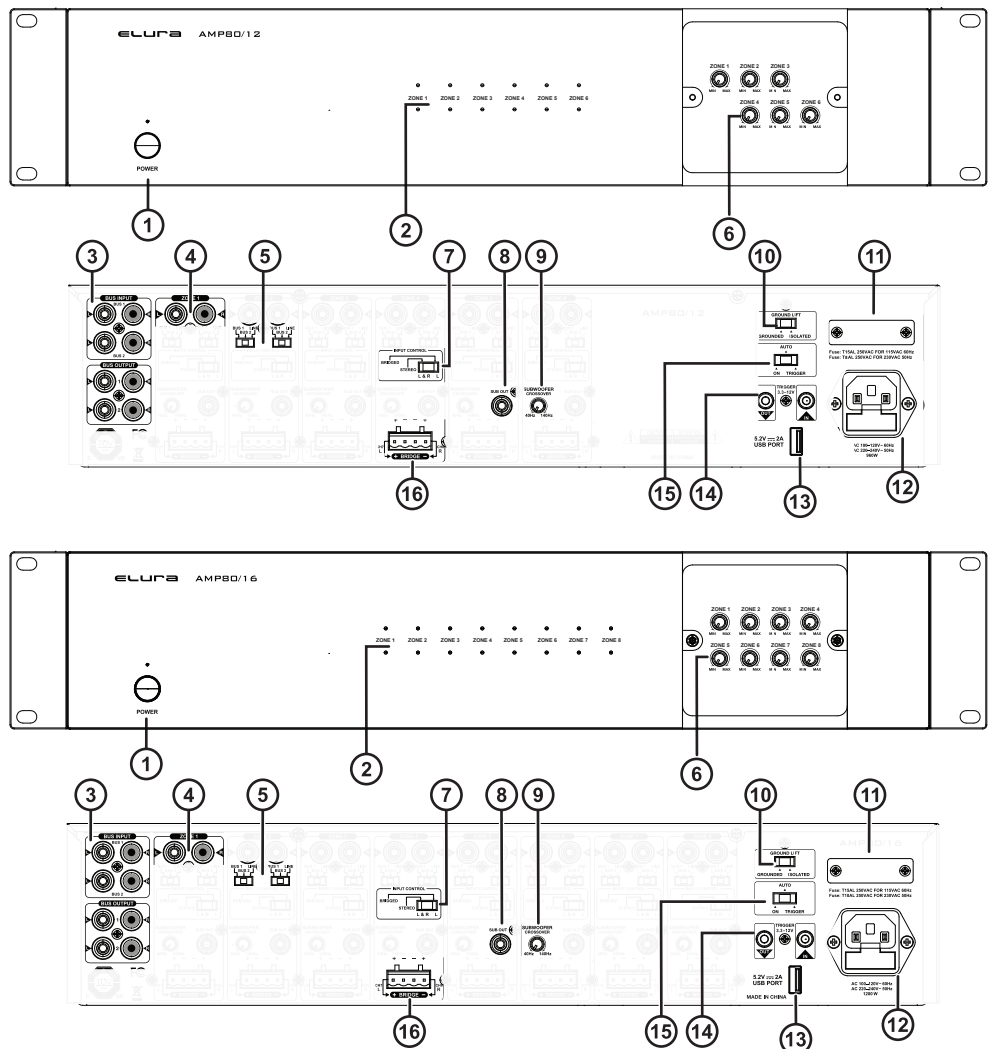

respective channel to make the selection. Pick the desired input source and position the switch to BUS 1 (for the source connected to the BUS 1 input), BUS 2 (for the source connected to the BUS 2 input), or LINE IN (for the source connected to the channel's LINE IN).

6. Channel Level/Gain Control

Each zone has its own level adjustment which alters the output of that zone. This allows the output to be set to the desired volume level so it does not clip or overdrive the amplifier when it is being used at maximum level. This could cause speaker or amplifier damage.

7. Stereo & Bridging Selector Switch

This selector lets you combine two channels (bridged) on a given zone to increase the power output. This feature is convenient when extra power is required for a specific zone.

NOTE: the minimum impedance required for bridged channels is 8Ω and proper speaker wiring must be followed when bridging channels. The left channel will control input selection and volume settings for bridged channels. "BR" indicates bridged mode, while "ST" represents stereo mode. Ensure the amplifier is turned off before switching between modes.

8. Subwoofer RCA Outputs

Each zone has its own subwoofer RCA output that can be used to either connect an active/powered subwoofer or subwoofer amplifier to the AMP100/6.2, AMP80/12 and AMP80/16 or connect a single RCA cable from the SUB OUT for that zone to the next zone's RCA LINE IN left channel. See Fig. 7 & 8.

9. Crossover for Subwoofer Outputs

Each zone has its own independent crossover knob with variable LPF (Low Pass Filter) that is adjustable from 40Hz-140Hz. The crossover setting allows for frequencies below the chosen cut off frequency to pass through, preventing it from interfering with other speakers or producing unwanted frequencies. This ensures that the subwoofer(s) blend seamlessly with the rest of the audio system.

10. Ground Lift Selector Switch

This switch addresses unwanted ground-related noise caused by ground

loops in audio cables. If a ground loop occurs, adjust the switch to reduce or eliminate any audible hum or buzz noise from the sound system.

11. Switchable 110/220V Input Voltage

The AMP100/6.2, AMP80/12 and AMP80/16 amplifiers work in both 110V and 220V environments. **Before powering on the amplifier, ensure this switch is in the correct position.** For 220V operation, adjust the voltage selector switch to the 220V position. Remember that when operating the amplifier at 220V, the internal fuse found in the IEC socket must also be changed.

12. IEC Power Connector

The AMP100/6.2, AMP80/12 and AMP80/16 amplifiers have a fused IEC power inlet, allowing the flexibility to change the power cable for the different countries. The main fuse holder is located just beneath the IEC inlet and can be accessed by prying off the cover with a flathead screwdriver. Avoid plugging the amplifier's power cable into a switched outlet. To have the amplifier turn on when the AV receiver is powered up, use one of the power modes, such as Trigger or Auto.

13. 5.2V/2A USB Port

The 5.2V/2A USB port integrated into the amplifier is designed to supply power to other external devices such as wireless audio connectivity adapters. NOTE: the port solely serves as a power source and does not facilitate data transfer or media functions.

14. Trigger Input & Output

The amplifier's trigger input is a convenient way to connect it to an automated audio system. The 3.5mm mini plug jack accepts a 3.3-12V AC/DC output from another device or a separate power supply. The trigger input activates the amplifier, turning it from standby to ON mode. If using the AMP100/6.2, AMP80/12 or AMP80/16 with an AV receiver that lacks a trigger output, the voltage can come from a 12V wall wart (3.5mm tip-positive connector) plugged into the receiver's switched outlet and the trigger input. Moreover, the amplifier's output trigger voltage (12V DC @ 50mA max.) can turn other audio system devices on and off.

NOTE: the amplifier has a delay of approximately 15 minutes before it goes into standby when using the "Auto" turn-on mode. Additionally, the voltage will drop to zero when the amplifier turns off, entering standby mode.

15. On/Auto/Trigger Selector Switch On Mode

With the switch in the "ON" mode, the amplifier is controlled by the front panel power button (see #1).

Auto Mode

Auto mode detects audio signals and switches on automatically. If there has been no audio signal for around 20 minutes, the amplifier will enter standby mode. While in sleep/standby mode, there will be a 10 to 15 second delay before the amplifier powers back on and audio playback resumes.

Trigger Mode

The AMP100/6.2, AMP80/12 and AMP80/16 can be turned on and off by utilizing the 12V trigger input and/or output. NOTE: after power is applied to the trigger, there will be a few seconds delay before an audio signal is played. For everyday use, it is best to leave the amplifier in the "ON" position. Please note that a 3.5mm MONO male to male cable does not come with the AMP100/6.2, AMP80/12 and AMP80/16 amplifiers and that the use of a 3.5mm STEREO will not work for the 12V trigger feature.

16. Speaker Output Terminals

The AMP100/6.2, AMP80/12 and AMP80/16 speaker connections employ high-quality Phoenix-style connectors. Using 14-18 gauge stranded two-conductor wire for the loudspeakers is recommended. Ensure at least a 2-inch separation between each wire, and strip away roughly a quarter-inch of insulation from each wire. Correctly connect the corresponding speaker wire for each screw terminal, observing proper polarity. Also, when bridging channels, ensure proper speaker wiring protocol is maintained.

LED Indicators and Anti-Clipping Circuitry: What You Need to Know

Front Panel LED Reference Chart

	LED COLOR	DESCRIPTION
POWER	BLUE	Amplifier is on
	RED	Amplifier is in standby , no signal
	OFF	Amplifier is off
CHANNEL	BLUE	Zone is active
	RED	Zone fault
	OFF	No signal
CLIP	RED FLASHING	Source is set too high
	OFF	Source is set correctly

Note: If a channel LED is RED, there is a fault and an issue needs to be fixed. Once settled, the indicator should turn back to BLUE if the zone is being used or OFF if the zone is not being used. A fault is typically the positive and negative speaker wires touching.

Note: If one of the clip LED indicators is flashing, then that zone is being clipped. Anti-clipping circuitry will automatically reduce the output level going to the speaker from the amplifier when it senses the volume is too loud. The RED clipping LED will continue to flash until the source or the input gain control for that zone is lowered.

Setup & Installation

The AMP100/6.2, AMP80/12 and AMP80/16 comes with feet attached to the bottom for shelf or table-top applications. In order to rack mount the amplifier, first remove the four feet from the bottom of the amplifier. Then, attach the supplied rack ears with the 6 supplied rack ear screws. Be sure to allow enough space above and below the amplifier for proper ventilation.

Input Selection

Position the input selector for each channel to either BUS 1, BUS 2, or LINE. This tells the amp which input type will be used for the given zone.

Fig. 1

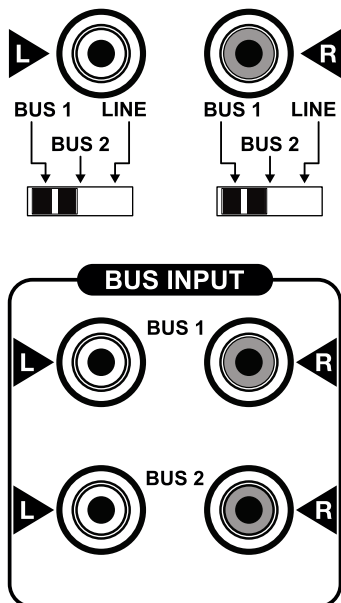

Speaker Connections

A pair of speaker terminals are provided for each channel. These terminals accept bare wire only. Strip approximately a quarter inch of insulation from the end of each wire and carefully twist the strands of each conductor together. Use 14-18 gauge stranded two conductor wire for each loudspeaker and ensure the polarity is correct when wiring the channel in STEREO or BRIDGED configuration. Adjust the ST & BR selector to the correct position. Do this for all channels being used.

Fig. 2

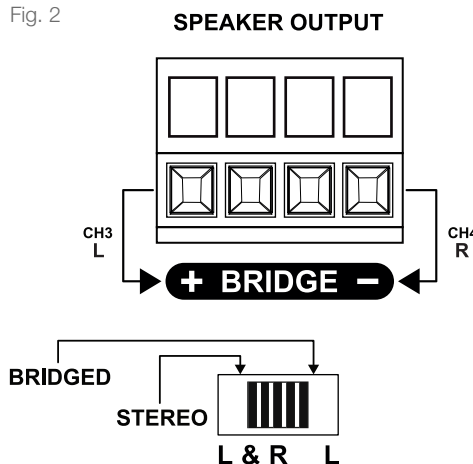

12V Trigger Input

To use the remote turn-on feature of this amplifier - to turn it on from an external source such as a compatible AV receiver - a 3.5mm mono male to male cable is needed. Do not use a 3.5mm stereo cable. Run the cable from the external source to the 3.3-12V TRIGGER IN and adjust the switch above to the TRIGGER position. When powering on the AV receiver or processor, the amplifier will turn on with it. Additionally, it is possible to connect another 3.5mm mono cable from the TRIGGER OUT to another device or amplifier, if needed.

Fig. 3

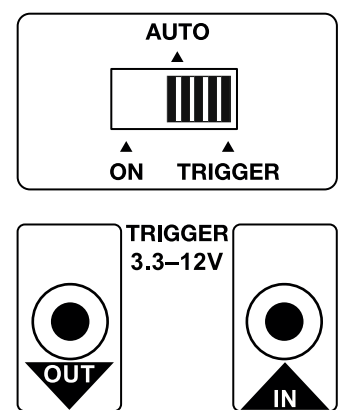

Input AC & Power Cord

The AMP100/6.2, AMP80/12 and AMP80/16 can operate in 110V and 220V environments. Before powering the amplifier on, make sure that the Input AC Selector is in the correct position and that the correct fuse is installed. Plug the AC power cord into the amplifier first and then into the wall outlet. Make sure it is firmly connected.

Caution

The fuse holder is located directly under the power socket. It contains one extra 10 ampere, 250V fuse.

When accessing the fuse holder, first make sure the AMP100/6.2, AMP80/12 Or AMP80/16 is turned off and unplugged from both the wall outlet and the amplifier's power socket. Place a flat head screwdriver just above the groove on the top of the fuse holder to pry it off.

Typical Multi-Zone Wiring Example

Ensure that the STEREO/BRIDGE switch is in the correct position prior to operation. This must be done for all channels that are being driven.

Stereo Wiring:

21V AC (4Ω Minimum - 110 WRMS / 200W MAX)

Mono Wiring:

42V AC (8Ω Minimum - 220 WRMS / 400W MAX)

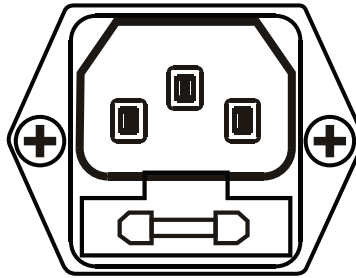
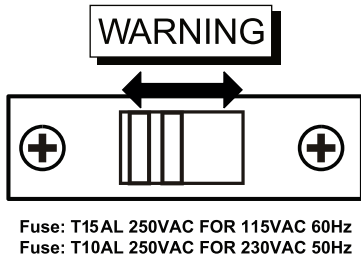

AC 100-120V ~ 60Hz
AC 220-240V ~ 50Hz
1200 W

Fig. 4

Multi-Zone Preamp

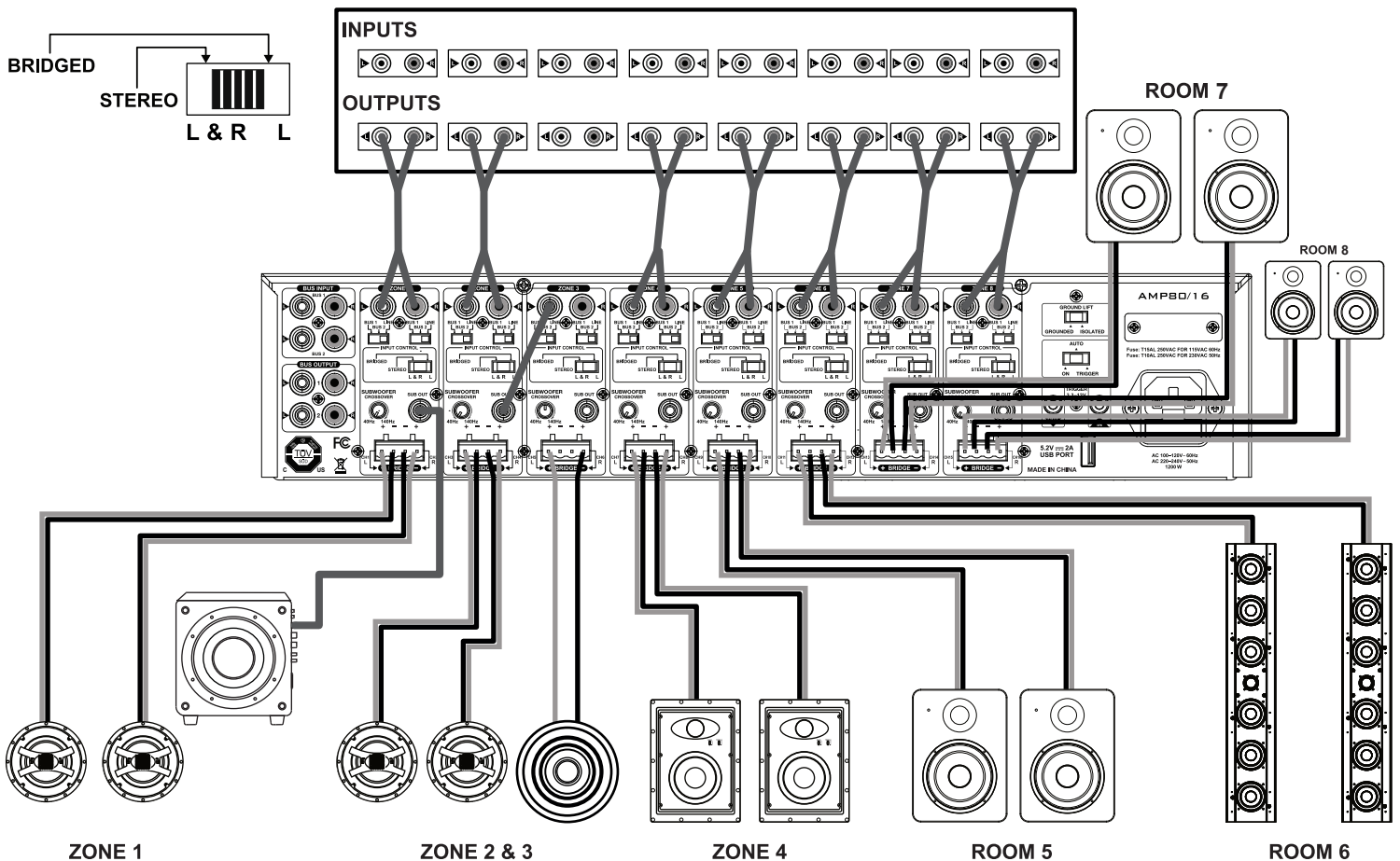

Wiring Configurations

Standard 2-Channel Stereo Wiring

1. Attach the source to the RCA LINE IN or BUS INPUT
2. Set the input switch to the appropriate source
3. Set the ST/BR switch to ST (stereo)
4. Attach two speakers to the phoenix connector, left & right channel

Fig. 5

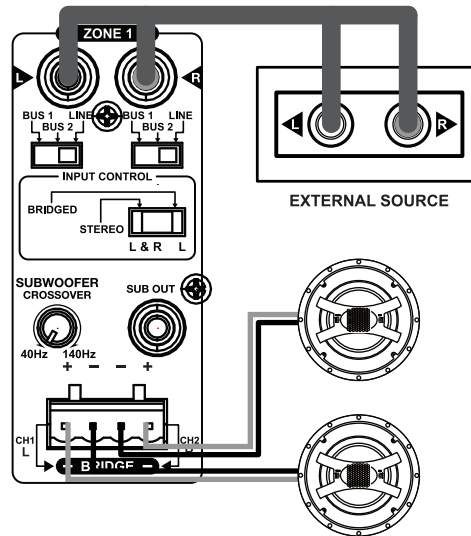

Powered Subwoofer Wiring

1. Attach the source to the RCA LINE IN or BUS INPUT
2. Set the input switch to the appropriate source
3. Set the ST/BR switch to ST (stereo)
4. Attach a single RCA wire from the SUB OUT of that zone to a powered subwoofer or subwoofer amplifier
5. Turn the subwoofer crossover knob clockwise to the 140Hz position and use the crossover on the powered subwoofer or subwoofer amplifier

Fig. 6

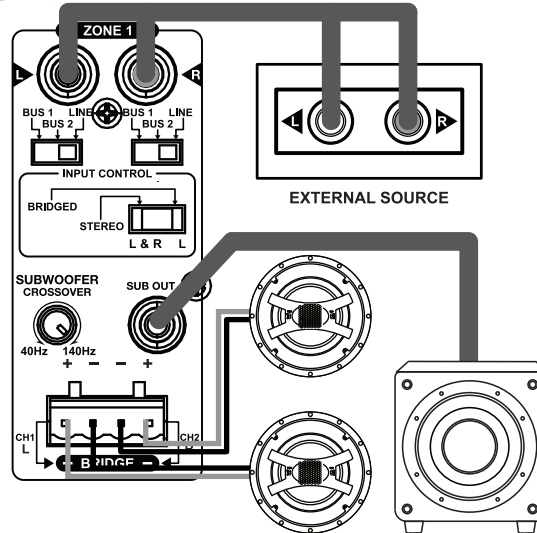

Passive Subwoofer Wiring - Bridged Output

1. Attach the source to the LINE IN or BUS IN
2. Set the input switch to the desired source
3. Connect a single RCA wire from the SUB OUT of one zone to the next zone's LINE IN LEFT channel
4. Connect the full range speakers to the phoenix connector of the first zone and set it to ST for stereo. Then connect the passive subwoofer to the outermost portions of the phoenix connector on the subwoofer zone and set it to BR for bridged
5. Adjust the crossover and gain knobs on both zones until preferred music and subwoofer sound are achieved and use the source volume to adjust the sound level

Fig. 7

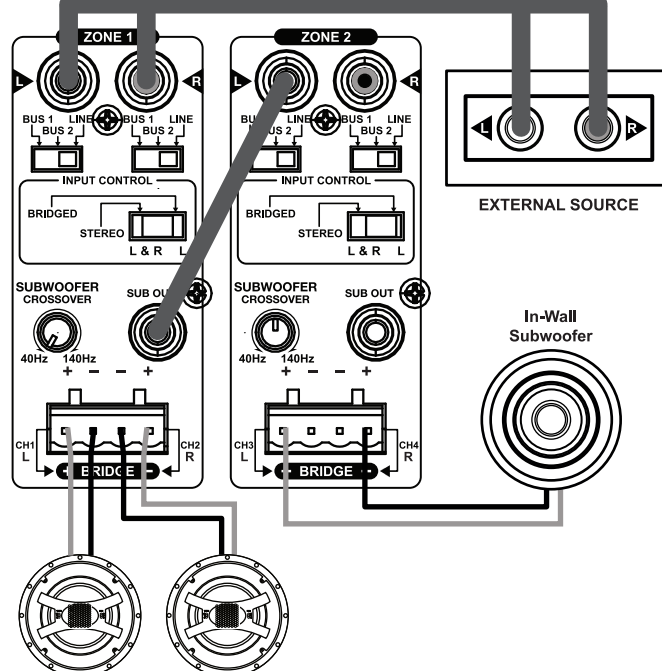

Note: The minimum impedance for bridging the channels on the amplifiers is 8Ω

Wiring Configurations (continued)

Dual Passive Subwoofer Wiring - Bridged Output

1. Attach the source to the LINE IN or BUS IN
2. Set the input switch to the desired source
3. Connect a single RCA wire from the SUB OUT of one zone to the next zone's LINE IN LEFT channels
4. Connect the speakers to the phoenix connector of the first zone and set it to ST for stereo. Then connect the passive subwoofers to the phoenix connectors on the two subwoofer zones and set them to BR for bridged
5. Adjust the crossover and gain knobs on both zones until preferred music and subwoofer sound are achieved and use the source volume to adjust the sound level

Note: The minimum impedance for bridging the channels on the amplifiers is 8Ω

Fig. 8

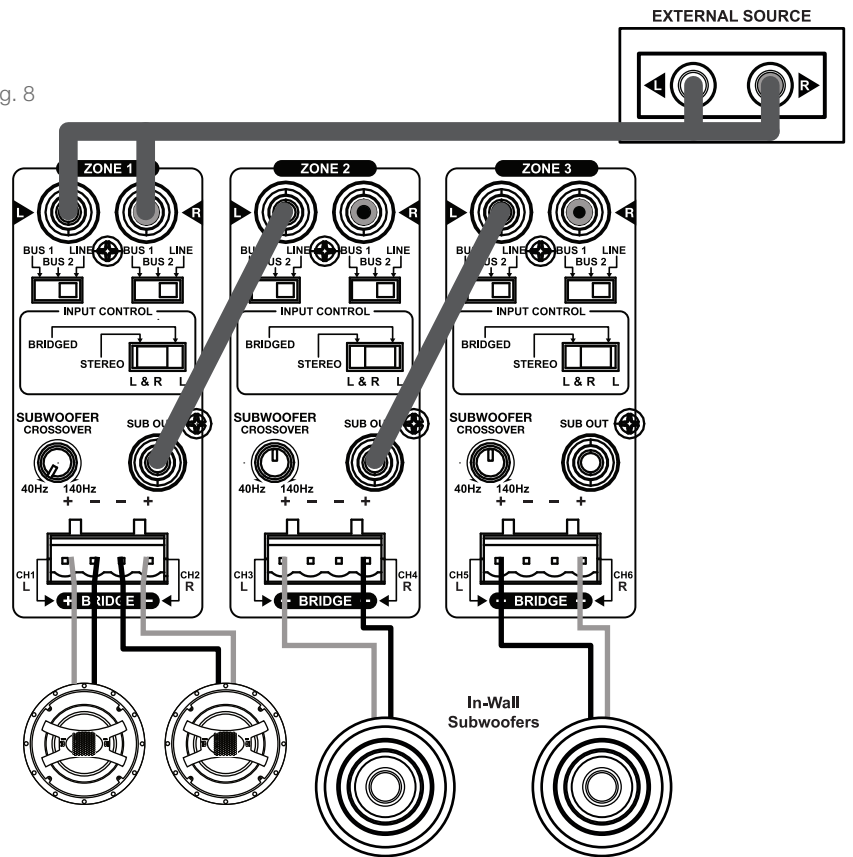

Outputting a Mono Signal Using BUS IN & OUT

1. Use an RCA Y-cable to combine the left and right audio signals from the source. Then, connect it to the BUS 1 LEFT input
2. Using a single RCA cable, connect the BUS 1 LEFT output to the BUS 1 RIGHT input
3. To play the audio source through any speaker, slide the input selector to the BUS 1 position for that channel

Fig. 9

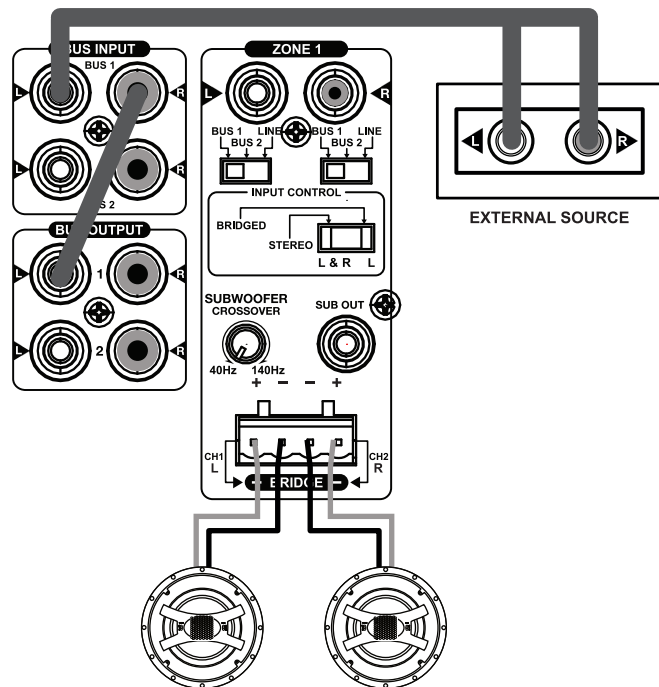

Connecting Multiple Amplifiers

If connecting multiple amplifiers, run an RCA cable from one of the BUS OUTPUTS of amplifier 1 to a BUS INPUT of amplifier 2. This will supply the source signal to the additional amplifier. Ensure that the input selector switches on amplifier 2 are in the correct BUS INPUT position. Additionally, if using the trigger feature, run an additional 3.5mm trigger cable from the TRIGGER IN of amplifier 2.

Fig. 10

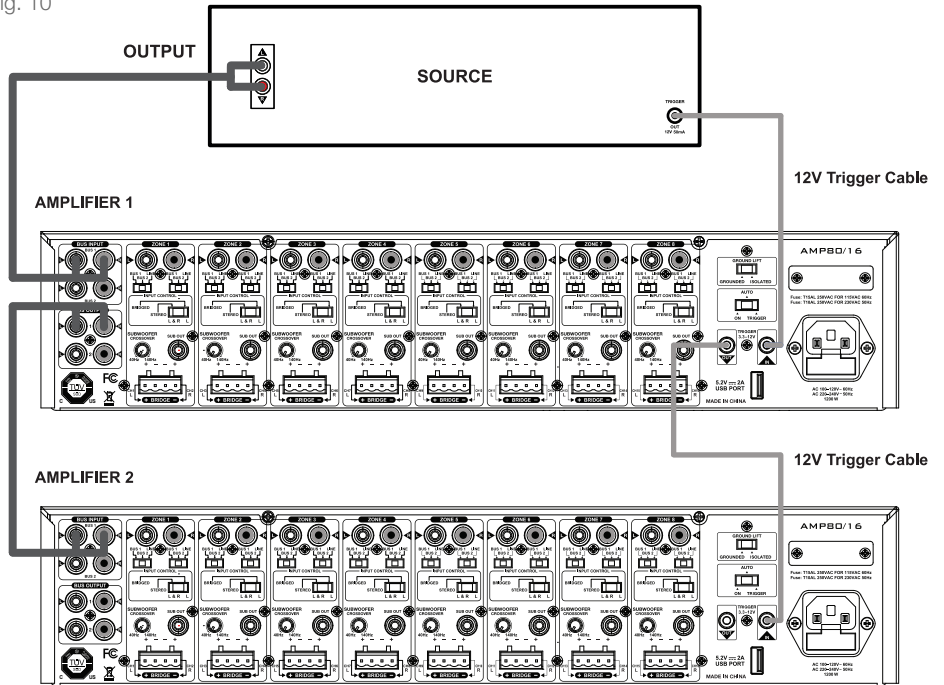

Specifications

Model	AMP100/6.2	AMP80/12	AMP80/16
Number of Channels	6-channels / 3 zones	12-channels / 6 zones	16-channels / 8 zones
Power Rating Per Channel	100W @ 8Ω 125W @ 4Ω 200W @ 8Ω Bridged	80W @ 8Ω 100W @ 4Ω 180W @ 8Ω Bridged	80W @ 8Ω 100W @ 4Ω 180W @ 8Ω Bridged
Frequency Response	20Hz-20kHz	20Hz-20kHz	20Hz-20kHz
Total Harmonic Distortion - THD	<1%	<1%	<1%
Input Impedance	20kΩ	20kΩ	20kΩ
Signal-to-Noise Ratio (A-Weighted)	95dB	95dB	95dB
Auto OFF Delay Time	15 minutes	15 minutes	15 minutes
Crosstalk	110 dB mono, 75dB stereo	110 dB mono, 75dB stereo	110 dB mono, 75dB stereo
Gain	24dB	24dB	24dB
Trigger In Voltage	3.3-12V DC/AC	3.3-12V DC/AC	3.3-12V DC/AC
Trigger Out Voltage	12V DC	12V DC	12V DC
Standby Power	0.4W	0.4W	0.4W
Power Requirement	110-120V/60Hz, 220-240V/50Hz	110-120V/60Hz, 220-240V/50Hz	110-120V/60Hz, 220-240V/50Hz
Fuse Rating	T8AL 250VAC for 115VAC 60Hz T4AL 250VAC for 230VAC 50Hz	T15AL 250VAC for 115VAC 60Hz T8AL 250VAC for 230VAC 50Hz	T15AL 250VAC for 115VAC 60Hz T10AL 250VAC for 230VAC 50Hz
Chassis Dimensions (H x W x D)	89mm x 430mm x 335mm 3.5" x 16.93" x 13.19"	89mm x 430mm x 335mm 3.5" x 16.93" x 13.19"	89mm x 430mm x 335mm 3.5" x 16.93" x 13.19"
Net Weight	9.7 kg (21.4 lb)	13.3 kg (29.3 lb)	13.8 kg (30.4 lb)
Rack Spaces	2U	2U	2U

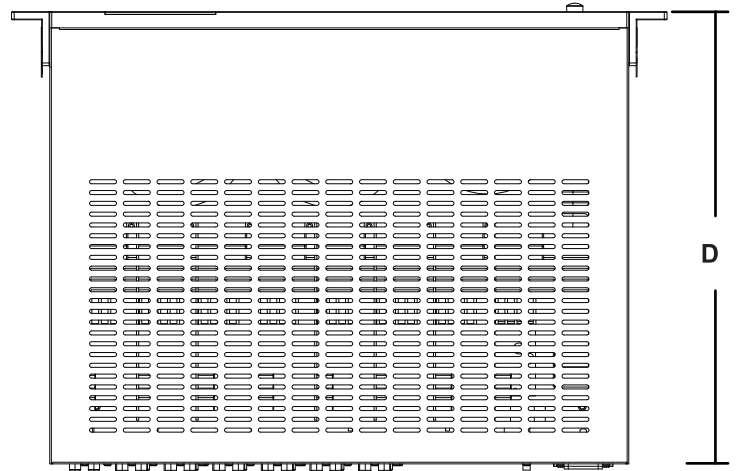
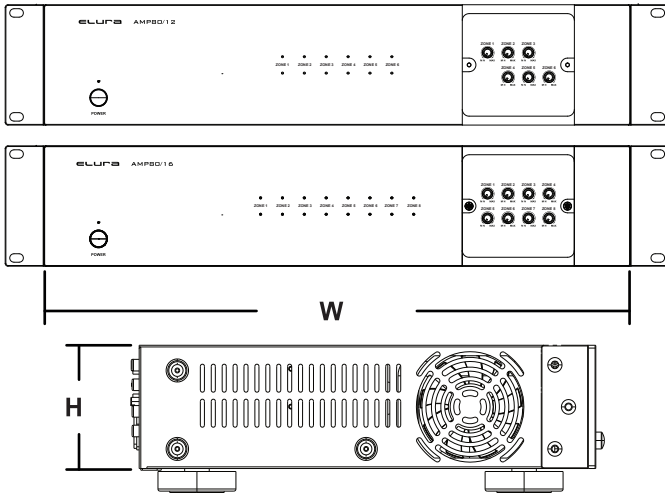

Front Panel LEDs

Each pair of channels or zones has a red and blue LED to indicate its operational status. These indicators provide quick and easy troubleshooting of the amplifier. In the event that the circuitry detects that a channel(s) must be shut down due to excessive heat or low impedance (or short), only the affected channel(s) will be turned off, forcing the zone LED to turn red. The remaining zones will continue to operate and maintain a blue LED status. Once the status has been corrected for the given zone(s), the status LED will return to blue. Note that the unit is in standby mode when the power LED is red, and the zone status LEDs are not illuminated (off).

Circuit Protection

The AMP100/6.2, AMP80/12 and AMP80/16 are protected by anti-clipping circuitry that will automatically reduce the output level going to the speaker(s) from the amplifier when it senses the volume is too loud. The RED clipping light will flash until you lower the source or the input gain control for that zone.

Maintenance

The following maintenance should be performed routinely:

- Clean the exterior surfaces of the unit with a soft, dry, lint-free cloth;
- Do not use alcohol, benzene, acetone-based cleaners, or strong commercial cleaners;
- Do not use cloth made with steel wool or metal polish;
- If the unit is exposed to a dusty environment, a low-pressure blower may be used to remove dust from its interior and exterior.

Speaker Impedance Checklist

Speaker Impedance	Standard Wiring	Number of Channels
One 8Ω Speaker	OK	1
Two 8Ω Speakers	OK	1
One 4Ω Speaker	OK	1

Speaker Impedance	Bridged Wiring	Number of Channels
One 8Ω Speaker	OK	2
One Below 8Ω Speaker	Do Not Use	2

Troubleshooting

Elura amplifiers are designed to function trouble-free. Most problems that occur are due to simple issues. If there is an issue, please check the list of simple fixes below. If the problem persists, contact the installer or MSTR Brand.

No audio from any channel

- Power cable to the amplifier is incorrectly connected or plugged into an outlet that does not have power. Check connections and verify power to the outlet. Verify the power button on the front panel is "BLUE".
- Audio cable to the source component is not connected properly, connected to incorrect BUS input, or the cable is defective. Check connections or replace cable with one that has been verified as good.
- The input selection switches are set incorrectly. Refer to instructions for correct settings.

No audio from one or more channels

- Audio cable to the source component is not connected properly or the cable is defective. Check connections or replace cable with one that has been verified as good.
- The input selection switch is positioned incorrectly. Refer to installation instructions for proper settings.
- The bridging switch is positioned incorrectly. Refer to installation instructions for proper settings.
- Check the connections of the speaker wire at both the speaker and amplifier.

No audio from one channel or one zone only

- Check the front panel LED for the zone that is not working. If it is "RED", there may be a short on either one of the speaker wires for that zone. Check wires and speaker connections for shorts.
- The level adjustment on the channel is turned down. Turn it slowly to the right to raise the volume.

- Test the bad channel by connecting it to a speaker that is known to work.
- Audio cable to the source component is not connected properly or the cable is defective. Check connections or replace cable with one that has been verified as good.
- The input selection switch is positioned incorrectly. Refer to installation instructions for proper settings.
- The bridging switch is positioned incorrectly. Refer to installation instructions for proper settings.
- Check the connections of the speaker wire at both the speaker and amplifier.

Hum or buzzing sound is heard

- Check RCA input cables by removing them one at a time (powering down the amplifier before disconnecting) and checking to see if a connection or cable is to blame. Also, move the ground lift switch on the rear panel between “grounded” and “isolated” to determine which position provides the least hum.

Amplifier will not turn on

- The amplifier must be plugged into a live outlet.
- The power switch on the front panel must be on and “BLUE”.
- Ensure 12V is present if using the trigger input, or that signal is applied if using the “AUTO” mode.
- Ensure that the power mode switch is set correctly for the desired power mode.

Front panel power button is inoperative

- Set the power mode switch to “POWER ON”.

Product Warranty

The seller warrants the AMP100/6.2, AMP80/12 and/or AMP80/16 free from defects in the material and workmanship for 2 years from the date of purchase from the seller or authorized dealer. Should this product fail to be in good working order within the warranty period, the product will be repaired or replaced provided that the unit has not been subjected to accident, disaster, abuse, or any unauthorized modification. This warranty is offered by the seller for its buyer with direct transaction only. This

warranty does not apply to products that have been abused, incorrectly installed, modified, disassembled and/or repaired by anyone other than Elura or our appointed repair facility.

A unit that fails under conditions other than those covered will be repaired at the current price of parts and labor in effect at the time of repair. Such repairs are warranted for 90 days from the day of reshipment to the buyer. If the unit is delivered by mail, customers agree to insure the unit or assume the risk of loss or damage in transit. Under no circumstances will a unit be accepted without a return authorization number.

The warranty is in lieu of all other warranties expressed or implied, including without limitations, any other implied warranty, all of which are expressly disclaimed. Proof of sale may be required in order to claim warranty.

The content of this manual has been carefully checked and is believed to be accurate. However, the seller assumes no responsibility for any inaccuracies that may be contained in this manual. Also, the technical information contained herein regarding the AMP100/6.2, AMP80/12 and/or AMP80/16 features and specifications are subject to change without further notice.

www.elura.com

