

IMPORTANT, RETAIN FOR FUTURE REFERENCE: READ CAREFULLY  
WICHTIG, FÜR SPÄTERE NACHSCHLAGE AUFBEWAHREN: SORGFÄLTIG LESEN  
IMPORTANTE, GUARDAR PARA REFERENCIA FUTURA: LEER ATENTAMENTE  
IMPORTANTE, CONSERVARE PER RIFERIMENTI FUTURI: LEGGERE ATTENTAMENTE  
IMPORTANT, À CONSERVER POUR RÉFÉRENCE FUTURE : LIRE ATTENTIVEMENT

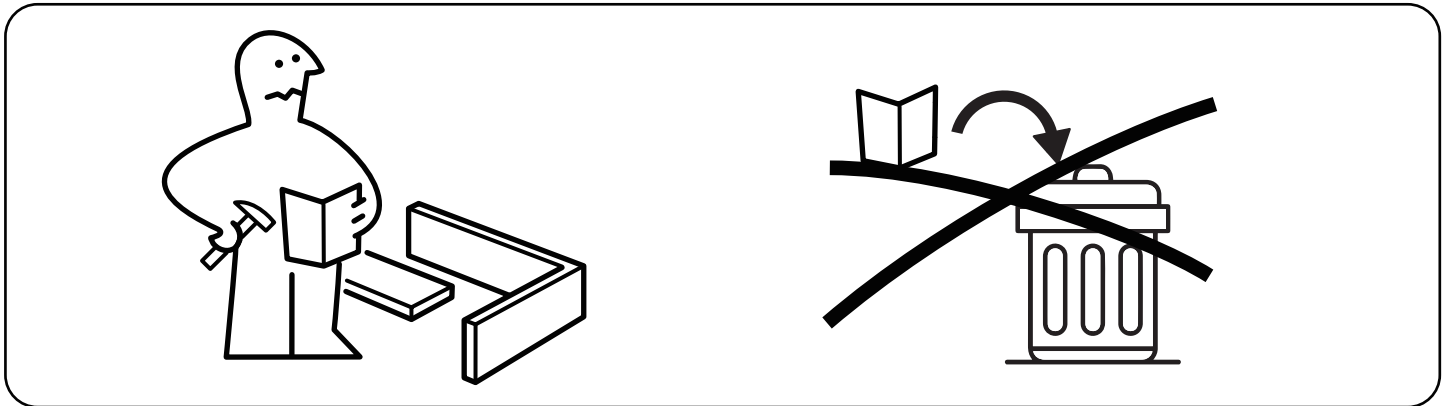

Assemble on a flat and solid surface. To avoid the unstable surface affecting the overall frame stability during installation.

Montieren Sie auf einer ebenen und festen Oberfläche. Um zu verhindern, dass eine unebene Oberfläche während der Montage die Gesamtrahmen-Stabilität beeinträchtigt.

Ensamblar en una superficie plana y sólida. Afin d'éviter que la surface inégale n'affecte la stabilité générale du cadre lors de l'installation.

Assemblare su una superficie piana e solida. Per evitare che una superficie irregolare influisca sulla stabilità complessiva della struttura durante l'installazione.

Assembler sur une surface plate et solide. Para evitar que la instalación en una superficie irregular afecte la estabilidad general del marco.

Professional installation is highly recommended.

Eine professionelle Installation wird dringend empfohlen.

Une installation professionnelle est fortement recommandée.

Si raccomanda vivamente l'installazione professionale.

Se recomienda altamente la instalación profesional.



Periodically Check That All Components Are Tightly Secured.

Überprüfen Sie Regelmäßig, Dass Alle Komponenten Fest Gesichert Sind.

Vérifiez Périodiquement Que Tous Les Composants Sont Bien Fixés.

Controllare Periodicamente Che Tutti I Componenti Siano Ben Fissati.

Verifique Periódicamente Que Todos Los Componentes Estén Bien Asegurados.

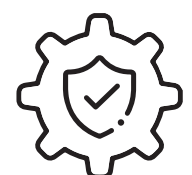

It is recommended that multiple people assemble this product.

Es wird empfohlen, dass mehrere Personen dieses Produkt zusammenbauen.

Il est recommandé que plusieurs personnes assemblent ce produit.

Si raccomanda che più persone assemblino questo prodotto.

Se recomienda que varias personas ensamblen este producto.

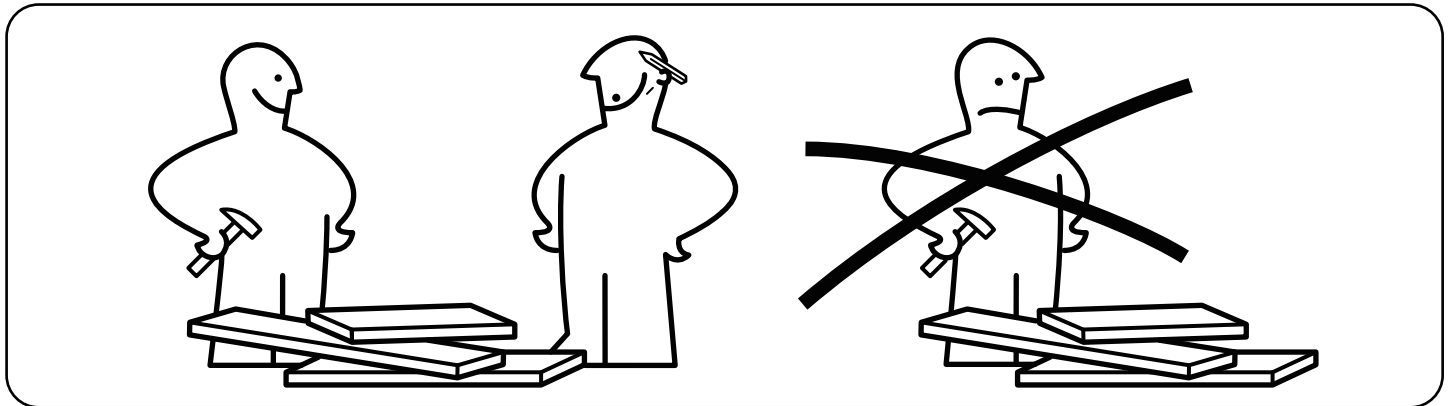

Please have the following auxiliary tools ready:

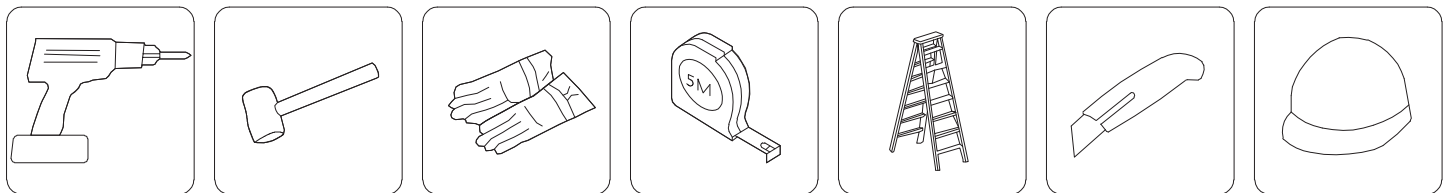

Please contact us if parts of your furniture are missing.



Bitte kontaktieren Sie uns, wenn Teile Ihrer Möbel fehlen.





Por favor contáctenos si faltan piezas de sus muebles.

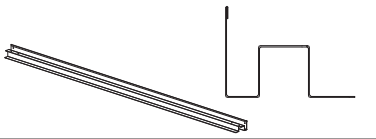
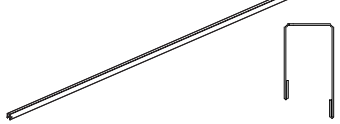
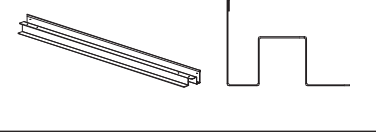
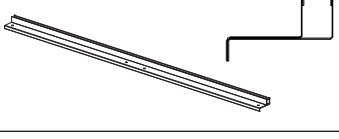
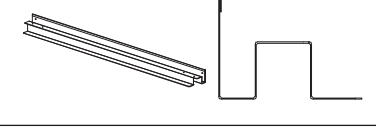
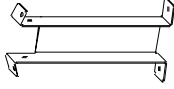
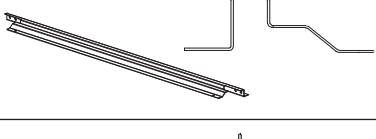
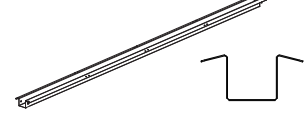
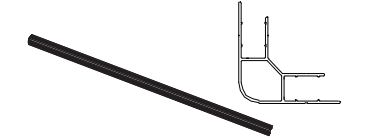
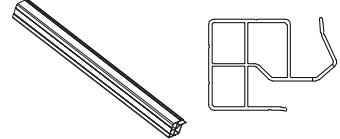
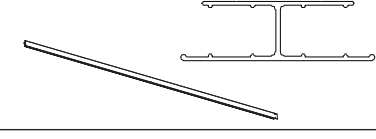
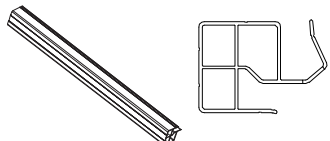
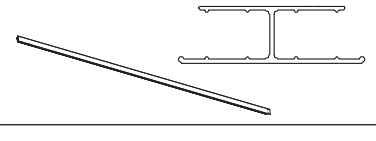
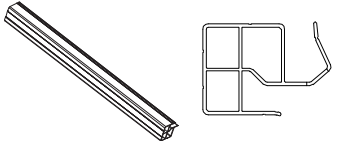
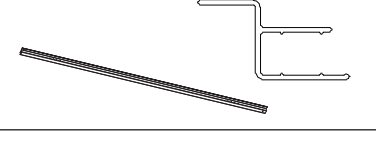
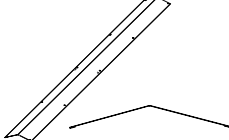
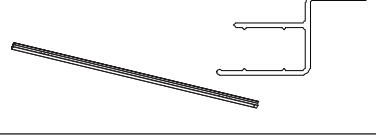
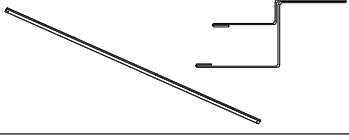
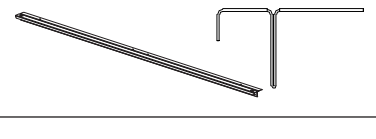
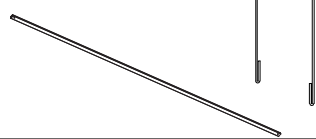
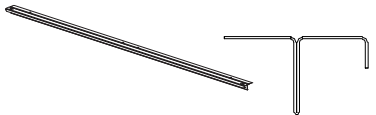

Si prega di contattarci se mancano parti dei vostri mobili.

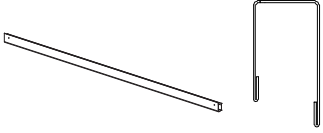
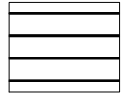
Veillez nous contacter si des pièces de vos meubles manquent.

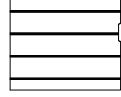
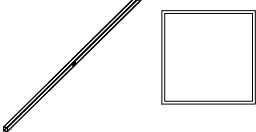
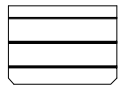
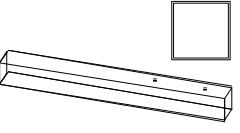
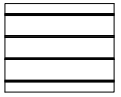
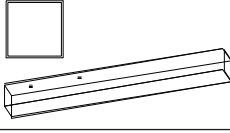
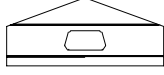
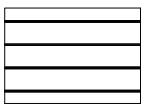
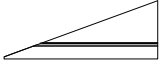
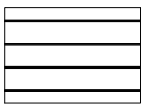

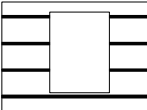
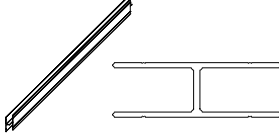
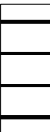
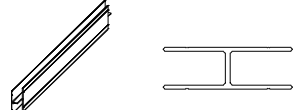
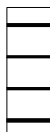
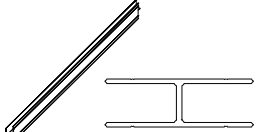
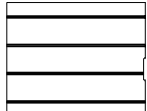
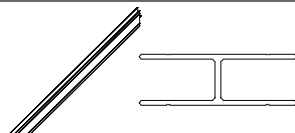
Item no.	Reference Image	Qty.	Item no.	Reference Image	Qty.
<b>XD-A2</b>		<b>X3</b>	<b>YG-B14</b>		<b>X2</b>
<b>XD-A3L</b>		<b>X1</b>	<b>YG-C15</b>		<b>X2</b>
<b>XD-A3R</b>		<b>X1</b>	<b>YG-C18</b>		<b>X2</b>
<b>XD-A4</b>		<b>X1</b>	<b>YG-B19</b>		<b>X1</b>
<b>YG-A5</b>		<b>X4</b>	<b>YG-C20</b>		<b>X2</b>
<b>YG-B8</b>		<b>X2</b>	<b>YG-C21</b>		<b>X2</b>
<b>YG-C9</b>		<b>X1</b>	<b>YG-B22</b>		<b>X2</b>
<b>YG-A10</b>		<b>X1</b>	<b>YG-B23</b>		<b>X1</b>
<b>YG-A11</b>		<b>X1</b>	<b>YG-C24</b>		<b>X1</b>
<b>YG-C12</b>		<b>X1</b>	<b>YG-A25</b>		<b>X2</b>
<b>YG-C13</b>		<b>X1</b>	<b>YG-A26</b>		<b>X1</b>

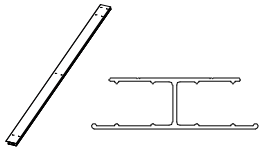
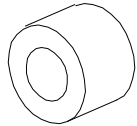
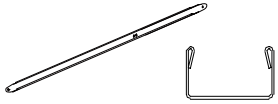
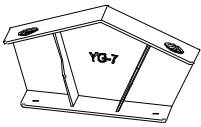
Item no.	Reference Image	Qty.	Item no.	Reference Image	Qty.
YG-C27		X4	YG-C33a		X2
YG-D28		X1	YG-C33b		X2
VA-G15		X3	YG-C34		X4
VA-F14AL		X1	YG-D34		X4
VA-F14AR		X1	YG-C35		X2
YG-A31		X12	YG-C35a		X2
YG-A31a		X5	YG-C35b		X2
YG-A31b		X1	YG-A41		X12
YG-C32		X4	YG-C42		X4
YG-C32a		X2	YG-C43		X4
YG-C33		X2	YG-C44		X4

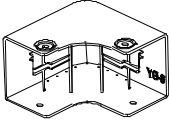
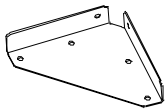
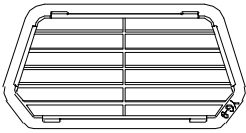
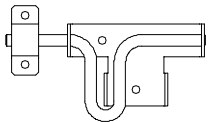
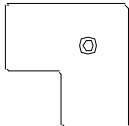
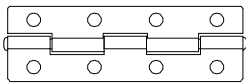
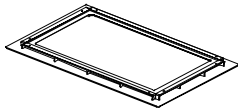
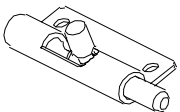
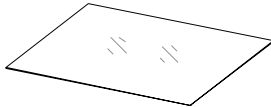
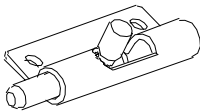
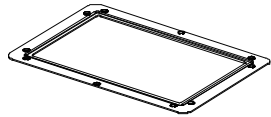
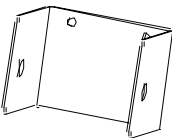
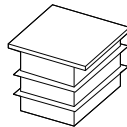
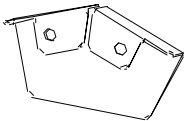
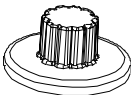
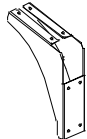
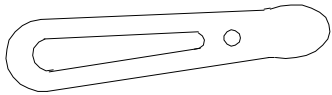
Item no.	Reference Image	Qty.	Item no.	Reference Image	Qty.
YG-C46		X6	YG-6		X2
YG-C48		X4	YG-7		X2
XD-1		X4	YG-8		X4
XD-2		X4	YG-9		X2
XD-5		X1	YG-10		X8
XD-6		X4	W1		X1
XD-7		X1	W2		X1
XD-8		X1	PPX10		X1
YG-1		X2	VA-43		X2
YG-2		X2	PA01		X3
YG-3		X2	CN-A33		X2

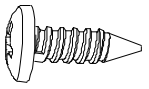
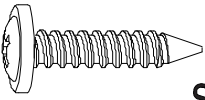
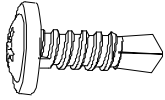
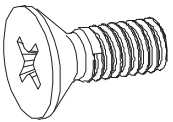
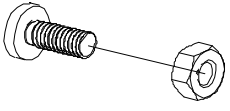
Item no.	Reference Image	Qty.
YG-D50	 ST4.0x10	X340
YG-D51	 ST4.2x19	X9
YG-D52	 ST4.2x13	X18
YG-D53	 M4x10	X16
YG-D54	 ST4.0x12	X16
YG-D55	 M4x10	X18

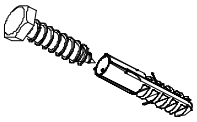
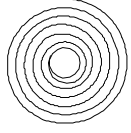
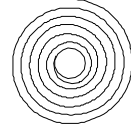
Item no.	Reference Image	Qty.
YG-D56	 ST6.0x40	X12
VA-51		X1
YG-54		X3



1

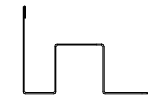

XD-A2 3pcs

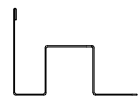

XD-A3L 1pc

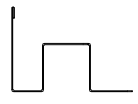

XD-A3R 1pc

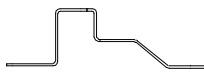

XD-A4 1pc



XD-1 4pcs

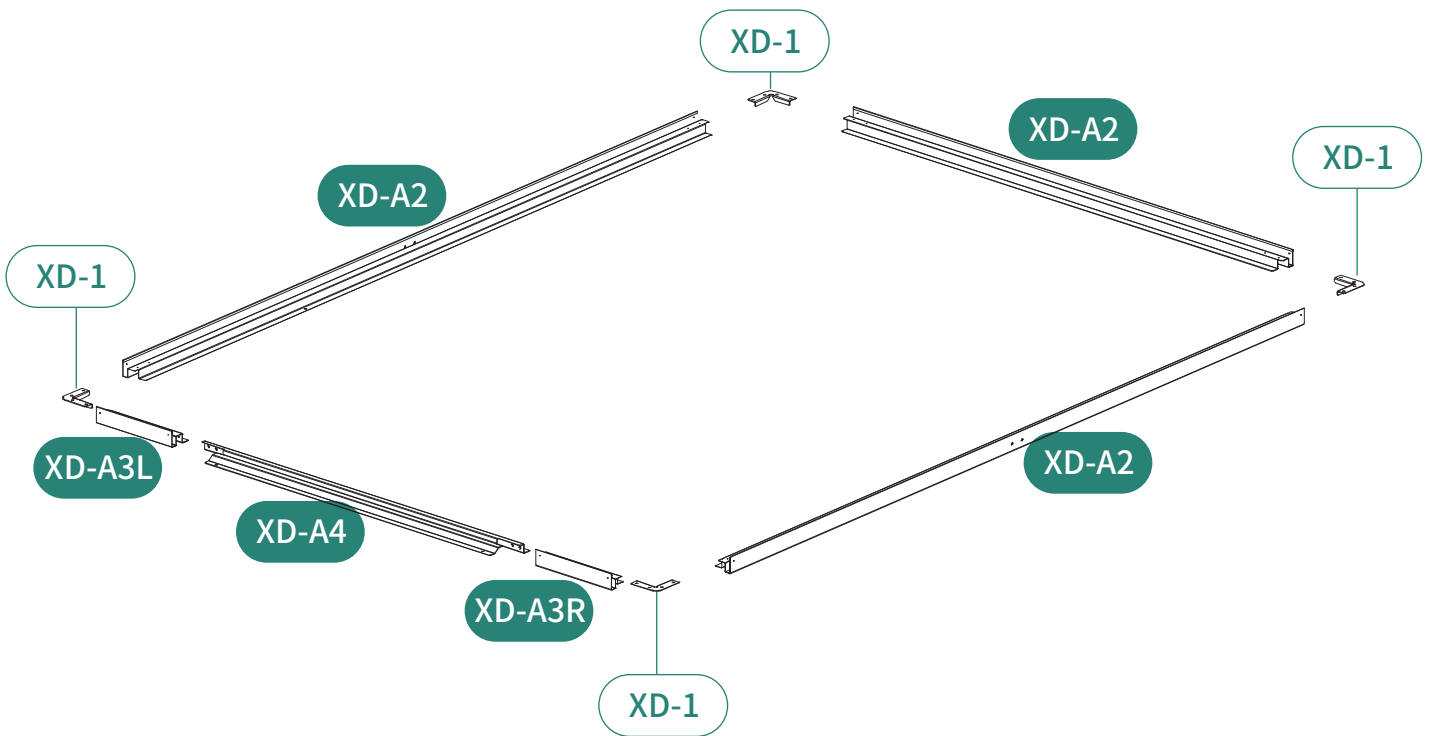



2

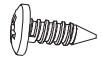

ST4.0x10

YG-D50 20pcs

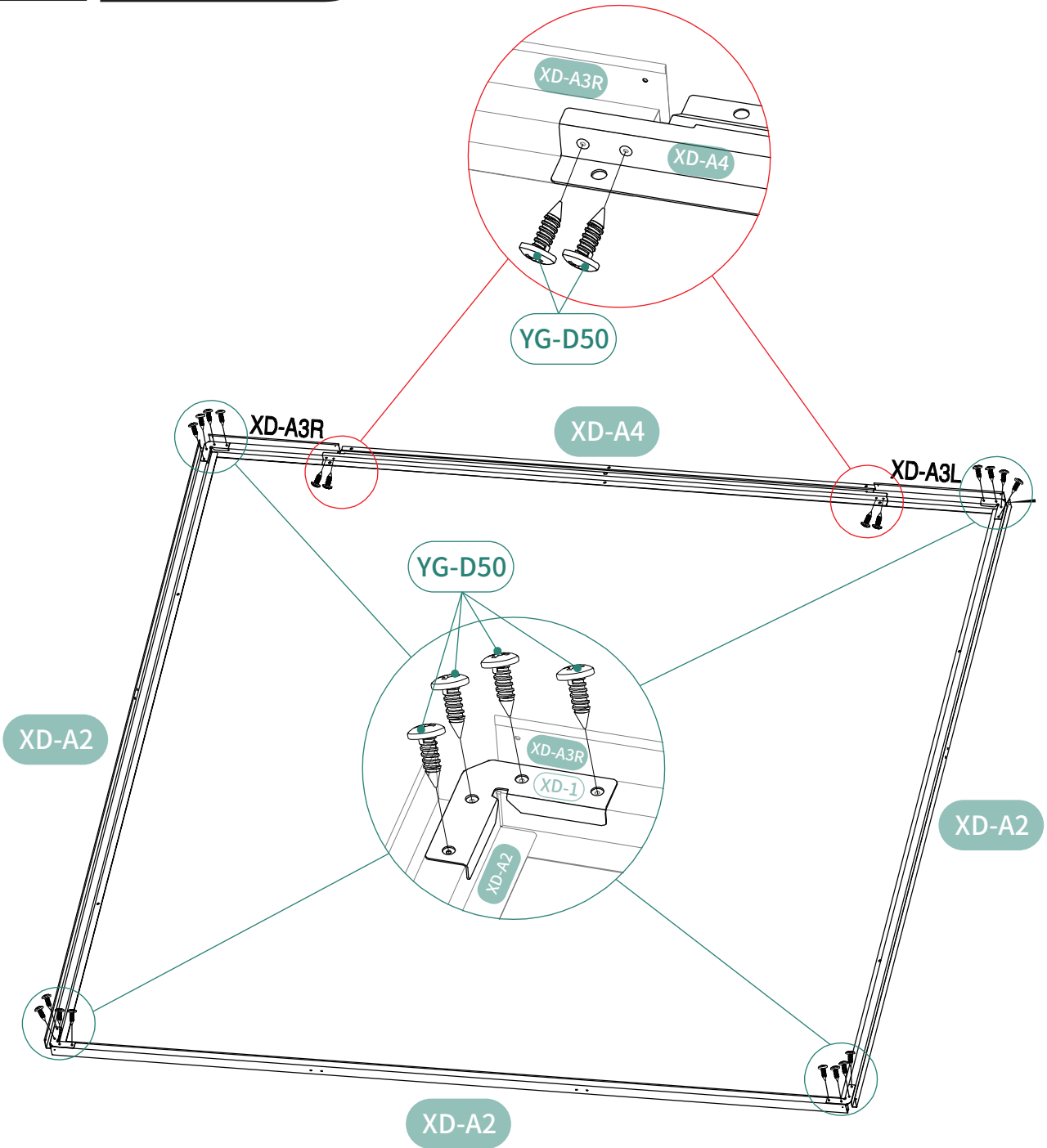

3

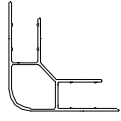

YG-A5 1pc

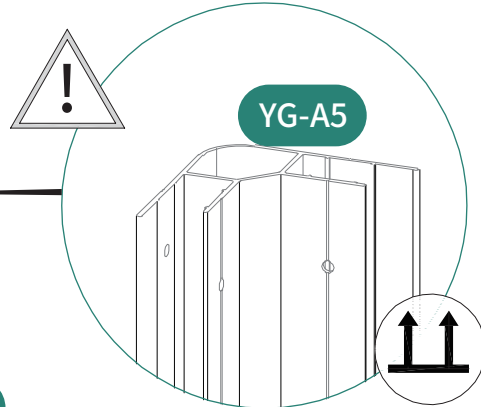
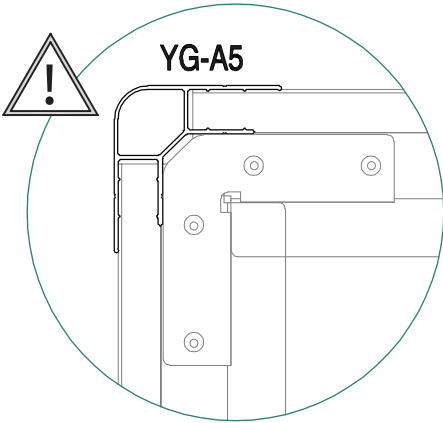

Observe the top and bottom positions of the columns

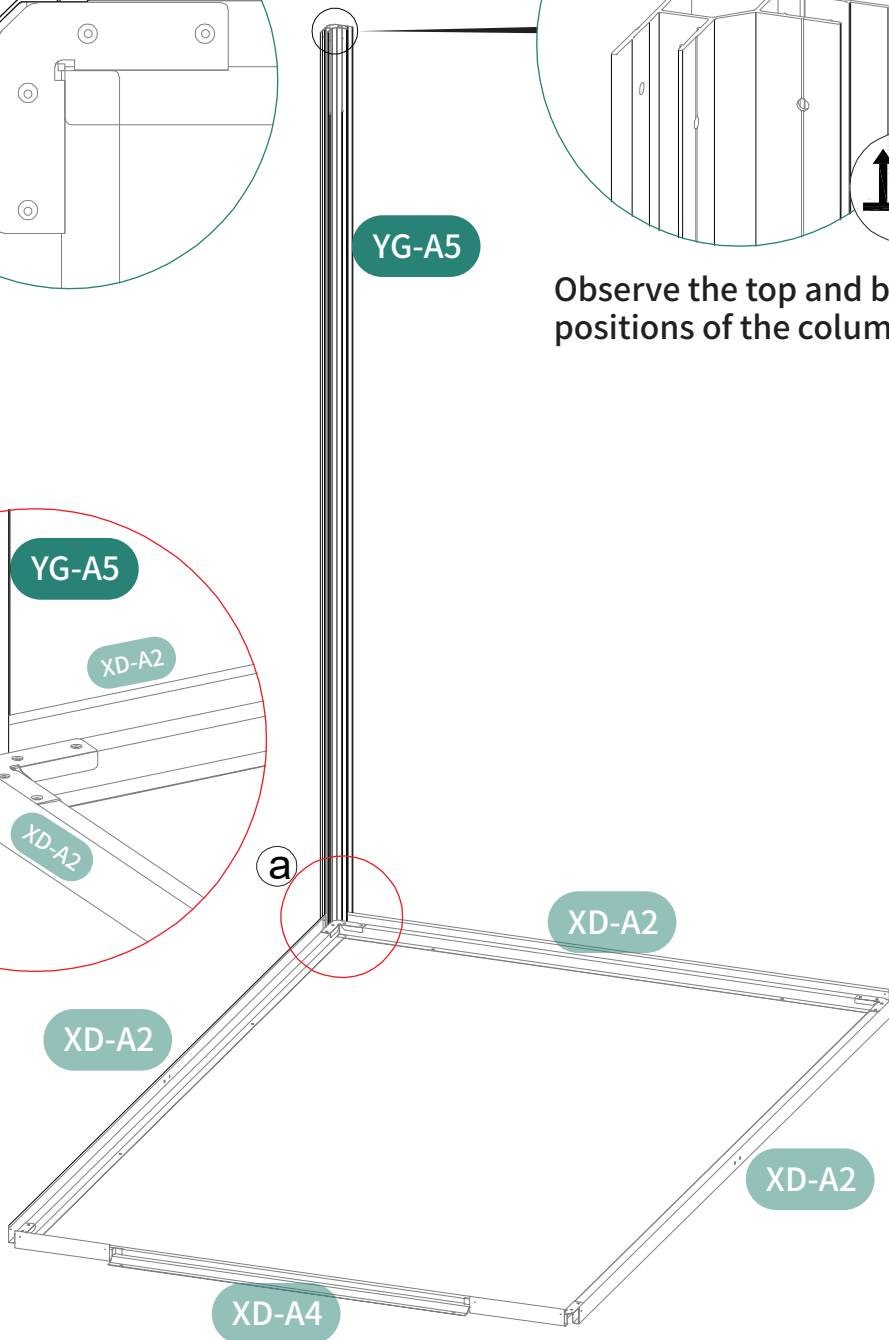
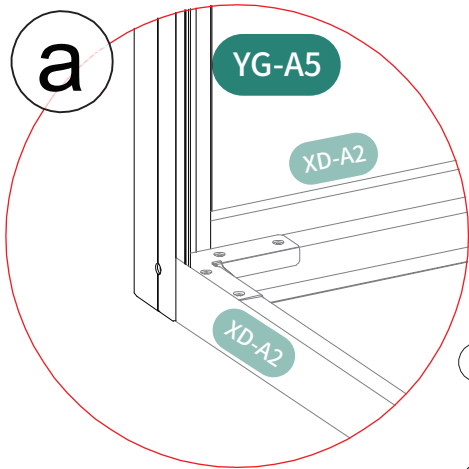

# 4

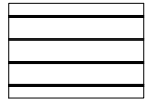

YG-A31 2pcs

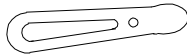

Auxiliary Tools

CN-A33

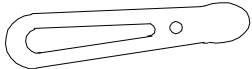

Auxiliary Tools

CN-A33

Assemble with the side with the grooves/indentations facing outward.

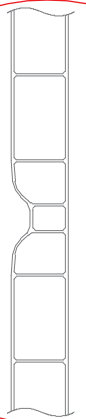

YG-A31 ↑



Pay attention to the direction of the arrow on the board markings, and follow the direction indicated by the arrow.

Ensure the panels are fully inserted into the slots to avoid issues with inserting subsequent panels.

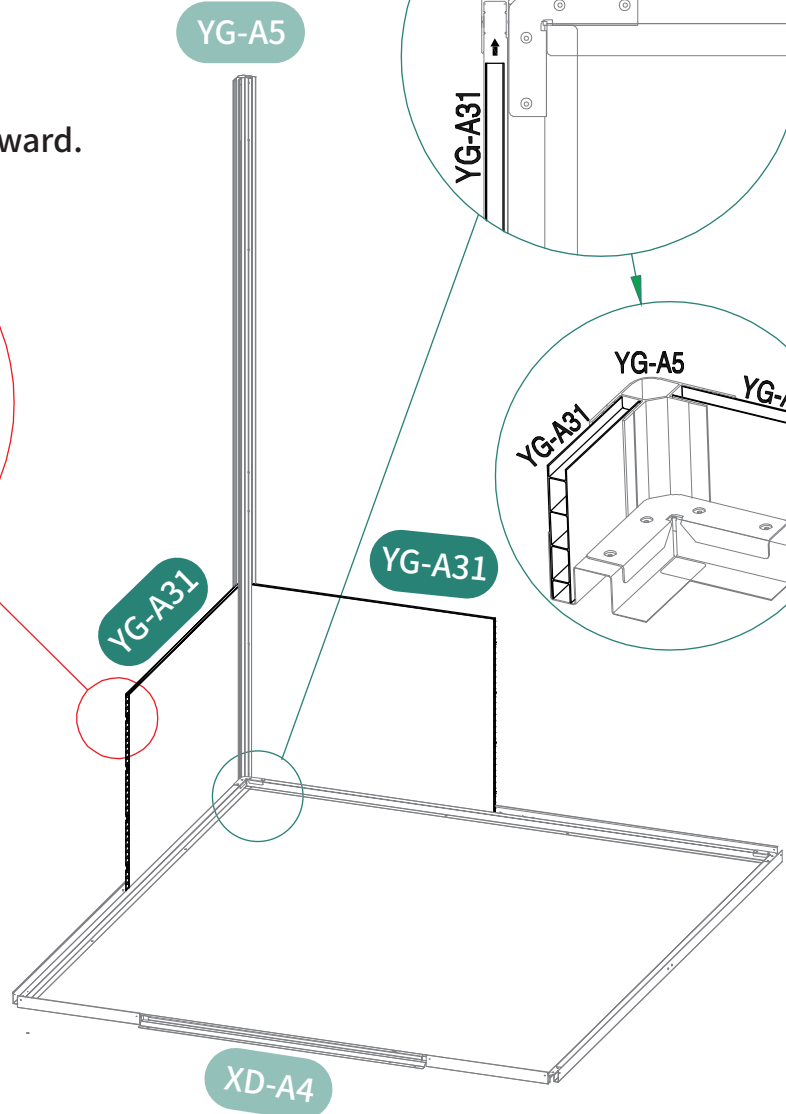
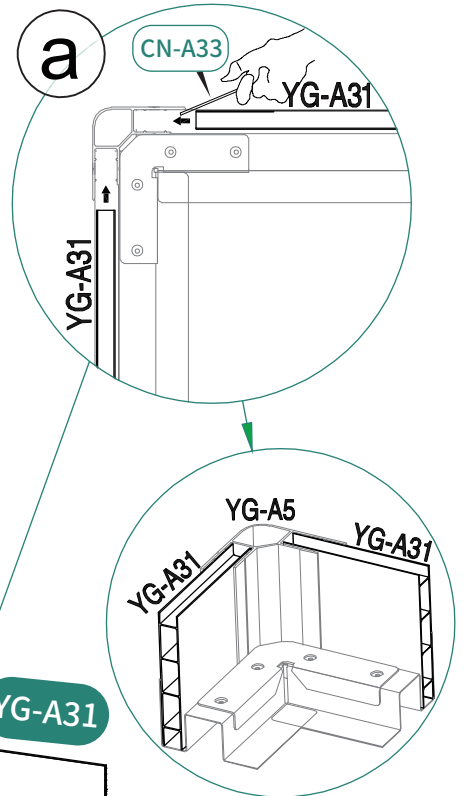

# 5



YG-D50 4pcs

CN-A33

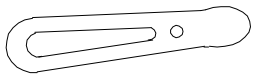
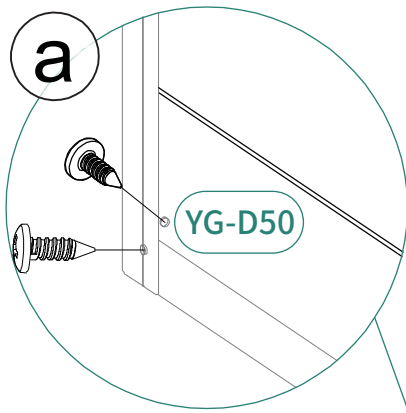

Auxiliary Tools

CN-A33

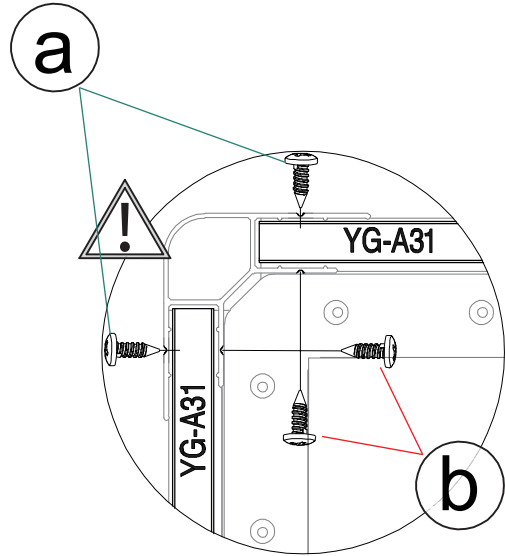

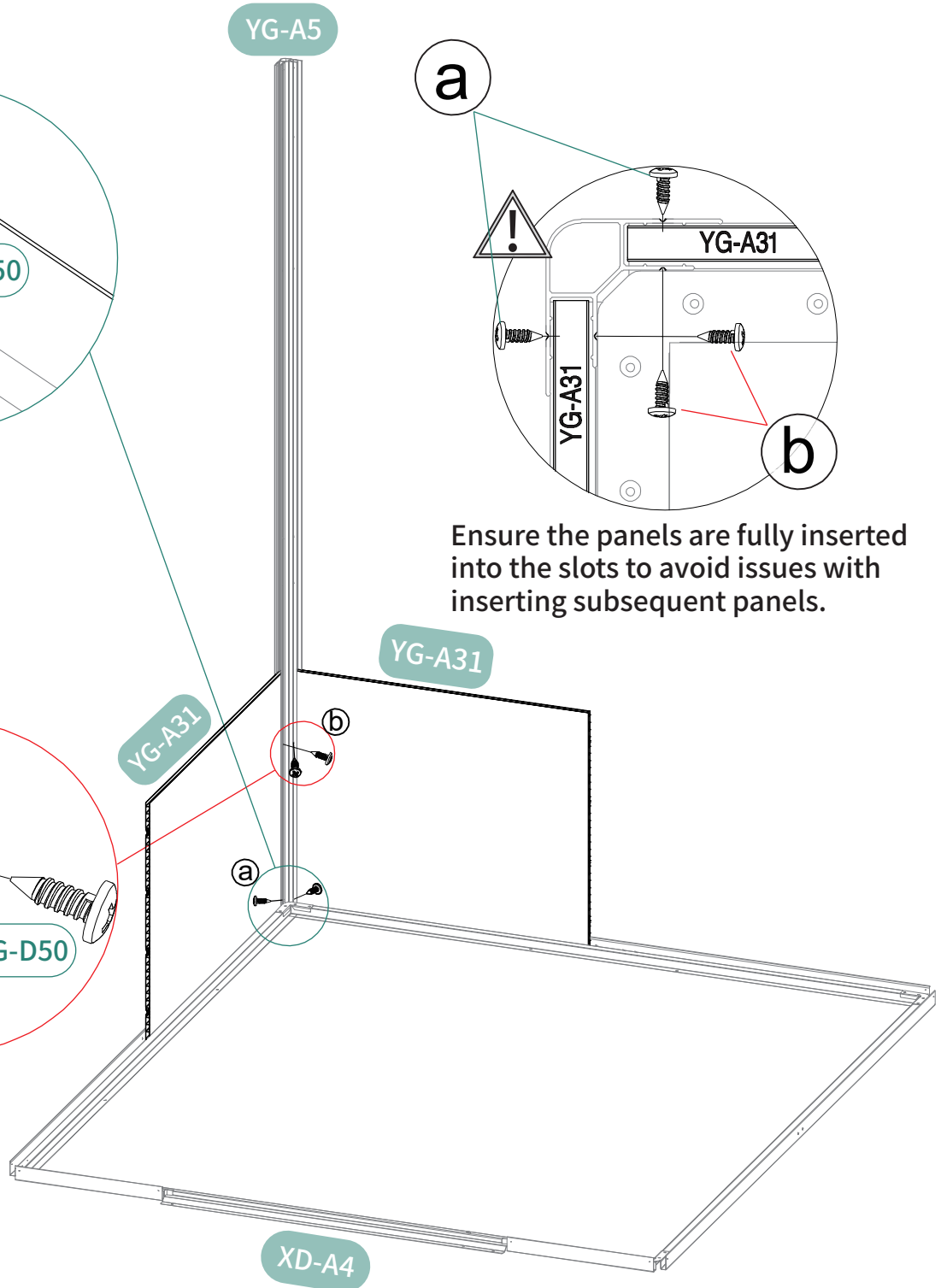
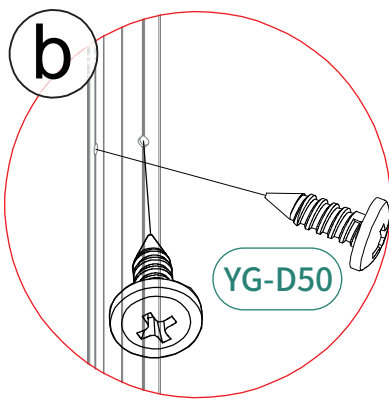

Ensure the panels are fully inserted into the slots to avoid issues with inserting subsequent panels.



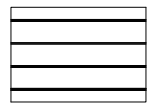
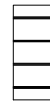

# 7

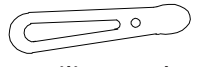
				
YG-A5 1pc	YG-A31 1pc	YG-C32 1pc	YG-D50 4pcs	CN-A33

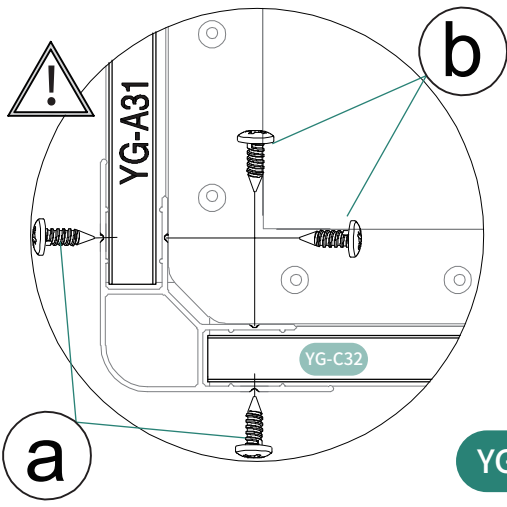

Auxiliary Tools  
CN-A33

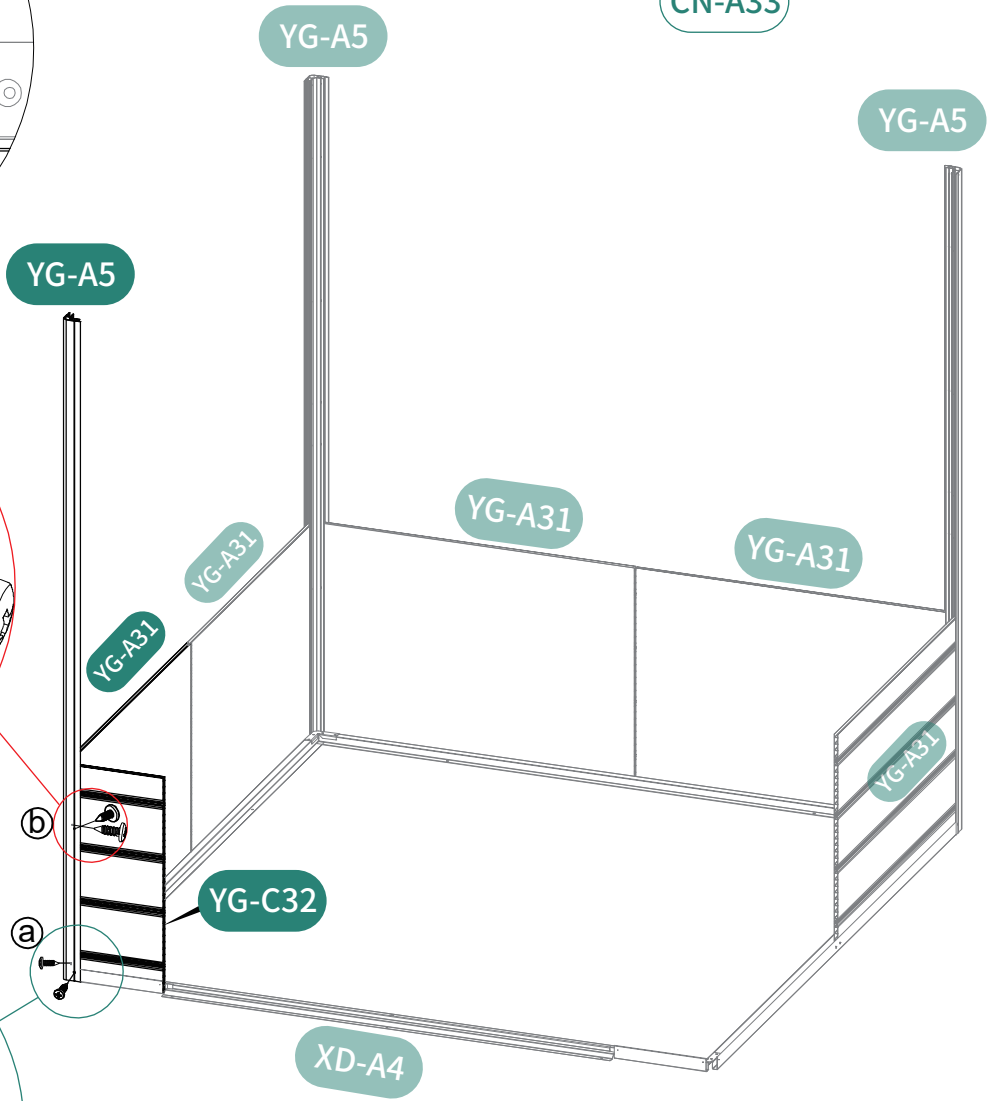
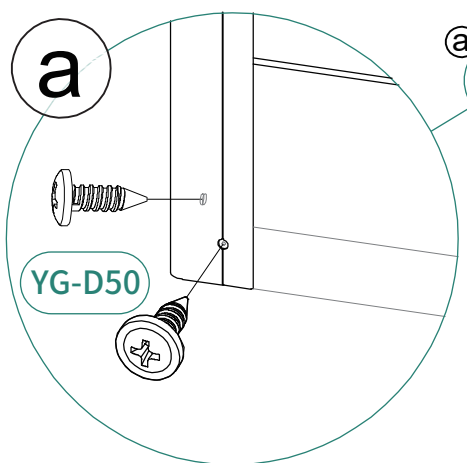
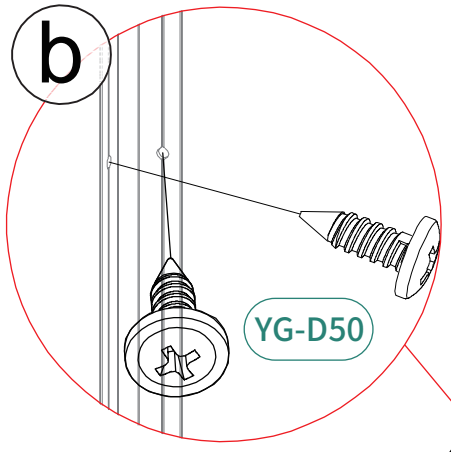

8

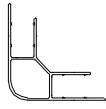

YG-A5 1pc

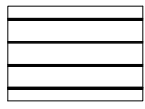

YG-A31 1pc



YG-C32 1pc

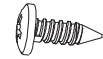

ST4.0x10

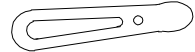

Auxiliary Tools

CN-A33

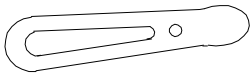

Auxiliary Tools

CN-A33

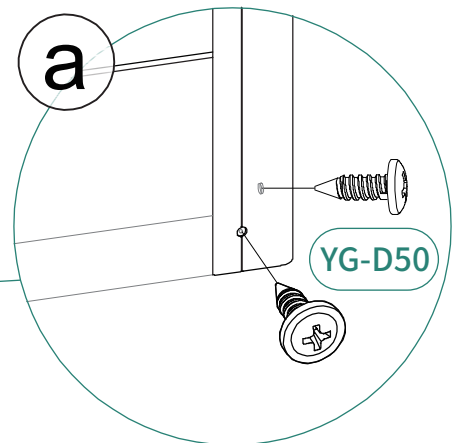
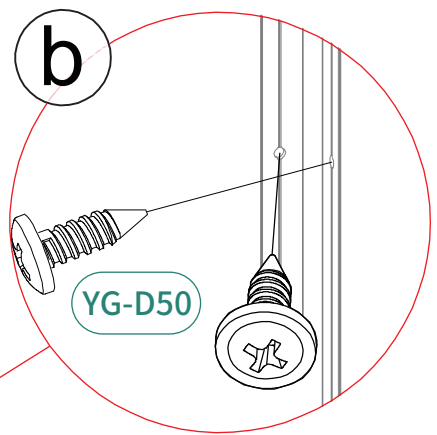
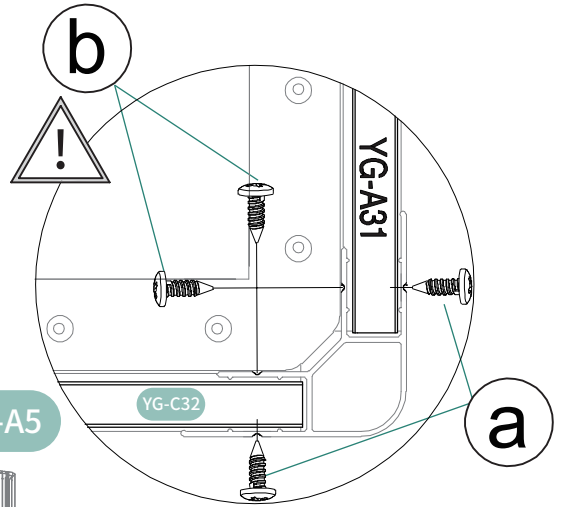
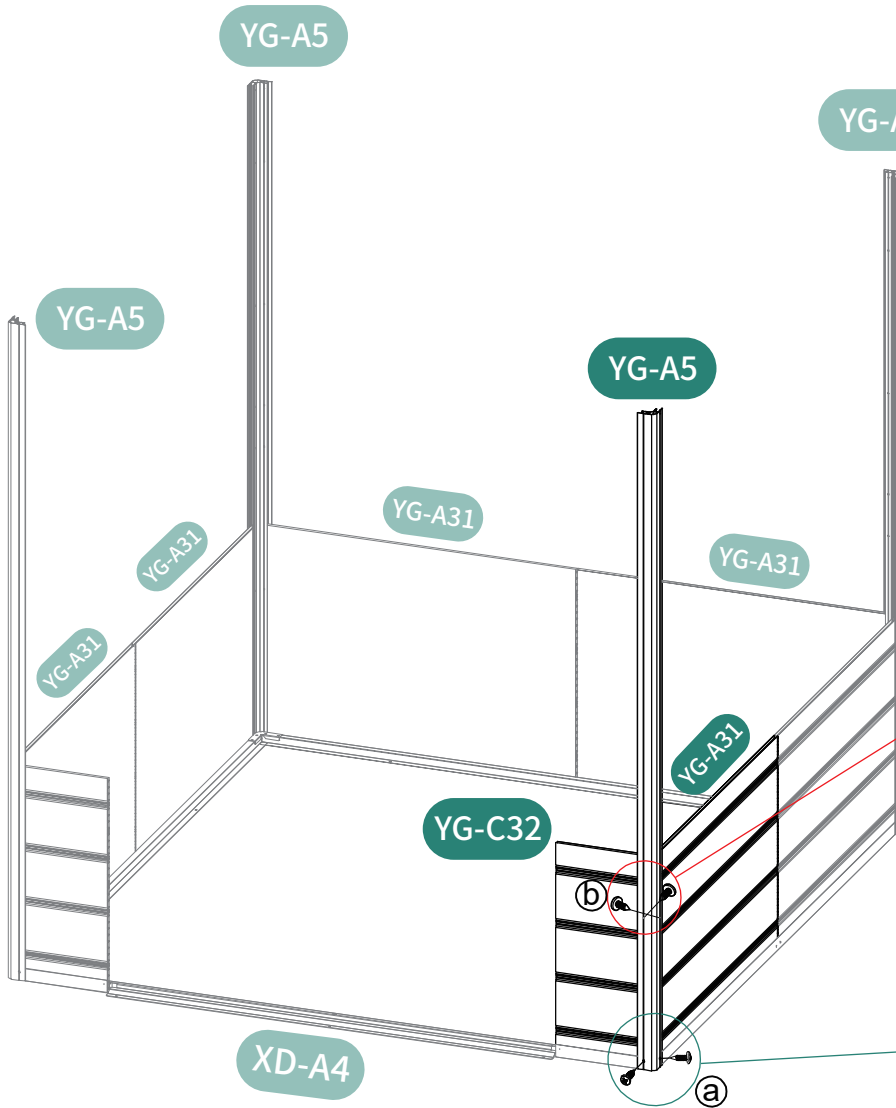

# 9

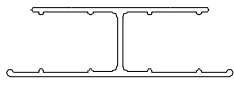

YG-B8 2pcs



ST4.0x10

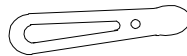

Auxiliary Tools

YG-D50 8pcs

CN-A33

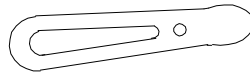
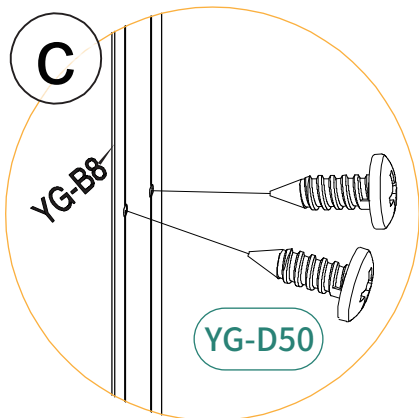
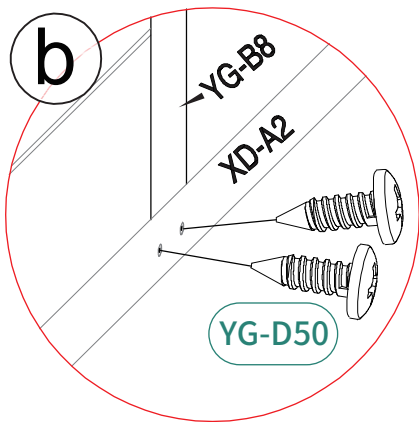
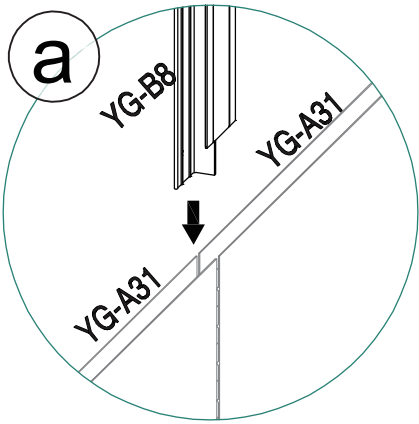

Auxiliary Tools

CN-A33

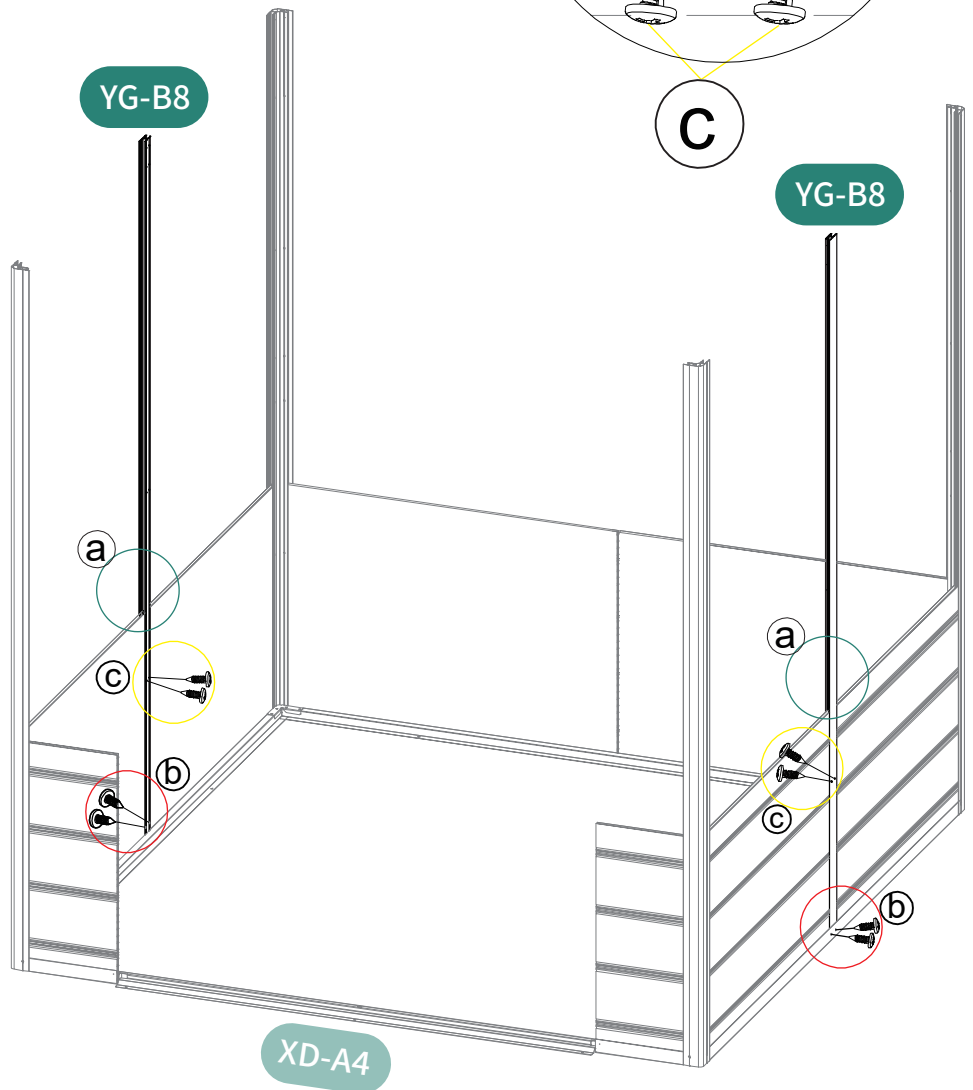
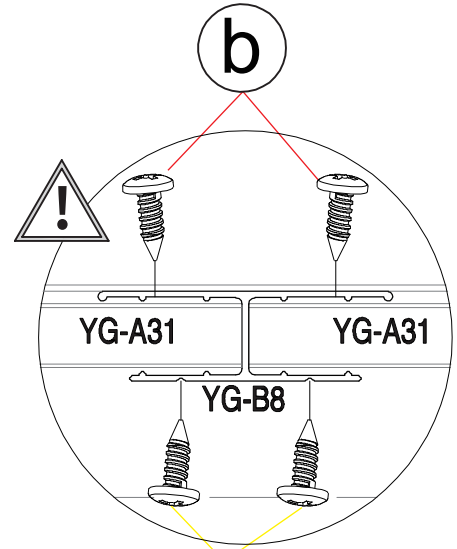



# 10

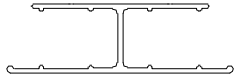

YG-C9 1pcs



ST4.0x10

YG-D50 2pcs



Auxiliary Tools

CN-A33

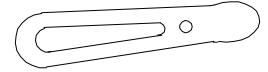
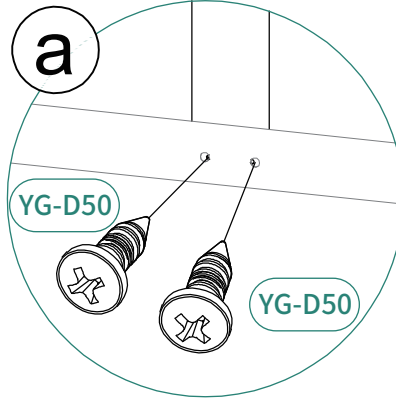
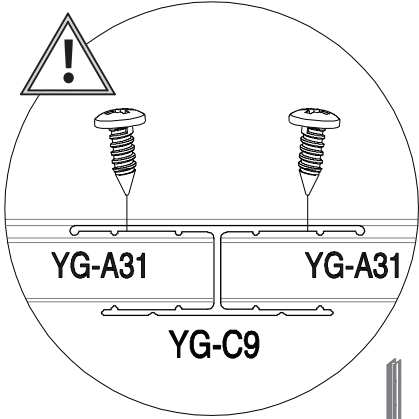

Auxiliary Tools

CN-A33

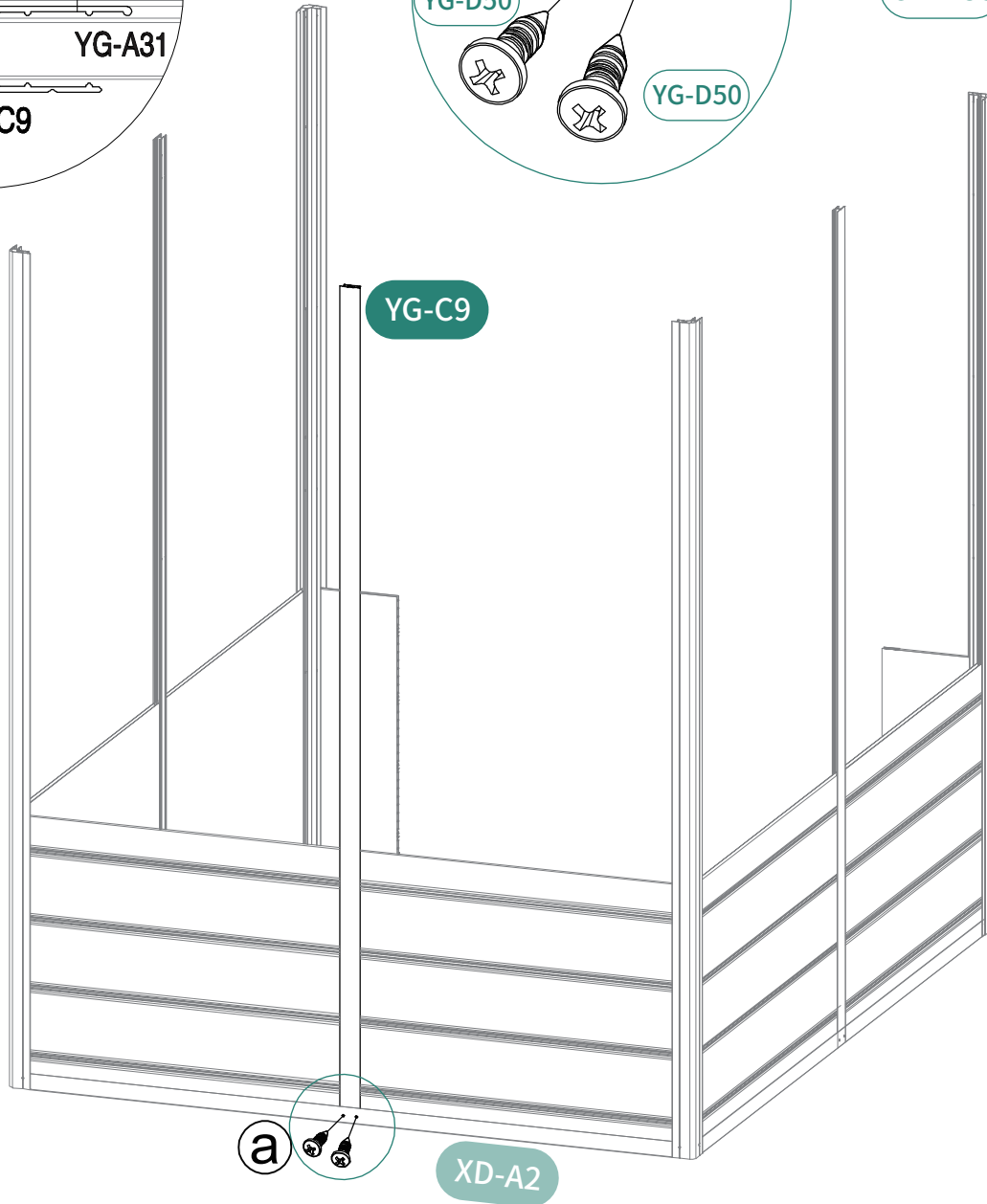

YG-C9

a

XD-A2

# 11

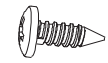

ST4.0x10

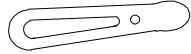

Auxiliary Tools

YG-D50 2pcs

CN-A33

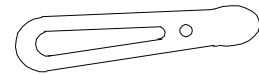
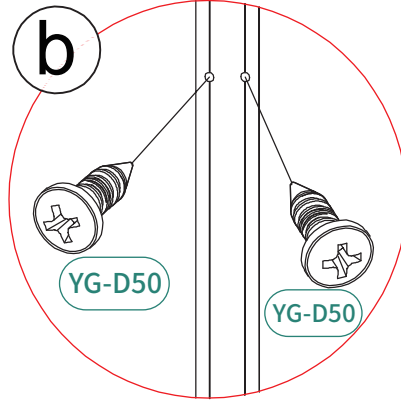
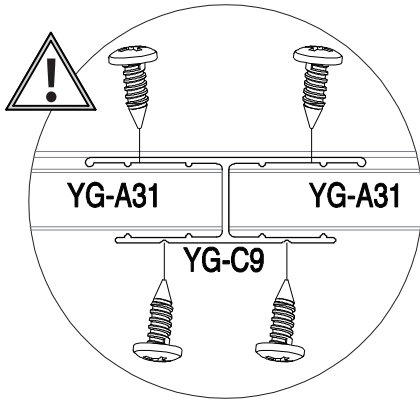

Auxiliary Tools

CN-A33

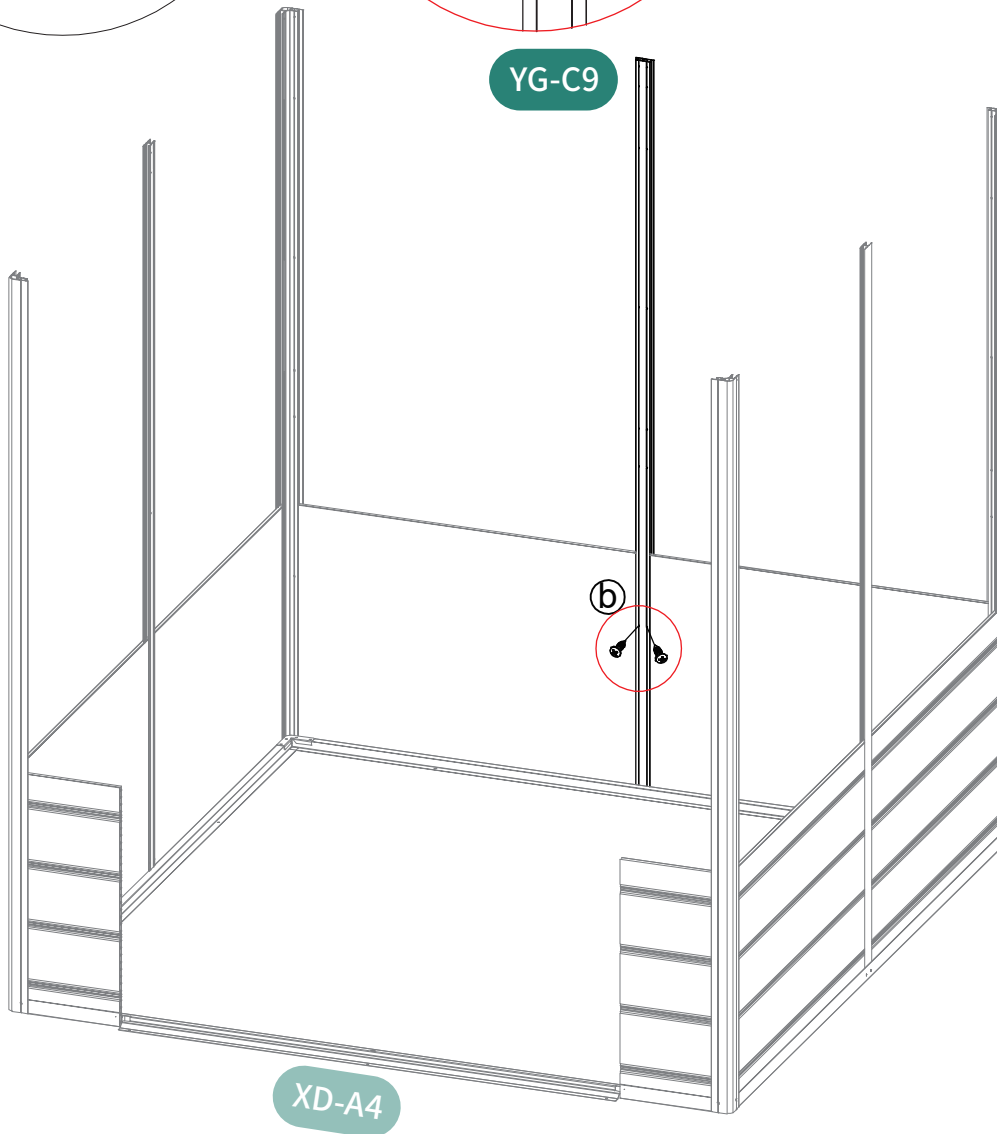

# 12

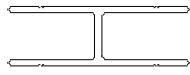

YG-A41 6pcs

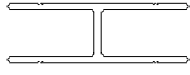

YG-C42 2pcs

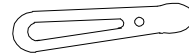

Auxiliary Tools

CN-A33

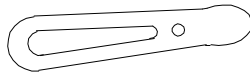
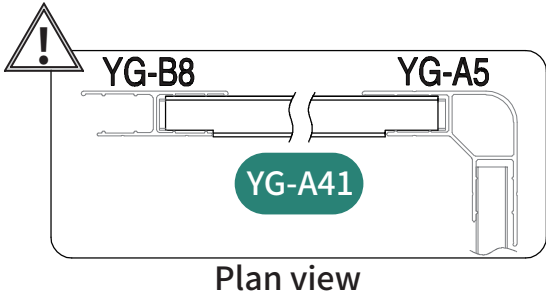

Auxiliary Tools

CN-A33

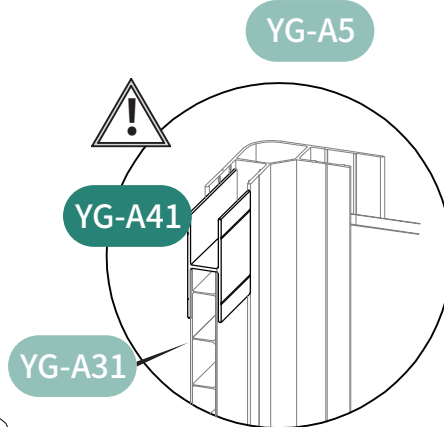

Ensure that the side panel is fully inserted into the slot. It is recommended to use a tool to assist with the operation.

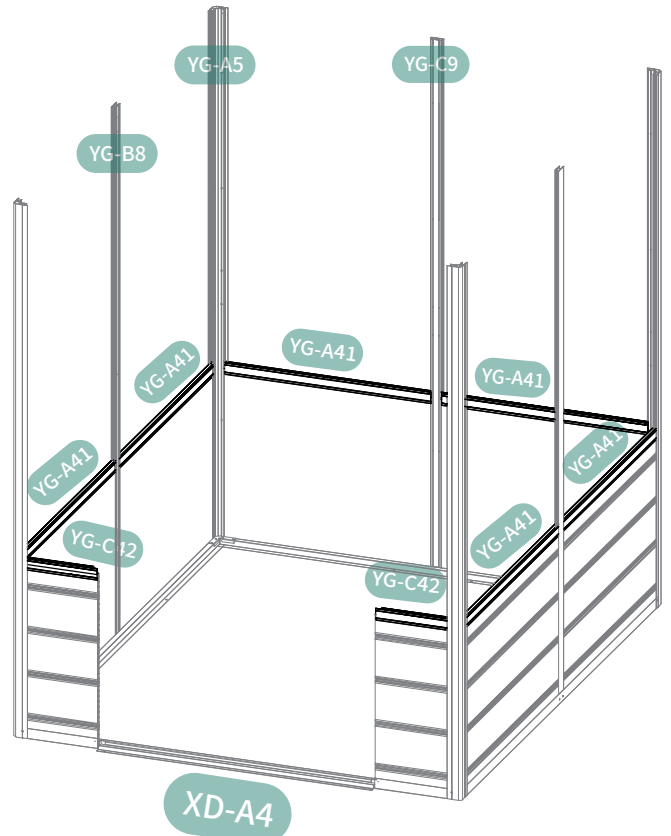
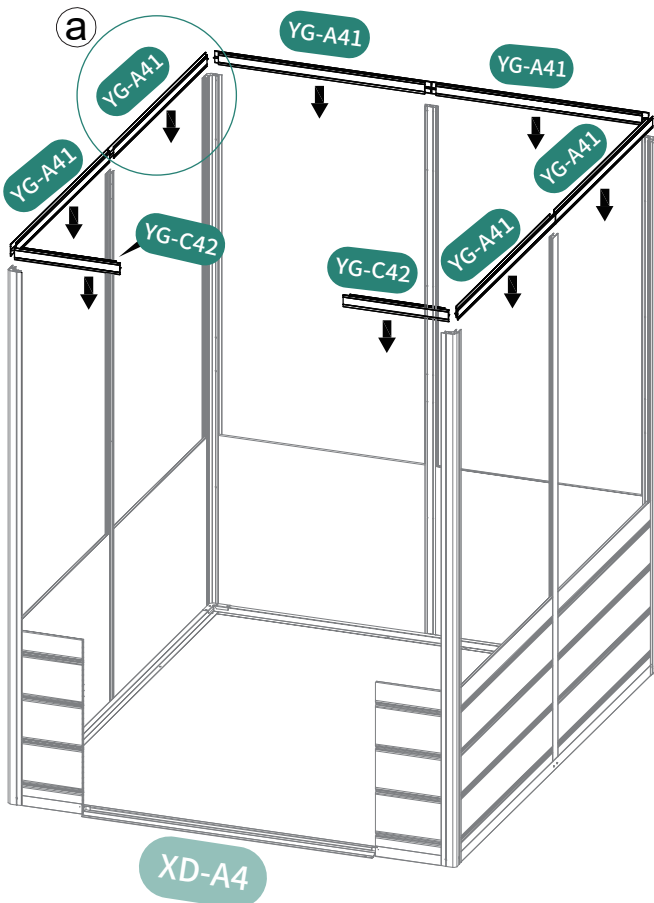
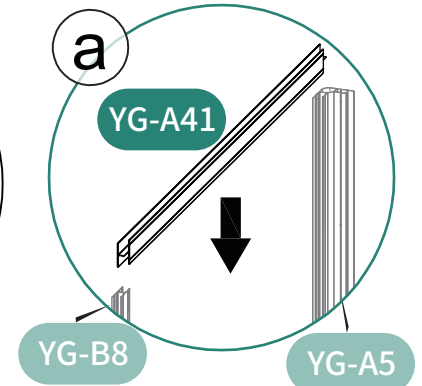

# 13

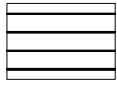

YG-A31 6pcs



YG-C32 2pcs

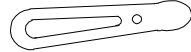

Auxiliary Tools

CN-A33

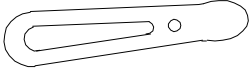

Auxiliary Tools

CN-A33

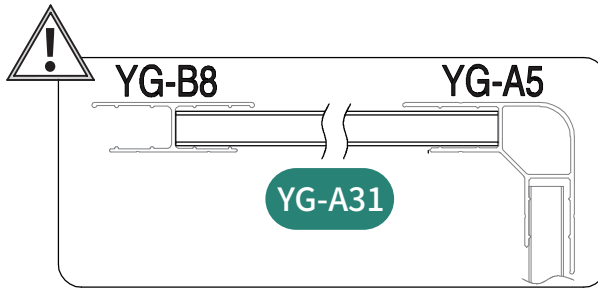

YG-A31

Plan view

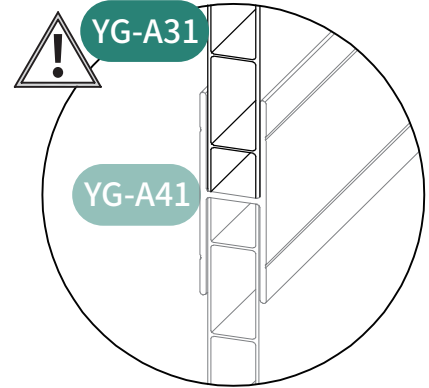

YG-A31

YG-A41

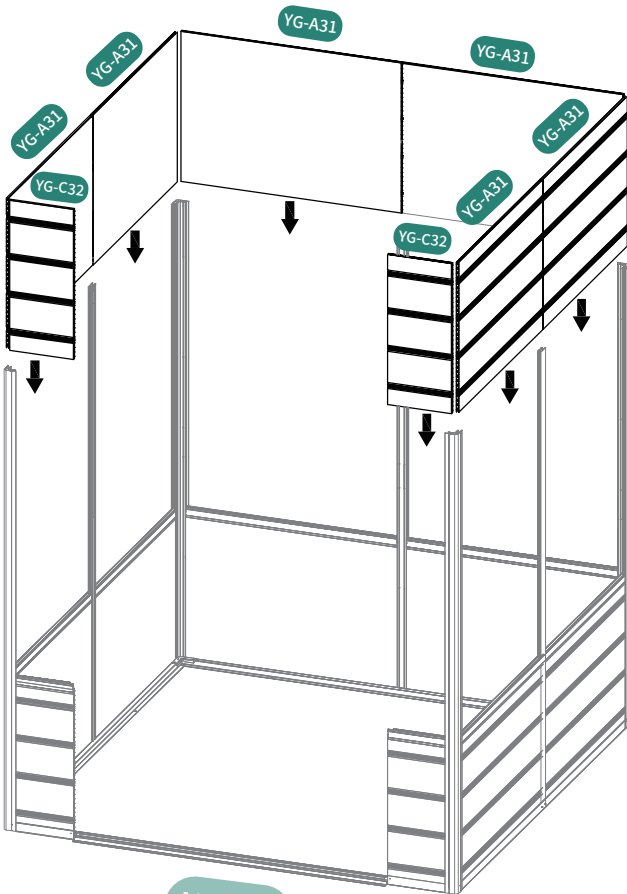

XD-A4

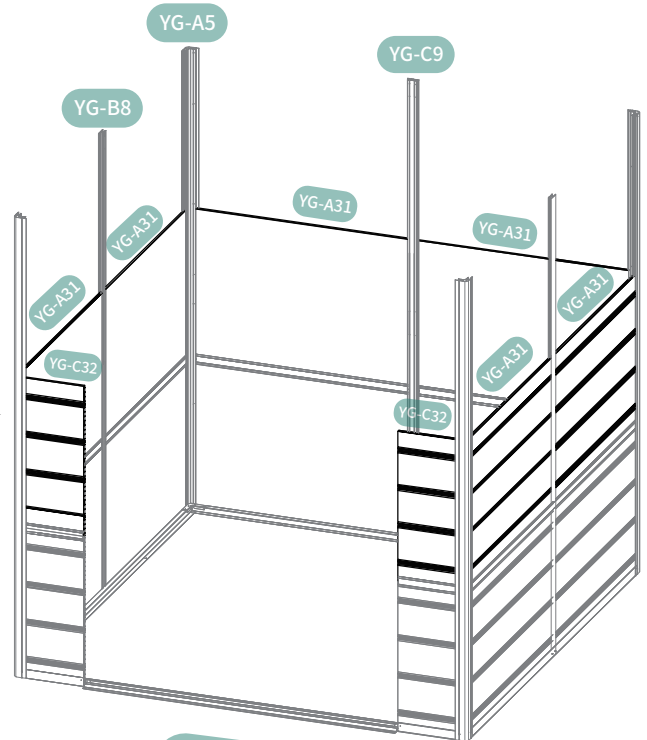

XD-A4

# 14

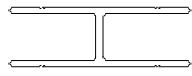

YG-A41 6pcs

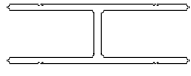

YG-C42 2pcs

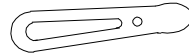

Auxiliary Tools

CN-A33

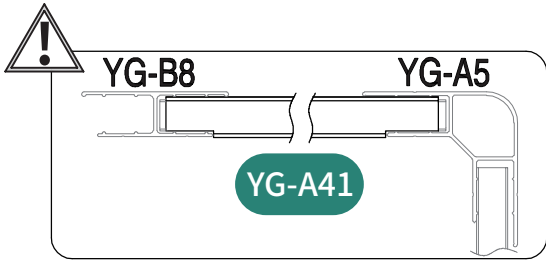

Plan view

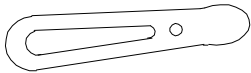
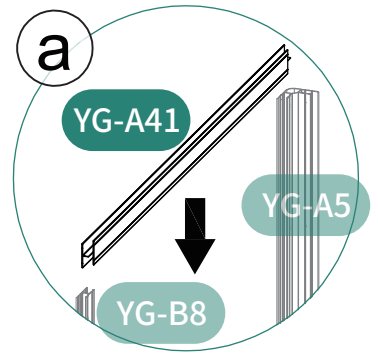
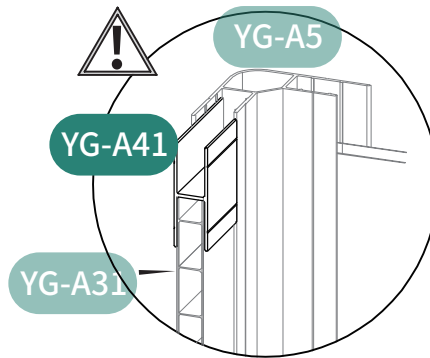

Auxiliary Tools

CN-A33

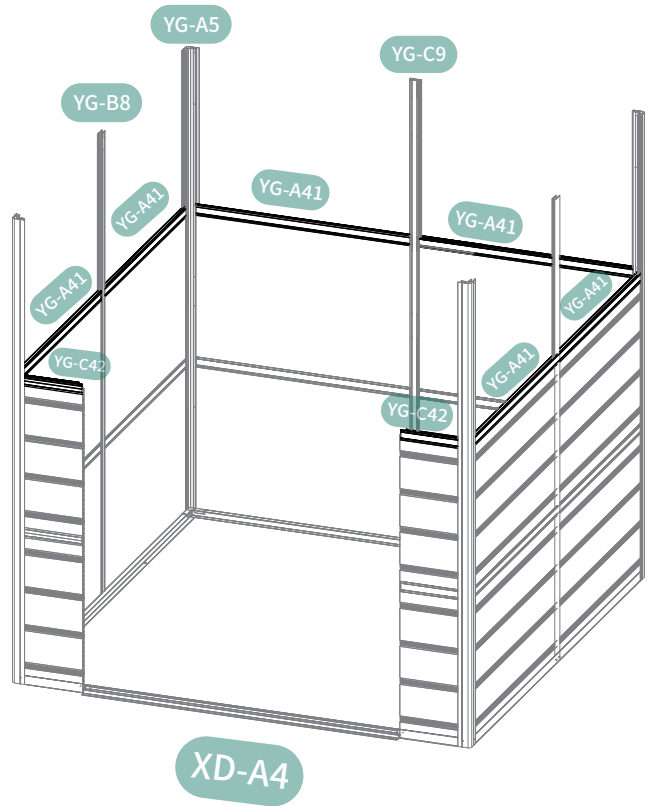
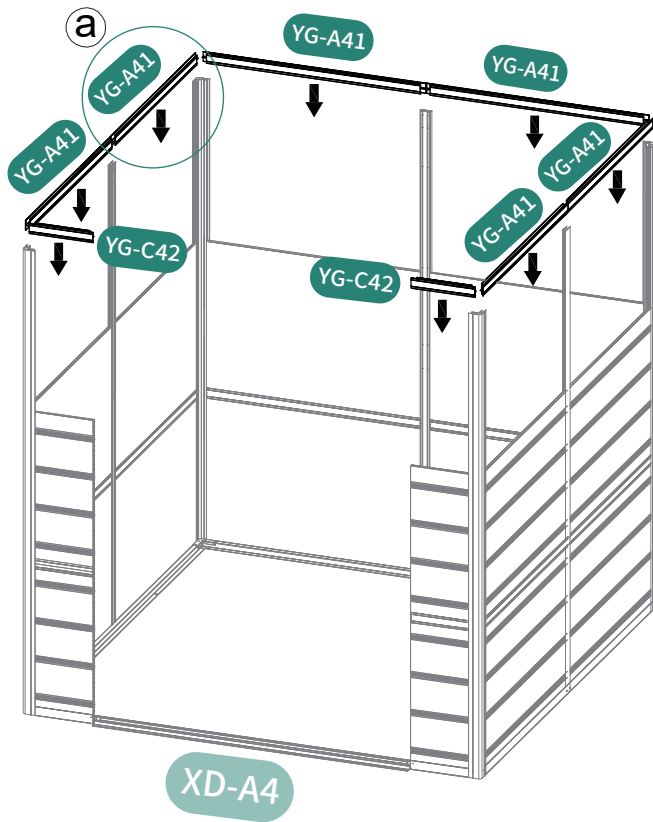

# 15

During window installation, the window's orientation can be adjusted according to the location where it is being placed, so that it accurately corresponds with the direction of the light exposure.

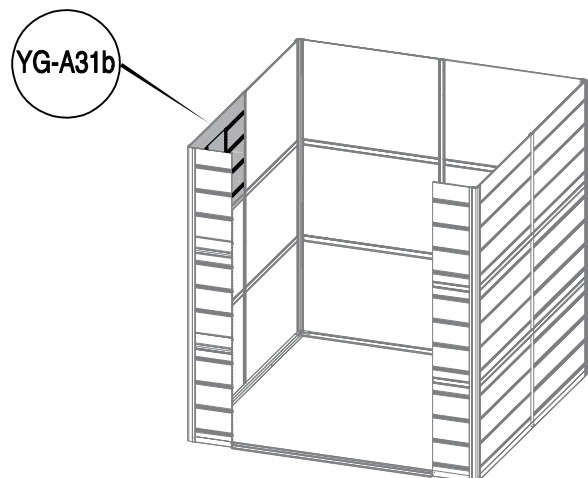
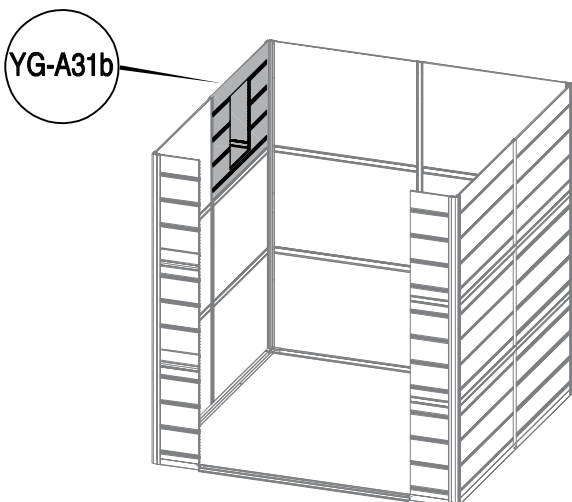
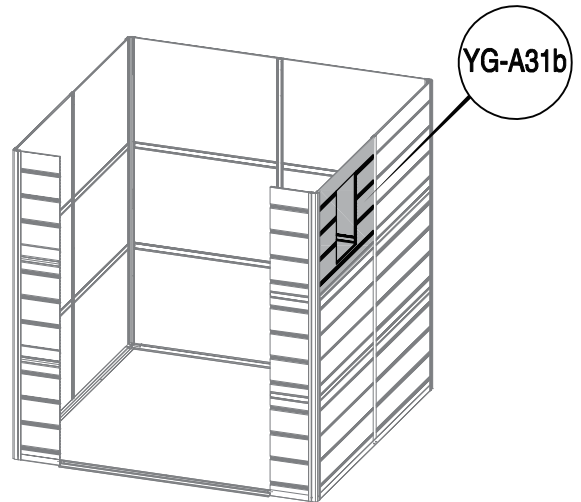
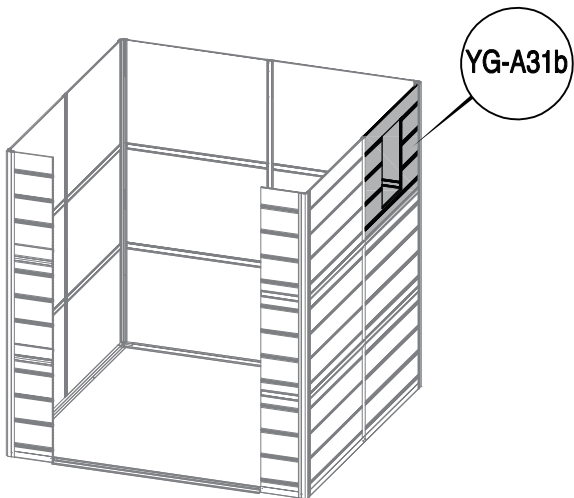

# 16

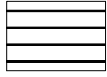

YG-A31a 5pcs

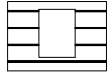

YG-A31b 1pc



YG-C32a 2pcs

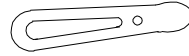

Auxiliary Tools

CN-A33

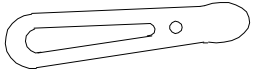

Auxiliary Tools

CN-A33

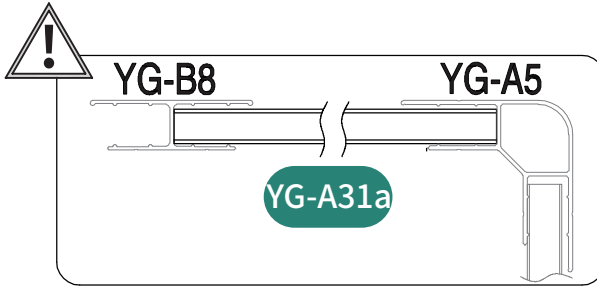

Plan view

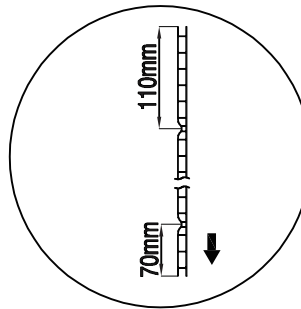
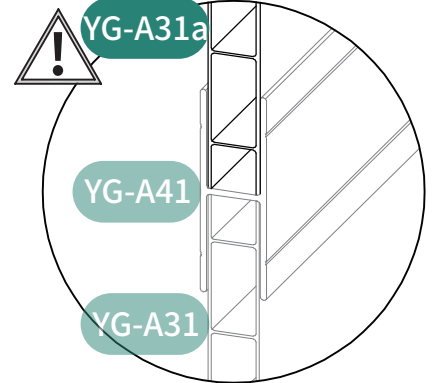

During installation, ensure the narrow edge of the panel is oriented facing downward.

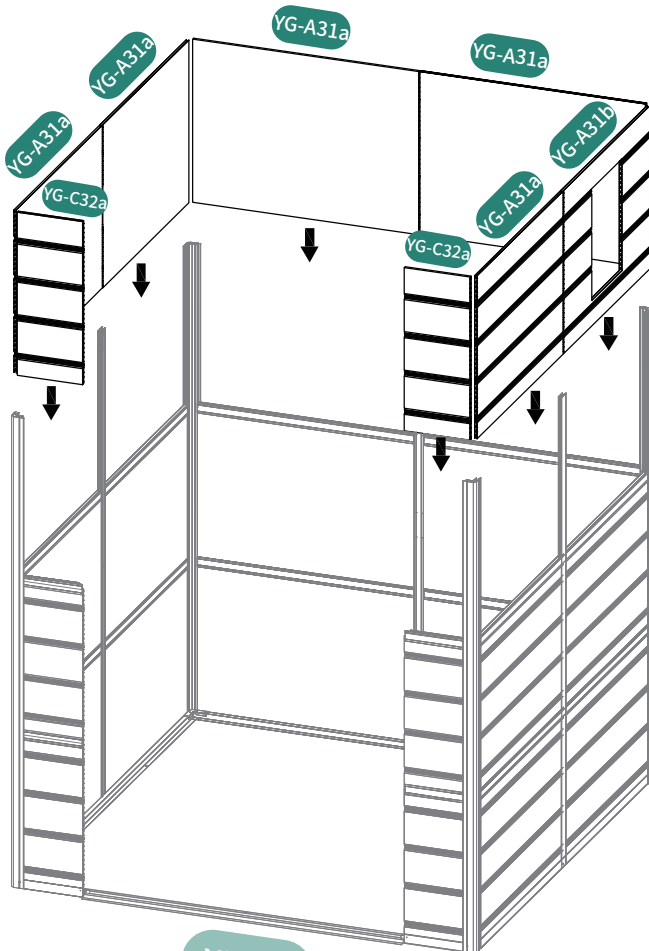

XD-A4

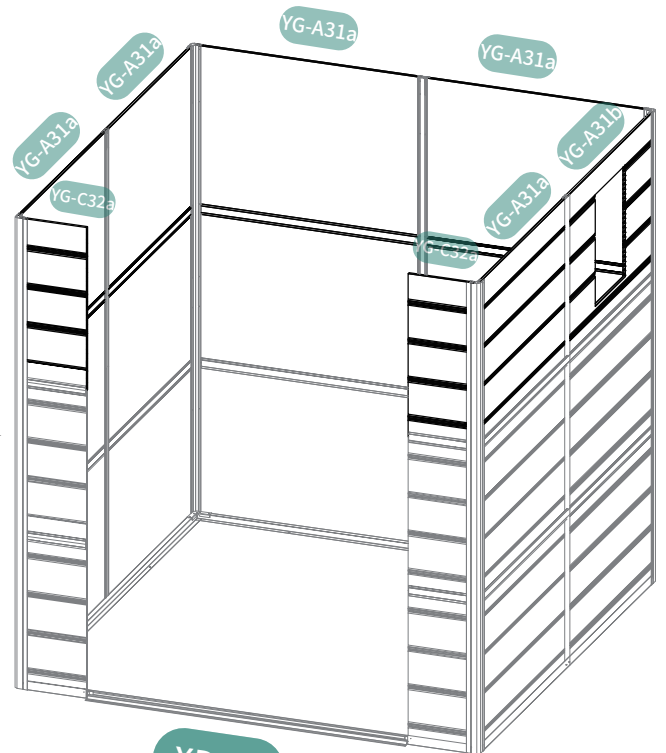

XD-A4

# 17

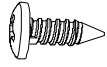

YG-D50 42pcs

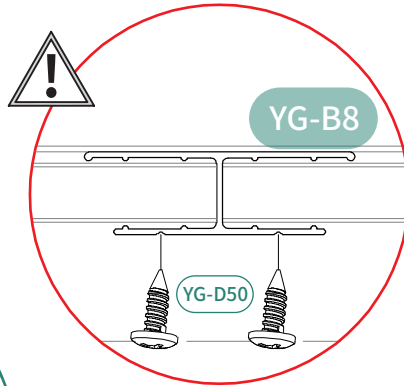
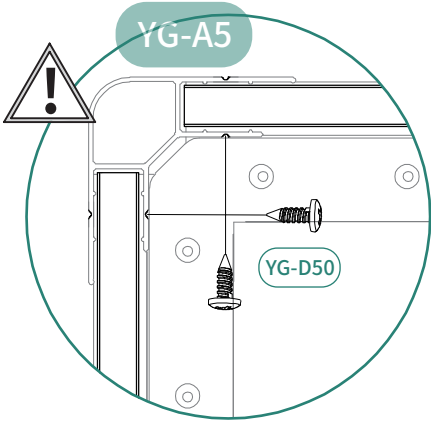

After the panel is installed, secure it from the inside using screws. When fastening, please align the screws with the grooves to avoid any deviations that could lead to loosening.

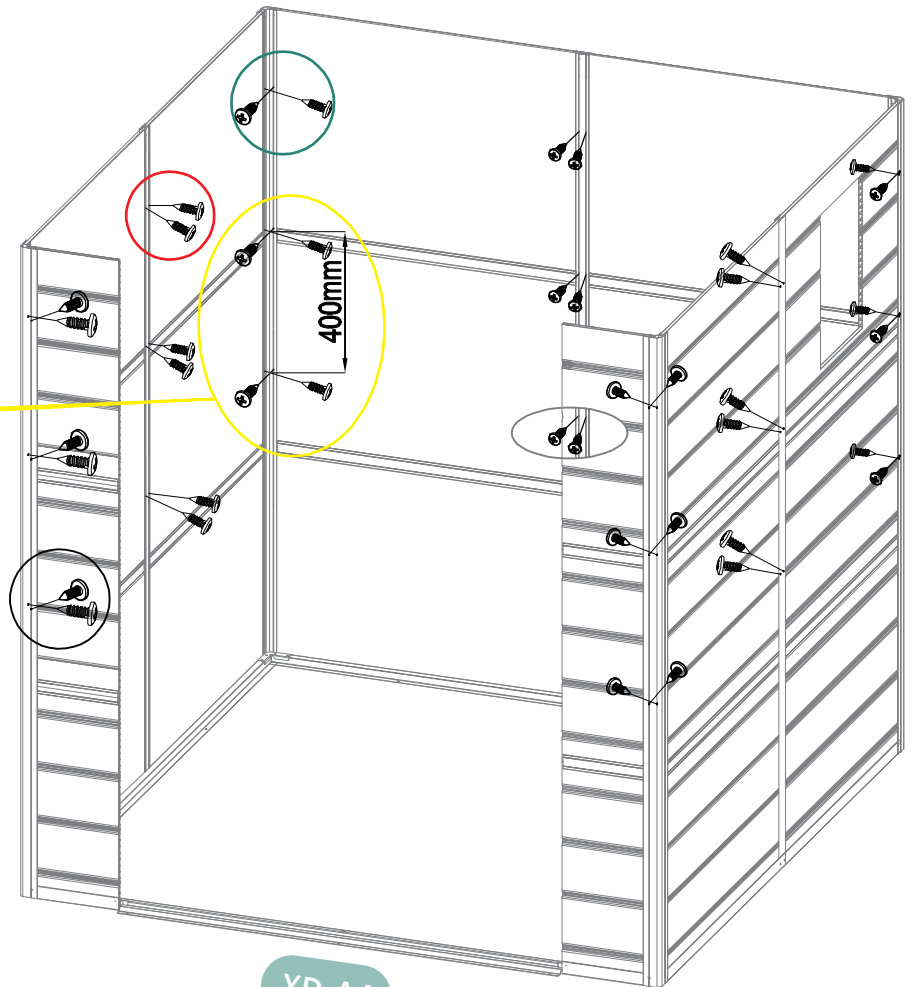
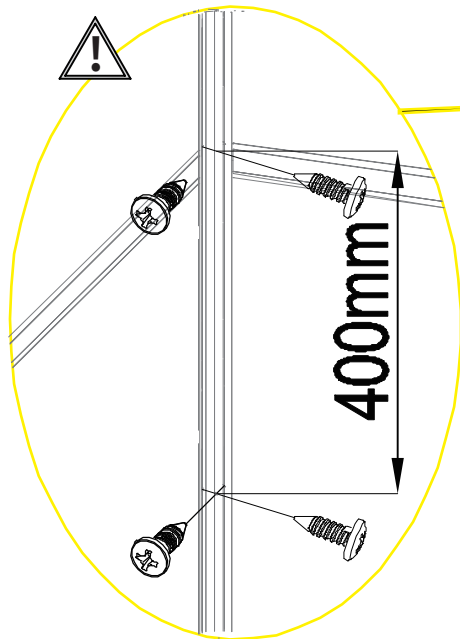



# 18

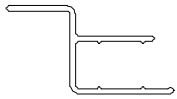

YG-A10 1pc

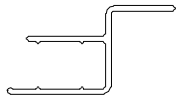

YG-A11 1pc

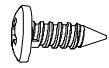

YG-D50 6pcs

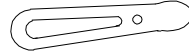

Auxiliary Tools

CN-A33

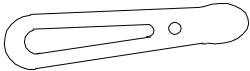
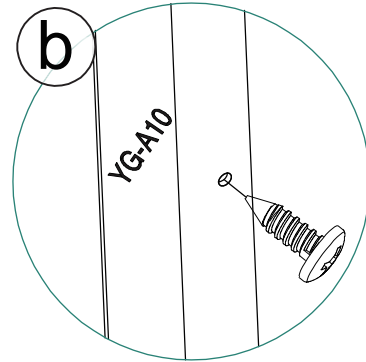
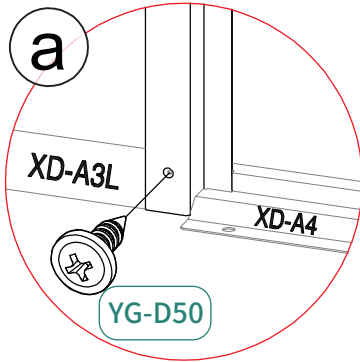
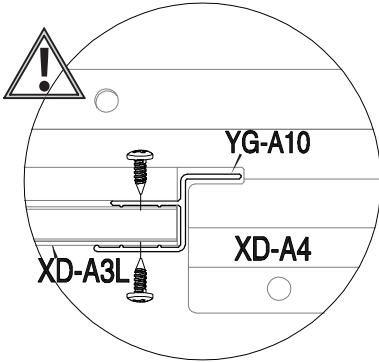

Auxiliary Tools

CN-A33

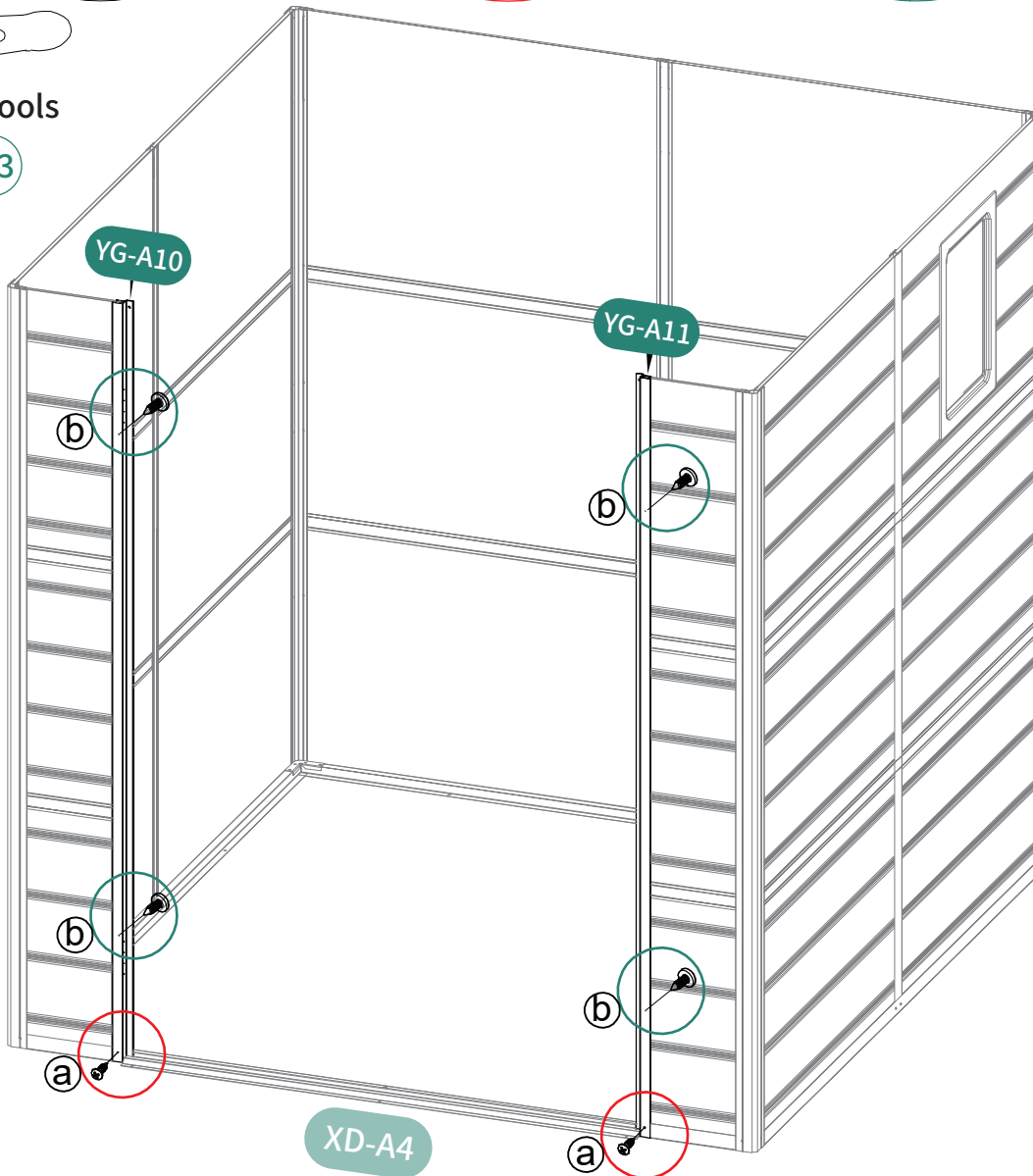

# 19

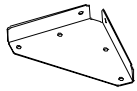

XD-2 4pcs

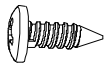

YG-D50 8pcs

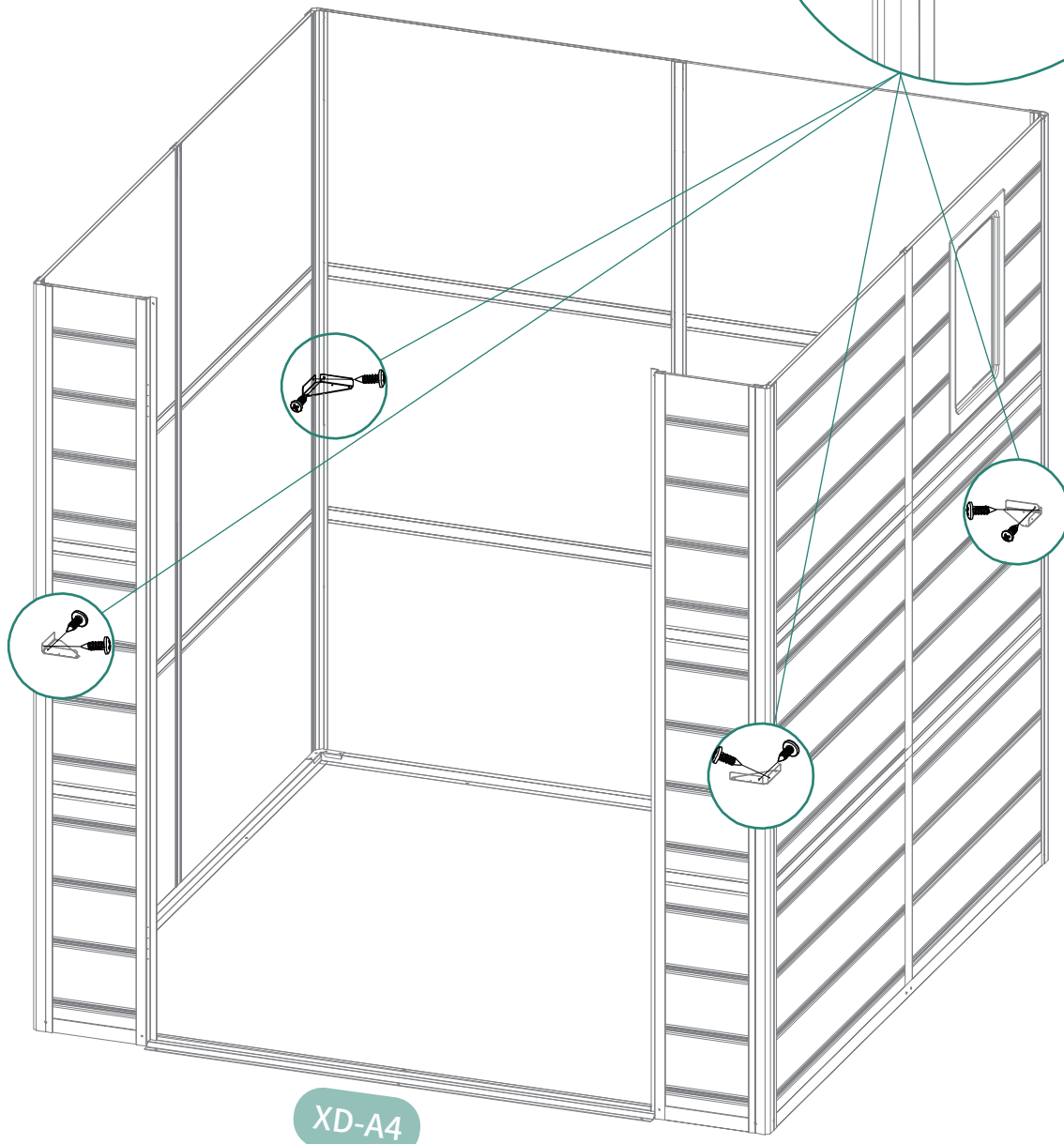
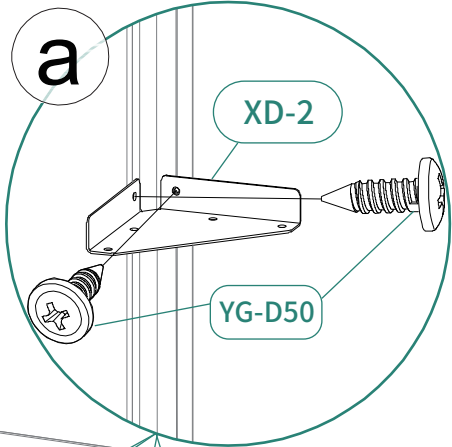

XD-A4

# 20

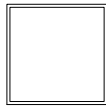

VA-G15 3pcs

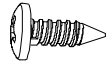

YG-D50 18pcs

please align the screws with the grooves to avoid any deviations that could lead to loosening.

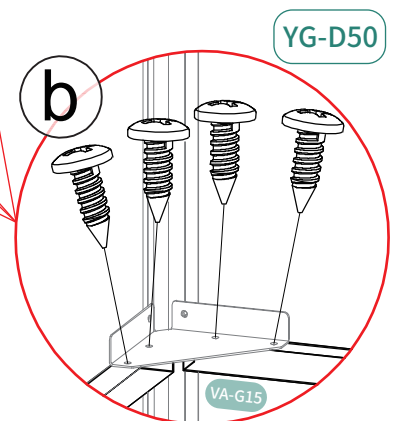
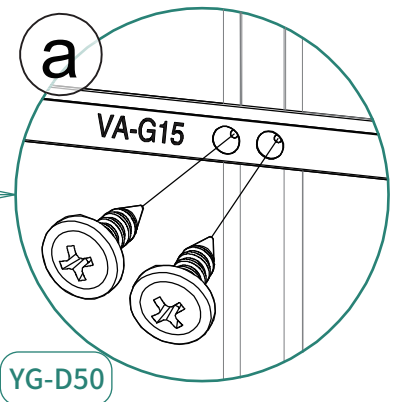
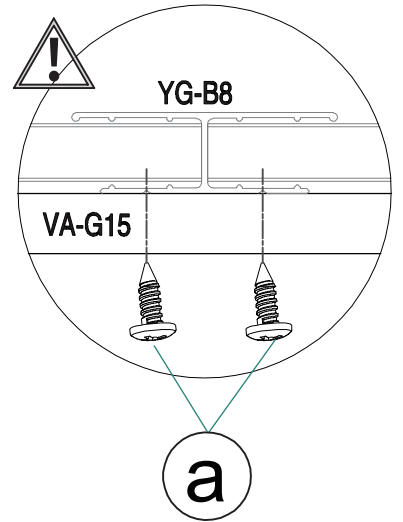
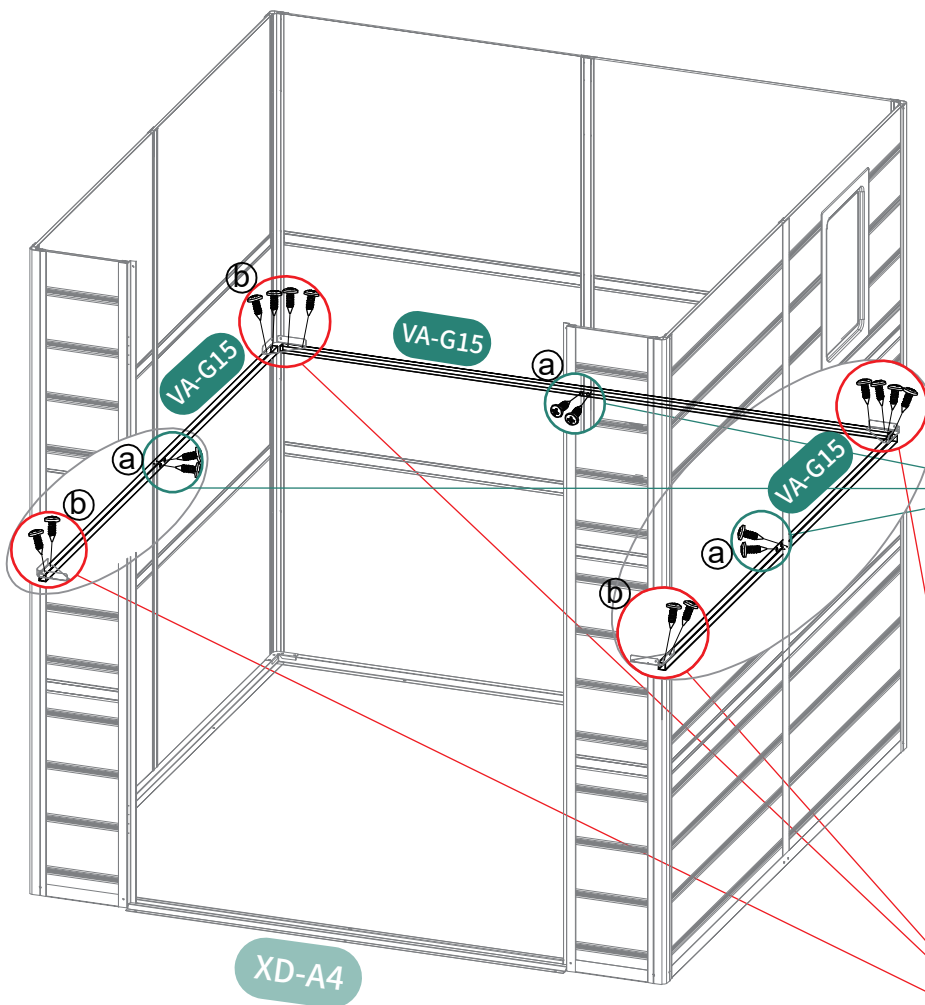

# 21

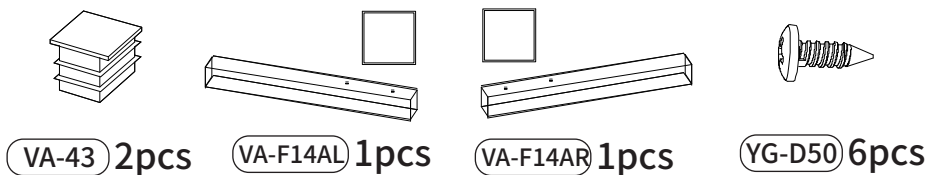

First, secure the reinforcement rod, but do not fully tighten it. Then, rotate the reinforcement rod and cover the hole with the cover plate. Next, rotate the reinforcement rod back to the original position. Finally, tighten the bolts completely to fully secure the reinforcement rod.

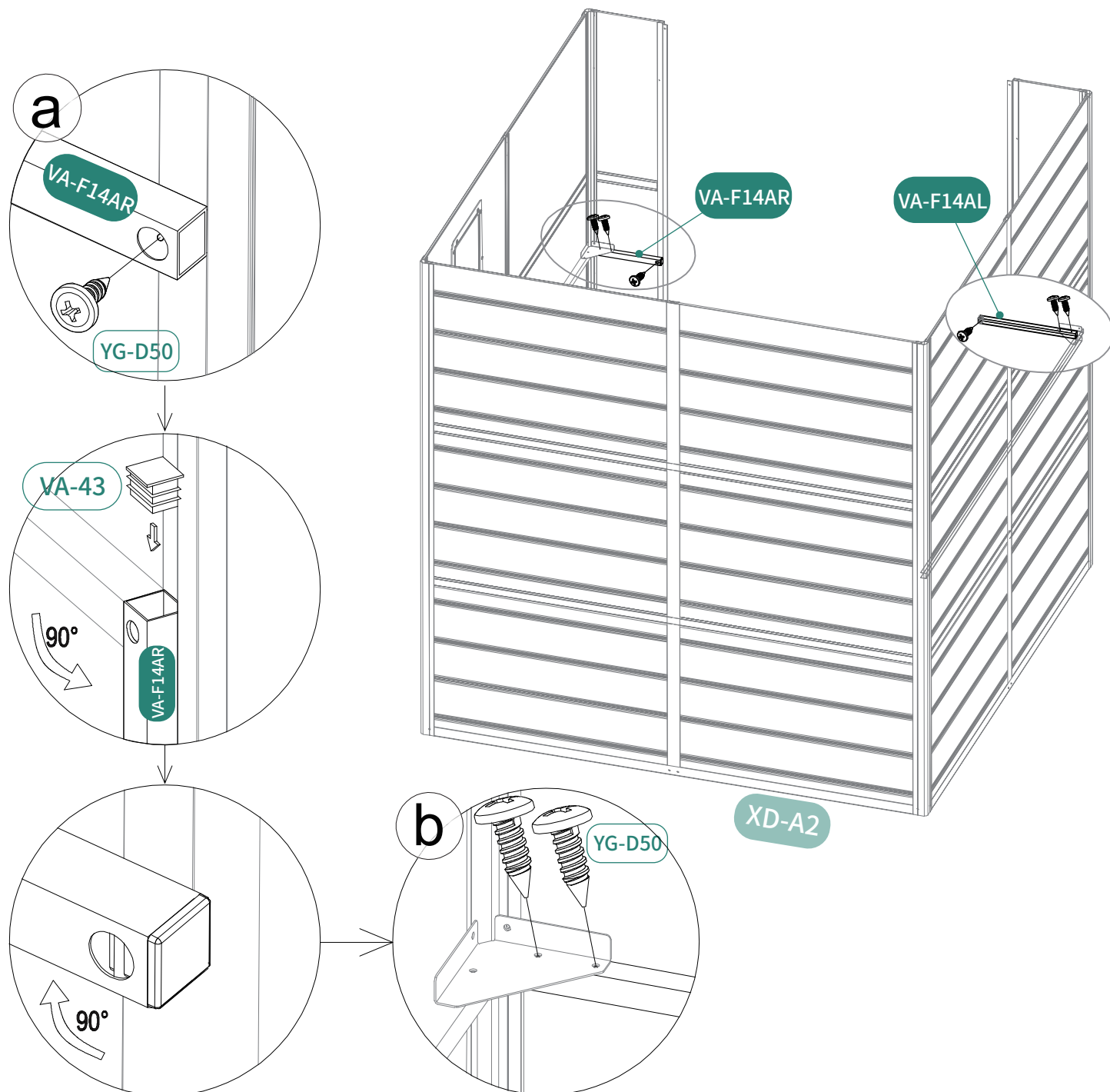

# 22



PPX10 1pc



W1 1pc



W2 1pc



VA-51 1pc



YG-54 1pc

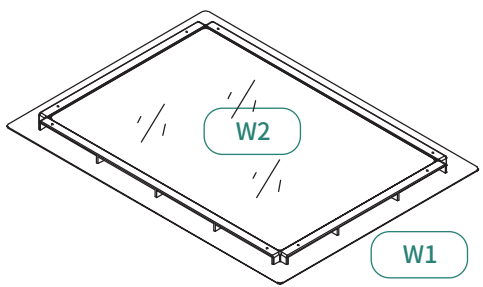
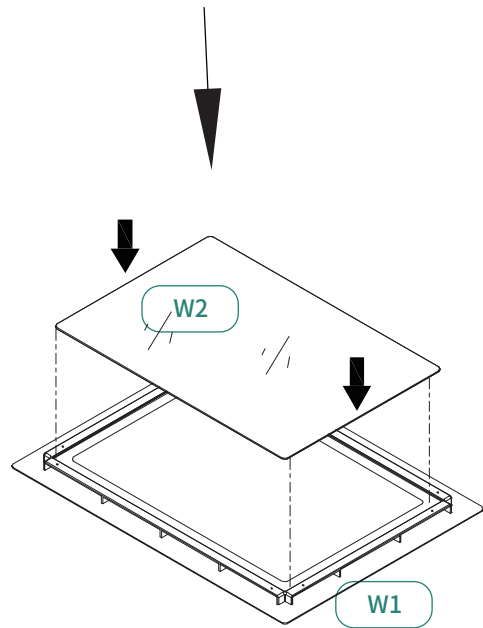
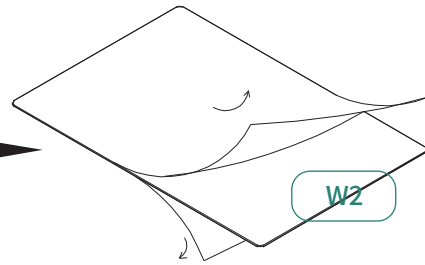
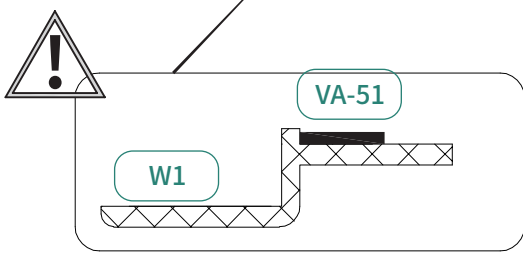
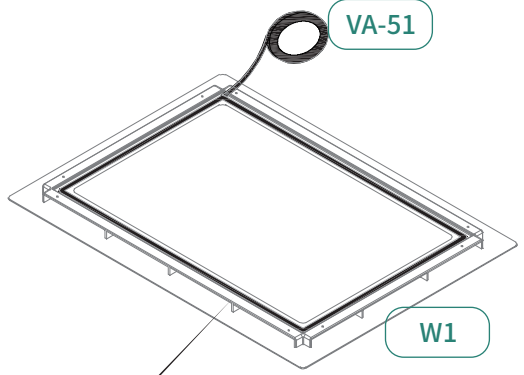
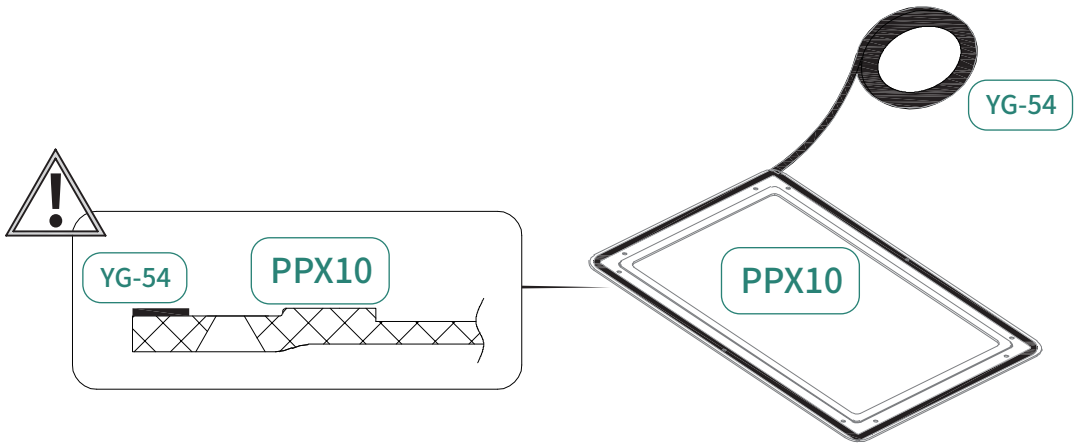

# 23

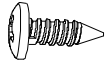

YG-D50 10pcs

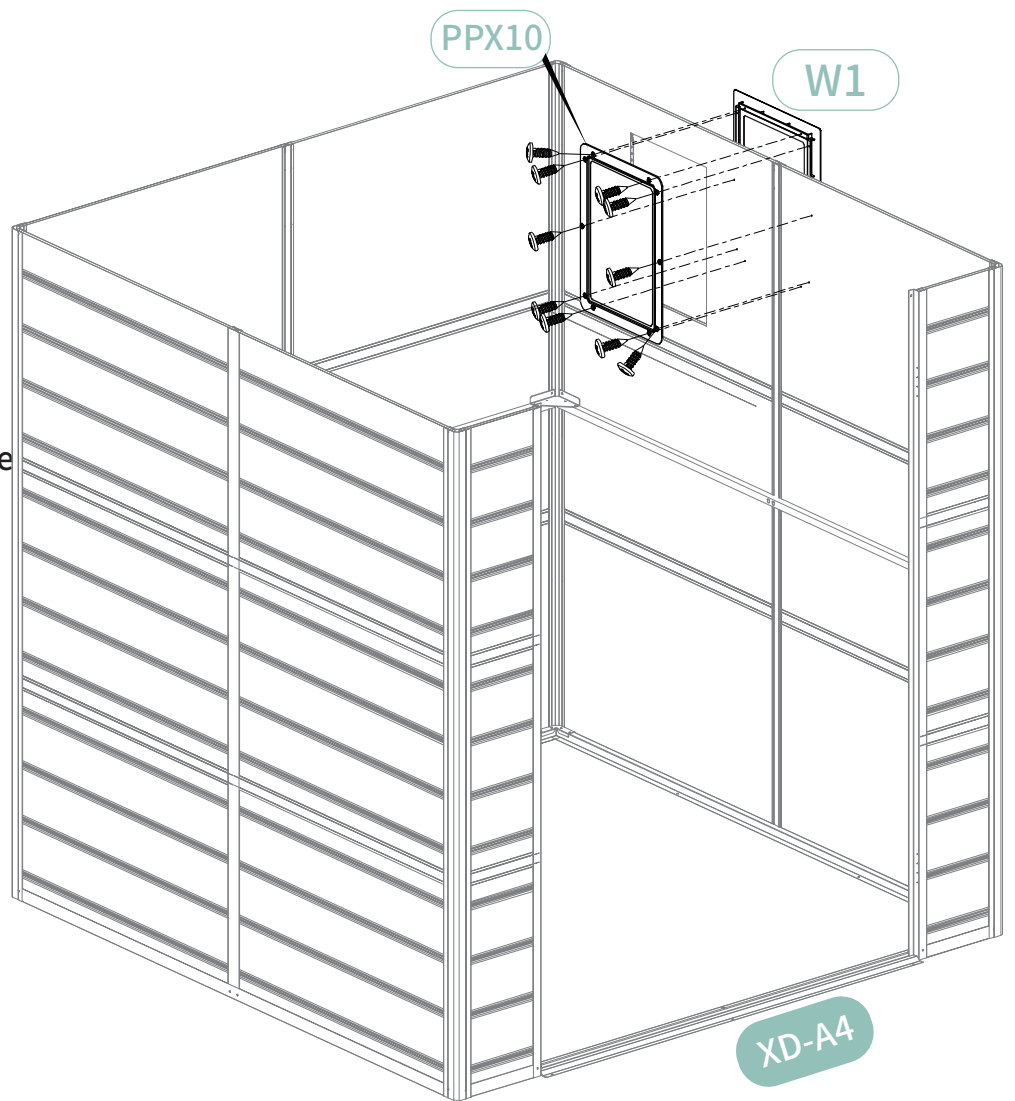
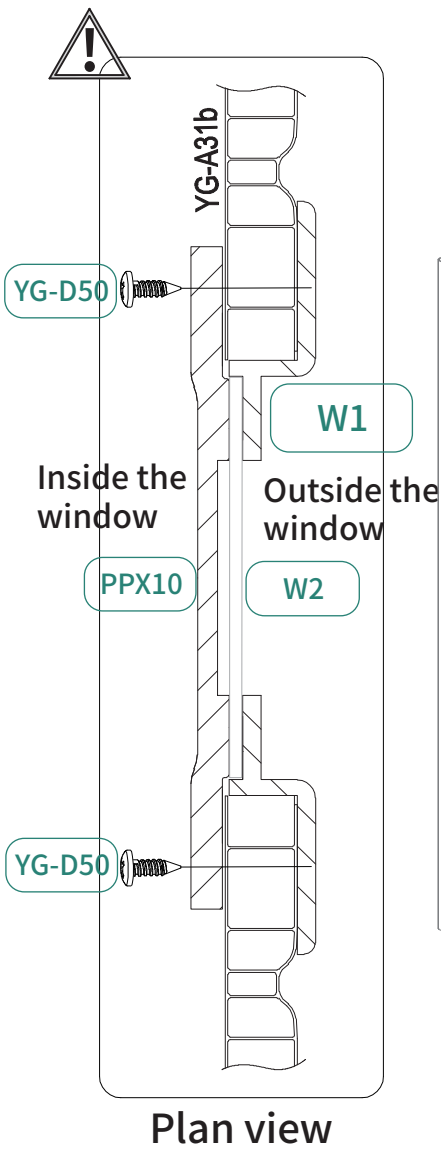

# 24

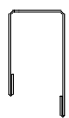

YG-B14 2pcs

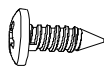

YG-D50 4pcs



Auxiliary Tools

CN-A33

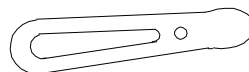
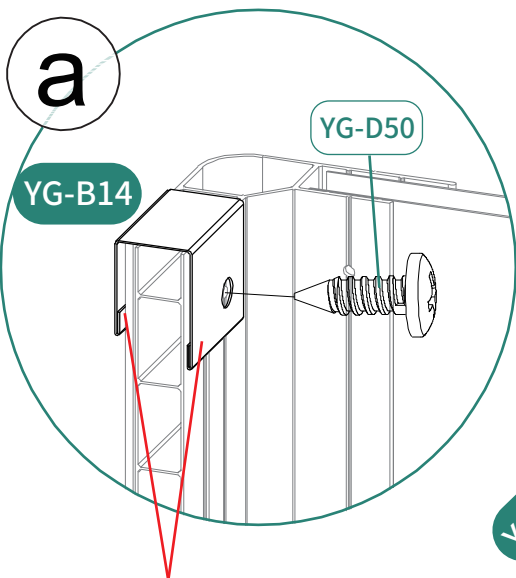

Auxiliary Tools

CN-A33

That the longer sides of the components should be oriented towards the inside, while the shorter sides should be oriented towards the outside during installation or assembly.



# 25

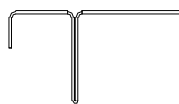

YG-C12 1pc

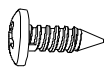

YG-D50 4pcs



Auxiliary Tools

CN-A33

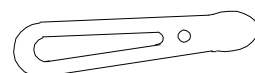
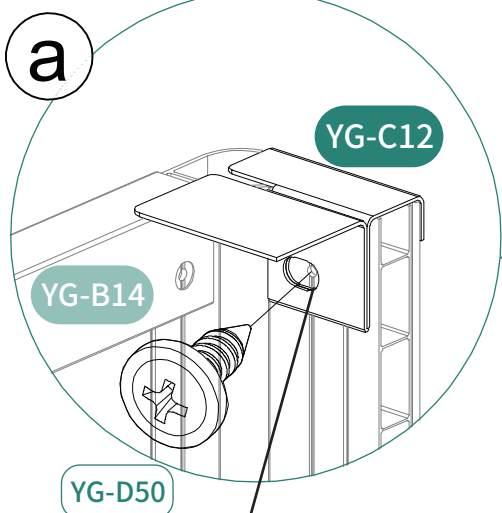

Auxiliary Tools

CN-A33

Ensure the folded edge of the component is facing inwards.

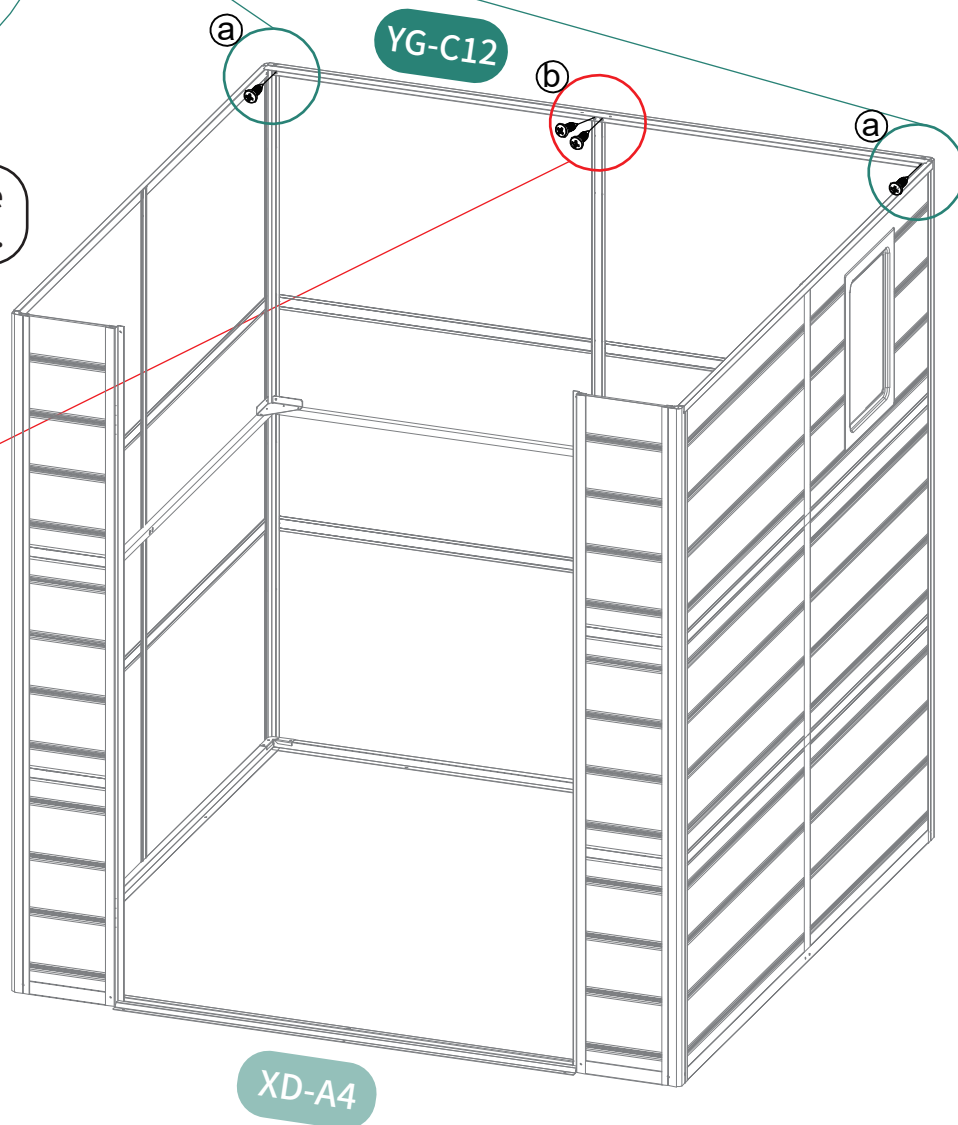
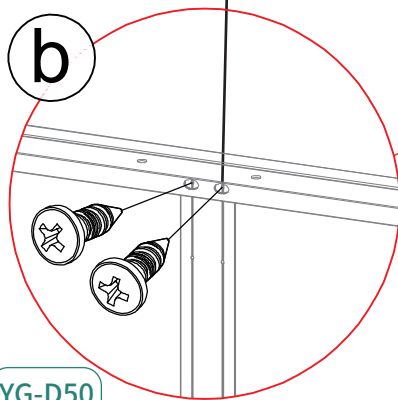



# 26

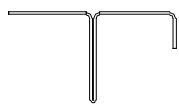

YG-C13 1pc



YG-6 2pcs

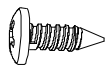

YG-D51 2pcs



YG-D55 2pcs

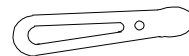

Auxiliary Tools

CN-A33

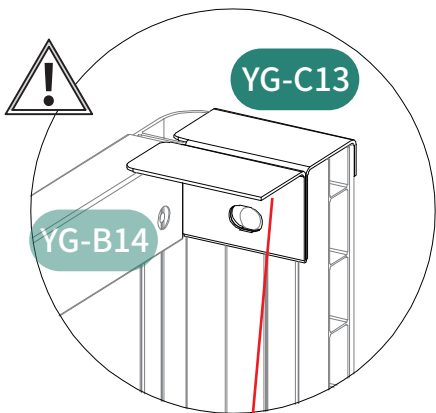

Ensure the folded edge of the component is facing inwards.

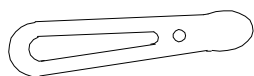
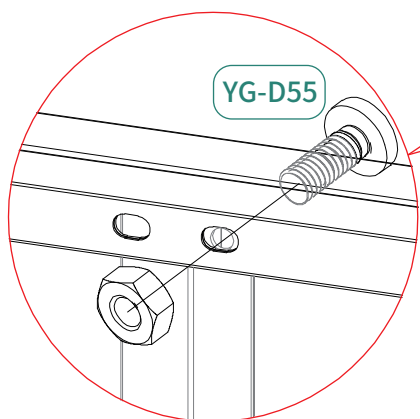
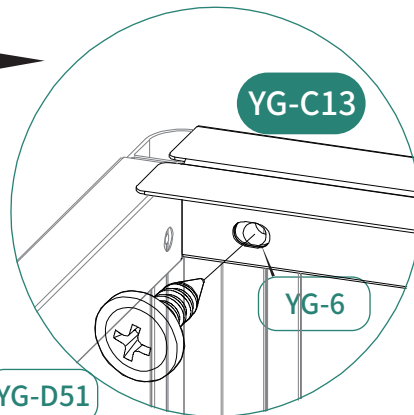
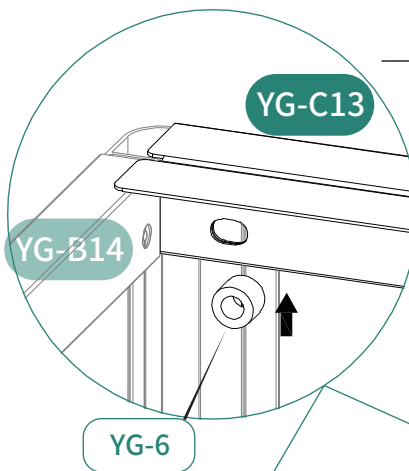

Auxiliary Tools

CN-A33

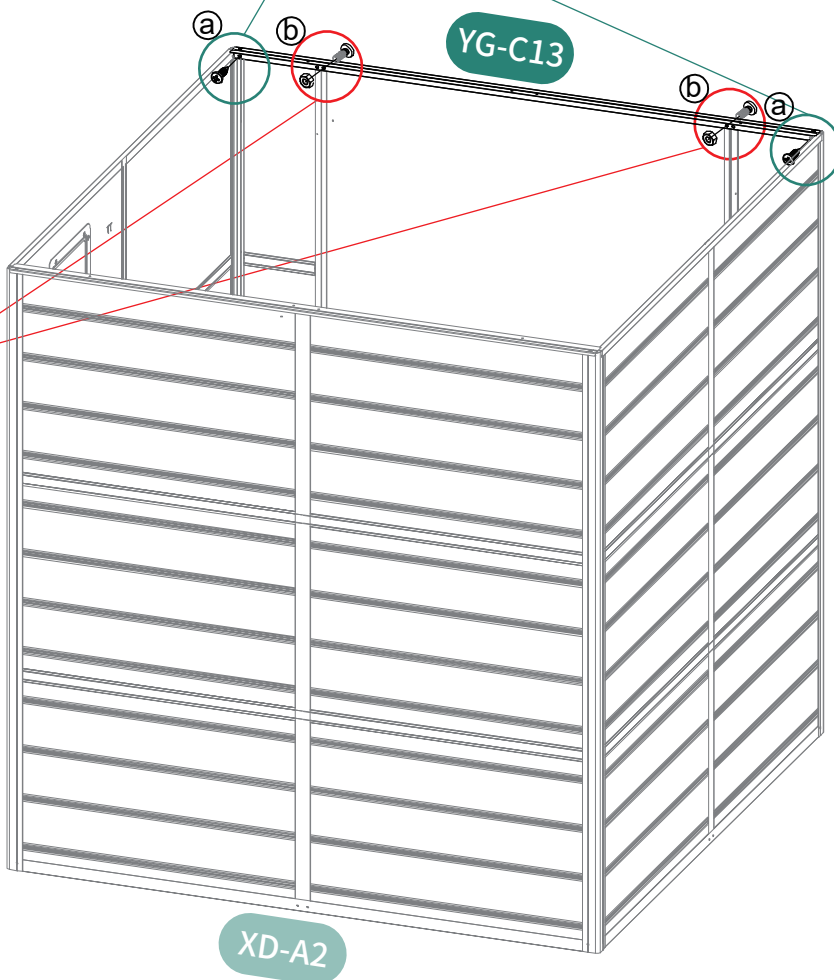

# 27

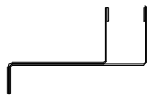

YG-C15 1pc

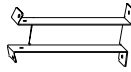

YG-C18 1pc



YG-D55 4pcs

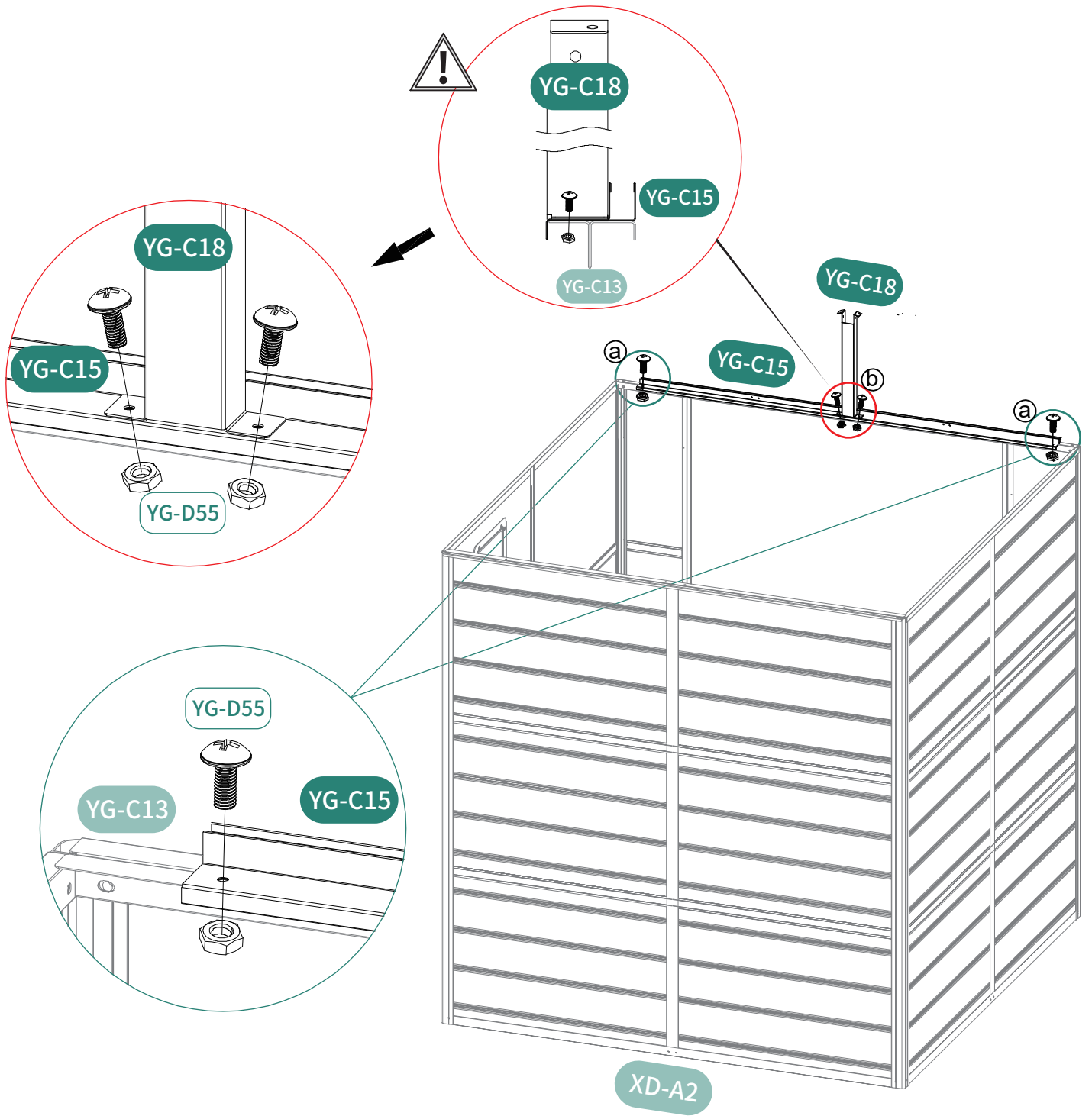

# 28

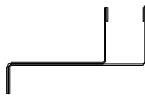

YG-C15 1pc

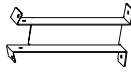

YG-C18 1pc



YG-D55 4pcs

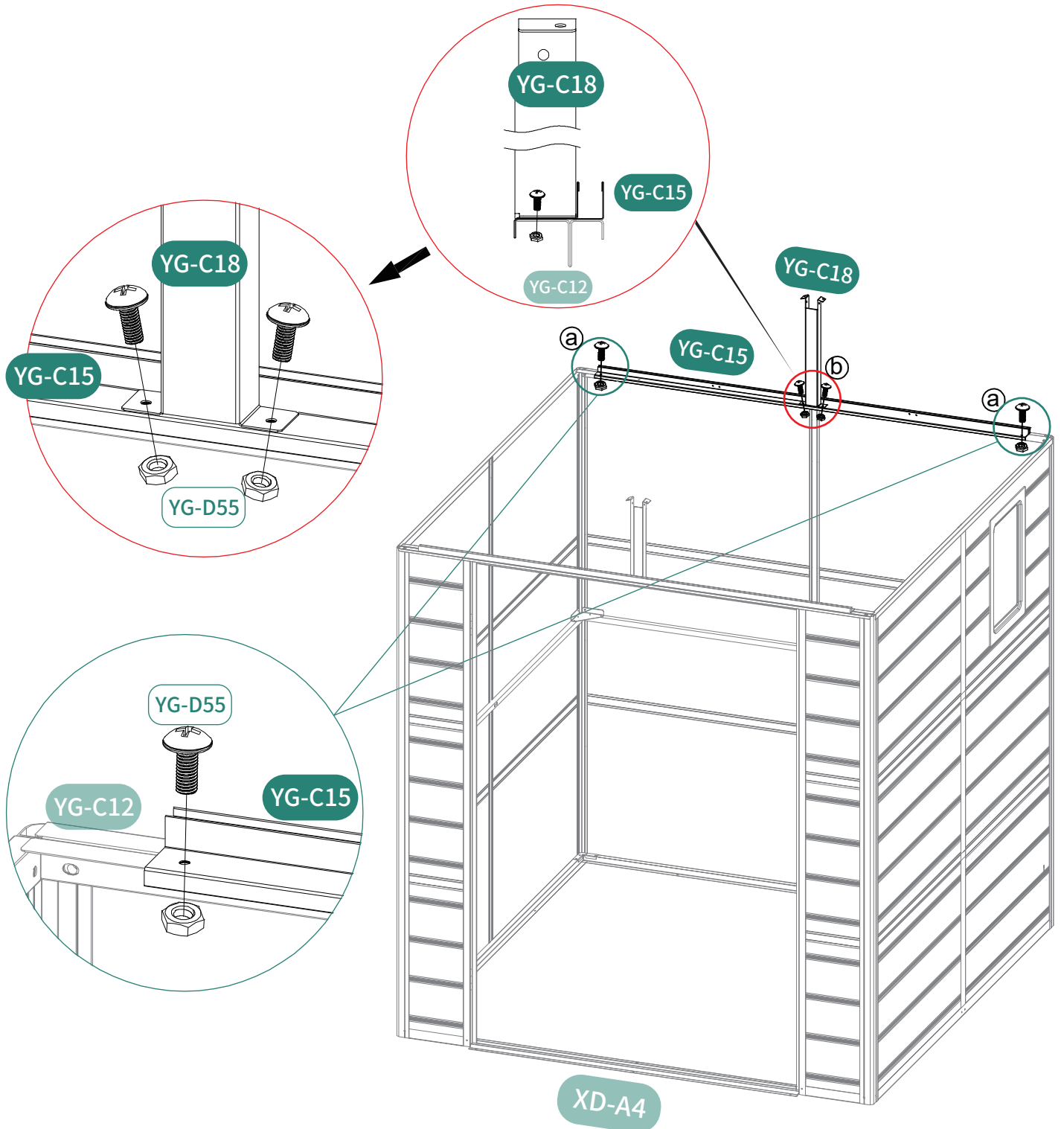

# 29

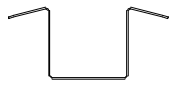

YG-B19 1pc

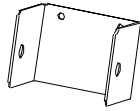

YG-1 2pc

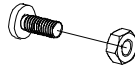

YG-D55 4pcs

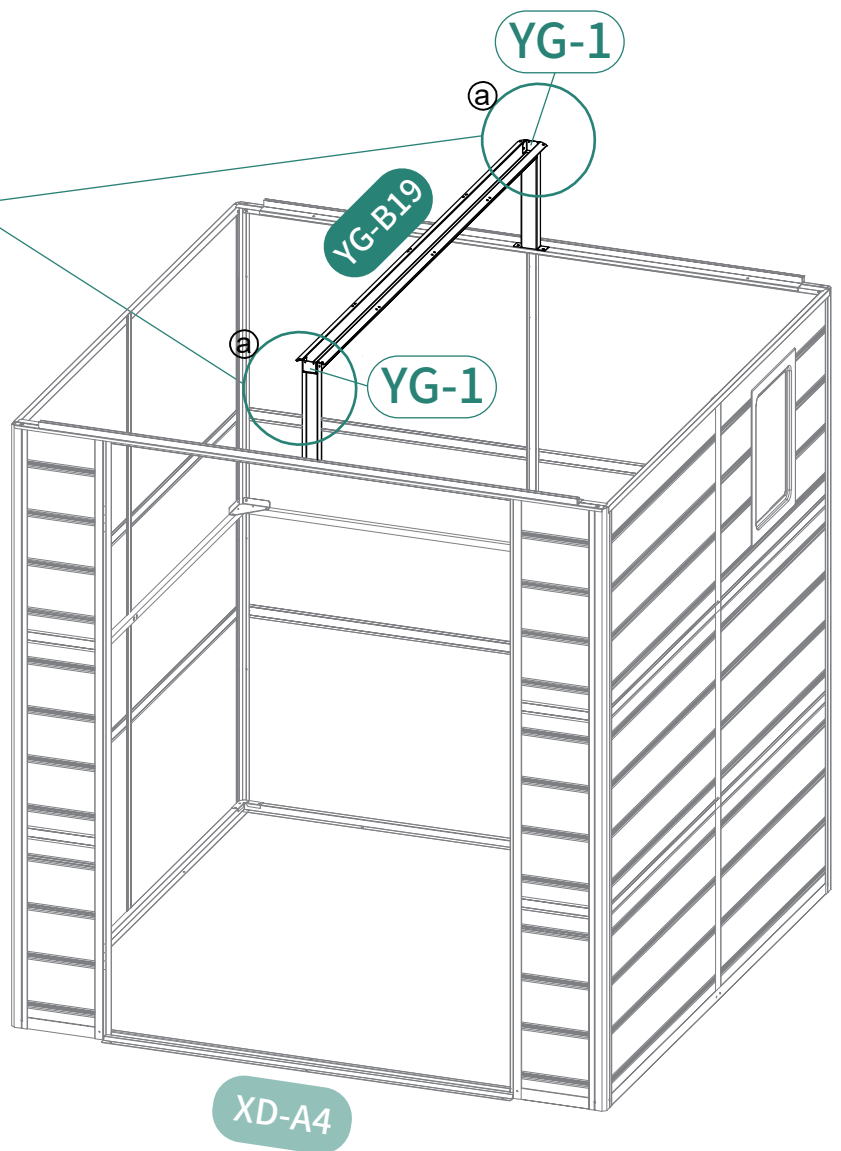
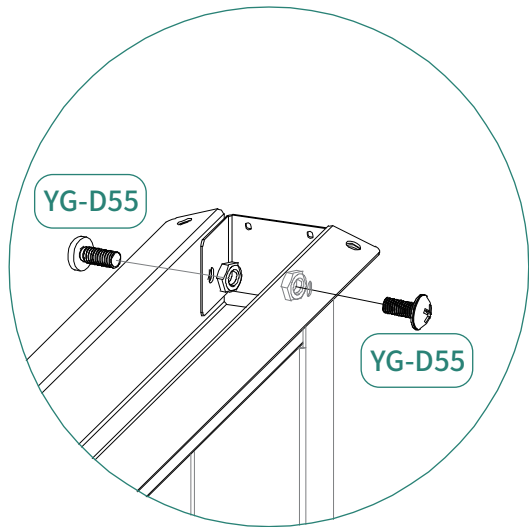
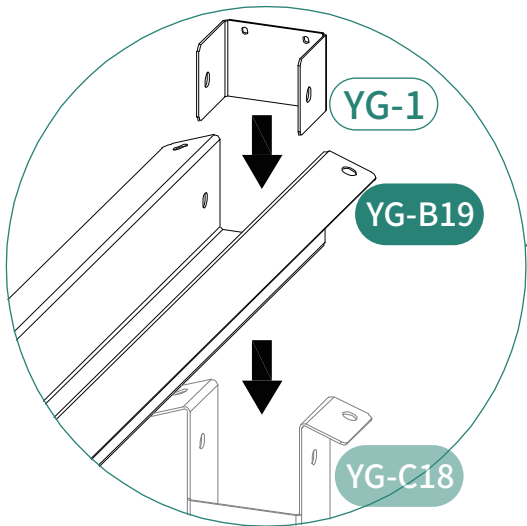

# 30

## X2

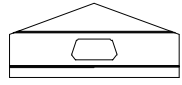

YG-C35 2pcs

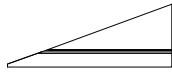

YG-C35a 2pcs

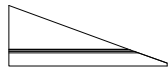

YG-C35b 2pcs

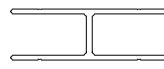

YG-C44 2pcs



YG-9 2pcs



YG-D50 16pcs

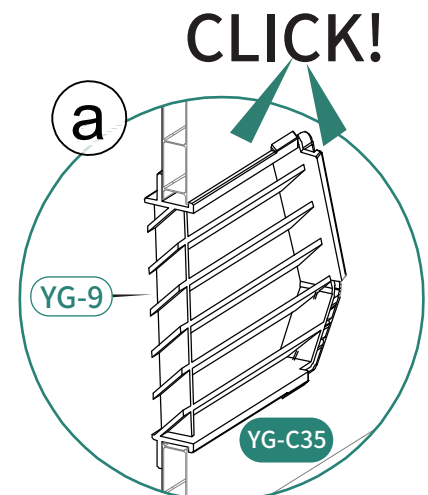
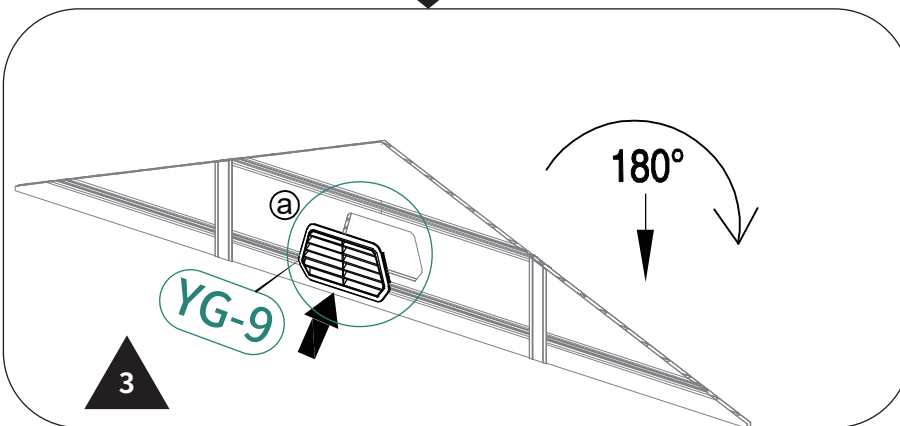
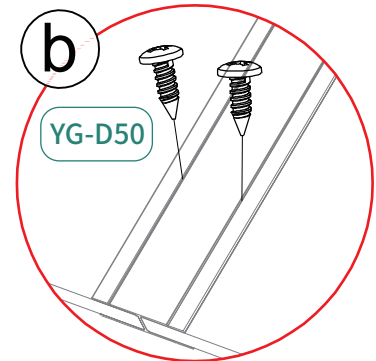
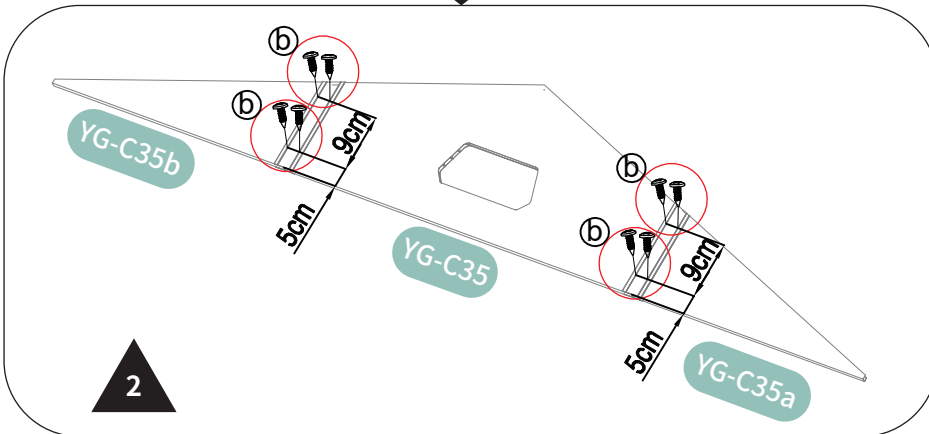
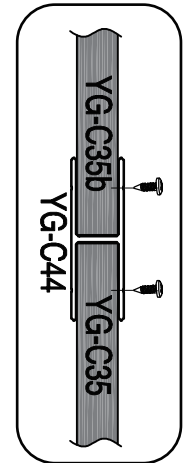
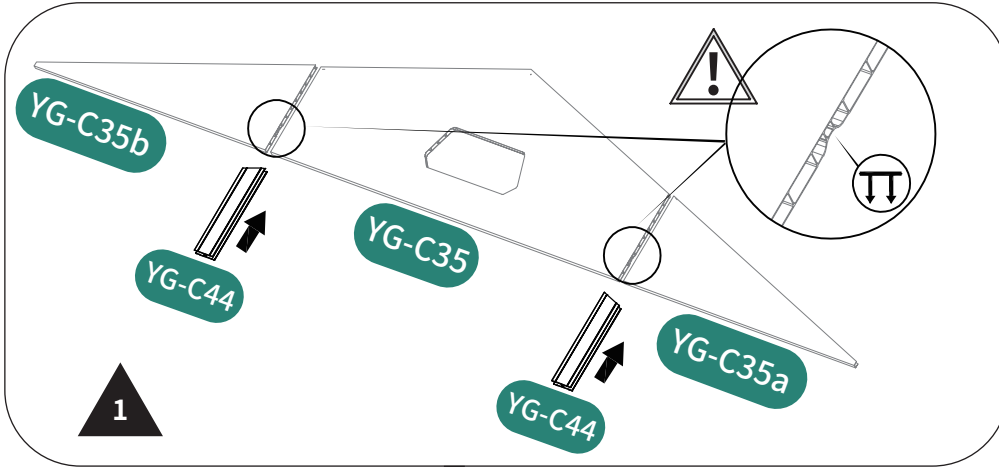

Make sure the clips are fully engaged, to prevent them from coming loose during use.

# 31

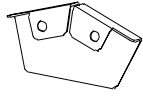

YG-2 2pcs

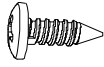

YG-D50 12pcs

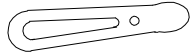

Auxiliary Tools

CN-A33

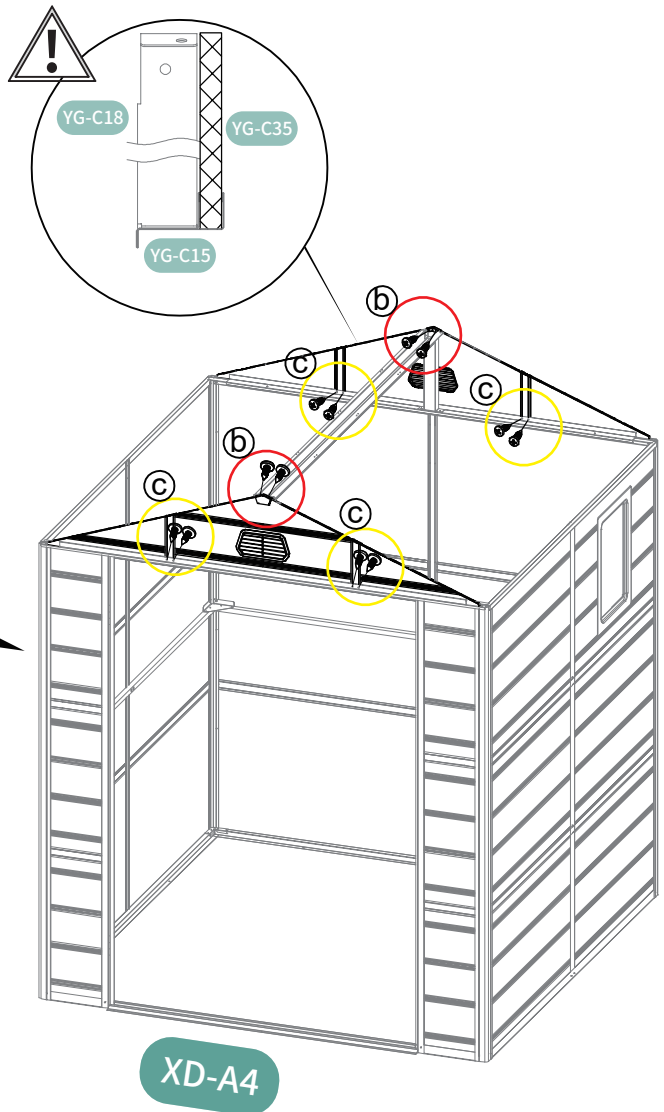
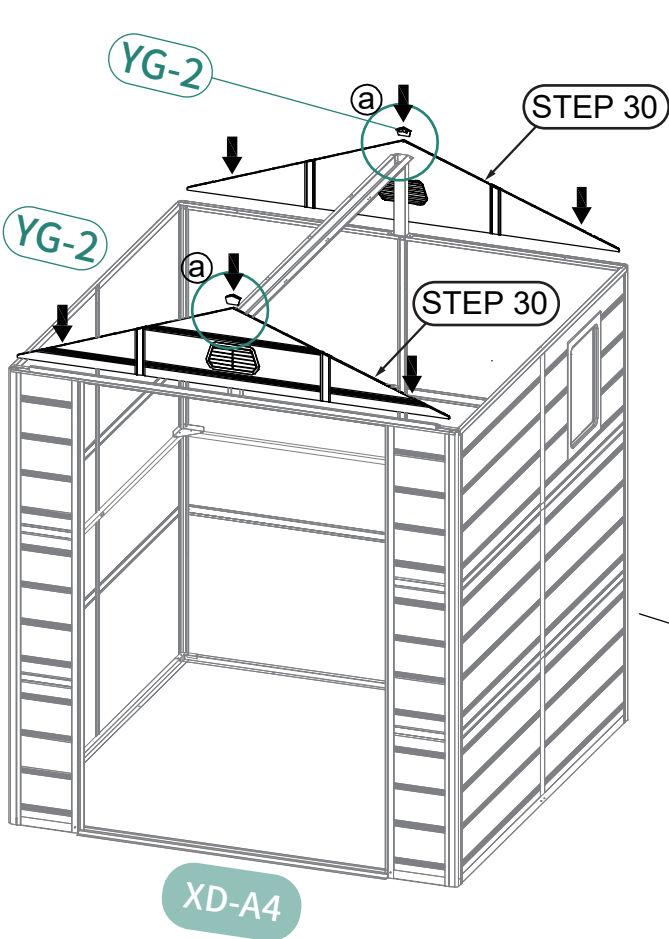
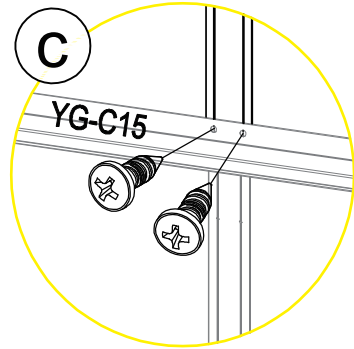
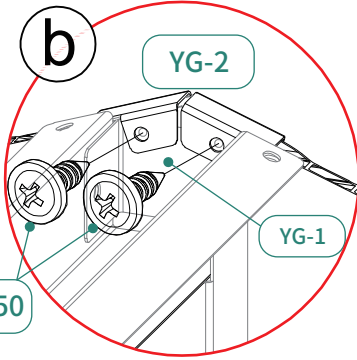
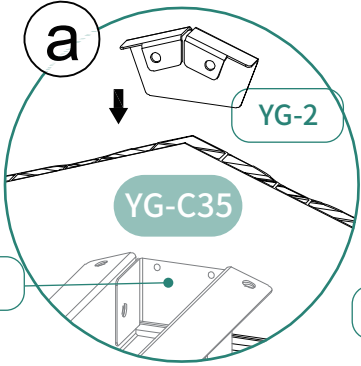

# 32

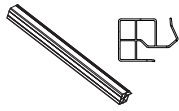

YG-B22 1pc



YG-D52 3pcs

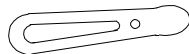

Auxiliary Tools

CN-A33

When installing the roof fixture tracks, please observe if the distances on both sides of the fixture tracks are consistent, and try to ensure the fixture tracks are positioned centrally.

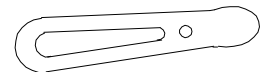
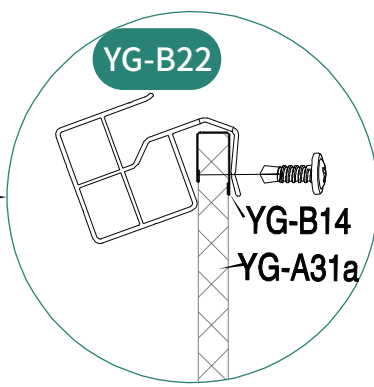
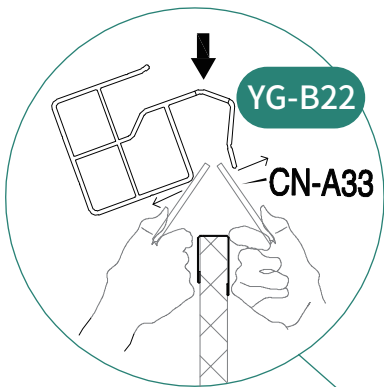

Auxiliary Tools

CN-A33

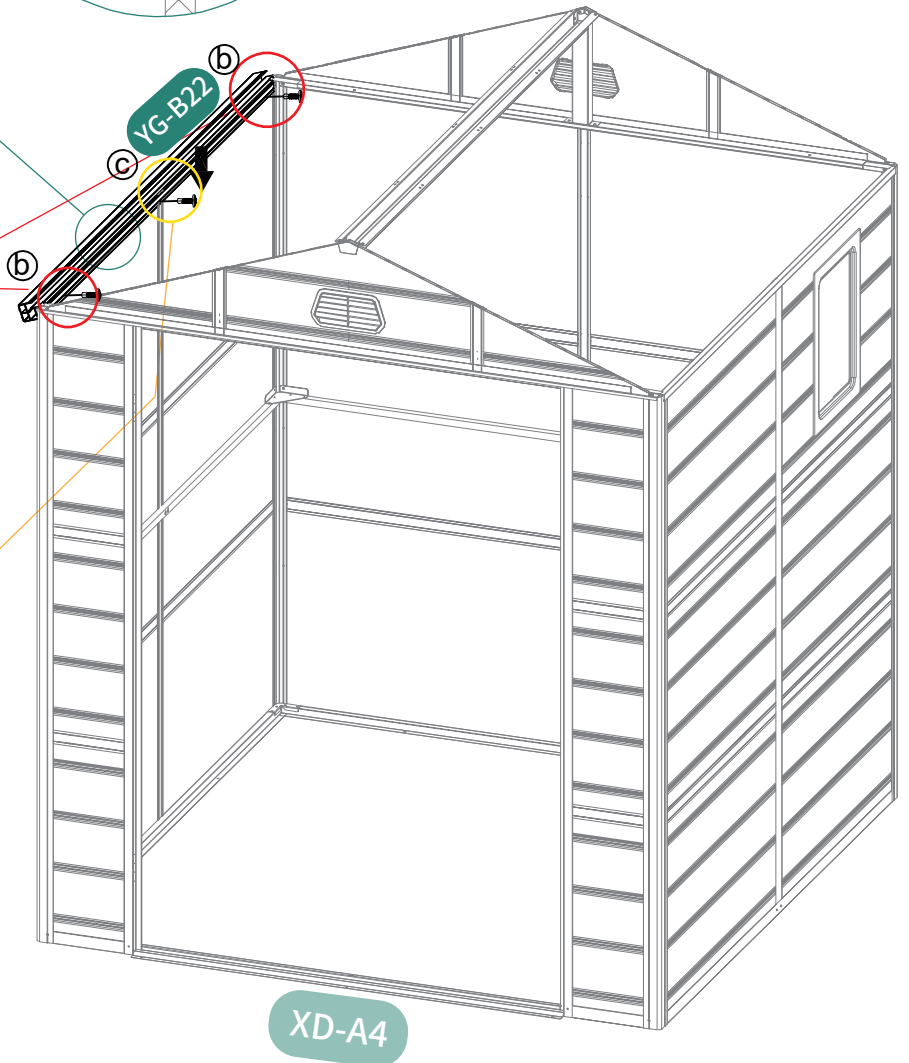
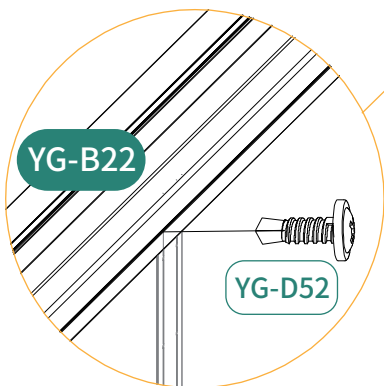
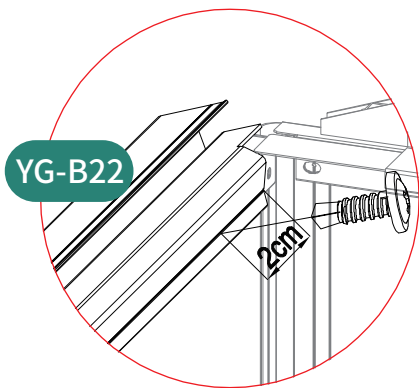

# 33

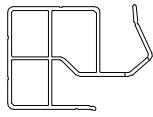

YG-C20 1pc

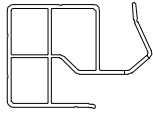

YG-C21 1pc

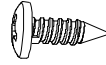

YG-D50 4pcs



YG-D52 2pcs

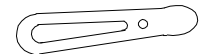

Auxiliary Tools

CN-A33

When installing the roof fixture tracks, please observe if the distances on both sides of the fixture tracks are consistent, and try to ensure the fixture tracks are positioned centrally.

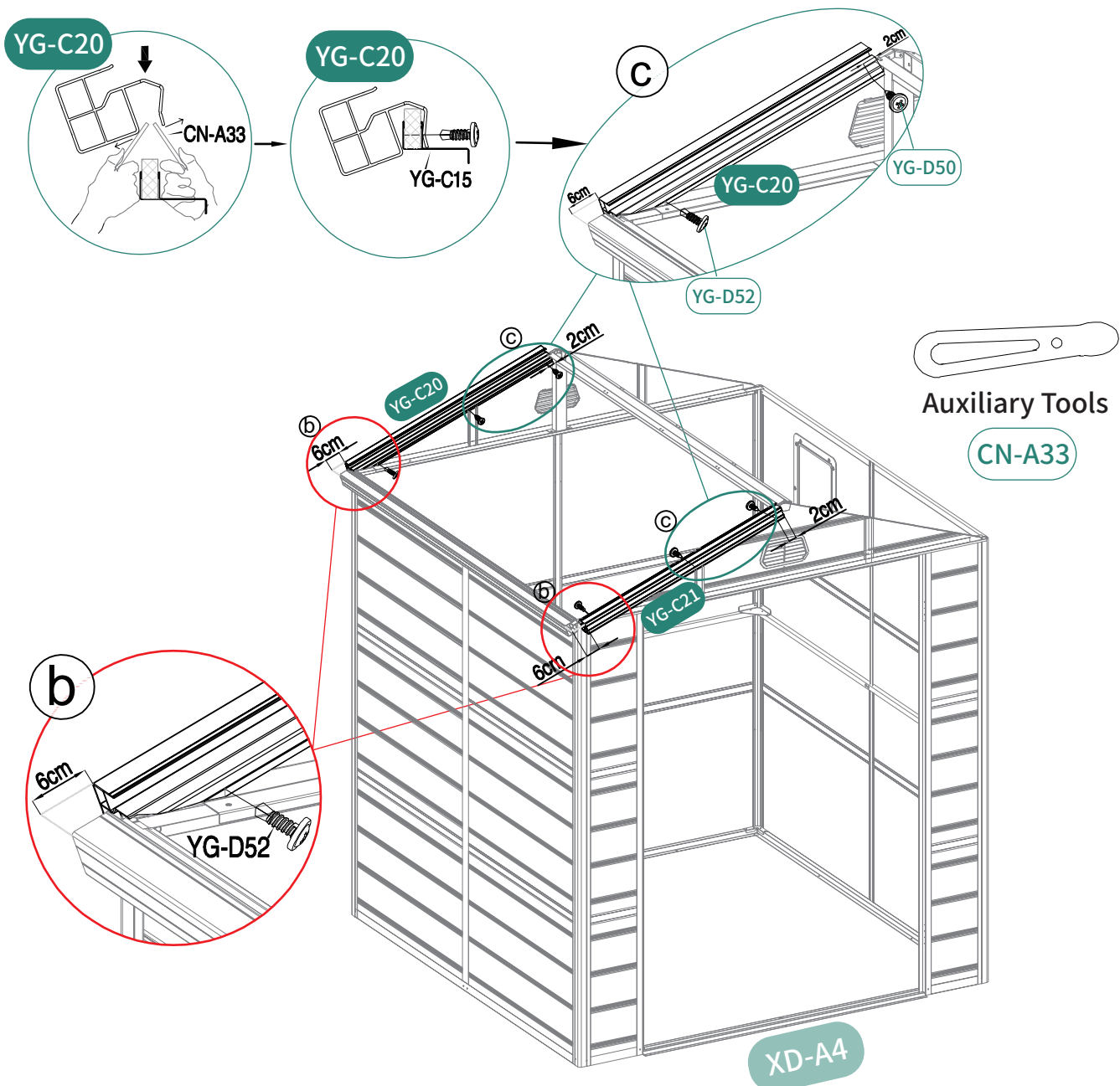



# 34

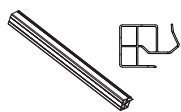

YG-B22 1pc



YG-D52 3pcs

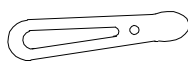

Auxiliary Tools

CN-A33

When installing the roof fixture tracks, please observe if the distances on both sides of the fixture tracks are consistent, and try to ensure the fixture tracks are positioned centrally.

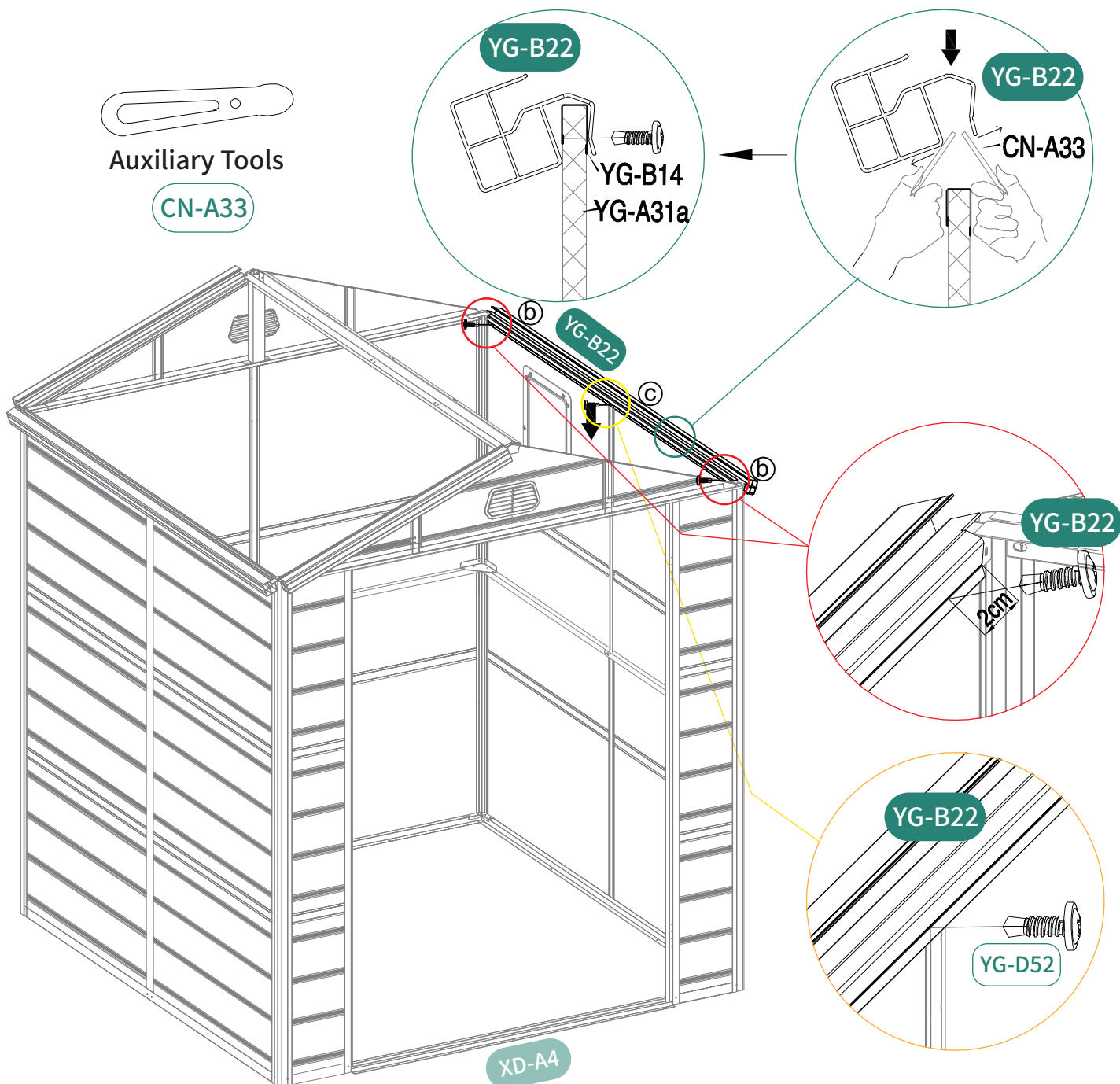

# 35

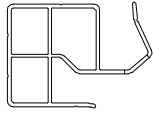

YG-C20 1pc

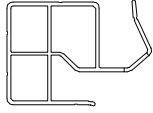

YG-C21 1pc

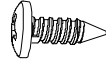

YG-D50 4pcs



YG-D52 2pcs

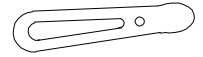

Auxiliary Tools

CN-A33

When installing the roof fixture tracks, please observe if the distances on both sides of the fixture tracks are consistent, and try to ensure the fixture tracks are positioned centrally.

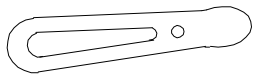

Auxiliary Tools

CN-A33

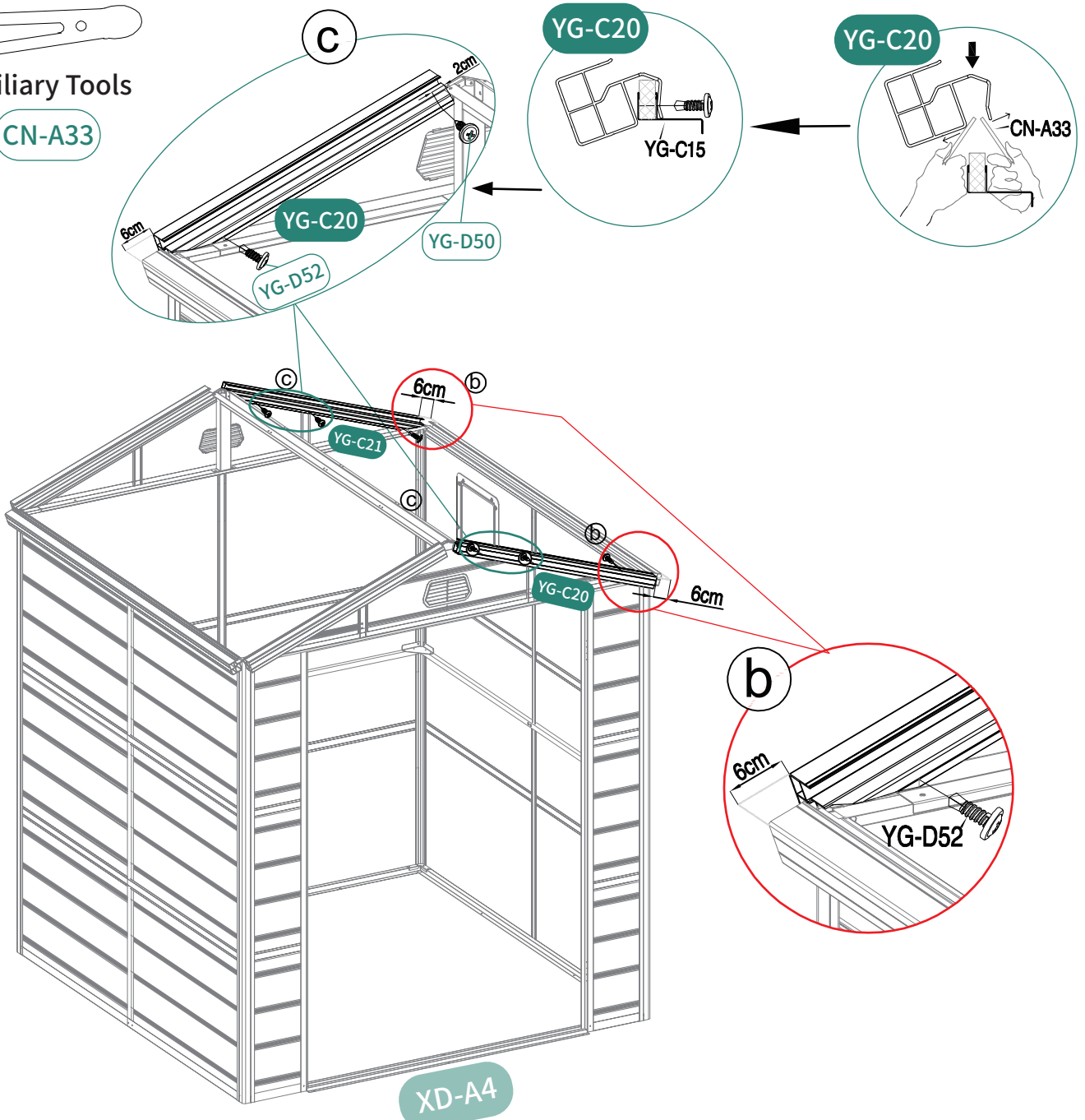

# 36

## X2

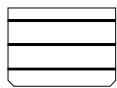

YG-C34 4pcs

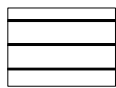

YG-D34 4pcs

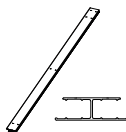

YG-C46 6pcs



YG-54 2pcs



YG-D50 36pcs

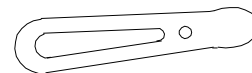

Auxiliary Tools

CN-A33

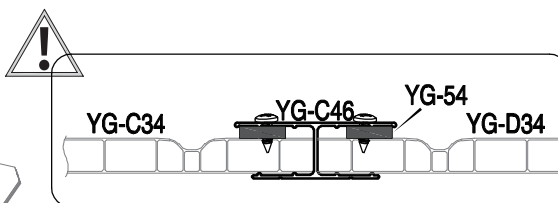
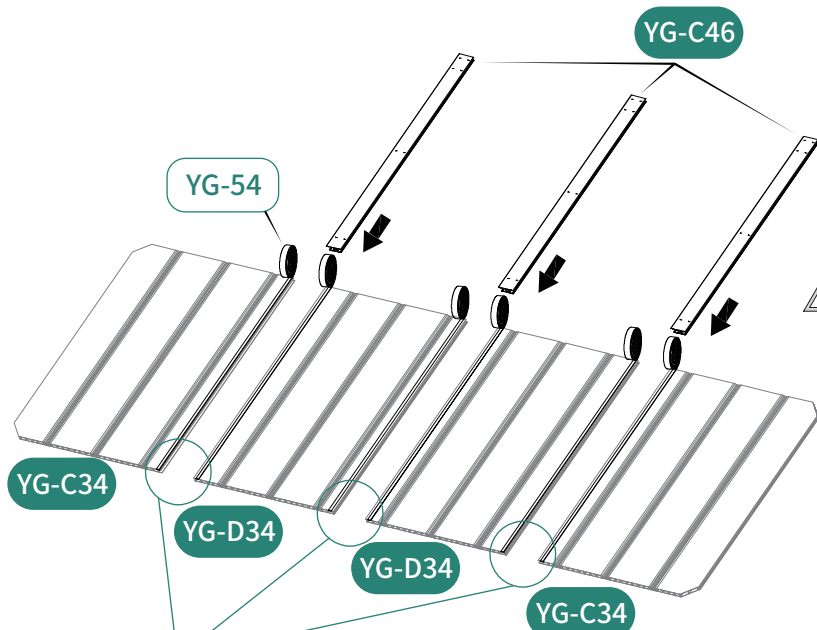

Attention, the screws should be fixed in the waterproof rubber/sealant section.

Important: This has 4 holes. Make sure not to ignore them when you are installing.

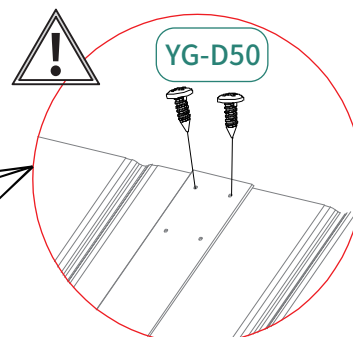

When assembling, ensure the cross-sections are aligned.

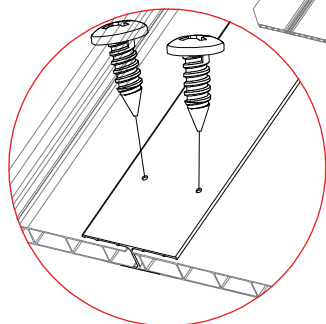

# 37

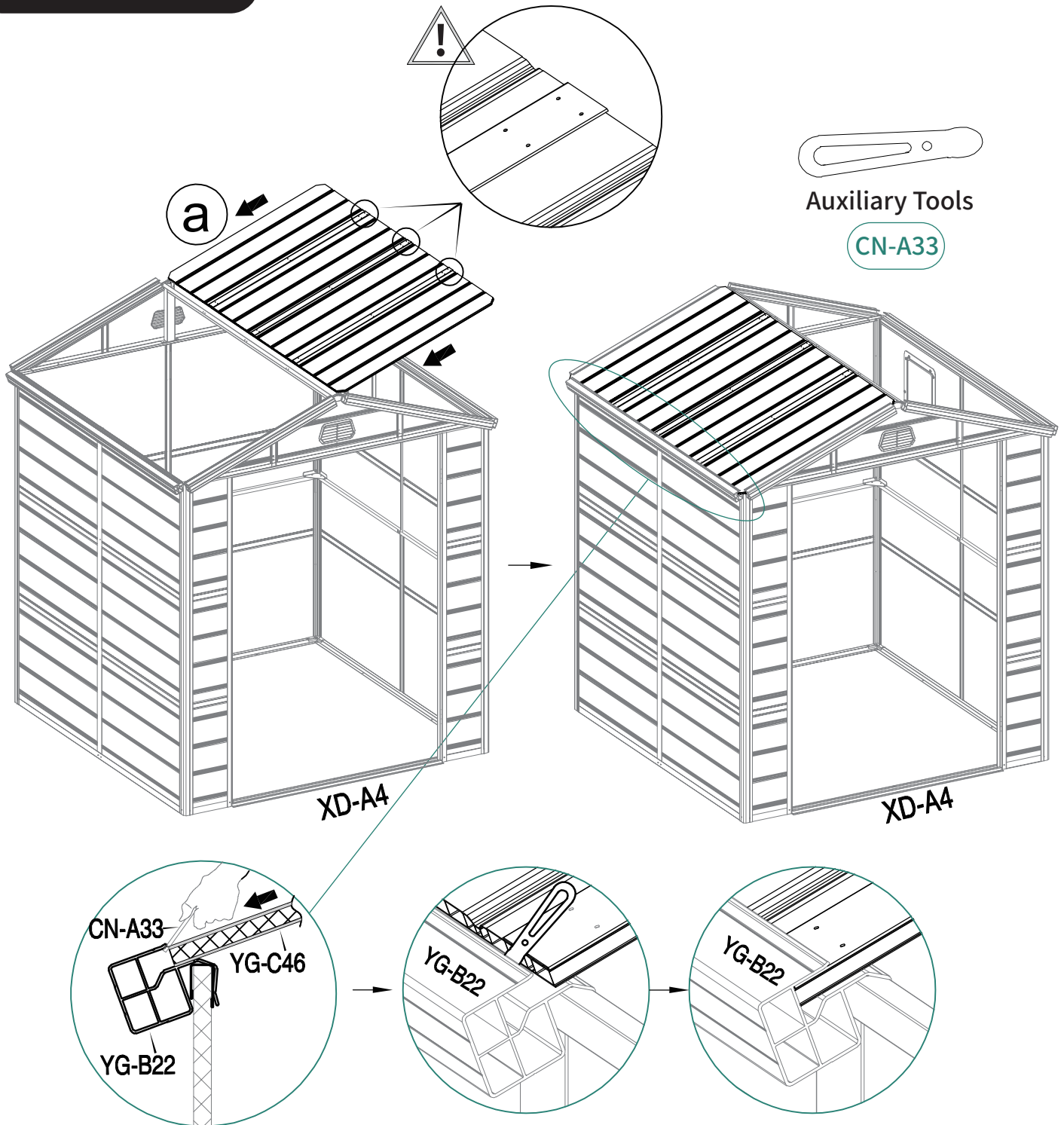

When sliding the roof panels into the slots, please use an assisting tool to ensure they are fully inserted into the tracks.

# 38

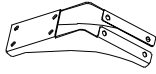

YG-3 1pc

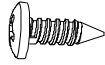

YG-D50 14pcs

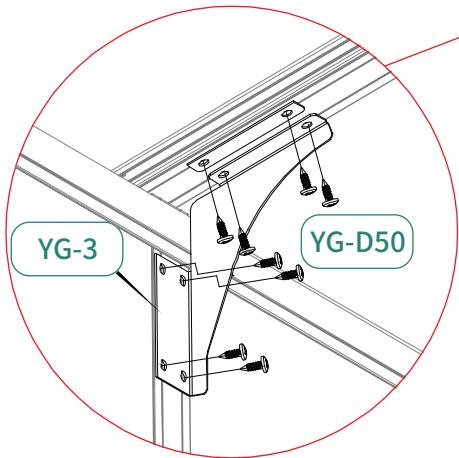
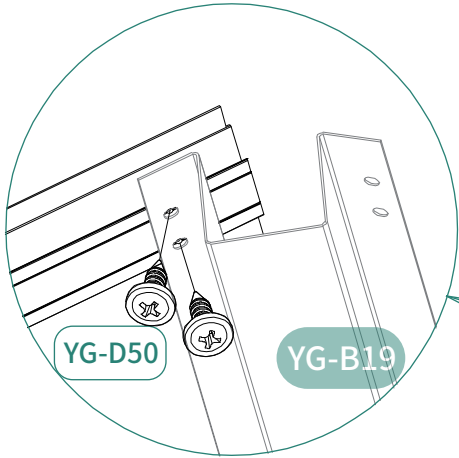

Undertake the installation process by accessing it from the roof's inner space/interior.

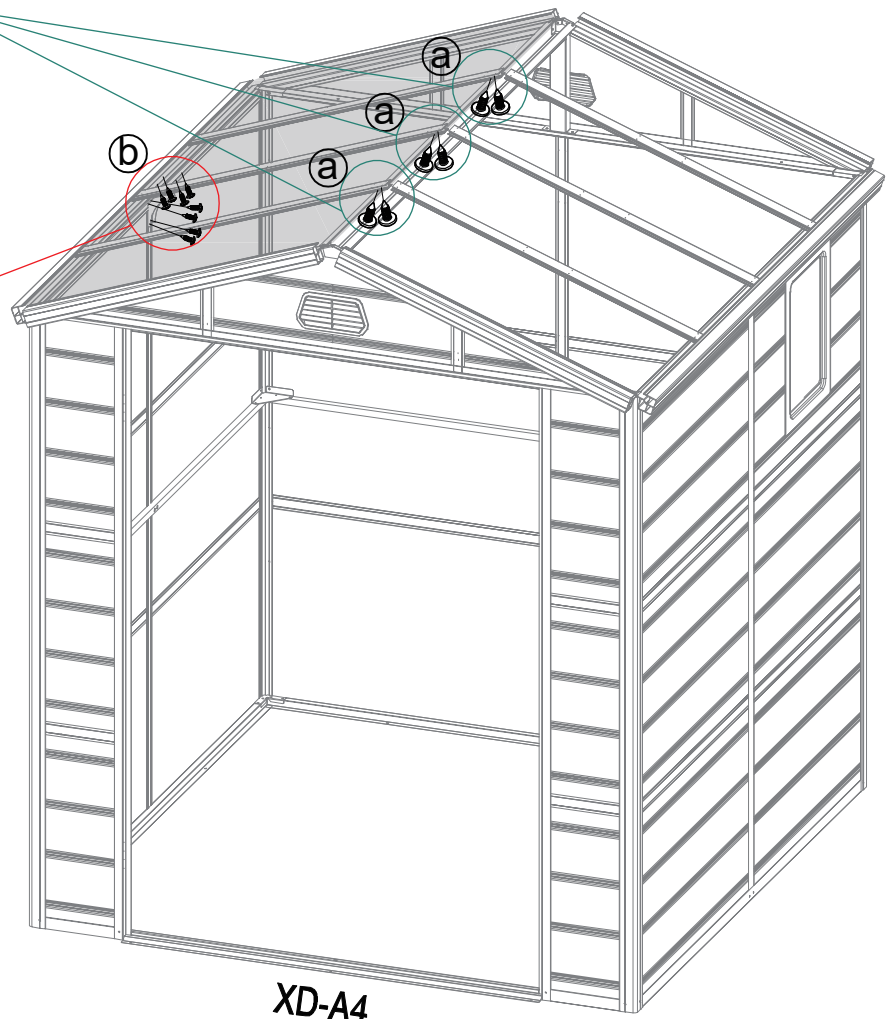

XD-A4

# 39

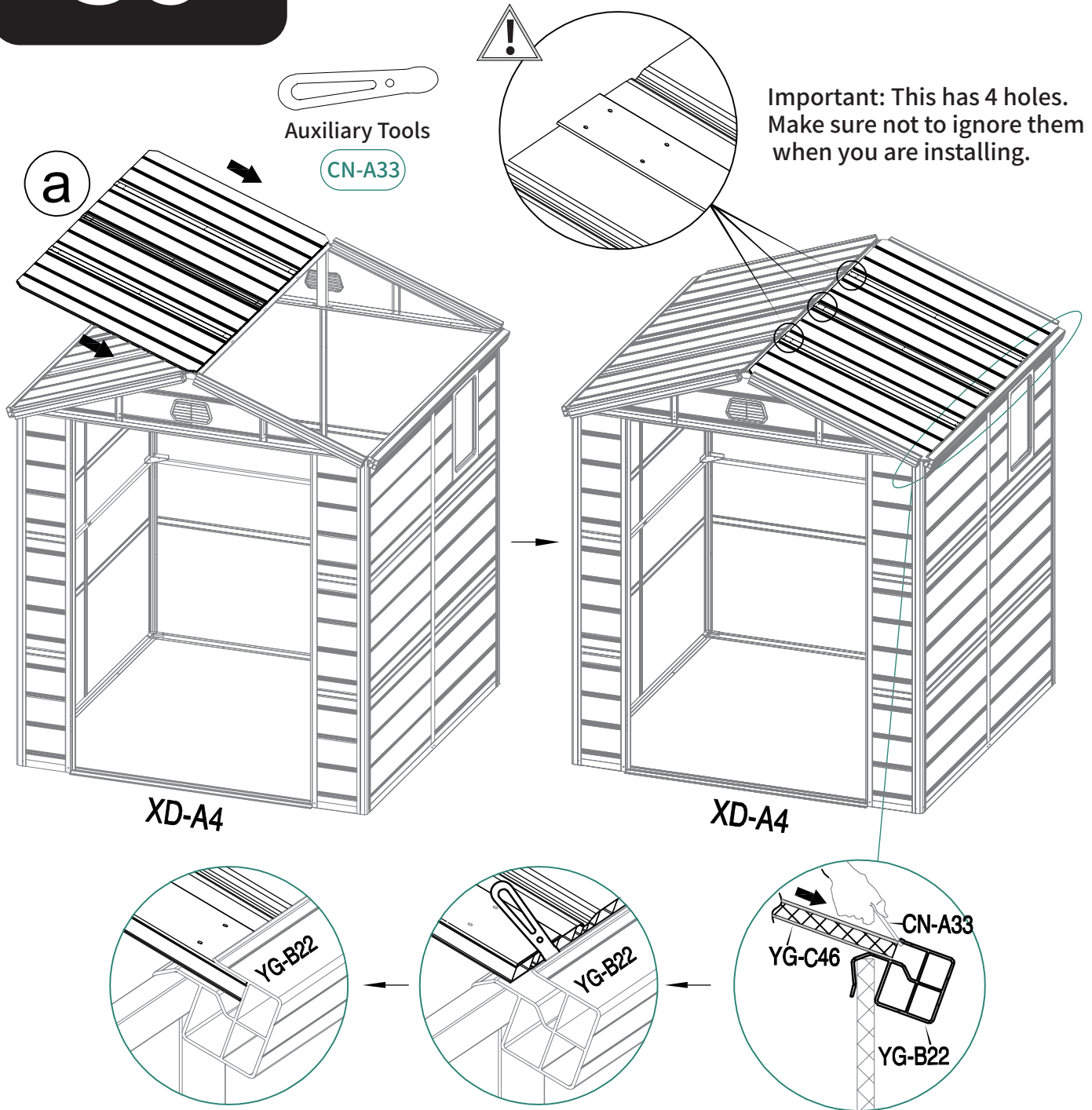

When sliding the roof panels into the slots, please use an assisting tool to ensure they are fully inserted into the tracks.

# 40

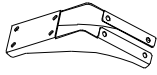

YG-3 1pc

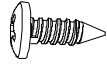

YG-D50 14pcs

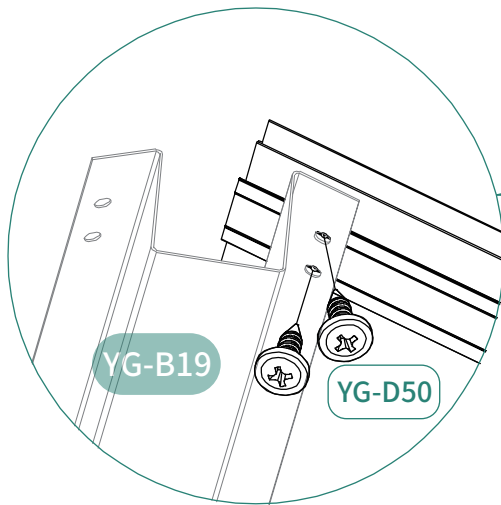

YG-B19

YG-D50

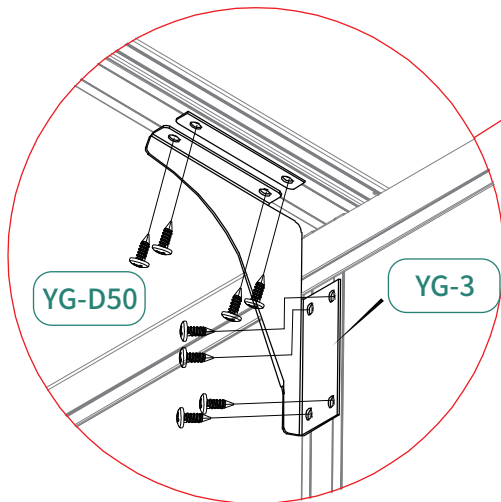

YG-D50

YG-3

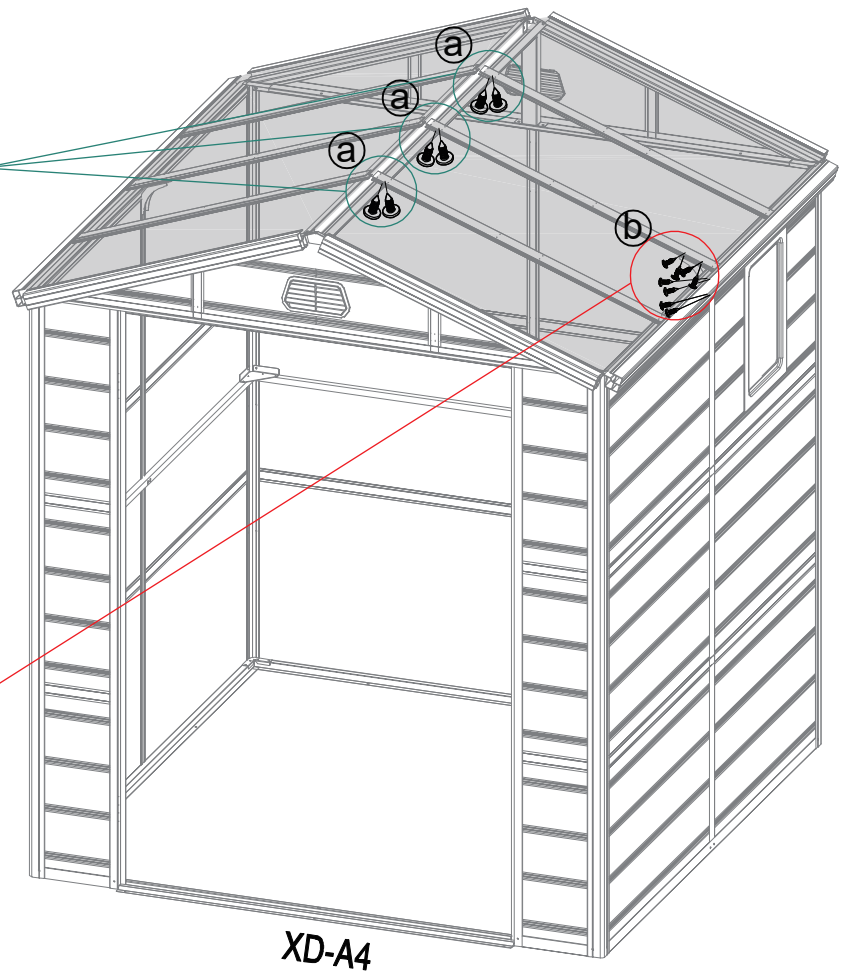

XD-A4

Undertake the installation process by accessing it from the roof's inner space/interior.

# 41

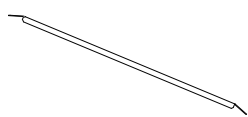

YG-D28 1pc

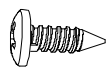

YG-D50 4pcs

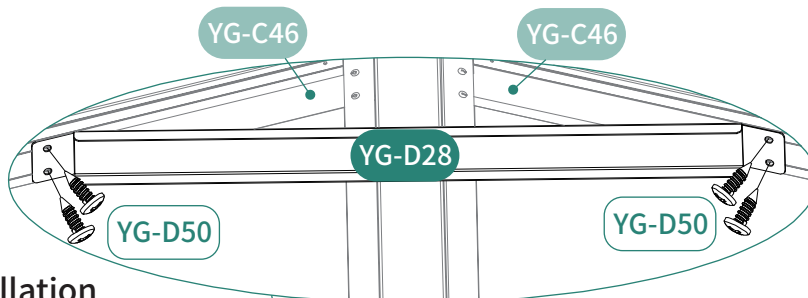

Undertake the installation process by accessing it from the roof's inner space/interior.

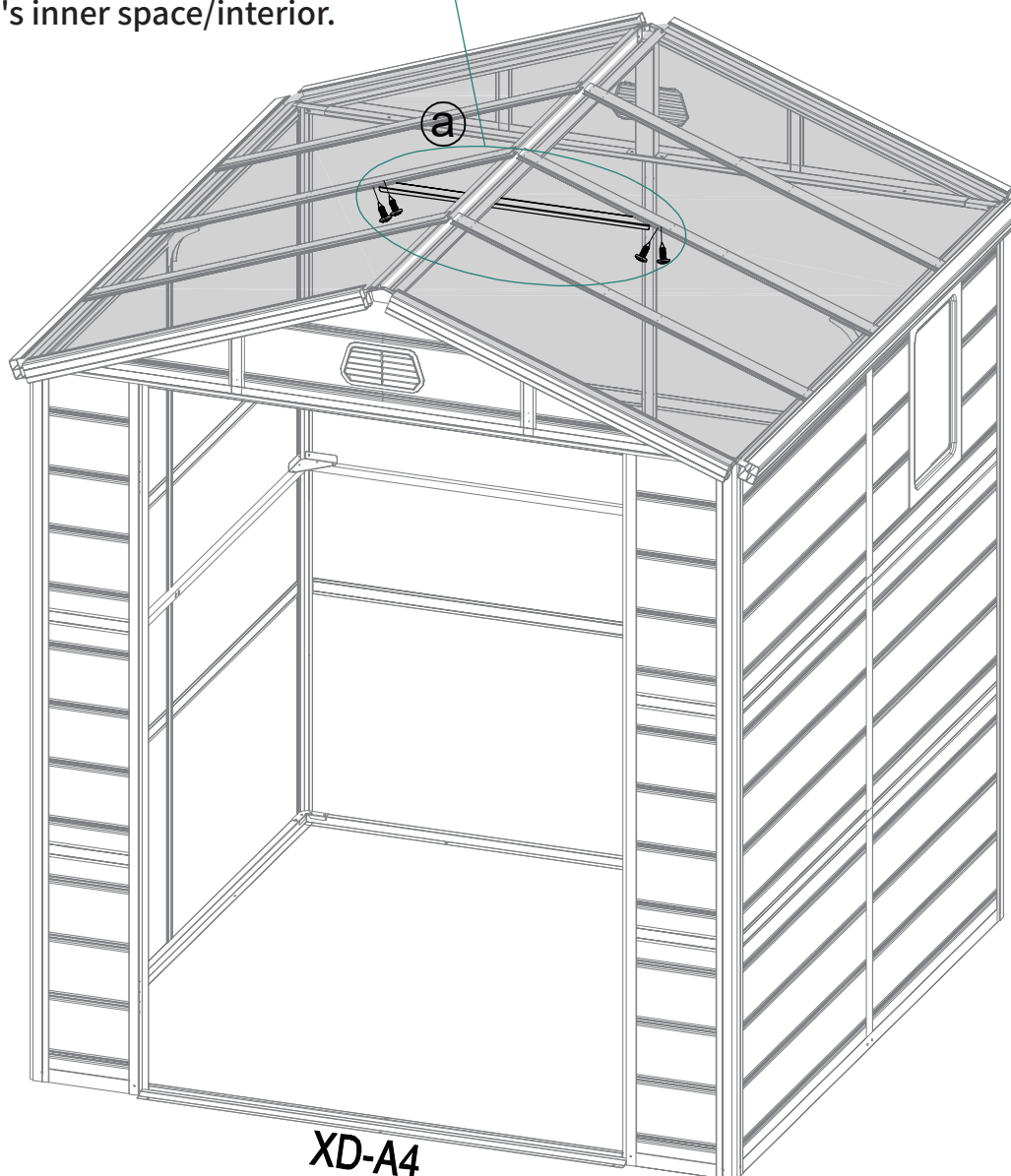

XD-A4



# 42

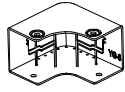

YG-8 4pcs

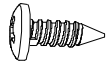

YG-D50 16pcs

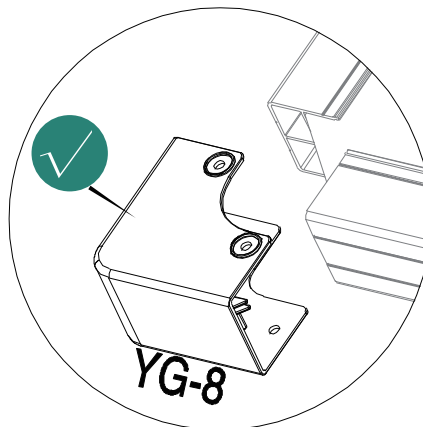
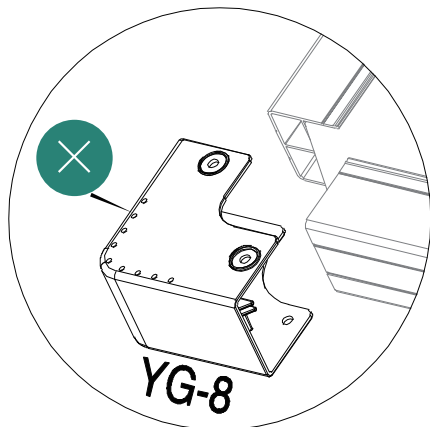
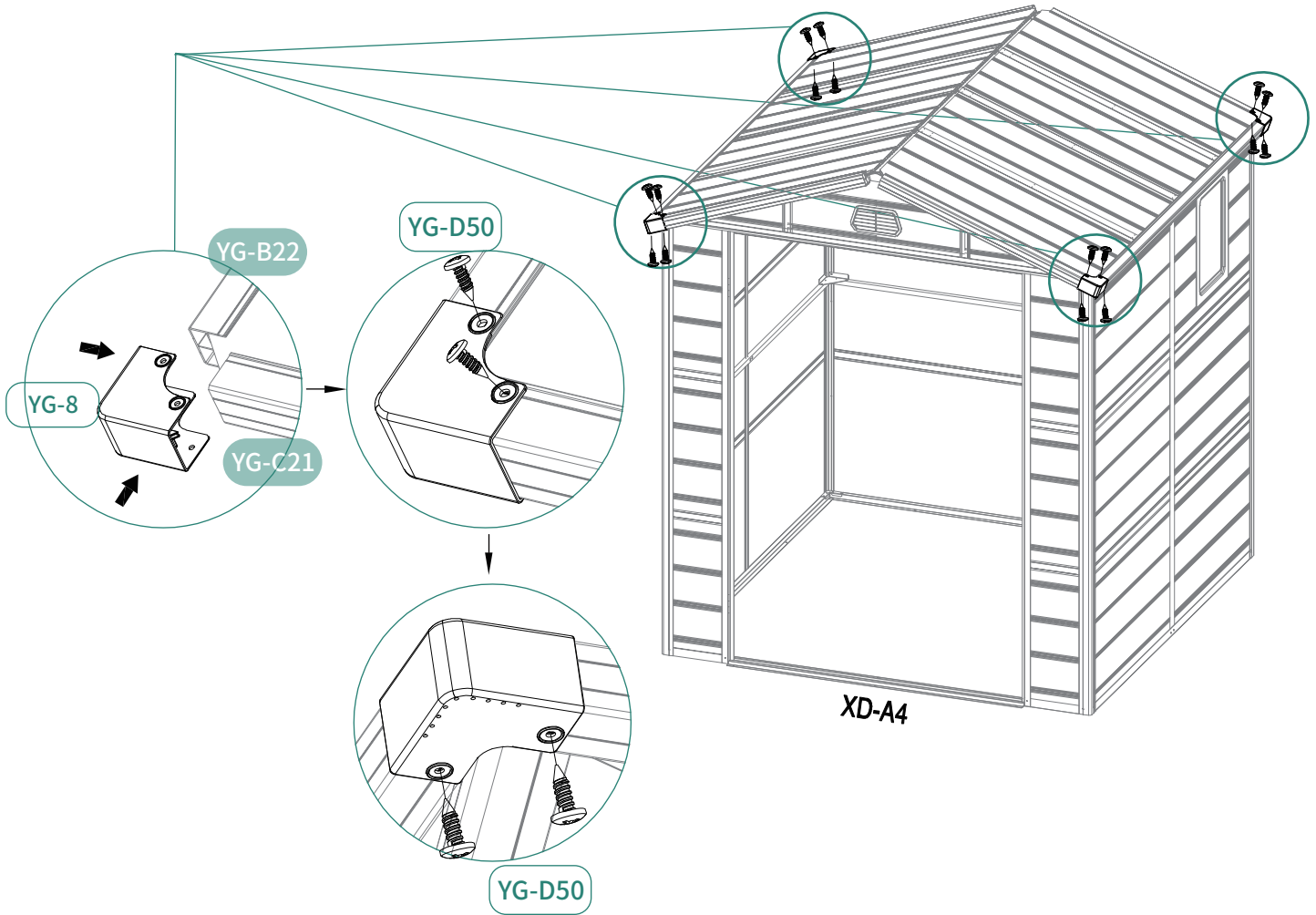

Remember to position the drainage holes pointing down when putting in the corner/edge accessory pieces.

# 43



YG-D52 6pcs

YG-D50 4pcs

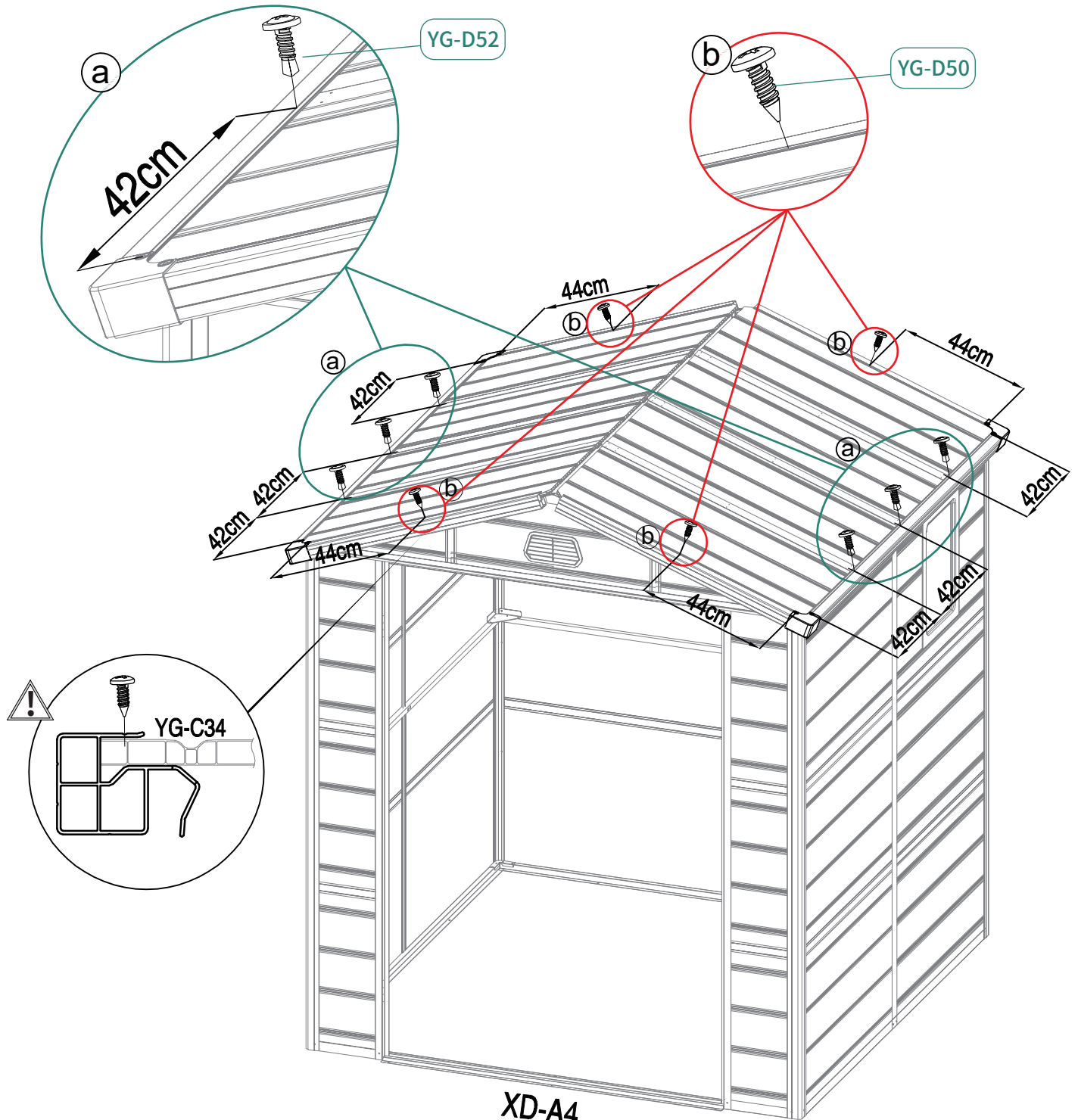

**XD-A4**

44

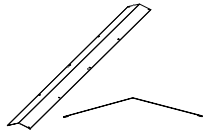

YG-B23 1pc

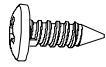

YG-D50 8pcs

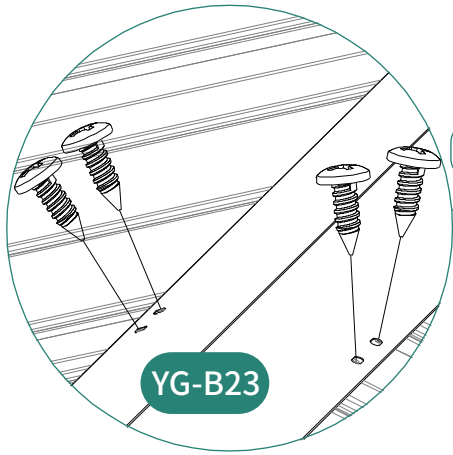

YG-B23

YG-D50

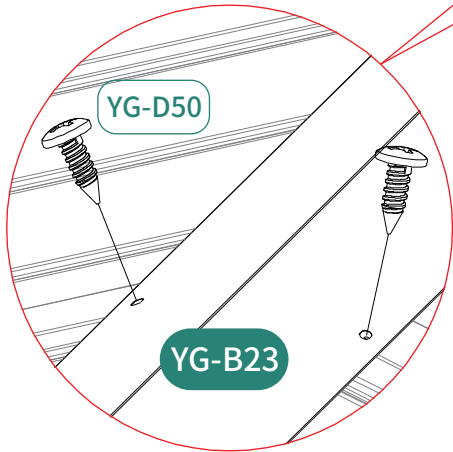

YG-D50

YG-B23

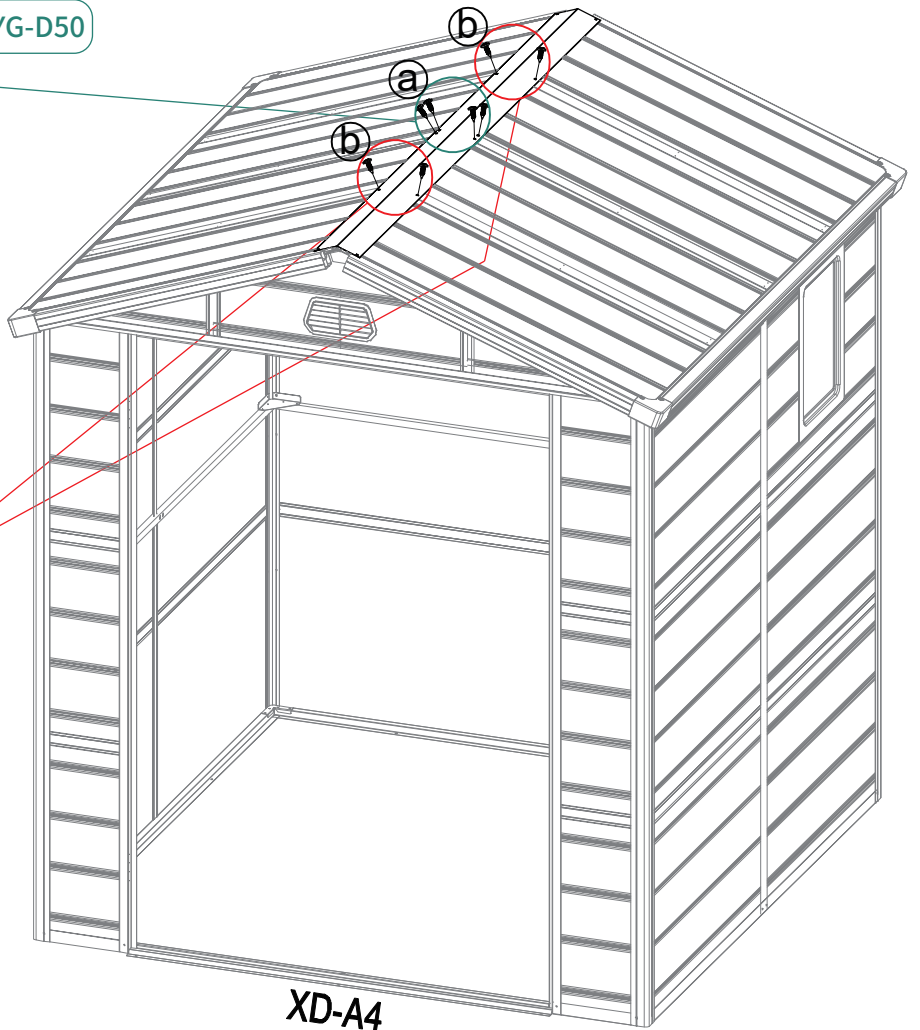

45



YG-7 2pcs

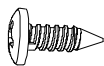

YG-D50 4pcs

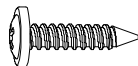

YG-D51 4pcs

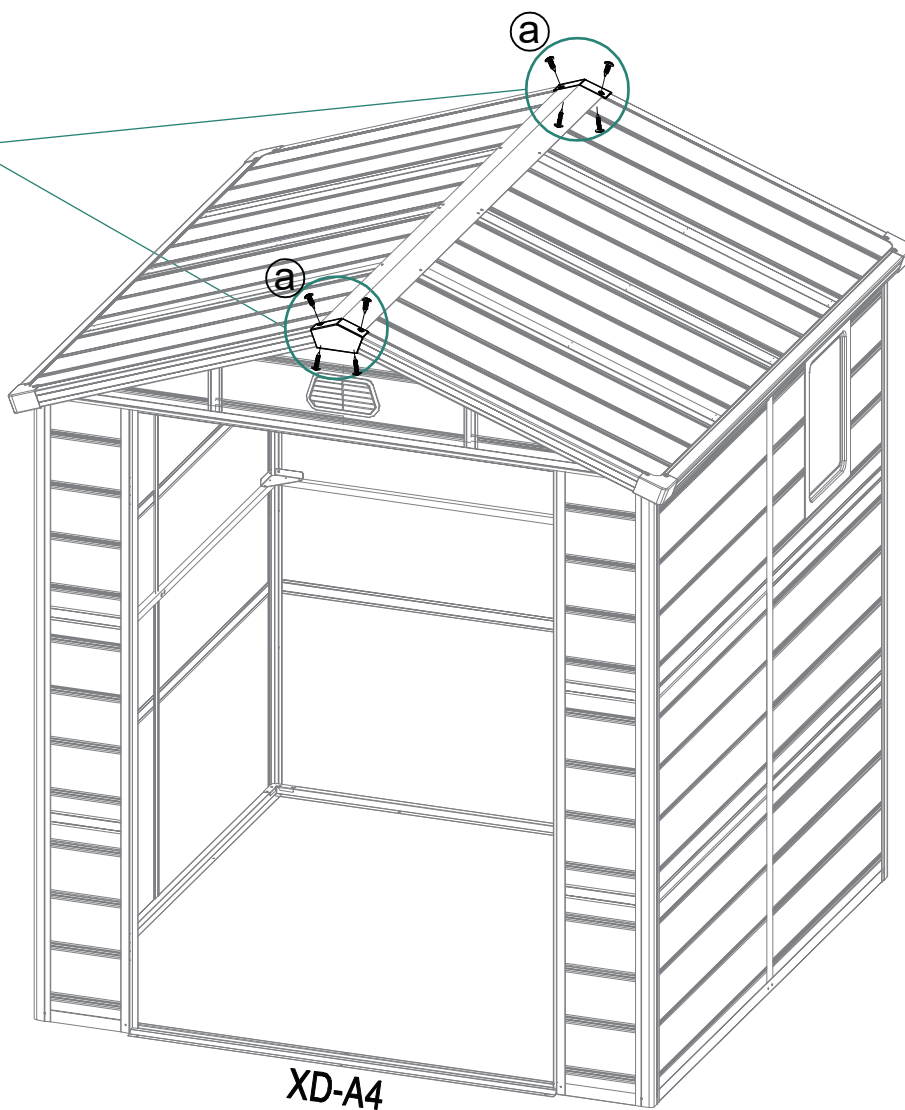
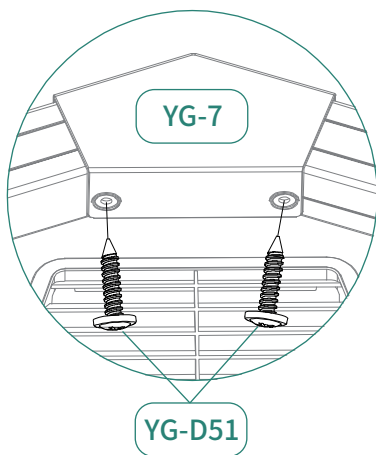
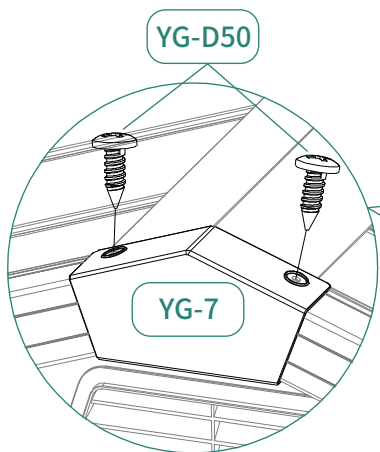

# 46

## X2

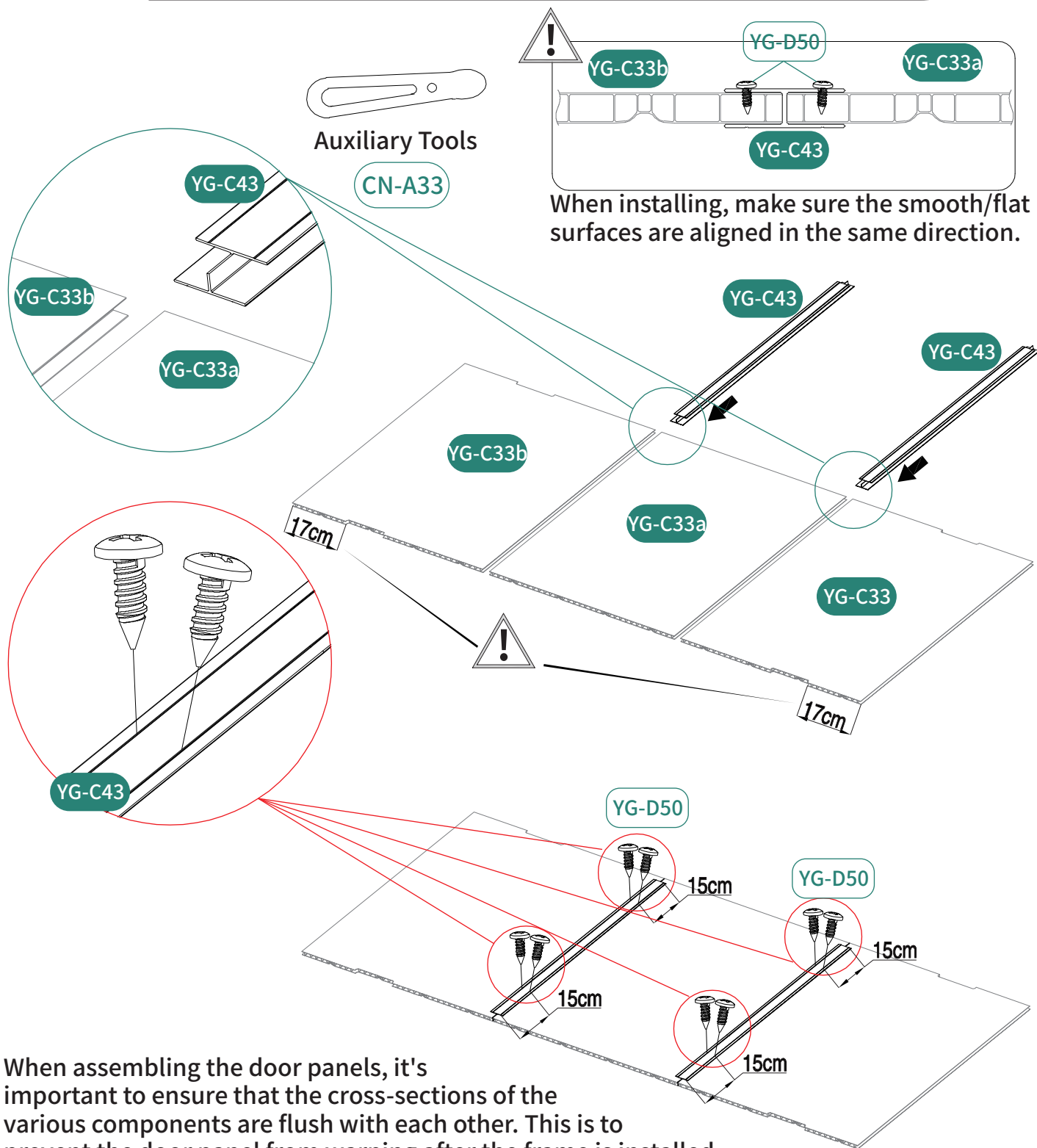
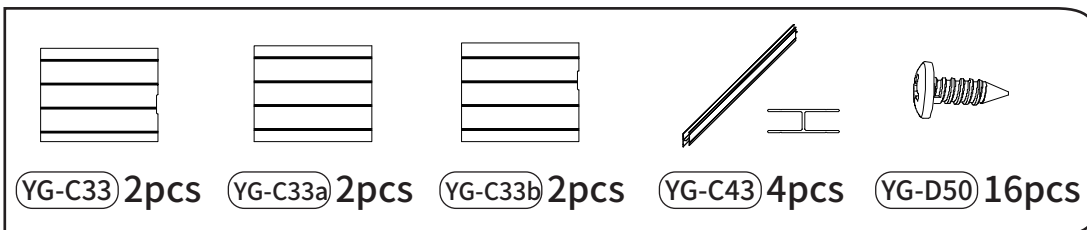

When assembling the door panels, it's important to ensure that the cross-sections of the various components are flush with each other. This is to prevent the door panel from warping after the frame is installed.

47

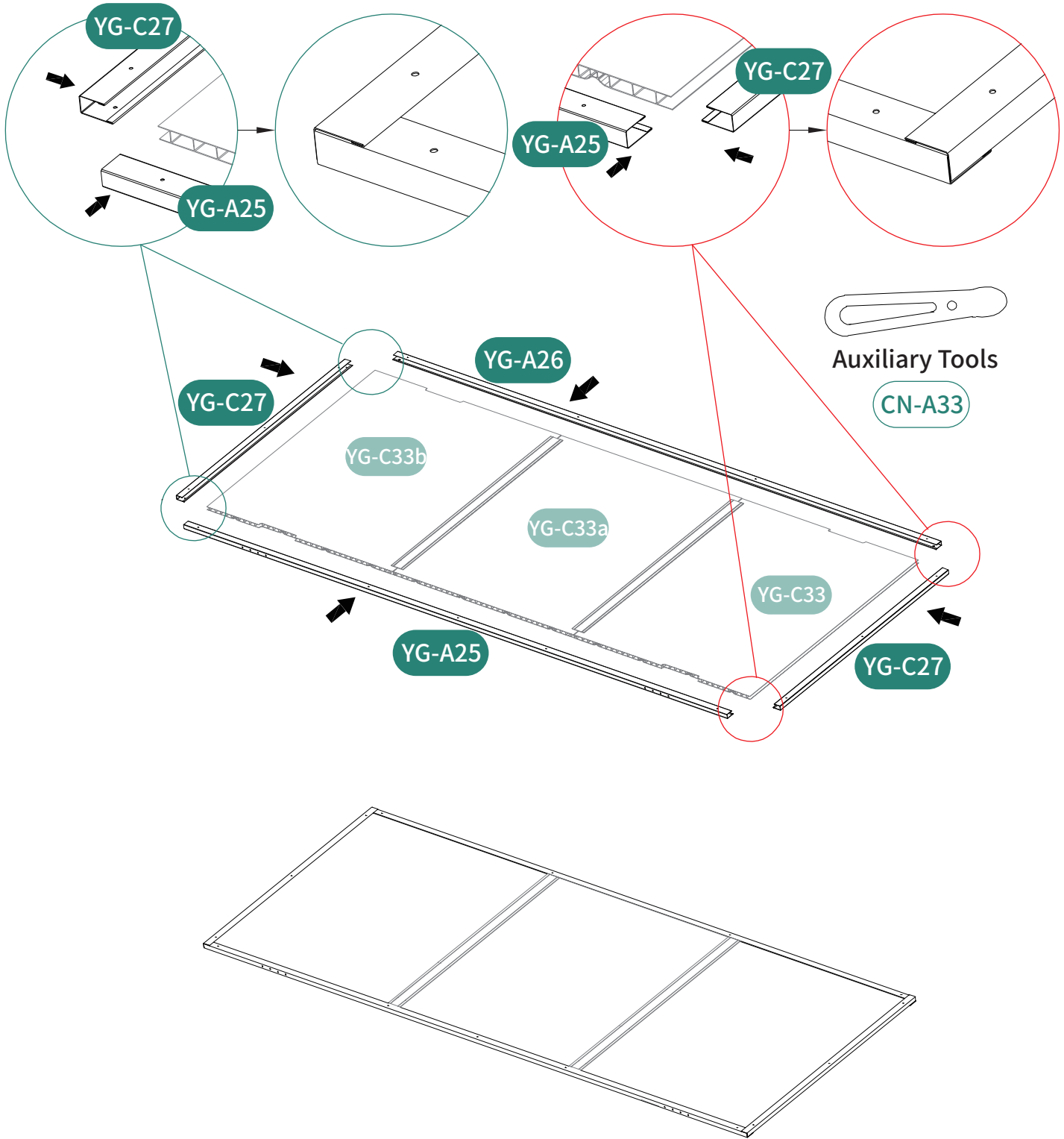
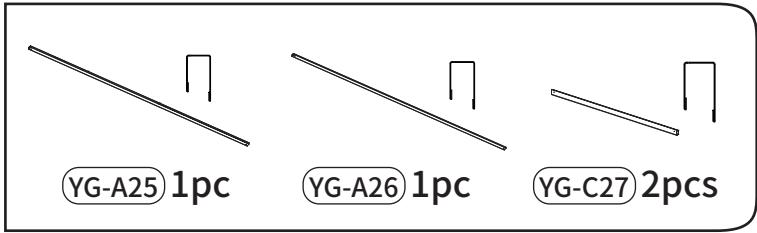

# 48

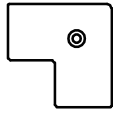

YG-10 4pcs



YG-D50 10pcs

# R

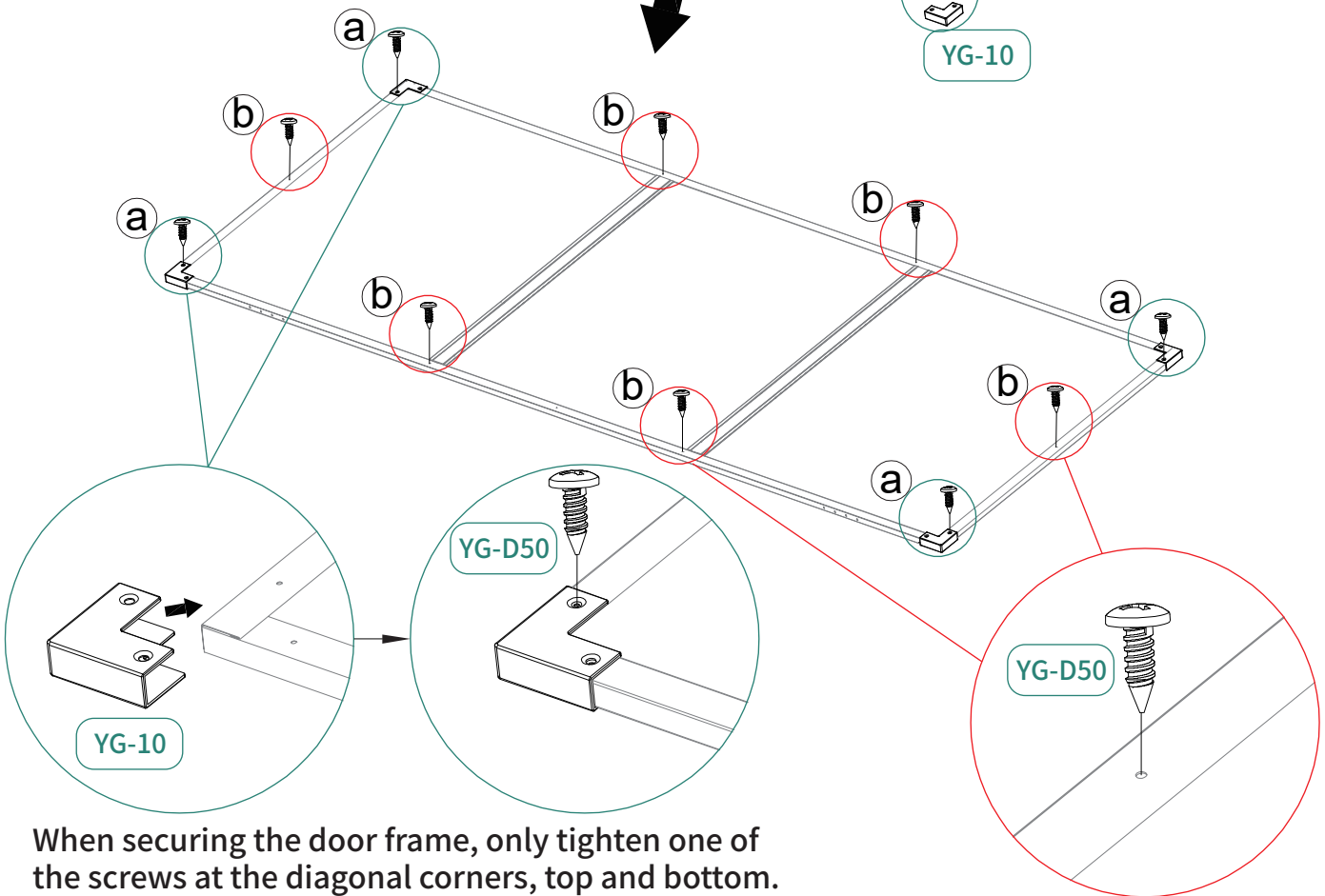
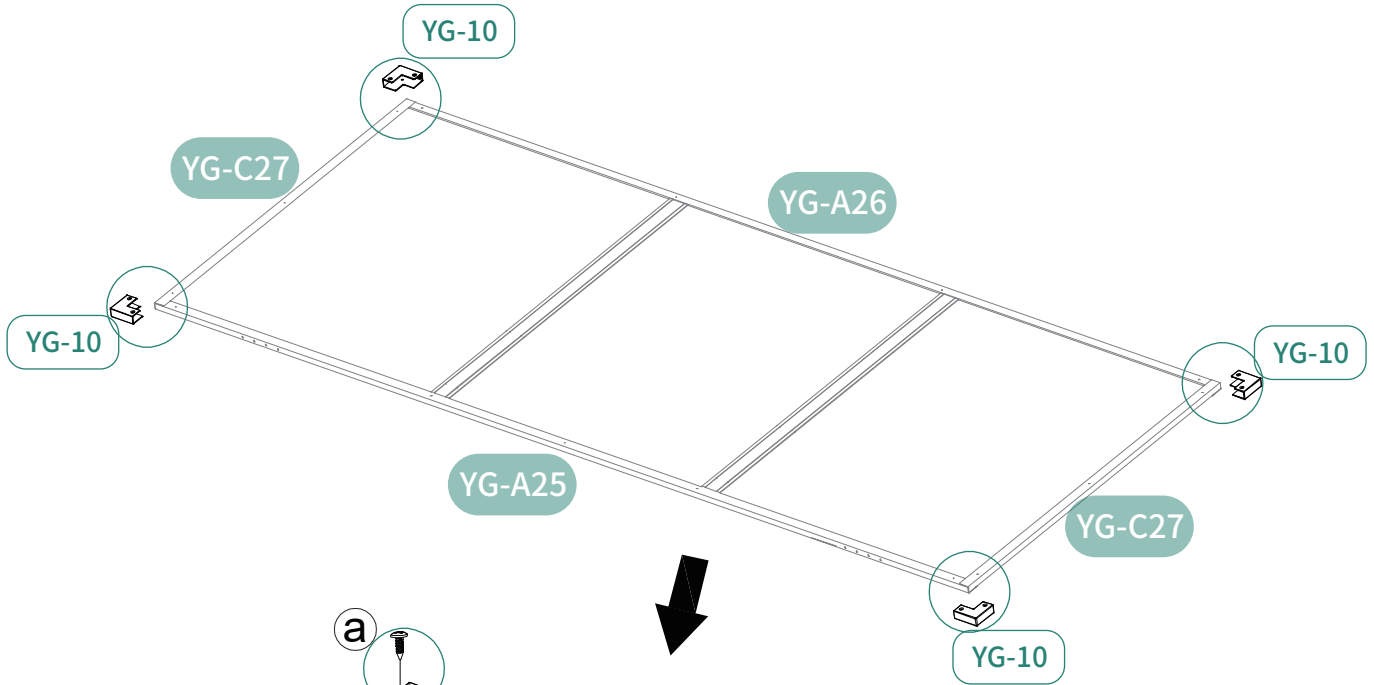

When securing the door frame, only tighten one of the screws at the diagonal corners, top and bottom.

# 49

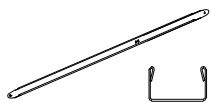

YG-C48 2pcs



YG-D50 7pcs

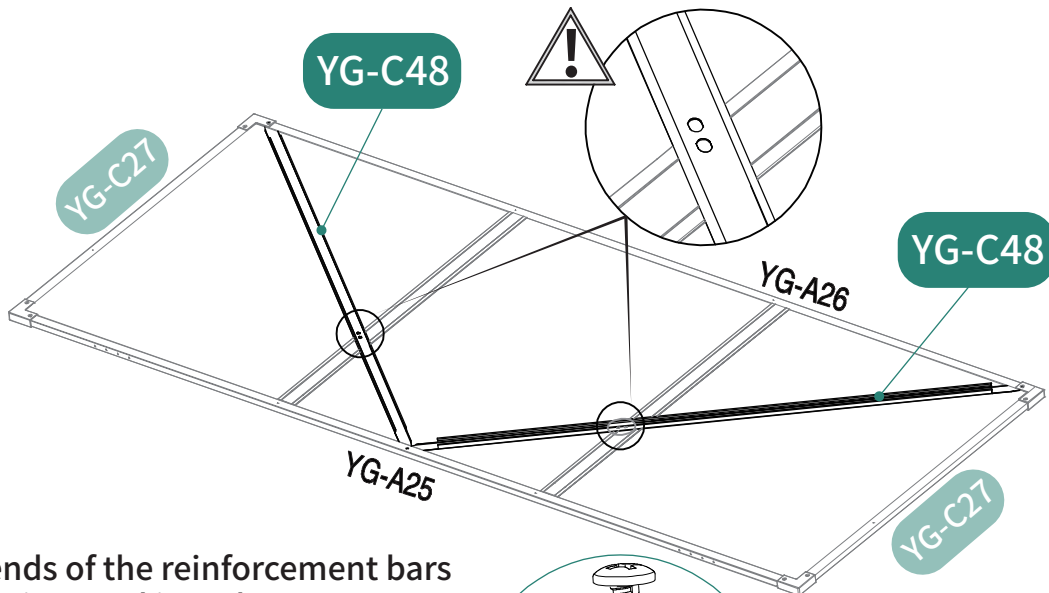

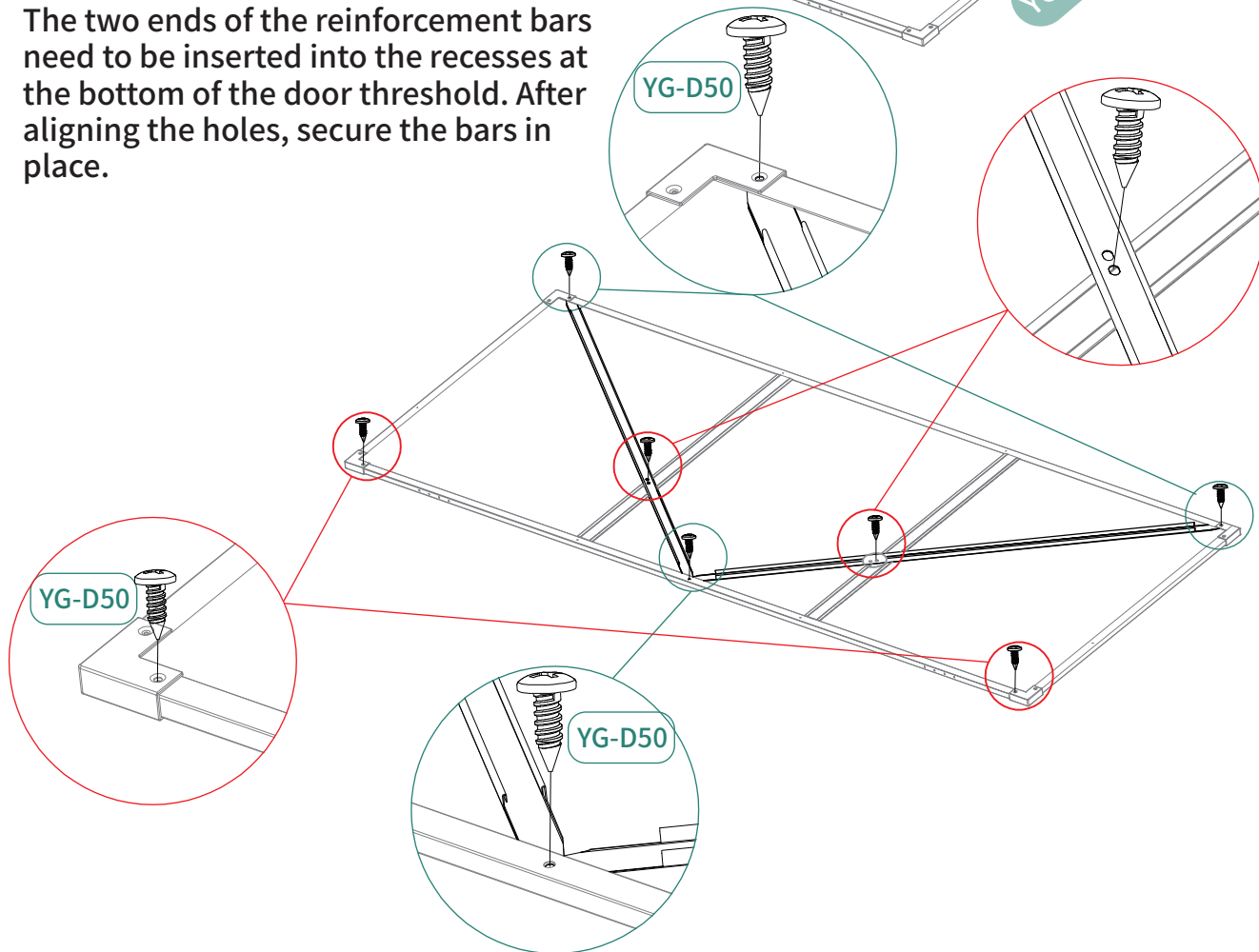

The two ends of the reinforcement bars need to be inserted into the recesses at the bottom of the door threshold. After aligning the holes, secure the bars in place.



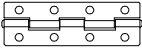

# 50

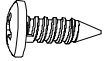
		
XD-6 2pcs	YG-D53 8pcs	YG-D50 4pcs

# R

When installing hinges, pay attention to the direction of swing to prevent installing them incorrectly.

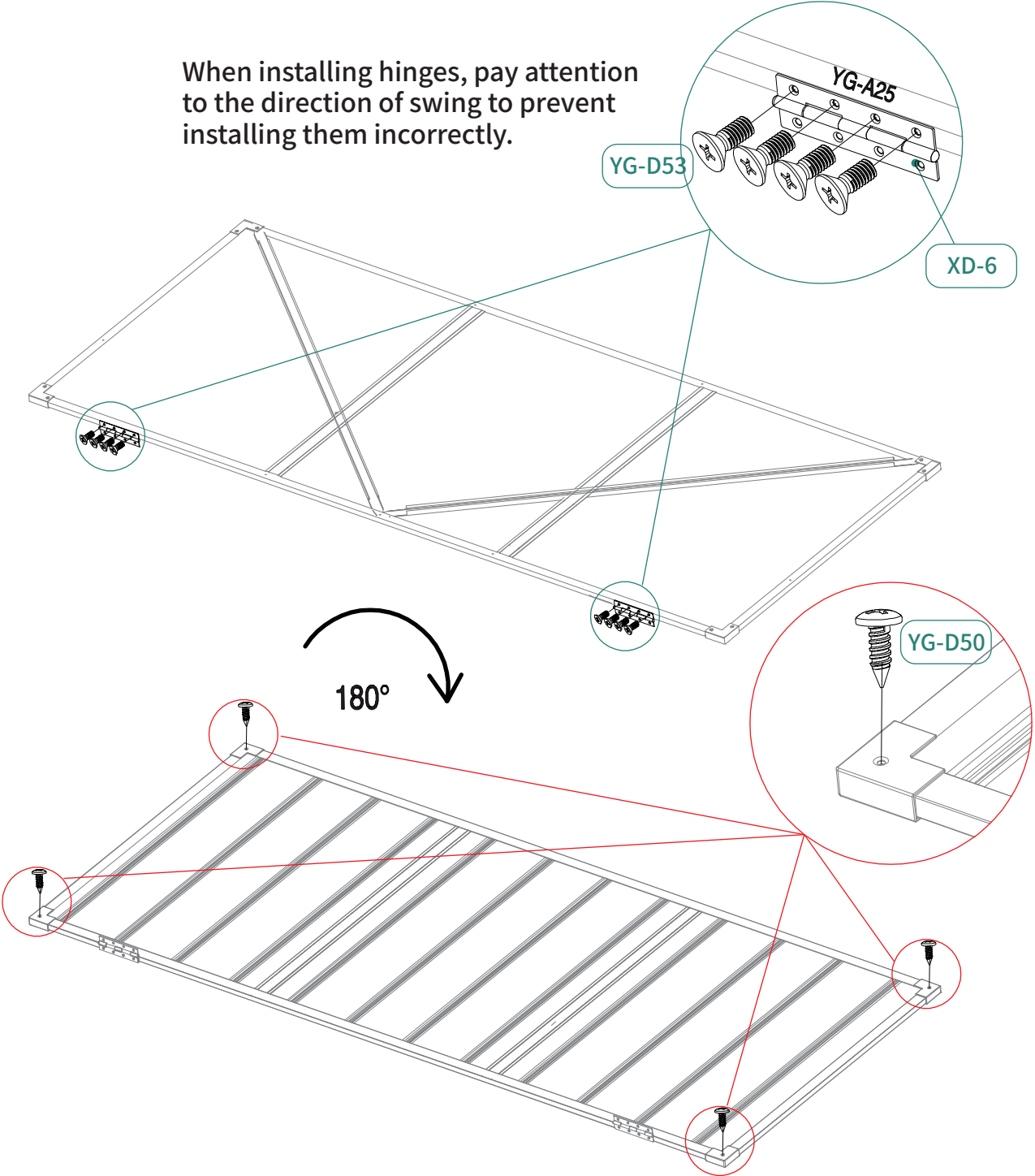

# 51

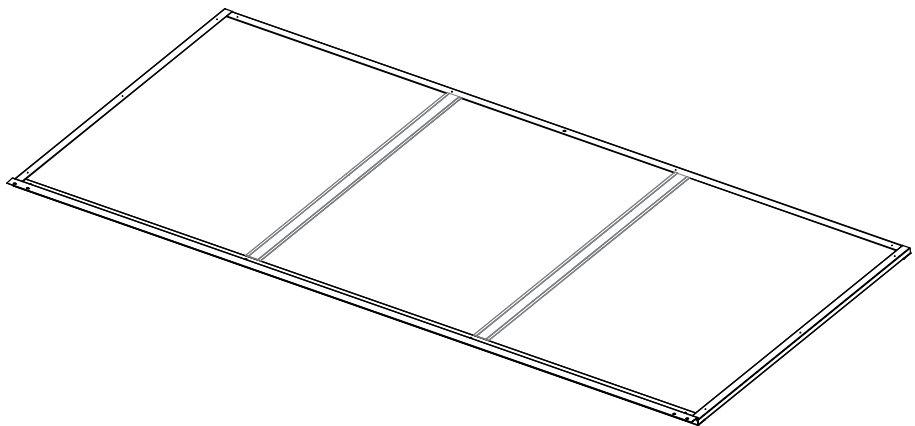
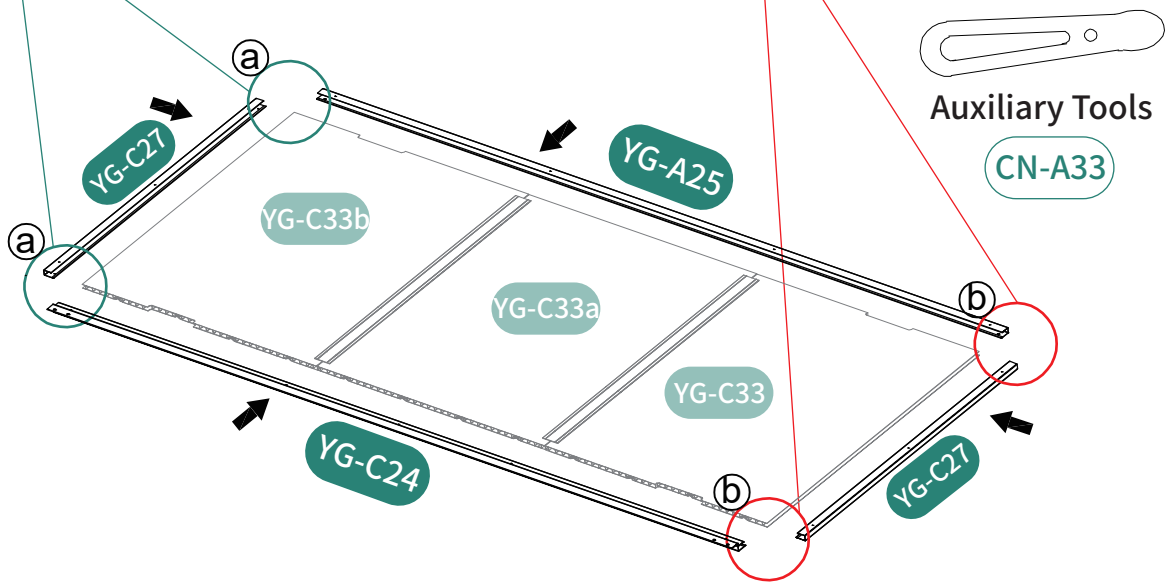
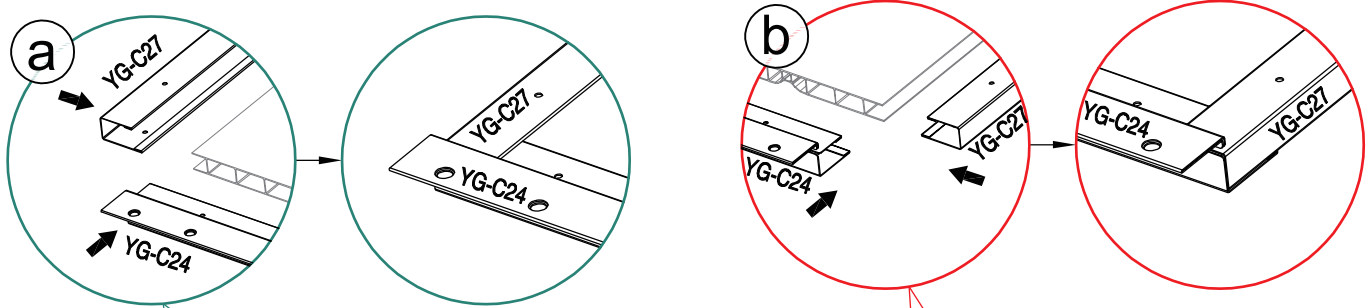
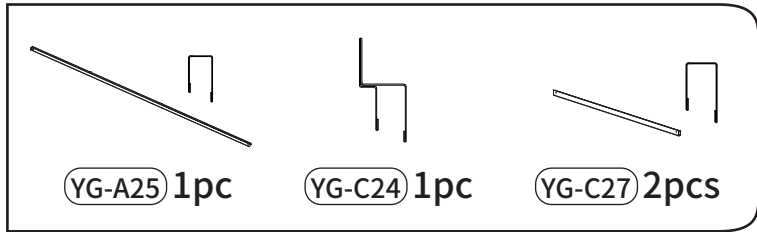

# 52

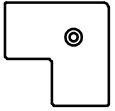
 **YG-10** 4pcs

 **YG-D50** 10pcs

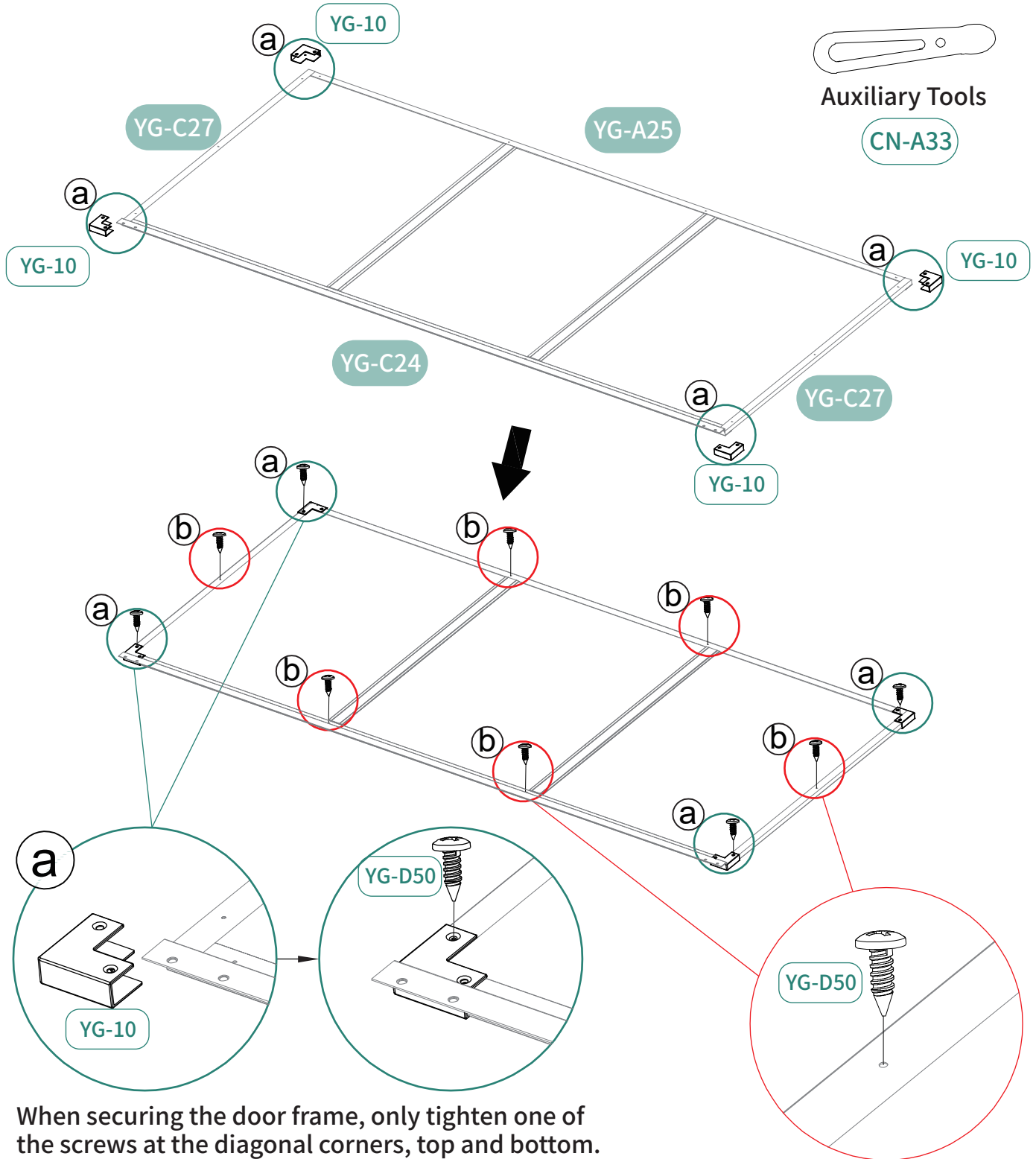

When securing the door frame, only tighten one of the screws at the diagonal corners, top and bottom.

# 53

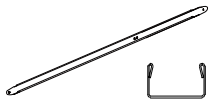

YG-C48 2pcs



YG-D50 7pcs

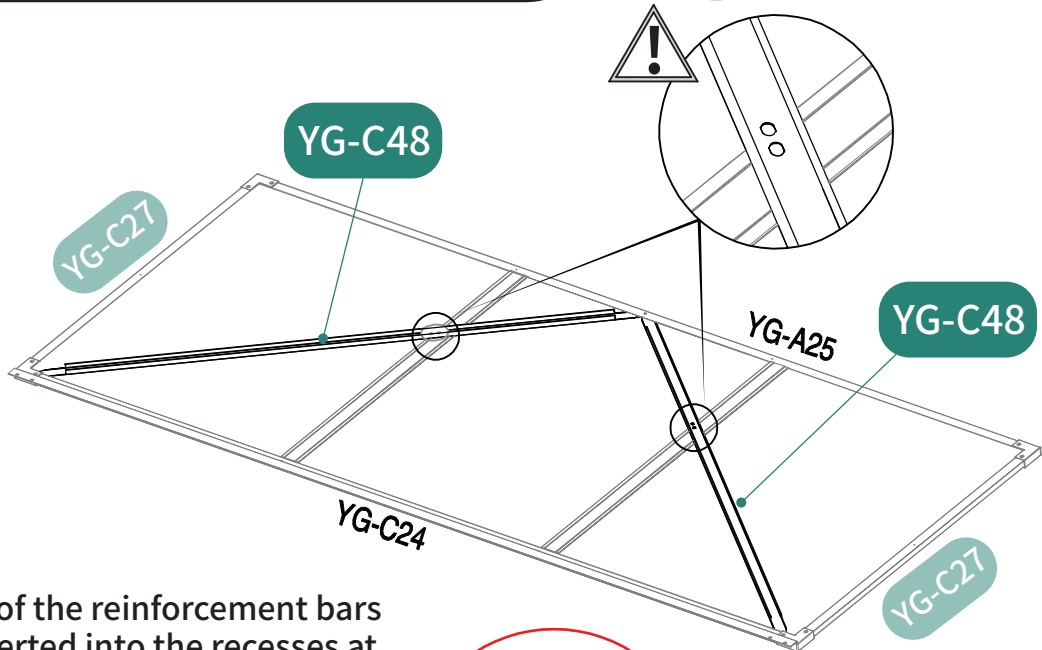
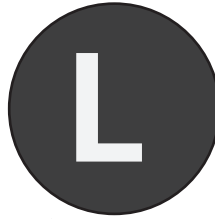

The two ends of the reinforcement bars need to be inserted into the recesses at the bottom of the door threshold. After aligning the holes, secure the bars in place.

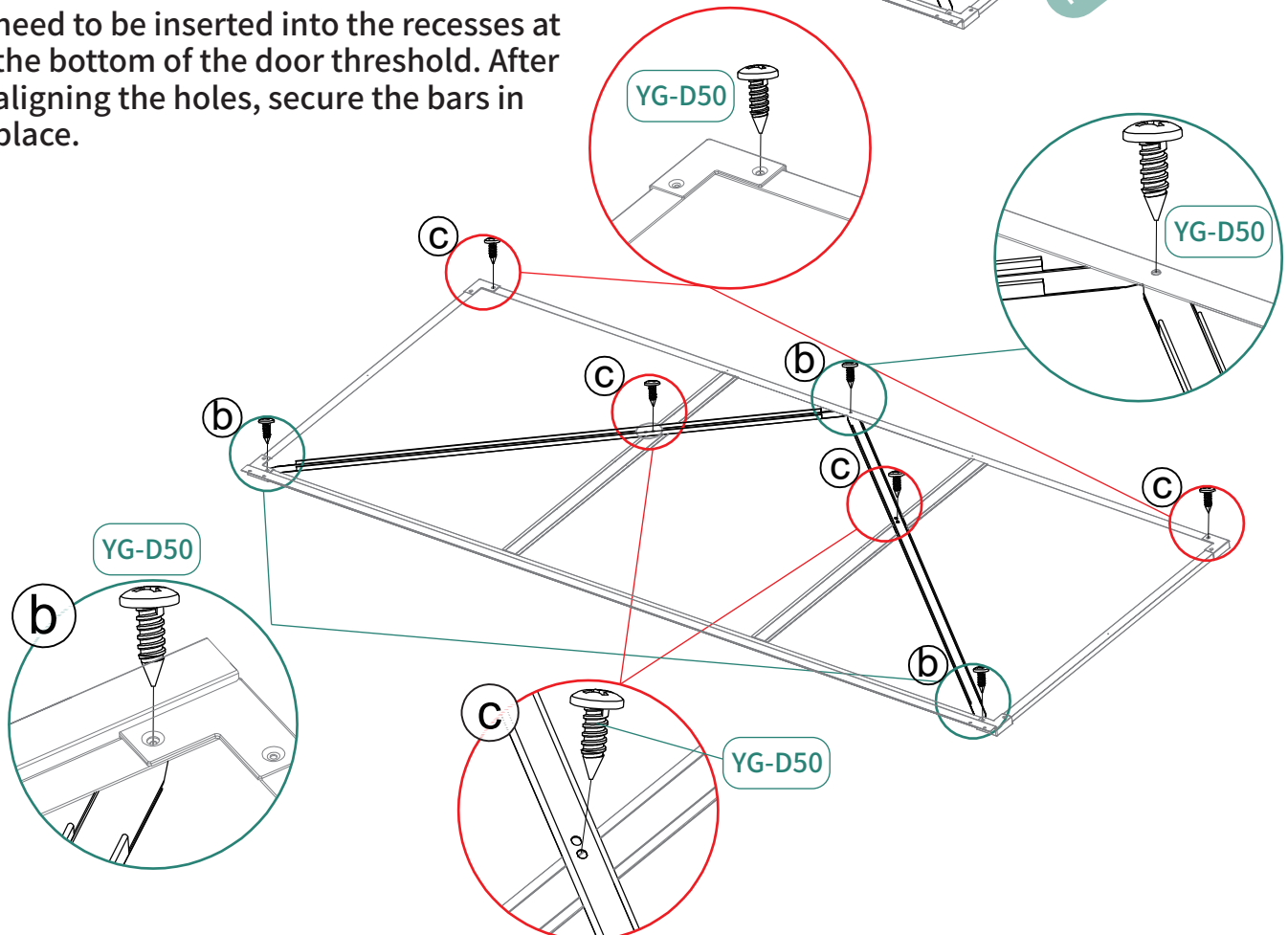

54

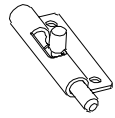

XD-7 1pc

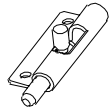

XD-8 1pc

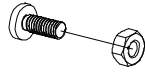

YG-D55 4pcs

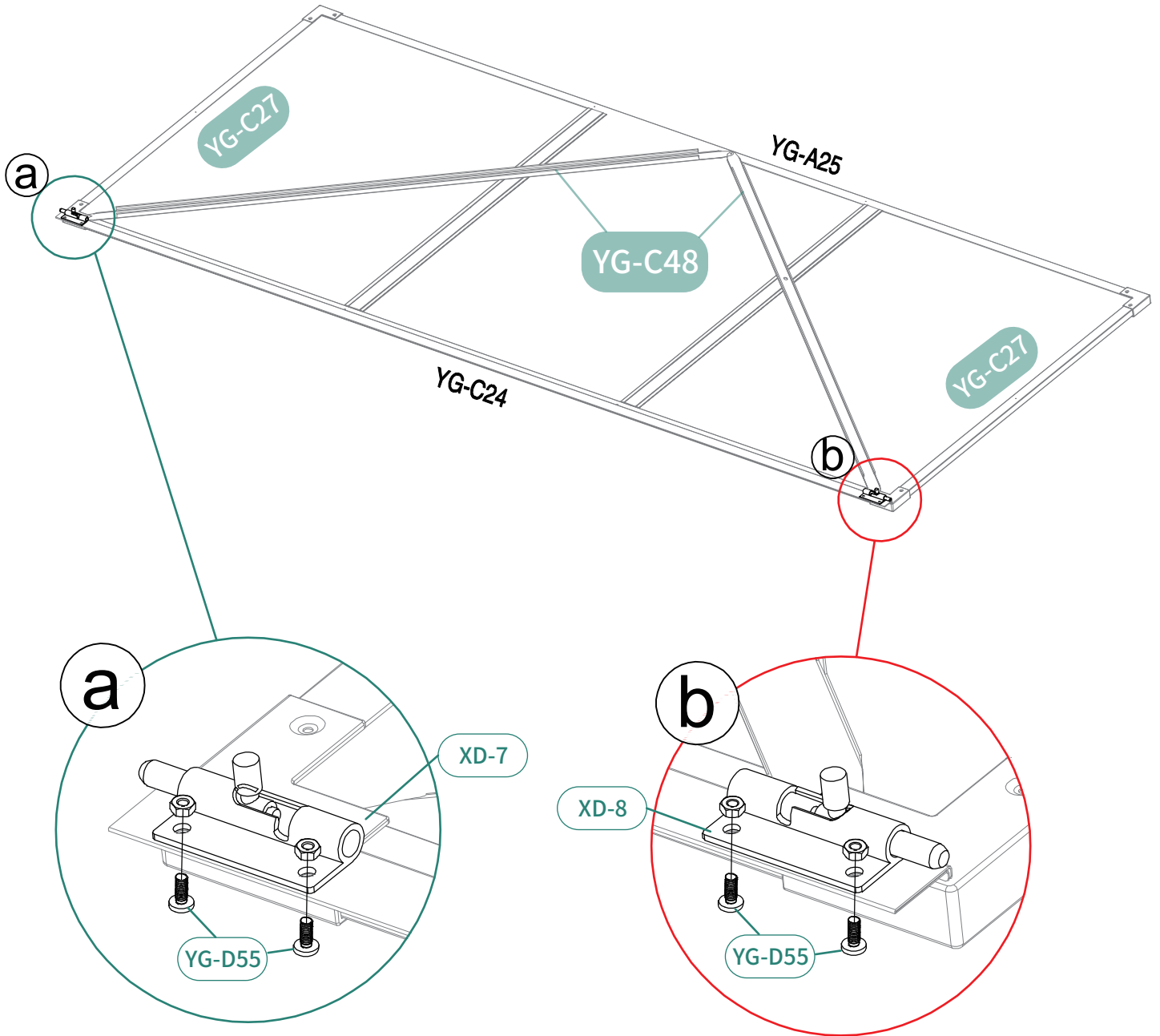

# 55

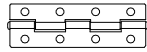

XD-6 2pcs



YG-D53 8pcs

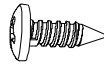

YG-D50 4pcs



When installing hinges, pay attention to the direction of swing to prevent installing them incorrectly.

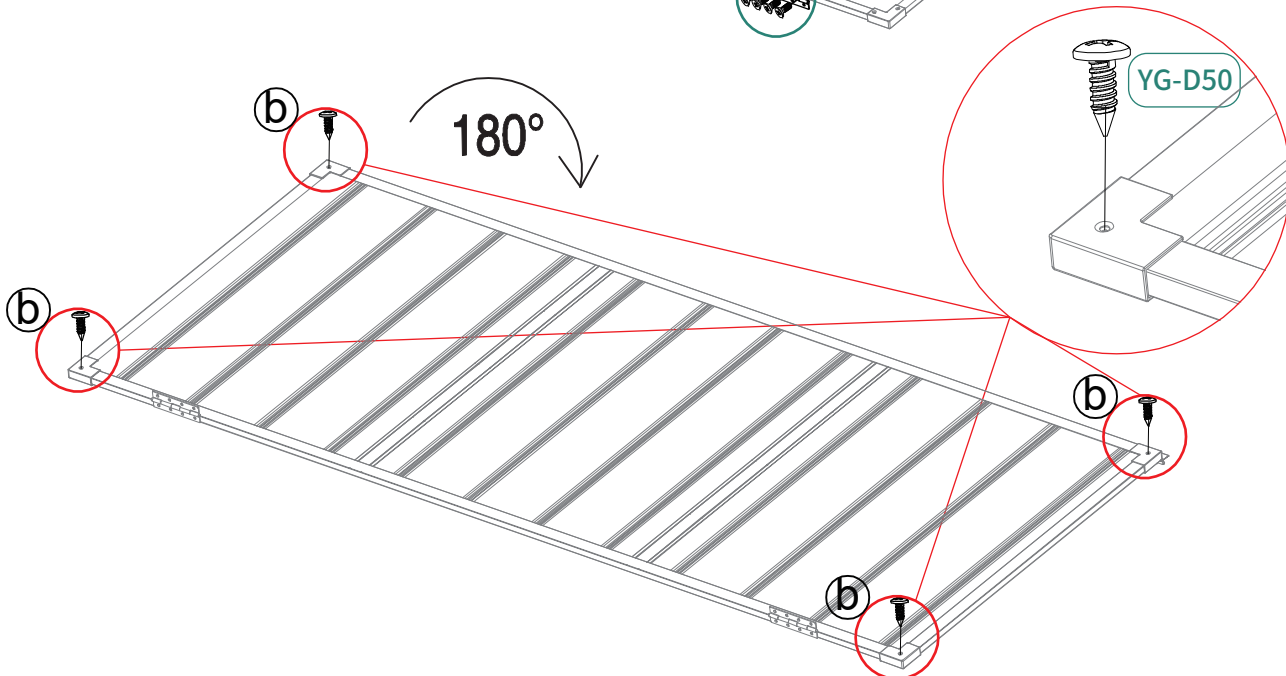
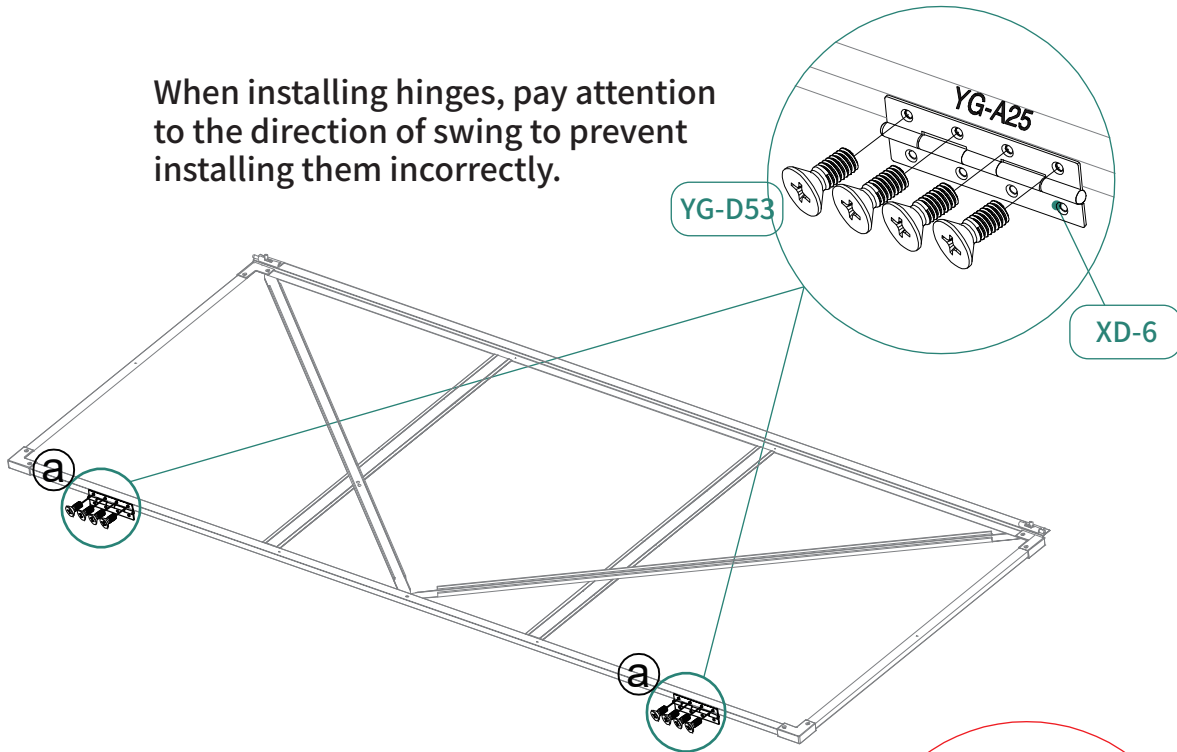

56



YG-D54 8pcs

YG-D54

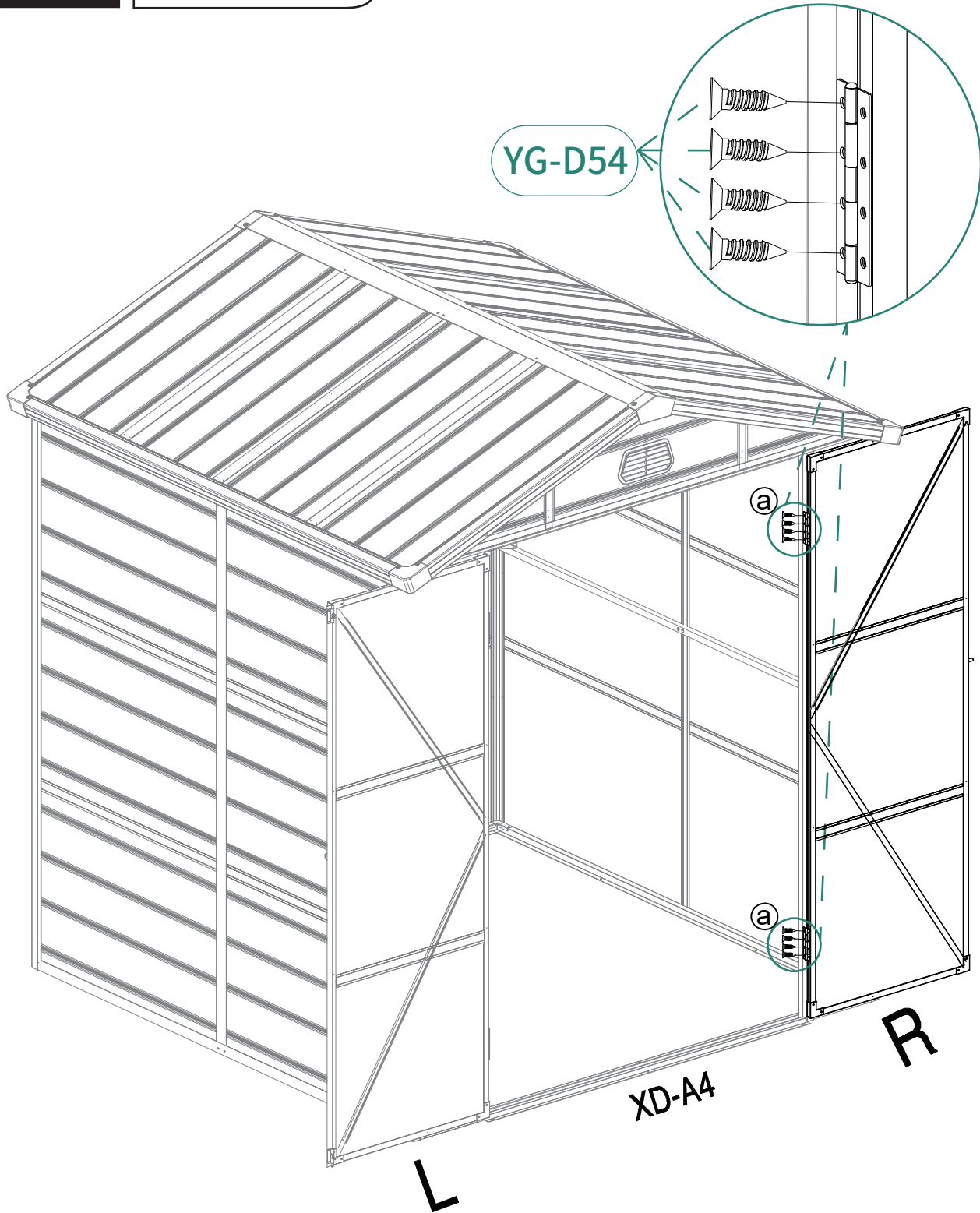

57



YG-D54 8pcs

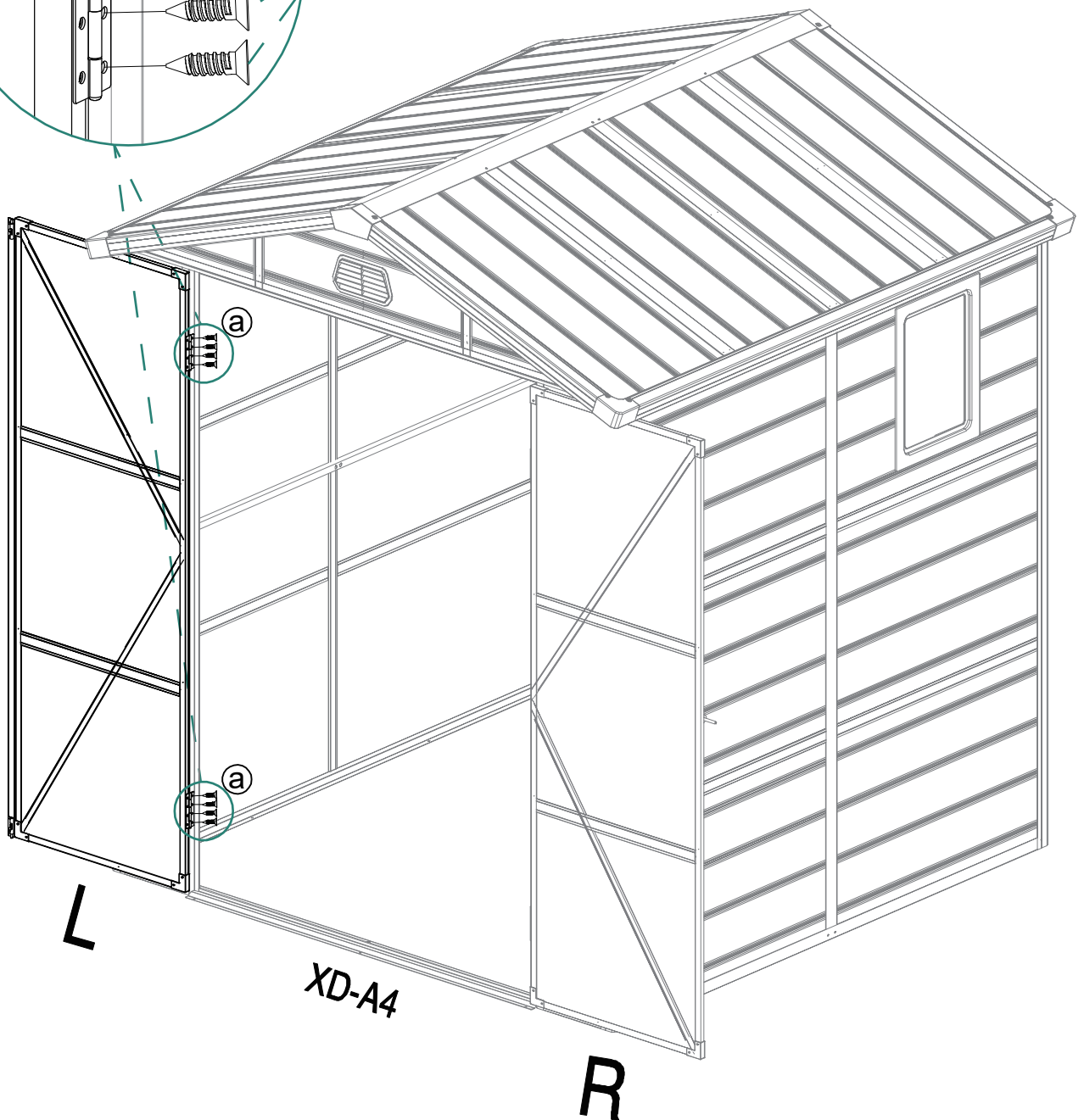
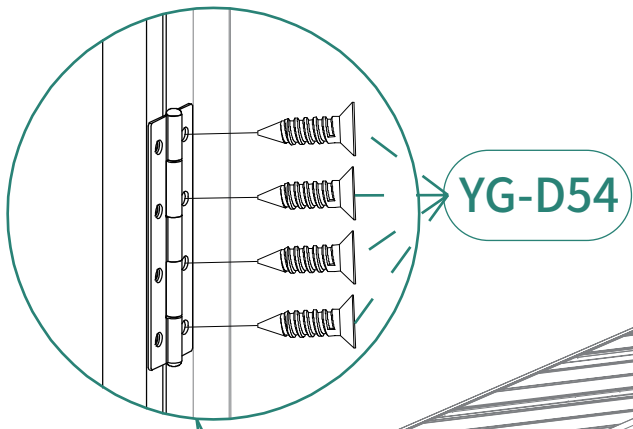



58



XD-5 1pc PA01 3pcs YG-D51 3pcs YG-D52 2pcs

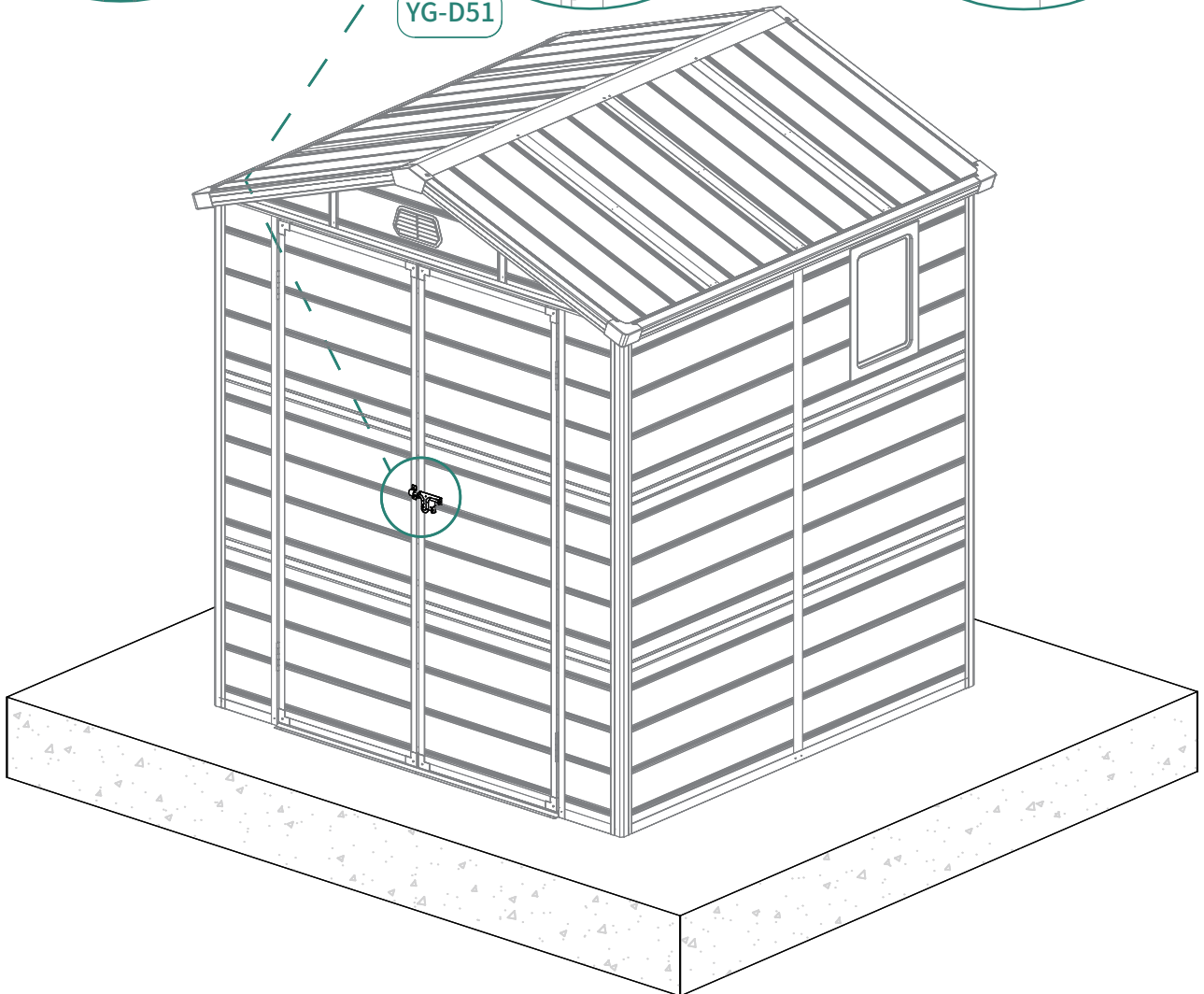
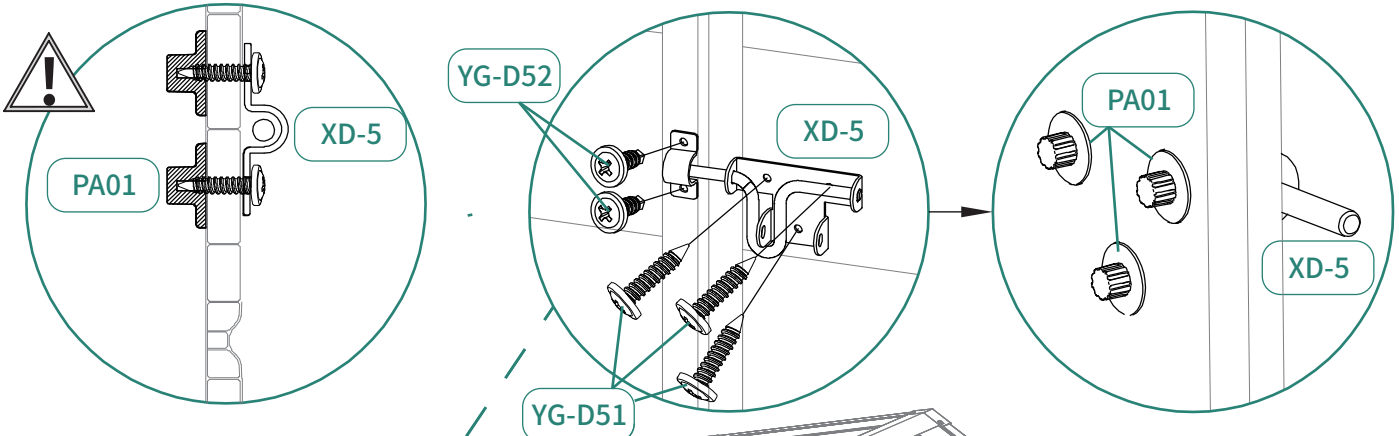

# 59

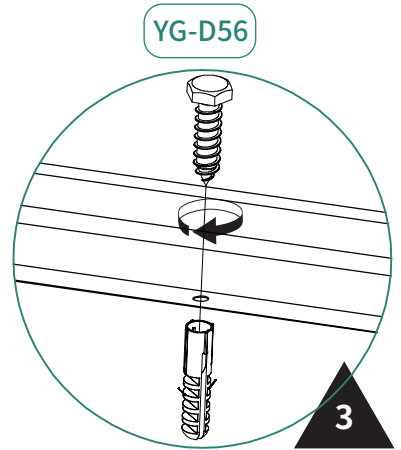
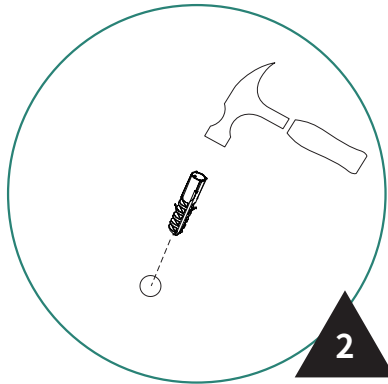
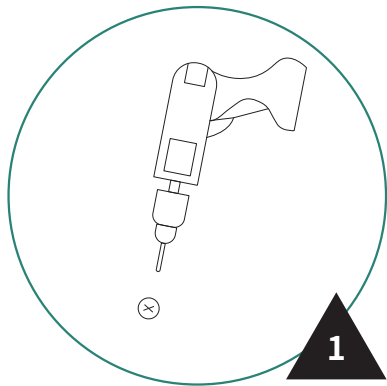
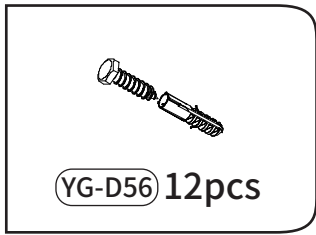

Upon completing the installation, the house can be further reinforced by connecting it to the floor using expansion anchors.

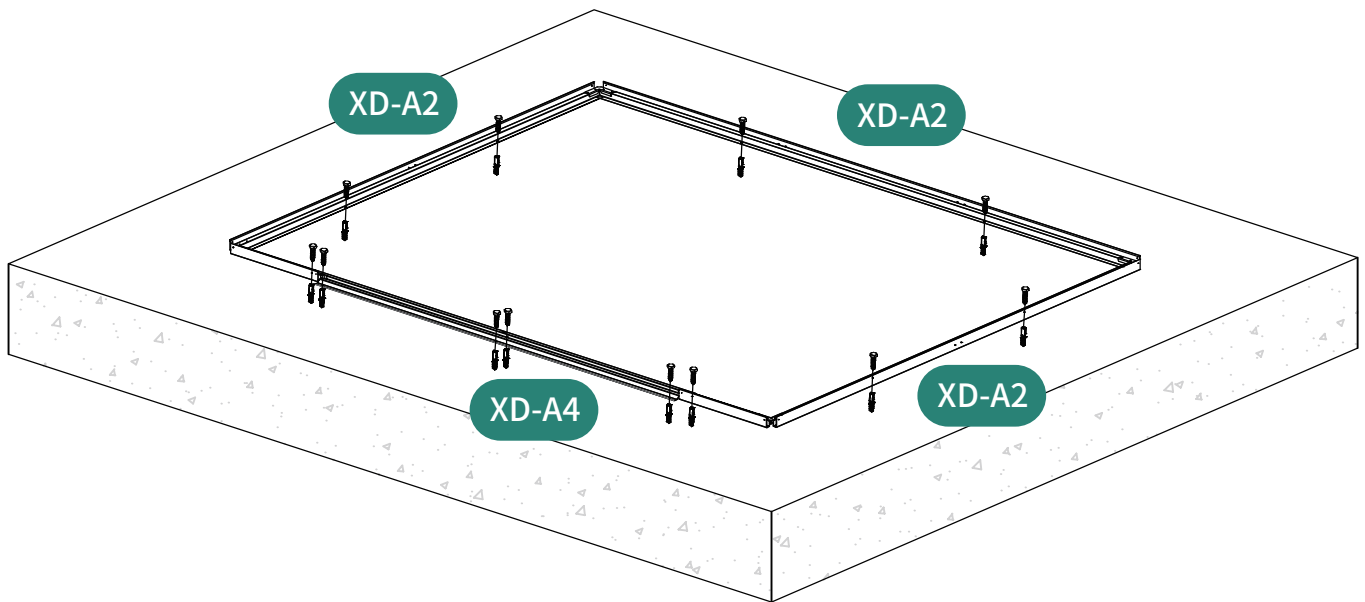

60

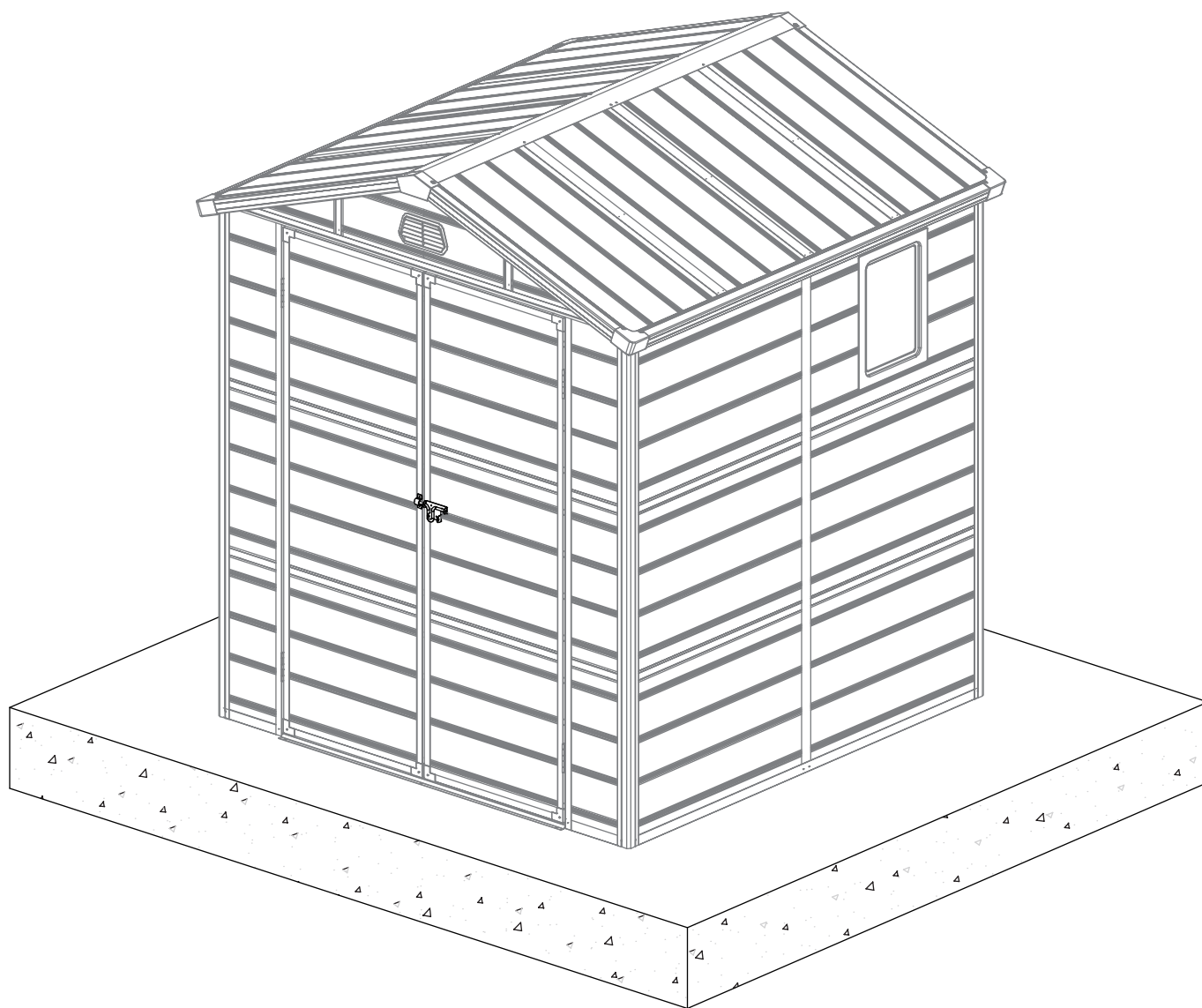

Installation Completed



Manufacturer and seller expressly disclaim any and all liability for personal injury, property damage or loss, whether direct, indirect, or incidental, resulting from the incorrect attachment, improper use, inadequate maintenance, unapproved modification, or neglect of this product.

Der Hersteller und Verkäufer lehnen ausdrücklich jegliche Haftung für Personenschäden, Sachschäden oder Verluste ab, egal ob direkt, indirekt oder zufällig, die durch falsche Anbringung, unsachgemäßen Gebrauch, unzureichende Wartung, nicht genehmigte Änderungen oder Vernachlässigung dieses Produkts entstehen.

El fabricante y vendedor renuncian expresamente a toda responsabilidad por lesiones personales, daños materiales o pérdidas, ya sean directos, indirectos o incidentales, derivados de la incorrecta colocación, uso inadecuado, mantenimiento insuficiente, modificación no aprobada o negligencia de este producto.

Il produttore e il venditore declinano espressamente ogni responsabilità per lesioni personali, danni materiali o perdite, dirette, indirette o incidentali, derivanti dall'errato fissaggio, uso improprio, manutenzione inadeguata, modifica non autorizzata o negligenza di questo prodotto.

Le fabricant et le vendeur déclinent expressément toute responsabilité en cas de blessures corporelles, de dommages matériels ou de pertes, qu'ils soient directs, indirects ou accessoires, résultant de la fixation incorrecte, de l'utilisation inappropriée, de l'entretien insuffisant, de la modification non approuvée ou de la négligence de ce produit.