

INSTALLATION & MAINTENANCE GUIDE

AMP® LOW VOLTAGE LANDSCAPE LIGHTING

AMP® RGBCW ParamountPro LED Flood Light

ITEM: AFL-4031-B-BZ

1-813-978-3900 • Mon-Fri 9am-6pm (EST)

! IMPORTANT SAFETY INSTRUCTIONS: READ BEFORE INSTALLATION

This luminaire is intended for installation in accordance with local codes and the National Electric Code (NEC). Failure to adhere to these codes and instructions may result in serious injury, property damage and void the warranty.

These instructions do not intend to cover all variations in installation, operation maintenance or mounting situations.

1. Make sure that the power is turned OFF before installing or servicing this luminaire.
2. **WARNING:** risk of electrical shock. Install all luminaires 10 feet (3.05M) or more from pool, spa or fountain.
3. This luminaire is intended to be used only with a power supply (transformer) rated maximum of 300 watts (25 AMPS) at 15 volts.
4. Wiring connections must be made with UL listed wire connectors that are suitable for outdoor use.
5. Position the low voltage wire and wire connector so that it is located within 6 inches (15.2 cm) from a building structure, a luminaire or fitting.
6. The main low voltage cable is intended for shallow burial - less than 6 inches (152 mm).

! IMPORTANT SAFETY INSTRUCTIONS**INSTRUCTIONS PERTAINING TO A RISK OF FIRE, OR INJURY TO PERSONS
LIGHTED FIXTURE IS HOT!****WARNING – TO REDUCE THE RISK OF FIRE OR INJURY TO PERSONS.**

1. Turn off/unplug and allow to cool before replacing lamp.
2. Fixture gets HOT quickly! Contact switch/plug only when turning on.
3. Do not touch the hot lens, guard or enclosure.
4. Keep fixture away from materials that may burn.
5. Do not operate the luminaire fitting with a missing or damaged shield.

SAVE THESE INSTRUCTIONS

PACKAGE CONTENTS

- A. (1) Fixture Body
- B. (1) Allen Wrench

- C. (1) Frosted Lens
- D. (1) Diffused Lens

PRODUCT DIMENSIONS

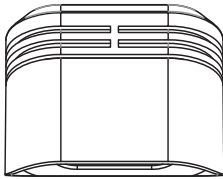
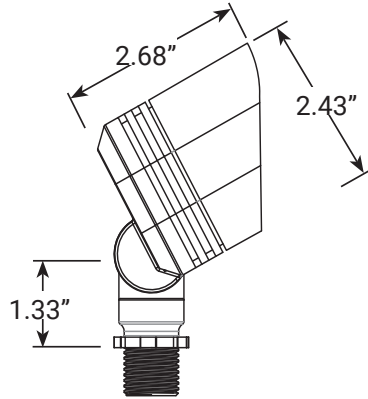
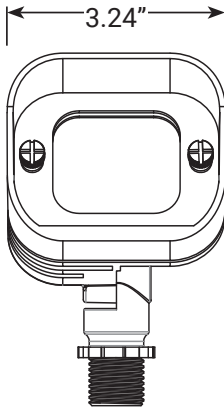

1

INSTALL STAKE

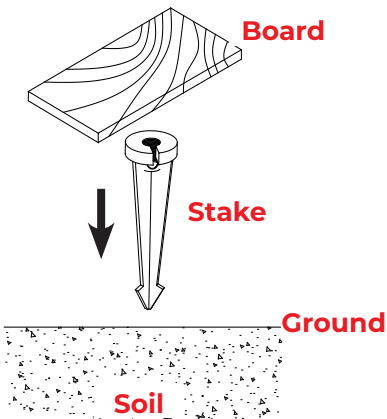

Determine the desired location for mounting the stake. Hammer the stake into the ground until flange of stake is flush to grade. To avoid damage to the stake, place a board on top of the stake while hammering.

Note: If the ground is hard and the stake is difficult to install, make a crosscut in the ground using a flat shovel.

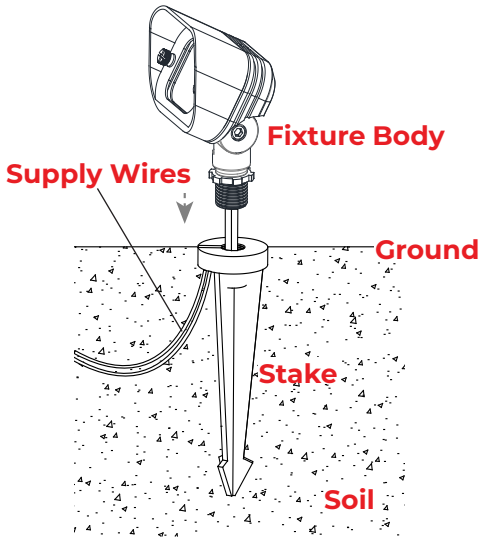
2 **INSTALL FIXTURE TO STAKE**

Pass supply wires through the center hole of the stake and thread the stem onto the stake. Hand tighten until snug. Clear away an area in the ground and lay supply wires into wireway slots.

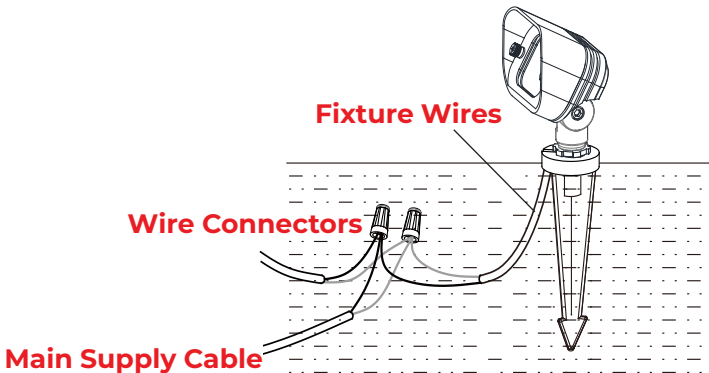
3 **WIRE CONNECTION**

Strip two leads from fixture wires. Using two UL listed wire connectors (not provided), connect leads from fixture wires to main supply cable leads.

4 ADJUST DIRECTION

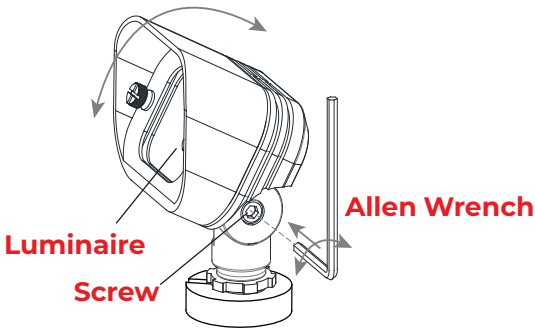

By using the Allen wrench, unlock the screw at the joint to adjust the luminaire directions. Tighten the screw when the desired direction is achieved.

HOW TO REPLACE LENS

There are three lenses provided with the product. A clear lens has been installed on the product as a default lens, which can be replaced with a frosted lens or diffused lens by using the following steps.



Frosted Lens

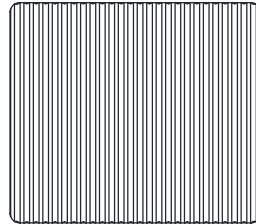

Diffused Lens

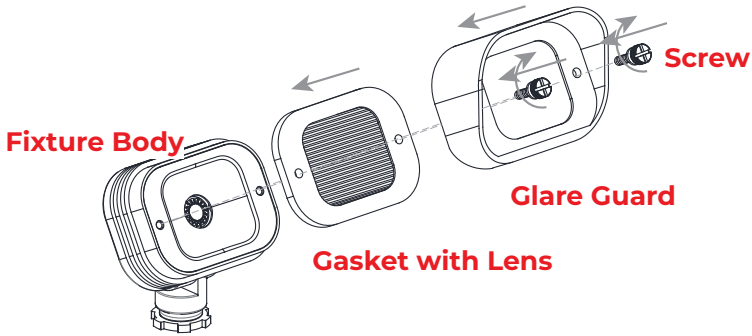
5 REMOVE GLARE GUARD AND GASKET WITH LENS

Unlock the screws to remove the glare guard and gasket with lens from the fixture body.

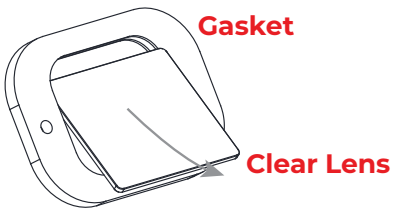
6 REMOVE CLEAR LENS

Remove the clear lens out of the gasket.

7 INSTALL FROSTED OR DIFFUSED LENS

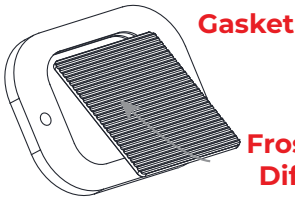

Insert the desired frosted lens or diffused lens into the gasket.

8 INSTALL FROSTED OR DIFFUSED LENS

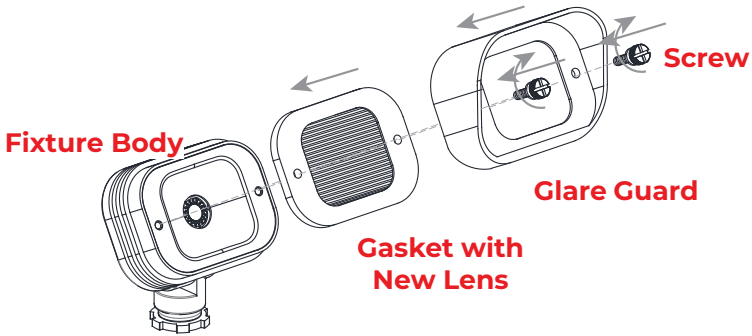

Place the gasket with new lens, the glare guard back onto the fixture body and secure with previously removed screws. Hand tighten until snug.

REMOTE CONTROL INSTRUCTIONS

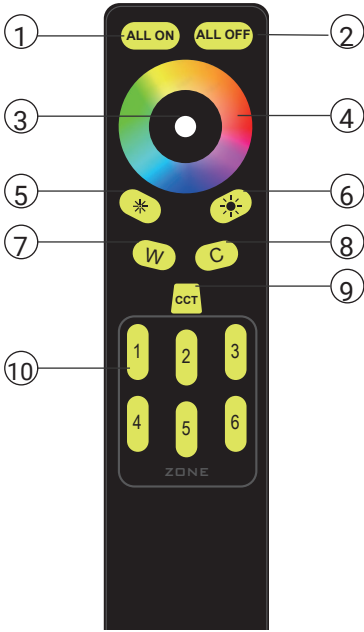

No.	Button Name	Function Description
1	ALL ON	Turns on all lights which are controlled by this remote that are within range.
2	ALL OFF	Turns off all lights which are controlled by this remote that are within range.
3	Indicator	Illuminates red when any button is pressed to indicate signal transmission.
4		RGB color wheel. Touch the desired color to change the light fixture within the selected zone and within range to that color.
5,6		Decrease or increase the light fixture brightness on the selected zone and within range by pressing the corresponding button.

No.	Button Name	Function Description
7	W	Adjusts the light to a warmer color temperature (CCT). Short press for increments, long press for continuous adjustment.
8	C	Adjusts the light to a cooler color temperature (CCT). Short press for increments, long press for continuous adjustment.
9	CCT	Color temperature (CCT) selector. Toggles through 2200K-2700K-3000K-4000K CCT when pressing
10	ZONE 1,2,3,4,5,6	Short press to select desired zone. Long press to turn zone on or off.

1 INSTALL AAA BATTERIES



Open the battery cover, install two AAA 1.5V batteries into the battery compartment. Pay attention to the “+”/“-” polarities of the battery when installing. Always reinstall the battery cover after installing AAA 1.5V batteries.

2 PAIRING THE REMOTE

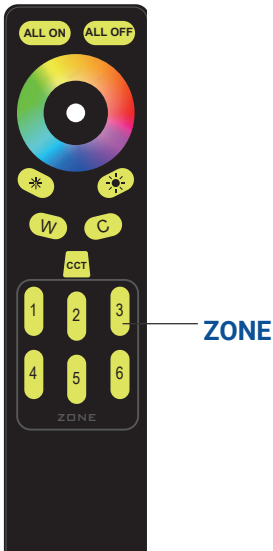

All products default to a factory setting. The lights must be paired by the remote controller before using them.

1. Install light(s).
2. Power the light(s) on. The light(s) will blink between warm and cool light for 30 seconds indicating pairing mode.
3. While the light(s) are in pairing mode, press the desired zone number on the remote once to pair the light fixture(s) with that zone. Cool white light (4000K) will flash three times indicating that the fixture is paired successfully with the zone. The light(s) will turn to warm white light (2200K).

2 PAIRING THE REMOTE (CONTINUED)

1. Using the same process you can pair additional fixtures to the same or different zones.

Note:



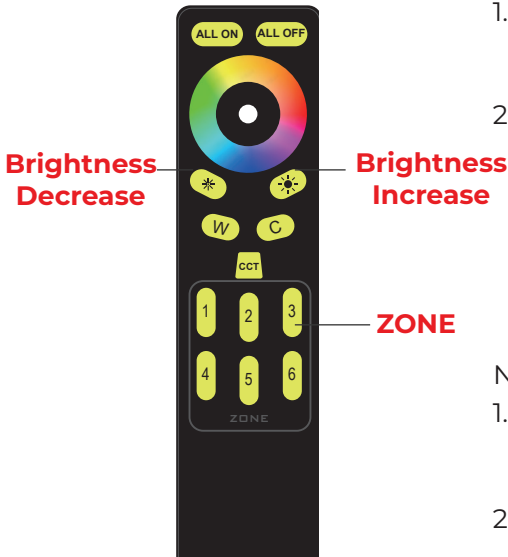

1. Please ensure light(s) are within range of the remote controller.
2. If zone pairing fails, power the light(s) OFF and ON, then repeat the above steps.
3. If pairing operation is not completed within 30 seconds, the lights will return to their default static cool white CCT (4000K). Once in this state, whenever the light(s) are powered OFF and back ON, the light(s) will re-initiate pairing mode for 30 seconds. This process will continue until pairing is successful.
4. The RF bulb(s) or fixture(s) can be paired with a maximum of 4 remote controllers. Power the light(s) OFF and ON and within 30 seconds the bulbs and fixtures can be paired with another remote controller by pressing the desired zone number. The fixture will flash cool white light (4000K) once after successful pairing. The bulb(s) or fixture(s) can be controlled by any of the paired remote controllers.
5. If more than four remote controllers are paired to the lights successfully, the first remote controller will be unpaired automatically. Only the last four remote controllers are functional.

3 ADJUST BRIGHTNESS



1. Select the desired lights by pressing the zone to which they have been assigned.
2. Press the brightness increase button to increase the light brightness, or press the brightness decrease button to decrease the light brightness.

Note:

1. Press the  or  button once and the brightness will adjust one level.
2. Long press the  or  button, and the brightness will gradually increase or decrease until the button is released.

4 ADJUST COLOR TEMPERATURE



1. Select the lights by pressing the zone they are in.
2. Press the warm light button or cool light button to the desired color temperature.

Note:

1. Press the warm light button or cool light button once, the color temperature will adjust to the next level.
2. Long press the warm light button or cool light button, the color temperature will gradually increase or decrease until the button is released.

5 QUICK COLOR TEMPERATURE ADJUSTMENT

The preset color temperatures of the CCT button are 2200K, 27000K, 3000K and 4000K.

1. Select the lights by pressing the zone they are in.
2. Press the CCT button to adjust the lights through 2200K-2700K-3000K-4000K color temperatures.

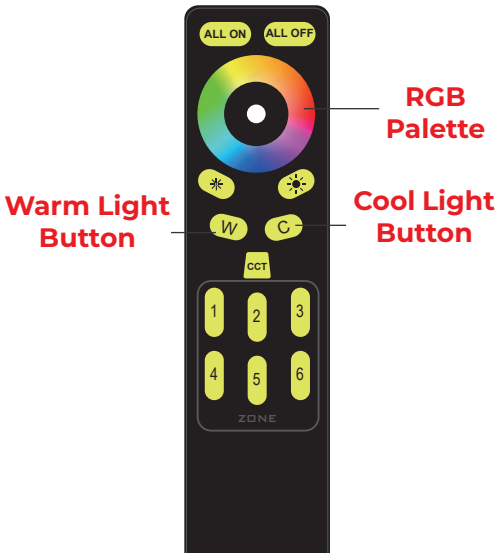
6 ADJUST COLOR

Use the RGB Palette wheel to select colored light modes and "W", "C", or "CCT" buttons to select white light modes.

1. For white light, press the warm light button or cool light button to adjust the white light color temperature.
2. For color light, touch the RGB palette wheel to adjust the light color.

7 CONTROL BY GROUP

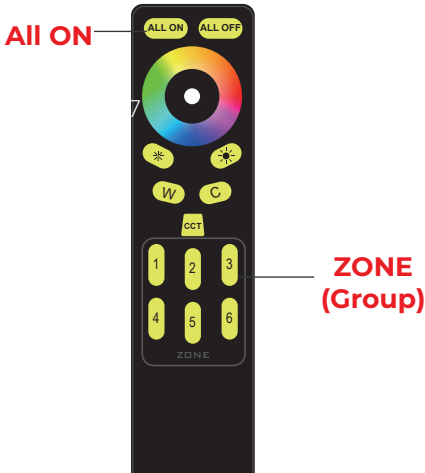

- To control lights by group,** Select the lights by pressing the zone they are in. And then press respective function buttons to adjust the lights.

8 UNPAIR LIGHTS



If you need to re-pair the light(s) that have already been paired to a different zone, they must be unpaired first.

- To unpair lights by group,** turn off the light(s) that are required to be unpaired and then turn back on. Select the light(s) by pressing the zone they are in. Press the corresponding zone button 6 times.
- To unpair all lights,** turn off all lights and then turn on all lights. Press the all “ON” button

6 times.

- After pressing six times, the corresponding lights will flash three times and then turn off, indicating that unpairing is complete. Now the lights will be restored to the factory settings.

Note:

- When the lights are ready for unpairing, you must only press zone button 1 to 6 in the zone area or “ON” button. Otherwise, unpairing will fail.
- If unpairing fails, the process needs to be re-initiated.



1-813-978-3700 • Mon-Fri 9am-6pm (EST)

Specifications and product details subject to change without notice.
© Copyright 2024, AMP® Lighting, Lutz FL USA 33549 • All rights reserved.
customersupport@amplighting.com • amplighting.com