

# TVÄTTAD

GB



Design and Quality  
IKEA of Sweden



**ENGLISH**

**3**

### Installation

**⚠ Warning!** Read the safety booklet and refer to assembly instruction. The manufacturer does not accept any responsibility for damage or injury through failure to comply with the safety precaution.

- Make sure that all transit bolts are removed.
- Make sure that hoses and cable are correctly connected.
- At the end of installation you can connect the mains plug to the mains socket. Connect the appliance to an earthed

socket. The rating plate and the 'Technical Data' chapter indicate the necessary electrical ratings. Make sure that they are compatible with the mains power supply. Check that your domestic electrical installation can take the maximum load required, also taking into account any other appliances in use. For any electrical work required to install this appliance, contact our Authorised Service Centre. The manufacturer does not accept any responsibility for damage or injury through failure to comply with the above safety precaution.

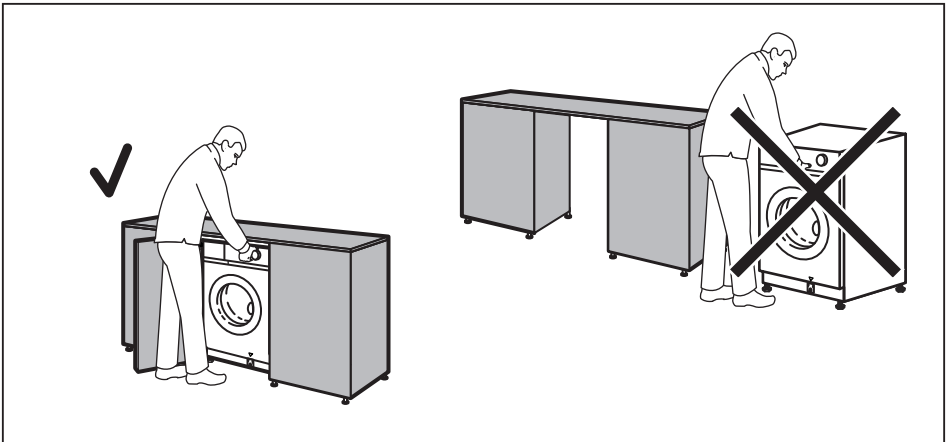

**⚠ Warning!** Do not install the appliance as free standing.

### Technical Data

Dimension	Width/ Height/ Total depth	59.6 cm /81.9 cm /55.3 cm
Electrical connection	Voltage Overall power Fuse Frequency	230-240 V 2000 W 13 A 50 Hz

Level of protection against ingress of solid particles and moisture ensured by the protective cover, except where the low voltage equipment has no protection against moisture		IPX4
Water supply <sup>1)</sup>		Cold water
Water supply pressure <sup>2)</sup>	Minimum Maximum	0.5 bar (0.05 MPa) 10 bar (1.0 MPa)
Maximum wash load	Cotton	8.0 kg
Maximum dry load	Cotton Synthetics	4 kg 3 kg
Spin Speed	Maximum spin speed	1551 rpm

1) Connect the water inlet hose to a water tap with a 3/4" thread.

2) The appliance works correctly if the water pressure is not lower than 0.05 MPa (0.5 bar). If you cannot connect the water inlet hose to the cold water tap of the primary hydraulic system, connect it to your domestic cold water storage system. Make sure not to exceed a distance of 5.02 m (16.5 ft) between the appliance inlet hose and the bottom of the water storage tank.

**Electrical connection**

At the end of installation you can connect the mains plug to the mains socket.

The rating plate and the 'Technical Data' chapter indicate the necessary electrical ratings. Make sure that they are compatible with the mains power supply.

Check that your domestic electrical installation can take the maximum load required, also taking into account any other appliances in use.

The power supply cable must be easily accessible after installing the appliance.

For any electrical work required to install this appliance, contact our Authorised Service Centre.

The manufacturer does not accept any responsibility for damage or injury through failure to comply with the above safety precaution.

**Connect the appliance to an earthed socket.**

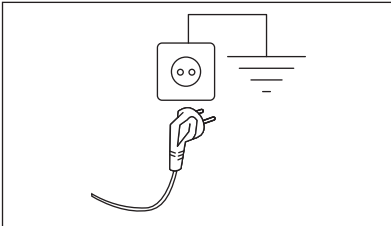

# Appliance overview

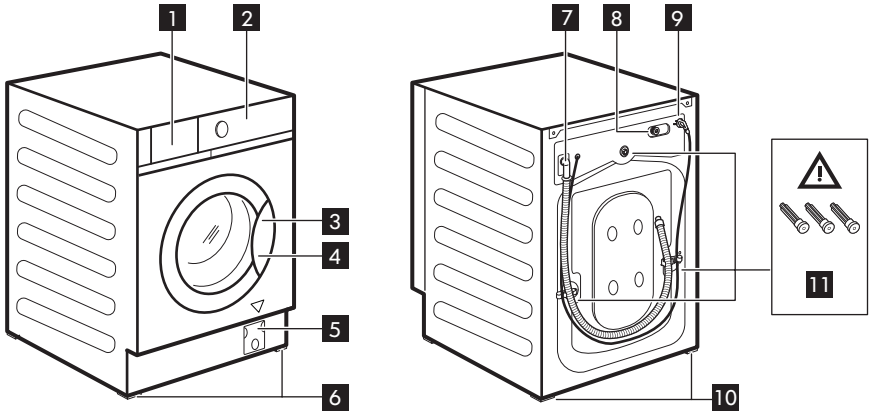

- 1** Detergent dispenser drawer
- 2** Control panel
- 3** Door handle
- 4** Rating plate
- 5** Drain pump filter
- 6** Front feet for levelling the appliance
- 7** Drain hose
- 8** Inlet hose connection
- 9** Mains cable
- 10** Back feet for levelling the appliance

**11** Transit bolts

### Rating plate position **4**

The data in the following drawing are indicative only. Please check the rating plate of your appliance.

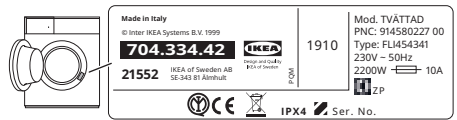

# Inspection check list

**⚠ Warning!** Refer to Safety chapters.

Please follow the inspection check list before using your appliance.

Topics	If the answer is YES <input checked="" type="checkbox"/> , no action is needed	If the answer is NO, please
All transit bolts are removed.	<input type="checkbox"/>	Refer to assembly instruction.

Topics	If the answer is YES <input checked="" type="checkbox"/> , no action is needed	If the answer is NO, please
The appliance is built in the furniture following the assembly instructions. It is NOT positioned free-standing.	<input type="checkbox"/>	Install it in the furniture as required. Refer to assembly instruction.
Open and close the detergent dispenser drawer: no collision with furniture.	<input type="checkbox"/>	Refer to 'Filling the detergent and additives' section.
Drain hose correctly connected to the drainage.	<input type="checkbox"/>	Refer to hoses connection description in the assembly instruction.
No water leakage around the hose connections.	<input type="checkbox"/>	Refer to water connection warning in the assembly instruction.
The appliance is connected to an earthed socket.	<input type="checkbox"/>	Refer to 'Electrical connection' section.
The appliance is stable and levelled properly.	<input type="checkbox"/>	Refer to 'Installation' section.
Hoses and mains cable are not kinked.	<input type="checkbox"/>	Refer to 'Electrical connection' and 'Water connection' section.
There is no carpet under the appliance.	<input type="checkbox"/>	Remove the carpet.

**i** Please write down the product model name, article number and serial number here below that you find in the rating plate and attach your receipt to this page.

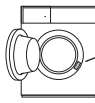
Model (Mod.): ..... Article number (Art.No.): ..... Serial number (Ser.No.): .....	 <div style="border: 1px solid black; padding: 5px; margin: 10px auto; width: 80%;"> <p>Made in Italy © Inner IKEA Systems B.V. 10390</p> <p><b>704.334.42</b> </p> <p>21552 <small>IEA of Sweden AB SE-340 91 Älmhult</small></p> </div> <p>Art. No.      Mod.</p> <p>1910</p> <p>Mod. TVÄTTAD PNC: 914580227 00 Type: FL1454341 230V ~ 50Hz 2200W  10A  IPX4  2P</p> <p>Ser. No.</p> <p>Ser. No.</p>
--	---

Control panel description

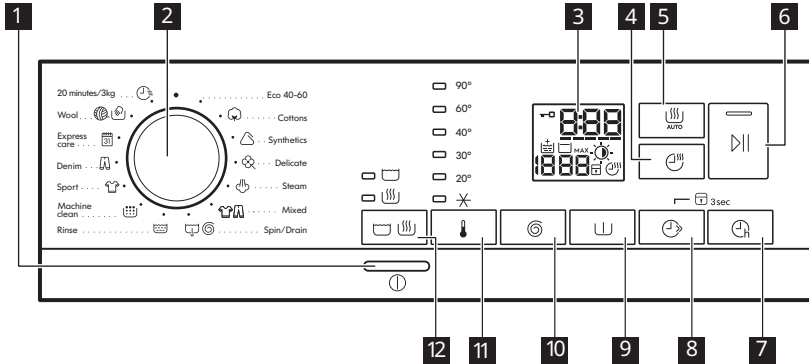

**i** The options/functions are not available with all washing programmes and an option/function can exclude another one, in these case the appliance doesn't allow an incompatible setting.

**1 On/Off button** **i**

Press this button for a few seconds to activate or deactivate the appliance. Two different tunes sound while switching the appliance on or off.

**2 Programme knob**

Turn the selector knob to select the desired programme.

**Eco 40-60 (Wash only mode):** Maximum load 8.0 kg. White cotton and fast-coloured cotton. Normally soiled items.

**For EU**

According to Commission Regulation EU 2019/2023. This programme at default temperature and spin speed, in washing only mode, with rated capacity 8.0 kg is able to clean normally soiled cotton laundry declared to be washable at 40 °C or 60 °C, together in the same cycle.



For the reached temperature in the laundry, the programme duration and other data, please refer to 'Consumption Values' chapter. The most efficient programmes in terms of energy consumption are generally those that perform at lower temperatures and longer duration.

**For Non EU**

According to UK Ecodesign for Energy-Related Products and Energy Information Regulations, this programme at default temperature and spin speed, in washing only mode, with rated capacity 8.0 kg is able to clean normally soiled cotton laundry declared to be washable at 40 °C or 60 °C, together in the same cycle.

 For the reached temperature in the laundry, the programme duration and other data, please refer to 'Consumption Values' chapter.

The most efficient programmes in terms of energy consumption are generally those that perform at lower temperatures and longer duration.

**Eco 40-60 + Cupboard dry level (Wash & Dry mode):** Maximum load 4 kg. White cotton and fast-coloured cotton. Normally soiled items.

#### For EU

According to Commission Regulation EU 2019/2023. This programme at default temperature and spin speed, in washing and drying mode, with rated capacity 4 kg and with Cupboard dry level performs the wash and dry cycle able to clean normally soiled cotton laundry declared to be washable at 40 °C or 60 °C, together in the same cycle and, after drying phase, the laundry can be immediately stored in a cupboard.

#### For Non EU

According to UK Ecodesign for Energy-Related Products and Energy Information Regulations, this programme at default temperature and spin speed, in washing and drying mode, with rated capacity 4 kg and with Cupboard dry level performs the wash and dry cycle able to clean normally soiled cotton laundry declared to be washable at 40 °C or 60 °C, together in the same cycle and, after drying phase, the laundry can be immediately stored in a cupboard.

**Eco 40-60 + Cupboard dry level (Dry only mode):** Maximum load 4 kg. White cotton and fast-coloured cotton.

 **Cottons:** Maximum load 8.0 kg. White cotton and coloured cotton.

 **Synthetics:** Maximum load 3.0 kg. Synthetic items or mixed fabric items.

 **Delicate:** Maximum load 2.0 kg. Delicate fabrics such as acrylics, viscose, polyester items.

 **Steam:** Maximum load 1.0 kg. Cotton and synthetic items. This programme reduces creases, odours and relaxes the fibres. Do not use any detergent!

 **Mixed :** Maximum load 3.0 kg. Synthetic fabrics like polyester, polyamide and their blends.

 **Spin/Drain:** Maximum load 8.0 kg. To spin the laundry and to drain the water in the drum. All fabrics, except woollens and delicate fabrics. If you set the No Spin option, the appliance performs draining only.

 **Rinse:** Maximum load 8.0 kg. All fabrics, except woollens and very delicate fabrics. Programme for rinsing and spinning.

 **Machine clean:** Empty drum. Maintenance cycle for drum cleaning. Pour a cup of chlorine bleach or a washing machine cleaner in the washing phase compartment. After the drum cleaning, run a further rinse cycle with empty drum and no detergent to remove any residue of bleach.

 **Sport:** Maximum load 3.0 kg. Sportswear.

 **Denim:** Maximum load 3.0 kg. Denim clothing.











 **Express care:** Maximum load 3.0 kg. Synthetic items or mixed fabric items.

 **Wool:** Maximum load 1.5 kg. Machine washable wool, hand washable wool and other fabrics with «hand washing» care symbol.







 **20 minutes/3kg:** Maximum load 3.0 kg. Cotton and synthetic items lightly soiled or worn only once.



**3 Display**

-  Door locked indicator:
  - Indicator on: the door cannot be opened. The appliance is working or has stopped with water left in the tub.
  - Indicator off: the door can be opened. The programme is finished or the water has been emptied out.
-  The digital indicator can show: reset position (— — —); programme duration (e. g.  washing and/or drying cycle); delay time (e. g. ); cycle end (); warning code (e.g. ); error indicator (— — —).
-  FlexTime indicator.
-  Extra Rinse indicator.
-  Spin speed indicator.
  - - - No Spin indicator. Spin phase is off.
-  Rinse Hold indicator.
- **MAX** After the AutoAdjust System detection, it flashes when the laundry

load exceeds the maximum declared load of the selected programme. Refer to "The AutoAdjust System load detection" paragraph.

-  Auto Dry indicator:  Iron dry,  Cupboard dry,  Extra dry.
-  Child safety lock indicator.
-  Time Dry and Non-Stop programme indicator.

**4  Time Dry touch button**

Touch this button to set the time that suits the fabrics you have to dry (refer to "Timed drying" table). The display shows the set value.

Each time you touch this button the time value increases by 5 minutes.

 You cannot set all time values for different types of fabrics.

Recommended time drying

Dryness Level	Type of fabric	Load (kg)	Spin speed (rpm)	Suggested duration (mins)
<b>Extra Dry</b> For towelling materials	<b>Cottons and Linen</b> (bathrobes, bath towels, etc)	4	1600	170 - 190
		2	1600	110 - 120
		1	1600	65 - 75
	<b>Denim garments</b>	3	1200	165 - 175
		1	1200	75 - 85
<b>Cupboard Dry</b> For items to be stored	<b>Cottons and Linen</b> (bathrobes, bath towels, etc)	4	1600	160 - 180
		2	1600	100 - 110
		1	1600	55 - 65



Dryness Level	Type of fabric	Load (kg)	Spin speed (rpm)	Suggested duration (mins)
	<b>Synthetics and mixed fabrics</b> (jumpers, blouses, underwear, household and bed linen)	3	1200	135 - 150
		1	1200	45 - 55
	<b>Delicates</b> (acrylics, viscose and delicate mixed fabrics)	2	1200	155 - 165
		1	1200	95 - 105
	<b>Wool</b> (woollen jumpers)	1	1200	80 - 100
	<b>Denim garments</b>	3	1200	155 - 165
		1	1200	65 - 75
<b>Iron Dry</b> Suitable for ironing	<b>Cottons and Linen</b> (sheets, tablecloths, shirts, etc)	4	1600	110 - 125
		2	1600	65 - 75
		1	1600	40 - 50

**5**  Auto Dry touch button

Touch this button to set one the automatic dryness levels proposed by the appliance.

On the display the relevant dryness indicator goes on:



-  **Iron dry:** laundry to be ironed.

-  **Cupboard dry:** laundry to be put in store.
-  **Extra dry:** laundry to be fully dried.

 You can not set all automatic levels for each type of fabrics.

Drying level

Dryness Level	Type of fabric	Load
 <b>Extra Dry</b> For towelling materials	<b>Cottons and Linen</b> (bathrobes, bath towels, etc)	up to 4 kg
	<b>Denim garments</b>	up to 3 kg

Dryness Level	Type of fabric	Load
 <b>Cupboard Dry</b> For items to be stored	<b>Cottons and Linen</b> (bathrobes, bath towels, etc)	up to 4 kg
	<b>Synthetics and mixed fabrics</b> (jumpers, blouses, underwear, household and bed linen)	up to 3 kg
	<b>Delicate fabrics</b> (acrylics, viscose and delicate mixed fabrics)	up to 2 kg
	<b>Wool items</b> (woollen jumpers)	up to 1 kg
	<b>Denim garments</b>	up to 3 kg
 <b>Iron Dry</b> Suitable for ironing	<b>Cottons and Linen</b> (sheets, tablecloths, shirts, etc)	up to 4 kg

**6**  **Start/Pause**

This button allows you to start or to pause the selected washing programme.

**7**  **Delay Start**

With this option you can delay the start of a program in a more convenient time.

**8**  **FlexTime**



With this option reduces the programme duration depending on the load size and the degree of soiling.

When you set a washing programme, the display shows the default duration and the dashes -----.

Tap on this button to reduce the programme duration according to the level of garments soil. The display shows the new programme duration and a number of dashes will decrease accordingly. The shortest is the cycle the smallest should be the load.

 When setting a steam programme, this button allows to chose three steam levels and the programme duration is reduced accordingly.

 3s **Permanent Child Lock option**

Hold pressed the button  for 3 seconds to set the Child Lock option  3s. This option prevents children from playing with the control panel: all controls are disabled. To deactivate this option, hold this button pressed for 3 seconds.

**9**  **Prewash**

This option adds a prewash phase to a washing program. Ideal to remove particulate soil like mud and clay.

**10**  **Spin and additional options**

When you set a programme, the appliance automatically sets the default spin speed allowed. Touch repeatedly this button to:

- **Change the spin speed.** The display shows only the spin speeds available for the set programme.
- Set the **No Spins** options . Set this option to deactivate all spin phases. The appliance performs the only draining phase of the selected washing programme. Set this option for very delicate fabrics. The rinses phase uses more water for some washing programmes
- Activate the **Rinse Hold** option. The final spin is not performed. The water of the last rinse is not drained out to prevent the fabrics from creasing. The washing programme ends with water in the drum.

The indicator is on display. The door stays locked and the drum turns regularly to reduce creasing. You must drain the water to unlock the door.

If you touch the button , the appliance performs the spinning phase and drains the water.

- The appliance empties the water out automatically after 18 hours approximately.

## Temperature

When you select a washing programme, the appliance automatically proposes a default temperature. With this option you can change the temperature.

The indicator = cold water.

## 

Thanks to this button, a cycle can perform:

- **Only washing:** indicator is on (default mode).
- **Washing and drying:** and indicators are on.
- **Only drying:** indicator is on.





## Acoustic signals







This appliance has different acoustic signals. To **activate/deactivate** some of the acoustic signals when the programme is completed, touch the and the buttons simultaneously for about 2 seconds. The display shows On or Off.



## Daily use

- **Warning!** Read the safety booklet.
- Before the very first use, pour 2 litres of water into the detergent compartment marked by . Pour 2 litres of water into the detergent compartment marked by . Pour a small quantity of detergent into the compartment marked by . Set and start a programme for cotton at the highest temperature without any laundry in the drum. This removes all possible dirt from the drum and the tub.

1. Make sure that the mains plug is connected to the mains socket.
2. Make sure that the water tap is open.
3. Load the laundry.
4. Pour the detergent and other treatments in the proper compartment of the detergent dispenser.
5. Push the button to switch the appliance on.
6. Turn the programme dial to set the desired programme. The appliance defaults to the **washing only mode** and the indicator of the button is on. If you wish to run a **washing and drying cycle**, tap on the Mode button once to activate also the drying function.



Both indicators  and  are on. The indicator  appears on the display. You can change the drying level by means of  button or the drying time by means by  button.

If you wish to run a **drying only cycle**, tap on the Mode button   twice to activate the drying function only. Only the indicator  is on. The indicator  appears on the display. You can change the drying level by means of  button or the drying time by means by  button.

7. Set the desired options by means of the corresponding touch buttons. The relevant indicator comes on.
8. To start the programme, touch the  button.
9. The appliance starts or, if you have set the  option, the countdown starts.

When programme starts, thanks to the AutoAdjust System, the appliance automatically adjusts - in 30 seconds - the programme duration to the load to achieve perfect washing results in the minimum possible time.

10. At the end of the programme, remove the laundry. If you set an option that ends with water in the tub, drain the water to unlock the drum.
11. Push the  button to switch the appliance off.
12. Close the water tap.

-  The Stand-by function may automatically deactivates the appliance to reduce the energy consumption. Press the  button to activate the appliance again.

## Hints and tips

- Sort the laundry as follows: white, coloured, synthetics, delicates and wool.
- Follow the washing instructions on the laundry care labels.
- Button up pillowcases, close zippers, hooks and poppers. Tie up belts.
- Turn multilayered fabrics, wool and items with printed illustrations inside out.
- Pre-treat tough stains. With adequate pre-treatment, stains and limited soiling can be removed; the laundry can then be washed at a lower temperature. Do not spray stain remover on garments near the appliance as it is corrosive to the plastic parts.
- Wash heavy soil stains with a special detergent.
- Be careful with curtains. Remove the hooks and put the curtains in a washing bag or pillowcase.
- Use a washing bag to wash small and/or delicate items (e.g. underwired bras, belts, tights, etc. ).
- Avoid washing garments full of long animal hair or poor quality garments releasing lots of fluff that could block the drain circuit and therefore requiring the Service assistance.
- Powder detergents for all types of fabric, excluding delicate. Prefer powder detergents containing bleach for whites and laundry sanitization. At temperature higher than 60 °C the use of powder detergent is recommended.
- Liquid detergents, preferably for low temperature wash programmes (60 °C max) for all types of fabric, or special ones for woollens only.
- The choice and quantity of detergent will depend on: type of fabric (delicates, woollens, cottons, etc), the colour of clothes, size of the load, degree of soiling, wash temperature and hardness of the water used.
- Follow the instructions that you find on packaging of the detergents or other

treatments without exceeding the indicated maximum level (**MAX**).

- Do not mix different types of detergents.
- Use less detergent if washing a small loads, the laundry is lightly soiled or there is large amounts of foam during washing.
- When using detergent tabs or pods, always put them inside the drum, not in the detergent dispenser.
- Normally soiled laundry may be washed without prewash in order to save detergent, water and time (the environment is protected too!).
- Loading the appliance to the maximum capacity indicated for each programmes helps to reduce energy and water consumption.
- To use the correct quantity of detergent, refer to the quantity suggested by the

detergent producer and check the water hardness of you domestic system.

- When you dry the laundry, obey the indications on the labels of the manufacturers.
- The drying time can change depending on speed of the last spin, dryness level, type of laundry, weight of the load.
- If, at the end of the drying programme, the laundry is still damp, set a short drying cycle again.
- To avoid creasing and shrinkage do not over dry the laundry. Refer to the «Drying programmes» table to find the average drying times.

## Alarm Codes and Possible failures

The appliance does not start or it stops during operation. First try to find a solution to the problem (refer to the tables).

 **Warning!** Deactivate the appliance before carrying out any check.

**With some problems, the display shows an alarm code and the  button may flash continuously:**

Problem	Possible solution
<p><b>E 10</b> The appliance does not fill with water properly.</p>	<ul style="list-style-type: none"> <li>• Make sure that the water tap is open.</li> <li>• Make sure that the pressure of the water supply is not too low. For this information, contact your local water authority.</li> <li>• Make sure that the water tap is not clogged.</li> <li>• Make sure that the inlet hose has no kinks, damages or bends.</li> <li>• Make sure that the connection of the water inlet hose is correct.</li> <li>• Make sure that the filter of the inlet hose and the filter of the valve are not clogged. Refer to 'Care and cleaning'.</li> </ul>

<p><b>E20</b> The appliance does not drain the water.</p>	<ul style="list-style-type: none"> <li>• Make sure that the sink spigot is not clogged.</li> <li>• Make sure that the drain hose has no kinks or bends.</li> <li>• Make sure that the drain filter is not clogged. Clean the filter, if necessary. Refer to "Care and cleaning".</li> <li>• Make sure that the connection of the drain hose is correct.</li> <li>• Set the drain programme if you set a programme without drain phase.</li> <li>• Set the drain programme if you set an option which ends with water in the tub.</li> </ul>
<p><b>E40</b> The appliance door is open or not closed correctly.</p>	<ul style="list-style-type: none"> <li>• Make sure that the door is properly closed.</li> </ul>
<p><b>E91</b> Internal fail. No communication between electronic elements of the appliance.</p>	<ul style="list-style-type: none"> <li>• The programme was not finished properly or the appliance stopped too early. Switch the appliance off and on again.</li> <li>• If the alarm code appears again, contact the Authorised Service Centre.</li> </ul>
<p><b>E40</b> The mains supply is unstable.</p>	<ul style="list-style-type: none"> <li>• Wait until mains supply is stable.</li> </ul>

We recommend the use of original spare parts. After the check, switch on the appliance and press the button  to restart the programme.

If the problem remains, contact your Authorised Service Centre. The necessary

data for the service centre is on the rating plate. Refer to 'Inspection check list' chapter.

In case of failures not linked to a warning code, please refer to the complete version of the user manual available in the web

## Consumption values

### Introduction



See the web link [www.theenergylabel.eu](http://www.theenergylabel.eu) for detailed information about Energy Label.

**For EU**

- i** The QR code on the energy label supplied with the appliance provides a web link to the information related to the performance of the appliance in the EU EPREL database. Keep the energy label for reference together with the user manual and all other documents provided with this appliance.  
It is also possible to find the same information in EPREL using the link <https://eprel.ec.europa.eu> and the model name and product number that you find on the rating plate of the appliance. Refer to 'Product description' chapter for the position of the rating plate.

**For Non EU**

- i** The QR code on the energy label supplied with the appliance provides a web link to the product information sheet. Keep the energy label for reference together with the user manual and all other documents provided with this appliance.

**Legend**

<b>kg</b>	Laundry load.	<b>hh:mm</b>	Programme duration.
<b>kWh</b>	Energy consumption.	<b>°C</b>	Temperature in the laundry.
<b>Litres</b>	Water consumption.	<b>rpm</b>	Spin speed.
<b>%</b>	Remaining moisture at the end of the cycle. The higher is the spin speed, the higher is the noise and the lower is the remaining moisture at the end of washing cycle.		

- i** Values and programme duration may differ depending on different conditions (e.g. room temperature, water temperature and pressure, load size and type of laundry, supply voltage) and also if you change the default setting of a programme.



**For Non EU - According to UK  
Ecodesign for Energy-Related  
Products and Energy Information  
Regulations / For EU - According to  
Commission Regulation Eu 2019/2023**

Washing only

<b>Eco 40-60 programme</b>	<b>kg</b>	<b>kWh</b>	<b>Litres</b>	<b>hh:mm</b>	<b>%</b>	<b>°C</b>	<b>rpm<sup>1)</sup></b>
Full load	8.0	1.085	60.0	03:30	50.00	46.0	1551
Half load	4.0	0.675	45.0	02:40	50.00	40.0	1551
Quarter load	2.0	0.375	35.0	02:40	54.00	33.0	1551

1) Maximum spin speed.

Wash and dry cycle

<b>Eco 40-60 programme and Cup-board dry level</b>	<b>kg</b>	<b>kWh</b>	<b>Litres</b>	<b>hh:mm</b>	<b>%</b>	<b>°C</b>	<b>rpm<sup>1)</sup></b>
Full load	4	3.215	68.0	06:15	0.00	41.0	1551
Half load	2	1.825	48.0	04:35	0.00	37.0	1551

1) Maximum spin speed.

Power consumption in different modes

<b>Off (W)</b>	<b>Stand-by (W)</b>	<b>Delay start (W)</b>
0.48	0.48	4.00
Time to Off/Standby mode is 15 minutes maximum.		

**Common programmes - Washing only**

 These values are indicative only.

<b>Programme</b>	<b>kg</b>	<b>kWh</b>	<b>Litres</b>	<b>hh:mm</b>	<b>%</b>	<b>°C</b>	<b>rpm<sup>1)</sup></b>
Cottons <sup>2)</sup> 90°C	8.0	1.750	85.0	03:45	44.00	85.0	1600
Cottons 60°C	8.0	0.750	80.0	03:30	44.00	55.0	1600
Cottons <sup>3)</sup> 20°C	8.0	0.250	80.0	02:50	44.00	20.0	1600

Programme	kg	kWh	Litres	hh:mm	%	°C	rpm <sup>1)</sup>
Synthetics 40°C	3.0	0.650	75.0	02:20	35.00	40.0	1200
Delicate <sup>4)</sup> 30°C	2.0	0.300	50.0	00:50	35.00	30.0	1200
Wool 30°C	1.5	0.250	60.0	01:05	30.00	30.0	1200

- 1) Reference indicator of the spin speed.
- 2) Suitable for washing heavily soiled textiles.
- 3) Suitable for washing lightly soiled cottons, synthetic and mixed fabrics.
- 4) It also performs as quick washing cycle for lightly soiled laundry.

**Common programmes - Wash and dry**

 These values are indicative only.

Programme	kg	kWh	Litres	hh:mm	%	°C	rpm <sup>1)</sup>
Synthetics 40°C	3.0	2.000	75.0	04:00	1.00	40.0	1200

1) Reference indicator of the spin speed.

**IKEA guarantee**

**How long is the IKEA guarantee valid?**

This guarantee is valid for **5 years** from the original date of purchase of your appliance at IKEA. The original sales receipt is required as proof of purchase. If service work is carried out under guarantee, this will not extend the guarantee period for the appliance.

**Who will execute the service?**

IKEA service provider will provide the service through its own service operations or authorized service partner network.

**What does this guarantee cover?**

The guarantee covers faults of the appliance, which have been caused by faulty construction or material faults from the date

of purchase from IKEA. This guarantee applies to domestic use only. The exceptions are specified under the headline “What is not covered under this guarantee?” Within the guarantee period, the costs to remedy the fault e.g. repairs, parts, labour and travel will be covered, provided that the appliance is accessible for repair without special expenditure. On these conditions the EU guidelines (Nr. 99/44/EG) and the respective local regulations are applicable. Replaced parts become the property of IKEA.

**What will IKEA do to correct the problem?**

IKEA appointed service provider will examine the product and decide, at its sole discretion, if it is covered under this guarantee. If considered covered, IKEA service provider or

its authorized service partner through its own service operations, will then, at its sole discretion, either repair the defective product or replace it with the same or a comparable product.

### **What is not covered under this guarantee?**

- Normal wear and tear.
- Deliberate or negligent damage, damage caused by failure to observe operating instructions, incorrect installation or by connection to the wrong voltage, damage caused by chemical or electro-chemical reaction, rust, corrosion or water damage including but not limited to damage caused by excessive lime in the water supply, damage caused by abnormal environmental conditions.
- Consumable parts including batteries and lamps.
- Non-functional and decorative parts which do not affect normal use of the appliance, including any scratches and possible color differences.
- Accidental damage caused by foreign objects or substances and cleaning or unblocking of filters, drainage systems or soap drawers.
- Damage to the following parts: ceramic glass, accessories, crockery and cutlery baskets, feed and drainage pipes, seals, lamps and lamp covers, screens, knobs, casings and parts of casings. Unless such damages can be proved to have been caused by production faults.
- Cases where no fault could be found during a technician's visit.
- Repairs not carried out by our appointed service providers and/or an authorized service contractual partner or where non-original parts have been used.
- Repairs caused by installation which is faulty or not according to specification.
- The use of the appliance in a non-domestic environment i.e. professional use.
- Transportation damages. If a customer transports the product to their home or other address, IKEA is not liable for any

damage that may occur during transport. However, if IKEA delivers the product to the customer's delivery address, then damage to the product that occurs during this delivery will be covered by this guarantee.

- Cost for carrying out the initial installation of the IKEA appliance. However, if an IKEA service provider or its authorized service partner repairs or replaces the appliance under the terms of this guarantee, the service provider or its authorized service partner will re-install the repaired appliance or install the replacement, if necessary.

This restriction does not apply to fault-free work carried out by a qualified specialist using our original parts in order to adapt the appliance to the technical safety specifications of another EU country.

### **How country law applies**

The IKEA guarantee gives you specific legal rights, which covers or exceeds local demands. However these conditions do not limit in any way consumer rights described in the local legislation.

### **Area of validity**

For appliances which are purchased in one EU country and taken to another EU country, the services will be provided in the framework of the guarantee conditions normal in the new country. An obligation to carry out services in the framework of the guarantee exists only if the appliance complies and is installed in accordance with:

- the technical specifications of the country in which the guarantee claim is made;
- the Assembly Instructions and User Manual Safety Information;

### **The dedicated After Sales Service for IKEA appliances:**

Please do not hesitate to contact IKEA After Sales Service to:

1. make a service request under this guarantee;
2. ask for clarification on installation of the IKEA appliance in the dedicated IKEA

kitchen furniture. The service won't provide clarifications related to:

- the overall IKEA kitchen installation;
- connections to electricity (if machine comes without plug and cable), to water and to gas since they have to be executed by an authorized service engineer.

3. ask for clarification on user manual contents and specifications of the IKEA appliance.

To ensure that we provide you with the best assistance, please read carefully the Assembly Instructions and/or the User Manual section of this booklet before contacting us.

### How to reach us if you need our service



Please refer to the last page of this manual for the full list of IKEA appointed contacts and relative national phone numbers.

- i** In order to provide you with a quicker service, we recommend that you use the specific phone numbers listed at the end of this manual. Always refer to the numbers listed in the booklet of the specific appliance you need an assistance for. Before calling us, assure that you have to hand the IKEA article number (8 digit code) and the Serial Number (8 digit code that can be found on the rating plate) for the appliance of which you need our assistance.

- i** **SAVE THE SALES RECEIPT!** It is your proof of purchase and required for the guarantee to apply. Note that the receipt reports also the IKEA article name and number (8 digit code) for each of the appliances you have purchased.

### Do you need extra help?

For any additional questions not related to After Sales of your appliances, please contact our nearest IKEA store call centre. We recommend you read the appliance documentation carefully before contacting us.







157038521-A-232022

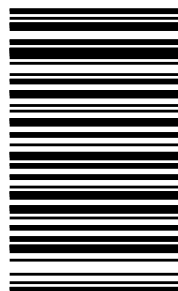

© Inter IKEA Systems B.V. 2022

21552

AA-2226987-2