

INSPIRED BY COMFORT

MORE COMFORT ON BOARD

2015



Mobile
refrigeration



Mobile
climate solutions



Mobile
energy systems



Mobile
comfort solutions



Mobile
kitchen solutions



Mobile
sanitation solutions

**THE COMPREHENSIVE RANGE OF COMFORT SYSTEMS
FOR LEISURE BOATS**

ENJOY YOUR CRUISE WITH THE COMFORTS OF HOME ON BOARD



2015



Dear Dometic Customer,

When do you start looking forward to your vacation? Is it when you set out to plan the cruise? Or when everything on board is shipshape? Why not start your preparations now, by exploring the new edition of Dometic's marine catalogue "More Comfort on Board"? The comprehensive accessory range for yachts and boats was inspired by the ideas of Dometic employees worldwide, the feedback from our customers, and the quality demands of boat builders. It is made in our own factories and sold in more than 100 countries worldwide. Let us take you on a cruise of discovery through the pages of our new catalogue. Pick what you like and make your idea of a perfectly equipped boat a reality.



DOMETIC SERVICE

THE DOMETIC GROUP
ON THE INTERNET
www.dometic.com/marine
info@dometic-waeco.com

In this catalogue we present a large segment of our product range for yachts and boats. You can find the complete product line-up on our marine website, including detailed descriptions, all of the technical data and valuable tips.



SERVICE NETWORK

Just in case you need advice, or an urgent spare part – Dometic is never far away. Our service partners are there for you in more than 100 countries around the globe, you will usually find them close to the coast.



AWARD-WINNING PRODUCTS

Dometic and WAECO products are regular winners in design prizes and best brand competitions. This is something that makes us proud. At the same time, it motivates us to keep going and improve what we have achieved so far.



COMFORT FACTORY DIRECT – OEM BY DOMETIC GROUP

Our work reveals a passion for quality and innovation – and the word is spreading. The majority of boat builders fit their products with comfort accessories by Dometic GROUP, which are made in our own factories in 20 locations worldwide.



MOBILE REFRIGERATION

6 – 35

- Portable coolers
- Refrigerators
- Cooling units



MOBILE CLIMATE SOLUTIONS

36 – 43

- Complete climate systems from Dometic
- Accessories for Marine Climate Systems
- Rooftop A/C system for heavy-duty applications



MOBILE ENERGY SYSTEMS

44 – 57

- Charger
- Battery management system / Battery care / IU0U automatic charger / Laptop charger / Smart inverter
- Charging converters / Voltage converters
- Sine wave inverter
- Inverter
- Sine wave inverter with automatic battery charger / Generator



MOBILE COMFORT SOLUTIONS

58 – 63

- Vacuum cleaners
- Cleaner Kit
- Safe



MOBILE KITCHEN SOLUTIONS

64 – 75

- Alcohol stoves / Oven
- Oven combinations
- Ovens / GasChecker / Gas cookers
- Hobs / Grill / Built-in hob / sink combinations
- Sinks with glass lid / Cooker hood / Coffee maker / Electric kettle



MOBILE SANITATION SOLUTIONS

76 – 91

- Macerator toilets
- Vacuum toilets
- Marine holding tank system
- Pressurised water pumps
- Accessories and spare parts for holding tanks
- Portable toilets
- Sanitation additives and toilet paper

New on board!



HIGHLIGHTS 2015

New digital control



NEW! WAECO CoolFreeze CDF 26

Portable cooler and freezer, 12/24 volts DC

More details p. 14



NEW! WAECO CoolFun CK 40D Hybrid

Thermoelectric/compressor cooler for 12 volts (thermoelectrics) and 230 volts (compressor)

More details p. 17



NEW! WAECO CoolMatic CD 20

Compressor drawer fridge, 12 / 24 volts DC

More details p. 31

FULL-RANGE SUPPLIER OF SANITATION SYSTEMS



NEW! Dometic sanitation system

- Three toilet technologies
- Marine holding tank system
- Installation parts, accessories and spare parts
- Pressurised water pumps

More details p. 76 – 91



HIGHLIGHTS 2015



NEW! WAECO PerfectCoffee MC 052 / 054

Coffee maker for 5 cups, 12 or 24 volts

More details p. 75



NEW! Dometic CV 1004

Central vacuum cleaning system
Efficient and hygienic thanks to a powerful motor and triple filter system

More details p. 61



NEW! Dometic Clean&Care

The right product for every cleaning task on board. Powerful, gentle and easy to use – with sparkling results.

More details p. 62

MY COOLING





MOBILE REFRIGERATION



Portable coolers

Portable compressor coolers	10 – 17
Portable thermoelectric coolers	18 – 21
Cool bags	21
Portable iceboxes	22 – 23

Refrigerators

Compressor refrigerators	24 – 30
Built-in compressor appliances	31

Cooling units

Cooling units, evaporators, cold accumulators	32 – 35
---	---------

Technical data

92 – 103

THREE COOLING SYSTEMS FOR MOBILE USE

No cooling system can handle every task. Whether you're better off with a thermoelectric, a compressor or a passive cooling unit depends entirely on how and where you intend to use mobile cooling. We start off with a detailed comparison of the individual systems and their features. This will then automatically point you to 'your' cooling technology and to 'your' cooling unit.

Shown below are the tags used for mobile cooling by Dometic and WAECO. They will allow you to immediately identify all the basic characteristics of a cooling unit.



12 V



230 V



12 V / 230 V



Solar operation



Cooling and heating



Tropical-rated

STANDARD COOLING AND FREEZING COMPRESSOR TECHNOLOGY

Compressor units operate using a refrigerant that changes from liquid to gaseous state in the evaporator. The evaporation extracts heat from the interior of the cooling unit – the temperature drops. The compressor draws in the refrigerant, compresses it and passes it on to the condenser. Here, the absorbed heat is released to the atmosphere. The refrigerant liquefies again and flows to the evaporator, where the cycle begins again.

The benefits of compressor refrigerators and freezers:

- Excellent cooling performance even at extreme ambient temperatures
- Refrigeration and deep-freezing
- Operation at 12/24 volts or 12/24 volts and 100–240 volts
- Minimal power consumption
- Ideal for solar operation
- Impeccable operation in inclined position



WAECO CoolMatic CR 50



WAECO CoolFreeze CFX 65DZ



100 – 240 V



12 / 24 V



Solar

COOLING AND HEATING THERMOELECTRICS

The thermoelectric principle was discovered by J. C. A. Peltier. The temperature generating parts of thermoelectric systems are therefore referred to as Peltier elements. Thermoelectrics are based on the fact that cold or heat energy is generated when a DC current is conducted between different types of metal. The heating or cooling capacity is further enhanced by heat exchangers and air fans. Ideal for low and medium cooling volumes.

The benefits of thermoelectric cooling units:

- Operation at 12/24 volts DC or 230 volts AC
- Can be used for cooling and keeping the contents warm
- Impeccable operation in inclined position
- Low weight, convenient to transport
- Wear-resistant and maintenance-free



WAECO TropiCool
TC 21FL



WAECO CoolFun S 28DC
(cooling mode only)



230 V



12 / 24 V



Cooling and
heating

PASSIVE COOLING WITHOUT ENERGY SUPPLY

Passive coolers work without an energy source, cooling takes place using ice cubes or pre-cooled cold packs. The efficiency of this cooling technology depends on the quality of the insulation and seals used in the cooler. The advantages of passive coolers: lightweight, easy cleaning, long service life and an attractive price.

The benefits of passive cooling:

- Works without energy supply
- Lightweight
- Easy cleaning
- Long service life
- Attractive price



WAECO Cool-Ice
WCI-22



Dometic FreshWay FW 32

WAECO COOLFREEZE CFX

THE LATEST GENERATION OF COOLERS AND FREEZERS!

Energy class A++ and freezer temperatures down to -22 °C: available for mobile use for the very first time! With its WAECO CoolFreeze CFX series, the refrigeration specialist Dometic WAECO is once again proving how milestones are made. Its specially-developed high-performance compressor and extra strong insulation have, once again, allowed the energy consumption to be reduced by up to 35% compared to its predecessors.

These hi-tech units are visually attractive with some heavy duty details: Reinforced corners, stainless-steel hinges and a robust lid lining ensure they can withstand the most demanding of loads and yet the CFX coolers are remarkably light in weight and easy to transport.

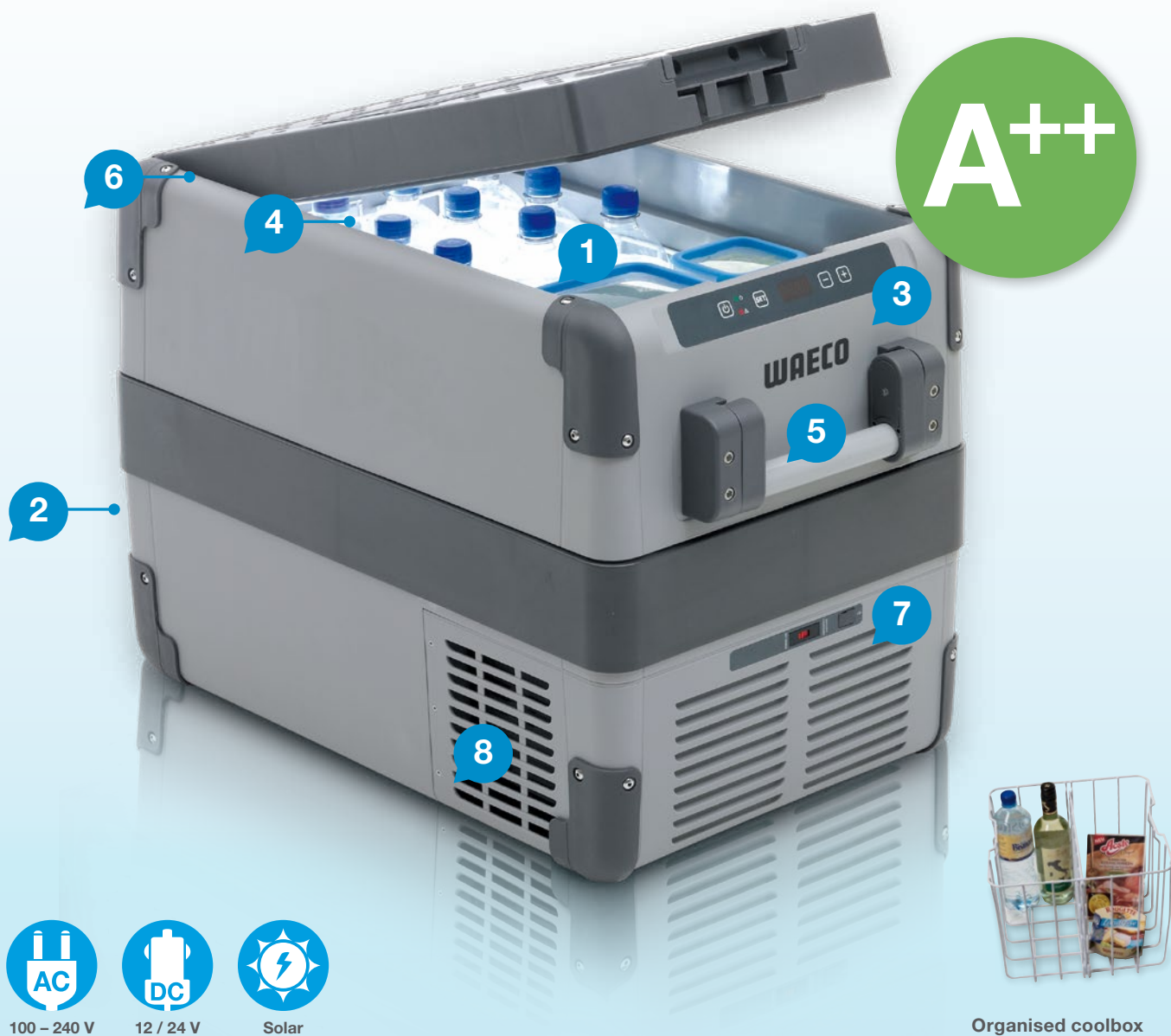

A++



Organised coolbox

The wire basket provided can even be divided using a grid divider.





Power coolers for all applications



Our tip!
Wireless display for refrigerator temperature, power source, battery protection and alarm setting
see p. 13

MY BENEFITS

- Suitable for deep freezing down to -22°C
- Excellent cooling performance even at extremely high outside temperatures
- 12/24 volts DC and 100 – 240 volts AC
- CFX special electronics with digital temperature display
- Extremely efficient and superbly quiet operation
- USB port
- Drain plugs make cleaning simple
- Suitable for solar operation
- Heavy-duty version



1
Deep-freezing down to -22°C
Cooling compartment with wire basket and separate crisper for fruit & vegetables.



5
Space-saving folding and detachable carrying handles



2
12/24 volts DC and 100 – 240 volts AC
DC cable guide: The cable fits securely and cannot come free accidentally



6
Detachable lid
Heavy-duty version with reinforced corners, stainless steel hinges and a robust closing mechanism



3
Electronic thermostat with digital temperature display



7
USB port for charging small electronic devices



4
Energy-efficient LED interior light



8
WAECO high performance compressor: sensational deep freeze performance as low as -22°C with minimal energy consumption!

GENERATION “FROSTY”: THE MOST POWERFUL COMPRESSOR COOLERS EVER

WAECO CoolFreeze CFX – uncompromising compressor coolers

The special CFX electronics



Digital temperature display, soft-start and turbo cooler function

The CFX series is equipped with special electronics which start up the compressor gently while saving energy. If the preset temperature is not reached within a short period of time, or a temperature below -12°C has been set, the turbo cooler switches on automatically to boost the compressor speed. As soon as the set temperature is reached, the CFX special electronics switch back to energy-saving mode.

- Intelligent, automatic turbo cooler
- 3-stage battery protection, set using the digital display
- 4-digit digital display (Celsius or Fahrenheit)
- Any temperature can be chosen
- Operating status and error display
- Memory function for storing set values



Up to
35%
less power
consumption!



4.30

WAECO CoolFreeze CFX 35

Cooler and freezer with CFX special electronics, 12/24 volts DC and 100–240 volts AC

- Storage volume: approx. 32 litres (including 4,5 litres crisper)
- Refrigeration from $+10^{\circ}\text{C}$ to -22°C
- Dimensions (WxHxD): 692 x 411 x 398 mm

Ref. No. 9105304047 //
UK 9105305645



4.30

WAECO CoolFreeze CFX 40

Cooler and freezer with CFX special electronics, 12/24 volts DC and 100–240 volts AC

- Storage volume: approx. 38 litres (including 7,0 litres crisper)
- Refrigeration from $+10^{\circ}\text{C}$ to -22°C
- Dimensions (WxHxD): 692 x 461 x 398 mm

Ref. No. 9105304048 //
UK 9105305646



4.30

WAECO CoolFreeze CFX 50

Cooler and freezer with CFX special electronics, 12/24 volts DC and 100–240 volts AC

- Storage volume: approx. 46 litres (including 8,5 litres crisper)
- Refrigeration from $+10^{\circ}\text{C}$ to -22°C
- Dimensions (WxHxD): 725 x 471 x 455 mm

Ref. No. 9105304049 //
UK 9105305647



4.30

WAECO CoolFreeze CFX 65

Cooler and freezer with CFX special electronics, 12/24 volts DC and 100–240 volts AC

- Storage volume: approx. 60 litres (including 13,0 litres crisper)
- Refrigeration from $+10^{\circ}\text{C}$ to -22°C
- Dimensions (WxHxD): 725 x 561 x 455 mm

Ref. No. 9105304050 //
UK 9105305648



WAECO COOLFREEZE CFX 65DZ

SIMULTANEOUS COOLING AND FREEZING

The extremely powerful WAECO CoolFreeze CFX 65DZ compressor cooler has a spacious cooling compartment and a separate 17 litre freezer compartment. Fresh foods, bottled drinks and frozen foods can therefore all be stored at optimal temperature conditions. In addition to this the CFX 65DZ offers all the advantages of the CoolFreeze CFX cooler series.



Two temperature zones
enable simultaneous
cooling and freezing



4.30

WAECO CoolFreeze CFX 65DZ

Fridge/freezer with CFX special electronics
12 / 24 volts DC and 100 – 240 volts AC

- Storage volume: approx. 53 litres (including 17 litres freezer compartment)
- Refrigeration from +10°C to –22°C
- Two temperature zones enable simultaneous cooling and freezing
- Dimensions (W x H x D): 725 x 561 x 455 mm

Ref. No. 9105304051 // UK 9105305649

WAECO WIRELESS DISPLAY

FOR ALL CFX COMPRESSOR COOLERS

This wireless display shows data such as the current temperature, power supply and alarms at up to 15 m away from the CFX cooler.



4.30

WAECO Wireless display

Wireless display for cooler temperature, power source, battery protection and alarm setting

- Visual and acoustic alarm
- Power supply from AAA batteries or 12/24 volt cigarette lighter socket

Ref. No. 9105304065



“LIGHT” COMPRESSOR TECHNOLOGY EXTREMELY COMPACT DESIGNS

These remarkably light WAECO CoolFreeze CDF coolers are as simple to use as the thermoelectric coolers. Thanks to the shoulder strap, carrier bar or handles, you can take them absolutely anywhere and storage won't ever be a problem as the super-slim design means it will fill any niche perfectly. Additional plus points really start to add up when it comes to performance: Refrigeration and deep-freezing down to -18°C with minimal power consumption, regardless of the outside temperature.



4.10

NEW! WAECO CoolFreeze CDF 26

Portable cooler and freezer, 12/24 volts DC

- Storage volume: approx. 21 litres (including 4 litres crisper)
- Refrigeration from $+10^{\circ}\text{C}$ to -18°C
- Dimensions (WxHxD): 550 x 425 x 260 mm

Ref. No. 9105303457



New digital control

MY BENEFITS CDF 26

- Super-slim body – minimal space requirements
- Refrigeration and deep-freezing
- Vertical space for 2-litre bottles
- Lift-out wire basket
- LED interior light
- Detachable lid



12 / 24 V



Solar



4.10

WAECO CoolFreeze CDF 11

Portable cooler and freezer, 12/24 volts DC

- Storage volume: approx. 10.5 litres
- Refrigeration from +10°C to –18°C
- Dimensions (WxHxD): 540 x 358 x 235 mm

Ref. No. 9105100007



4.10

WAECO CoolFreeze CDF 16

Portable cooler and freezer, 12/24 volts DC

- Storage volume: approx. 16 litres
- Refrigeration from +10°C to –18°C
- Dimensions (WxHxD): 549.5 x 366.9 x 260 mm

Ref. No. 9105303477



4.10

WAECO CoolFreeze CDF 18

Portable cooler and freezer, 12/24 volts DC

- Storage volume: approx. 18 litres
- Refrigeration from +10°C to –18°C
- Dimensions (WxHxD): 465 x 414 x 300 mm

Ref. No. 9105100002



MY BENEFITS CDF 11

- Extremely compact design
- Refrigeration and deep-freezing
- Two integrated drink holders
- Securely fastened in a vehicle using the vehicle's own seat belts
- Adjustable shoulder strap
- Special electronics with digital temperature display
- Three-stage battery monitor LED interior light



12 / 24 V



Solar

MY BENEFITS CDF 16

- Refrigeration and deep-freezing
- Detachable lid
- Vertical space for 2 x 1 litre bottles
- Special electronics with digital temperature display
- 3-stage battery protection
- LED interior light



12 / 24 V



Solar

MY BENEFITS CDF 18

- The energy efficiency box: improved insulation makes running times shorter: just 0.38 Ah/h at an inside temperature of +5°C and +20°C outside temperature
- Refrigeration and deep-freezing
- Vertical space for 2-litre bottles
- Detachable or fold-up lid
- Sturdy handle



12 / 24 V



Solar

4.10

Universal fixing kit

For fastening of WAECO CoolFreeze coolers in vehicles.
For CDF 16 and CDF 26

Ref. No. 9105303708



Our tip!

230-volt connection with low-priced mains adapter



see p. 103

KING-SIZED COOLING

COOLERS AND FREEZERS IN XXL

Still looking for a little more space? The high-capacity CoolFreeze CF 80/CF 110 coolers offer cooling capacities of 79 and 105 litres, respectively. They also perform impressively: temperatures as low as -18°C are achieved, independent of ambient temperatures and with low power consumption. The coolers transport easily with the help of the stable carrying handles and can be operated with almost any onboard or dockside power supply.

Standard equipment: interior lighting, wire basket.



MY BENEFITS

- Refrigeration and deep-freezing
- 12/24 volts DC and 100 – 240 volts AC
- CF special electronics with soft-start and turbo cooler function
- Interchangeable hinges
- Sturdy lid locks and hinges
- Interior light
- Vertical space for 2-litre bottles
- Lift-out wire basket



100 – 240 V



12 / 24 V



Solar



4.10

WAECO CoolFreeze CF 80

Cooler and freezer with special CF electronics, 12/24 volts DC and 100 – 240 volts AC

- Storage volume: approx. 79 litres (including 7 litres crisper)
- Refrigeration from $+10^{\circ}\text{C}$ to -18°C
- Dimensions (WxHxD): 790 x 455 x 500 mm

Ref. No. 9105303248



4.10

WAECO CoolFreeze CF 110

Cooler and freezer with CF special electronics, 12/24 volts DC and 100 – 240 volts AC

- Storage volume: approx. 105 litres (including 13 litres crisper)
- Refrigeration from $+10^{\circ}\text{C}$ to -18°C
- Dimensions (WxHxD): 790 x 555 x 500 mm

Ref. No. 9105303102

POWERFUL COOLING

AFLOAT AND ASHORE

Are you looking for an efficient cooler that can be used both afloat and ashore?

The WAECO CoolFun CK 40D Hybrid is just what you need. This versatile cooler incorporates a powerful compressor as well as a thermoelectric cooling unit. The latter comes in when the cooler is connected to a 12-volt battery. Cooling results up to 20°C below the ambient temperature are possible. Pre-cooled goods can be kept nice and cool even on a longer cruise. In compressor mode the hybrid box draws power from the 230-volt mains to provide cooling and deep-freezing up to -15°C.

The WAECO CoolFun CK 40D model uses the same, well proven compressor technology. It is ideal for use in a holiday home, on a patio or wherever else 230-volt mains power is available.



MY BENEFITS

- Refrigeration and deep-freezing in 230 volts (compressor)
- Variable temperature control in the compressor operation
- CK 40D Hybrid only: Normal refrigeration in 12 volts operation (Thermoelectric)
- Vertical space for 2-litre bottles
- Sturdy cabinet with recessed grips



230 V



12 V



Two
cooling
systems

4.21



4.21

WAECO CoolFun CK 40D Hybrid

Compressor/thermoelectric cooler for 230 volts (compressor) and 12 volts (thermoelectrics)

- Storage volume: approx. 38 litres
- Thermoelectrics: refrigeration up to approx. 20°C below ambient temperature
- Compressor: refrigeration +10°C to -15°C
- Dimensions (WxHxD): 520 x 454 x 515 mm

Ref. No. 9105305750

WAECO CoolFun CK 40D

Compressor cooler for 230 volts

- Storage volume: approx. 38 litres
- Refrigeration +10°C to -15°C
- Dimensions (WxHxD): 520 x 454 x 515 mm

Ref. No. 9105303388



Cooling up to
30°C
 below ambient
 temperature

MY BENEFITS

- Cooling up to 30°C below ambient temperature (TC 07 up to 25°C)
- Up to +65°C in heating mode
- 12/24/230-volt connection as standard with priority circuit for mains operation (TC 07: 12/230 volts)
- Intelligent power-save circuit
- Dynamic interior ventilation
- Wear-resistant fans
- Impeccable operation in inclined position



230 V



12 / 24 V



Cooling
 and
 heating
 mode

THERMOELECTRICS FOR CONNOISSEURS

Convenient coolers for DC/AC with TC special electronics

Versatility, performance and perfect equipment – the hallmarks of the WAECO TropiCool series. For example, the coolers feature an intelligent power-save circuit and the individually adjustable temperature is shown on an LED display. If desired, the convenient units can also take care of keeping food warm: activating the heating function supplies temperatures of up to +65°C.

12/24 V DC
 and
 230 V AC
 as standard

WAECO TROPICOOOL – HIGH-PERFORMANCE LUXURY

Perfect down to the last detail

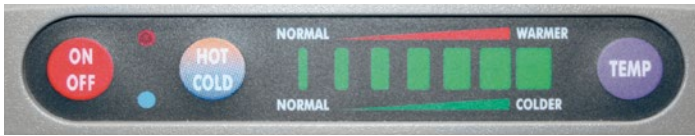

TC special electronics with soft-touch control panel*

WAECO Tropicool coolers* refrigerate down to 30°C below ambient temperature and heat up to +65°C. Using the soft-touch control panel, you can set the temperature individually – to seven different levels: from +1°C to +15°C in cooling mode or from +50°C to +65°C in heating mode. The memory function saves the most recent setting.

*All models except TC 07



4.01



4.01

WAECO Tropicool TC 07

Thermoelectric cooler for 12 volts DC and 230 volts AC

- Storage volume: approx. 7 litres
- Cooling up to 25°C below ambient temperature, heating up to +65°C
- Dimensions (WxHxD): 333 x 278 x 190 mm

Ref. No. 9105302036 // UK 9105303473

WAECO Tropicool TC 14FL

Thermoelectric cooler with TC special electronics for 12/24 volts DC and 230 volts AC

- Storage volume: approx. 14 litres
- Cooling up to 30°C below ambient temperature, heating up to +65°C
- Dimensions (WxHxD): 450 x 328 x 303 mm

Ref. No. 9105302046 // UK 9105302934



4.01



4.01

WAECO Tropicool TC 21FL

Thermoelectric cooler with TC special electronics for 12/24 volts DC and 230 volts AC

- Storage volume: approx. 20 litres
- Cooling up to 30°C below ambient temperature, heating up to +65°C
- Dimensions (WxHxD): 450 x 420 x 303 mm

Ref. No. 9105302085 // UK 9105302935

WAECO Tropicool TC 35FL

Thermoelectric cooler with TC special electronics for 12/24 volts DC and 230 volts AC

- Storage volume: approx. 33 litres
- Cooling up to 30°C below ambient temperature, heating up to +65°C
- Dimensions (WxHxD): 550 x 460 x 376 mm

Ref. No. 9105302110 // UK 9105302936

Universal fixing kit

For Tropicool TC 14FL, TC 21FL, TC 35FL:
for fastening of Tropicool coolers to vehicles

Ref. No. 9105303709



Our tip!

This practical spray cleaner is ideal for cleaning and care of portable coolers. The antibacterial bio-alcohol easily removes minor ice build-up.



see p. 62

WITH COOLING AND WARMING CAPABILITY

UNIVERSAL LEISURE COOLER

The WAECO CoolFun CX 30 offers high performance thermoelectrics, a volume of 29 litres and vertical space for 2 litre bottles and at a really attractive price. It cools up to 18°C below the ambient temperature, if and when needed, however, it can also keep lunch warm (heats up to +65°C). It proves equally versatile as regards energy selection: whether it's on board supply or mains – it accepts both. An extra compartment is integrated within the lid for storing the connection cable, the sturdy carrying handle also serves as a lid support.



MY BENEFITS

- Cooling and heating mode
- 12/230 volt connection as standard
- 29 litre capacity
- Carrier bar also functions as lid support and lid lock
- Cable compartment integrated within the lid



4.02

WAECO CoolFun CX30

Thermoelectric cooler, carrying handle as lid support or lid lock, 12 volt DC and 230 volt AC

- Capacity: approx. 29 litres
- Cooling up to 18°C below ambient temperature, heating up to + 65°C
- Dimensions (WxHxD): 396 x 444 x 296 mm

Ref. No. 9103500872

Works on
12 V DC or
230 V AC



230 V



12 V



Cooling and
heating
mode

TRENDY COOL BAGS

SHOP AND CHILL!

Transporting food from the supermarket to your boat has never been easier. The new Dometic FreshWay collection gives you a choice of four trendy soft coolers. Naturally, you can also opt for the thermoelectric WAECO CoolFun S 28, which comes in a classic marine design and can be attached directly to a shopping trolley with Velcro straps for easy filling.



4.02

WAECO CoolFun S 28DC

Thermoelectric, textile cool bag, 12 volts DC

- Storage volume: approx. 25 litres
- Refrigeration down to 15°C below ambient temperature
- Dimensions (W x H x D): 370 x 410 x 230 mm

Ref. No. 9105302763



4.14

NEW! Dometic FreshWay FW 32

Picnic cool bag with carrying straps, all-around zipper, "bottle flap" and 4 outside pockets

- Storage volume: approx. 30 litres
- Room for 2-litre bottles standing upright
- Dimensions (W x H x D): 395 x 345 x 240 mm

Ref. No. 9103540152



4.14

NEW! Dometic FreshWay FW 24

Shopping cool bag with carrying grips and zipper

- Storage volume: approx. 12 litres
- Room for 2-litre bottles standing upright
- Dimensions (W x H x D): 440 x 350 x 150 mm

Ref. No. 9103540153



4.14

NEW! Dometic FreshWay FW 13

Backpack cooler with shoulder straps, carrying handle, zipper and 3 outside pockets/compartments

- Storage volume: approx. 13 litres
- Adjustable padded shoulder straps
- Dimensions (W x H x D): 280 x 410 x 110 mm

Ref. No. 9103540154

For days
out and
walking
tours



4.14

NEW! Dometic FreshWay FW 10

Bike cooler with detachable shoulder strap, closable front pocket, multi-purpose and can size pockets, map window and rain cover

- Storage volume: approx. 9 litres
- Simply fastens to the handlebar
- Dimensions (W x H x D): 300 x 200 x 180 mm

Ref. No. 9103540155



5 year warranty

MY BENEFITS

- Extremely low heat absorption
- Highly effective polyurethane foam insulation, combined with a very efficient labyrinth seal
- Made without seams from UV-resistant plastic
- Large polyester feet for improved non-slip stability
- Practical (melt) water drain (WCI-42 to WCI-110)
- Suitable for food, and easy to clean
- Optimised volume/weight ratio

FIT FOR EVERYTHING!

ICEBOXES IN HEAVY DUTY QUALITY

High ambient temperatures, uneven terrain, rough seas, salt water, dust and mud – what can still keep cool under these conditions? The WAECO iceboxes, that's what. Equipped with extremely effective insulation and packed with cold packs or ice cubes, they keep food, fish, bait and game fresh for up to several days independent of use and weather conditions. Here's another number that speaks for itself: 5 year warranty. Finally, every detail of these boxes, which are seamlessly moulded from high-impact plastic, is designed to stand up to the toughest conditions. The food-safe iceboxes are lightweight, easy to transport and can be tied down securely on board. The melt water drain (WCI-42 to WCI-110) makes the coolers especially easy to clean.

Tips for use!

If viable, store the WAECO iceboxes in cool surroundings for several hours before use and keep them out of direct sunlight. If being filled with drinks or groceries, we recommend chilling the items beforehand. Standard freezer packs or ice cubes are suitable as coolants. Air will compromise the cooling capacity and shorten the duration of cooling. Therefore avoid opening it unnecessarily and pack the boxes as full as possible.



WCI-13 and WCI-22 with shoulder strap.



Stable, ergonomic polyethylene handles (WCI-42 or higher) making it easy to transport by one or two people.

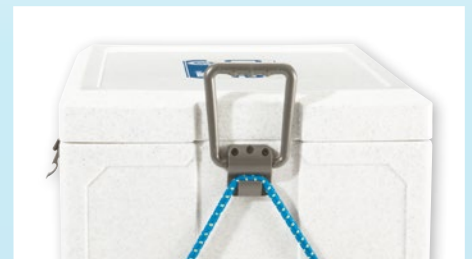

Extremely robust tethering points – integrated in the handle anchors. (WCI-42 or higher)



Full-integrated hinges with stainless steel rods for more stability and smooth contours



Sturdy ABS latches with stainless steel mounting screws. Easy, one-hand operation is possible

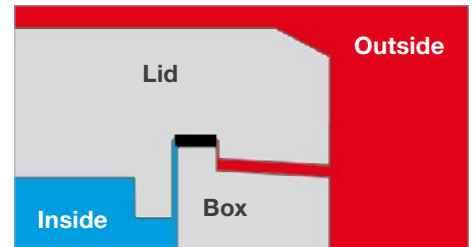

The labyrinth seal prevents any heat from making its way into the interior.

PASSIVE COOLERS WITH EXTRA-STRONG INSULATION

**Pre-cool
and pack
them!**



4.14

WAECO Cool-Ice WCI-13

- Storage volume: approx. 13 litres
- Weight: 2.8 kg
- Dimensions (W x H x D): 388 x 305 x 245 mm

Ref. No. 9108400056



4.14

WAECO Cool-Ice WCI-22

- Storage volume: approx. 22 litres
- Weight: 4.2 kg
- Dimensions (W x H x D): 388 x 313 x 365 mm

Ref. No. 9108400060



4.14

WAECO Cool-Ice WCI-42

- Storage volume: approx. 41 litres
- Weight: 7.5 kg
- Dimensions (W x H x D): 635 x 337 x 390 mm

Ref. No. 9108400062



4.14

WAECO Cool-Ice WCI-55

- Storage volume: approx. 55 litres
- Weight: 9.3 kg
- Dimensions (W x H x D): 565 x 420 x 485 mm

Ref. No. 9108400067



4.14

WAECO Cool-Ice WCI-70

- Storage volume: approx. 68 litres
- Weight: 10.4 kg
- Dimensions (W x H x D): 685 x 420 x 485 mm

Ref. No. 9108400071



4.14

WAECO Cool-Ice WCI-85

- Storage volume: approx. 86 litres
- Weight: 13.1 kg
- Dimensions (W x H x D): 835 x 435 x 495 mm

Ref. No. 9108400073



4.14

WAECO Cool-Ice WCI-85W

- Storage volume: approx. 86 litres
- Weight: 13.8 kg
- Dimensions (W x H x D): 835 x 435 x 495 mm

Ref. No. 9108400215



4.14

WAECO Cool-Ice WCI-110

- Storage volume: approx. 111 litres
- Weight: 15.7 kg
- Dimensions (W x H x D): 1050 x 440 x 510 mm

Ref. No. 9108400054

Also available with **stainless steel door**



CR 65S

WAECO CoolMatic CR 50S – CR 140S



CR 110S



CR 140S



CR 50S



CR 80S



12 / 24 V



Solar



Tropical-rated

A SPARKLING SIGHT PREMIUM REFRIGERATORS IN STAINLESS STEEL OR MATT SILVER FRONT

The exclusive CoolMatic CR refrigerators are designed for everyone who prefers to travel first class. They're simply unsurpassed with respect to performance, features, workmanship and technology and they're also a visual highlight in every galley.

That's especially true of the models with a stainless steel door!



MY BENEFITS

- Five models each with capacities from 48 to 136 litres and enhanced equipment: Bottle holder, functional storage trays (CR-110 / CR-140 with drawers)
- Ideal temperature regulation for refrigeration and deep-freezing
- Separately insulated *** freezer compartment
- Optimal temperature distribution due to additional evaporator integrated in the interior
- Unrivalled: condensation drainage via base and rear panel. Drainage via hose in bilge and holding tank system or collection tank
- Door lock with dual function (locking / ventilation)
- Reversible door hinge
- Tropical-rated in line with DIN EN ISO 7371
- High-performance cooling technology: Fully hermetic compressor

CR models

- Double door lock (top / bottom)
- Easy-to-change décor panel

CR S models

- With high grade stainless steel door (AISI 316)

A TIMELESS CLASSIC DESIGN WITH STAINLESS STEEL EFFECT FRONT



Proven standard models available in five sizes

PREMIUM DESIGN

PERFECT IN EVERY DETAIL!

CoolMatic CR refrigerators are great to look at while being very practical at the same time. The well organised interior provides a capacity of 48 to 136 litres, depending on the model. Bottle holders and both open and closed door trays keep everything perfectly in place.



1. "Ice" cool blue interior light



2. Functional cooling space



3. Tropical-rated: separately insulated
***freezer compartments



4. Patented lock: close or vent



5. Installation with standard or
flush-mount frame



6. Recessed door grips



**Neat
installation**



12 / 24 V



Solar



Tropical-rated

CoolMatic CR fronts come in either stainless steel or stainless steel effect, the choice is yours.

Installed with standard or flush mount frame, available to fit all models.



4.24

WAECO CoolMatic CR 50 / CR 50S

Compressor refrigerator, 12/24 volts DC

- Storage volume: approx. 48 litres including 5-litre freezer compartment
- Weight: 19 kg
- Dimensions (WxHxD): 380 x 534 x 500 mm

CR 50 // Ref. No. 9105303276

CR 50S // Ref. No. 9105305616



4.24

WAECO CoolMatic CR 65 / CR 65S

Compressor refrigerator, 12/24 volts DC

- Storage volume: approx. 64 litres including 7.2-litre freezer compartment
- Weight: 20 kg
- Dimensions (WxHxD): 448 x 525 x 545 mm

CR 65 // Ref. No. 9105303288

CR 65S // Ref. No. 9105305617



4.24

WAECO CoolMatic CR 80 / CR 80S

Compressor refrigerator, 12/24 volts DC

- Storage volume: approx. 80 litres including 7.9-litre freezer compartment
- Weight: 23 kg
- Dimensions (WxHxD): 475 x 640 x 528 mm

CR 80 // Ref. No. 9105303297

CR 80S // Ref. No. 9105305618



4.24

WAECO CoolMatic CR 110 / CR 110S

Compressor refrigerator, 12/24 volts DC

- Storage volume: approx. 108 litres including 10.2-litre freezer compartment
- Weight: 28 kg
- Dimensions (WxHxD): 520 x 745 x 558 mm

CR 110 // Ref. No. 9105303303

CR 110S // Ref. No. 9105305619



A+

4.24

WAECO CoolMatic CR 140 / CR 140S

Compressor refrigerator, 12/24 volts DC and 100–240 volts AC

- Storage volume: approx. 136 litres including 11.5-litre freezer compartment
- Weight: 32 kg
- Dimensions (WxHxD): 525 x 812 x 619 mm

CR 140 // Ref. No. 9105600002

CR 140S // Ref. No. 9105305620

CR 140
12/24 V DC and
100–240 V AC
as standard

PULL-OUT FRIDGE AND FREEZER

SLIDE OPEN AND ENJOY

Who doesn't enjoy sliding open a drawer fridge filled with cooled snacks and beverages?! The 50-litre drawer fridge (12/24 Volt DC) is a very easy way to keep track of supplies. Brackets hold beverage bottles securely in place and the removable ** freezer compartment provides space for other refrigerated items. Effective immediately, the fridge is available in two models: with a stainless steel front panel or in matt silver. It is easy and quick to install using installation frames (optional accessory) – either in interior spaces or on the flybridge.



MY BENEFITS

- Standard refrigeration and separately insulated **-freezer compartment
- Suitable for solar operation
- Stainless steel or stainless steel effect front
- Premium design with cool-blue interior light
- Installation frames available as accessory



12 / 24 V



Solar

Stainless steel or stainless steel effect front

4.24

WAECO CoolMatic CRD 50 / CRD 50S

Pull-out fridge and freezer, 12 / 24 volts DC

- Storage volume: approx. 50 litres, freezer compartment: approx 4 litres
- Weight: 20 kg
- Power consumption: 1.5 Ah/h at +25 °C ambient temperature
1.8 Ah/h at +32 °C ambient temperature
both at +5 °C interior temperature
- Dimensions (WxHxD): 380 x 534 x 500 mm

CRD 50 // Ref. No. 9105304081

CRD 50S // Ref. No. 9105305621



CRD 50S

SMALL, SMART AND FAVOURABLY PRICED!

With its matt-silver door panel, the CoolMatic CRP 40 makes an elegant statement in the galley of smaller boats. Inside, there is an amazingly spacious 39-litre cooling capacity, including the freezer compartment. Proven compressor technology provides excellent cooling results and matching mounting frames ensure a perfect installation result.

MY BENEFITS

- Normal refrigeration and freezer compartment
- Suitable for solar operation
- Easy-to-change decor panel
- Right-hinged door as standard
- Standard or flush-mount installation frame available as accessory



12 / 24 V



Solar



see p. 62



Our tip!

This practical spray cleaner is ideal for vertical surfaces. The antibacterial bio-alcohol easily removes minor ice build-up in refrigerators.



4.24

WAECO CoolMatic CRP 40

Premium built-in refrigerator in stainless steel finish for yachts, boats, motorhomes and caravans, 12/24 volts DC

- Approx. 39 litres including 5.3-litre freezer compartment
- Weight: 18 kg
- Dimensions (W x H x D): 380 x 356 x 545 mm

Ref. No. 9105203984



**Ideal in confined spaces:
The cooling unit can be fitted separately**



REFRIGERATORS FROM L TO XXL

FREE-STANDING OR UNDER-COUNTER MODELS

Brilliant white colour, practical interior layout, plenty of space: the CoolMatic HDC series was designed for large yachts and commercial vessels. Just like at home, these refrigerators have storage compartments on the doors, bottle holders, and fruit and vegetable compartments. In the free-standing models, the spacious freezer compartments are separated from the refrigeration area and have their own access door. The compartment is integrated in the HDC 155FF, which can be used both as a free-standing or under-counter model.

MY BENEFITS

- Deep-freezing up to -18°C
- Suitable for solar operation
- Models for under-counter installation or free-standing use
- HDC-195 / -225 / -275: large freezer compartments with separate door



12 / 24 V



Solar

4.06

WAECO CoolMatic HDC 155FF

Compressor refrigerator,
12/24 volts DC

- Storage volume: approx. 117 litres including 17-litre *** freezer compartment
- Weight: approx. 32 kg
- Dimensions (W x H x D): 600 x 820 x 550 mm

Ref. No. 9105203894



4.06

WAECO CoolMatic HDC 195

Compressor refrigerator,
12/24 volts DC

- Storage volume approx. 173 litres including 41-litre *** freezer compartment
- Weight: approx. 33 kg
- Dimensions (W x H x D): 500 x 1210 x 585 mm

Ref. No. 9105203896



4.06

WAECO CoolMatic HDC 225

Compressor refrigerator,
12/24 volts DC

- Storage volume: approx. 228 litres including 44-litre *** freezer compartment
- Weight: approx. 42 kg
- Dimensions (W x H x D): 550 x 1405 x 585 mm

Ref. No. 9105203897



4.06

WAECO CoolMatic HDC 275

Compressor refrigerator,
12/24 volts DC

- Storage volume: approx. 277 litres including 75-litre *** freezer compartment
- Weight: approx. 52 kg
- Dimensions (W x H x D): 540 x 1775 x 550 mm

Ref. No. 9105203898



Large
separate
freezer
compartments

TOP LOADER FOR GALLEYS AND BENCHES

Opens from the top. The cooling units can be detached and fitted separately.

4.12

WAECO CoolMatic CB 36 / CB 40

Built-in compressor coolers, 12 / 24 volts DC

- Storage volume: approx. 36 litres
- Detachable cooling unit (1.5 m supply cable)
- Temperature range: +10°C to –12°C
- Dimensions (W x H x D): 410 x 400 x 510 mm (incl. cooling unit)

CB 36 // Ref. No. 9105203899

- Storage volume: approx. 40 litres
- Detachable cooling unit (1.5 m supply cable)
- Temperature range: +10°C to –12°C
- Dimensions (W x H x D): 500 x 660 x 340 mm (incl. cooling unit)

CB 40 // Ref. No. 9105203900



ICE-COLD INSTALLATION!

COMPRESSOR COOLING THAT FITS ANYWHERE

Built-in drawer fridge for indoor and outdoor storage compartments.
Ideal for the flybridge. Pulls out easily, can be locked securely. Elegant front panel design.



4.10

NEW! WAECO CoolMatic CD 20

Compressor drawer fridge, 12 / 24 volts DC

- Storage volume: approx. 20 litres
- Detachable cooling unit (0.5 m supply cable)
- Temperature range: +15°C to +0°C
- Dimensions (W x H x D): 438 x 250 x 555 mm (incl. cooling unit)

CD 20 // Ref. No. 9105304843

CD 20W (white front) // Ref. No. 9105304844



4.10

WAECO CoolMatic CD 30

Compressor drawer fridge, 12 / 24 volts DC

- Storage volume: approx. 30 litres
- Detachable cooling unit (1.5 m supply cable)
- Temperature range: +12°C to –2°C
- Dimensions (W x H x D): 440 x 250 x 730 mm (incl. cooling unit)

CD 30 // Ref. No. 9105303053

CD 30W (white front) // Ref. No. 9105303054

TAILOR-MADE COOLING SOLUTIONS

KEEP EXTRA SPACE ICE-COLD

- 1 Stainless steel plate
- 2 Dynamic cooled ventilated or fin condenser
- 3 Power regulated compressor
- 4 Self sealed couplings
- 5 Dual voltage electronic
- 6 Evaporator

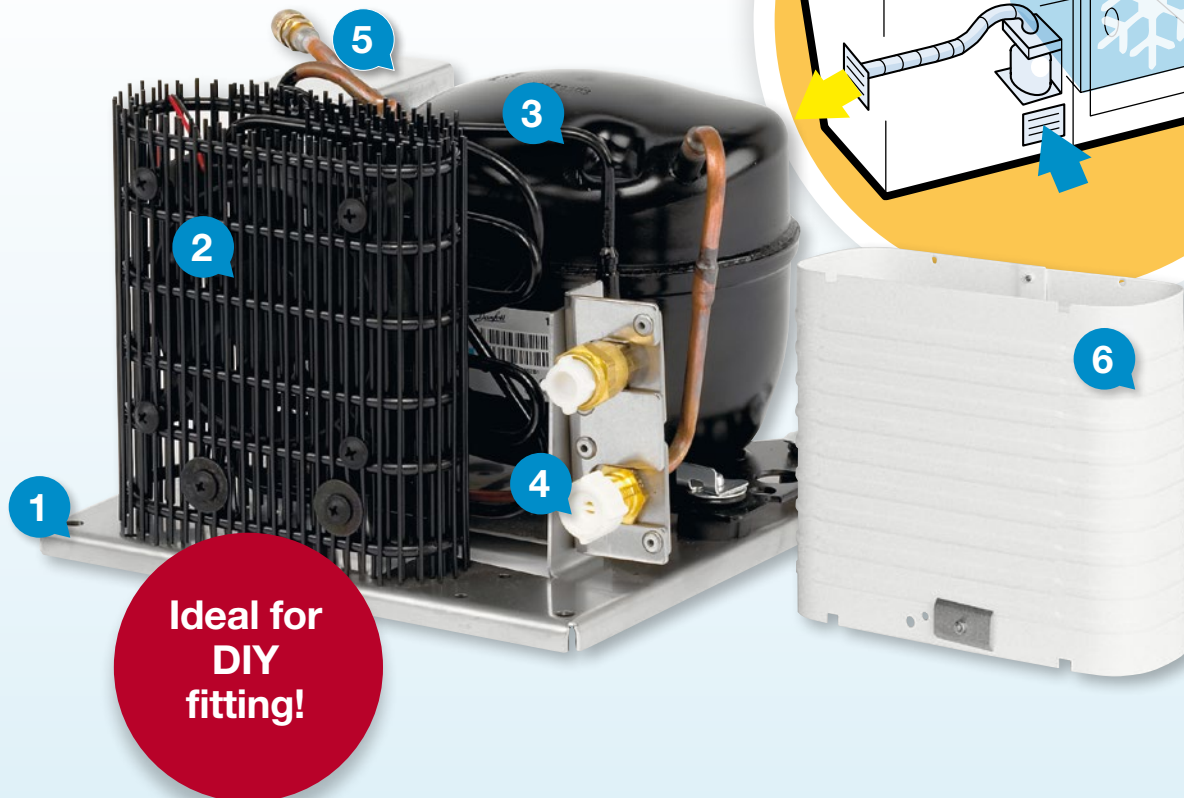

**Ideal for
DIY
fitting!**

COOLING UNITS FOR ALL KINDS OF APPLICATIONS

Where standard units don't fit, tailor-made fridge space must be provided – an easy task with WAECO ColdMachine cooling units. Supplied with pre-charged refrigerant and self-sealing valve couplings, they are ideal for do-it-yourself installation. Three different series are available to cater to all applications.

WAECO ColdMachine cooling units work with power-regulated compressors. They are powerful, economical and superbly quiet in operation, not sensitive to tilts and ready for connection to 12/24 volts DC. Each series comes with complementary evaporators specifically designed to match the performance of the compressor fitted.

COMPRESSORS WITH ADAPTIVE SPEED CONTROL

Every refrigeration system comprises a compressor, a condenser and an evaporator.

To ensure efficient operation the three key components must be perfectly coordinated. The WAECO range includes a variety of condensers and evaporators for optimal configuration.

WAECO exclusively uses the adaptive speed compressors. These compressors contribute significantly to the supreme efficiency of WAECO refrigeration systems – along with the following factors:

- The compressor speed adapts precisely to the performance requirements of the other system components (evaporator and condenser).
- Both compressor types can be supplied with plate and fin evaporators in a range of shapes and sizes. This ensures that every shape of container can be equipped correctly. It also makes optimum use of the compressor performance.
- The dynamically ventilated or fin condenser units ensure the required heat dissipation at all times.

Find complete range and technical data on pages 98 – 102



CHOOSING THE RIGHT COOLING UNIT AND MOUNTING LOCATION

- **Condenser: what are the advantages of an air-cooled condenser?**



All WAECO cooling units are air-cooled: heat is discharged to the surrounding environment by dynamically ventilated or fin condenser. The advantage over a water-cooled unit: significantly lower installation and maintenance costs with similarly efficient operation – after all, the air temperature on the ship's hull beneath the water line is barely higher than the water temperature.

- **Evaporator: Plate or fin type?**



The larger the surface area of an evaporator, the more heat it can absorb, and the greater its capacity. For small refrigerator volumes low-cost plate evaporators are ideal. Fin-type evaporators have up to five times more surface area than plate evaporators of the same size.

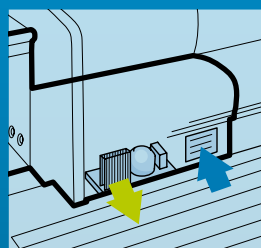

- **The ideal mounting location: Where is the air coolest on a boat?**

Clear answer: the best location is below the water line, because here, the air is already cooled by the water temperature. WAECO offers cooling units in various designs, so that even the most awkwardly shaped space can be used.

COOLING UNITS

FOR ENTRY-LEVEL AND PROFESSIONAL USE

WAECO ColdMachine Series 50

Entry-level units
at a great price

Designed for small refrigerator
capacities (up to approx. 130 litres)
and for use in cool waters

3
evaporator
options
available



- Equipped with a power-regulated compressor
- Two air-cooled units of different body shapes
- Three evaporator types each designed to precisely match the compressor performance
- Corrosion-resistant stainless steel mounting plate
- Impeccable operation in inclined position

WAECO ColdMachine Series 80

Professional units
for individual cooling comfort

Designed for small and medium
refrigerator capacities (up to
approx. 250 litres) and for use in
warmer waters.

7
evaporator
options
available



- Equipped with a power-regulated compressor
- Three air-cooled units of different body shapes
- Seven evaporator types and one cold accumulator with automatic programme controller, each designed to precisely match the compressor performance
- Corrosion-resistant stainless steel mounting plate
- Impeccable operation in inclined position

WAECO ColdMachine Series 90

Professional units
for highest demands

Designed for extra-large refrigerator
capacities (up to approx. 400 litres),
for deep-freeze cooling (up to
approx. 200 litres) and for
use in tropical waters.

3
evaporator
options
available



- Equipped with a power-regulated high-performance compressor (25% more cooling power)
- Three air-cooled units of different body shapes
- Three evaporator types and one cold accumulator with automatic programme controller, each designed to precisely match the compressor performance
- Corrosion-resistant stainless steel mounting plate
- Impeccable operation in inclined positions
- With AEO electronics (Adaptive Energy Optimiser)

Find complete range and technical data on pages 98 – 102

ATTRACTIVELY PRICED PACKAGES

COOLING UNIT + EVAPORATOR

Why bother configuring when you can have a complete package at a nice price?

Based on one of our best-selling entry-level cooling units, WAECO ColdMachine CU 55, these two package solutions are fine for smaller refrigerator capacities and for use in cold waters. Package 1 includes an L-shaped evaporator for refrigerator capacities up to 100 litres, package 2 uses an O-shaped evaporator for refrigerator capacities up to 130 litres.

Both evaporators are suitable for horizontal or vertical installation.

COOLING UNIT AND EVAPORATOR PACKAGE



4.07

4.07

Package 1

WAECO ColdMachine CU 55

Cooling unit for use in cool waters

- Connection voltage 12/24 V DC
- Fully hermetic compressor with control electronics and integrated low-voltage protection, adjustable low-voltage cut-off for consumer and starter battery, electronic reverse polarity protection, dynamically ventilated wire barrel condenser, self-sealing valve couplings
- Dimensions (W x H x D) 220 x 160 x 220 mm
- Approx. 6.5 kg
- Suitable for floor mounting, corrosion-resistant stainless steel mounting plate

WAECO L-evaporator VD-01

L-evaporator for installation in coolers up to 100 litres

- Cooling capacities of max. 80 litres with 35 mm PU isolation, or max. 100 litres with 50 mm PU isolation
- Power consumption of approx. 35 W
- For horizontal and vertical installation, self-sealing valve couplings, flexible connection line (approx. 2 m), continuously adjustable thermostat (mounted externally with blue rotary knob and LED indicator in white plastic housing), electrical supply line (approx. 3 m)

Ref. No. 9105305543

Package 2

WAECO ColdMachine CU 55

Cooling unit for use in cool waters

- Connection voltage 12/24 V DC
- Fully hermetic compressor with control electronics and integrated low-voltage protection, adjustable low-voltage cut-off for consumer and starter battery, electronic reverse polarity protection, dynamically ventilated wire barrel condenser, self-sealing valve couplings
- Dimensions (W x H x D) 220 x 160 x 220 mm
- Approx. 6.5 kg
- Suitable for floor mounting, corrosion-resistant stainless steel mounting plate

WAECO O-evaporator VD-07

O-evaporator for installation in coolers up to 130 litres

- Cool area contents of max. 100 litres with 35 mm PU isolation, or max. 130 litres with 50 mm PU isolation
- Power consumption of approx. 35 W
- For horizontal and vertical installation, self-sealing valve couplings, flexible connection line (approx. 2 m), continuously adjustable thermostat (mounted externally with blue rotary knob and LED indicator in white plastic housing), electrical supply line (approx. 3 m)

Ref. No. 9105305544

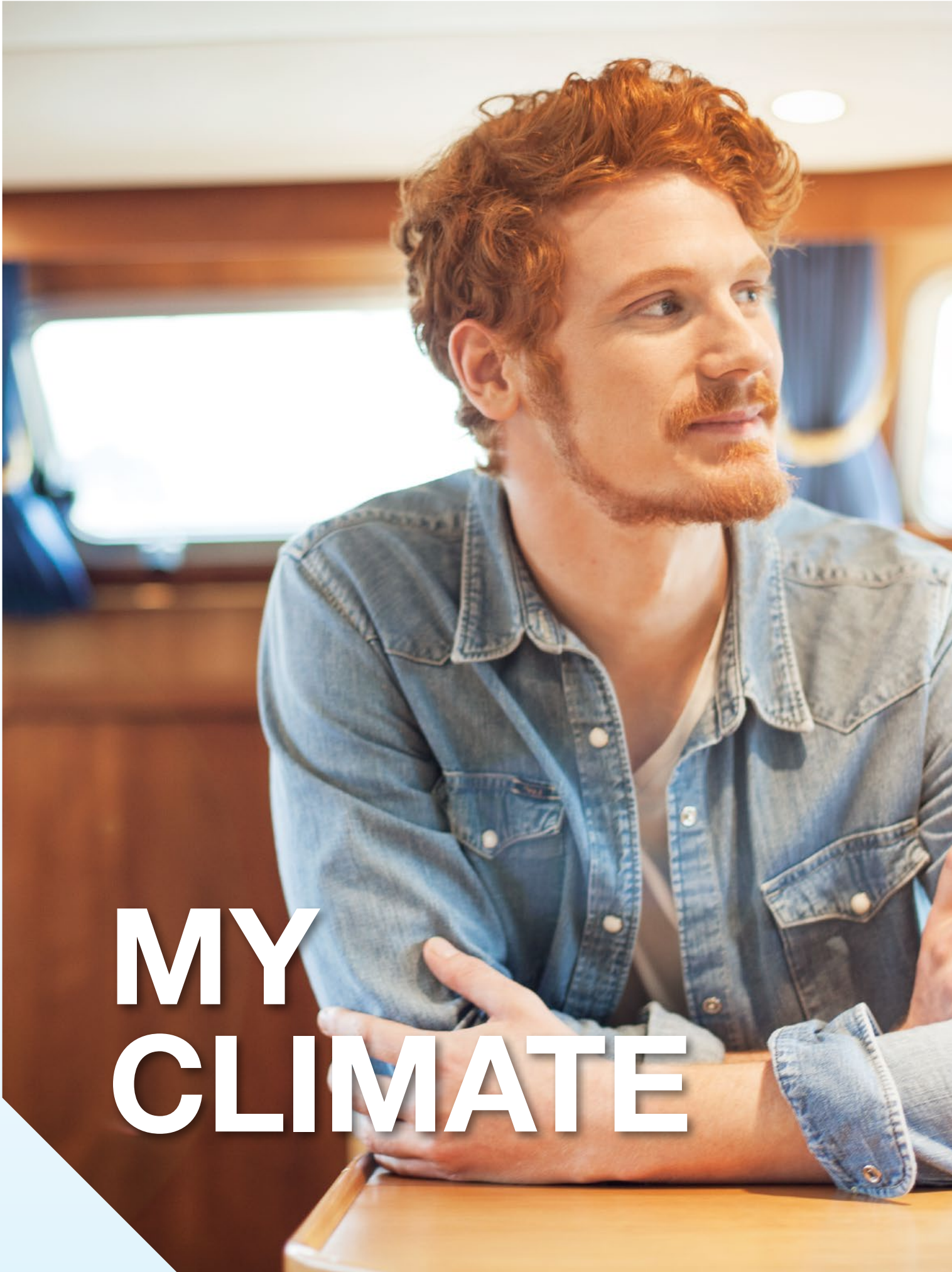

MY CLIMATE

MOBILE CLIMATE SOLUTIONS



Complete climate systems from Dometic	38 – 39
Accessories for marine climate systems	40
Air Purifier	41
Rooftop A/C system for heavy-duty applications	41
Climate systems from the market leader: Condaria, Cruisair and Marine Air	42 – 43

PLANNING AN AIR CONDITIONING SYSTEM FOR YOUR BOAT

Whether you have a small leisure boat or a super yacht with multiple cabins, Dometic can always provide a tailor-made air conditioning solution that's a perfect fit for you and your travel habits. When planning your air conditioning system there are a few things you should take into consideration. By using the QR code located below to navigate to our website. You will find detailed information about the following six important factors

1. Calculating the required system capacity
2. Number of units needed and their location(s)
3. The seawater cooling system
4. Duct and grille sizes
5. Cabin controls
6. Electrical requirements



www.dometic.com/marine/planning_guide

SELF-CONTAINED SYSTEM FOR SELF-INSTALLATION

Dometic MCS Marine Climate Systems were designed for fast and easy retrofitting. All components and mounting materials are included in the scope of delivery. Three available capacities which are using a new, modern refrigerant which enables the systems to work even more effectively and supply air-conditioned comfort to cabins of different sizes or design. To air-condition an additional cabin, purchase the optional air distribution kit (MCS 12/16 only).

Another advantage of the super-compact MCS climate systems: thanks to efficient heat pump technology, they can also be used as heating systems at water temperatures > 6°C.

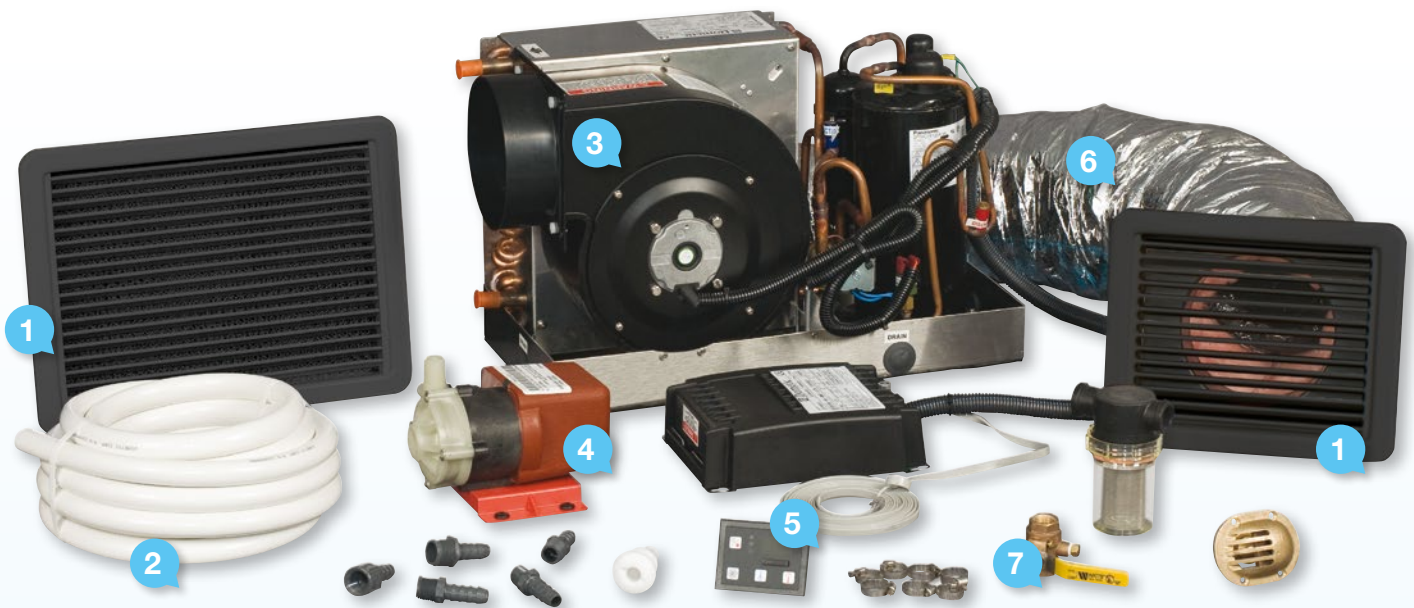

COMPLETE SYSTEMS FOR QUICK INSTALLATION

- 1 Supply-air and return-air grilles
- 2 Seawater hose
- 3 A/C unit
- 4 Seawater pump
- 5 Electrical box and control panel
- 6 Air duct
- 7 Through-hull fittings, fixing material, fittings, valves

HOW TO FIND YOUR MCS MODEL

Selecting the right MCS model for your needs depends on the size and location of the cabin you want to air condition.

A cabin below deck requires less capacity per square metre than an upper-deck cabin with large windows and direct exposure to the sun.

Maximum air-conditioned room size (at ambient temperatures of 20 – 35°C)

	Below deck (no windows)	Mid deck (small windows)	Above deck (large windows)
Dometic MCS6	8 m ²	5 m ²	4 m ²
Dometic MCS12	16 m ²	10 m ²	8 m ²
Dometic MCS16	23 m ²	15 m ²	12 m ²



MY BENEFITS

- Combines cooling, dehumidification and heating in one powerful system
- Ultra-compact, space-saving components
- Complete package with all required installation materials
- 3 models with cooling capacities of 6000, 12000 and 16000 Btu/h
- User-friendly operator panel for control of all functions
- Easy to clean, integrated air filter
- High-quality return-air and supply-air grilles
- Accessory kit for MCS 12/16: Optional add-on kit for directing the air flow into two separate cabins, see p. 40

Complete
kit for a
perfect
climate!

2.12

Dometic MCS 6 / MCS 12 / MCS 16

Complete climate system for 230-volt operation

	MCS 6	MCS 12	MCS 16
Ref. No.	9108782885	9108782884	9108782886
Cooling capacity	6000 BTU/h	12000 BTU/h	16000 BTU/h
Heating capacity	1750 watts	3500 watts	4700 watts
Consumption (at 230 V) in cooling/heating mode	621 watts / 851 watts	759 watts / 989 watts	1035 watts/1357 watts
Input voltage	230 volts AC (220 to 240 volts) / 50 Hz		
Current consumption in cooling/heating mode	2.7 A/3.7 A	3.3 A/4.3 A	4.5 A/5.8 A
Required circuit protection (harbour)	min. 6 A, max. 10 A, delay fuse up to 11 A	min. 8 A, max. 10 A, delay fuse up to 22 A	min. 11 A, max. 15 A, delay fuse up to 32 A
Number of blower speeds	6/automatic	6/automatic	6/automatic
Temperature range (preset)	18°C to 30°C	18°C to 30°C	18°C to 30°C
Thermostat temperature control	yes	yes	yes
Refrigerant	R410a	R410a	R410a
Dimensions (W x H x D) A/C unit	407 x 286 x 229 mm	508 x 337 x 245 mm	508 x 343 x 286 mm
Electronic control	165 x 222 x 67 mm	165 x 222 x 67 mm	165 x 222 x 67 mm
Weight	18 kg	26 kg	28 kg
Quality features	Complete set including seawater components, air duct and installation fittings, space-saving self-contained air conditioner, high-quality, corrosion-resistant materials		

Scope of delivery: A/C unit, electrical box and control panel, seawater pump, seawater strainer, air ducts, supply-air and return-air grilles, seawater hose, through-hull fittings, fixing material, fittings, valves

ACCESSORIES

FOR MARINE CLIMATE SYSTEMS



2.12

Real-wood ventilation grilles

For Dometic MCS climate systems

- High-quality appearance
- Louvres can be removed for cleaning
- Return-air grilles have easy-to-clean, replaceable filters
- Supply-air grilles have double-deflection, moveable louvres

Contact your local Dometic office for available wooden grill models.

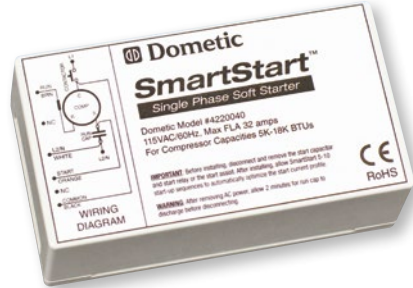

2.12

Dometic SmartStart™ soft starter

Reduces A/C compressor current draw during start-up

- Prevents voltage spikes when starting, helps prevent power outages
- Problem-free A/C start-up at moorings with a low standard of electrical circuit protection

230 V, 50/60 Hz for climate systems with 12,000– 30,000 BTU/h // Ref. No. 9108680633

230 V, 50/60 Hz for climate systems with 30,000– 60,000 BTU/h // Ref. No. 9108680637

Dometic Marine Products
Dealer Locator

More information at your local dealer.
www.dometic.com/marine/dealer_locator



DOMETIC BREATHE EASY™ AIR PURIFIER

Indoor air can be five times more polluted than outdoor air, especially on board. Not healthy for the lungs! Breathe Easy™ air purifier keeps the air you breathe clean and healthy and stops unpleasant odours.

MY BENEFITS

- Eliminates unpleasant odours
- Reduces contaminants by up to 99.9 %
- Can relieve allergy and asthma symptoms
- Special UV light produces no harmful ozone

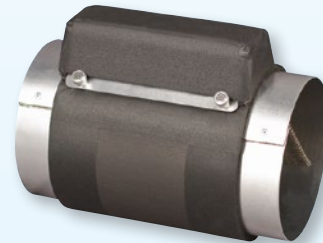

2.12

Dometic In-Duct Breathe Easy™ Air Purifier

In-duct air purifier

- Diameter: 102 mm or 152 mm
- Connection-ready for 230 volts

ø 102 mm // Ref. No. 9108682881

ø 152 mm // Ref. No. 9108681937



2.12

Centrifugal seawater pumps

Centrifugal seawater pumps to provide seawater circulation in marine A/C systems

- Magnetic-drive impeller is wear- and maintenance-free
- Efficient motor with low power consumption
- Quiet operation

PML250C, 230 V // Ref. No. 9108549752
 PML500CK, 230 V // Ref. No. 9108549753
 PMA1000C, 230 V // Ref. No. 9108549776



2.12

Air distribution kit

This additional kit for the Dometic MCS 12 and MCS 16 can be used to cool or heat two cabins simultaneously. The flexible design adapts easily to the individual installation situation.

- Low-cost two-cabin solution

Ref. No. 9108549923

Mobile climate solutions

ROOFTOP A/C SYSTEM FOR HEAVY-DUTY APPLICATIONS

An extremely robust design, low in weight and a cooling capacity of up to 12,000 BTU/h: Dometic's DuraSea Rooftop Air Conditioner is the ideal climate solution for supply vessels, patrol boats and houseboats.

The A/C unit, which is air-cooled, can be installed in a flat position on any horizontal deck or rooftop location to cool the area directly below it. Located on the underside of the unit – which is accessible from the interior cabin – are the thermostat and fan controls as well as the return-air vent and two supply-air vents that blow in opposite directions for increased cooling capability.

MY BENEFITS

- Easy installation – no ducting or plumbing required
- Corrosion-resistant components
- Vibration-free operation
- Ready for rooftop/decktop mounting



The air distribution box (sold separately) mounts on the ceiling to provide A/C controls



Compressor is bracketed at top and bottom to minimise vibration and movement

Easy to install – no ducting, no plumbing required



2.12

Dometic DuraSea

Rooftop A/C for work boats

Rooftop A/C // Ref. No. 9108792081

Required part (to complete installation)
 Air distribution kit // Ref. No. 9108556174



THREE STRONG BRANDS FROM DOMETIC

55 YEARS OF EXPERIENCE IN THE MARINE SECTOR

Dometic has supplied owners and outfitters of boats and yachts with exceptional comfort solutions for more than half a century. Our expertise in the air-conditioning and climate sectors is just as experienced. We've always responded to the challenges of this marketplace and today we can offer a programme that rises to the occasion. Custom-made climate solutions for boats with lengths from 7 to 150 metres and more: three proven brands make it all possible.

DX SYSTEMS (Self-Contained & Split)

Direct expansion (DX) systems use circulated refrigerant gas to cool or heat cabins. A self-contained system has all major components on a single chassis. A split system puts the condenser and evaporator at different locations connected by insulated copper tubing, and two air handlers can be connected to one condensing unit to cool multiple cabins or a single large area. Self-contained systems can cool one or two cabins (with additional duct work).

CHILLED WATER SYSTEMS

Installed in the engine room, the chiller circulates cold or hot water in a closed circuit to all of the rooms to be air-conditioned. Air handlers then cool or heat the individual cabins. Chiller systems are also well suited for very large boats or yachts with many cabins. There is no limit to the number of air handlers that can be integrated into the system.

AIR-COOLED APPLICATIONS

These air conditioning units are designed for exterior installation and are engineered for exceptional resistance to harsh marine environments.

Available in split and self-contained configurations, air-cooled systems require no plumbing and are ideal for replacing non-marinated systems.



CLIENT LIST

Aicon	Chinese Customs	Galeon	Monte Carlo Yachts	RMK	Sunreef
Amels	Christensen	Grady White	Monterey	Robertson and	Sunrunner
Astondoa	CNB	Grand Banks	Mustang	Caine	Sunseeker
Azimut	Cobalt	Hanse	Nautor's Swan	Sabre	Ta Shing
Baltic Yachts	Cranchi	Hatteras	Norhavn	Sanlorenzo	Tecnomar
Bavaria	CRN	Hinkley	Ocean Alexander	Salona Yachts	Thunderbird
Bayliner	Crownline	Horizon	Oyster	Sea Ray	Tiara
Beneteau	Delphia	Hunter	Palmer Johnson	Sealine	Trinity
Benetti	Donzi	Indian Navy	Pendennis	Selene	US Coast Guard
Bertram	Doral	Israeli Navy	Pershing	Sessa Marine	US Navy
Boston Whaler	Dufour	Jeanneau	Premier	Silverton	Velvette Marine
Broward	English Pilot Boats	Jefferson	President	Skipperliner	Vicem
Burger	Fairline	Johnson	Princess	South Coast	Viking
Cabo	Ferretti	Lagoon	Proteksan	Spanish Coast	Vision
Chaparral	Fipa Group	Luhrs	Regal	Guard	Wally
Cheoy Lee	Fountaine Pajot	Maritimo	Rinker	Sri Lanka - Navy	Wellcraft
Chinese Coast	Four Winns	Mexican Coast	Riva	Stamas	Westport
Guard	French Coast Guard	Guard	Riviera	Sunbeam Yachts	Windy Boats

Mobile climate solutions

Largest global marine service network

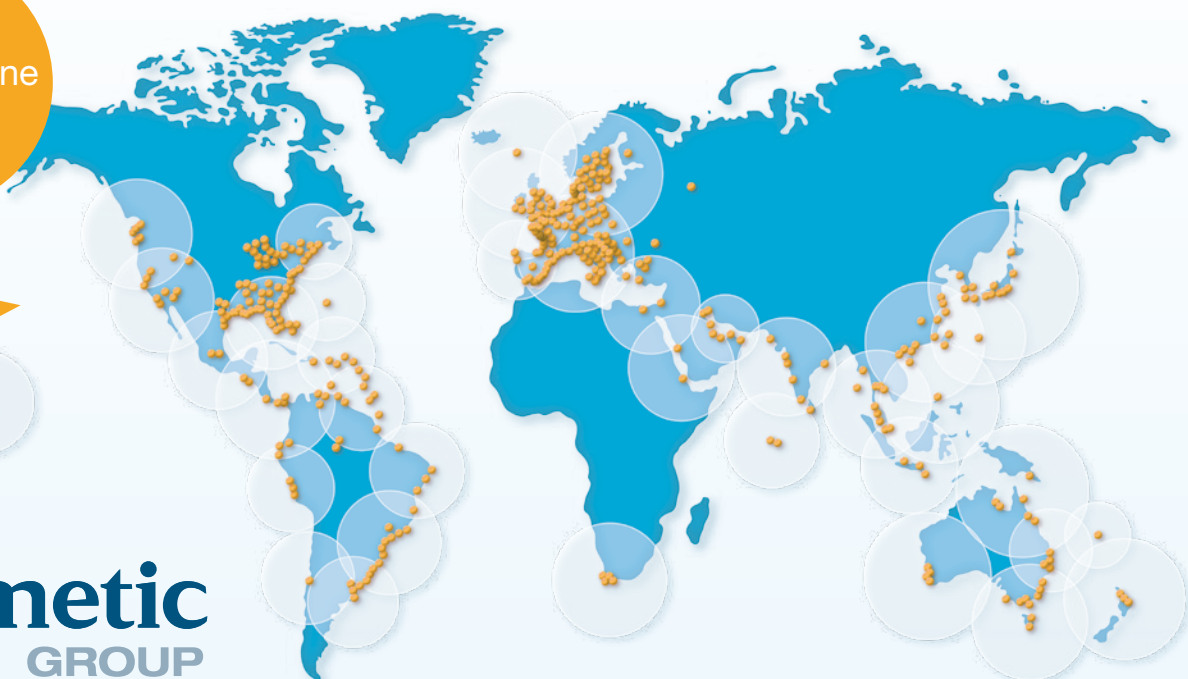

Problems with Dometic's climate systems are extremely rare because of their high level of quality. However, should you encounter a problem or require a replacement part, Dometic is never far away. We're represented in more than 100 countries on every continent and are usually found close to the coast. This ensures that our customers all around the world have fast access to the professional support they need.

The commitment to quality that stands behind the brand names Condaria, Cruisair and Marine Air has also made us the market leader in the marine climate sector. We supply our OEM partners with custom-made solutions.



Complete climate system line-up on the Internet! For comprehensive information about all of the climate system models from the brands Condaria, Cruisair and Marine Air, visit www.dometic.com/marine/climate_systems The QR code takes you directly to the website.

MY ENERGY

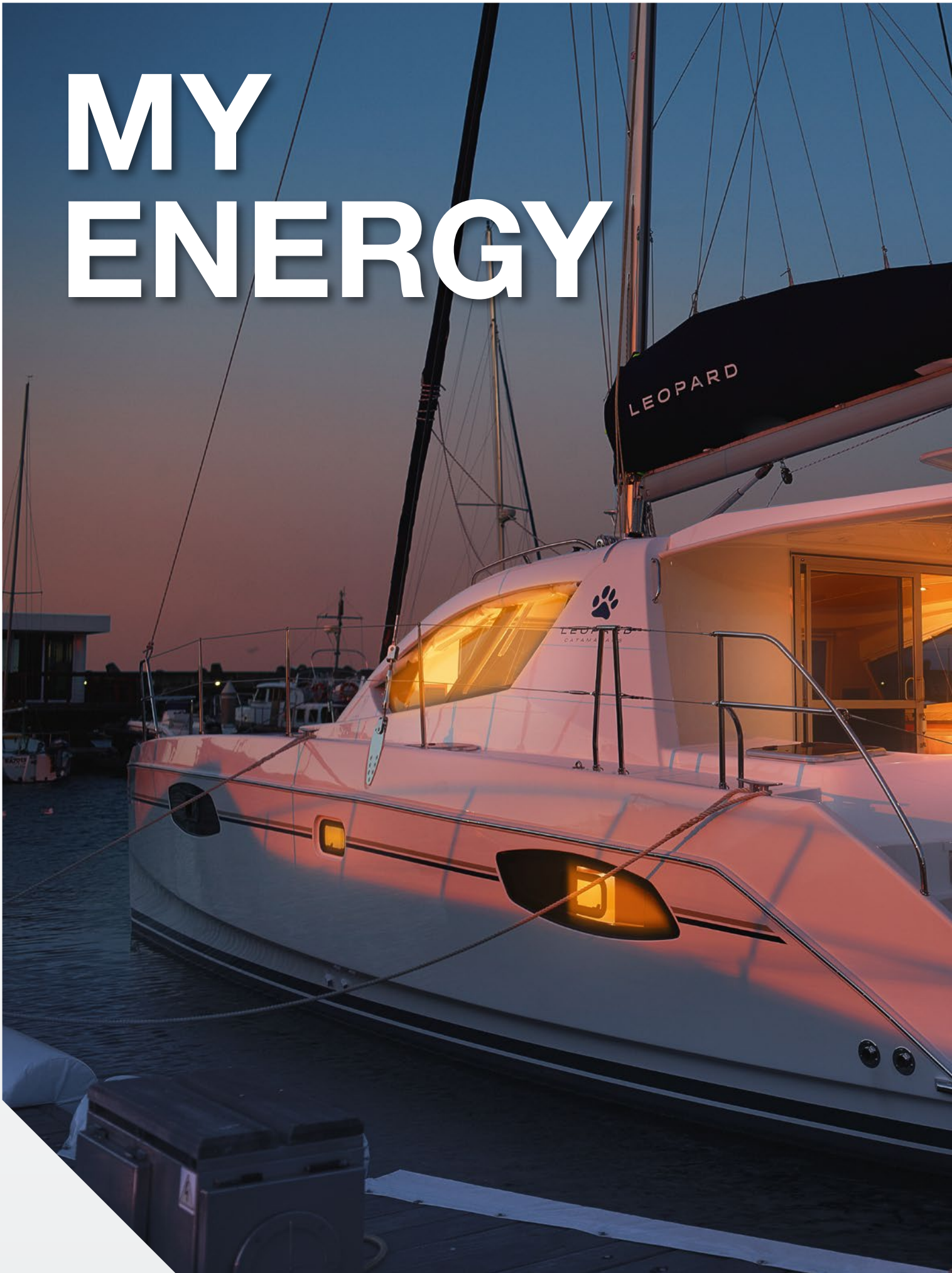

MOBILE ENERGY SYSTEMS



Chargers	46 – 47
Battery management system / Battery care	48
IU0U automatic charger /	
Laptop charger / Smart inverter	49
Charging converters / Voltage converters	50
Sine wave inverters	51 – 53
Inverters	54 – 55
Sine wave inverter with automatic battery charger / Generator	56 – 57
Technical data	104 – 109



MY BENEFITS

- Compact design, lightweight
- Series-standard bus interface
- 6-stage IU0U charging characteristics optimised for charging wet, gel and AGM batteries.
- Compatible with the battery manager Dometic MPC-01
- Sleep mode function for quiet charging with half the charge power
- Remote control, Hella battery sensor and temperature sensor available as accessory

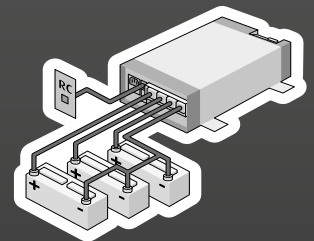

SIGNIFICANTLY SHORTER CHARGING TIMES!

WAECO PERFECTCHARGE BATTERY CHARGERS

Sophisticated charging technology at a super price

Faster full-capacity charging times – faster installation – favourable price: the PerfectCharge IU0U chargers from WAECO offer a complete line-up of compelling features. They're suitable for all lead-acid batteries and deliver especially gentle and – thanks to a 6-stage charging characteristic – especially fast charging times. A standard Bus interface also turns the chargers into genuine “networkers” that can be integrated perfectly into existing Bus systems as needed.

With their surprisingly low weight and very compact design, the devices offer problem-free installation even in restricted spaces.



Accessories available



The WAECO PerfectCharge IU0U chargers have an input voltage range of 110 – 230 volts (90 – 260 volts) and are available in performance variants ranging from 15 A to 80 A.



3.16

WAECO PerfectCharge MCA 1215

- Battery outputs: 1 plus 1 A output for starter battery
- Charging current: 15 A

12 V // Ref. No. 9102500027 // UK 9102500046



3.16

WAECO PerfectCharge MCA 1225

- Battery outputs: 2 plus 1 A output for starter battery
- Charging current: 25 A

12 V // Ref. No. 9102500028 // UK 9102500047



3.16

WAECO PerfectCharge MCA 1235

- Battery outputs: 2 plus 1 A output for starter battery
- Charging current: 35 A

12 V // Ref. No. 9102500029 // UK 9102500048



3.16

WAECO PerfectCharge MCA 1250

- Battery outputs: 3
- Charging current: 50 A

12 V // Ref. No. 9102500030 // UK 9102500049



3.16

WAECO PerfectCharge MCA 1280

- Battery outputs: 3
- Charging current: 80 A

12 V // Ref. No. 9102500031 // UK 9102500050



3.16

WAECO PerfectCharge MCA 2415

- Battery outputs: 2
- Charging current: 12.5 A

24 V // Ref. No. 9102500032 // UK 9102500051



3.16

WAECO PerfectCharge MCA 2425

- Battery outputs: 3
- Charging current: 25 A

24 V // Ref. No. 9102500033 // UK 9102500052



3.16

WAECO PerfectCharge MCA 2440

- Battery outputs: 3
- Charging current: 40 A

24 V // Ref. No. 9102500034 // UK 9102500053

Mobile energy systems



Two bus interfaces as series standard

The bus compatibility makes connecting a battery sensor or integrating them into a management system, such as the MPC 01, particularly easy.



DIP switches

Four dip switches allow the optimum charging characteristics for the battery type connected (gel, AGM or wet battery) to be configured. Switchover and float voltage can be set in accordance with the battery manufacturer's specifications.

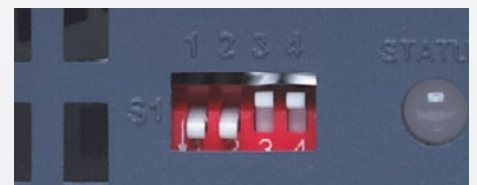

Digital interface

Interface for connecting an external functional control or an external switch, which can be used to switch the charger into sleep mode, for example.

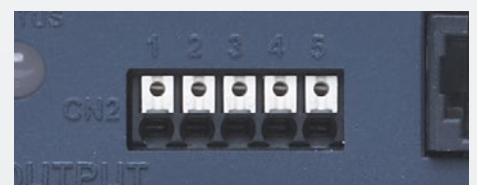

EXACT BATTERY ANALYSIS

DOMETIC MPC 01

It doesn't miss a thing: the intelligent battery sensor, which comes with the MPC 01, measures the effective current and voltage of the batteries connected. It uses these to calculate the capacities and charge status. When the battery is discharged or faulty, it triggers a warning and the command to disconnect the battery from the load circuit. It also helps WAECO PerfectCharge battery chargers unfold their full potential. The battery sensor adapts the charging voltage to the respective battery characteristics, giving a particularly fast and optimal charge.



3.16

NEW! Dometic MPC 01

Intelligent battery management system with display and a battery sensor

- Input voltage: 8 – 16 volts
- Current consumption: 150 mA in display mode, 10 mA in standby mode
- CIB interface
- Two additional battery sensors (accessory) can be connected
- Display dimensions (W x H x D):
142 x 117 x 16 mm (with turning knob)
142 x 117 x 6 mm (without turning knob)

Ref. No. 9102500073

Optional extras:

Hella Sensor MCA-HS1, 12 V

Ref. No. 9102500038

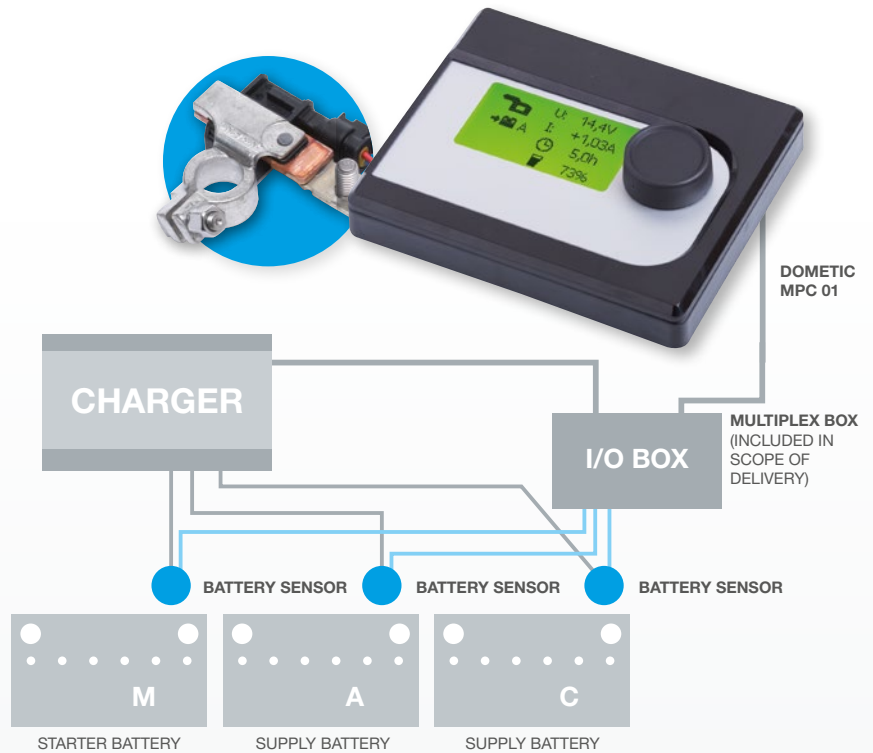

BATTERY REFRESHER & BATTERY CONDITIONER: KEEP YOUR BATTERIES IN TOP-NOTCH CONDITION!



3.28

WAECO PerfectBattery BR 12

Battery refresher, 12 volts
Extends the service life of wet, gel and AGM batteries

- Reduces sulphate deposits, the cause of premature battery ageing
- Reactivates apparently defective batteries by destroying existing sulphate crystals

Ref. No. 9103556045



3.28

WAECO PerfectBattery BC 100

Battery conditioner, 12 volts
Three functions in one unit: conditioning, charging, back-up mains adapter

- For service and maintenance of all 12-volt batteries
- Bridges long periods of standstill
- Can also be used as charger or back-up mains adapter

Ref. No. 9102500044

MATURE IU0U CHARGING TECHNOLOGY AT ENTRY LEVEL PRICES

WAECO IU0U compact charger: Fast and gentle charging for supply batteries of up to 100 Ah



Powerful performance at a low price: The proven WAECO PerfectCharge compact charger is ideal for charging supply batteries (up to 100 Ah) on smaller boats. Thanks to a large input voltage range, the charger easily compensates for fluctuations in the mains power supply while in port. Switch mode design ensures high efficiency.



3.16

WAECO PerfectCharge IU812

IU0U automatic charger, 12 volts
Optimal charging technology for 12-volt wet, gel and AGM batteries

- For charging a battery
- Input voltage: 230 volts DC
- Input voltage range: 180 – 253 volts AC/50 – 60 Hz
- Nominal battery voltage: 12 volts DC
- End-of-charging voltage: 14.4 volts DC
- Float charging voltage: 13.6 volts DC
- Max. battery capacity: 100 Ah
- Max. charging current: 8 A
- Operating temperature: 0 °C to +50 °C

Ref. No. 9103555791

FOR SMALL CONSUMER UNITS AND LAPTOPS: MINI INVERTER AND BATTERY CHARGER



3.29

WAECO PocketPower SI 102

Smart inverter for mobile use, 100 watts
Turns 12-volt battery voltage into sine-wave-like 230-volt AC

- Modified sine wave voltage
- Continuous power: 100 watts
- Peak power: 200 watts
- Mounting bracket
- Euro socket
- Weight: 282 g
- W x H x D: 67 x 43 x 125 mm

Ref. No. 9105303816

Please note! Not suitable for use in the UK.



3.29

WAECO PocketPower LC

Universal laptop charger for use in vehicles / boats

- Output power: 90 watts
- 13 adapters for more than 400 different laptops
- Automatic identification of the correct charge voltage
- USB port plus micro-USB cable for charging mobile phones simultaneously
- Patented adapter plug system
- Automatic overvoltage and low voltage protection
- Weight: 255 g
- W x H x D: 124.8 x 50 x 31.5 mm

Ref. No. 9102500022

ENERGY AVAILABLE AT ALL TIMES

IU-charging converters

Sensitive 12-volt appliances depend on a constant, stable voltage that the onboard battery cannot always supply. Simply connect a PerfectCharge IU charging converter between the power sources: it stabilises voltage and compensates for over- and undervoltage in the range from 8 – 16 volts.

By increasing the charging voltage, it also ensures complete charging of supply batteries during a cruise.

Voltage converters

If the 24-volt on-board battery powers the 12-volt navigation system and the 24-volt coffee maker works problem-free with a 12-volt supply, there's bound to be a PerfectPower voltage converter somewhere along the line. This product range satisfies the highest standards with respect to voltage stability and operating safety. Also functions as a high-quality IU charger, can be operated in parallel mode.



3.16



3.18

WAECO PerfectCharge DC 08 / DC 20 / DC 40

Charging converters and battery chargers with 8 A / 20 A / 40 A output current

- Ideal for voltage stabilisation and for charging the supply battery while cruising
- High efficiency
- Electrically isolated input and output voltage

DC 08, 8 A, 12 V » 12 V // Ref. No. 9102500055
 DC 20, 20 A, 12 V » 12 V // Ref. No. 9102500045
 DC 40, 40 A, 12 V » 12 V // Ref. No. 9102500056

WAECO PerfectPower DCDC 10 / DCDC 20 / DCDC 40

Voltage converters with 10 A / 20 A / 40 A output current

- Ideal for sensitive appliances
- Electrically isolated input and output voltage
- Can also be used as battery chargers
- To increase capacity, several converters can be used in parallel

DCDC 10, 10 A, 12 V » 24 V // Ref. No. 9102500057
 DCDC 20, 20 A, 12 V » 24 V // Ref. No. 9102500058
 DCDC 10, 10 A, 24 V » 24 V // Ref. No. 9102500061
 DCDC 20, 20 A, 24 V » 12 V // Ref. No. 9102500059
 DCDC 40, 40 A, 24 V » 12 V // Ref. No. 9102500060

MY BENEFITS

- Gives the battery a full charge while driving
- It stabilises voltage for sensitive 12-volt devices
- High energy efficiency
- Electrically isolated output voltage
- Clean output voltage
- Parallel operation possible



PURE SINE VOLTAGE AT A BUDGET PRICE

There is often just one single, and “modest” consumer unit on board which requires 230 volt AC voltage to run – a TV, for example, the DVD player or a mobile phone charger. If this is the case, we recommend the MSI 212/224, or MSI 412/424, the two most compact WAECO SinePower models. They provide 150 and 300 watts of output respectively, a USB interface and a super slimline design at an unbelievably low price!



MY BENEFITS

- Extremely slim design, lightweight
- Series-standard USB interface
- Easily accessible socket integrated in the upper housing
- Outstanding price-performance ratio
- MSI 212 / 224 with cigarette lighter socket

Mobile energy systems

Attractive price



3.30



3.30

WAECO SinePower MSI 212 / MSI 224

Sine wave inverter 150 W

- Continuous power: 150 W
- Peak power: 300 W
- Weight: 0.82 kg

12 V // Ref. No. 9102600124 // UK 9102600139

24 V // Ref. No. 9102600125 // UK 9102600140

WAECO SinePower MSI 412 / MSI 424

Sine wave inverter 350 W

- Continuous power: 350 W
- Peak power: 700 W
- Weight: 0.82 kg

12 V // Ref. No. 9102600126 // UK 9102600141

24 V // Ref. No. 9102600127 // UK 9102600142



MY BENEFITS

- Very high peak output levels make it suitable for demanding consumer units with high start-up currents
- Extremely compact design, light weight
- Quick and easy installation
- Mains priority circuit integrated or as an optional extra

Lightweight and compact

WAECO SINEPOWER SINE WAVE INVERTERS WITH VERY HIGH PEAK OUTPUT LEVELS

Optional mains priority circuit and CAN-Bus interface

SinePower sine wave inverters use 12-volt or 24-volt battery current to produce the same pure 230-volt alternating current available from a home wall socket. This ensures the problem-free mobile operation of all kinds of appliances, even highly sensitive 230-volt devices (e.g. computers, PAD coffee machines, electric toothbrushes, etc.)

The extremely high peak output levels are a special quality feature of this generation of WAECO inverters. The devices have sufficient capacity to easily accommodate high starting currents generated by connected appliances. Other advantages: simple installation, super-compact design and lightweight – the inverters are easy to install, even if there’s a shortage of space.



Remote controls as accessory



see p. 106

VERSIONS **WITHOUT** MAINS PRIORITY CIRCUIT

If you don't require a mains priority circuit you can choose from three particularly cost-efficient SinePower models. If necessary, the priority circuit, available as an accessory, is easy to retrofit.



3.30

WAECO SinePower MSI 912 / MSI 924

Sine wave inverter 900 W

- Continuous power: 900 W
- Peak power: 1600 W

MSI 912, 12 V //

Ref. No. 9102600111 // UK 9102600033

MSI 924, 24 V //

Ref. No. 9102600112 // UK 9102600034



3.30

WAECO SinePower MSI 1312 / MSI 1324

Sine wave inverter 1300 W

- Continuous power: 1300 W
- Peak power: 2400 W

MSI 1312, 12 V //

Ref. No. 9102600113 // UK 9102600035

MSI 1324, 24 V //

Ref. No. 9102600114 // UK 9102600036



3.30

WAECO SinePower MSI 1812 / MSI 1824

Sine wave inverter 1800 W

- Continuous power: 1800 W
- Peak power: 3200 W

MSI 1812, 12 V //

Ref. No. 9102600115 // UK 9102600037

MSI 1824, 24 V //

Ref. No. 9102600116 // UK 9102600038

VERSIONS **WITH** MAINS PRIORITY CIRCUIT

All versions of the SinePower with a capacity of 1800 watts or more feature a mains priority circuit with voltage synchronisation, and the 2300/3500 watt models even feature a bus interface.



3.30

WAECO SinePower MSI 1812T / MSI 1824T

Sine wave inverter 1800 W

- Continuous power: 1800 W
- Peak power: 3200 W

MSI 1812T, 12 V //

Ref. No. 9102600117 // UK 9102600039

MSI 1824T, 24 V //

Ref. No. 9102600118 // UK 9102600040



3.30

WAECO SinePower MSI 2312T / MSI 2324T

Sine wave inverter 2300 W

- Continuous power: 2300 W
- Peak power: 4000 W

MSI 2312T, 12 V //

Ref. No. 9102600119 // UK 9102600041

MSI 2324T, 24 V //

Ref. No. 9102600120 // UK 9102600042



3.30

WAECO SinePower MSI 3512T / MSI 3524T

Sine wave inverter 3500 W

- Continuous power: 3500 W
- Peak power: 6000 W

MSI 3512T, 12 V //

Ref. No. 9102600121 // UK 9102600043

MSI 3524T, 24 V //

Ref. No. 9102600122 // UK 9102600044



MY BENEFITS

- Suitable for appliances with PFC control
- Reverse pole protection by exchangeable fuses
- External on/off switch
- Individually adjustable clip-on mounts
- 12- or 24-volt cigarette lighter plug (PerfectPower PP 152 / PP 154)

MODIFIED SINE WAVE VOLTAGE! WAECO PERFECTPOWER INVERTERS

230 volts for many commonly used appliances

The economically priced inverters in the WAECO PerfectPower series offer a modified output voltage – sufficient for appliances with a wide range of input voltages (hair dryer, vacuum cleaner, microwave). Both high-performance inverters (1000/2000 watts) are equipped with a mains priority circuit and can be connected to a remote control. All PerfectPower models can be switched on/off using an external switch and have adjustable mounting feet.



Back: ON/OFF switch and outlet for an external ON/OFF switch



Front: Earthed safety socket and LEDs for function check



Mounting aid: Individually adjustable clip-on mounts



3.18

**WAECO PerfectPower
PP 152 / PP 154**

Inverter 150 W

- Continuous power: 150 W
- Peak output: 350 W
- Weight: approx. 0.84 kg
- With cigarette lighter plug

12 V // Ref. No. 9105303791 //
UK 9105303792
24 V // Ref. No. 9105303794 //
UK 9105303795



3.18

**WAECO PerfectPower
PP 402 / PP 404**

Inverter 350 W

- Continuous power: 350 W
- Peak output: 700 W
- Weight: approx. 0.99 kg

12 V // Ref. No. 9105303796 //
UK 9105303797
24 V // Ref. No. 9105303799 //
UK 9105303800



3.18

**WAECO PerfectPower
PP 602 / PP 604**

Inverter 550 W

- Continuous power: 550 W
- Peak output: 1100 W
- Weight: approx. 1.4 kg

12 V // Ref. No. 9105303801 //
UK 9105303802
24 V // Ref. No. 9105303804 //
UK 9105303805



3.18

**WAECO PerfectPower
PP 1002 / PP 1004**

High-performance inverter 1000 W

- Continuous power: 1000 W
- Peak output: 2000 W
- Weight: approx. 3.5 kg

12 V // Ref. No. 9102600002 //
UK 9102600003
24 V // Ref. No. 9102600028 //
UK 9102600004



3.18

**WAECO PerfectPower
PP 2002 / PP 2004**

High-performance inverter 2000 W

- Continuous power: 2000 W
- Peak output: 4000 W
- Weight: approx. 5 kg

12 V // Ref. No. 9102600027 //
UK 9102600005
24 V // Ref. No. 9102600029 //
UK 9102600006

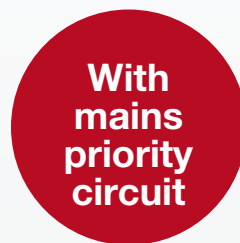

Remote control as accessory



see p. 108

CombiPower features:

- 1 Battery + connection
- 2 Battery – connection
- 3 Outputs for temperature sensor CAN bus, RS232, remote control
- 4 DIP switches for configuration
- 5 Separate starter battery connection +5 A
- 6 ON/OFF switch
- 7 Outputs for 230 volts
- 8 Cable fixing bar
- 9 GND connection



WAECO COMBIPOWER – SINE WAVE INVERTER AND AUTOMATIC CHARGER IN ONE

Limited shore-side power supply? Everything on board can still run smoothly because CombiPower monitors the mains input and responds to each situation accordingly. Therefore it supports the limited power capacity of an external energy source through battery power. If the external sources fail completely, the inverter automatically provides power to the attached appliances. If the mains input is adequate, the battery is charged with consideration given to the settings of the current limiter and the actual 230-volt power consumption.

3.30

WAECO CombiPower 2012 / 2024

Sine wave inverter with integrated automatic charger, 12 or 24 volts/2000 watts. Boosts the external mains powers supply with energy from the battery

Sine wave inverter

- Input voltage: 12 volts or 24 volts
- 2000 watts continuous power
- 3000 watt peak output for 3 sec. for high start-up power
- Automatic earthing for the function of an RCD circuit breaker

Automatic charger

- Charging voltage: 30–100 A, adjustable
- Transfer current: 50 A (230 volts)
- 6-step charging characteristics with conditioning function
- 2nd charger output for starter battery 5 A

CombiPower 2012 // 12 volts // Ref. No. 9102600104

CombiPower 2024 // 24 volts // Ref. No. 9102600105



The compact device is perfectly equipped for installation: Mounting rails on the right and left, each with two pre-drilled holes, all connections are easily accessible. The control unit/remote control is installed separately.

DIESEL GENERATOR – COMPACT POWERHOUSE

This generator has real power: with a continuous output of 3.5 kilowatts the BLUTEC 40D will easily power two self-contained air conditioners. Precision quartz technology delivers pure sine wave voltage that's ideal for even sensitive electronic devices.

An additional 12-volt output is available for charging the starter battery. The BLUTEC is one of the most compact diesel generators on the market and easily installs on board.



MY BENEFITS

- High continuous output
- Suitable as a power source for Dometic air conditioners
- Very compact unit
- User-friendly digital control panel
- Diesel fuel

Mobile energy systems

Super
compact
diesel
generator

3.39

Dometic BLUTEC 40D

3.5-kW diesel generator for generating 230-volt AC

- Suitable as a power source for two powerful air conditioners (e.g., each rated at 15,000 BTU/h)
- Low weight, small footprint
- Robust design with stainless steel housing
- Convenient digital control panel

Ref. No. 9102900202

Essential accessory: installation kit // Ref. No. 9102900035





MY COMFORT



MOBILE COMFORT SOLUTIONS



Vacuum cleaners	60 – 61
Boat cleaners	62
Safe	63



MY BENEFITS

- Handy, battery-powered vacuum cleaner for mobile use in boats, cars, motorhomes, caravans, and at home
- Maximum mobility with rechargeable 12-volt battery
- Can be recharged from 12 and 230 volts
- Cleaning power: 400 mm water column
- Easy-to-clean dust container and fabric filter

WET-AND-DRY VACUUM CLEANER SPOTLESSLY CLEAN

The handy WAECO PowerVac PV 100 doesn't need an external power supply because it comes with its own integrated battery. Up to 18 minutes of intensive vacuuming are possible before recharging is necessary – using the mains or a 12-volt battery. Even stubborn dirt is no match for the PowerVac's considerable suction power. The vacuum also handles liquids with absolutely no problem.

A practical, super compact device for the boat and home!

3.31



WAECO PowerVac PV 100

Wet/dry vacuum cleaner with 12-volt rechargeable battery

- Motor: 12 volts DC, 28,000 rpm
- Battery: 12 volts DC, 2.6 Ah
- Operating time: up to 18 min $\pm 10\%$
- Recharge time: 10 – 14 h (automatic switch-off)
- Power input: approx. 90 watts
- Vacuuming performance: approx. 400 mm water column ($\pm 10\%$)
- Capacity: 3.8 l
- Scope of delivery: vacuum cleaner, hose, attachments for upholstery, rugs and narrow gaps, carrying strap, mains adapter, 12-volt charging cable, operating instructions

Ref. No. 9103500212



NEW! DOMETIC CV 1004

CENTRAL VACUUM CLEANER SYSTEM

It has enough power to get the dirt out of the smallest gap, but it's only the size of a shoe box: the new CV 1004 vacuum cleaner system from Dometic can be neatly integrated into unused storage spaces. Its vacuum hose can be connected directly to the central unit or to an external "socket". The appliance starts automatically when the hose end is inserted into the socket and switches off automatically when it is removed. All in all, it is a consistent development of its predecessor model, with more functions at a more favourable price!

MY BENEFITS

- High vacuum power and efficient cleaning
- Small-sized central unit
- Vacuum hose can be inserted in 2 different places
- Extensive range thanks to 12 m vacuum hose
- Various brushes and nozzles included
- Upgradable with Dometic VacPort, the new sweep inlet valve



Clean result,
nice price!

3.31

NEW! Dometic CV 1004

Central vacuum cleaning system

- Power Input: 950 watts
- Input voltage: 230 volts
- Suction power: 2500 mm (water column)
- Dimensions (W x H x D): 298 x 171 x 175 mm
- Suction hose connection to the central unit or to an external hose socket (included in delivery)

Ref. No. 9103501126

Optional extras

Vacuum cleaner bag (5 pieces) // Ref. No. 9103501128



3.31

NEW! Dometic VacPort

Sweep inlet valve for CV 1004 and CV 2004

- Can be used only in combination with Dometic vacuum cleaner systems CV 1004 or CV 2004
- Installation at floor level – preferably in dirt-intensive areas
- Automatic activation and deactivation by opening or closing of the vacuum slot
- Two integrated LEDs for illumination of the floor area
- Accessories for installation included

Ref. No. 9103501127

MY BENEFITS

- Easy to use
- Perfect hygiene
- Powerful yet gentle cleaning



POWERFUL EFFECT – SPARKLING RESULTS

DOMETIC CLEAN&CARE BOAT CLEANERS

A complete line of cleaners for every task on board: Dometic has the right formulation for stainless steel surfaces, fridges, ovens and grills, and even for your boat cover. Innovative, easy-to-use products guarantee sparkling results – powerful and gentle at the same time. Cleaning your boat has never been easier and more fun!



7.03

NEW! Dometic Clean&Care Hygiene cleaner

- Antibacterial bio-alcohol
- Spray cleaner – ideal for vertical surfaces
- Also for refrigerators (eliminates minor ice build-up)
- Content: 500 ml

Ref. No. 9103501145



WARNING – Flammable liquid and vapour. Causes serious eye irritation.



7.03

NEW! Dometic Clean&Care Stainless steel cleaner

- Ideal for Dometic hobs and sinks
- Easily removes fat and grease
- Streak-free shine
- Content: 500 ml

Ref. No. 9103501173



7.03

NEW! Dometic Clean&Care BBQ and oven cleaner

- Effectively removes burnt-on food or grease
- Gel cleaner – holds vertically
- Neutral odour and gentle cleaning
- Content: 500 ml

Ref. No. 9103501159



WARNING – Causes skin irritation. Causes serious eye damage.



7.03

NEW! Dometic Clean&Care Awning and boat cover cleaner

- Quickly removes even the most persistent dirt
- Simple brush application
- Eliminates bad odours
- Content: 500 ml

Ref. No. 9103501131



WARNING – Causes serious eye damage.

UNDER LOCK AND KEY

SAFE WITH MECHANICAL LOCKING SYSTEM



3.34

Dometic SAFE 310C

Safe with mechanical locking system

- Capacity: 9 litres
- Weight: 7.4 kg
- Steel wall thickness: Door: 5.0 mm, cabinet: 2.0 mm
- Steel bolts: 2 x 19 mm
- Dimensions (W x H x D): 310 x 165 x 235 mm

Ref. No. 9106600543

Optional extras

Fixing kit // Ref. No. 9106600005



Where to put passports, money, and jewellery if you want to go to the beach or into town? The same company that equips hotels all over the world with room safes also offers a tailor-made security concept for your boat. The relatively light-weight Dometic SAFE 310C stops thieves with a steel enclosure, a door equipped with 19-mm steel bolts and a proven mechanical locking system. The safe can be installed horizontally or vertically depending on the room layout.

Mobile comfort solutions

MY BENEFITS

- Door locking with two 19 mm steel pivots
- High-quality manufacturing for maximum security
- Horizontal or vertical installation
- Mechanical locking system
- Easy key operation





DELIGHTFUL



MOBILE KITCHEN SOLUTIONS



Cooking with alcohol

Alcohol stoves / Oven 66 – 67

Cooking with gas

Oven combinations 68 – 69

Ovens / GasChecker / Gas cookers 70 – 71

Hobs 72

Built-in hob / sink combinations 73

Grill 72

Sinks with glass lid 74

Cooker hood 74

Coffee maker / Electric kettle 75

Technical data 110 – 115

COOKING, HEATING AND BAKING WITH ALCOHOL

Alcohol cookers are traditionally considered to be the safest way to cook at sea. That's because they work without pressure, are pleasantly quiet and require little space. Alcohol cookers from Dometic have been successful in the marketplace for more than 25 years. Customers appreciate the long burning times, the functional design using rust-free stainless steel and the wide selection of models and accessories. Dometic alcohol cookers can be permanently installed in the pantry or galley, and they can also be used as free-standing units on deck.

FREE-STANDING ALCOHOL STOVES IN RETRO-DESIGN

- ❶ Burner with flame spreader
- ❷ Carrying handle
- ❸ Flexible potholders (optional accessory)
- ❹ Safety lock
- ❺ Pan support – removable for easy cleaning
- ❻ Feet – enabling fixed installation



Gimbals available
as optional extra



3.33

Dometic ORIGO ONE

Free-standing alcohol stove

- Compact design – easy to stow
- Carrying handle for one-handed transportation
- Patented, easy-to-access alcohol fuel container
- High cooking performance
- Gimbals, flexible potholders and cutting board as optional extra

Ref. No. 9103303977



3.33

Dometic ORIGO TWO

Free-standing alcohol stove

- Compact design – easy to stow
- Carrying handle for one-handed transportation
- Patented, easy-to-access alcohol fuel container
- High cooking performance
- Gimbals, flexible potholders and cutting board as optional extra

Ref. No. 9103303978



3.32

Dometic ORIGO 5100

Boat heater / 1-burner alcohol stove

- Heater and stove all in one
- Can also be used for keeping food warm
- 1500 watts output in heater mode

Ref. No. 9103303920



MY BENEFITS

- Easy and safe operation with pressure-free alcohol fuel
- Long burning times
- Space-saving design



Alcohol



3.32

Dometic ORIGO A100 / A200

1- or 2-burner built-in alcohol stoves

- Easy and convenient to use
- Easy to fit

ORIGO A100 // Ref. No. 9103303935

ORIGO A200 // Ref. No. 9103303937



3.32

Dometic ORIGO 2000 / 4100

1- or 2-burner built-in alcohol stoves

- Low built-in height – ideal in confined spaces
- Flush-mounted – elegant appearance
- Detachable pan support and rounded corners – easy to clean

ORIGO 2000 // Ref. No. 9103303884

ORIGO 4100 // Ref. No. 9103303890

ALCOHOL OVEN WITH 2-BURNER STOVE



3.32

Dometic ORIGO 6000

Free-standing alcohol oven / stove

- High cooking power on all plates – fast, flexible cooking on board
- Easy access to the alcohol-fuel container – simple and safe to fill
- With gimbals – to keep the stove level in all weathers

Ref. No. 9103303922



MY BENEFITS

- Outstanding energy efficiency – fast cooking
- Precise flame regulation – absolute control over the cooking power
- Safety ignition system
- Transparent door with safety lock
- Wide choice of models – with or without grill
- Standard width (50 cm) or slimline design (45 cm)
- Dometic MoonLight TWO / THREE: with electrical ignition and interior light in oven



Gas

BAKING, COOKING AND GRILLING WITH GAS

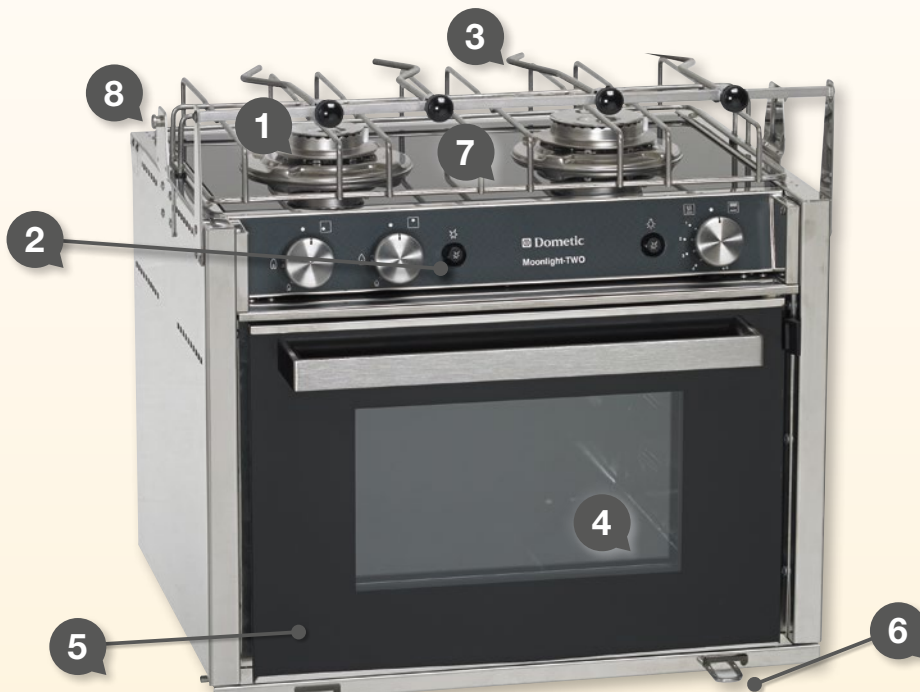

Dometic

MoonLight TWO / THREE

- 1 Burner
- 2 Electrical ignition
- 3 Potholders
- 4 Interior light
- 5 Transparent door with safety lock
- 6 Lock for gimbals
- 7 Glass top surface
- 8 Gimbals included

Why do without familiar ways of cooking food just because you're at sea? Dometic's convenient gas stoves and ovens satisfy the desires of even the most demanding cooks. They're visually stunning as well: the four stoves are now available in Dometic's elegant "Family Design". Two of the models – Dometic SunLight and StarLight – feature an extra-narrow footprint.

Both MoonLight models impress with a mirror-polished glass surface.



3.38



3.38

Dometic MoonLight TWO

Fully equipped oven with grill and 2-burner hob

- 28-litre gas oven with grill burner
- Transparent door with safety lock
- Electrical ignition and Interior light in oven
- Dimensions (W x H x D): 500 x 390 x 395 mm
incl. semi-gimbal suspension: 525 x 457 x 395 mm

Ref. No. 9103303824

Dometic MoonLight THREE

Fully equipped oven with grill and 3-burner hob

- 30-litre gas oven with grill burner
- Transparent door with safety lock
- Electrical ignition and Interior light in oven
- Dimensions (W x H x D): 473 x 435,4 x 470 mm
incl. semi-gimbal suspension: 501 x 500 x 470 mm

Ref. No. 9103303825



3.37

**Extra-slim
design for
small
galleys**



3.37

Dometic SunLight

Oven with 2-burner hob

- 28-litre gas oven
- Slimline design: ideal for smaller galleys or confined spaces
- Transparent door with safety lock
- Safety ignition system
- Dimensions (W x H x D): 448.6 x 397.5 x 356.9 mm
incl. semi-gimbal suspension: 475 x 429.5 x 356.9 mm

Ref. No. 9103303823

Dometic StarLight

Oven with grill cabinet and 2-burner hob

- 28-litre gas oven with grill cabinet
- Slimline design: ideal for smaller galleys or confined spaces
- Transparent door with safety lock
- Safety ignition system
- Dimensions (W x H x D): 448.6 x 507.5 x 356.9 mm
incl. semi-gimbal suspension: 475 x 539.5 x 356.9 mm

Ref. No. 9103303822

OVENS WITH GRILL

TWO SIZES – 20 OR 30 LITRES



Gas



3.38

Dometic FO211GT

Oven with grill

- With rotary tray and highly insulated multi-layer door
- Electronic 12-volt ignition
- Safety ignition system
- Oven door with safety lock
- Dimensions (W x H x D): 530 x 310 x 410 mm
Built-in dimensions (W x H x D): 504 x 283 x 460 mm

Ref. No. 9102302150



3.38

Dometic FO311GT

Oven with grill

- With rotary tray and highly insulated multi-layer door
- Electronic 12-volt ignition
- Safety ignition system
- Oven door with safety lock
- Dimensions (W x H x D): 530 x 430 x 415 mm
Built-in dimensions (W x H x D): 500 x 410 x 460 mm

Ref. No. 9102302151

GAS LEVEL INDICATOR

IS THERE ENOUGH GAS?

You'll have an answer in just a few seconds! This is how quickly the GasChecker from Dometic will let you know how full – or empty – your gas bottle is. Using the probe, it is placed on various points on the surface of the bottle horizontally. If there is gas in the bottle at the point where the measurement is taken, then the GasChecker signal lamp lights up in green.

At those points where there is no gas, it changes to red.

4.28

Dometic GasChecker GC100

Indicator for identifying the fill level of all standard propane and butane gas bottles.*

- Reliable level measurements using ultrasound
- Easy to use
- Suitable for all steel and aluminium gas bottles with a diameter of 200 - 350 mm (with the exception of self refilling bottles)
- Ideal for camping, recreation, boating and trades
- Weight: 25 g
- Dimensions: ø 16 x 113 mm
- Tested for explosion protection

*Not suitable for use on plastic bottles, self refilling gas bottles (because internal components can deflect the measurement signal)

Ref. No. 9103500697

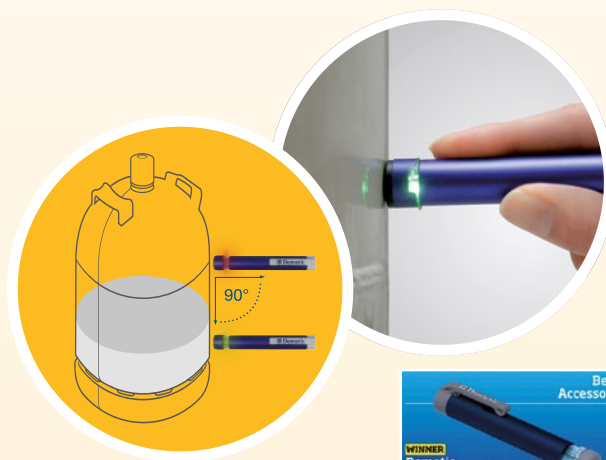

GasChecker

Watch video



FREE-STANDING GAS COOKERS

HIGH-QUALITY DESIGN IN STAINLESS STEEL

The one- or two-burner cookers offer an output of 1600 watts per burner, and come equipped with a safety ignition system, heat shield, adjustable pot holder and an easy-to-clean stainless steel surface. They can be permanently installed in the pantry or galley, but can also be used as free-standing units on deck. For those who need it, it's easy to add a (gimballed) suspension that's available as an optional accessory.



MY BENEFITS

- Outstanding energy efficiency – fast cooking
- Precise flame regulation – absolute control over the cooking power
- High-quality stainless steel
- Safety ignition system
- FO211GT / FO311GT: rotary plate and highly insulated multi-layered door
- Dometic EK 1600 / Dometic EK 3200: can be used permanently installed or free-standing unit



Gas



3.37

Dometic EK 1600

Single-burner, free-standing gas cooker

- Can be used as permanently installed or free-standing unit
- Adjustable potholder
- Safety ignition system
- High-quality stainless steel

Ref. No. 9103300517



3.37

Dometic EK 3200

Double-burner, free-standing gas cooker

- Can be used as a permanently installed or free-standing unit
- Adjustable potholder
- Safety ignition system
- High-quality stainless steel

Ref. No. 9103300518

MY BENEFITS

- PI8062M / PI8063M: with heat-resistant glass lid
- Dometic PI2232M: detachable chromed pan support – easy to clean
- Dometic PI7093: 230-volt grill in mirror-polished stainless steel



3.38

Dometic PI2232M

2-burner hob

- Power rating: 1 x 1 kW; 1 x 1.8 kW
- Dimensions (W x H x D): 380 x 90 x 280 mm
- Detachable chromed pan support – easy to clean
- Stainless steel burner cap

Ref. No. 9102300032



3.38

Dometic PI8062M

2-burner hob with glass lid

- Voltage: 12 volts (electronic ignition)
- Power rating: 1 x 1 kW; 1 x 1.8 kW
- Dimensions (W x H x D): 480 x 90.5 x 370 mm
- Built-in dimensions (W x D): 466 x 358 mm

Ref. No. 9102300008



3.38

Dometic PI8063M

3-burner hob with glass lid

- Voltage: 12 volts (electronic ignition)
- Power rating: 1 x 1 kW; 2 x 1.8 kW
- Dimensions (W x H x D): 560 x 90.5 x 440 mm
- Built-in dimensions (W x D): 546 x 428 mm

Ref. No. 9102300009

230-VOLT GRILL

With the compact electric grill from Dometic, grilling on board becomes a clean and convenient pleasure. This is especially true in harbour, where electrical connections are available, but the use of open flame is forbidden. The grill is easy to use and its mirror-polished stainless steel surface offers hassle-free cleaning.

3.38

Dometic PI7093

230-volt grill

- Mirror-polished stainless steel finish
- Heating capacity: 2.4 kw
- Dimensions (W x H x D): 533.4 x 101.6 x 304.8 mm
- Built-in dimensions (W x D): 501.7 x 295.3 mm

Ref. No. 9102302153



COMPACT HOB AND SINK COMBINATIONS



MO917R
(sink on right)



MO927R
(sink on right)



MO917L
(sink on left)



MO927L
(sink on left)

3.38

3.38

Dometic MO917R / MO917L

2-burner hob / sink combinations

- Power rating: 1 x 1 kW; 1 x 1.8 kW
- Dimensions (W x H x D): 600 x 120 x 420 mm
Built-in dimensions (W x D): 566 x 386 mm

MO917R // Ref. No. 9102300046
MO917L // Ref. No. 9102300045

Dometic MO927R / MO927L

2-burner hob/sink combinations

- Power rating: 1 x 1 kW; 1 x 1.8 kW
- Dimensions (W x H x D): 490 x 120 x 460 mm
Built-in dimensions (W x D): 456 x 426 mm

MO927R // Ref. No. 9102300050
MO927L // Ref. No. 9102300049



WASHING-UP IN COMFORT UNDER THE HOOD

Just fold down the glass lid when you're done washing up those dirty dishes. On the one hand, you'll have a neat and organized look. On the other, you'll also have additional storage space or an extra work surface, exactly when needed. The extremely compact sinks are available in three different models and include a siphon and rubber seal.



3.38

Dometic VA7306FP

Round sink with glass lid

- Heat-resistant safety glass lid, AC 540 siphon, rubber seal, with hole for tap (Ø 39 mm)
- Weight: 3.5 kg
- Dimensions (Ø x H): 420 x 148 mm
- Installation dimension (Ø): 400 mm

Ref. No. 9102300030



3.38

Dometic VA8005

Square sink with glass lid

- Heat-resistant safety glass lid, AC 540 siphon, rubber seal, with hole for tap (Ø 39 mm)
- Weight: 2.7 kg
- Dimensions (W x H x D): 420 x 145 x 370 mm
- Built-in dimensions (W x D): 405 x 355 mm

Ref. No. 9102300027



3.38

Dometic VA8006

Square sink with glass lid

- Heat-resistant safety glass lid, AC 540 siphon, rubber seal, with hole for tap (Ø 39 mm)
- Weight: 3.4 kg
- Dimensions (W x H x D): 420 x 145 x 440 mm
- Built-in dimensions (W x D): 405 x 425 mm

Ref. No. 9102300028

AIR RECIRCULATION COOKER HOOD: REMOVES FUMES



3.36

Dometic CK 2000

Air recirculation cooker hood with replaceable activated carbon filter

- Washable metal grease filter, easily replaceable carbon filter
- Easy access to grease filter and carbon filter
- Two-speed fan, two integrated halogen lamps

Ref. No. 9107300002



THIS MAKES YOUR GALLEY COMPLETE

COFFEE MAKER AND ELECTRIC KETTLE

MY BENEFITS

- Tailor-made for mobile use
- Wall or desk mounting
- For 12 volts and 24 volts
- Automatic switch-off (MCK 750)



NEW
With practical
swing filter

3.13

NEW! WAECO PerfectCoffee MC 052/054

Coffee maker for 5 cups, 12 or 24 volts

- Capacity: 5 cups (625 ml)
- Average power consumption: 12 volts: 200 watts, 24 volts: 300 watts
- Swing filter can be turned for easier use, integrated transport securing device for glass pot, hotplate with thermostat, fixing kit for wall or desk mounting
- Weight: 1.1 kg
- Dimensions (W x H x D): 240 x 270 x 155 mm
- E-approved (Automotive / EMC Directive), food-safe according to the German Foodstuff and Consumer Goods Act (LMBG)

MC052 12 V // Ref. No. 9103533013

MC054 24 V // Ref. No. 9103533014



3.14

WAECO PerfectKitchen MCK 750

Electric kettle for 12 volts and 24 volts

- Capacity: approx. 0.75 litres
- Average power consumption: 12 volts: 200 watts, 24 volts: 380 watts
- Automatic switch-off when boiling temperature is reached, robust relay technology, wall or desk mounting
- Weight: 0.8 kg
- Dimensions (W x H x D): 190 x 205 x 125 mm (incl. fixing kit)
- E-approved (Automotive / EMC Directive), food-safe according to the German Foodstuff and Consumer Goods Act (LMBG)

12 V // Ref. No. 9103533003

24 V // Ref. No. 9103533004





MY WELL-BEING



MOBILE SANITATION SOLUTIONS



Macerator toilets	80 – 83
Vacuum toilets	84 – 85
Marine holding tank system	86
Accessories and spare parts for holding tanks	87 – 89
Pressurised water pumps	88
Portable toilets	90
Sanitation additives / Toilet paper	91
Technical data	116 – 121

Clean water – a joint commitment

More and more countries have passed laws governing the discharge of wastewater. Boat owners who have installed a holding tank are on the right side of the law when sailing in far away waters. Dometic has been active for years in the use of holding tanks and pumping stations in order to keep our marinas and the marine environment clean.

NETHERLANDS | From 1st of January 2009, release of black water from any type of recreational craft is prohibited. All existing yachts with toilets must be equipped with holding tanks of adequate capacity as of January 1st 2009.

UNITED KINGDOM | Direct discharge of sewage into inland waters is prohibited. Codes of best practice are strongly encouraged.

FRANCE | Recreational boats equipped with toilets and built after January 1st 2008 which enter maritime or inland ports must be equipped with an installation that permits either storing toilet water or treating it.

SPAIN | All vessels built in May 2004 or later must have a holding tank installed.

BALTIC SEA | The Helsinki Convention for the protection of the Baltic Sea (HELCOM) recommends installation of toilet retention systems on all ships. The recommendation is still awaiting transposition into national law.

USA | Since 1980 all boats in US waters with a permanent toilet must be equipped with a Marine Sanitation Device. Waters of special concern (drinking water, shellfish beds and others) can be designated a No Discharge Zone, where treatment devices of any type cannot be used.

DOMETIC SANITATION SYSTEMS

TECHNOLOGY YOU CAN TRUST

With three toilet technologies to choose from, Dometic provides the right solution for every size of boat and every demand on comfort: electric toilets with macerator system, water saving vacuum flush toilets, portable toilets for confined spaces. For reliable and odour-free waste discharge Dometic offers a well engineered holding tank system that is easy to install, easy to use and compliant with ISO 8099 standards.



3 Tank monitors

Tank monitor systems can provide 4 indicator light signals – ‘empty’, ‘low’, ‘mid’ and ‘full’. A relay can also be fitted to shut down electric toilet operation when the tank is full. See p. 87

4 Discharge pump control

Permits operation of overboard discharge pump in unrestricted waters. Switch turns pump on and shuts pump off automatically when tank is empty. See p. 88

5 Vent filter

Vent filter media absorbs heavier-than-air gases that accumulate in holding tank and prevents them from escaping via the through-hull vent fitting. See p. 87

6 Vent line (MaxFlex)

MaxFlex sanitation hose, especially flexible and simple to install. See p. 89

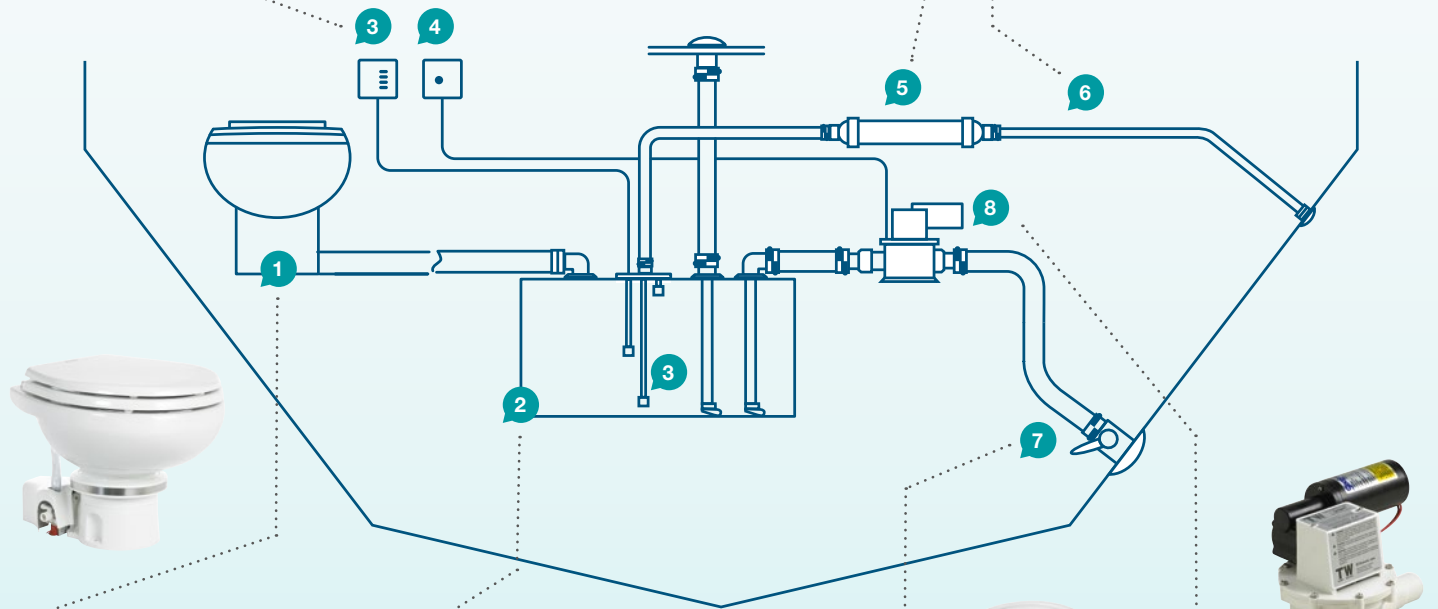

1 Toilet

Choose between Dometic macerator or vacuum toilets. See p. 80 – 84

2 Holding tank

Stores sewage from toilet until it can be discharged at dockside or at sea (according to local regulations). See p. 86

7 Sanitation hoses & fittings (OdorSafe)

Especially flexible and simple to install, excellent odour barrier. See p. 89

8 Discharge pump

Empties holding tank via seacock and through-hull discharge fitting. See p. 88



TWO TOILET TECHNOLOGIES COMPATIBLE WITH DOMETIC HOLDING TANK SYSTEM

MASTERFLUSH INSTALLATION

MY BENEFITS

- Quick and easy installation
- Powerful macerator flush
- Quiet operation
- 12 or 24 volts DC

Dometic MasterFlush electric toilets from Dometic install quickly and easily. They work with an integrated lifting and macerating unit, operate quietly and offer good flushing performance. Ideal for connecting to a holding tank, which may also be located further away.

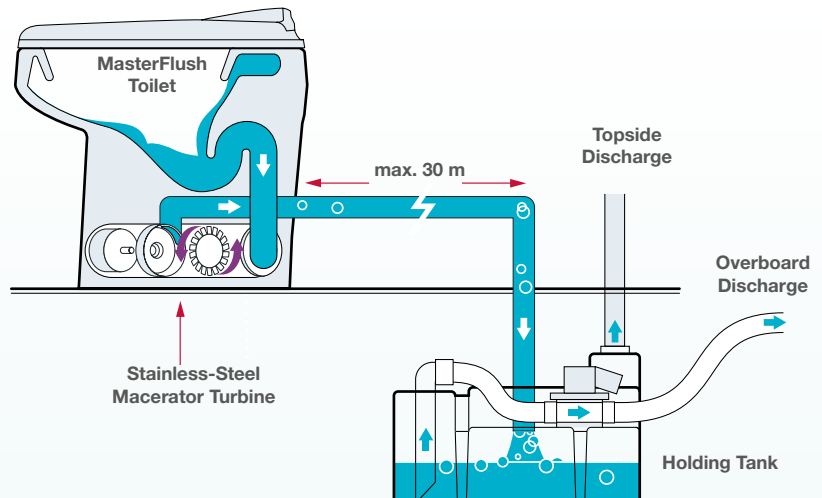

VACUFLUSH INSTALLATION

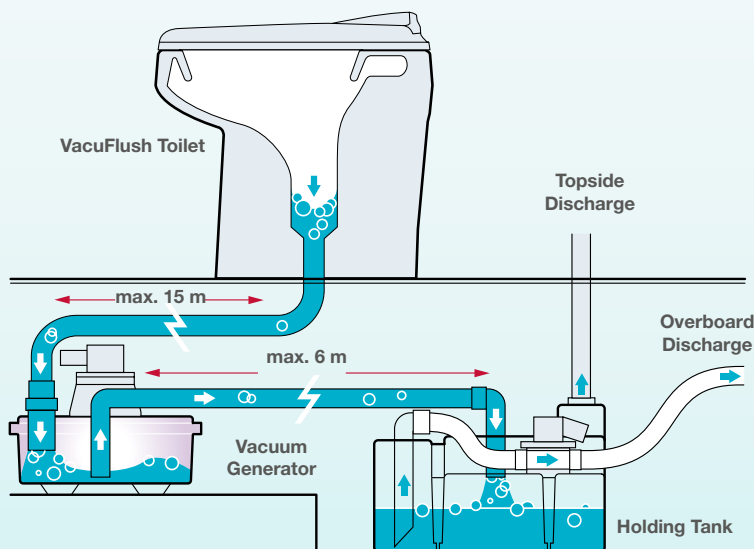

MY BENEFITS

- Low water consumption
- Powerful vacuum flush
- No unpleasant odours
- 12 or 24 volts DC

Dometic VacuFlush vacuum toilets stand out through their low water consumption. As a result, smaller water tanks can be used because, and fresh water flushing is possible. Yet another advantage: there are absolutely no unwanted odours.

Read how it works on page 85.

HOMELIKE COMFORT, EASY ON YOUR BUDGET

Easy drop-in replacement for manual toilets



DOMETIC MASTERFLUSH TOILETS
WITH 360° ORBIT BASE TECHNOLOGY

- 1 Full, flat back ledge hides all plumbing when viewed from above
- 2 Residential-size round-front enameled wood seat
- 3 Aesthetic seat-to-bowl matching contour
- 4 Deeply sloped bowl enhances user hygiene
- 5 360° omnidirectional rotating base
- 6 Integrated electric water valve
- 7 Macerator pump and enclosure
- 8 Water supply line to bowl and check valve



Homelike comfort and hygiene: residential-size seat, deeply sloped toilet bowl



Elegant and installation-friendly: electric water valve integrated in the base



Versatile installation in tight spaces: full 360° base-to-bowl rotation

MY BENEFITS

- Homelike comfort and hygiene
- Residential-size seat, a deeply sloped bowl, and an aesthetically appealing round front
- Its small footprint fits the plumbing points of most commonly used boat toilets

View video to see how easy these models are to install



The space-saving toilet is ideal for retrofitting. Its small footprint fits the plumbing points of most commonly used boat toilets and best of all, the 360° ORBIT installation feature means the base can be fixed to any angle to the bowl to avoid walls or adapt to diverse bathroom layouts. This industry first makes the new MasterFlush fit where other marine toilets won't.

Another asset is the highly effective macerator system. Its 10-blade stainless steel cutting wheel pulverizes waste for optimum effluent flow. This minimises the chance of odour permeation, so you can enjoy your cruise in complete comfort and convenience.



7.04

Dometic MasterFlush MF 7100

Electric macerator toilet with 360°-ORBIT base technology, **standard height**, sea water or fresh water

- MF 7160, sea water, 12 V // Ref. No. 9108833973
- MF 7160, sea water, 24 V // Ref. No. 9108833974
- MF 7120, fresh water, 12 V // Ref. No. 9108833970
- MF 7120, fresh water, 24 V // Ref. No. 9108833972



7.04

Dometic MasterFlush MF 7200

Electric macerator toilet with 360°-ORBIT base technology, **low-profile**, sea water or fresh water

- MF 7220, fresh water, 12 V // Ref. No. 9108834283
- MF 7260, sea water, 12 V // Ref. No. 9108834285

Spare parts available
Ask your dealer

7.04

Dometic MasterFlush Switches



Sea water flush switch – standard with all sea water models

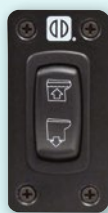

Fresh water add water / flush switch – standard with all fresh water models



Fresh water add water / flush / dry bowl switch – optional for all fresh water models DFST // Ref. No. 9108559126

ELEGANT DESIGN

SILENT YET POWERFUL FLUSH



7.04

Dometic MasterFlush 8152 / 8156

Electric toilet as **standard height**, 12 or 24 volts

8152, 12 V // Ref. No. 9108553023
 8156, 24 V // Ref. No. 9108553024



7.04

Dometic MasterFlush 8112 / 8116

Electric toilet as **low-profile model**, 12 or 24 volts

8112, 12 V // Ref. No. 9108553021
 8116, 24 V // Ref. No. 9108553022



ELECTRIC TOILETS WITH MACERATING SYSTEM

The same level of quality as your toilet at home: high-quality ceramic bowl, a sturdy toilet lid made of enamelled wood, convenient control elements, very low noise levels and connections that are invisible on the outside so they won't spoil the aesthetic appearance.

Dometic MasterFlush electric toilets work with an integrated macerating and pumping system and are ideal for connecting to a holding tank. This tank can be located up to 30 metres away or up to 3 metres above the toilet.

Dometic MasterFlush Switch



Fresh water add water / flush / dry bowl switch – as standard for 8000 models.



8900 SERIES MACERATOR TOILETS

STYLE, QUALITY AND VERSATILITY

The Dometic MasterFlush 8900 series gives boat builders and owners unprecedented freedom of choice. Toilet only or comfort model with integrated bidet function, low profile or standard height, through-the-floor or through-the-wall discharge – everything is possible. All models feature a contemporary soft-close seat.

MasterFlush 8900 series macerator toilets come standard with the Dometic Flush Touchpad. A control element to fit Vimar/Gewiss frames is available as optional accessory.



NEW
Models with bidet function



7.04

Dometic MasterFlush MF 8900

Electric macerator toilet with or without bidet as **standard height**, 12 or 24 volts

- 8979, Standard, 12 V // Ref. No. 9108553155
- 8970, Standard, 24 V // Ref. No. 9108553153
- 8989, Standard, toilet/bidet, 12 V // Ref. No. 9108684198
- 8980, Standard, toilet/bidet, 24 V // Ref. No. 9108684195



7.04

Dometic MasterFlush MF 8900

Electric macerator toilet with or without bidet as **low-profile model**, 12 or 24 volts

- 8939, Low-profile, 12 V // Ref. No. 9108553050
- 8930, Low-profile, 24 V // Ref. No. 9108553048
- 8949, Low-profile, toilet/bidet, 12 V // Ref. No. 9108684175
- 8940, Low-profile, toilet/bidet, 24 V // Ref. No. 9108684176

MY BENEFITS

- Toilet only or comfort model with integrated bidet function
- Powerful macerator flush
- Soft-close seat
- Small footprint – fits in almost any head compartment
- Dometic Flush Switch Panels to fit Vimar/Gewiss frames (optional)
- Dometic Flush Touchpad as standard

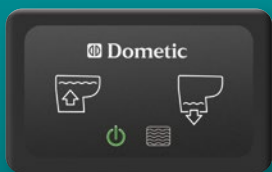

Add water and flush functions. Power on and full tank indicator lights. In scope of delivery.



Optional Accessory

7.04

Dometic Flush Switch Panel

Optional flush switch, fits Vimar/Gewiss frames. Add water and flush control. "Power on" and "full tank" indicators.

- 12 V DC or 24 V DC

Ref. No. 9108782202

VACUUM TOILETS

TO MATCH EVERY REQUIREMENT

Only 0.47 litres of water per flush: the 5000 series from Dometic conserves fresh water resources; the size of the holding tank can be reduced accordingly. Standard flush and economy flush are both possible with the 4800 series. Toilets in this series have a high level of comfort and quality and a space-saving design.



7.04

Dometic VacuFlush 5000 series

Pedal operated vacuum toilet as low-profile or in standard height, 12 / 24 volts

- Very low water consumption (0.47 l/flush)
- Small footprint
- Connection to vacuum generator, vacuum pump and in combination with vacuum tank or holding tank system with integrated vacuum generator

5006, Low-profile // Ref. No. 9108554828
5009, Standard // Ref. No. 9108554833
5048, Standard // Ref. No. 9108554839



7.04

Dometic VacuFlush 4800 series

Electric operated vacuum toilet as low-profile or in standard height, 12 or 24 volts

- Very low water consumption in two operating modes
- Seat with automatic soft-close
- Service mode possible without running water

4806, Low-profile, 12 V // Ref. No. 9108554740
4806, Low-profile, 24 V // Ref. No. 9108554772
4809, Standard, 12 V // Ref. No. 9108554742
4809, Standard, 24 V // Ref. No. 9108554774

MY BENEFITS

- Very low water consumption
- 5000 series: small footprint; pedal operation
- 4800 series: two flush settings – standard flush and economy flush



Backlit push buttons



Optional Accessory for 4800 series

7.04

VacuFlush Toilet switch

VacuFlush switch for wall mounting. Add water and flush control at the touch of a button. "OK to flush" and "do not flush" indicators.

- 12 V DC or 24 V DC

Ref. No. 9108782199

VACUUM GENERATORS

NECESSITY FOR VACUUM TOILETS

At the heart of every VacuFlush marine toilet system is a vacuum generator. A stored reservoir of vacuum is quietly accumulated in a separate tank, and instantly evacuates the VacuFlush toilet when flushed.

Two models are available: the low-profile VGLP vacuum generator is the perfect fit in confined spaces, the VG4 model comes with adjustable components to accommodate diverse head layouts. It is the most versatile, efficient and quiet vacuum source developed by Dometic.



7.04

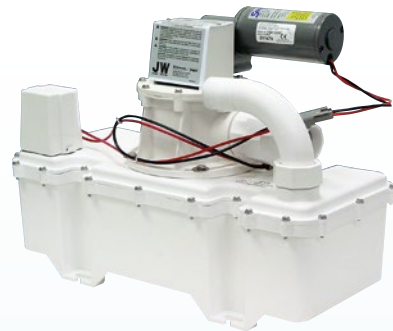

7.04

Vacuum generator VGLP

Combination of vacuum tank and S-series vacuum pump

Powerful vacuum source for all VacuFlush toilets, vacuum pump and tank can be fitted up to 0.9 m apart from each other (additional sanitation hose required), supplied pre-wired and pre-fitted

12 V DC // Ref. No. 9108554934
24 V DC // Ref. No. 9108554935

Vacuum generator VG4

Combination of vacuum tank and J-series vacuum pump

Components accommodate diverse plumbing layouts, improved pump flow thanks to large valve openings (51 mm ID), injection-moulded tank with precise tolerances for efficient and reliable operation, supplied pre-wired and pre-fitted

12 V DC // Ref. No. 9108554946
24 V DC // Ref. No. 9108554947

HERE'S HOW VACUFLUSH WORKS

Vacuum is maintained in the system at all times. When the toilet is flushed, the vacuum energy stored in the system is released. The bowl is instantly cleared and the waste is moved through the vacuum tank and the vacuum pump, ending up in the holding tank.

The change in pressure in the vacuum tank causes the integral pressure switch to activate the vacuum pump.

The vacuum pump continues to run until the vacuum level is recharged in the system. Recharging the vacuum takes about one minute.

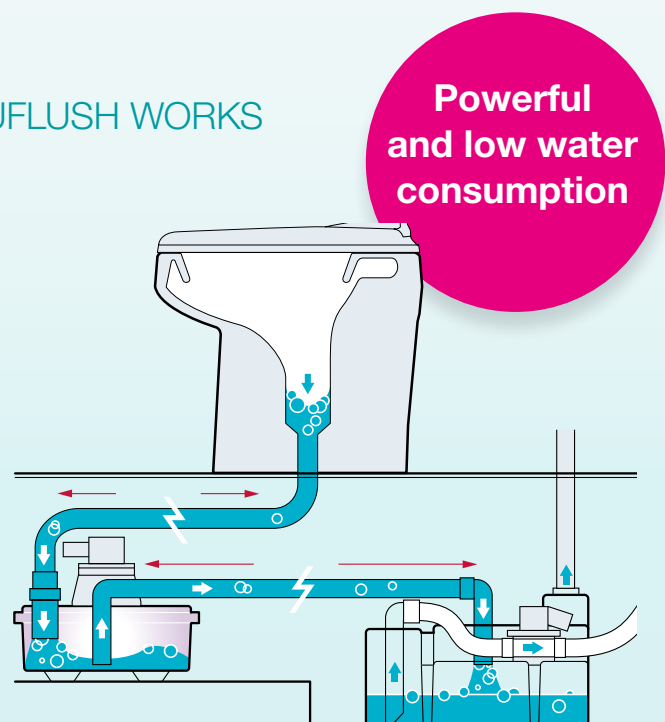

PRE-INSTALLED AND TESTED FITTINGS FOR EASY AND SAFE INSTALLATION



Pre-fitted
and
pre-tested

- 1 + 2 Outlet to deck fitting or discharge pump
- 3 Inspection port (and location of optional level indicator)
- 4 Ventilation connection
- 5 Holding tank safety valve
- 6 Inlet from toilet

7.04

Dometic DHT42L / DHT61L / DHT88L / DHT110L / DHT137L

Holding tank for marine toilets

Available in 5 sizes: 42, 61, 88, 110 and 137 litres

DHT42L // Ref. No. 9107100001
 DHT61L // Ref. No. 9107100002
 DHT88L // Ref. No. 9107100003
 DHT110L // Ref. No. 9107100004
 DHT137L // Ref. No. 9107100005

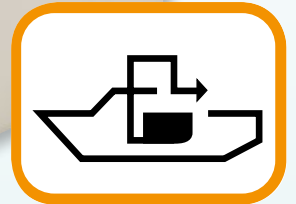

Dometic has been a leading supplier of holding tank systems in the original equipment sector for decades. Know-how and experience gained in numerous OEM projects are the basis for our successful retrofit solutions. Dometic holding tanks are especially developed for the European market and fully comply with ISO 8099 standards.

They are long lasting and odour-free, easy to install and to operate.

WHAT SHOULD I LOOK FOR IN A RELIABLE HOLDING TANK?

A reliable holding tank should be designed to eliminate leakage of fluids and odours.

Here are five things we believe it should have:

- Pre-installed fittings to minimise the risk of leakage
- Sturdy, thick walls to prevent odour permeation
- Ventilation connection for vent filter

- Separate outlets for dockside and overboard discharge
- A vacuum relief valve to protect tank and fittings from excessive suction force by dockside pumps

Ensure the unit meets ISO 8099 requirements. This international standard defines the technical requirements for boat toilet retention systems.

ACCESSORIES FOR HOLDING TANK SYSTEMS

TankSaver®

- Holding tank safety valve
- Material: Rubber, PE
 - Dimensions: Ø 76 mm, 1½" vent

Ref. No. 9108554455

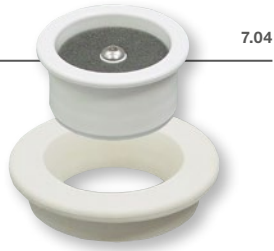

7.04

NEW! DTK diptube kit

Removes waste through top of tank – eliminates stagnant waste from sitting in discharge line connected at bottom of tank.

- Prevents clogging; reduces tank effluent
- Fits tanks up to 762 mm in height
- Easy to install

Ref. No. 9108558205

Accessory // 90° elbow // Ref. No. 9108558704



7.04

Upgrade any other holding tank

Lasts for the whole season



7.04

NEW! Dometic Vent Filter

Absorbs holding tank vent odours. Keeps air clean and pleasant

- Most effective odour control – absorbs tank odours for an entire boating season
- Installs easily between holding tank and through-hull vent
- Easily replaceable every season

Ref. No. 9108849515

Dometic DTM04

Tank monitor. Four-level unit with three float switches and four-colour LED indicator

- Continuous tank monitoring with four-level indication
- Easy installation, probe cap installs in Dometic tank inspection port
- Adjustment of float switch to required length possible

DTM04 with ventilation // Ref. No. 9108554495

DTM04 without ventilation // Ref. No. 9108554496



7.04

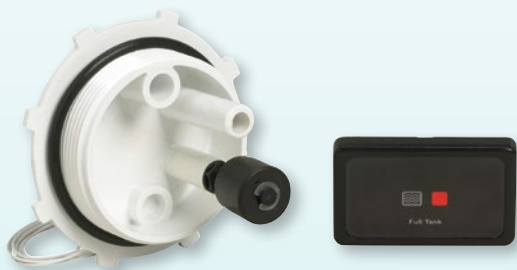

7.04

Dometic DTM01C

Tank monitor
Single-level unit with one float switch and red warning light

- Simple and cost-effective solution
- Activates red warning light when holding tank is about ¾ full
- Easy installation; probe cap installs in Dometic tank inspection port

Ref. No. 9107100009



7.04

Dometic DTM01P

Tank monitor
Single-level unit with one float switch and red warning light

- Easy installation on Dometic holding tanks
- Activates red warning light when holding tank is approx. ¾ full

Ref. No. 9108688891

PUMPS AND CONTROLS

FOR RELIABLE HOLDING TANK DISCHARGE



7.04

Dometic DTW12 / DTW24

Holding tank discharge pump for 12 or 24 volts DC

- Quiet operation
- Long-lasting bellows design
- Dry self-priming
- Flow rate: 1130 litres per hour

Dometic DTW12, 12 V // Ref. No. 9107100006

Dometic DTW24, 24 V // Ref. No. 9107100007



7.04

Dometic DTD01-12 / DTD01-24

Tank discharge management

For use in combination with DTM04 tank monitor

- Easy and safe holding tank discharge
- Manual discharge in unrestricted waters
- No accidental discharge in restricted waters
- Simplifies plumbing by eliminating Y-valves

Dometic DTD01-12, 12 volts // Ref. No. 9107100011

Dometic DTD01-24, 24 volts // Ref. No. 9107100012

PRESSURISED WATER PUMPS

DESIGNED FOR WORRY FREE OPERATION

PowerPump pressurised water pumps from Dometic are self-priming, can run dry without being damaged, and are energy-efficient and quiet. Scope of delivery includes a filter and three 12.5 mm (1/2") hose connectors. Easy to install.

7.13

Dometic PowerPump

High-performance pressurised water pumps

- Powerful yet quiet and economical
- Self-priming – can be placed above water tank
- Runs dry without damage
- Maintenance-free diaphragm design

PP127, 7 l/min, 12 V // Ref. No. 9107100051

PP1210, 10 l/min, 12 V // Ref. No. 9107100052

PP2410, 10 l/min, 24 V // Ref. No. 9107100053

PP1217, 17 l/min, 12 V // Ref. No. 9107100054

PP2417, 17 l/min, 24 V // Ref. No. 9107100055

**Powerful.
Robust.
Lasting.**



HIGH-QUALITY HOSES

FOR SANITATION APPLICATIONS

Boat builders swear by them and have made Dometic MaxFlex the most-purchased sanitation hoses in Germany, because they're especially flexible and simple to install, even in tight spaces. Dometic OdorSafe offers the best odour barrier – up to 500% more effective than other sanitation hoses!



7.13



7.13

Dometic MaxFlex 38 / 25 / 19 / 16

Very flexible, high-quality hose for multiple sanitation uses
Available in four sizes: Ø 38 mm, Ø 25 mm, Ø 19 mm and Ø 16 mm

Ref. No. see p. 120

Dometic OdorSafe Plus 38

Sanitation hose with excellent odour barrier properties.
Available in Ø 38 mm for sewage system

15 m // Ref. No. 9107100015

HOSE FITTINGS AND CHECK VALVE

For use with OdorSafe® Plus (38 mm) ID hose. Kits include Custom Hose Adapters.



Hose Mender Kit

- Connects 38 mm hose ends together
- Includes two adapters

Ref. No. 9108553350

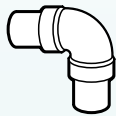

90° Bend Kit

- Provides smooth sweep corner to eliminate kink
- Includes two adapters

Ref. No. 9108553351



Hose Adapter Kit

- Connects 38 mm hose to 38 mm FPT fitting
- Includes one adapter

Ref. No. 9108553352

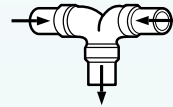

Double Bend Kit

- Connects intersecting hose ends together per indicated flow
- Includes three adapters

Ref. No. 9108553353

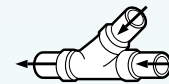

Wye Kit

- Connects intersecting hose ends together per indicated flow
- Includes three adapters

Ref. No. 9108553354

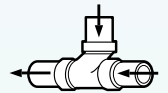

Tee Kit

- Connects intersecting hose ends together per indicated flow
- Includes three adapters

Ref. No. 9108553355



PVC 45° Street El

- Adapts to all (38 mm) fittings shown here

Ref. No. 9108731117



Reducing Adapter

- Connects 38 mm hose to 25 mm hose
- Includes one adapter

Ref. No. 9108731118



PVC 90° Street El

- For tight corners
- Can be used with other PVC fittings shown here

Ref. No. 9108731123



PVC Adapter

- Connects 38 mm hose with Custom Hose Adapter or rigid PVC pipe to 38 mm fitting

Ref. No. 9108731124



Custom Hose Adapter

- Can be used with all 38 mm PVC fittings with socket connection
- Lubricated hose or cuff slides on easily

Ref. No. 9108559169

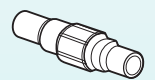

Check Valve Adapter

- For light-duty applications

Ref. No. 9108709375

COMPACT HYGIENE: PORTABLE TOILETS

Convenient, space-saving hygienic comfort for your boat.
The portable toilets from Dometic combine many useful functions in the smallest of spaces.

MY BENEFITS

- Portable toilet in two sizes and two colours
- 8.7 litre flush water tank – sufficient for 27 flushes
- Push-button operation
- Strong 360° pressure flush for effective cleaning
- Tank level indicator protects against overflow
- Ingenious disposal system: extra-long, pivoting spout and vent openings for clean, splash-free discharge
- Back-up tank, discharge kit and fixing kit as accessories



Basic model

7.01

SaniPottie® 972

Space-saving portable toilet with 360° pressurised flush

- Holding tank capacity: 9.8 litres
- Flush water tank capacity: 8.7 litres
- Dimensions (W x H x D): 333 x 317 x 387 mm
- Weight: 5.4 kg

SaniPottie® 972, white/beige // Ref. No. 9108557678

SaniPottie® 972, white/grey // Ref. No. 9108557679



Larger volume for waste

7.01

SaniPottie® 976

Space-saving portable toilet with 360° pressurised flush

- Holding tank capacity: 18.9 litres
- Flush water tank capacity: 8.7 litres
- Dimensions (W x H x D): 333 x 387 x 387 mm
- Weight: 5.9 kg

SaniPottie® 976, white/beige // Ref. No. 9108557680

SaniPottie® 976, white/grey // Ref. No. 9108557681





It's Tab time!

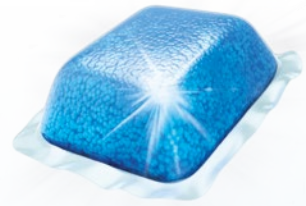

CONVENIENT, CLEAN, EFFICIENT:
SANITATION TABS FROM DOMETIC

IT COULDN'T BE MORE CONVENIENT! SANITATION IN A TAB

The highly effective sanitation tabs from Dometic are pre-dosed for use in holding tanks of approx. 20 litres and are added to the tank in their soluble film wrapper. Benefit: Hands and surrounding areas stay clean. With Dometic GreenCare the practical tabs are designed to be environmentally friendly.

- Rapid decomposition of solid waste without the annoying formation of gas or odours
 - Pre-dosed and ready for use
 - Available in two versions



7.03



7.03



7.03

Dometic PowerCare Tabs

Highly-effective additive for the waste holding tank. Breaks down waste into liquid and prevents unpleasant odours.

- No spills
- Pre-measured dosage
- Tabs in soluble films
- Lightweight
- For all portable toilets
- Easy storage
- 16 tabs per tub

Ref. No. 9107200100



DANGER – Causes serious eye damage. Very toxic to aquatic life with long lasting effects.

Dometic GreenCare Tabs

Highly effective environmentally friendly tab for the waste holding tank. Breaks down waste into liquid and prevents unpleasant odours.

- New environmentally friendly version
- No spills
- Pre-measured dosage
- Tabs in soluble films
- Lightweight
- For all portable toilets
- Easy storage
- 16 tabs per tub

Ref. No. 9107200117



WARNING – Causes serious eye irritation.

Dometic ComfortCare

Special, fast-soluble toilet paper for the comforts of home

- Quickly-soluble to prevent blockages
- 2-ply
- Extra-soft
- Facilitates waste holding tank discharging
- Content: 4 rolls

Ref. No. 9107200081

4.30 // WAECO CoolFreeze CFX

Compressor coolers



	CFX 35	CFX 40	CFX 50	CFX 65	CFX 65DZ
Ref. No.	9105304047	9105304048	9105304049	9105304050	9105304051
Ref. No. UK	9105305645	9105305646	9105305647	9105305648	9105305649
Storage volume (l, approx.) incl. for fresh food (l)	32 4.5	38 7	46 8.5	60 13	53 13 + 17 freezer
Connections	12/24 V DC 100–240 V AC	12/24 V DC 100–240 V AC	12/24 V DC 100–240 V AC	12/24 V DC 100–240 V AC	12/24 V DC 100–240 V AC
Temperature range	+10°C to –22°C	+10°C to –22°C	+10°C to –22°C	+10°C to –22°C	+10°C to –22°C
Power input (watts, approx.)	43	48	52	58	50
Current consumption (Ah/h) at 12 V at +20°C at +32°C ambient temperature, both at +5°C interior temperature	0.32 0.60	0.36 0.64	0.38 0.68	0.42 0.76	0.42 0.76
Energy class	A++	A++	A++	A++	A+
Insulation PU foam all around	•	•	•	•	•
System	Fully hermetic compressor with integrated control electronics, low-voltage protection/electronic fuse, automatic reverse pole protection, electronic thermostat				
Material	Cabinet: PP + ABS Lid: PE	Cabinet: PP + ABS Lid: PE	Cabinet: PP + ABS Lid: PE	Cabinet: PP + ABS Lid: PE	Cabinet: PP + ABS Lid: PE
Colour	Pale grey/ dark grey	Pale grey/ dark grey	Pale grey/ dark grey	Pale grey/ dark grey	Pale grey/ dark grey
Weight (kg, approx.)	17.5	18.5	20.4	22.3	23.2
Test marks	TÜV/GS, e-certified (Automotive EMC Directive)				
Scope of delivery	•	•	•	•	•
Removable wire basket	•	•	•	•	•
Detachable carrying handles	•	•	•	•	•
Optional extras					
Mains adapter EPS 100, 230 V > 24 V	–	–	–	–	–
Mains adapter MPS 35, 110 V – 240 V > 24 V	–	–	–	–	–
Universal fixing kit	–	–	–	–	–
Wireless display	9105304065	9105304065	9105304065	9105304065	9105304065

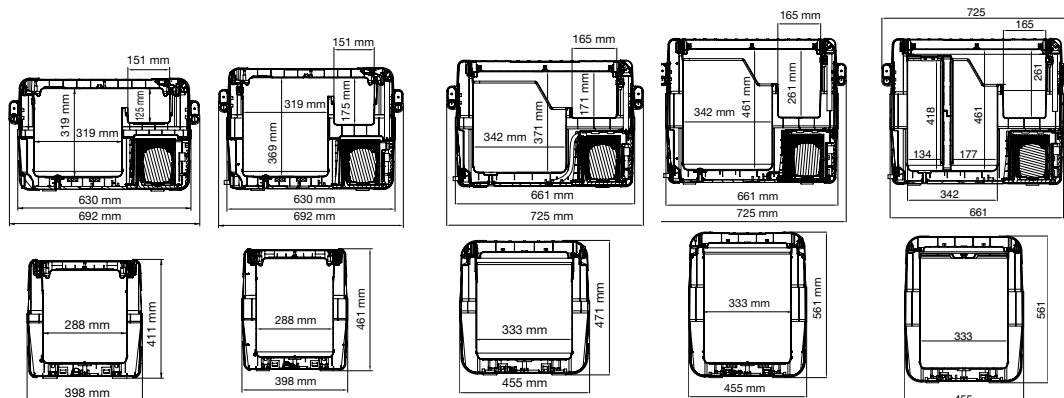

4.10 // WAECO CoolFreeze CDF

4.10 // WAECO CoolFreeze CF

4.21 // WAECO CoolFun CK



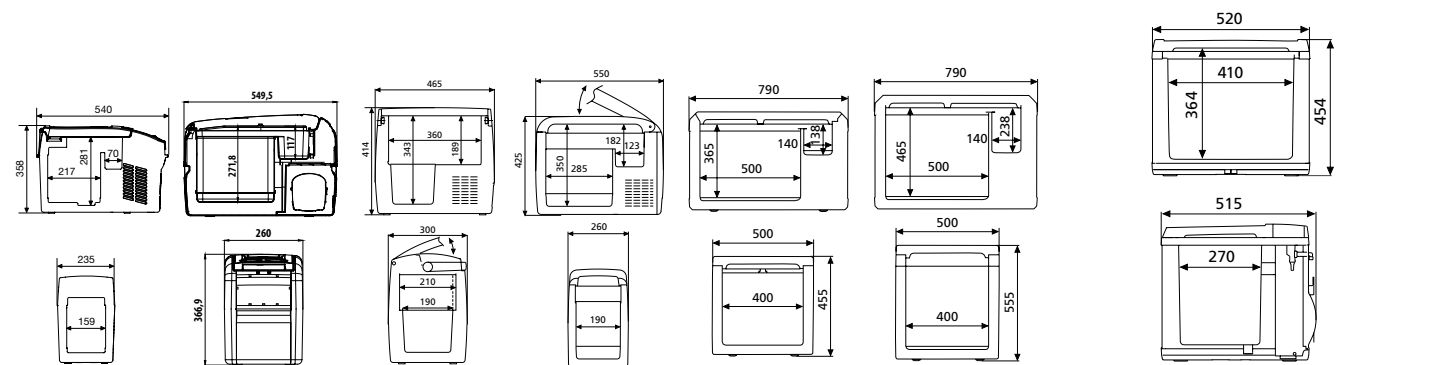



CDF 11	CDF 16	CDF 18	CDF 26	CF 80	CF 110	CK 40D	CK 40D Hybrid
9105100007	9105303477	9105100002	9105303457	9105303248	9105303102	9105303388	9105305750
10.5 –	16 –	18 –	21 4	79 7	105 13	38	38
12/24 V DC	12/24 V DC	12/24 V DC	12/24 V DC	12/24 V DC 100–240 V AC	12/24 V DC 100–240 V AC	230 V AC	12 V DC (thermoelectrics) 230 V AC (compressor)
+10°C to –18°C	+10°C to –18°C	+10°C to –18°C	+10°C to –18°C	+10°C to –18°C	+10°C to –18°C	+10°C to –15°C	DC: to 20°C* AC: +10°C to –15°C
35	35	35	35	65	65	75	DC: 47/AC: 75
0.29 0.61	0.21 0.44	0.38 0.64	0.44 0.67	0.65 1.19	0.76 1.35	– –	3,9 –
–	–	–	–	A+	A+	A++	A+
•	•	•	•	•	•	PU-foam	
Fully hermetic compressor with integrated control electronics, low-voltage protection/electronic fuse, automatic reverse pole protection, electronic thermostat						Thermoelectrics + 230-V-compressor, electronic thermostat	
Cabinet: PP Lid: PE	Cabinet: PP Lid: PE	Cabinet: PP Lid: PE	Cabinet: PP Lid: PE	Cabinet: coated sheet steel Top and base: PP Lid: PE		Cabinet: coated sheet steel, Top and base: plastic	
Pale grey/ dark grey	Pale grey/ dark grey	Pale grey/ dark grey	Pale grey/ dark grey	Pale grey/ dark grey	Pale grey/ dark grey	Silver/black	Black
8.8	11.5	11.5	12.7	31	33	22	22
e-certified (Automotive EMC Directive)	TÜV/GS, e-certified (Automotive EMC Directive)						
–	–	–	•	•	•	–	–
–	–	–	–	•	•	–	–



4.01 // WAECO TropiCool

4.02 // WAECO CoolFun

Thermoelectric coolers

						
	TC 07	TC 14FL	TC 21FL	TC 35FL	CX 30	S 28DC
Ref. No.	9105302036	9105302046	9105302085	9105302110	9103500872	9105302763
Ref. No. UK	9105303473	9105302934	9105302935	9105302936		
Storage volume (l, approx.)	7	14	20	33	29	25
Connections	12 V DC/ 230 V AC	12/24 V DC/ 230 V AC	12/24 V DC/ 230 V AC	12/24 V DC/ 230 V AC	12 V DC/ 230 V AC	12 V DC
Consumption at 12 V DC (watts) at 24 V DC (watts) at 230 V AC (watts)	36 — 40	46 50 64	46 50 64	46 50 64	47 — 55	35 — —
Energy class	—	A++	A++	A++	A++	—
Temperature range Cooling below ambient temperature (°C, approx.) Heating (°C, approx.)	max. 25 +65	max. 30 +50 to +65	max. 30 +50 to +65	max. 30 +50 to +65	max. 18 +65	max. 15 —
Insulation PU foam all around	•	•	•	•	•	Lightweight full insulation
System Thermoelectric (Peltier system)	•	•	•	•	•	•
Material	Injection moulded parts	Injection moulded parts	Injection moulded parts	Injection moulded parts	PP	Plastic: PP Bag: Textile
Colour	Dark grey/ pale grey	Dark grey/ pale grey	Dark grey/ pale grey	Dark grey/ pale grey	Dark grey/ pale grey	Beige/blue
Weight (kg, approx.)	2.8	5.0	6.0	10.0	4.3	2.3
Test marks	TÜV/GS, e-certified (Automotive EMC Directive)					





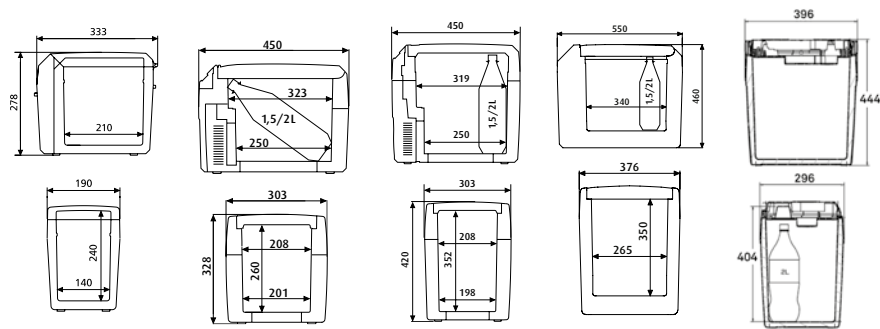



Optional extras

Universal fixing kit	—	9105303709	9105303709	9105303709	—	—
Mains adapter EPS 817, 230 V AC > 12 V DC	—	—	—	—	—	9102600030



4.14 // WAECO Cool-Ice

Ice Boxes

								
	WCI-13	WCI-22	WCI-42	WCI-55	WCI-70	WCI-85	WCI-85W	WCI-110
Ref. No.	9108400056	9108400060	9108400062	9108400067	9108400071	9108400073	9108400215	9108400054
Storage volume (l, approx.)	13	22	41	55	68	86	86	111
Dimensions (WxHxD, mm)	388 x 305 x 245	388 x 313 x 365	635 x 337 x 390	565 x 420 x 485	685 x 420 x 485	835 x 435 x 495	835 x 435 x 495	1050 x 440 x 510
Weight (kg, approx.)	2.8	4.2	7.5	9.3	10.4	13.1	13,8	15.7

Built-in compressor coolers / refrigerators

4.12 // WAECO CoolMatic CB

**4.10 // WAECO CoolMatic CD
4.24 // WAECO CoolMatic CRD**

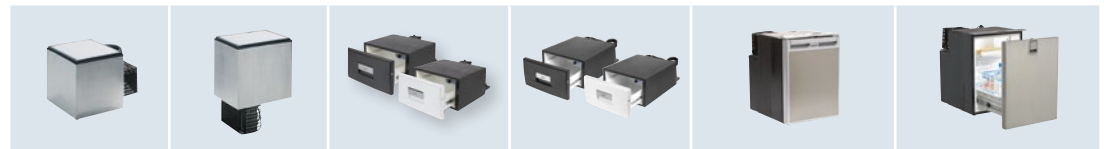

	CB 36	CB 40	CD 20 / CD 20W	CD 30 / CD 30W	CRD 50	CRD 50S
Ref. No.	9105203899	9105203900	9105304843 (black) 9105304844 (white)	9105303053 (black) 9105303054 (white)	9105304081	9105305621
Storage volume (l, approx.) thereof freezer compartment	36 –	40 –	20 –	30 –	50 4	50 4
Connections	12/24 V DC	12/24 V DC	12/24 V DC	12/24 V DC	12/24 V DC	12/24 V DC
Temperature range	+10 °C to –12 °C	+10 °C to –12 °C	+15°C to +0°C	+12°C to –2°C	+10°C to –12°C	+10°C to –12°C
Average power consumption (watts, approx.)	45	45	40	40	40	40
Consumption (Ah/h) at 12 V at +20°C at +32°C	0.56 0.94	0.64 1.01	0.67 1.33	0.67 1.33	1.5 (at 25°C) 1.8	1.5 (at 25°C) 1.8
ambient temperature, both at +5°C interior temperature						
Energy class	–	–	–	–	–	–
Insulation PU foam all around	•	•	•	•	•	•
System	Fully hermetic compressor with integrated control electronics, electronic thermostat, low voltage protection / electronic fuse, automatic reverse pole protection			Fully hermetic compressor with integrated control electronics, mechanical, continuously variable thermostat, low voltage protection / electronic fuse, automatic reverse pole protection		
Material	Outside: zinc coated sheet steel, inside: stainless steel, base: shock-resistant plastic	Sturdy metal housing, drawer of injection-moulded parts		Body: with coated metal frame Interior: Plastic Door frame: Plastic Fittings: Stainless steel	Body: with coated metal frame Interior: Plastic Fittings: Stainless steel Door: Stainless steel	
Colour	Body: grey, decor panel: pale grey	CD 20: black CD 20W: black, front white	CD 30: black CD 30W: black, front white	Body: black Door frame: Silver Door panel: Matt-silver (brushed stainless steel appearance)	Body: black Door: Stainless steel (AISI316)	
Weight (kg, approx.)	17	19	16.1	18	20	20
Test marks	e-certified (Automotive EMC Directive)			TÜV/GS, e-certified (Automotive EMC Directive)		
Optional extras						

Mains adapter EPS 100, 230 V > 24 V	9102600031	9102600031	9102600031	9102600031	–	–
Mains adapter MPS 35 110 V – 240 V > 24 V	9103555825	9103555825	9103555825	9103555825	9103555825	9103555825
Stainless steel installation frame	–	–	9105303901	9105303901	–	–
Standard installation frame	–	–	–	–	9105303880	9105305676
Flush-mount installation frame	–	–	–	–	9105303881	9105305671

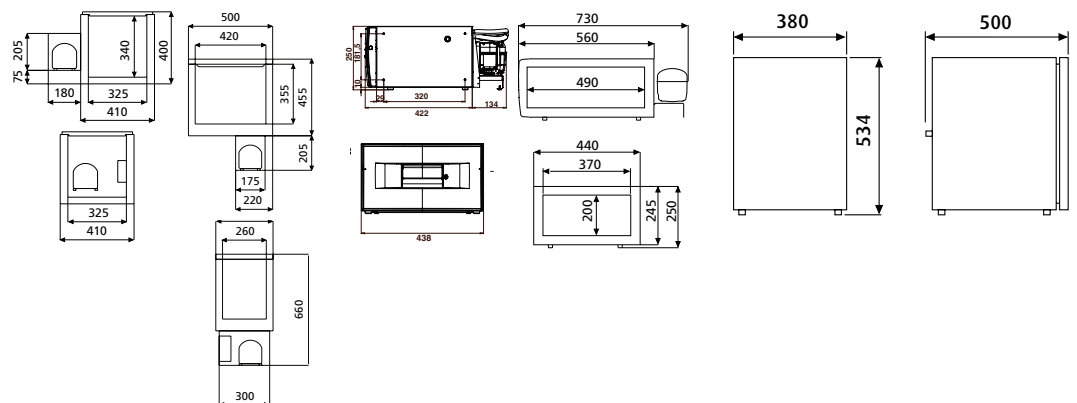

Compressor refrigerators

4.06 // WAECO CoolMatic HDC

4.24 // WAECO CoolMatic CR



	HDC 155FF	HDC 195	HDC 225	HDC 275	CRP 40	CR 50
Ref. No.	9105203894	9105203896	9105203897	9105203898	9105600001	9105303276
Storage volume (approx. l) thereof freezer compartment	117 17	173 41	228 44	277 75	39 5.3	48 5
Energy supply	12/24 V DC	12/24 V DC	12/24 V DC	12/24 V DC	12/24 V DC	12/24 V DC
Average power input (watts, approx.)	36	40	41	61	40	40
Current consumption (Ah/h) at 12 V at +25°C at +32°C ambient temperature, both at +5°C interior temperature	2.1 3.0	2.2 3.4	2.4 3.3	3.3 5.1	1.5 1.8	1.4 1.7
Energy class	-	-	-	-	-	-
Insulation PU foam all around	●	●	●	●	●	●
System	Fully hermetic compressor with integrated control electronics, low-voltage protection/electronic fuse, automatic reverse pole protection, mechanical, continuously variable thermostat					
Material						
Body		Sheet steel			with coated metal frame	
Interior		Polystyrene			Plastic	
Door frame		-			Plastic	
Fittings		-			Stainless steel	
Door		Sheet steel			-	
Colour						
Body		White			Black	
Door frame		White			Silver	
Decor plate		-			Matt-silver (brushed stainless steel appearance)	
Door		-			-	
Weight (kg)	32	33	42	52	18	19
Scope of delivery	2 safety glass shelves, a transparent crisper, door trays	3 safety glass shelves, 2 adjustable in height, a transparent crisper, door trays, shelf rack in froster compartment	4 safety glass shelves, 3 adjustable in height, a transparent crisper, door trays, shelf rack in froster compartment	5 safety glass shelves, 4 adjustable in height, 2 transparent crispers, door trays, 3 drawers for frozen food	-	-
Test marks	e-certified (Automotive EMC Directive)				TÜV/GS, e-certified (Automotive EMC Directive)	
Optional extras						
Mains adapter 110–240 V > 24 V	MPS 50 // 9102600032	MPS 50 // 9102600032	MPS 50 // 9102600032	MPS 80 // 9102600138	MPS 35 // 9103555825	MPS 35 // 9103555825
Standard installation frame	-	-	-	-	9105303880	9105303880
Flush-mount installation frame	-	-	-	-	9105303881	9105303881

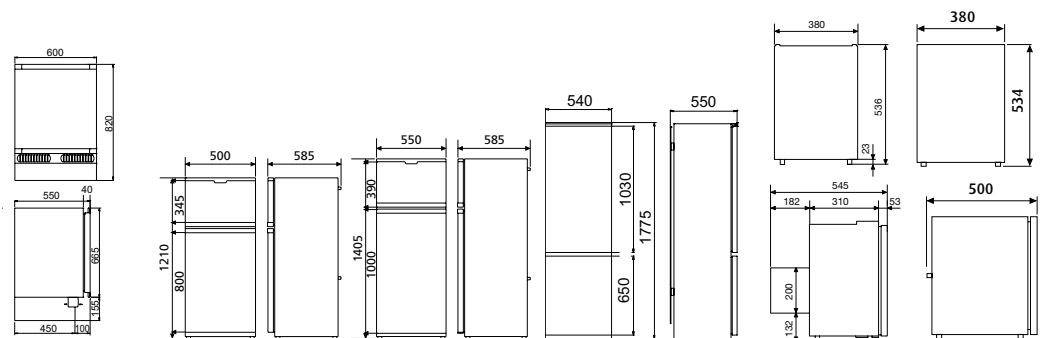

4.24 // WAECO CoolMatic CR



CR 65	CR 80	CR 110	CR 140	CR 50S	CR 65S	CR 80S	CR 110S	CR 140S
9105303288	9105303297	9105303303	9105600002	9105305616	9105305617	9105305618	9105305619	9105305620

64 7.2	80 7,9	108 10.2	136 11.5	48 5	64 7.2	80 7,9	108 10.2	136 11.5
12/24 V DC	12/24 V DC	12/24 V DC	12/24 V DC / 100–240 V AC	12/24 V DC	12/24 V DC	12/24 V DC	12/24 V DC	12/24 V DC / 100–240 V AC
45	48	50	65	40	45	48	50	65

1.6 1.9	1.8 2.1	2.2 2.5	2.3 2.6	1.4 1.7	1.6 1.9	1.8 2.1	2.2 2.5	2.3 2.6
------------	------------	------------	------------	------------	------------	------------	------------	------------

–	–	–	A+	–	–	–	–	A+
---	---	---	----	---	---	---	---	----



Fully hermetic compressor with integrated control electronics, low-voltage protection/electronic fuse, automatic reverse pole protection, mechanical, continuously variable thermostat

with coated metal frame
Plastic
Plastic
Stainless steel
–

with coated metal frame
Plastic
–
Stainless steel
Stainless steel (AISI316)

Black
Silver
Matt-silver (brushed stainless steel appearance)
–
–

Black
–
–
Stainless steel
–

20	23	28	32	19	20	23	28	32
–	–	–	–	–	–	–	–	–

TÜV/GS, e-certified (Automotive EMC Directive)

MPS 35 // 9103555825	MPS 35 // 9103555825	MPS 35 // 9103555825	–	MPS 35 // 9103555825	MPS 35 // 9103555825	MPS 35 // 9103555825	MPS 35 // 9103555825	–
9105303885	9105303891	9105303895	9105900001	9105305676	9105305677	9105305678	9105305679	9105305680
9105303886	9105303892	9105303896	9105900003	9105305671	9105305672	9105305673	9105305674	9105305675

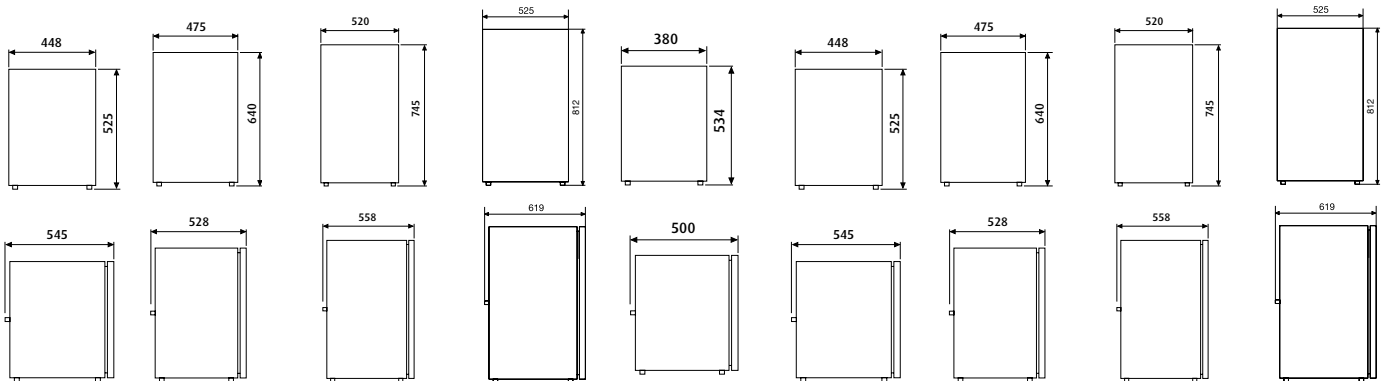

4.07 // WAECO ColdMachine

Cooling units

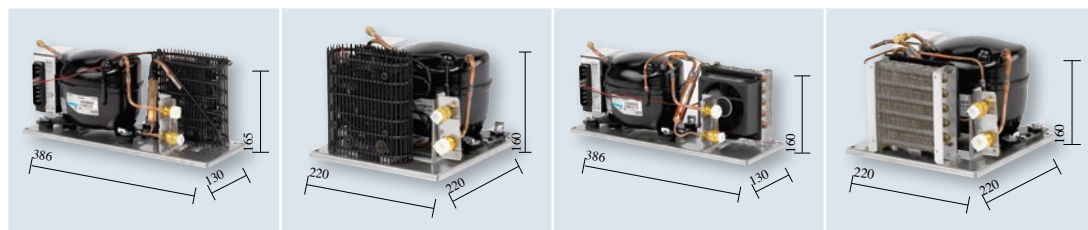

	ColdMachine 54	ColdMachine 55	ColdMachine 84	ColdMachine 85
Ref. No.	9105304106	9105304107	9105304108	9105304110
Cooling capacities (l) normal refrigeration with direct evaporators with cold accumulators deep-freezing	max. 130 max. 100 –	max. 130 max. 100 –	max. 250 – max. 70	max. 250 – max. 70
Voltage	12/24 V DC	12/24 V DC	12/24 V DC	12/24 V DC
Power input (approx. watts) depending on the evaporator type	35 / 40	35 / 40	45 – 60	45 – 60
System Fully hermetic compressor with control electronics and integrated low-voltage protection	•	•	•	•
Fully hermetic high-performance compressor with AEO electronics and integrated low-voltage protection	–	–	–	–
Low-voltage cut-off / electronic reverse pole protection	•	•	•	•
Brushless DC fan	–	–	•	•
Fin condenser	–	–	•	•
Dynamically ventilated wire tube condenser	•	•	–	–
Self-sealing valve couplings	•	•	•	•
Dimensions (W x H x D)	386 x 165 x 130 mm	220 x 160 x 220 mm	386 x 160 x 130 mm	220 x 160 x 220 mm
Weight (kg)	6	6.5	6	6
Quality features	Suitable for floor mounting, corrosion-resistant stainless steel mounting plate		Suitable for floor mounting, corrosion-resistant stainless steel mounting plate	
Accessories				
Air exhaust hood with counterpart and 2 m hose, for providing air circulation	9103540107	9103540107	9103540107	9103540107
Mains adapter, 110 – 240 V · 24 V	MPS 35 // 9103555825	MPS 35 // 9103555825	MPS 35 // 9103555825	MPS 35 // 9103555825
Mains adapter EPS 100, 230 V · 24 V	9102600031	9102600031	9102600031	9102600031

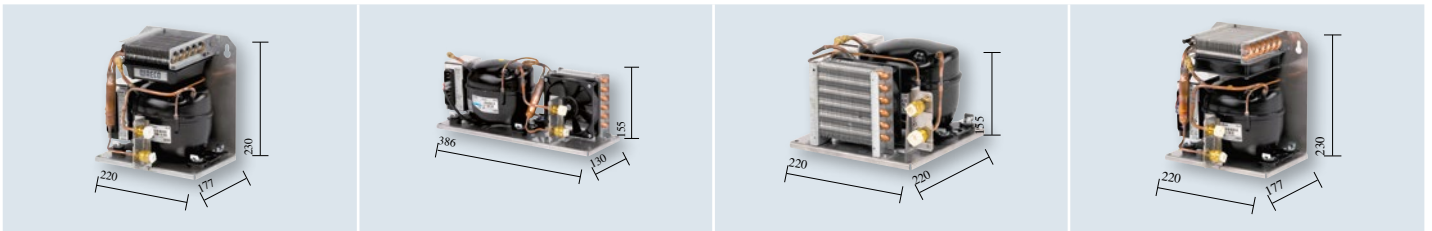

ColdMachine 86	ColdMachine 94	ColdMachine 95	ColdMachine 96
9105304111	9105304112	9105304113	9105304114



max. 250 – max. 70	max. 400 max. 250 max. 200	max. 400 max. 250 max. 200	max. 400 max. 250 max. 200
12/24 V DC	12/24 V DC	12/24 V DC	12/24 V DC
45 – 60	60 – 100	60 – 100	60 – 100

•	–	–	–
–	•	•	•
•	•	•	•
•	•	•	•
•	•	•	•
–	–	–	–
•	•	•	•
220 x 230 x 177 mm	386 x 155 x 130 mm	220 x 155 x 220 mm	220 x 230 x 177 mm
6.5	6	6	6.5
Suitable for floor mounting, corrosion-resistant stainless steel mounting plate	Suitable for floor mounting, corrosion-resistant stainless steel mounting plate, AEO electronics		

9103540107	9103540107	9103540107	9103540107
MPS 35 // 9103555825	MPS 50 // 9102600032	MPS 50 // 9102600032	MPS 50 // 9102600032
9102600031	–	–	–

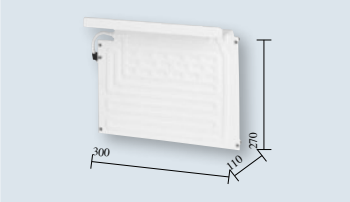
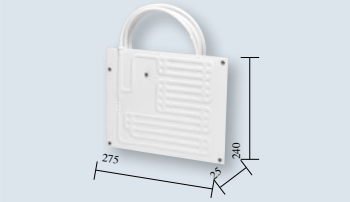

4.07 // WAECO ColdMachine Series 50

Evaporators

			
	L-evaporator VD-01 for Series 50	Plate evaporator VD-02 for Series 50	O-evaporator VD-07 for Series 50
Ref. No.	9105304115	9105304116	9105304121
Cooling capacities (l) with 35 mm PU insulation with 50 mm PU insulation	max. 80 max. 100	max. 30 max. 50	max. 100 max. 130
Power input (approx. watts)	35	35	35
Current consumption (Ah/h) with 35 mm PU insulation with 50 mm PU insulation	1.46 1.17	1.31 1.02	1.46 1.17
System	Standard, L-shape evaporator for horizontal and vertical installation, self-sealing valve couplings, flexible connection pipe approx. 2 m, continuously variable thermostat (for external installation, with blue turning dial and LED indicator, white plastic housing), electric supply cord approx. 3 m	Standard, plate evaporator for horizontal and vertical installation, self-sealing valve couplings, flexible connection pipe approx. 2 m, continuously variable thermostat (for external installation, with blue turning dial and LED indicator, white plastic housing), electric supply cord approx. 3 m	Standard O-evaporator for horizontal or vertical installation, self-sealing valve couplings, flexible connection pipe approx. 2 m, continuously variable thermostat (for external installation, with blue turning dial and LED indicator, white plastic housing), electric supply cord approx. 3 m
Dimensions (W x H x D)	300 x 270 x 110 mm	275 x 240 x 25 mm	255 x 210 x 90 mm
Weight (kg)	1.5	1	1.5

4.07 // WAECO ColdMachine Series 80

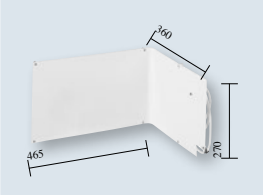
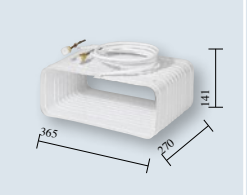
Evaporators

				
	Angle evaporator VD-08 for Series 80	O-evaporator VD-09 for Series 80	Circulating air evaporator VD-15 for Series 80	Circulating air evaporator VD-14N for Series 90
Ref. No.	9105304122	9105304123	9105304126	9105304125
Cooling capacities (l) with 35 mm PU insulation with 50 mm PU insulation	max. 160 max. 180	max. 160 max. 180	max. 200 max. 250	max. 300 max. 400
Power input (approx. watts)	60	60	60	80
Current consumption (Ah/h) with 35 mm PU insulation with 50 mm PU insulation	2.50 2.00	2.25 1.75	2.00 1.50	3.33 2.33
System	Standard angle evaporator, self-sealing valve couplings, flexible connection pipe approx. 2 m, continuously variable thermostat (for external installation, with blue turning dial and LED indicator, white plastic housing), electric supply cord approx. 3 m	O-evaporator for vertical and horizontal installation, self-sealing valve couplings, flexible connection pipe approx. 2 m, continuously variable thermostat (for external installation, with blue turning dial and LED indicator, white plastic housing), electric supply cord approx. 3 m	High-performance circulating air evaporator in a white plastic housing, with brushless fan, fast cooling through circulating air operation, self-sealing valve couplings, flexible connection pipe approx. 2.5 m, continuously variable thermostat integrated in the evaporator housing	High-performance circulating air evaporator, especially effective due to enlarged surface area. Radial fan with enhanced ventilation capacity, continuously variable room thermostat for optimal temperature distribution in the refrigeration compartment. Ease of installation with self-sealing valve couplings and flexible connection pipe (approx. 2.5 m). Sturdy, white plastic housing.
Dimensions (W x H x D)	465 x 270 x 360 mm	365 x 141 x 270 mm	220 x 275 x 80 mm	250 x 310 x 90 mm
Weight (kg)	2.0	2.0	2.0	2.0

4.07 // WAECO ColdMachine Series 90

4.07 // WAECO ColdMachine Series 80

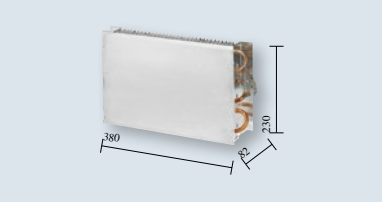
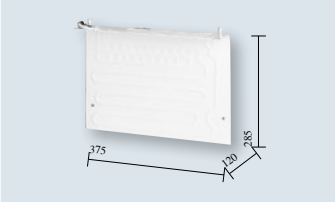
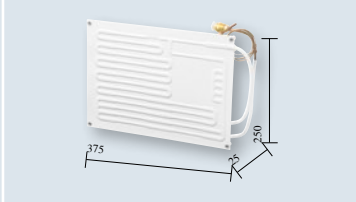
			
Fin evaporator VD-03 for Series 80	L-evaporator VD-04 for Series 80	Plate evaporator VD-05 for Series 80	Plate evaporator VD-18 for Series 80
9105304117	9105304118	9105304119	9105304129
max. 170 max. 200	max. 130 max. 170	max. 130 max. 170	max. 100 max. 150
50	45	45	45
1.88 1.46	1.88 1.50	1.88 1.50	1.88 1.50
Copper-aluminium fin evaporator with large surface due to the cooling fins, for vertical and horizontal installation, self-sealing valve couplings, flexible connection pipe approx. 2.5 m, continuously variable thermostat (for external installation, with blue turning dial and LED indicator, white plastic housing), electric supply cord approx. 3 m	Standard, L-shape evaporator, self-sealing valve couplings, flexible connection pipe approx. 2 m, continuously variable thermostat (for external installation, with blue turning dial and LED indicator, white plastic housing), electric supply cord approx. 3 m	Standard plate evaporator, self-sealing valve couplings, flexible connection pipe approx. 2 m, continuously variable thermostat (for external installation, with blue turning dial and LED indicator, white plastic housing), electric supply cord approx. 3 m	Standard plate evaporator, self-sealing valve couplings, flexible connection pipe approx. 2 m, continuously variable thermostat (for external installation, with blue turning dial and LED indicator, white plastic housing), electric supply cord approx. 3 m
380 x 230 x 82 mm	375 x 285 x 120 mm	375 x 350 x 25 mm	375 x 250 x 25 mm
2	1.5	1.5	1.5

4.07 // WAECO ColdMachine Series 90

Evaporators

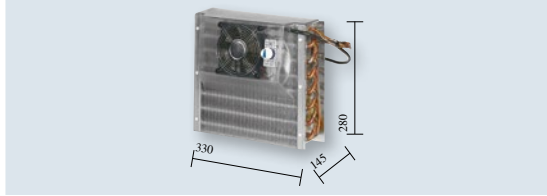
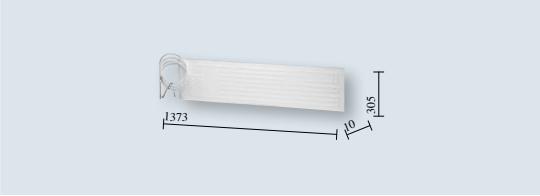
		
	Air circulating deep-freeze evaporator VD-16 for Series 90	Plate evaporator VD-21 for Series 90
Ref. No.	9105304128	9105304130
Cooling capacities (l) with 50 mm PU insulation with 100 mm PU insulation	max. 130 max. 200	max. 250 (normal refrigeration) / 100 (deep-freezing) max. 300 (normal refrigeration) / 150 (deep-freezing)
Power input (approx. watts)	60	60
Current consumption (Ah/h) with 50 mm PU insulation with 100 mm PU insulation	2.75 2.00	2.50 normal (refrigeration) / 3.00 (deep-freezing) 2.00 normal (refrigeration) / 2.00 (deep-freezing)
System	High-performance air circulating fin evaporator in a transparent plastic housing, self-sealing valve couplings, flexible connection pipe approx. 2.5 m, continuously variable deep-freeze thermostat integrated in the evaporator housing	Standard plate evaporator with large surface, self-sealing valve couplings, flexible connection pipe approx. 2 m, continuously variable thermostat (for external installation, with blue turning knob and LED indicator, white plastic housing), for refrigeration and deep-freezing
Dimensions (W x H x D)	330 x 280 x 145 mm	1373 x 305 x 10 mm
Weight (kg)	2.5	4.0

4.07 // WAECO ColdMachine

Cold accumulators



	Cold accumulator VD-06 for Series 80	Cold accumulator VD-06 for Series 90
Ref. No.	9105304120	9105304120
Cooling capacities (l) with 35 mm PU insulation with 50 mm PU insulation	max. 120 max. 200	max. 200 max. 250
Power input (approx. watts)	65	80
Battery load	At one charge/discharge cycle per day = 10 watts/hour	At one charge/discharge cycle per day = 10 watts/hour
Charging time	approx. 1.5 hours	approx. 1.5 hours
Discharging time	8 to 18 hours (without compressor operation)	8 to 18 hours (without compressor operation)
System	Stainless steel cold accumulator with integrated high-performance fin evaporator, self-sealing valve couplings, continuously variable with TEC electronic controller	Stainless steel cold accumulator with integrated high-performance fin evaporator, self-sealing valve couplings, continuously variable with TEC electronic controller
Pipe length (m)	2.5	2.5
Dimensions (WxHxD) TEC electronic controller	380 x 300 x 62 mm 86 x 170 x 45 mm	380 x 300 x 62 mm 86 x 170 x 45 mm
Weight (kg)	5	5

Compact cooling unit



Compact cooling unit CS-NC15

Ref. No.	9105304104
Cooling capacities (l) with 35 mm PU insulation with 50 mm PU insulation	max. 200 max. 250
Voltage	12/24 V DC
Power input (approx. watts)	60
Current consumption (Ah/h) with 35 mm PU insulation with 50 mm PU insulation	2.00 1.50
System	Fully hermetic compressor with control electronics and integrated low-voltage protection, low-voltage cut-off, electronic reverse pole protection, brushless DC fan, fin condenser, high-performance air circulating fin evaporator in white plastic housing with brushless fan, rapid chill capability with circulating air operation
Weight (kg)	8.5
Colour	White
Quality features	Rapid-chill capability with circulating air operation, continuously variable thermostat (integrated in the evaporator housing), low-voltage protection, low-voltage cut-off

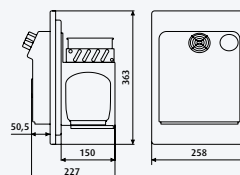

Electronic accessories for coolers and refrigerators

3.17 // WAECO CoolPower



	CoolPower M 50U	CoolPower 804 K	CoolPower EPS 817
	Voltage monitor for 12-volt applications	Voltage converter 24 volts > 12 volts	Mains adapter for connecting thermoelectric 12-volt cooling appliances
Ref. No.	9105303854	9103555790	9102600030
Cut-off voltage	11.6 V DC	-	-
Cut-in voltage	12.8 V DC	-	-
Current	5 amps max.	-	-
Input voltage	-	20 – 30 V DC	230 V AC/50 Hz
Output voltage	-	12.5 V DC ±10 %	13 V DC
Efficiency	-	max. 90 %	max. 90 %
Short-time load	-	6 A/70 watts	-
Continuous load	-	4 A/48 watts	6 A
No-load current input max.	-	60 mA	60 mA
Dimensions (WxHxD)	-	53 x 45 x 120 mm	115 x 65 x 170 mm
Weight (kg)	-	0.25	0.6
Quality features	LED display, ready for connection with cigarette lighter plug	Energy-saving switch mode design with connection socket	-
Test mark	e-certified (Automotive EMC Directive)	e-certified (Automotive EMC Directive)	GS



	CoolPower EPS 100	CoolPower MPS 35	CoolPower MPS 50	CoolPower MPS 80
	Mains adapter for connection of 12-/24-volt compressor cooling appliances to the 230-volt mains.	Mains adapter for connection of 12-/24-volt compressor cooling appliances to 110 – 240-volt mains systems.	Mains adapter for connection of 12-/24-volt compressor cooling appliances to 110 – 240-volt mains systems.	Mains adapter for connection of 12-/24-volt compressor cooling appliances to 110 – 240-volt mains systems.
Ref. No.	9102600031	9103555825	9102600032	9102600138
Input voltage	230 V AC	110 – 240 V AC	110 – 240 V AC	110 – 240 V AC
Output voltage	25 V DC	25 V DC	27 V DC	27 V DC
Output power	100 watts	75 watts	150 watts	180 W
Battery voltage	12/24 V DC	12/24 V DC	12/24 V DC	12/24 V DC
Output current	4 A	3 A	6 A	8 A
Dimensions (WxHxD)	115 x 65 x 170 mm	115 x 55 x 160 mm	120 x 70 x 200 mm	120 x 70 x 200 mm
Weight (kg)	approx. 0.7	approx. 0.75	approx. 1	approx. 1.2
Test mark	-	GS	-	-

3.16 // WAECO PerfectCharge

IU0U-
Automatic chargers

	MCA 1215	MCA 1225	MCA 1235	MCA 1250	MCA 1280
Ref. No.	9102500027	9102500028	9102500029	9102500030	9102500031
Ref. No. UK	9102500046	9102500047	9102500048	9102500049	9102500050
Charge outputs	1 + 1	2 + 1	2 + 1	3	3
Input voltage (V)	90 – 260				
Output voltage (V)	–	–	–	–	–
Frequency (Hz)	50 – 60				
End-of-charging voltage (V)	14,4/14,7				
Float charging voltage (V)	13,8				
Recommended battery capacity (Ah)	40 – 170	75 – 300	100 – 400	150 – 600	200 – 800
U0 phase limited at (h)	8 or 16				
Energy efficiency up to (%)	92				
Charging current (A)	15	25	35	50	80
Operating temperature (°C)	–20 to +50				
Dimensions (W x H x D, mm)	179 x 63 x 238	179 x 63 x 238	179 x 63 x 274	208.5 x 75 x 283	208.5 x 75 x 303
Weight (kg)	1.6	1.7	1.9	3.1	4
6-stage charging characteristics	•	•	•	•	•
Overload/short-circuit protection	•	•	•	•	•
Sleep mode	Using the remote control or dip switch on the device				
Battery types	Lead-acid batteries (liquid, gel, AGM)				
Test mark	–	–	–	–	–
Type of protection	equivalent to IP 21				
Optional extras					
Temperature sensor MCA-TS1	9102500036	9102500036	9102500036	9102500036	9102500036
Remote control MCA-RC1	9102500037	9102500037	9102500037	9102500037	9102500037
Controller MPC 01	9102500073	9102500073	9102500073	9102500073	9102500073
Hella sensor MCA-HS1	9102500038	9102500038	9102500038	9102500038	9102500038

3.16 // WAECO PerfectCharge Charging converters

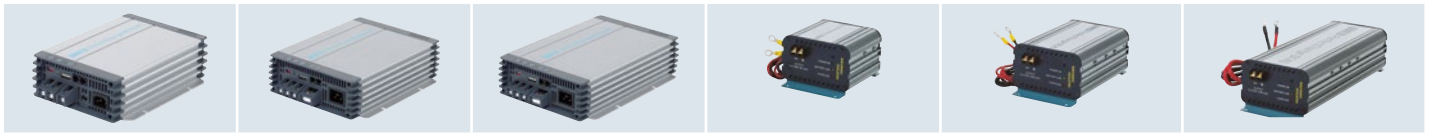







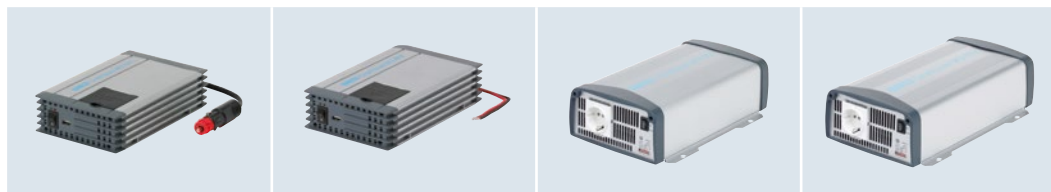







MCA 2415	MCA 2425	MCA 2440	DC 08	DC 20	DC 40
9102500032	9102500033	9102500034	9102500055	9102500045	9102500056
9102500051	9102500052	9102500053			
2	3	3	-	-	-
	90 – 260			12 (8 – 16)	
-	-	-		14.2 ±0.1	
	50 – 60		-	-	-
	28.8 / 29.4		-	-	-
	27.6		-	-	-
40 – 170	75 – 300	100 – 400	-	-	-
	8 or 16		-	-	-
	92			87	
12.5	25	40	8	20	40
	-20 to +50		-	-	-
179 x 63 x 238	208.5 x 75 x 283	208.5 x 75 x 303	115 x 70 x 100	115 x 70 x 160	115 x 70 x 270
1.6	2.9	3.9	0.75	1.2	2.1
•	•	•	-	-	-
•	•	•	-	-	-
Using the remote control or dip switch on the device			-	-	-
Lead-acid batteries (liquid, gel, AGM)			-	-	-
-	-	-	e-certified (Automotive EMC Directive)		
	equivalent to IP 21		-	-	-
9102500036	9102500036	9102500036	-	-	-
9102500037	9102500037	9102500037	-	-	-
-	-	-	-	-	-
-	-	-	-	-	-

3.30 // WAECO SinePower

Sine wave inverters









	MSI 212 / MSI 224	MSI 412 / MSI 424	MSI 912 / MSI 924	MSI 1312 / MSI 1324
Ref. No.	9102600124 9102600125	9102600126 9102600127	9102600111 9102600112	9102600113 9102600114
Ref. No. UK	9102600139 9102600140	9102600141 9102600142	9102600033 9102600034	9102600035 9102600036
Input voltage (V DC)	12 (11 – 15 V) 24 (22 – 30 V)	12 (11 – 15 V) 24 (22 – 30 V)	12 (10,5 – 16 V) 24 (21 – 32 V)	12 (10,5 – 16 V) 24 (21 – 32 V)
Output voltage (V AC)/ shape	230 / pure sine wave 	230 / pure sine wave 	230 / pure sine wave 	230 / pure sine wave 
Output frequency (Hz)	50	50	50	50
No-load current input (A)	0.6 / 0.5	0.6 / 0.5	1.8 / 1.0	2.1 / 1.1
Standby current consumption (A)	–	–	0,5 / 0,3	0,5 / 0,3
Continuous output (watts)	150	350	900	1300
Peak power (watts)	300	700	1600	2400
Energy efficiency up to (%)	90	90	92	92
Dimensions (W x H x D, mm)	124 x 49 x 199	124 x 49 x 199	197.5 x 94.3 x 291	197.5 x 94.3 x 324.6
Weight (kg, approx.)	0.82	0.82	3	4
Integrated mains priority circuit with voltage synchronisation	–	–	–	–
Test mark	e-certified (Automotive EMC Directive)			
Type of protection	equivalent to IP 21			
Optional extras				
DC connection cable	–	–	9102700001	9102700002
Standard remote control MCR-9	–	–	9102600026	9102600026
Convenience remote control MCR-7	–	–	9102600001	9102600001
Mains priority circuit VS-230	–	–	9103556043	9103556043

				3.29 // WAECO PocketPower Smart inverter	3.29 // WAECO PocketPower Laptop Charger
					
MSI 1812 / MSI 1824	MSI 1812T / MSI 1824T	MSI 2312T / MSI 2324T	MSI 3512T / MSI 3524T	SI 102	PocketPower LC
9102600115 9102600116	9102600117 9102600118	9102600119 9102600120	9102600121 9102600122	9105303816	9102500022
9102600037 9102600038	9102600039 9102600040	9102600041 9102600042	9102600043 9102600044		
12 V (10,5 – 16 V) 24 (21 – 32 V)	12 (10,5 – 16 V) 24 (21 – 32 V)	12 (10 – 16 V) 24 (20 – 32 V)	12 (10 – 16 V) 24 (20 – 32 V)	12 (11 – 15 V)	12 – 24, 10 A max
230 / pure sine wave 	230 / pure sine wave 	230 / pure sine wave 	230 / pure sine wave 	230 / modified sine wave 	12 V / 15 V / 16 V / 18 V (18.5 V) / 19 V (19.5 V) / 20 V / 24 V DC
50	50	50	50	50	–
2.1 / 1.1	2.1 / 1.1	3.1 / 1.5	2.7 / 1.3	< 0.4	–
0,5 / 0,3	0,5 / 0,3	1,1 / 0,7	1,1 / 0,7	–	–
1800	1800	2300	3500	100	90
3200	3200	4000	6000	200	–
92	92	92	92	90	–
197.5 x 94.3 x 376	197.5 x 94.3 x 406	283 x 128.4 x 436	283 x 128.4 x 496	67 x 43 x 125	124.8 x 50 x 31.5
5	6.5	7.5	9	0.282	0.255
–	•	•	•	–	–
e-certified (Automotive EMC Directive)				e-certified (Automotive EMC Directive)	
equivalent to IP 21				–	–

9102700002	9102700002	9102700004	on request	–	–
9102600026	9102600026	9102600026	9102600026	–	–
9102600001	9102600001	9102600001	9102600001	–	–
–	–	–	–	–	–

3.18 // WAECO PerfectPower



Inverters with modified AC voltage

					
	PP 152 / PP 154	PP 402 / PP 404	PP 602 / PP 604	PP 1002 / P 1004	PP 2002 / PP 2004
Ref. No.	9105303791 / 9105303794	9105303796 / 9105303799	9105303801 / 9105303804	9102600002 / 9102600028	9102600027 / 9102600029
Ref. No. UK	9105303792 / 9105303795	9105303797 / 9105303800	9105303802 / 9105303805	9102600003 / 9102600004	9102600005 / 9102600006
Input voltage (V DC)	12 (11 – 15 V) / 24 (22 – 30 V)				
Output voltage/curve (V AC)	230 / modified sine wave \square _r				
Output frequency (Hz)	50	50	50	50	50
No-load input current (A)	0.25	0.25	0.25	< 0.8	< 1.5
Continuous power (W)	150	350	550	1000	2000
Peak output (W)	350	700	1100	2000	4000
Cooling	Ventilator				
Energy efficiency up to (%)	90	90	90	85	85
Mains priority circuit	–	–	–	•	•
Dimensions (W x H x D, mm)	129 x 71 x 177	129 x 71 x 192	129 x 71 x 237	176 x 95 x 338	176 x 95 x 443
Weight (approx. kg)	0.84	0.99	1.4	3.5	5
Test marks	e-certified (Automotive EMC Directive)				
Type of protection	Equivalent to IP 21				
 Optional extras					
DC connection cable	–	–	–	9102700005	9102700006
Standard remote control MCR-9	–	–	–	9102600026	9102600026

IU0U charger / Battery care





3.16 // WAECO PerfectCharge

3.28 // WAECO PerfectBattery

			
	IU812	BC 100	BR 12
Ref. No.	9103555791	9102500044	Ref. No. 9103556045
Input voltage (V AC)	230 (180 – 253 V)	230 (180 – 253 V)	Battery voltage (V DC) 12
Input frequency (Hz)	50 – 60	50 – 60	Cut-in voltage (V) > 12.6 ± 0.2
Battery connections	1	1	Stand-by current (mA) < 0.2
End-of-charging voltage (V DC)	14.4	13.8	Dimensions (W x H x D, mm) 100 x 67 x 25
Float charging voltage	13.6	13.0	Weight (kg) 0.12
Charging indicator	–	3 LEDs	Test mark e-certified (Automotive EMC Directive)
Maximum battery capacity (Ah)	100	–	
Maximum charging current (A)	8	1.0	
Charging curve	IU0U with limited IU0 phase	–	
Operating temperature (°C)	–20 to +50	–20 to +50	
Dimensions (W x H x D, mm)	120 x 70 x 200	70 x 100 x 60	
Weight (approx. kg)	0.9	0.45	
Quality features	Overload and short-circuit protection		

3.18 // WAECO PerfectPower

Voltage converters

					
	DCDC 10	DCDC 20	DCDC 10	DCDC 20	DCDC 40
Ref. No.	9102500057	9102500058	9102500061	9102500059	9102500060
Input voltage (V DC)	12	12	24	24	24
Input voltage range (V DC)	8 to 16	8 to 16	20 to 32	20 to 32	20 to 32
Output current (A)	10	20	10	20	40
Output voltage (V)	27.6 ±0.1	27.6 ±0.1	27.6 ±0.1	13.8 ±0.1	13.8 ±0.1
Energy efficiency (%)	87	87	87	87	87
Ripple & Noise (mA)	40	40	40	20	20
Dimensions (W x H x D, mm)	115 x 70 x 155	115 x 70 x 240	115 x 70 x 140	115 x 70 x 155	115 x 70 x 240
Weight (kg)	1.2	1.9	1	1.2	1.9
Test mark	e-certified (Automotive EMC Directive)				

3.30 // WAECO CombiPower

Sine wave inverter with integrated automatic battery charger



	2012 / 2024
Ref. No.	9102600104 (12 V) / 9102600105 (24 V)
Dimensions (W X H X D)	490 x 145 x 285 mm
Weight (approx. kg)	14
Test marks	e-certified (Automotive EMC Directive)
Type of protection	Equivalent to IP 21
Technical data inverter	
Input voltage (V DC)	12 (10 – 16 V) 24 (20 – 32 V)
Output voltage/curve (V AC)	230 / pure sine wave \sim
Output frequency (Hz)	50/60
Continuous power (W)	2000
Peak output (W, 3 sec)	3000
Transfer power (V / A)	230 / 50
Transfer time	< 10 msec.
Technical data automatic battery charger	
Charging characteristic	IU0U 6-step
Input voltage range (V AC)	207 – 253
Frequency range (Hz)	47 – 63
Adjustable charging current (A)	30 – 100 (12 V) / 15 – 50 (24 V)
End-of-charging voltage (V DC)	14.4 – 14.7 (12 V) / 28.8 – 29.4 (24 V)
Float charging voltage (V DC)	13.6 (12 V) / 27.2 (24 V)
Second charger output (starter battery, A)	5
Cooling	Speed controlled fans

Generator

3.39 // Dometic BLUTEC

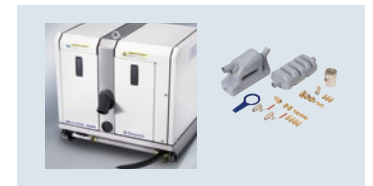

	BLUTEC 40D
Ref. No.	9102900202
Output voltage / curve	230 V AC ± 10% (continuous) / pure sine voltage \sim
Total distortion factor	1%
Frequency (Hz)	50 ± 1%
Max. starting current (A)	45
Continuous power (W)	3500
Peak output (W)	4000
Engine output (kW)	4.5 (6.1 PS)
Fuel	Diesel
Consumption (l/h)	max. 1.3
Noise level	54 dBA
Insulation class	H
Oil capacity (l)	1.1
Dimensions (W x H x D)	570 x 528 x 406 mm
Weight (kg)	85
Quality features	Remote control, noise-insulated stainless steel housing, additional 12-volt output for DC appliances and battery charging, automatic low-oil cut-off, protected against overload and short circuit
 Essential accessory	
Installation kit	9102900035

3.33 / 3.32 // Alcohol stoves – free-standing

3.32 // Alcohol oven /stove

Stoves



	ORIGO 5100	ORIGO ONE	ORIGO TWO	ORIGO 6000
Ref. No.	9103303920	9103303977	9103303978	9103303922
Heater coil voltage	–	–	–	–
Heater coil output	–	–	–	–
Oven output	–	–	–	1500 W
Oven capacity	–	–	–	22 litres
Burning time	approx. 5 hours	approx. 4.5 hours	approx. 4.5 hours	approx. 4.5 hours
Number of burners	1	1	2	Stove 2 / oven 1
Burner capacity	1500 W	2000 W	2000 W per burner	2000 W per burner
Boiling time (in minutes for 1 litre of water)	15	10	10	10
Tank capacity (litres per tank)	1.2	1.2	1.2	1.2
Dimensions (W x H x D) incl. gimbals	285 x 150 – 285 mm	237 x 165 x 300 mm	464 x 165 x 300 mm	465 x 562 x 335 mm
Built-in dimensions (W x H x D)	–	273 x 228 x 300 mm	500 x 228 x 300 mm	–
Weight (kg)	2.5	2.9	5.8	28.8
Optional extras				
Potholder	–	9103303828	9103303828	9103303980
Cutting board	–	9103303829	9103303829	9103303985
Glass lid	–	–	–	–
Fuel tank	9103303994	–	–	9103303993
Rubber gasket	–	–	–	–
Flame spreader	–	–	–	–
Gimbal	–	9103303827	9103303827	–

3.32 // Alcohol stoves, built-in



ORIGO 2000	ORIGO 4100	ORIGO A100	ORIGO A200
9103303884	9103303890	9103303935	9103303937
-	-	-	-
-	-	-	-
-	-	-	-
-	-	-	-
approx. 4.5 hours	approx. 4.5 hours	approx. 4.5 hours	approx. 4.5 hours
1	2	1	2
2000 W	2000 W per burner	2000 W	2000 W per burner
10	10	10	10
1.2	1.2	1.2	1.2
396 x 150 x 377 mm	623 x 150 x 377 mm	270 x 160 x 365 mm	500 x 160 x 365 mm
-	-	-	-
345 x 140 x 325 mm	575 x 140 x 325 mm	255 x 150 x 340 mm	485 x 150 x 340 mm
5.8	8	3.5	7
9103303981	9103303981	9103303982	9103303982
9103303987	9103303986	-	-
9103303990	9103303989	9103303992	9103303991
9103303993	9103303993	9103303993	9103303993
9103303995	9103303995	-	-
9103303996	9103303996	-	-
-	-	-	-

Cooker / oven combinations / Ovens

3.37 // Cooker / oven combinations



	SunLight	StarLight
Ref. No.	9103303823	9103303822
Voltage (electronic 12-volt ignition)	–	–
Oven output	1.1 kW	1.1 kW
Gas consumption oven	80 g/h	80 g/h
Grill output	–	1.3 kW
Gas consumption grill	–	100 g/h
Cooker output	1 x 2.2 kW; 1 x 1.8 kW	1 x 2.2 kW; 1 x 1.8 kW
Gas consumption cooker	291 g/h	291 g/h
Gas supply pressure	30 mbar	30 mbar
Number of burners	2	2
Oven capacity (litres)	28	28
Dimensions (W x H x D, mm) incl. semi-gimbal suspension	448.6 x 397.5 x 356.9	448.6 x 507.5 x 356.9
Built-in dimensions (W x H x D)	475 x 429.5 x 356.9	475 x 539.5 x 356.9
Weight (kg)	20	23
Optional extras		
Grill pan	–	9103303862

3.38 // Dometic gas cooker

Stoves



	PI2232M	PI8062M	PI8063M
Ref. No.	9102300032	9102300008	9102300009
Voltage	–	12 V DC (with electric ignition)	12 V DC (with electric ignition)
Power rating	1 x 1 kW; 1 x 1.8 kW	1 x 1 kW; 1 x 1.8 kW	1 x 1 kW; 2 x 1.8 kW
Number of burners	2	2	3
Gas consumption	204 g/h	204 g/h	335 g/h
Gas supply pressure	30 mbar	30 mbar	30 mbar
Quality features	Detachable chromed pan support, stainless steel burner lid, safety ignition system, Piezo ignition, rubber seal, potholder	Heat-resistant safety glass lid, detachable chromed pan support, stainless steel burner caps, safety ignition system, recessed controls, electronic 12-volt ignition, AC 540 siphon, rubber seal, potholder	
Dimensions (W x H x D)	380 x 90 x 280 mm	480 x 90.5 x 370 mm	560 x 90.5 x 440 mm
Built-in dimensions (W x D)	–	466 x 358 mm	546 x 428 mm
Weight (kg)	1.7	3.6	5.2
Optional extras			
Gimbal			

3.38 // Cooker / oven combinations

3.38 // Ovens



MoonLight TWO 9103303824	MoonLight THREE 9103303825	FO211GT 9102302150	FO311GT 9102302151
•	•	•	•
1.2 kW	1.2 kW	1.2 kW	1.2 kW
87 g/h	87 g/h	87 g/h	87 g/h
1.6 kW	1.6 kW	1.6 kW	1.6 kW
116 g/h	116 g/h	116 g/h	116 g/h
1 x 2.2 kW; 1 x 1.8 kW	1 x 2.2 kW; 1 x 1.8 kW, 1 x 1 kW		
291 g/h	364 g/h	160 + 131 g/h	160 + 131 g/h
30 mbar	30 mbar	30 mbar	30 mbar
2	3	–	–
28	30	20	30
500 x 390 x 395 525 x 457 x 395	473 x 435,4 x 470 501 x 500 x 470	530 x 310 x 410 mm – 504 x 283 x 460 mm	530 x 430 x 415 mm – 500 x 410 x 460 mm
–	–	–	–
20	21	13.2	19.5
–	–		

3.37 // Dometic gas cooker

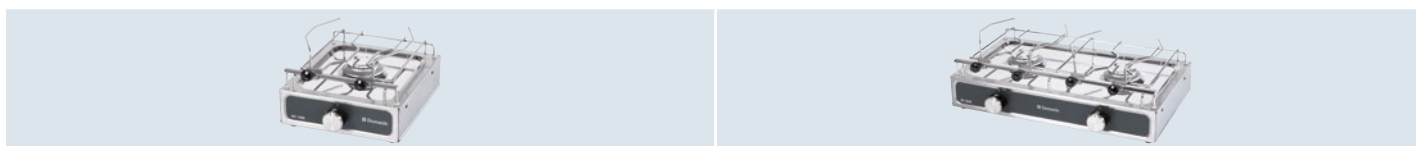

EK 1600 9103300517	EK 3200 9103300518
–	–
1.6 kW	2 x 1.6 kW
1	2
115 g/h	230 g/h
30 mbar	30 mbar
1 pair of adjustable potholders, heat shields, safety ignition system	2 pair of adjustable potholders, heat shields, safety ignition system
281 x 245.7 x 262 mm (with gimbals) 237 x 71.1 x 262 mm (without gimbals)	508 x 245.7 x 262 mm (with gimbals) 464 x 71.1 x 262mm (without gimbals)
–	–
2.9	4.2

9103303826

9103303826

3.38 // Built-in hob/sink combinations

Built-in hob/sink combinations

	MO917R / MO917L	MO927R / MO927L
Ref. No.	MO917R 9102300046 (sink right) MO917L 9102300045 (sink left)	MO927R 9102300050 (sink right) MO927L 9102300049 (sink left)
Voltage	–	–
Power rating	1 x 1 kW; 1 x 1.8 kW	1 x 1 kW; 1 x 1.8 kW
Gas consumption	204 g/h	204 g/h
Gas supply pressure	30 mbar	30 mbar
Number of burners	2	2
Quality features	Detachable chrome pot grid, enamelled burner caps, safety ignition system, AC 540 siphon, rubber seal	
Dimensions (W x H x D)	600 x 120 x 420 mm	490 x 120 x 460 mm
Built-in dimensions (W x D)	566 x 386 mm	456 x 426 mm
Weight (kg)	2.5	2.5
Optional extras		
Tap AC 539 (Plastic, colour: chrome)	9102300076	9102300076
Tap AC 537 (Brass, colour: chrome)	9102300077	9102300077

3.38 // Grill

3.36 // Dometic CK 2000

Grill / Cooker hood /
Electric kettle /
Coffee maker



	PI7093	CK 2000
Ref. No.	9102302153	9107300002
Voltage	230 V AC	12 V DC
Capacity	–	38/45 m ³ /h
Heating capacity	2.4 kW	–
Power consumption	–	5 W
Colour	–	–
Dimensions (W x H x D)	533.4 x 101.6 x 304.8 mm	400 x 56 x 280 mm
Built-in dimensions (W x D)	501.7 x 295.3 mm	–
Weight (kg)	6.0	2.2
Quality features	–	Two integrated halogen lights (2 x 10 W, GU4), 2-level lighting, washable metal grease filter, exchangeable carbon filter, two-speed fan
Test marks	–	–
Scope of delivery	–	–
Optional extras		
Active carbon filter (2-pack)	–	9107300007

3.38 // Built-in sinks with glass lid

		
VA7306FP	VA8005	VA8006
9102300030	9102300027	9102300028
-	-	-
-	-	-
-	-	-
-	-	-
Heat-resistant safety glass lid, AC 540 siphon, rubber seal, with hole for tap (Ø 39 mm)		
(Ø x H): 420 x 148 mm	420 x 145 x 370 mm 405 x 355 mm	420 x 145 x 440 mm 405 x 425 mm
3.5	2.7	3.4
9102300076	9102300076	9102300076
-	-	-

3.14 // WAECO PerfectKitchen



3.13 // WAECO PerfectCoffee

	
MCK750	MC052 / 054
9103533003 (12 V) 9103533004 (24 V)	9103533013 (12 V) 9103533014 (24 V)
12 or 24 V DC	12 or 24 V DC
approx. 0.75 litres	5 cups (625 ml)
12 V: 200 W 24 V: 380 W	12 V: 200 W 24 V: 300 W
Black/silver	Black/silver
190 x 205 x 125 mm (incl. fixing kit)	240 x 270 x 155 mm (incl. fixing kit)
0.8	1.1
Robust relay technology, switches off automatically when the boiling temperature has been reached, or when there's no water in the kettle, status indication	Swing filter can be turned for easier use, integrated transport securing device for glass pot, hotplate with thermostat, fixing kit for wall or desk mounting
E-certified (Automotive EMC Directive), complies with the German Foodstuff and Consumer Goods Act (LMBG)	
Fixing kit for wall or desk mounting	Glass pot, fixing kit for wall or desk mounting

Mobile kitchen solutions



7.04 // MasterFlush 7000 series

Macerator Toilets

			
	MF7160	MF7120	MF7260 / MF7220
Ref. No.	9108833973 (12 V DC) 9108833974 (24 V DC)	9108833970 (12 V DC) 9108833972 (24 V DC)	9108834285 (Sea water) 9108834283 (Fresh water)
Voltage	12 V DC or 24 V DC	12 V DC or 24 V DC	12 V DC
Current consumption	20 A / 12 V DC; 10 A / 24 V DC	20 A / 12 V DC; 10 A / 24 V DC	20 A
Fuse	25 A / 12 V DC; 15 A / 24 V DC	25 A / 12 V DC; 15 A / 24 V DC	25 A
Wiring	2 mm (up to 7.6 m total circuit) Consult ABYC guidelines for additional information	2 mm (up to 7.6 m total circuit) Consult ABYC guidelines for additional information	2 mm (up to 7.6 m total circuit) Consult ABYC guidelines for additional information
Water supply	Sea water	Fresh water	9108834285: Sea water 9108834283: Fresh water
Material	Seat: wood, bowl: ceramic	Seat: wood, bowl: ceramic	Seat: wood, bowl: ceramic
Colour	White	White	White
Dimensions (WxHxD, mm)	381 x 375 x 483	381 x 375 x 483	337 x 368 x 476
Weight (kg)	15.9	15.9	15.9
Quality features	360° omnidirectional rotating base, efficient stainless steel macerator, integrated electric water valve		
Accessories			
Triple switch, DFST for all freshwater models	–	9108559126	9108559126
Dometic Flush Switch Panel			

7.04 // VacuFlush 5000 series







Vacuum toilets

			
	5006	5009	5048
Ref. No.	9108554828	9108554833	9108554839
Model	Low profile	Standard height	Standard height
Voltage	12/24 V DC	12/24 V DC	12/24 V DC
Current consumption	–	–	–
Fuse	–	–	–
Vacuum pump*	6 A (12 V DC); 3 A (24 V DC)	6 A (12 V DC); 3 A (24 V DC)	6 A (12 V DC); 3 A (24 V DC)
Consumption	10 A (12 V DC); 5 A (24 V DC)	10 A (12 V DC); 5 A (24 V DC)	10 A (12 V DC); 5 A (24 V DC)
Fuse			
Discharge	Through the floor	Through the floor	Rear
Material	Seat: wood, bowl: ceramic	Seat: wood, bowl: ceramic	Seat: wood, bowl: ceramic
Colour	White	White	White
Dimensions (WxHxD, mm)	438 x 337 x 467	378 x 441 x 467	378 x 441 x 467
Weight (kg)	12.7	12.7	12.7
Quality features	Powerful vacuum flush with foot pedal operation, very economical water consumption – only 0.47 litres per flush, small footprint – fits most bathroom layouts, household-size seat and bowl, anti-splash bowl rim helps prevent spills, through-the-floor or through-the-wall discharge options, connection to VacuFlush vacuum generator or holding tank system		
Accessories			
VacuFlush Toilet switch	–	–	–



* Not included in the scope of delivery.

7.04 // MasterFlush MF 8100 series

7.04 // MasterFlush MF 8900 series

					
8112 / 8116	8152 / 8156	8979 / 8970	8989 / 8980	8939 / 8930	8949 / 8940
9108553021 (12 V DC) 9108553022 (24 V DC)	9108553023 (12 V DC) 9108553024 (24 V DC)	9108553155 (12 V DC) 9108553153 (24 V DC)	9108684198 (12 V DC) 9108684195 (24 V DC)	9108553050 (12 V DC) 9108553048 (24 V DC)	9108684175 (12 V DC) 9108684176 (24 V DC)
12 V DC or 24 V DC	12 V DC or 24 V DC	12 V DC or 24 V DC	12 V DC or 24 V DC	12 V DC or 24 V DC	12 V DC or 24 V DC
20 A / 12 V DC; 15 A / 24 V DC	20 A / 12 V DC; 15 A / 24 V DC	20 A / 12 V DC; 15 A / 24 V DC	20 A / 12 V DC; 15 A / 24 V DC	20 A / 12 V DC; 15 A / 24 V DC	20 A / 12 V DC; 15 A / 24 V DC
20 A / 12 V DC; 15 A / 24 V DC	20 A / 12 V DC; 15 A / 24 V DC	20 A / 12 V DC; 15 A / 24 V DC	20 A / 12 V DC; 15 A / 24 V DC	20 A / 12 V DC; 15 A / 24 V DC	20 A / 12 V DC; 15 A / 24 V DC
12 ga. (up to 6.1 m from breaker)			12 ga. (up to 6.1 m from breaker)		
Fresh water	Fresh water	Fresh water	Fresh water	Fresh water	Fresh water
Seat: wood, ceramic bowl	Seat: wood, ceramic bowl		Vitreous ceramic		
White	White	White	White	White	White
375 x 381 x 467	375 x 467 x 467	375 x 460 x 473	375 x 460 x 473	375 x 375 x 464	375 x 375 x 464
20.5	26.5	25.4	25.4	22.2	22.2
High-quality ceramic bowl, efficient stainless steel macerator, quiet operation, low energy consumption, easy installation		Soft-close seat	With integrated bidet function, soft-close seat	Soft-close seat	With integrated bidet function, soft-close seat
-	-	-	-	-	-
		9108782202	9108782202	9108782202	9108782202

7.04 // VacuFlush 4800 series

	
4806	4809
9108554740 (12 V DC) 9108554772 (24 V DC)	9108554742 (12 V DC) 9108554774 (24 V DC)
Low profile	Standard height
12 V DC or 24 V DC	12 V DC or 24 V DC
2 A (12 V DC); 1 A (24 V DC)	2 A (12 V DC); 1 A (24 V DC)
5 A (12 V DC); 5 A (24 V DC)	5 A (12 V DC); 5 A (24 V DC)
6 A (12 V DC), 3 A (24 V DC) 10 A (12 V DC), 5 A (24 V DC)	6 A (12 V DC), 3 A (24 V DC) 10 A (12 V DC), 5 A (24 V DC)
Rear	Rear
Seat: thermoset plastic, bowl: ceramic	Seat: thermoset plastic, bowl: ceramic
White	White
375 x 375 x 464	375 x 460 x 473
24	28
Powerful electric vacuum flush, very economical water consumption in two modes – “Normal Flush” 0.95 litres, “Dry Bowl” flush 0.5 litres, small footprint – fits most bathroom layouts, soft-close thermoset seat, automatic “full tank” shutdown (when connected to tank level indicator) prevents overfilling the holding tank, service mode allows cleaning or other service without running water	
9108782199	9108782199



7.04 // Accessories

Accessories for vacuum toilets

		
	Vacuum generator VG4	Vacuum generator VGLP
Ref. No.	9108554946 (12 V DC) 9108554947 (24 V DC)	9108554934 (12 V DC) 9108554935 (24 V DC)
	Combination of vacuum tank and S-series vacuum pump	Combination of vacuum tank and S-series vacuum pump
Voltage	12 V DC or 24 V DC	12 V DC or 24 V DC
Consumption	6 A (12 V DC), 3 A (24 V DC)	6 A (12 V DC), 3 A (24 V DC)
Fuse	10 A (12 V DC), 5 A (24 V DC)	10 A (12 V DC), 5 A (24 V DC)
Pump motor	–	–
Material	Tank: High-density polyethylene (durable)	Tank: High-density polyethylene (durable)
Hose connections (mm)	38	38
Dimensions (W x H x D, mm)	511 x 356 x 232	737 x 203 x 254
Weight (kg)	–	–
Quality features	Components accommodate diverse plumbing layouts, improved pump flow thanks to large valve openings (51 mm ID), injection-moulded tank with precise tolerances for efficient and reliable operation, supplied pre-wired and pre-fitted	Powerful vacuum source for all VacuFlush toilets, vacuum pump and tank can be fitted up to 0.9 m apart from each other (additional sanitation hose required), supplied pre-wired and pre-fitted

7.04 // Accessories

Accessories for holding tanks

		
	Dometic DTM04	Dometic DTD01-12 / DTD01-24
Ref. No.	9108554495 (with ventilation) 9108554496 (without ventilation)	9107100011 (12 V DC) 9107100012 (24 V DC)
	Tank monitor Four-level unit with three float switches and four-colour LED indicator	Tank discharge management For use in combination with DTM04 tank monitor
Voltage	–	12 V DC or 24 V DC
Consumption	12 volts DC: 8 mA 24 volts DC: 4 mA	16 mA
Required circuit protection	–	1 A breaker / fuse
Dimensions (W x H x D, mm)	Panel: 83 x 83 x 10	Panel: 83 x 83 x 10
Testmarks	ISO 8846, EMC Directive 2004/108/EC	ISO 8846, EMC Directive 2004/108/EC
Scope of delivery	Cap with three level switches, display panel with four lights, instruction manual	Electric discharge control panel, 2 x keys, instruction manual
Quality features	Continuous tank monitoring with four-level indication, easy installation; probe cap installs in Dometic tank inspection port, adjustment of float switch to required length possible	Easy and safe holding tank discharge, manual discharge in unrestricted waters, no accidental discharge in restricted waters, simplifies plumbing by eliminating Y-valves
Optional extras		
12-volt-relay	9107100013	–
24-volt-relay	9107100014	–
Flange	9108553349	–



Vacuum tank VT

9108554885

Vacuum pump S12 / S24

9108554750 (12 V DC)
9108554752 (24 V DC)

Stores the vacuum force that evacuates VacuFlush toilet bowls with every flush.

Robust and reliable vacuum pump

–

12 V DC or 24 V DC

–

6 A (12 V DC), 3 A (24 V DC)

–

10 A (12 V DC), 5 A (24 V DC)

PVC

–

–

38

622 x 292 x 241

406 x 197 x 171

3.5

Highly sensitive vacuum switch monitors vacuum level and activates vacuum pump when vacuum level drops due to flushing. Flexible installation – floor or wall mounting. Corrosion-proof construction, durable and easy to clean. Including 2 90° & 2 straight hose adapters

Runs dry without damage even for extended periods of time. No dynamic seals or impellers that might overheat or clog. Patented Quadra Valve™ valves let metal or plastic contaminants up to 13 mm in diameter pass without damage. Current draw on 12 V: only 4 – 6 amps.



Dometic DTM01P

9108688891

Dometic DTM01C

9107100009

Tank monitor
Single-level unit with one float switch and red warning light

Tank monitor
Single-level unit with one float switch and red warning light

–

–

16 mA

16 mA

–

–

Panel: 83 x 51 x 10

Panel: 83 x 51 x 10

ISO 8846, EMC Directive 2004/108/EC

ISO 8846, EMC Directive 2004/108/EC

Single float switch assembly with cap, display panel with one LED, instruction manual

Single float switch assembly with cap, display panel with one LED, instruction manual

Easy installation on Dometic holding tanks, activates red warning light when holding tank is approx. ¾ full

Simple and cost-effective solution, activates red warning light when holding tank is about ¾ full, easy installation; probe cap installs in Dometic tank inspection port

–

–

–





–

–

9108553349





7.04 // Holding tanks

Holding tanks

					
	DHT42L	DHT61L	DHT88L	DHT110L	DHT137L
Ref. No.	9107100001	9107100002	9107100003	9107100004	9107100005
Gross capacity (l)	42	61	88	110	137
Material	Holding tank: polyethylene, Fittings: polyvinyl chloride, ABS				
Colour	Holding tank: natural, Fittings: white				
Dimensions (W x H x D, mm)	460 x 347 x 350	660 x 348 x 350	800 x 388 x 400	1200 x 348 x 350	1200 x 388 x 400
Empty weight (kg)	5.4	7.7	10.2	14	14.5
Quality features	Leak-proof, odour-free design in highly durable polyethylene (6.3 mm wall thickness), pre-cut holes, pre-installed and tested fittings that can rotate, two separate outlets for dockside and overboard discharge, vacuum relief valve prevents damage from high-capacity dockside vacuum pumps				
Test mark	ISO 8099 compliant				

7.13 // Sanitation Hoses

Sanitation Hoses

				
	MaxFlex 38	MaxFlex 25	MaxFlex 19	MaxFlex 16
Ref. No.	9107100016 (15 m) 9107100033 (50 m)	9107100017 (15 m) 9107100034 (50 m)	9107100018 (15 m) 9107100035 (50 m)	9107100019 (15 m) 9107100036 (50 m)
Material	Flexible polyvinyl chloride			
Colour	White			
Operating pressure (bar)	4	6	8	8
Diameter (Ø, mm) inner / outer	39 / 47	26 / 32	20 / 24	17 / 22
Wall thickness (mm)	4.1	2.9	2.3	2.6
Inside bend radius (mm)	152	102	78	65
Hose length (m)	15 or 50			
Weight (g/m)	700	340	200	190
Working temperature (°C)	-17 to +65			
Quality features	Very flexible hose, easy installation, suitable for multiple sanitation uses (38 mm best for toilet, pump and tank connections; 25 mm commonly used on some electric marine toilets; 19 mm and 16 mm commonly used on vent systems). Not suitable for drinking water.			









OdorSafe Plus 38

Ref. No.	9107100015
Material	Flexible polyvinyl chloride
Colour	White
Operating pressure (bar)	6
Diameter (Ø, mm) inner / outer	38 / 47
Wall thickness (mm)	4.1
Inside bend radius (mm)	190.5
Hose length (m)	15
Weight (g/m)	710
Working temperature (°C)	-17 to +65
Quality features	Excellent odour barrier, up to 500 % more effective than other sanitation hoses, available in Ø 38 mm for sewage systems, PVC anti-crash spiral, no friction and no risk of clogging thanks to smooth inside surface

Discharge pump / Pressurised water pumps

7.04 // Dometic DTW

7.13 // Dometic PowerPump

						
	DTW12 / DTW24	PP 127	PP 1210	PP 2410	PP 1217	PP 2417
Ref. No.	9107100006 (12 V) 9107100007 (24 V)	9107100051	9107100052	9107100053	9107100054	9107100055
Flow rate	1130 l/h	7 l/min	10 l/min	10 l/min	17 l/min	17 l/min
Material	PP	Metal / PP				
Voltage	12 or 24 volts DC	12 V DC	12 V DC	24 V DC	12 V DC	24 V DC
Consumption	6 A / 3 A	-	-	-	-	-
Required circuit protection	10 A / 5 A breaker / fuse	-	-	-	-	-
Colour	-	Orange / black / white				
Dimensions (WxHxD, mm)	349 x 197 x 170	210 x 98.5 x 87.5				
Hose connection	38 mm ID sanitation hose	-	-	-	-	-
Cut-off pressure	-	1.4 bar / 2.2 Ah	2.1 bar / 3.0 Ah	2.1 bar / 1.5 Ah	2.8 bar / 6.0 Ah	2.8 bar / 3.0 Ah
Weight (kg)	3.5	-	-	-	-	-
Test marks	ISO 8846, EMC Directive 2004/108/EC	-	-	-	-	-
Scope of delivery	Waste discharge pump, 1" reduction, instruction manual	Pump, strainer with 1/2" hose connector, 1/2" straight hose connector, 1/2" 90° elbow hose connector, 1/2" straight thread				
Quality features	Quiet operation, long-lasting bellows design, 5-year warranty*, dry self-priming	High-performance pump, four-chamber diaphragm design – maintenance free, self-priming, runs dry without damage, fast and easy installation of strainer and fittings, low-noise operation, low energy consumption				

* Due to the unique bellows design, we offer a five-year limited warranty on the bellows against wear-out.

7.01 // Portable Toilets

Portable Toilets

		
	SaniPottie® 972	SaniPottie® 976
Ref. No.	9108557678 (white/beige) 9108557679 (white/grey)	9108557680 (white/beige) 9108557681 (white/grey)
Tank capacity (l)	8.7	8.7
Flush water	9.8	18.9
Waste tank		
Material	ABS	ABS
Colour	White/beige or white/grey	White/beige or white/grey
Dimensions (WxHxD, mm)	333 x 317 x 387	333 x 387 x 387
Weight (kg)	5.4	5.9
Accessories		
Additional tank	9107100030	9107100031
Discharge kit	9107100028	9107100029
Fixing kit	9108559158	9108559158

FAX ORDER

Simply copy the form – fill it in – and fax it back to us.

Address	Sender details/stamp
---------	----------------------

FANCY MORE ...? REQUEST OUR CATALOGUES!



Cruisair by Dometic GROUP

Wide choice of direct expansion air conditioning and tempered water air conditioning systems. Complemented by matching controls and accessories. Plus: Dometic Marine air conditioning systems and Eskimo Ice fishbox ice systems.



Superyacht Air Conditioning and Sanitation

Complete systems, controls and accessories for large boats: chilled water air conditioning, direct expansion systems, special applications, sanitation products.



MarineAir Systems® by Dometic GROUP

Specification sheets for: direct expansion air conditioning systems, chilled water air conditioning systems, controls and accessories. Also included: Dometic Marine air conditioning systems and Eskimo Ice fishbox ice systems.

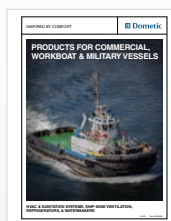

Commercial, Workboat & Military Air Conditioning & Sanitation Systems

A guide to chilled water and direct expansion air conditioning systems, plus accessories and sanitation products, designed for commercial, workboat, and military vessels.



My Freedom

The comprehensive specialist catalogue for camping and leisure. A comprehensive range of products – mobile refrigeration, air conditioning, electronics, reversing video systems, vehicle accessories, lighting, windows, awnings, kitchen and sanitation equipment.



On the Road again

Safety and comfort accessories for cars, trucks and vans. From parking aids to reversing video systems and battery care products. Plus a wide choice of portable coolers for work and leisure time.

Our catalogues are also available on the internet at:
www.dometic.com/marine

YOUR CONTACT TO DOMETIC WAECO

www.dometic.com/marine // info@dometic-waeco.com

Always a good link: the Dometic WAECO website. That's where you will find the complete Dometic WAECO range. You'll get a clear view of the products along with detailed information. Plus interesting news about our company and the latest special offers. And of course you can order all our catalogues online.

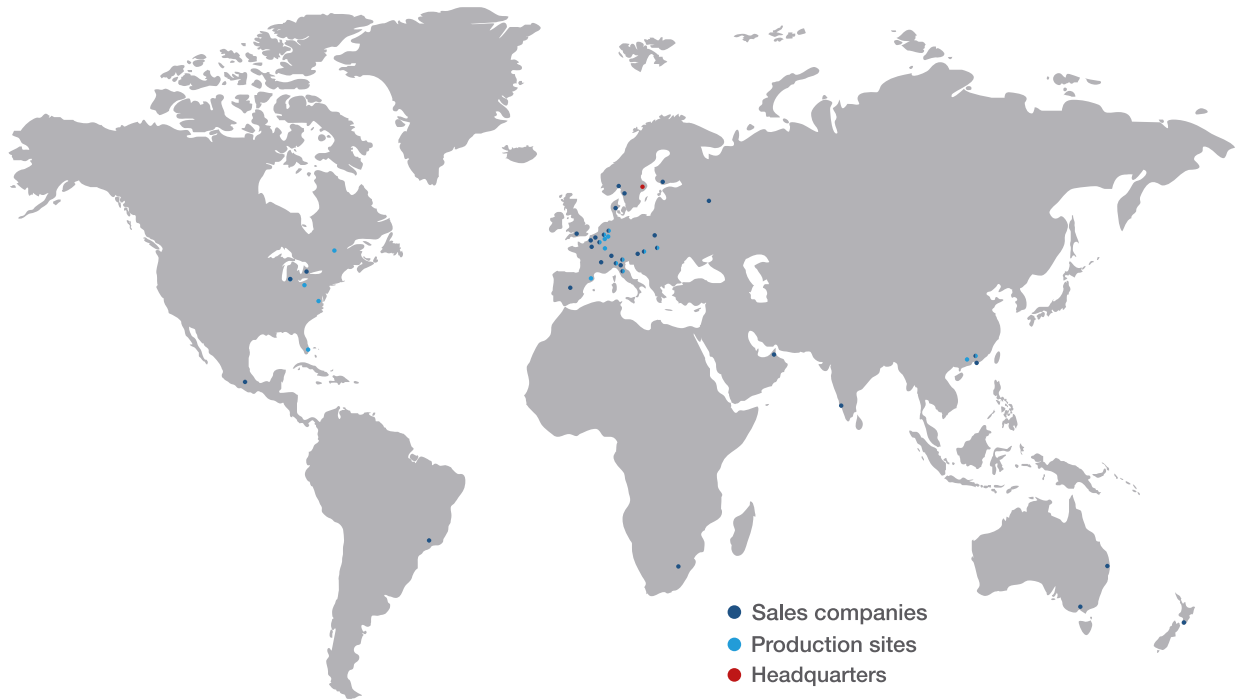

Dometic GROUP is a customer-driven, world-leading provider of leisure products for the RV, automotive, truck and marine markets. We supply the industry and aftermarket with a complete range of air conditioners, refrigerators, awnings, cookers, sanitation systems, lighting, mobile power equipment, comfort and safety solutions, windows, doors and other equipment that make life more comfortable away from home.

Dometic GROUP supplies a wide range of workshop equipment for service and maintenance of built-in air conditioners.

Dometic GROUP also provides specially designed refrigerators for hotel rooms, offices, wine storage and transport and storage of medical products.

Our products are sold in almost 100 countries and are produced mainly in wholly-owned production facilities around the world.

THE COMPREHENSIVE RANGE OF COMFORT SYSTEMS FOR LEISURE BOATS



GERMANY

Dometic WAECO International GmbH
Hollefeldstraße 63
D-48282 Emsdetten
Tel +49 (0) 2572 879-0
Fax +49 (0) 2572 879-300
Mail info@dometic-waeco.de
Net www.dometic.com/marine

UNITED KINGDOM

Dometic UK Ltd.
Dometic House, The Brewery,
Blandford St. Mary
Dorset DT11 9LS
Tel +44 (0) 844 626 0133
Fax +44 (0) 844 626 0143
Mail bestbrands@dometic.co.uk
Net www.dometic.co.uk/marine

AUSTRALIA

Dometic Australia Pty. Ltd.
1 John Duncan Court
Varsity Lakes QLD 4227
Tel +61 7 55076000
Fax +61 7 55076001
Mail sales@dometic-waeco.com.au

AUSTRIA

Dometic Austria GmbH
Neudorferstrasse 108
A-2353 Guntramsdorf
Tel +43 2236 908070
Fax +43 2236 90807060
Mail info@waeco.at

BENELUX

Dometic Benelux B.V.
Ecustraat 3
NL-4879 NP Etten-Leur
Tel +31 76 5029000
Fax +31 76 5029019
Mail info@dometic.nl

Dometic Branch Office Belgium

Zinkstraat 13
B-1500 Halle
Tel +32 2 3598040
Fax +32 2 3598050
Mail info@dometic.be

DENMARK

Dometic Denmark A/S
Nordensvej 15, Taulov
DK-7000 Fredericia
Tel +45 75585966
Fax +45 75586307
Mail info@dometic.dk

FINLAND

Dometic Finland OY
Mestarintie 4
FIN-01730 Vantaa
Tel +358 20 7413220
Fax +358 9 7593700
Mail info@dometic.fi

FRANCE

Dometic France SAS
ZA du Pré de la Dame Jeanne
B.P. 5
F-60128 Plailly
Tel +33 3 44633526
Fax +33 3 44636516
Mail marine@dometic.fr

HONG KONG

Dometic Group Asia Pacific
Suites 2207-11 · 22/F · Tower 1
The Gateway · 25 Canton Road
Tsim Sha Tsui · Kowloon
Tel +852 2 4611386
Fax +852 2 4665553
Mail info@waeco.com.hk

HUNGARY

Dometic Plc. Sales Office
H-1147 Budapest
Kerékgyártó u. 5.
Tel +36 1 468 4400
Fax +36 1 468 4401
Mail budapest@dometic.hu

ITALY

Dometic Italy S.r.l.
Via Virgilio, 3
I-47122 Forlì (FC)
Tel +39 0543 754901
Fax +39 0543 754983
Mail vendite@dometic.it

JAPAN

Dometic KK
Maekawa-Shibaura, Bldg. 2
2-13-9 Shibaura Minato-ku
Tokyo 108-0023
Tel +81 3 5445 3333
Fax +81 3 5445 3339
Mail info@dometic.jp

NEW ZEALAND

Dometic New Zealand Ltd.
Unit E, The Gate
373 Neilson Street
Penrose 1061, Auckland
Tel +64 9 622 1490
Fax +64 9 622 1573
customerservices@dometic.co.nz

NORWAY

Dometic Norway AS
Østerøyveien 46
N-3236 Sandefjord
Tel +47 33428450
Fax +47 33428459
Mail firmapost@dometic.no

POLAND

Dometic Poland Sp. z o.o.
ul. Puławska 435A
PL-02-801 Warszawa
Tel +48 22 414 32 00
Fax +48 22 414 32 01
Mail info@dometic.pl

PORTUGAL

Dometic S.L.- Sucursal em Portugal
Rotunda de São Gonçalo n° 1
Esc. 122775-399 Carcavelos
2710-297 Sintra
Tel +351 219 244 173
Fax +351 219 243 206
Mail info@dometic.pt

RUSSIA

Dometic RUS LLC
Komsomolskaya square 6 – 1
RU-107140 Moscow
Tel +7 495 780 79 39
Fax +7 495 916 56 53
Mail info@dometic.ru

SINGAPORE

Dometic Pte Ltd
18 Boon Lay Way 06-140 Trade Hub 21
Singapore 609966
Tel +65 6795 3177
Fax +65 6862 6620
Mail dometic@dometic.com.sg

SLOVAKIA

Dometic Slovakia Sales Office
Bratislava
Nádražná 34/A
900 28 Ivanka pri Dunaji
Tel +421 2 45 529 680
Fax +421 2 45 529 680
Mail bratislava@dometic.com

SOUTH AFRICA

Dometic (Pty) Ltd.
Regional Office
South Africa & Sub-Saharan Africa
P.O. Box 2562
2008 Bedfordview
Tel +27 11 4504978
Fax +27 11 4504976
Mail info@dometic.co.za

SPAIN

Dometic Spain S.L.
Avda. Sierra del Guadarrama, 16
E-28691 Villanueva de la Cañada
Madrid
Tel +34 902 111 042
Fax +34 900 100 245
Mail info@dometic.es

SWEDEN

Dometic Scandinavia AB
Gustaf Melins gata 7
S-421 31 Västra Frölunda
Tel +46 31 7341100
Fax +46 31 7341101
Mail info@dometicgroup.se

SWITZERLAND

Dometic Switzerland AG
Riedackerstrasse 7a
CH-8153 Rümlang
Tel +41 44 8187171
Fax +41 44 8187191
Mail info@dometic-waeco.ch

UNITED ARAB EMIRATES

Dometic Middle East FZCO
P.O. Box 17860
S-D 6, Jebel Ali Freezone
Dubai
Tel +971 4 883 3858
Tel +971 4 883 3868
Mail info@dometic.ae

USA

Dometic Marine Division
2000 N. Andrews Ave. Ext.
Pompano Beach, FL 33069
Tel +1 954-973-2477
Fax +1 954-979-4414
Mail marinesales@dometicusa.com

For regions not listed above please call our Dometic WAECO International GmbH office.

Your dealer:

