

CONTENTS

SAFETY PRECAUTIONS	1
NAMES OF PARTS	4
INDOOR UNIT DISPLAY	5
MANUAL ON/OFF FUNCTION & AUTO-RESTART FUNCTION	6
REMOTE CONTROLLER	7
OPERATING INSTRUCTIONS	11
INSTALLATION MANUAL.....	20
MAINTENANCE	31
TROUBLESHOOTING	32

In line with the company's policy of continual product improvement, the aesthetic and dimensional characteristics, technical data and accessories of this appliance may be changed without notice.

SAFETY RULES AND RECOMMENDATIONS FOR THE INSTALLER

⚠ **R**ead this guide before installing and using the appliance.

⚠ **E**nsure no child or at risk party is present during the installation of the indoor or outdoor unit as unforeseeable accidents can occur.

⚠ **M**ake sure that the base of the outdoor unit is firmly secured.

⚠ **C**heck that air cannot enter the refrigerant system and that there are no refrigerant leaks when moving the air conditioner.

⚠ **T**est the air conditioner after installing the unit and record the operating data.

⚠ **E**nsure the indoor unit is connected to a fuse that can withstand the maximum input current or another device with overload protection.

⚠ **M**ake sure the mains voltage matches to the voltage stamped on the rating plate. Keep the switch and power plug clean. Insert the power plug correctly and firmly into the socket, thereby avoiding the risk of electric shock or fire due to insufficient contact.

⚠ **C**heck that the socket is the same physical configuration as the plug; otherwise, change the socket to match.

⚠ **T**he appliance must be fitted with means for disconnection from the supply mains having a contact separation in all poles that provide full disconnection under over voltage category III conditions, and these means must be incorporated in the fixed wiring in accordance with the wiring rules.

⚠ **T**he air conditioner must be installed by professionals or qualified persons.

⚠ **M**ake sure to install the appliance more than 50 cm from inflammable substances (e.g., alcohol, etc.) and pressurized containers (e.g., spray cans).

⚠ **I**f the appliance is used in areas without proper ventilation, precautions must be taken to prevent any refrigerant gas leaks that can become trapped and create fire hazards.

⚠ **T**he packaging materials are recyclable and should be disposed of in the appropriate waste bins. When it is time, take the air conditioner to a special waste collection center for disposal.

⚠ **O**nly use the air conditioner as instructed in this booklet. These instructions are not intended to cover every possible condition and situation. As with any electrical household appliance, common sense and caution are therefore always recommended for installation, operation and maintenance.

⚠ **T**he appliance must be installed in accordance with applicable national and regional regulations.

⚠ **B**efore accessing the terminals, all power circuits must be disconnected from the power supply.

⚠ **T**he appliance shall be installed in accordance with national and regional wiring regulations.

⚠ **T**his appliance can only be used by children 8 years and older and persons with reduced physical, sensory or mental capabilities or persons that lack experience and knowledge of the device IF they have been supervision or instruction concerning the use of the appliance in a safe way and understand the hazards involved. Children shall not play with the appliance and should not clean or exercise maintenance of the unit without direct supervision.

SAFETY RULES AND RECOMMENDATIONS FOR THE USER

⚠ Do not try to install the conditioner alone; always contact specialized technical personnel.

⚠ Cleaning and maintenance must be carried out by specialized technical personnel. Make sure to disconnect the appliance from the mains electricity supply before carrying out any cleaning or maintenance.

⚠ Do not pull out the plug to switch off the appliance when it is in operation, since this could create a spark and cause a fire, etc.

⚠ This appliance has been made for air conditioning domestic environments and must not be used for any other purpose, such as for drying clothes, cooling food, etc.

⚠ Always use the appliance with the air filter installed. Use of the conditioner without air filter could cause an excessive accumulation of dust or waste on the inner parts of the device with possible subsequent failures.

⚠ The user is responsible for having the appliance installed by a qualified technician, who must check that it is earthed in accordance with current legislation and insert a thermomagnetic circuit breaker.

⚠ The batteries in remote controller must be recycled or disposed of properly. Disposal of Scrap Batteries --- Please discard the batteries as sorted municipal waste at the accessible collection point.

⚠ Never remain in direct flow of cold air for extended periods of time as this could be dangerous for your health. Exercise caution in rooms where there are children and old or sick individuals.

⚠ If the appliance gives off smoke or there is a burning smell, immediately cut off the power supply and contact the Service Center.

⚠ Use of the device in the state mentioned above can cause fire or electrocution.

⚠ All repairs should be carried out by an authorised service center. Incorrect repair can expose the user to the risk of electric shock, fire, etc.

⚠ Unhook the automatic switch if you foresee not using the device for a long time. The airflow direction must be properly adjusted.

⚠ The flaps must be directed downwards in the heating mode and upwards in the cooling mode.

⚠ Ensure that the appliance is disconnected from the power supply when it will remain inoperative for a long period and before carrying out any cleaning or maintenance.

⚠ Selecting the most suitable temperature can prevent damage to the appliance.

SAFETY RULES AND PROHIBITIONS

- ⊖ Do not bend , tug or compress the power cord as this could damage it and may result in electrical shocks or fire hazards. Only specialized technical personnel should replace a damaged power cord.
 - ⊖ Do not use extension cords, power strips, or gang modules.
 - ⊖ Do not touch the appliance when barefoot or parts of the body are wet or damp.
 - ⊖ Do not obstruct the air inlet or outlet of the indoor or the outdoor unit.
The obstruction of these openings causes a reduction in the operating efficiency of the conditioner and may cause unit damage or failure.
 - ⊖ In no way alter the characteristics of the appliance.
 - ⊖ Do not install the appliance in environments where the air could contain gas , oil or sulphur or near sources of heat.
 - ⊖ This appliance is not intended for use by persons (including children) with reduced physical, sensory or mental capabilities, or lack of experience and knowledge, unless they have been given supervision or instruction concerning use of the appliance by a person responsible for their safety.
- ⊖ Do not climb onto or place any heavy or hot objects on top of the appliance.
 - ⊖ Do not leave windows or doors open for long periods of time.
 - ⊖ Do not direct airflow onto plants or animals as long, direct exposure could have negative effects.
 - ⊖ Do not install the conditioner in areas with risk to water exposure and do not allow water to come in contact with the unit as the electrical insulation could become damaged, resulting in electrocution.
 - ⊖ Never insert a stick or similar object into the appliance. It could cause injury.
 - ⊖ Children should be supervised to ensure that they do not play with the appliance. If the supply cord is damaged, it must be replaced by the manufacturer, its service agent or similarly qualified persons in order to avoid a hazard.

NAMES OF PARTS

Indoor unit

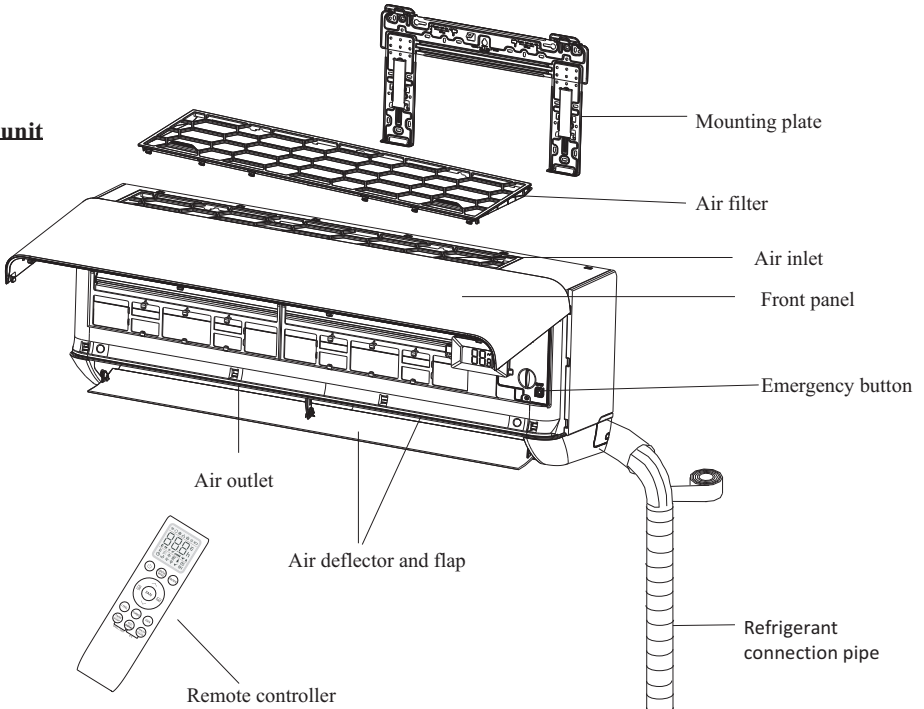



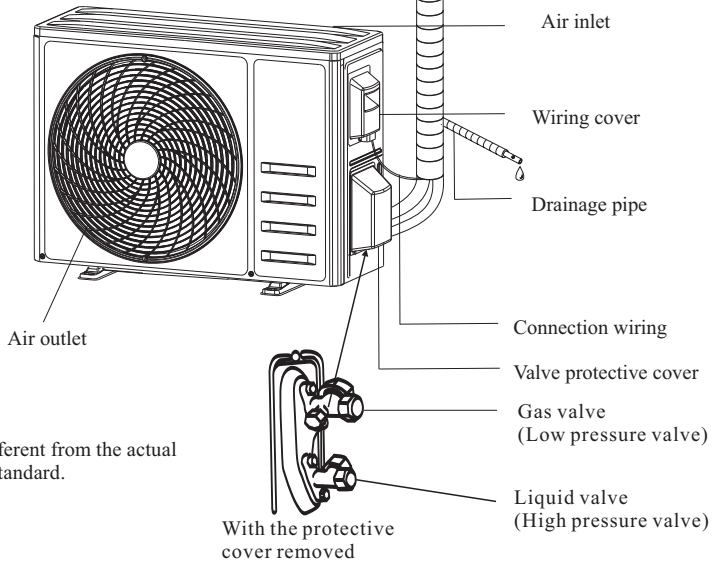

Outdoor unit

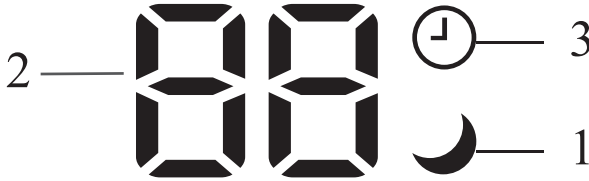

Note: This figure shown may be different from the actual object. Please take the latter as the standard.

INDOOR UNIT DISPLAY



No.	Led		Function
1	SLEEP		SLEEP mode
2	Temperature display (if present) /Error code		(1) Lights up during Timer operation when the air conditioner is operational (2) Displays the malfunction code when fault occurs.
3	TIMER		Lights up during Timer operation.

Note:

For the models with Wi-Fi function, there will be some information shown on the display when setting Wi-Fi function:

PP means searching the router

SA means connected to the router

AP means connected to the server

 *The shape and position of switches and indicators may be different according to the model, but their function is the same.*

MANUAL ON/OFF FUNCTION & AUTO-RESTART FUNCTION

MANUAL ON/OFF FUNCTION

If the remote controller fails to work or maintenance is necessary, proceed as the following:

Open and lift the front panel up to reach the emergency button.

For cooling only model, press the manual on/off once to enter COOL mode. Press the manual on/off a second time to turn off the unit.

For cooling and heating models, press the manual on/off once to enter COOL mode, Press the manual on/off a second time within 3 seconds to enter HEAT mode.

AUTO-RESTART FUNCTION

The appliance is preset with an auto-restart function. In case of a sudden power failure, the module memorizes the settings before power failure. When the power restores, the unit will restart automatically with the previous settings preserved by the memory function.

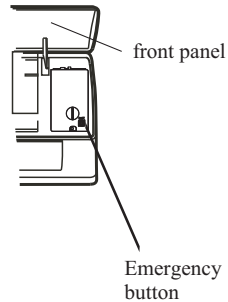

The emergency button is located on the E-box cover of the unit under the front panel.

 *The shape and position of the emergency button may be different according to the model, but their function is the same.*



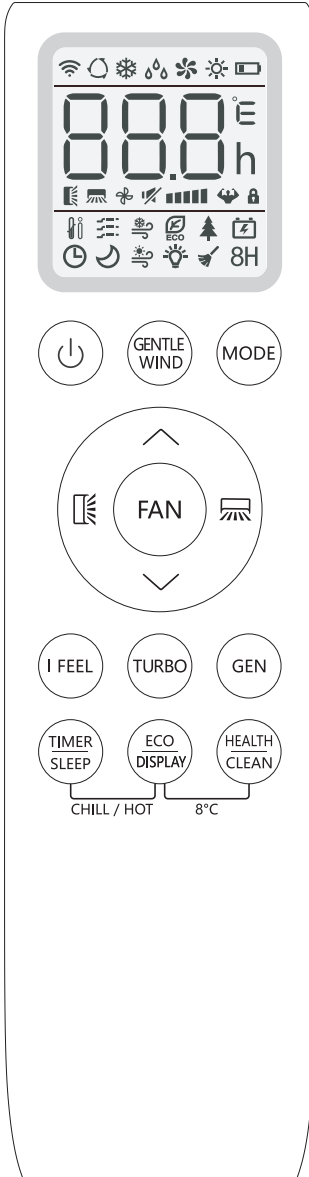







REMOTE CONTROLLER





REMOTE CONTROLLER

Remote controller buttons

Some functions may not apply to the purchased model. Refer to the included remote control for which functions are applicable to the unit.

No.	Buttons	Function
1		To turn on/off the air conditioner
2	GENTLE WIND	To activate Gentle Wind function.
3	MODE	To select the operation mode: AUTO, COOL, DRY, FAN, HEAT.
4	 (TEMP UP)	To increase the temperature or lengthen the time when setting the TIMER.
5	 (TEMP DN)	To decrease the temperature or reduce the time when setting the TIMER.
6		To adjust the air flow direction vertically(optional).
7		To adjust the air flow direction horizontally.
8	FAN	To adjust the fan speed: auto, mute, low, mid-low, mid, mid-high, high, Turbo. To switch the temperature display between Fahrenheit & Celsius, press and hold the FAN button for 5 seconds
9	I FEEL	To activate the I FEEL function
10	TURBO	To switch on/off TURBO mode
11	GEN	To switch on/off GENERATOR mode
12	TIMER/SLEEP	To switch on/off the TIMER function and SLEEP mode
13	ECO/DISPLAY	To switch on/off ECO mode and LED display light
14	HEALTH/CLEAN	To switch on/off the HEALTH function and Auto Clean function.
15	TIMER/SLEEP + ECO/DISPLAY	To switch on/off the CHILL WIND and HOT WIND function.
16	ECO/DISPLAY + HEALTH/CLEAN	To switch on/off the 8° C heating function.
17	 ( + )	To activate the function of Child Lock, press  and  buttons together for more than 3 seconds.

 The display and some functions of the remote control may vary according to the model.

 The shape and position of buttons and indicators may vary according to the model, but their function is the same.

 The unit confirms the correct reception of each button with a beep.

 Some functions on your remote may not be fit for the purchased air conditioner. In this event, the air conditioner will beep but will not activate the request accordingly.

REMOTE CONTROLLER

Remote controller DISPLAY (Symbols on the liquid crystal display)

No.	Symbols	Meaning
1		AUTO MODE indicator
2		COOLING MODE indicator
3		DRY MODE indicator
4		FAN MODE indicator
5		HEATING MODE indicator
6		BATTERY indicator
7		TEMPERATURE/ CLOCK indicator
8		FLAP SWING (Air flow) indicator
9		MUTE indicator
10		FAN SPEED indicator
11		AUTO FAN indicator
12		TURBO indicator
13		CHILD LOCK indicator
14		I FEEL indicator
15		GENTLE WIND indicator
16		CHILL WIND indicator
17		ECO indicator
18		HEALTHY indicator
19		GENERATOR MODE indicator
20		TIMER indicator
21		SLEEP MODE indicator
22		HOT WIND indicator
23		DISPLAY LIGHT indicator
24		CLEAN function indicator
25		8° C heating function indicator

REMOTE CONTROLLER

Battery Installation & Replacement

Remove the battery cover plate from the rear of the remote controller by sliding it in the direction of the arrow.

Install the batteries according to the directions (+and -)shown on the Remote Controller.

Reinstall the battery cover by sliding it into place.

- ⚠ Use 2 AAA (1.5V) batteries . Do not use rechargeable batteries . Replace the old batteries with new ones of the same type when the display is no longer legible.
Do not dispose batteries as unsorted municipal waste. Collection of such waste separately for special treatment is necessary.

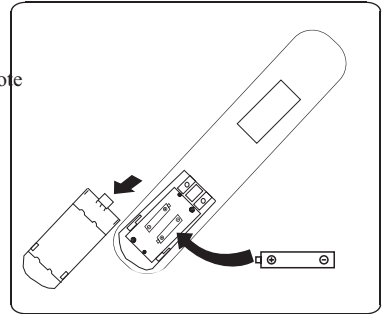

It is recommended to keep the remote controller in the designated wall mounted holder (if included) .

OPERATING INSTRUCTIONS

Air is pulled by the fan through the grille and passes through the filter, then it is cooled/dehumidified or heated through the heat exchanger.

The direction of the air outlet is motorized up and down by flaps, and manually moved right and left by the vertical deflectors, for some models, the vertical deflectors could be controlled by motor as well.

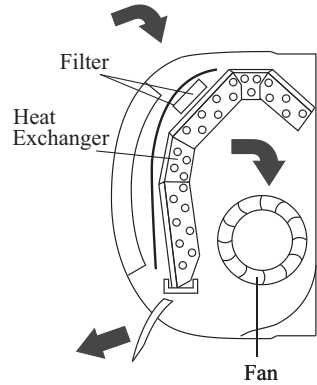

Turn ON / Turn OFF the air conditioner

Press the button  to turn on or turn off the air conditioner.

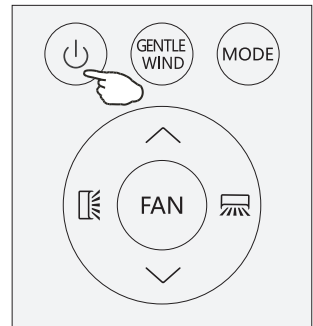

COOLING MODE



The cooling function allows the air conditioner to cool the room and, at the same time, reduces air humidity.

To activate the cooling function (COOL) , press the **MODE** button until the symbol  appears on the display.

Use \blacktriangledown or \blacktriangle set the unit to the desired temperature.

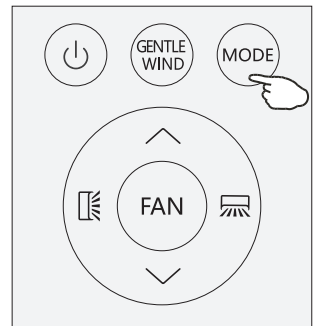

OPERATING INSTRUCTIONS

HEATING MODE



The heating function allows the air conditioner to heat the room.

To activate the heating function (HEAT), press the MODE button until the symbol ☀ appears on the display.

Use ▼ or ▲ set the unit to the desired temperature.



In HEAT mode, the unit can automatically activate a defrost cycle, which is essential to remove frost from the condenser and restore the heat exchange. This cycle usually lasts for 2-10 minutes.

When activated, the indoor unit fan will pause and then resume heating once the cycle has finished.

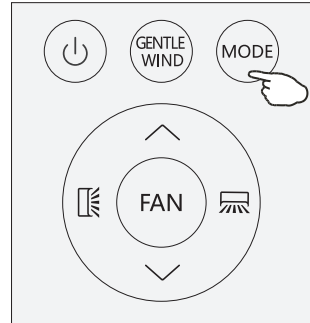

DRY MODE



This function reduces the humidity of the air to make the room more comfortable.

To set the DRY mode, Press MODE until ☁ appears in the display.

The DRY setting humidity level is fixed and can not be changed.

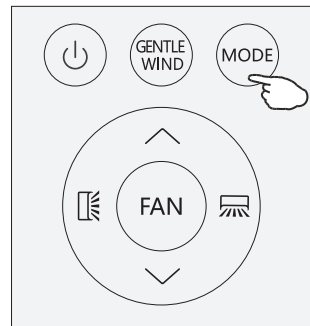

FAN MODE(Not FAN button)



Fan mode circulates air only.

To set the FAN mode, press MODE until ☪ appears on the display.

AUTO MODE



Automatic mode.

To set AUTO mode, press MODE until ⏻ appears on the display.

In AUTO mode, the run mode will be set automatically according to the room temperature.

OPERATING INSTRUCTIONS

Change the fan speed

Press **FAN** button to set the running fan speed, it can be set to AUTO/ MUTE/ LOW/ MID-LOW/ MID/ MID-HIGH/ HIGH/ TURBO speed.

Flashing

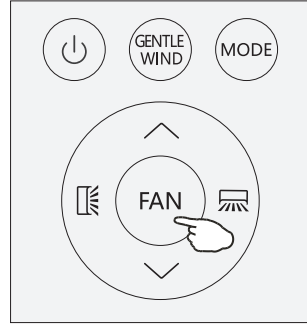

AIR FLOW CONTROL

1. Normal 4 way air flow (vertical and horizontal):

- (1) Press to activate the horizontal flaps to swing from up to down. Press again to stop the swing movement at the current angle.
- (2) Press to activate the vertical deflectors to swing from left to right. Press again to stop the swing movement at the current angle.

2. Vector precise air flow

- (1) Press and hold for 1s, it will go into the horizontal vector air flow, you can select a small swing angle:

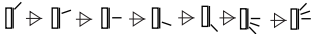

Hold for 5s to stop the selection. Press again to exit the horizontal vector precise air flow.

- (2) Press and hold for 1s, it will go into the vertical vector air flow:



Hold for 5s to stop the selection. Press again to exit the vertical vector precise air flow.

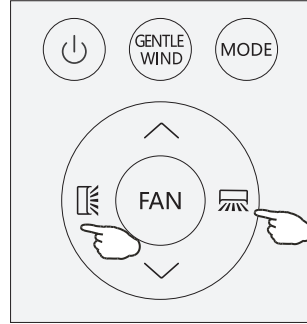

3. If the vertical deflectors are positioned manually which are placed under the flaps, they can be adjusted to airflow left or right.

- ⚠ *This adjustment must be done while the appliance is switched off.*
- ⚠ *Never position "Flaps" manually, the delicate mechanism can be seriously damaged.*
- ⚠ *Never poke fingers, sticks or other objects in the air inlet or outlet vents. Such accidental contact with live parts might cause unforeseeable damage or injury.*

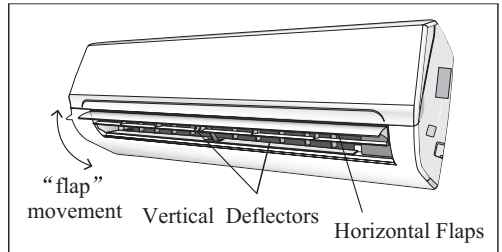

OPERATING INSTRUCTIONS

GENTLE WIND (select models only)



The vertical louvers will close and air flow will be forced through the louvers diffused holes to cool the room gently.

Press the GENTLE WIND button and  appears on the display, and the appliance will run in GENTLE WIND mode. Press again to cancel it..

NOTE:

The gentle wind function is available in COOLING mode only.

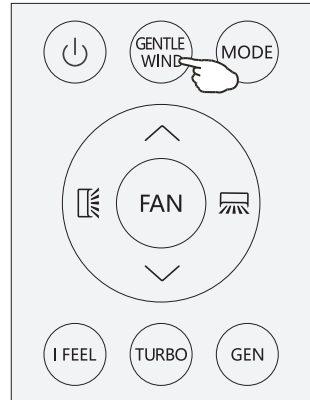

I FEEL function

I FEEL

Press **I FEEL** button to activate the function, and  will appear on the remote display. Do it again to deactivate this function.

This function enables the remote control to measure the temperature at its current location, and send this signal to the air conditioner to optimize the temperature around you.

It will automatically deactivate after 2 hours.

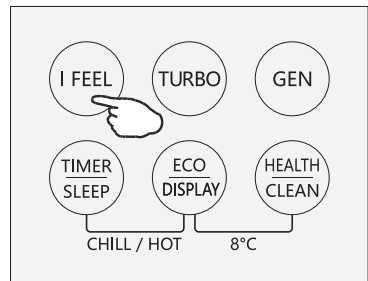

Turbo function



To activate turbo function, press the TURBO button, and  will appear on the display. Press again to cancel this function.

In COOL/HEAT mode, when you select TURBO, the appliance will operate the fast cooling/ fast heating with the highest fan speed.

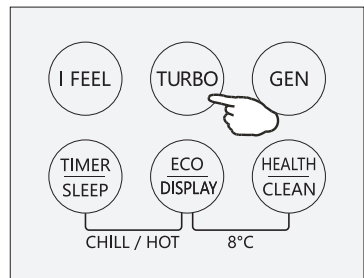

OPERATING INSTRUCTIONS

GENERATOR MODE (select models only)



In generator mode, the air conditioner will work at selected current percentage.

Through GEN mode, you can choose the current level of the unit. There are three levels (L1, L2, L3) in this mode, and the current increases in turn.

To activate GEN function, press the button GEN and the unit current level will cycle as below
OFF → L3 → L2 → L1 ”

Running current (% of rated current):

L1: 30%, L2: 50%, L3: 70%

To cancel this function, press the GEN until code OF appears on the display.

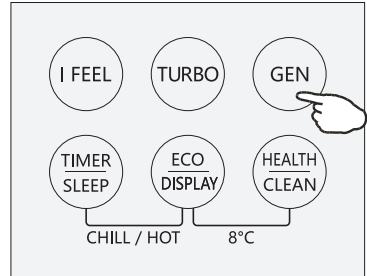

SLEEP MODE



Press SLEEP button and hold for 2s to activate the sleep mode, then  appears on the display. Press and hold for 2s again to cancel this mode.

In sleep mode, the air conditioner will automatically adjust the temperature and fan speed to make the room more comfortable during the night.

After 10 hours running in sleep mode, the air conditioner will change to its previous setting.

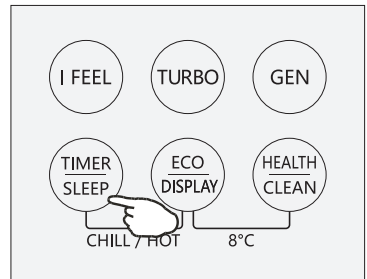

ECO MODE



Eco mode helps to conserve energy.

Press the ECO button, the  appears on the display, and the appliance will run in ECO mode. Press again to cancel it.

NOTE:

The ECO function is available in both COOLING and HEATING modes.

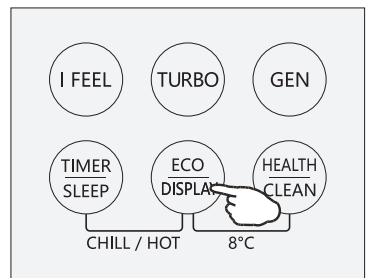

OPERATING INSTRUCTIONS

LED display light ON/OFF

Press **DISPLAY** button and hold for 2s to turn on/off the indoor LED display light.

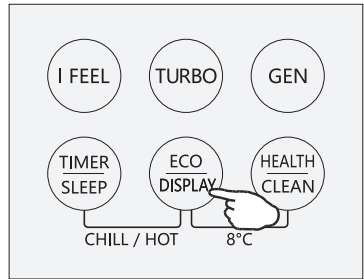

HEALTH function (Select models only)

Press **HEALTH** button to active / exit the health functions such as ion generator/ plasma, etc.

Note: Health function is not available when the air conditioner is off.

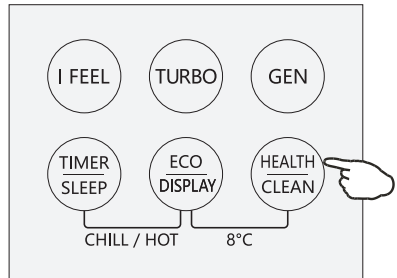

SELF-CLEAN function (select models only)

1. This function helps carry away the accumulated dirt, bacteria, etc from the evaporator
2. Turn off the air conditioner, and press CLEAN button ("CL" will be displayed on the indoor unit display).
3. This function will run about 30 minutes, and it will exit automatically. You will hear 2 beeps when it's finished or cancelled.
4. It's normal if there are some noise during this process as plastic materials expand with heat and contract with cold.
5. It is recommended to enable this feature in the following ambient temperatures.

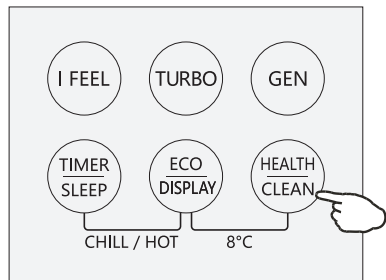

Indoor unit	Temp<86°F
Outdoor unit	41°F<Temp<86°F

6. It is recommended to enable this function every 3 months.

OPERATING INSTRUCTIONS

TIMER MODE----SET TIMER OFF



Set the air conditioner to turn off automatically.

With the AC on, press the Timer button and then use the \wedge and \vee buttons to set the length of time before the AC will turn off. Press the timer button again to start the countdown.

Note: To cancel the setted function, press the TIMER button again.

Note: In case of power off, it is necessary to set TIMER OFF again

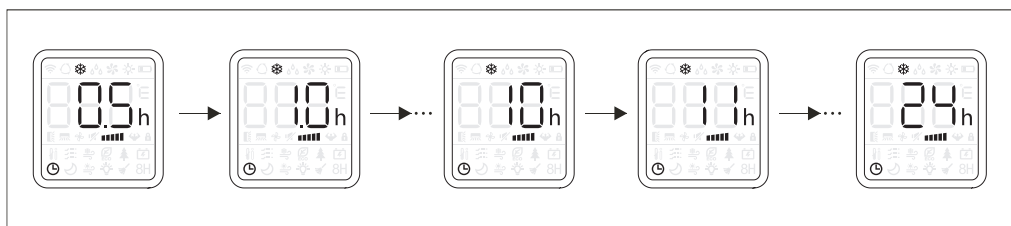
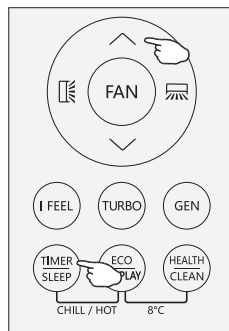

TIMER MODE----SET TIMER ON



Set the air conditioner to turn on automatically.

With the AC off, press the Timer button and use the \wedge and \vee buttons to set the desired amount of time before the AC turns on. Press the timer button again to start the countdown.

After setting the time, you can set the operation mode, fan speed, desired temperature, air flow when air conditioner starts to run.

Note: To cancel the timer function, press the TIMER button again.

Note: In case of power off, it is necessary to set TIMER ON again

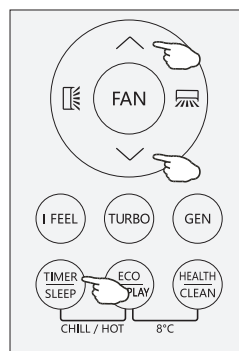

OPERATING INSTRUCTIONS

CHILL wind/ HOT wind function (select models only)



1. In cooling mode, press both TIMER/SLEEP and ECO/DISPLAY buttons and hold for 2s to activate the chill wind function.
2. In heating mode, press both TIMER/SLEEP and ECO/DISPLAY buttons and hold for 2s to activate the hot wind function.
3. Press both TIMER/SLEEP and ECO/DISPLAY buttons and hold for 2s to exit the chill wind or hot wind function.

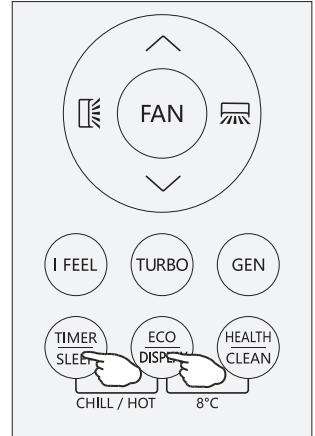

8°C heating function (Select models only)



1. Press both ECO/DISPLAY and HEALTH/CLEAN buttons and hold for 2s to activate the 8°C heating.
2. If the air conditioner is in standby, this function will enable the air conditioner to automatically start heating when the indoor temperature is equal or lower than 8°C, the unit will return to standby if the temperature is equal or higher than 18°C.
3. When the AC is turned off, press both ECO/DISPLAY and HEALTH/CLEAN buttons and hold for 2s to exit the 8°C heating.

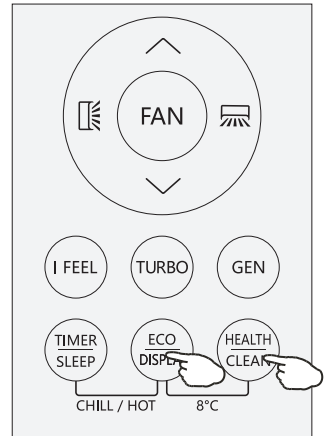

OPERATING INSTRUCTIONS

Operating Temperature

The air conditioner is programmed for appropriate environmental conditions as shown below. If used outside the specified conditions, certain safety precautions feature might be activated.

Inverter air conditioner:

MODE Temperature	Cooling operating	Heating operating	Drying operating
Room temperature	63 °F~90 °F	32 °F~81 °F	63 °F~90 °F
Outdoor temperature	59 °F~122 °F	5 °F~75 °F	59 °F~122 °F
	5 °F~ 122 °F For models with low temperature cooling system	-13 °F~75 °F For models with low temperature heating system	5 °F~ 122 °F For models with low temperature cooling system

 *The unit does not operate immediately if it is turned on after being turned off or after changing the mode during operation. This is a normal self-protection action, you need waiting for about 3 minutes.*

 *The capacity and efficiency are according to the test conducted at full-load operation (The highest speed of indoor fan motor and the maximum open angle of the flaps and deflectors are requested.)*

INSTALLATION MANUAL---Selecting the Installation Place

INDOOR UNIT

- Install the indoor unit on a strong wall that is not subject to vibrations.
- The inlet and outlet ports should not be obstructed. The air should be able to blow all over the room.
- Do not install the unit near a source of heat, steam, or flammable gas.
- Do not install the unit where it will be exposed to direct sunlight.
- Select a site where the condensed water can be easily drained out, and where it is easily connected to outdoor unit.
- Check the machine operation regularly and reserve the necessary spaces as shown in the picture.
- Select a place where the filter can be easily taken out.

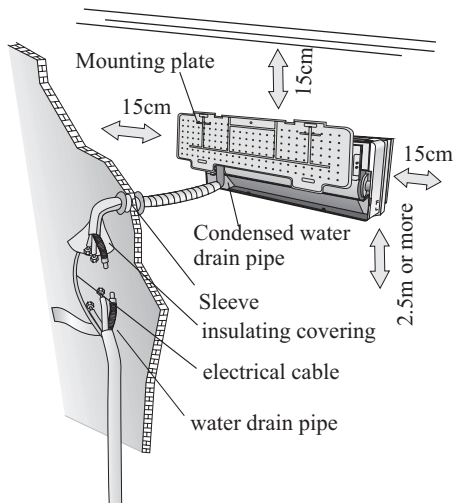

OUTDOOR UNIT

- Do not install the outdoor unit near sources of heat, steam or flammable gas.
- Do not install the unit in too windy or dusty places.
- Do not install the unit where people often pass. Select a place where the air discharge and operating sound will not disturb the neighbors.
- Avoid installing the unit where it will be exposed to direct sunlight (other wise use a protective covering, if necessary, that should not interfere with the air flow).
- Reserve the spaces as shown in the picture for the air to circulate freely.
- Install the outdoor unit in a safe and solid place.
- If the outdoor unit is subject to vibration, place rubber gaskets onto the feet of the unit.

minimum space to be reserved (mm) showing in the picture

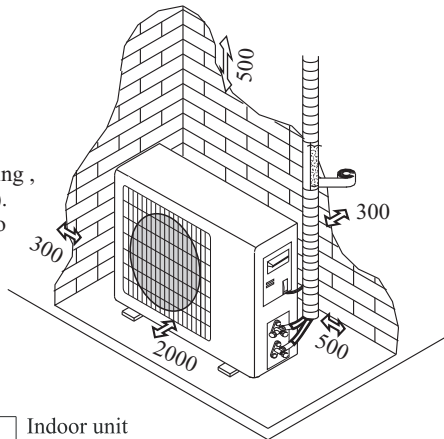

Installation Diagram

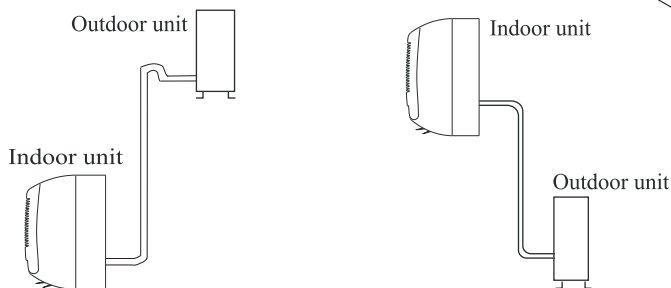

The purchaser must ensure that the person and/or company who is to install, maintain or repair this air conditioner has qualifications and experience in refrigerant products.

INSTALLATION MANUAL---Installation of the Indoor unit

Before starting installation, decide on the position of the indoor and outdoor units, taking into account the minimum space reserved around the units

- ⚠ Do not install your air conditioner in a wet room such as a bathroom or laundry etc
- ⚠ The installation site should be 250cm or more above the floor.

To install, proceed as follows:

Installation of the mounting plate

1. Always mount the rear panel horizontally and vertically
2. Drill 32 mm deep holes in the wall to fix the plate;
3. Insert the plastic anchors into the hole;
4. Fix the rear panel on the wall with provided tapping screws
5. Be sure that the rear panel has been fixed firmly enough to withstand the weight.

Note : The shape of the mounting plate may be different from the one above, but installation method is similar .

Drilling a hole in the wall for the piping

1. Make the piping hole ($\Phi 65$) in the wall at a slight downward slant to the outdoor side.
2. Insert the piping-hole sleeve into the hole to prevent the connection piping and wiring from being damaged when passing through the hole.

- ⚠ The hole must slope downwards towards the exterior

Note : Keep the drain pipe down towards the direction of the wall hole, otherwise leakage may occur.

Electrical connections---Indoor unit

1. Open the front panel.
2. Take off the cover as indicated in the picture (by removing a screw or breaking the hooks).
3. For the electrical connections, see the circuit diagram on the right part of the unit under the front panel.
4. Connect the cable wires to the screw terminals by following the numbers. Use wire size suitable to the electric power input (see name plate on the unit) and in accordance with all current national safety code requirements.

- ⚠ The cable connecting the outdoor and indoor units must be suitable for outdoor use.

- ⚠ The plug must be accessible after the appliance has been installed so that it can be pulled out if necessary.

- ⚠ An efficient ground connection must be used.
- ⚠ If the power cable is damaged, it must be replaced by an authorised Service Center.

Note Optional: the wires can be connected to the main PCB of indoor unit by manufacturer according to the model without terminal block.

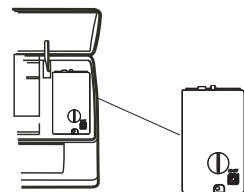
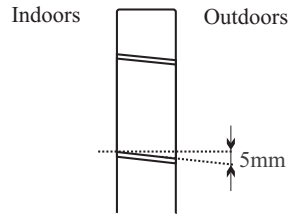
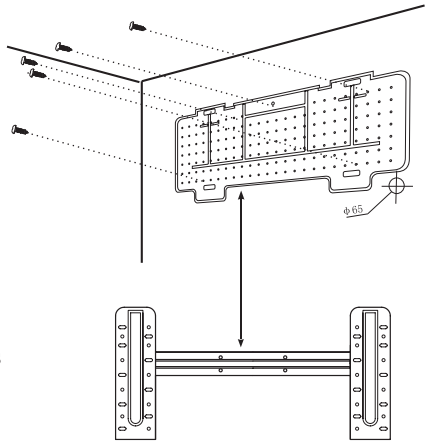

INSTALLATION MANUAL---Installation of the Indoor unit

Refrigerant piping connection

The piping can be run in the 3 directions indicated by numbers in the picture . When the piping is run in direction 1 or 3, cut a notch along the groove on the side of the indoor unit with a cutter.

Run the piping in the direction of the wall hole and bind the copper pipes , the drain pipe and the power cables together with tape with the drain pipe at the bottom, so that water can flow freely.

- Do not remove the cap from the pipe until connecting it to avoid dampness or dirt from entering.
- If the pipe is bent or pulled too often , it will become stiff . Do not bend the pipe more than three times at one point.
- When extending the rolled pipe, straighten the pipe by unwinding the rolled pipe, as shown in the picture.

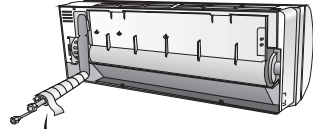
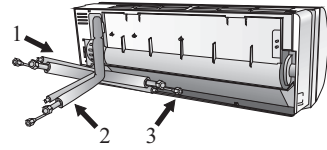

Shape the connection pipe

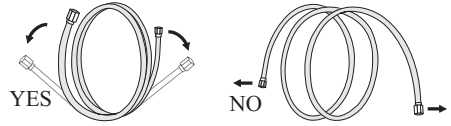

Extending the rolled pipe

Connections to the indoor unit

1. Remove the indoor unit pipe cap (check that there is no debris inside).
2. Insert the flare nut and create a flange at the extreme end of the connection pipe.
3. Tighten the connections by using two wrenches working in opposite directions.
4. For R32/R290 refrigerants, mechanical connectors should be outdoors.

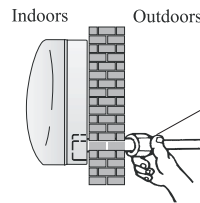

The connectors should be outdoors

Indoor unit condensed water drainage

The indoor unit condensed water drainage is fundamental for the success of the installation.

1. Place the drain hose below the piping, taking care not to create siphons.
2. The drain hose must slant downwards to aid drainage.
3. Do not bend the drain hose or leave it protruding or twisted and do not put the end of it in water . If an extension is connected to the drain hose , ensure that it is lagged when it passes into the indoor unit.
4. If the piping is installed to the right, the pipes , power cable and drain hose must be lagged and secured onto the rear of the unit with a pipe connection.
 - 1) Insert the pipe connection into the relative slot.
 - 2) Press to join the pipe connection to the base.

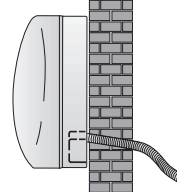

YES

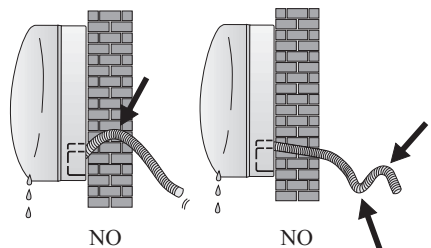

INSTALLATION MANUAL---Installation of the Indoor unit

INSTALLATION OF THE INDOOR UNIT

After having connected the pipe according to the instructions, install the connection cables. Now, install the drain pipe. After connecting, lag the pipe, cables and drain pipe with the insulating material.

1. Arrange the pipes ,cables and drain hose well.
2. Lag the pipe joints with insulating material , securing it with vinyl tape.
3. Run the bound pipe , Cables and drain pipe through the wall hole and mount the indoor unit onto the upper part of the mounting plate securely.
4. Press and push the lower part of the indoor unit tightly against the mounting plate

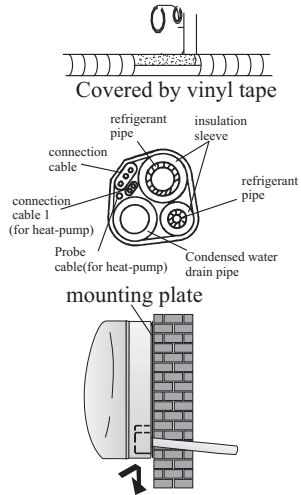

Sometimes, if the refrigerant piping is already embedded in the wall, or if you want to connecting the piping and wiring on the wall, do as below:

1. Gab both ends of the bottomplate, apply a little outward force to take off the bottomplate.
2. Hook the top of the indoor unit on the mounting plate without piping and wiring.
3. Lift the indoor unit opposite the wall, unfold the bracket on the mounting plate, and use this bracket to prop up the indoor unit, there will be a big space for operation.
4. Do the refrigerant piping, wiring, connect drainage hose, and wrap them as **Step 4 to 7**.
5. Replace the bracket of mounting plate.
6. Push down the bottom of indoor unit to let the snaps onto the bottom hooks of the mounting plate, and make sure it is hooked firmly.
7. Replace the bottomplate of the indoor unit.

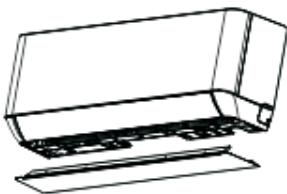

Take off the bottomplate

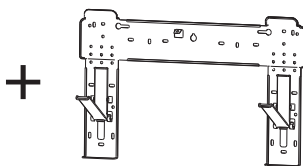

Unfold the bracket on the mounting plate

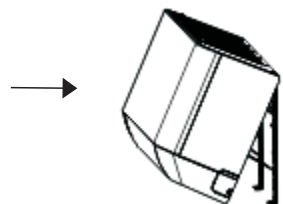

INSTALLATION MANUAL---Installation of the outdoor unit

- The outdoor unit should be installed on a solid wall and fastened securely.
- The following procedure must be observed before connecting the pipes and connecting cables : decide which is the best position on the wall and leave enough space to be able to carry out maintenance easily.
- Fasten the support to the wall using screw anchors which are particularly suited to the type of wall;
- Use a larger quantity of screw anchors than normally required for the weight they claim to avoid vibration during operation and to remain fastened in the same positing for years without the screws becoming loose.
- The unit must be installed following national regulations.

Outdoor unit condensed water drainage (only for heat pump models)

The condensed water and the ice formed in the outdoor unit during heating operation can be drained away through the drain pipe

1. Fasten the drain port in the 25mm hole placed in the part of the unit as shown in the picture.
2. Connect the drain port and the drain pipe.
Pay attention that water is drained in a suitable place.

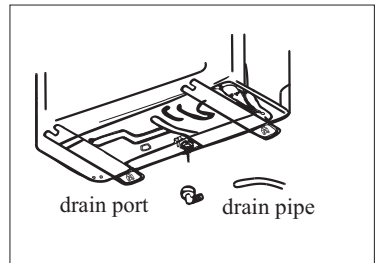

INSTALLATION MANUAL---Installation of the outdoor unit

ELECTRICAL CONNECTIONS

1. Remove the handle on the right side plate of outdoor unit.
2. Connect the power connection cord to the terminal board.
Wiring should fit that of indoor unit.
3. Fix the power connection cord with wire clamp.
4. Confirm if the wire has been fixed properly.
5. An efficient ground connection must be ensured.
6. Recover the handle.

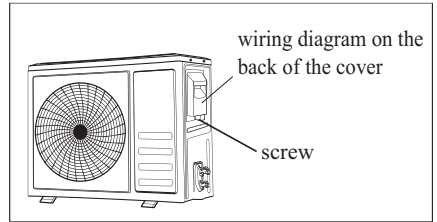

CONNECTING THE PIPES

Screw the flare nuts to the outdoor unit coupling with the same tightening procedures described for the indoor unit.

To avoid leakage, pay attention to the following points:

1. Tighten the flare nuts using two wrenches. Pay attention not to damage the pipes.
2. If the tightening torque is not sufficient, there will probably be some leakage. With excessive tightening torque there will also be some leakage, as the flange could be damaged.
3. The surest system consists in tightening the connection by using a fix wrench and a torque wrench as below:

PIPE Size	Newton meter [N x m]	Pound-force foot (1bf-ft)	Kilogram-force meter (kgf-m)
1/4" (φ 6.35)	18 - 20	24.4 - 27.1	2.4 - 2.7
3/8" (φ 9.52)	30 - 35	40.6 - 47.4	4.1 - 4.8
1/2" (φ 12)	45 - 50	61.0 - 67.7	6.2 - 6.9
5/8" (φ 15.88)	60 - 65	81.3 - 88.1	8.2 - 8.9

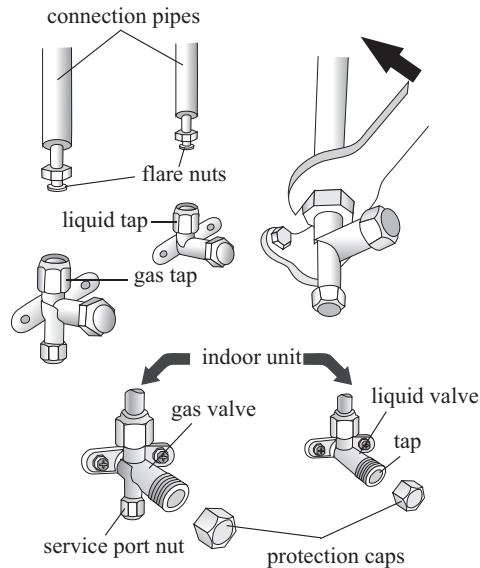

INSTALLATION MANUAL---Installation of the outdoor unit

Air Vacuumizing

1. Use a spanner to take down the protective caps from the service port, low pressure valve and high pressure valve of the outdoor unit.
2. Connect the pressure hose of the manifold gauge to the service port on the outdoor unit low pressure valve.
3. Connect the charge hose from the manifold gauge to the vacuum pump.
4. Open the low pressure valve of the manifold gauge and close the high pressure valve.
5. Turn on the vacuum pump to vacuumize the system.
6. The vacuuming time should not be less than 15 minutes, or make sure the compound gauge indicates -0.1 MPa (-76 cmHg)
7. Close the low pressure valve of the manifold gauge and turn off the vacuum.
8. Hold the pressure for 5 minutes, make sure that the rebound of compound gauge pointer does not exceed 0.005 Mpa .
9. Turn the low pressure valve counterclockwise for $1/4$ turn with hexagonal wrench to let a little refrigerant fill in the system, and close the low pressure valve after 5 seconds and quickly remove the pressure hose.
10. Check all indoor and outdoor joints for leakage with soapy water or leak detector.
11. Fully open the low pressure valve and high pressure valve of the outdoor unit with hexagonal wrench.
12. Replace the protective caps of the service port, low pressure valve and high pressure valve of the outdoor unit.
13. Replace the valve cover.

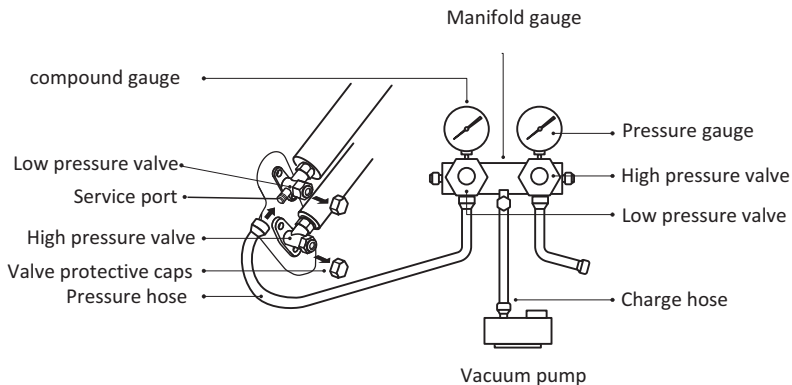
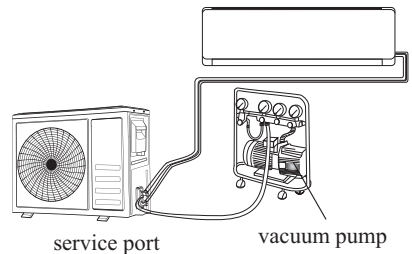

INSTALLATION MANUAL---Installation of the outdoor unit

BLEEDING

The air and humidity left inside the refrigerant circulation can cause compressor malfunction. After having connected the indoor and outdoor units, bleed the air and humidity from the refrigerant circulation using a vacuum pump.

- (1) Unscrew and remove the caps from the 2 - way and 3-way valves.
- (2) Unscrew and remove the cap from the service port.
- (3) Connect the vacuum pump hose to the service port.
- (4) Operate the vacuum pump for 10 - 15 minutes until an absolute vacuum of 10 mm Hg has been reached.
- (5) With the vacuum pump still in operation, close the low - pressure knob on the vacuum pump coupling. Stop the vacuum pump.
- (6) Open the 2 - way valve by 1/4 turn and then close it after 10 seconds. Check all the joints for leaks using liquid soap or an electronic leak device.
- (7) Turn the body of the 2-way and 3-way valves. Disconnect the vacuum pump hose.
- (8) Replace and tighten all the caps on the valves.

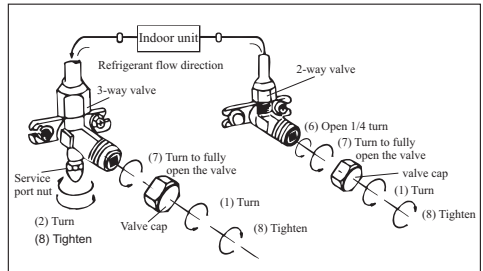
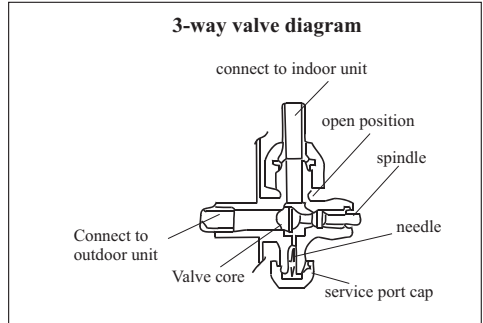

INSTALLATION MANUAL--- operation test

1. Install wind insulating covering around the joints of the indoor unit and fix it with insulating tape.
2. Fix the exceeding part of the signal cable to the piping or to the outdoor unit.
3. Fix the piping to the wall (after having coated it with insulating tape) using clamps or insert them into plastic slots.
4. Seal the hole in the wall through which the piping is passed so that no air or water can fill.

Indoor unit test

- Do the ON/OFF and FAN operate normally?
- Does the MODE operate normally?
- Do the set point and TIMER function properly?
- Does each lamp light normally?
- Do the flap for air flow direction operate normally?
- Is the condensed water drained regularly?

Outdoor unit test

- Is there any abnormal noise or vibration during operation?
- Could the noise, the air flow or the condensed water drainage disturb the neighbours?
- Is there any coolant leakage?

Note: the electronic controller allows the compressor to start only three minutes after voltage has reached the system.

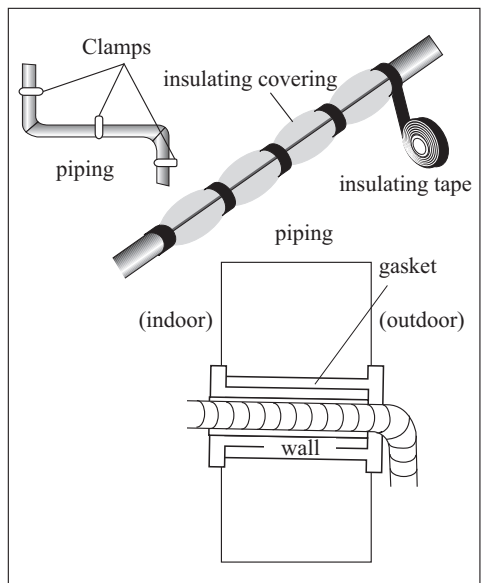

Pipe length and Additional refrigerant

Inverter Models capacity (Btu/h)	9k-12k	18k-36K
Length of pipe with standard charge	7.5m/25ft	7.5m/25ft
Maximum distance between indoor and outdoor unit	15m/49ft	25m/82ft
Additional refrigerant charge	20g/m (0.22oz/ft)	30g/m (0.32oz/ft)
Max. diff. in level between indoor and outdoor unit	10m/33ft	15m/49ft
Type of refrigerant	R410A	R410A

Dedicated Distribution Device and Wire for Air Conditioner

USE THE RIGHT CABLE

Appliance Amps (A)	Minimum Wire Cross-sectional Area (AWG)
10	18
13	16
15	14
20	12
30	10

- Outdoor Power Cable: H07RN-F
- Signal Cable: H07RN-F

Note:

This table is only for reference, the installation shall meet the requirements of local laws and regulations.

INSTALLATION MANUAL---Information for the installer

WIRING DIAGRAM

For different models, the wiring diagram may be different. Please refer to the wiring diagrams pasted on the indoor unit and outdoor unit, respectively.

On indoor unit, the wiring diagram is pasted under the front panel;

On outdoor unit, the wiring diagram is pasted on the backside of the outdoor handle cover.

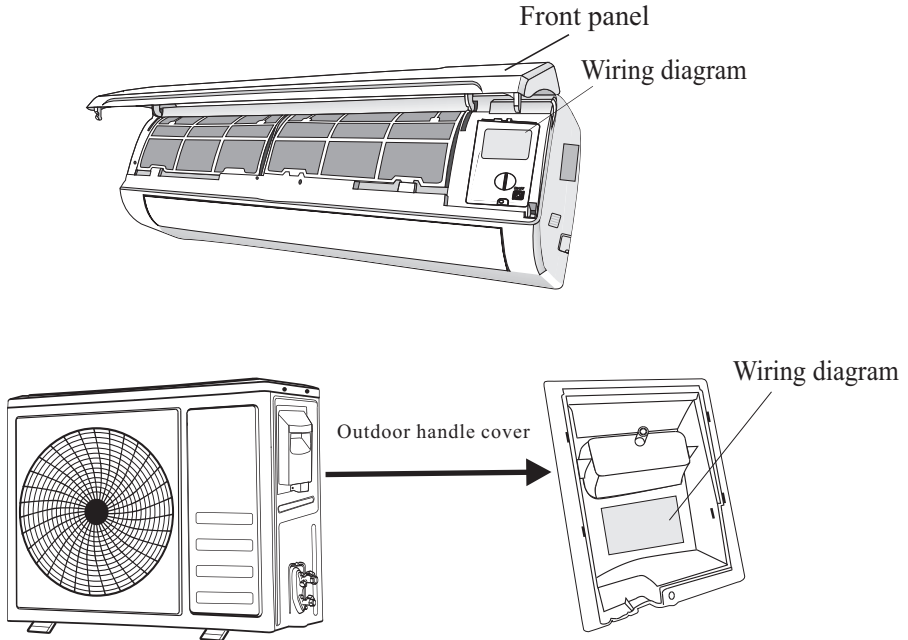

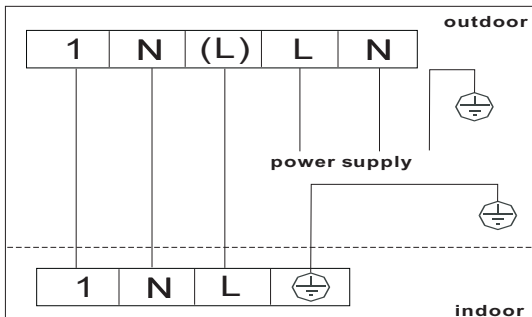

Wiring example:



Note: For some models, the wires has been connected to the main PCB of indoor unit by manufacturer without terminal block.

INSTALLATION MANUAL---Information for the installer

CABLE WIRES SPECIFICATION

INVERTER TYPE MODEL capacity (Btu/h)		9K/115V	12K/115V	9K/230V	12K/230V	18k	24k	36k
		sectional area						
Power supply cable	N(L2)	12AWG	12AWG	14AWG	14AWG	12AWG	12AWG	10AWG
	L(L1)	12AWG	12AWG	14AWG	14AWG	12AWG	12AWG	10AWG
		12AWG	12AWG	14AWG	14AWG	12AWG	12AWG	10AWG
Connection supply cable	3(L)	16AWG	16AWG	16AWG	16AWG	16AWG	16AWG	16AWG
	2(N)							
	1(S)							
								

MAINTENANCE

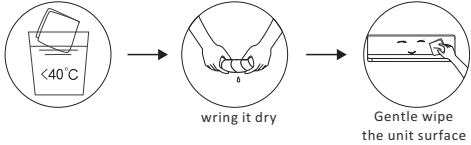
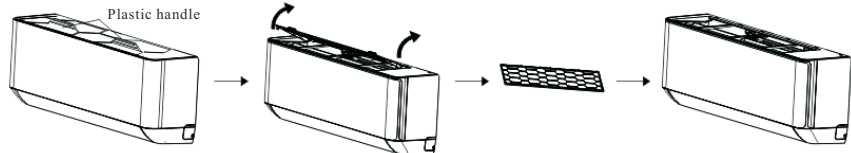
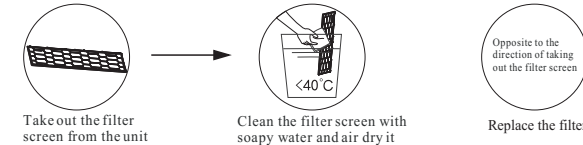
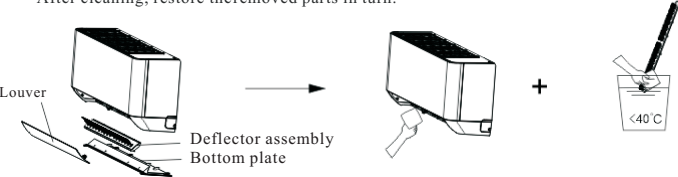
<p>Warning</p> 	<ul style="list-style-type: none"> • When cleaning, you must shut down the machine and cut off the power supply for more than 5 minutes. • Under no circumstances should the air conditioner be flushed with water. • Volatile liquid (e.g. thinner or gasoline) will damage the air conditioner, so only use soft dry cloth or wet cloth dipped with neutral detergent to clean the air conditioner. • Pay attention to cleaning the filter screen regularly to avoid dust covering which will affect the filter screen effect. When the operating environment is dusty, the cleaning frequency should be increased appropriately. • After removing the filter screen, do not touch the fins of the indoor unit to avoid scratching.
<p>Clean the unit</p>	 <p>Tip: Wipe frequently to keep air conditioner clean and good appearance .</p>
<p>Disassembly and assembly of filter screen</p>	<ul style="list-style-type: none"> • Grasp the raised plastic handle on the filter screen by hand, and then pull the filter screen out in the direction deviating from the unit, so that the upper edge of the filter screen is separated from the unit. The filter can be removed by lifting the filter upwards. • When installing the filter screen, first insert the lower end of the filter screen into the corresponding position of the unit, and then squeeze the upper end of the filter screen into the corresponding buckling position of the unit body. 
<p>Clean the filter screen</p>	 <p>Tip: When you find accumulated dust in the filter screen, please clean the filter screen in time to ensure the clean, healthy and efficient operation inside the air conditioner.</p>
<p>Cleaning of inner air duct</p>	<ul style="list-style-type: none"> • First, loosen the knob in the middle of louver and bend the louver outwards to take it out. • Then, grasp both sides of bottom plate push downwards to take down the bottom plate. • Finally, loosen the buckle of deflector assembly with your thumb and take it out. • Wipe the air duct and fan assembly with a clean and wrung wet rag. • Clean the removed parts with soapy water and air dry it. • After cleaning, restore the removed parts in turn. 
<p>Service and maintenance</p>	<ul style="list-style-type: none"> • When the air conditioner is not in use for a long time, do the following work: Take out the batteries of the remote controller and disconnect the power supply of the air conditioner. • When starting to use after long-term shutdown: <ol style="list-style-type: none"> 1. Clean the unit and filter screen; 2. Check whether there are obstacles at their inlet and outlet of indoor and outdoor units; 3. Check whether the drain pipe is unobstructed; Install the batteries of the remote controller and check whether the power is on.

TROUBLESHOOTING

MALFUNCTION	POSSIBLE CAUSES
The appliance does not operate	Power failure/plug pulled out.
	Damaged indoor/outdoor unit fan motor.
	Faulty compressor thermomagnetic circuit breaker.
	Faulty protective device or fuses.
	Loose connections or plug pulled out.
	It sometimes stops operating to protect the appliance.
	Voltage higher or lower than the voltage range.
	Active TIMER-ON function.
Strange odor	Dirty air filter.
Noise of running water	Back flow of liquid in the refrigerant circulation.
A fine mist comes from the air outlet	This occurs when the air in the room becomes very cold, for example in the “COOLING” or “DEHUMIDIFYING/DRY” modes.
A strange noise can be heard	This noise is made by the expansion or contraction of the front panel due to variations in temperature and does not indicate a problem.
Insufficient airflow, either hot or cold	Unsuitable temperature setting.
	Obstructed air conditioner intakes and outlets.
	Dirty air filter.
	Fan speed set at minimum.
	Other sources of heat in the room.
The appliance does not respond to commands	No refrigerant.
	Remote control is not close enough to indoor unit.
	The batteries of remote control need to be replaced.
The display is off	Obstacles between remote control and signal receiver in indoor unit.
	Active LIGHT function.
Switch off the air conditioner immediately and cut off the power supply in the event of:	Power failure.
	Uncommon noises during operation.
	Faulty electronic control board.
	Faulty fuses or switches.
	Spraying water or objects inside the appliance.
	Overheated cables or plugs.
Very strong smells coming from the appliance.	

ERROR SIGNALS ON THE DISPLAY

In case of error, the display on the indoor unit shown the following error codes:

Display	Description of the trouble	Display	Description of the trouble
<i>E1</i>	Indoor temperature sensor fault	<i>E8</i>	Outdoor discharge temperature sensor fault
<i>E2</i>	Indoor pipe temperature sensor fault	<i>E9</i>	Outdoor IPM module fault
<i>E3</i>	Outdoor pipe temperature sensor fault	<i>Ea</i>	Outdoor current detect fault
<i>E4</i>	Refrigerant system leakage or fault	<i>Ee</i>	Outdoor PCB EEPROM fault
<i>E5</i>	Malfunction of indoor fan motor	<i>Ef</i>	Outdoor fan motor fault
<i>E7</i>	Outdoor air temperature sensor fault	<i>EH</i>	Outdoor suction temperature sensor fault

