

UNI-T®

UNI-TREND TECHNOLOGY (CHINA) CO., LTD.

No. 6, Gong Ye Bei 1st Road,
Songshan Lake National High-Tech Industrial
Development Zone, Dongguan City,
Guangdong Province, China
Tel: (86-769) 8572 3888
<http://www.uni-trend.com>

PN:110401109812X
2020.12.01 REV.0

UNI-T®

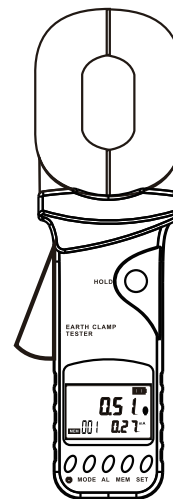

UT276A+
UT278A+
Clamp Earth Ground Testers
Operating Manual

Table of Contents

I. Preface	3
II. Brief Introduction	4
III. Model differentiation	4
IV. Range and Accuracy	5
V. Technical Specifications	6
VI. Structure of Tester	8
VII. LCD Display	9
VIII. Measuring Principle	10
IX. Operation Method	11
1. Turn On/Off	11
2. Battery Voltage Check	11
3. Resistance Test	11
4. Alarm Setting	13
5. Data Hold	13
6. Data Storage/Access/Deletion	14
X. Field Application	15
1. Multi-Point Grounding System	15
2. Limited Point Grounding System	16
3. Single-Point Grounding System	17
XI. Packing List	20

I. Preface

Thank you for purchasing the clamp ground resistance tester. Before using this tester, in order to avoid possible electric shock or personal injury, please read this manual thoroughly, especially the safety part below.

In any situation, pay special attention to safety when using this tester.

- The tester is designed, produced and inspected according to IEC61010 safety standard.
- When measuring, high-frequency signal generators such as mobile phones should not be used near the tester to avoid errors.
- Pay attention to the label text and symbols on the tester.
- Before use, make sure that the tester and accessories are in good condition.
- Before starting up, press the trigger once or twice to ensure that the jaws are closed properly.
- Do not measure in a flammable place. Sparks may cause an explosion.
- Do not press the trigger or clamp any wires when turning on the tester.
- After the tester is turned on normally, the "OL Ω" symbol is displayed, and the measured object can be clamped.
- Do not place or store the tester for an extended period of time under high temperature, humidity, condensation, or direct sunlight.
- Before replacing the batteries, make sure the tester is turned off.
- When low battery symbol "☐" is displayed, please replace the batteries in time to avoid errors.
- The jaw contact surfaces must be kept clean and cannot be wiped with corrosives or rough objects.
- When opening the trigger, avoid the impact of the clamp, especially the jaw joint.
- When measuring the resistance, it is normal for the clamp jaws to make a slight noise. Distinguish it from the beeps for alarming.

- Pay attention to the measuring range and use environment specified by this tester.
- Do not measure the current above the upper limit of the tester.
- The use, disassembly, calibration and maintenance of this tester must be performed by authorized personnel.
- If it is dangerous to continue using the tester, it should be immediately stopped and sealed, and then handled by a qualified organization.
- When it comes to the safety warning sign "⚠", users should strictly follow the contents of this manual for safe operation.

II. Brief Introduction

Clamp ground resistance tester, also known as loop resistance tester, is used to test grounding resistance. The tester, designed with a new black luxury screen, displays resistance and current on the same screen, and has data storage, data access, data upload, alarm, automatic shutdown and other functions. It is beautiful and upscale, and has a wide range, high resolution, convenient operation, accurate, reliable, stable performance, and strong anti-interference ability. With the shockproof, dustproof, and moisture-proof structure, the tester is commonly used for telecommunications, electricity, meteorology, computer rooms, oil fields, electromechanical installation and maintenance, and industrial enterprises that use electricity as industrial power or energy. The clamp ground resistance tester is controlled by the microprocessor and can accurately detect the ground resistance. It uses a fast filtering technique to minimize interference.

III. Model differentiation

Model	Resistance Range	Current Range
UT276A+	0-500Ω	
UT278A+	0-1200Ω	0-20A

IV. Range and Accuracy

Mode	Range	Resolution	Accuracy
Resistance	0.010Ω - 0.099Ω	0.001Ω	± (1%+0.01Ω)
	0.10Ω-0.99Ω	0.01Ω	± (1%+0.01Ω)
	1.0Ω-49.9Ω	0.1Ω	± (1%+0.1Ω)
	50.0Ω-99.5Ω	0.5Ω	± (1.5%+0.5Ω)
	100Ω-199Ω	1Ω	± (2%+1Ω)
	200Ω-395Ω	5Ω	± (5%+5Ω)
	400-590Ω	10Ω	± (10%+10Ω)
	600Ω-880Ω	20Ω	± (20%+20 Ω)
	900Ω-1200Ω	30Ω	± (25%+30 Ω)
Current	0.00mA-9.95mA	0.01mA	± (2.5%+1mA)
	10.0mA-99.0mA	0.1mA	± (2.5%+5mA)
	100mA -300mA	1mA	± (2.5%+10mA)
	0.30A-2.99A	0.01A	± (2.5%+0.1A)
	3.0A-9.9A	0.1A	± (2.5%+0.3A)
	10.0A-20.0A	0.1 A	± (2.5%+0.5A)

V. Technical Specifications

Functions	Ground resistance test, loop resistance test
Ambient Temperature and Humidity	23 ±5 , below 75%rh
Power Supply	DC 6V (4×1.5V AA alkaline batteries)
Range	UT276A+ resistance: 0.01-500 Ω
	UT278A+ resistance: 0.01-1200 Ω
	UT278A+ current: 0.00mA-20.0A
Measurement Method	Mutual induction
Resistance Resolution	0.001 Ω
Current Resolution	0.01mA (UT278A+)
Jaw Size	55mm×32mm
Ω + A Synchronous Display	Displays resistance and current on the same screen (UT278A+)
Display Mode	4-digit LCD display, black screen design
LCD Size	46mm×29mm
Tester Size	L/W/H: 285mm×85mm×58mm
Measuring Time	2 times/second
Data Storage	300 groups, "MEM" storage indication, "FULL" symbol indicates that storage is full
Data Access	"MR" symbol indicates when looking up data
Overflow Display	"OL" symbol indicates over-range overflow

Interference Test	Automatically identifies interference signals, the "NOISE" symbol indicates when the interference current is large
Alarm Function	Alarm when the measured value exceeds the alarm setting value
Battery Voltage	Real-time display of battery power, reminding timely charging when battery voltage is low
Automatic Shutdown	Turns off after 5 minutes
Power Consumption	50mA Max
Weight	1180g (including batteries)
Working Temperature and Humidity	-10°C - 40°C, below 80%rh
Storage Temperature and Humidity	20°C - 60°C, below 70%rh
Insulation Resistance	Above 20MΩ (500V between circuit and case)
Withstand Voltage	AC 3700V/rms (between circuit and case)
External Magnetic Field	<40A/m
External Electric Field	<1V/m
Applicable Safety Regulations	IEC61010-1 (CAT III 300V, CAT IV 150V, Pollution degree 2); IEC61010-031

VI. Structure of Tester

1. Clamp Jaw
2. Trigger
3. LCD
4. POWER Key
5. MODE Key
6. AL Key
7. MEM Key
8. SET Key
9. HOLD Key
10. CALIBRATION LOOP: 1Ω
11. CALIBRATION LOOP: 10Ω

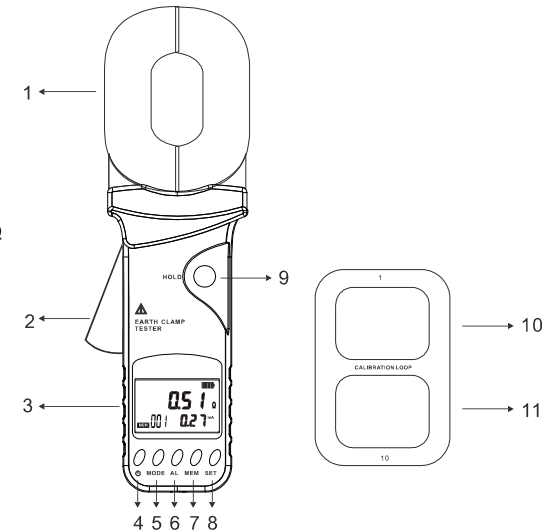

VII. LCD Display

- (1) Jaw opening symbol
- (2) Alarm symbol
- (3) Greater than symbol
- (4) DC/AC symbol
- (5) Data access symbol
- (6) Data memory symbol
- (7) Noise symbol
- (8) Data hold symbol
- (9) Battery symbol
- (10) Resistance unit
- (11) Resistance value
- (12) Current unit
- (13) Number of storage groups
- (14) Current value

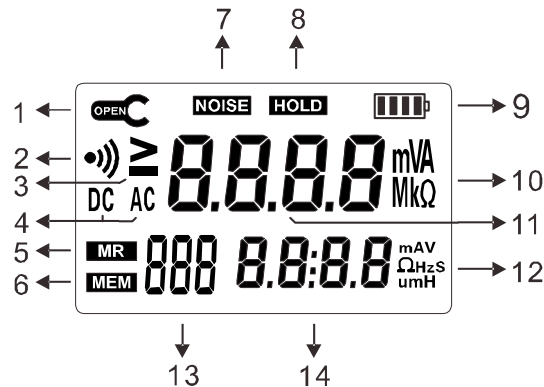

Description of Special Symbols

- (1) Jaw opening symbol: As a jaw is in the open state, the symbol shows. At this point, trigger may be artificially pressed, or the jaws have been seriously polluted, and can no longer continue to measure.
- (2) "Er" Boot error symbol: Trigger may be pressed or jaw is open when the tester is turned on.
- (3) Low battery symbol: When the battery voltage is lower than 5.0V, the symbol shows, and the measurement accuracy cannot be guaranteed at this point, Batteries should be replaced.
- (4) "OL Ω" symbol: Indicates that the measured resistance has exceeded the upper limit of the tester.

9

- (5) "L0.01Ω" symbol: Indicates that the measured resistance has exceeded the lower limit of the tester.
- (6) "OL A" symbol: Indicates that the measured current has exceeded the upper limit of the tester.
- (7) Alarm symbol: When the measured value is greater than the critical value of alarm setting, the symbol flashes, and the tester beeps intermittently.
- (8) MEM Data storage symbol: Flashes when saving data.
- (9) MR Data access symbol: Displays when viewing data, and the number of stored data is displayed at the same time.
- (10) NOISE symbol: When there is a large interference current in the ground loop being tested, the symbol flashes and the tester beeps. At this point, the measurement accuracy cannot be guaranteed.

VIII. Measuring Principle

The basic principle of the ground resistance measurement of the clamp ground resistance tester is to measure the loop resistance. See below. The jaw section of the tester consists of a voltage coil and a current coil. The voltage coil provides the excitation signal and induces a potential V on the circuit under test. Under the action of the potential V, a current I will be generated in the circuit under test. The tester measures V and I and uses the following formula to obtain the measured resistance R.

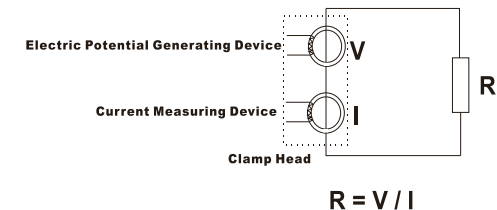

10

IX. Operation Method

1. Turn On/Off

	When turning on the tester, DO NOT press the trigger, open the jaws, or clamp any wire.
	Only press the trigger, open the jaws, or clamp the measured wire after "OL Ω" shows.
	Before starting up, press the trigger once or twice to ensure that the jaws are closed properly.
	When turning on the tester, keep it in the natural state of rest, do not flip it, and do not apply external force to the jaws, otherwise the measurement accuracy cannot be guaranteed.

Press "POWER" key to turn on/off. When the tester is turned on, it automatically calibrates, displays "OL Ω", and enters the resistance measurement mode. If there is no normal self-calibration, "Er" shows, indicating that the boot error occurs. Common causes include the jaws are not closed properly, a wire is clamped during startup, etc.

The tester automatically turns off after 5 minutes. There will be 30 seconds of blinking display before automatic shutdown. Press "POWER" key to delay the shutdown time by 5 minutes.

2. Battery Voltage Check

If the LCD shows low battery symbol "  ", it indicates that the battery power is low. Please replace the batteries to ensure the measurement accuracy.

3. Resistance Test

	When users think the ground value is abnormal, the calibration loop can be used to check whether the tester is normal. The calibration loop has two resistance values of 1Ω and 10Ω.
---	--

Press the trigger, open the jaws, clamp the circuit under test, and read the resistance value.

Resistance and earth leakage can be measured simultaneously. Press "MODE" key to switch between resistance measurement mode and resistance + current measurement mode.

If "OL Ω" shows, it indicates that the measured resistance exceeds the upper limit of the tester.

If "L0.01 Ω" shows, it indicates that the measured resistance exceeds the lower limit of the tester.

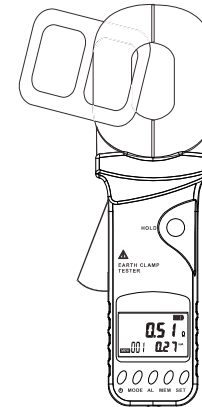

Resistance + current mode:

The measured resistance is 0.51Ω.

The number of storage groups is 1 and the

Measured loop resistance is 0.00mA.

4. Alarm Setting

After starting up, short press "AL" key to turn on or off the alarm function, long press "SET" key to set the resistance alarm value, press "AL" key and "MEM" key to change the current value, short press "MODE" key to switch the alarm mode, and long press "SET" key to save and exit. When the measured resistance is greater than the critical value of alarm setting and the alarm is turned on, ")))" symbol flashes, and the tester beeps intermittently. The maximum alarm value of the ground resistance is 200Ω. As shown below.



5. Data Hold

After the measurement is stable, short press "HOLD" key to hold and save the current data. Short press "HOLD" key again to exit the hold mode. As shown below:

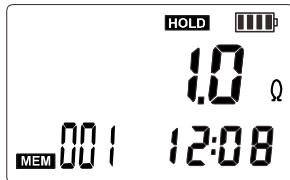

6. Data Storage/Access/Deletion

When the measurement is completed, short press "HOLD" key to store data and "MEM" symbol flashes once. If the memory is full, the tester flashes to display "MEM" symbol. Short press "MEM" key to enter data access and "MR" symbol is displayed. Press "AL" or "SET" key to view the data corresponding to the group number with a step value of 1. Short press "MEM" key again to exit. The left figure below shows that "MEM" symbol flashes once when the data is stored, and the number of storage groups is 1. The right figure below shows the data access mode, and the number of access groups is 1.

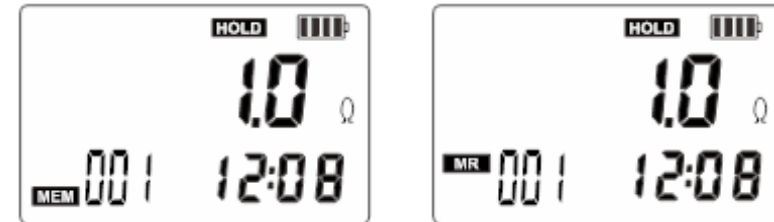

In the data access state, long press "MEM" key, and then press "POWER" key to delete the stored data.

X. Field Application

1. Multi-Point Grounding System

As for the multi-point grounding system (such as electricity transmission tower grounding system, communication cable grounding systems, certain buildings, etc.), they are connected by overhead ground wires (shielding layer of communication cables) to form a grounding system. When the tester is used for measurement, its equivalent circuit is shown in the figure below.

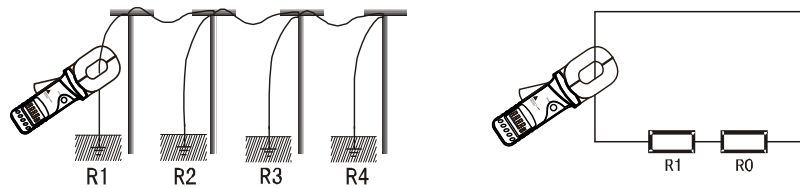

Where: R1 is the target grounding resistance.

R0 is the equivalent resistance of the grounding resistance of all other towers in parallel. Although, from the strict grounding theory, R0 is not the usual parallel value in the sense of electrical engineering (slightly higher than its IEC parallel output value) due to the existence of so-called "mutual resistance". But, since the grounding hemisphere of each tower is much smaller than the distance between the towers, and, after all, the number of grounding points is large, R0 is much smaller than R1. Therefore, it is reasonable to assume R0=0 from an engineering perspective. In this way, the measured resistance should be R1.

Times of comparing tests in different environments and different occasions with the traditional method proved that the above assumption is entirely reasonable.

2. Limited Point Grounding System

For some towers, five towers are linked with each other through overhead ground wires. Besides, the grounding of some buildings is not an independent grounding grid, but several grounding bodies connected with each other through wires.

Under such circumstances, regarding the above R0 as 0 will yield a greater error on the measurement result. For the same reason mentioned above, the impact of the mutual resistance is ignored and the equivalent resistance of the grounding resistance paralleled is calculated in the usual sense. In this way, for the grounding system of N (N is small, but greater than 2) grounding bodies, N equations can be listed:

$$R_1 + \frac{1}{\frac{1}{R_2} + \frac{1}{R_3} + \dots + \frac{1}{R_N}} = R_{IT}$$

$$+ \frac{\quad}{- + - + \quad + -} =$$

$$+ \frac{\quad}{- + - + \quad + -} =$$

Where: R_1, R_2, \dots, R_N are grounding resistance of N grounding bodies.

$R_{1T}, R_{2T}, \dots, R_{NT}$ are the resistance measured with the tester in different grounding branches.

It is nonlinear equations with N unknown numbers and N equations. It indeed has a definite solution, but it is very difficult to solve the issue artificially, even impossible when N is large.

Users can use a PC to get the solution through the Limited-Point Grounding System Calculation software (optional) of our company.

In principle, in addition to ignoring the mutual resistance, this method does not have the measurement error caused by neglecting R_0 .

However, users need pay attention to that: in response to the number of the grounding bodies mutually linked in the grounding system, it is necessary to measure the same number of testing values for calculation, not more or less. And the software would output the same number of grounding resistance values.

3.Single-Point Grounding System

From the measuring principle, the tester can only measure loop resistance, not single-point grounding. However, users can use a testing line and the earth electrode near the grounding system to artificially create a loop for testing. The following presented is two methods for single-point grounding measurement by the tester These methods can be applied to the occasions beyond the reach of the traditional voltage-current testing method.

(1) Two-Point Method

As shown in the figure below, in the vicinity of the measured grounding body RA , find an independent grounding body of better grounding state RB (for example, a nearby water pipe or building). Connect RA and RB with a testing line.

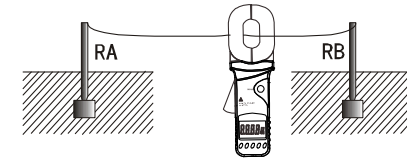

The resistance value measured by the tester is the series value of the two grounding resistance and the resistance of the testing line.

$$R_T = R_A + R_B + R_L$$

Where: R_T is the resistance value measured by the tester.

R_L is the resistance value of the testing line.

R_L can be measured with the tester by connecting the testing line end to end.

So, if the measurement value of the tester is less than the allowable value of the grounding resistance, the grounding resistance of the two grounding bodies is qualified.

(2) Three-Point Method

As shown in the figure below, in the vicinity of the measured grounding body RA , find two independent grounding bodies of better grounding state RB and RC .

First, connect RA and RB with a testing line. Use the tester to get the first reading R_1 .

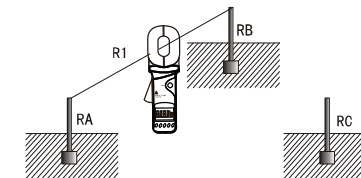

Second, connect RB and RC as shown in the figure below. Use the tester to get the second reading R2.

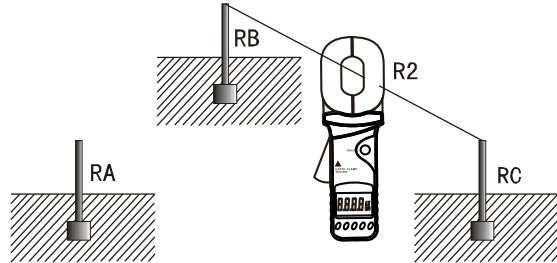

Third, connect RC and RA as shown in the figure below. Use the tester to get the third reading R3.

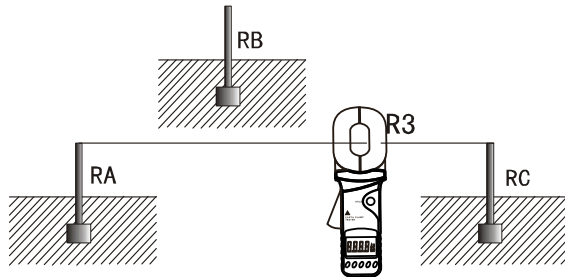

In the above three steps, the reading measured in each step is the series value of the two grounding resistance.

In this way, the value of each grounding resistance can be easily calculated:

$$\text{As: } R1 = RA + RB, R2 = RB + RC, R3 = RC + RA$$

$$\text{So: } RA = (R1 + R3 - R2) \div 2$$

This is the grounding resistance value of the grounding body RA. To facilitate the memory of the above formula, these three grounding bodies can be viewed as a triangle; then the measured resistance is equal to the sum of the resistance values of the adjacent edges minus the resistance value of the opposite side and then divided by 2.

The grounding resistance values of the other two grounding bodies are:

$$RB = R1 - RA$$

$$RC = R3 - RA$$

XI. Packing List

Tester	1pc
Battery	4×1.5V batteries (LR06)
Calibration Loop	1pc
User Manual	1pc
Carrying Case	1pc

The manual information is subject to changes without prior notice!