

momcozy

VIDEO BABY MONITOR

BM01



Looking for help?
Contact us to get expert support.

 www.momcozy.com

 support@momcozy.com

USER GUIDE

5" HD LCD



→ ENGLISH

CONTENTS

SAFETY INSTRUCTIONS	03
CAUTION	03
PACKAGE CONTENTS	04
PRODUCT OVERVIEW	05
GETTING STARTED	08
1. Charging & Powering Baby Monitor	08
2. Powering Camera	08
3. Pairing the Baby Monitor & the Camera	08
4. Placing the Camera	09
5. Wall Mounting Camera	10
FUNCTIONS & OPERATIONS	11
Status Icons	11
1. Volume Adjustment	12
2. Selecting a Camera & Scanning Cameras	12
3. Digital Zoom	12
4. Lullaby	13
5. Talk Back	13
6. Brightness	13
7. Screen Sleep	14
8. Add A New Camera	14
9. Split Screen	15
10. Selecting a Camera & Scanning	16
11. Deleting A Camera	16
12. Speaker Volume	17
13. Alarm Volume	17
14. VOX	18
15. Alarm Clock	18
16. Date/ Time	19
17. Temperature	20
18. Night Vision	20
19. Language	21

20. Lullabies	21
21. Refresh Rate	21
22. Factory Settings	22
23. Contact Us	22
SPECIFICATIONS	23
TROUBLESHOOTING	25
FCC COMPLIANCE	27
WEEE COMPLIANCE	28
IC CAUTION	28

SAFETY INSTRUCTIONS

- Strangulation Hazard—Children have STRANGLED in cords. Keep this cord out of the reach of children (more than 3 ft (0.9 m) away). Do not remove this tag.

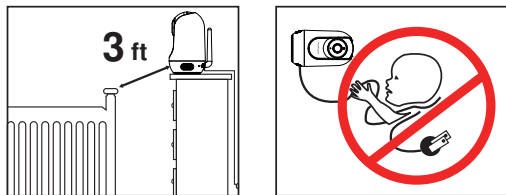

- NEVER place the camera or cord in or near the crib or playpen.
- NEVER mount the camera directly above the crib or playpen to avoid the risk of injury.
- Only use the AC adapters provided.
- Never use the unit near water, including near a bathtub, sink, laundry machine tube, wet basement, etc.
- Do not install near any heat sources such as radiators, heat registers, stoves, or other devices that produce heat.
- Only use attachments and accessories specified by the manufacturer.
- Unplug this device when unused for long periods of time.

CAUTION

- NOT toys. Do not allow children to play with them.
- This product is NOT intended to replace the proper supervision of children. You MUST check your child's activity regularly.
- This product is not intended for use as a medical camera and its use should not replace adult supervision.
- Unplug the product during lightning storms.
- Please check the operating range and condition of the camera carefully at the initial installation, and on a regular basis after that.

- Check the reception regularly. Test the camera before use and after changing the camera's location.
- For indoor use only.
- Clean the camera with a dry cloth only.
- Do not block any ventilation openings.
- Microphone feedback might occur when the monitor is too close to the camera. Please keep them at least 1.5 m / 4.9ft apart.

PACKAGE CONTENTS



Camera



Baby Monitor

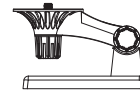

Wall Mount Bracket



Power Cable * 2

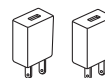

Adapter * 2



User Guide



Screw * 2









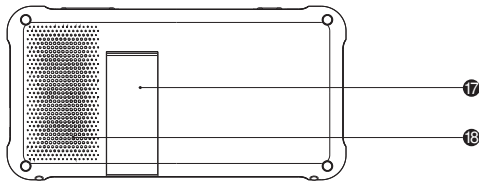
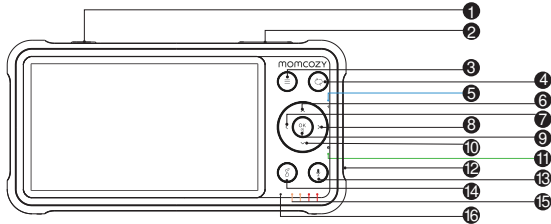

Wall Anchor * 2

PRODUCT OVERVIEW

Monitor



- ① Power On/Off & LCD On/Off: Press and hold for 3 seconds to turn on/off the monitor. Short press: Turn on/off the LCD screen. When the screen is turned on, press and hold for 8 seconds to reset the system.
- ② Volume adjustment: Press the left button to reduce the speaker volume, and press the right button to increase the speaker volume.
- ③ Menu: Press  to enter/exit the menu.
- ④ Camera Switch: Press  to switch to another camera if connected with two or more cameras.
- ⑤ Charging Indicator: Solid blue during charging, and goes out when fully charged; Blinking red when the monitor is in a low power state.
- ⑥ Up Button: Press  to move the camera upward or to change your selection upward.
- ⑦ Left Button: Press  to move the camera leftward or to change your selection leftward.
- ⑧ Right Button: Press  to move the camera rightward or change your selection rightward.
- ⑨ Confirm/Zoom Button: Press  to zoom in/out to confirm your selection.
- ⑩ Down Button: Press  to move the camera downward or change your selection downward.
- ⑪ Monitoring Status Indicator: Green. When the camera is disconnected, it flashes slowly; when the camera enters pairing mode, it flashes quickly; when the camera is turned on, it remains steady.
- ⑫ Indicator: 1. The louder the sound is received by the monitor, the more indicator is on. 2. Signal indicator (temperature alarm/off-connection alarm/feeding alarm).
- ⑬ Talk: Press  to talk to your baby.
- ⑭ Lullaby: Press  to select your desired lullaby song.
- ⑮ Indicator: The louder the sound is received by the monitor, the more indicator is on.
- ⑯ Microphone.
- ⑰ Stand.
- ⑱ Speaker.

Camera

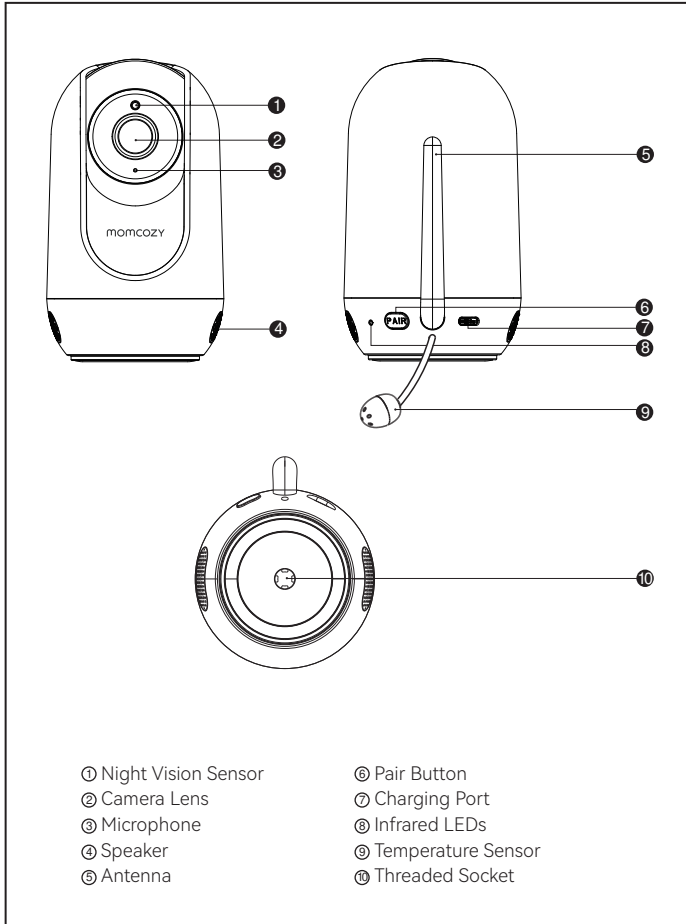

GETTING STARTED

1. Charging & Powering Baby Monitor

- 1) Connect the monitor adapter to the monitor and a power outlet.
- 2) Unplug the unit when its power indicator turns off, indicating a full charge.
Unplug the unit after fully charging the monitor, which can prolong the lifespan of the device.

2. Powering Camera

- 1) Connect the camera to power source via the USB Type-C cable and camera adapter.



- Only use the power adapters provided.
- Do not place the camera and power cord within the reach of your baby.

3. Pairing the Baby Monitor & the Camera

Based on default setting, one camera is paired with the monitor. When you power on the monitor and camera, the two will automatically pair.

Adding a new camera to the baby monitor

Step 1:

1. Press to enter menu page.
2. Choose -> OK button.

Step 2:

1. Select through Add -> -> OK button.

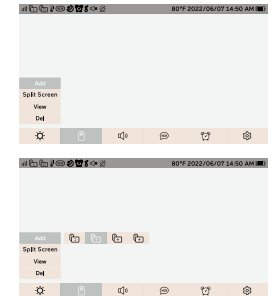

Step 3:

1. Press **PAIR** button on the rear of the camera.
2. Then the monitor will auto-pair with the camera.



- Once they're paired successfully, the camera number with icon  will be shown at the top left of the screen.
- It is recommended to pair in the baby's room, or wherever you intend to place the camera.
- High-pitched noises might occur when the monitor is too close to the camera. Please keep them at least 1.5 m / 4.9ft apart.
- The monitor can connect up to 4 cameras at once.

4. Placing the Camera

For safety concerns and better vision in night vision mode, if the camera is placed on a 0.75 m / 2.5ft table top, the distance from the baby is at least 1.5 m / 4.9ft. (The baby monitor has an infrared night vision capacity up to 6 m / 19.7ft). Most importantly, make sure that the camera power cord is out of your baby's reach.

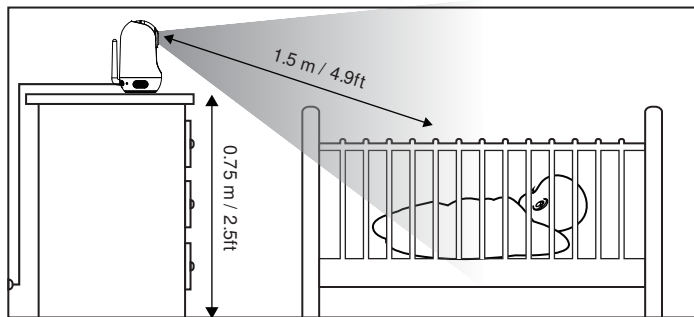

5. Wall Mounting Camera



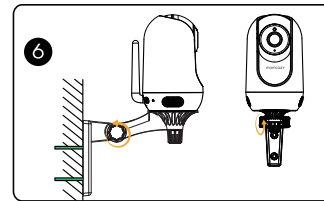
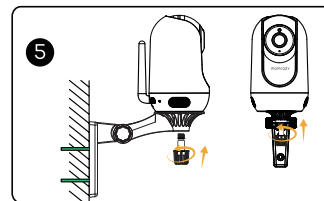
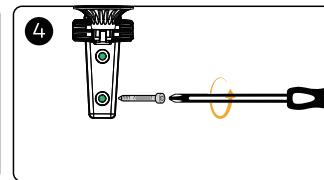
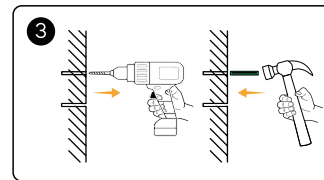
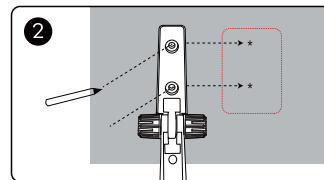
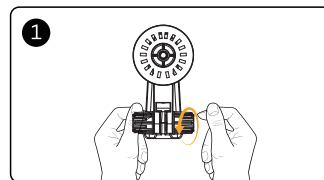









- 1) Rotate the knob in anticlockwise direction to adjust the wall mount bracket, then fasten the joint and secure the angle.
- 2) Mark the upper and lower holes with a pencil.
- 3) Drill holes in the wall (17/64 inch drill bit) and insert wall anchors into holes with a hammer.
- 4) Fasten the wall mount bracket with screws.
- 5) Place the camera on the wall mount bracket. Tighten the screw into the threaded socket at the bottom to secure the camera.
- 6) You can maximize your camera unit's viewing angles by tilting the wall mount bracket. Tilt your camera up or down to adjust to your preferred angle.





- Don't release the camera until it is firmly mounted.

FUNCTIONS & OPERATIONS

Status Icons

	No Signal
	Signal Strength
	Cycle Cameras Enabled (rotate every 10 seconds)
	Camera
12:08	Current Time
	Lullabies Enabled
	VOX Function on
	Temperature Alarm
	Feeding Reminder
	Volume Mute
	Night Vision Mode
°C / °F	Current Room Temperature
	Battery Level
	Alarm Mute





You can use the auto-scan function by short pressing the  button until you see  on the screen. Then the camera view cycles through the list of connected cameras every 10 seconds. And if there is an alarm, the auto-scan function will pause temporarily.

1. Volume Adjustment

Use Shortcut Button:

Press  Button ->Left/Right button to quickly adjust the volume.



To adjust system sound, navigate to Monitor  ->  -> Alarm volume.

2. Selecting a Camera & Scanning Cameras

Note:

This function requires more than two cameras to be turned on. Multiple cameras are powered on and within the monitor connection range.

Selecting a Camera

Step 1:

Check the camera icons, click  to switch to the next camera view.

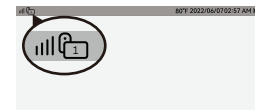

Scanning Cameras

Step 2:

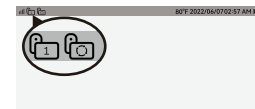

After switching all camera views, click the  button again. Then the camera view transits from one to other connected cameras every 10 seconds, displaying a loop icon at the top left of the screen.



Step 3:

Click  again to stop scanning. Then the camera will switch to single camera view.

3. Digital Zoom

Press  button to zoom in the screen to 2X and 4X respectively in camera viewing mode. Press  button for the third time to adjust the zoom setting back to default.

4. Lullaby

Use Shortcut Button:

Press to enter the lullaby page. Press & buttons to select the lullaby song, press & buttons to adjust the volume of the lullaby, and press **OK** to turn on or off the lullaby.

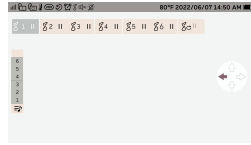

5. Talk Back

Press and hold Button to talk to your baby, release it to exit the talking mode.



- When you are in the monitoring mode, press and hold the button to enter the intercom mode, and the icon will be displayed on the monitor. When you enter the menu, the intercom function can still be used, but the icon will not appear on the screen.
- When it's mute or the speaker volume is too low, you may not be able to hear the baby.
- When you're pressing the Button, the camera will not transfer the sound to the monitor. Please release the button to listen to your baby.

6. Brightness

Explanation:

This function is used to adjust the screen brightness of the monitor.

Step 1:

- Press to enter menu page.
- Choose -> **OK** button.

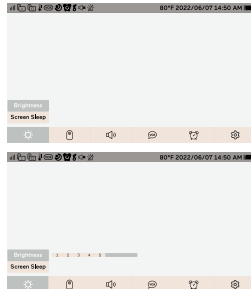

Step 2:

- Select the **Brightness** Setting to change the monitor screen Brightness.

7. Screen Sleep

Explanation:

This function is to set the monitor screen to sleep without powering off the monitor.

Step 1:

- Press to enter menu page.
- Choose -> **OK** button.

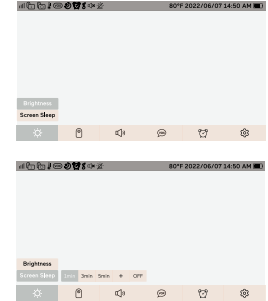

Step 2:

- Select the **Screen Sleep** and select the time you want.



- Click to enter the page for customizing the resting time. The resting time ranges from 1 to 60 minutes.
- The screen will automatically light up if there is a VOX or a temperature alert.
- When VOX is turned off, the screen will not automatically wake up and light up.
- When the sleep time is set to "OFF", the monitor will not be off the screen.

8. Add A New Camera

Step 1:

- Press to enter menu page.
- Choose -> **OK** button.



Step 2:

1. Select through **Add** ->  -> OK button.

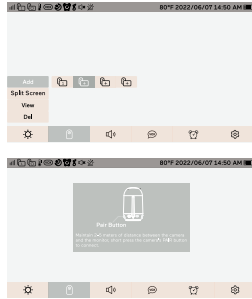

Step 3:

1. Press  PAIR button on the rear of the camera.
2. Then the monitor shows the camera is paired successfully.





• The monitor can connect up to 4 cameras at once.

9. Split Screen

Explanation:

This function is to display two camera views on a single screen.

Step 1:

1. Press  to enter menu page.
2. Select through  -> **Split Screen** -> OK button.

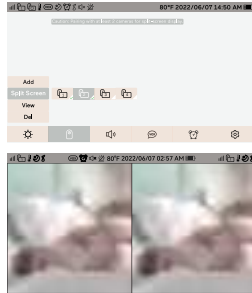

Step 2:

1. Select another camera that needs a split screen and press OK. Then the monitor will give you a split screen view.





• Select the camera on the split screen and press OK. If the camera is not selected, the monitor will exit the split screen mode.

10. Selecting a Camera & Scanning

Note:

This function requires more than two cameras to be turned on. Multiple cameras are powered on and within the monitor connection range.

Step 1:

1. Press  to enter menu page.
2. Select through  -> **View** -> OK button.

Step 2:

1. Select the camera you want to switch and press OK button.

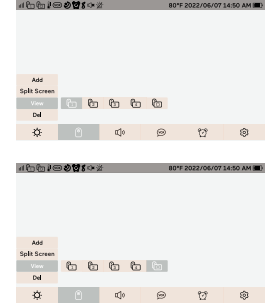

Step 3:

1. If you need to cycle multiple camera views. Select  -> OK button.



11. Deleting A Camera

Step 1:

1. Press  to enter menu page.
2. Select through  -> **Del** -> OK button.

Step 2:

1. Select the camera you want to delete and press OK button.

Step 3:

1. Select **YES**. The camera is deleted successfully.

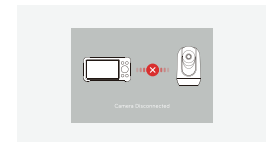



· The monitor is paired with one camera by default, you should keep at least one camera connected.

12. Speaker Volume

Explanation:

This function is used to adjust the speaker volume of the monitor.

Step 1:

1. Press to enter menu page.
2. Choose -> OK button
-> **Speaker Volume** -> Left / Right button to decrease/increase the volume, and press OK Button to save your settings.



13. Alarm Volume

Explanation:

This function is to adjust the monitor system sound.

Step 1:

1. Press to enter menu page.
2. Select through -> **Alarm Volume**
-> OK button.



Step 2:

1. Select the preferred alarm sound level.
Press OK button.

14. VOX

Explanation:

1. This function is used to wake up the monitor screen and light up. There are three wake-up levels (low/medium/high). When the sound detected by the camera reaches 75dB/65dB/60dB or more, the monitor will wake up to trigger the alarm and the LED indicator will flash.
2. Caution: The screen will not wake up automatically if VOX is turned off.

Step 1:

1. Press to enter menu page.
2. Choose -> OK button.

Step 2:

1. Select the option you want.
Press OK button.

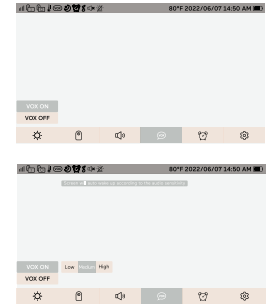

15. Alarm Clock

Explanation:



This function is to remind you of feeding your baby. OFF means you turn off the function; 2 hours mean it reminds you every 2 hours and so on for the other options.

Step 1:

1. Press to enter menu page.
2. Choose -> OK button.



Step 2:

1. Select **Remind** and set the time you want. Press **OK** to start / finish setting.  stands for starting the setting.
2.  stands for finishing the setting.





Step 3:

1. Select **Repeat** to create a recurring alarm and choose the scheduled time you want your alarm to repeat.



16. Date/Time

Step 1:

1. Press  to enter menu page.
2. Choose  -> **Time/Date** -> **OK** button.



Step 2:

1. Press **OK** to start / finish setting.  stands for starting the setting.



Step 3:

1.  stands for finishing the setting.





· Press Up/Down/Left/Right to select and press  button to confirm.

17. Temperature

Explanation:

you can set the maximum/minimum temperature and turn on the temperature alert, so that the baby monitor beeps whenever the room temperature falls outside the desired temperature range. You can also choose to display the temperature in Fahrenheit (°F) or Celsius (°C) on your monitor.

Step 1:

1. Press  to enter menu page.
2. Choose  -> **Temperature** -> **OK** button.



Step 2:

1. Press **OK** to start / finish setting.  stands for starting the setting.

Step 3:

1.  stands for finishing the setting.





· A temperature alarm can be temporarily turned off by pressing any button on the monitor.

18. Night Vision

Explanation:

In normal mode, the camera displays color images during the day, during nighttime the camera displays black and white images.

Step 1:

1. Press  to enter menu page.
2. Choose  -> **Night Vision** -> **OK** button.



Step 2:

1. Press **OK** button to switch to night vision mode.





· When the camera is set to night vision mode, the monitor will display black and white images both day and night.

19. Language

Explanation:

There are four languages available in your device, you can choose your language here.

Step 1:

1. Press  to enter menu page.
2. Choose  -> **Language**
-> OK button.



Step 2:

1. Select the desired language and press OK button.

20. Lullabies

Explanation:

This function is to comfort baby with soothing lullabies.

Step 1:

1. Press  to enter menu page.
2. Choose  -> **Lullabies**
-> OK button.

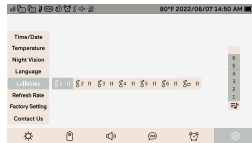

Step 2:

1. Select your desired lullaby and press "OK" to turn it on/off. Press up/down button to increase or decrease the lullaby sound. Select  to play the lullaby on a loop.





21. Refresh Rate

Explanation:

You can change the image refresh frequency of the camera to ensure that the camera works normally.

Step 1:

1. Press  to enter menu page.
2. Choose  -> **Refresh Rate**
-> OK button.



Step 2:



1. Set the refresh frequency based on use in your area.

22. Factory Settings

Explanation:

System will be restored to default Settings.

Step 1:

1. Press  to enter menu page.
2. Choose  -> **Factory Setting**
-> OK button.



Step 2:

1. Choose **YES** -> OK button
to start restoring factory settings.

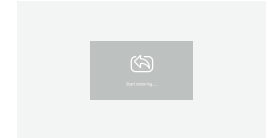

· Press and hold the display power button for 8 seconds to force the display to shut down.

23. Contact Us

Step 1:

1. Press  to enter menu page.
2. Choose  -> **Contact Us**
-> OK button.

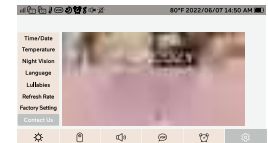

Step 2:

1. Press  return to menu page.

SPECIFICATIONS

Monitor

Connectivity	2.4GHz
Image Aspect	16:9
Image Compression	H.264
Operating Range	960ft (line of sight, no obstructions)
Temperature Alert	Yes
Volume Control	9 levels
Brightness	8 levels
Operating Voltage	5V \approx 2A
Zoom	Zoom In (2X) Zoom In (4X)
Two-Way Talk	Yes
Multi-Camera	Max. 4 cameras
Storage Temperature	-20 °C to 70 °C / -4 °F to 158 °F
Operation Temperature	0 °C to 40 °C / 32 °F to 104 °F

Camera

Connectivity	2.4GHz
Image Compression	H.264
Operating Voltage	5V \approx 2A
Pan-n-Tilt	90 degrees vertical (Up=50°, Down=40°) 350 degrees horizontal (Left=175°, Right=175°)
Zoom	Zoom In (2X) Zoom In (4X)
Night Vision	Black & White image
IR LED	Non-visible IR LED with wave length 940nm
Light Sensor	Yes
Two-Way Talk	Yes
Storage Temperature	-20 °C to 70 °C / -4 °F to 158 °F
Operation Temperature	0 °C to 40 °C / 32 °F to 104 °F

TROUBLESHOOTING

Product not powering on?	<ul style="list-style-type: none"> · Check that the camera and monitor are turned on. · Check the camera and make sure it is well plugged into the outlet. · Check that the monitor is of enough battery (When the battery icon flashes red, the monitor will automatically shut off after 10 minutes).
Baby monitor can't connect with the camera?	<ul style="list-style-type: none"> · Check whether the camera is near the monitor (recommended to keep distance within 1.5–2 m / 4.9–6.6ft). · Check whether the monitor is of low battery. Charge it in time to keep a good connection. · Check whether the camera is well-connected to power. · Check whether there are any large metallic objects including doors, refrigerators, mirrors, etc., placed between the camera and monitor thus blocking the radio signals. · Check, whether there's any other 2.4GHz product, is used nearby like Wi-Fi routers, and microwave ovens, which may interfere with the connection. · If nothing above is involved, please try to pair again.
Nothing shown when I view a camera?	<ul style="list-style-type: none"> · Check all connections to the camera (power cable plugging and pairing). · Check whether the screen is in sleep mode. Press any button to wake it. · Check whether the camera is within monitor connection range.

No sound from the monitor?	· Check whether the system sound volume is set too High or Low. It'll be mute if set so.
Black and white pictures?	· Night vision LED may be ON. Please turn on the room lights to force it out of the night mode.
Choppy videos?	· Check whether the camera is near the monitor and that there're no obstacles between them. 增加 be
Too much noise?	<ul style="list-style-type: none"> · Volume may be set too high. Press Shortcut Button -> Left Button to reduce the volume. · The camera and monitor may be too close; keep them at least 1.5 m / 4.9ft apart.

WARRANTY & CUSTOMER SERVICE

12 months guarantee (contact information can be found on the monitor or on the cover of this user manual)

FCC COMPLIANCE (Camera)

Any Changes or modifications not expressly approved by the party responsible for compliance could void the user's authority to operate the equipment.

This device complies with part 15 of the FCC Rules. Operation is subject to the following two conditions:

- (1) This device may not cause harmful interference, and
- (2) this device must accept any interference received, including interference that may cause undesired operation.

Note:

This equipment has been tested and found to comply with the limits for a Class B digital device, pursuant to part 15 of the FCC Rules. These limits are designed to provide reasonable protection against harmful interference in a residential installation. This equipment generates uses and can radiate radio frequency energy and, if not installed and used in accordance with the instructions, may cause harmful interference to radio communications.

However, there is no guarantee that interference will not occur in a particular installation. If this equipment does cause harmful interference to radio or television reception, which can be determined by turning the equipment off and on, the user is encouraged to try to correct the interference by one or more of the following measures:

- Reorient or relocate the receiving antenna.
- Increase the separation between the equipment and receiver.
- Connect the equipment into an outlet on a circuit different from that to which the receiver is connected.
- Consult the dealer or an experienced radio/TV technician for help.

FCC 20cm Statement

This equipment complies with FCC radiation exposure limits set forth for an uncontrolled environment. This equipment should be installed and operated with a minimum distance of 20cm between the radiator & your body. This transmitter must not be co-located or operating in conjunction with any other antenna or transmitter.

IC statement

This device contains licence-exempt transmitter(s)/receiver(s) that comply with Innovation, Science and Economic Development Canada's licence-exempt RSS(s). Operation is subject to the following

two conditions:

- (1) This device may not cause interference.
- (2) This device must accept any interference, including interference that may cause undesired operation of the device.

The term "IC: " before the certification/registration number only signifies that the Industry Canada technical specifications were met.

This product meets the applicable Industry Canada technical specifications.

Cet appareil contient des émetteurs / récepteurs exemptés de licence conformes aux RSS (RSS)

d'Innovation, Sciences et Développement économique Canada. L'exploitation est autorisée aux deux conditions suivantes : (1) l'appareil ne doit pas produire de brouillage, et (2) l'utilisateur de

l'appareil doit accepter tout brouillage radioélectrique subi, même si le brouillage est susceptible

d'en compromettre le fonctionnement.

L'émetteur/récepteur exempt de licence contenu dans le présent appareil est conforme aux CNR

d'Innovation, Sciences et Développement économique Canada applicables aux appareils radio exempts de licence.

L'exploitation est autorisée aux deux conditions suivantes :

- 1) L'appareil ne doit pas produire de brouillage;
- 2) L'appareil doit accepter tout brouillage radioélectrique subi, même si le brouillage est susceptible

d'en compromettre le fonctionnement.

This transmitter must not be co-located or operating in conjunction with any other antenna

or transmitter. This equipment should be installed and operated with a minimum distance of

20 centimeters between the radiator and your body. Cet émetteur ne doit pas être Co-placé ou ne fonctionnant en même temps qu'aucune autre

antenne ou émetteur. Cet équipement devrait être installé et actionné avec une distance minimum

de 20 centimètres entre le radiateur et votre corps.

FCC COMPLIANCE (Monitor)

Any Changes or modifications not expressly approved by the party responsible for compliance could void the user's authority to operate the equipment. This device complies with part 15 of the FCC Rules. Operation is subject to the following two conditions:

- (1) This device may not cause harmful interference, and
- (2) this device must accept any interference received, including interference that may cause undesired operation.

This equipment has been tested and found to comply with the limits for a Class B digital device, pursuant to part 15 of the FCC Rules. These limits are designed to provide reasonable protection against harmful interference in a residential installation. This equipment generates uses and can radiate radio frequency energy and, if not installed and used in accordance with the instructions, may cause harmful interference to radio communications. However, there is no guarantee that interference will not occur in a particular installation. If this equipment does cause harmful interference to radio or television reception, which can be determined by turning the equipment off and on, the user is encouraged to try to correct the interference by one or more of the following measures:

- Reorient or relocate the receiving antenna.
- Increase the separation between the equipment and receiver.
- Connect the equipment into an outlet on a circuit different from that to which the receiver is connected.
- Consult the dealer or an experienced radio/TV technician for help.

IC statement (Monitor)

This device contains licence-exempt transmitter(s)/receiver(s) that comply with Innovation, Science and Economic Development Canada's licence-exempt RSS(s). Operation is subject to the following two conditions:

- (1) This device may not cause interference.
- (2) This device must accept any interference, including interference that may cause undesired operation of the device.
- (3) The device has been evaluated to meet general RF exposure requirement. The device
- (4) can be used in portable exposure condition without restriction.

Cet appareil contient des émetteurs/récepteurs exemptés de licence qui sont conformes aux flux RSS exemptés de licence de Innovation, Science et développement économique Canada. L'exploitation est soumise aux deux conditions suivantes:

- 1) cet appareil ne doit pas causer d'interférences.
- (2) ce dispositif doit accepter toute interférence, y compris toute interférence susceptible de provoquer un fonctionnement indésirable du dispositif.
- (3) l'appareil a été évalué pour répondre aux exigences générales d'exposition aux RF. Le dispositif
- (4) peut être utilisé dans des conditions portatives d'exposition sans restriction

FCC/IC RF Radiation Exposure and SAR Statements

The xTablet T1190 has been tested for body-worn Specific Absorption Rate (SAR) compliance. The FCC/IC has established detailed SAR requirements and has established that these requirements. RF Exposure Information The radio module has been evaluated under FCC Bulletin C95.1 and IEEE 1528 and found to be compliant to RF Exposure from radio frequency devices. This model meets the applicable government requirements for exposure to radio frequency waves. The highest reported SAR level for usage near the body (0mm) is 0.518 W/kg