



COMBIMASTER

**120V Series: 12/1500-60,
12/2000-100, 12/3000-160, 24/2000-60, 24/3000-70,
12/3500-200, 24/3500-100, 24/4500-120, 48/5000-70**

INVERTER CHARGER COMBINATION
WITH AC-IN SUPPORT



CZONE



USER AND INSTALLATION MANUAL

- Ⓔ EN For the latest version of this manual, visit our website:
- Ⓔ ES Para descargar este manual en otros idiomas, visite nuestro sitio web:
- Ⓔ FR Pour télécharger ce manuel dans d'autres langues, consultez notre site Web :



www.mastervolt.com

TABLE OF CONTENTS

1 SAFETY INSTRUCTIONS	3	6 OPERATION	34
1.1 General	3	6.1 Switching on / charge only	34
1.2 Warnings regarding the use of batteries ..	4	6.2 Status LEDs	34
1.3 Location.....	5	6.3 Remote control.....	35
1.4 Connections	5	6.4 3-step+ charge process.....	35
1.5 Warning regarding life support applications	5	6.5 Temperature compensated charging.....	36
2 GENERAL INFORMATION	6	6.6 Reset the thermal breaker after an overload	36
2.1 Liability	6	6.7 Maintenance	37
2.2 Warranty.....	6	6.7.1 Decommissioning	37
2.3 Identification label.....	6	6.7.2 Storage and transportation	37
2.4 Correct disposal of this product	6	7 PARALLEL AND SPLIT-PHASE SYSTEMS	38
3 PRODUCT DESCRIPTION	7	7.1 General information.....	38
3.1 Overview of the connections.....	7	7.2 Materials needed	39
3.1.1 Models 1500W, 2000W, 3000W	7	7.3 Preparations	39
3.1.2 Models 3500W, 4500W, 5000W	8	7.4 DC wiring	40
3.2 Operating modes.....	8	7.5 AC wiring	41
3.3 Protection	10	7.5.1 AC wiring of single-phase parallel units.....	42
4 INSTALLATION	11	7.5.2 AC wiring of split-phase units (one unit for each phase).....	43
4.1 Unpacking	11	7.5.3 AC wiring of split-phase (two parallel units for each phase)	45
4.2 Location.....	11	7.6 Network wiring	46
4.3 Batteries.....	12	7.6.1 Preparation.....	46
4.4 Connection examples	13	7.6.2 Network wiring of single-phase parallel units.....	47
4.4.1 Models 1500W, 2000W, 3000W	13	7.6.3 Network wiring of split-phase units.....	47
4.4.2 Models 3500W, 4500W, 5000W	14	7.6.4 Network wiring of two units in split-phase with two units in parallel.....	48
4.5 Wiring	15	7.7 Configuration and initial start-up.....	48
4.5.1 DC wiring	15	7.7.1 DIP switches (for a single-phase parallel configuration in a basic MasterBus system).....	49
4.5.2 AC wiring.....	16	7.7.2 MasterAdjust.....	50
4.5.3 AC safety grounding.....	17	7.7.3 CZone Configuration Tool.....	51
4.5.4 Network wiring (CZone/MasterBus).....	18	7.8 Breaking down a cluster.....	53
4.6 Tools and materials needed	19	8 TROUBLESHOOTING	54
4.7 Installation step-by-step.....	20	9 TECHNICAL DATA	56
4.8 Accessories connector (dry contacts)	23	9.1 Inverter specifications	56
4.8.1 Remote switch.....	24	9.2 Charger specifications.....	57
4.8.2 Output.....	24	9.3 Transfer system specifications	59
5 SETTINGS	25	9.4 Miscellaneous	60
5.1 DIP switch settings	25	9.5 CZone specifications.....	60
5.2 MasterBus configuration	26	9.6 Characteristics	61
5.2.1 Monitoring tab	26	9.7 Dimensions	62
5.2.2 Alarms tab.....	28		
5.2.3 History tab.....	28		
5.2.4 Configuration tab.....	28		
5.2.5 Events tab – System automation.....	31		
5.3 CZone configuration	32		

1 SAFETY INSTRUCTIONS

IMPORTANT SAFETY INSTRUCTIONS

SAVE THESE INSTRUCTIONS

1.1 General

1. This manual contains important safety and operating instructions for the following models:

Model	Product code
CombiMaster 12V/1500W-60A 120V	35511500
CombiMaster 12V/2000W-100A 120V	35512000
CombiMaster 12V/3000W-160A 120V	35513000
CombiMaster 12V/3500W-200A 120V	35513500
CombiMaster 24V/2000W-60A 120V	35522000
CombiMaster 24V/3000W-70A 120V	35523000
CombiMaster 24V/3500W-100A 120V	35523500
CombiMaster 24V/4500W-120A-HT 120V	35524500
CombiMaster 48V/5000W-70A-HT 120V	35545000

These models are further referred to as “CombiMaster Inverter/Charger”.

2. CAUTION – To reduce risk of injury, the CombiMaster Inverter/Charger may only be used for charging Lead-acid type (flooded, Gel, AGM) or Mastervolt Lithium-Ion rechargeable batteries and the supply of loads attached to these batteries, in permanent systems. Other types of batteries may burst causing personal injury and damage.
3. Do not expose the CombiMaster Inverter/Charger to rain, snow, spray, moisture, excessive pollution, aggressive environments, ammonia, salt or condensing circumstances.
4. Use of an attachment not recommended or sold by Mastervolt may result in a risk of fire, electric shock, or injury to persons.
5. Except for making the electrical connections, the CombiMaster Inverter/Charger may not be opened. There are no serviceable parts inside the casing. Do not disassemble the CombiMaster Inverter/Charger; take it to qualified service personnel when service or repair is required. Incorrect reassembly may result in a risk of electric shock or fire.
6. To reduce risk of electric shock, disconnect the CombiMaster Inverter/Charger from both AC and DC electrical system before attempting any maintenance or cleaning. Turning off controls will not reduce this risk. Be sure that third parties cannot reverse the measures taken.
7. The CombiMaster Inverter/Charger is not to be used by children or persons with reduced physical, sensory or mental capabilities, or lack of experience and knowledge, unless they have been given supervision or instruction.
8. In case of fire, you must use the fire extinguisher which is appropriate for electrical equipment.
9. CAUTION – Risk of Electric Shock. Both AC and DC voltage sources are terminated inside this equipment. Each circuit must be individually disconnected before servicing.
10. CAUTION – Risk of electric shock from energy stored in capacitor. Do not remove cover until 5 minutes after disconnecting all sources of supply.

1.2 Warnings regarding the use of batteries

1. WARNING – RISK OF EXPLOSIVE GASES

- i. WORKING IN VICINITY OF A LEAD-ACID BATTERY IS DANGEROUS. BATTERIES GENERATE EXPLOSIVE GASES DURING NORMAL BATTERY OPERATION. FOR THIS REASON, IT IS OF UTMOST IMPORTANCE THAT EACH TIME BEFORE SERVICING THE COMBIMASTER INVERTER/CHARGER IN THE VICINITY OF THE BATTERY, YOU READ THIS MANUAL AND FOLLOW THE INSTRUCTIONS EXACTLY.
- ii. To reduce risk of battery explosion, follow these instructions and those published by battery manufacturer and manufacturer of any unit you intend to use in vicinity of battery. Review cautionary marking on these products and on engine.

2. PERSONAL PRECAUTIONS

- i. Someone should be within range of your voice or close enough to come to your aid when you work near a lead-acid battery.
- ii. Have plenty of fresh water and soap nearby in case battery acid contacts skin, clothing, or eyes.
- iii. Wear complete eye protection and clothing protection. Avoid touching eyes while working near battery.
- iv. If battery acid contacts skin or clothing, wash immediately with soap and water. If acid enters eye, immediately flood eye with running cold water for at least 10 min and get medical attention immediately.
- v. NEVER smoke or allow a spark or flame in vicinity of battery or engine.
- vi. Do not short circuit battery! Be extra cautious to reduce risk of dropping a metal tool onto battery. It might spark or short-circuit battery or other electrical part that may cause explosion.
- vii. Remove personal metal items such as rings, bracelets, necklaces, and watches when working with batteries. A battery can produce a short-circuit current high enough to weld a ring or the like to metal, causing a severe burn.
- viii. NEVER charge a frozen battery.
- ix. If necessary, to remove battery from a vessel or vehicle, always remove grounded terminal from battery first. Make sure all accessories in the vessels or vehicle are off, so as not to cause an arc.
- x. Be sure that the area around battery is well ventilated.
- xi. Clean battery terminals. Be careful to keep corrosion from coming in contact with eyes.
- xii. Study all battery manufacturer's specific precautions such as removing or not removing cell caps while charging and recommended rates of charge.
- xiii. Add distilled water in each cell until battery acid reaches level specified by battery manufacturer. This helps purge excessive gas from cells. Do not overfill. For a battery without cell caps (e.g. AGM, Gel or Li-ion batteries), carefully follow manufacturer's recharging instructions.
- xiv. A battery is heavy! It may become a projectile if it is involved in an accident! Ensure adequate and secure mounting and always use suitable handling equipment for transportation.

1.3 Location

1. COMBIMASTER INVERTER/ CHARGER LOCATION

- i. Locate the CombiMaster Inverter/Charger away from battery in a separate, well-ventilated compartment.*
- ii. Never place the CombiMaster Inverter/Charger directly above battery; gases from battery will corrode and damage the CombiMaster Inverter/Charger.*
- iii. Never allow battery acid to drip on the CombiMaster Inverter/Charger when reading gravity or filling battery.*
- iv. Do not operate the CombiMaster Inverter/Charger in a closed-in area or restrict ventilation in any way. To reduce risk of fire hazard, do not cover or obstruct the ventilation openings.

* *This restriction does not apply to Li-ion batteries.*

1.4 Connections

1. DC CONNECTION PRECAUTIONS

- i. Connect and disconnect DC output connections only after setting any switches of the CombiMaster Inverter/Charger to off position and removing AC connections or opening AC disconnect switch.
- ii. Short circuiting or reversing polarity will lead to serious damage to batteries, the CombiMaster Inverter/Charger, wiring as well as accessories. Fuses cannot prevent damage caused by reversed polarity and the warranty will be void.
- iii. When you exceed the rated maximum DC input voltage, you may damage the CombiMaster Inverter/Charger.

2. EXTERNAL CONNECTIONS TO CombiMaster Inverter/Charger SHALL COMPLY WITH THE UNITED STATES COAST GUARD ELECTRICAL REGULATIONS (33CFR183, SUB PART I).

3. GROUNDING INSTRUCTIONS – The CombiMaster Inverter/Charger should be connected to a grounded, metal, permanent wiring system; or an equipment-grounding conductor should be run with circuit conductors and connected to equipment-grounding terminal or lead on unit. Connections to the CombiMaster Inverter/Charger should comply with all local codes and ordinances.

1.5 Warning regarding life support applications

Mastervolt products are not designed to be used as component of medical equipment, unless negotiated in the form of a written agreement between customer and/or manufacturer and Mastervolt. Such agreement will require the equipment manufacturer either to contract additional reliability testing of the Mastervolt parts and/or to commit to undertake such testing as a part of the manufacturing process. Furthermore, the manufacturer must agree to indemnify and not hold Mastervolt responsible for any claims arising from the use of the Mastervolt parts in the life support equipment.

2 GENERAL INFORMATION

2.1 Liability

Mastervolt can accept no liability for:

- Consequential damage resulting from the use of the CombiMaster Inverter/Charger.
- Possible errors in the included manual and the consequences of these.
- Use that is inconsistent with the purpose of the product.

Disclaimer: Our products are subject to continual development and improvement. Therefore, additions or modifications to the products may cause changes to the technical data and functional specifications. No rights can be derived from this document. Please consult our most current Terms & Conditions of Sale.

2.2 Warranty

The Mastervolt product warranty covers the CombiMaster 120V Series for the first two years after the purchase date, on the condition that the product is installed and used according to the instructions in this manual. Installation or use that do not comply with these instructions may result in under performance, damage or failure of the product and may void this warranty. The warranty is limited to the cost of repair and/or replacement of the product. Costs of labor or shipping are not covered by this warranty.

2.3 Identification label

The following picture is only an example!



Part number

Serial number
L821A0001,
device version
"A".

Important information required for service or maintenance can be derived from the identification label. The identification label is located at the right-hand side of the CombiMaster Inverter/Charger



CAUTION!

Never remove the identification label. This will void the warranty

Figure 1: Example of an identification label

2.4 Correct disposal of this product



This product is designed and manufactured with high quality materials and components, which can be recycled and reused. Please be informed about the local separate collection system for electrical and electronic products. Please act according to your local rules and do not dispose of your old products with your normal household waste.

The correct disposal of your old product will help prevent potential negative consequences to the environment and human health.

3 PRODUCT DESCRIPTION

The CombiMaster Inverter/Charger is a battery charger, inverter and AC transfer system in one compact case.

3.1 Overview of the connections

3.1.1 Models 1500W, 2000W, 3000W

Front side with open connection compartment

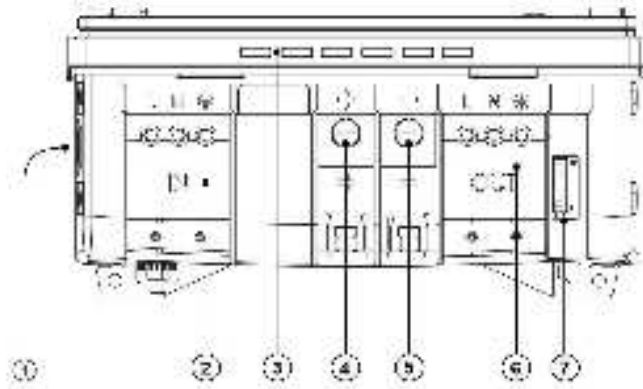

Bottom side

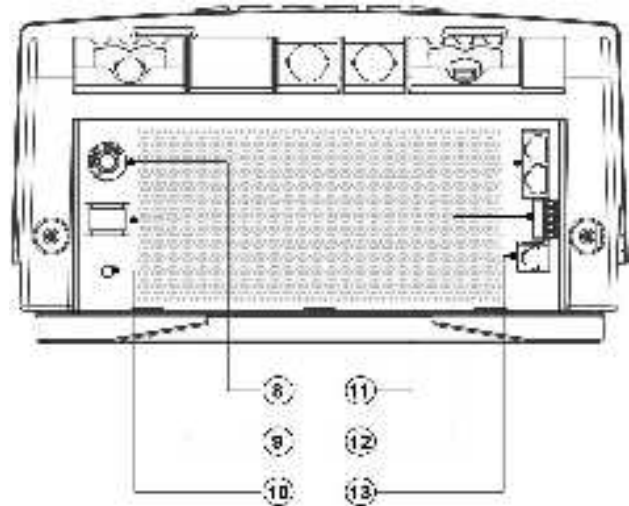
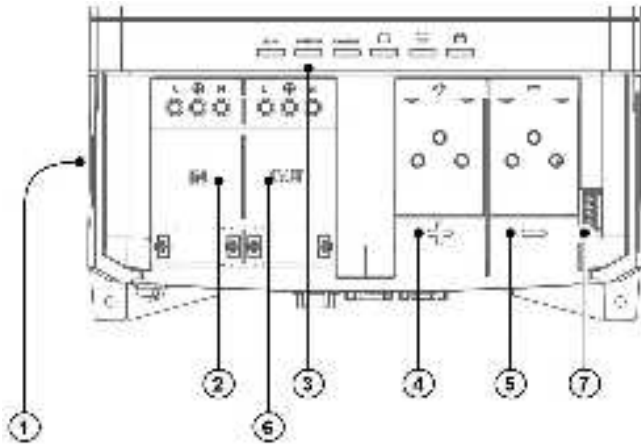

Figure 2. Connections for models with product code: 35511500, 35512000, 35513000, 35522000, 35523000.

- | | |
|--------------------------------|------------------------------------|
| 1 Neutral-ground bonding | 8 Resettable thermal breaker (30A) |
| 2 AC input | 9 "On/Charge only"-switch |
| 3 Status LEDs | 10 5/16" Ground stud |
| 4 M8 Positive battery terminal | 11 CZone/MasterBus connection |
| 5 M8 Negative battery terminal | 12 Accessories connector |
| 6 AC output | 13 Temperature sensor connection |
| 7 DIP switches | |

3.1.2 Models 3500W, 4500W, 5000W

Front side with open connection compartment



Bottom side

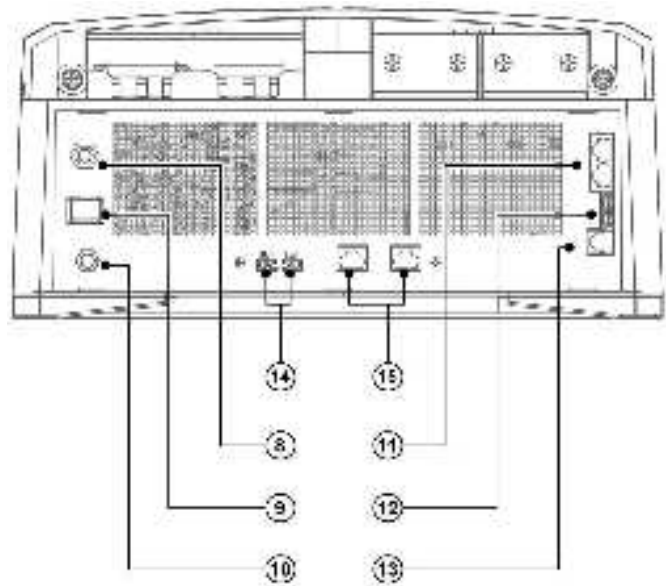

Figure 3. Connections for models with product code: 35513500, 35523500, 35524500, 35545000.

- | | |
|------------------------------------|---|
| 1 Neutral-ground bonding | 9 "On/Charge only"-switch |
| 2 AC input | 10 5/16" Ground stud |
| 3 Status LEDs | 11 CZone/MasterBus connection |
| 4 5/16" Positive battery terminal | 12 Accessories connector |
| 5 5/16" Negative battery terminal | 13 Temperature sensor connection |
| 6 AC output | 14 Current sharing (parallel unit configuration) |
| 7 DIP switches | 15 Cluster communication ports (multi-unit configuration) |
| 8 Resettable thermal breaker (50A) | |

For information on multi-unit configurations, see chapter 7.

3.2 Operating modes

- Inverter mode:** When there is no external AC power available, the inverter provides AC power on the AC output. If energy saving mode is enabled, battery power consumption will be reduced when there is no load on AC OUT. Please note that some electronic loads such as wifi routers, satellite receivers, or digital clocks are most likely not to work in this mode.
- Charger mode:** When external AC power is available on the AC input, the battery will be charged and the AC output is supplied by the external power.

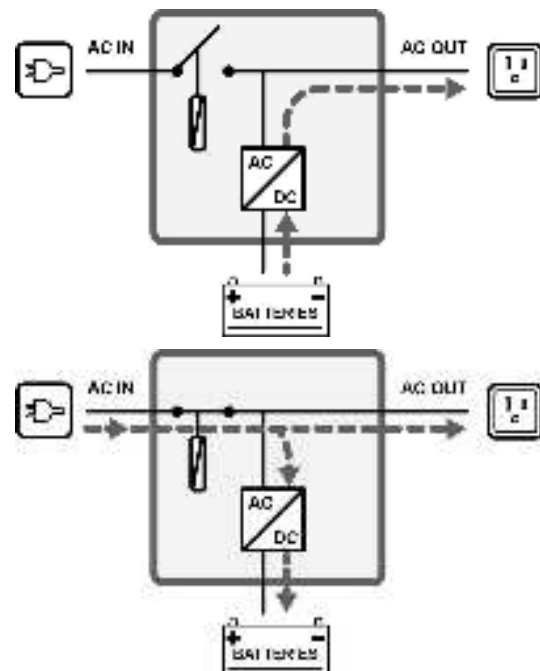

- **DC power supply mode:** During an installation procedure, it may be desirable to test onboard systems before connecting a battery bank. To do this, start the CombiMaster Inverter/Charger with no load connected. Wait for one minute and then connect a low power DC load. In small steps, 25A max, more loads can be switched-in sequentially. Do not exceed 50A to prevent unstable power supply.

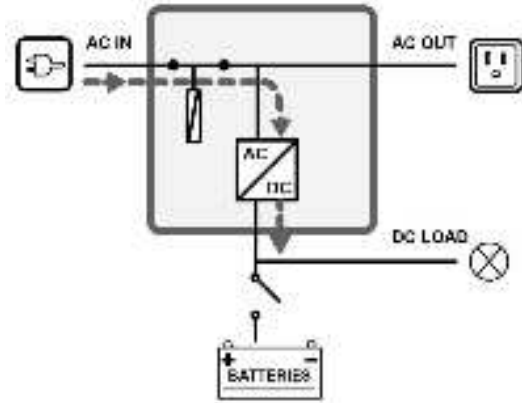

- **Power sharing mode:** The CombiMaster Inverter/Charger automatically reduces its battery charger output when the load connected to AC OUT increases while the available power at AC IN is limited. This avoids the external AC circuit breaker from tripping. The power sharing level, i.e. AC IN Limit setting (adjustable from an optional display), should match the value of the external circuit breaker.

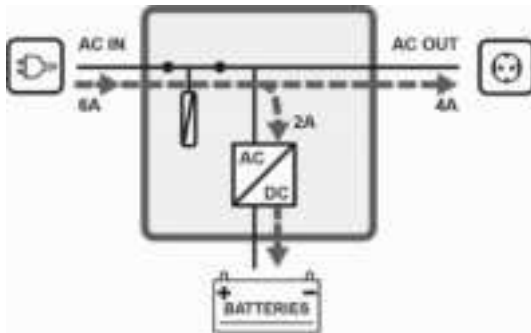

Load on AC OUT < AC IN Limit

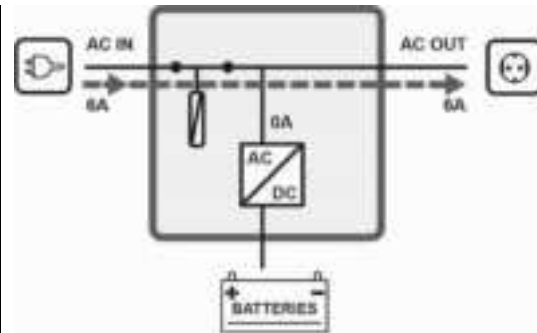
Load on AC OUT \geq AC IN Limit

- **AC input support mode:** If the demand for AC power still increases, the AC input circuit breaker may still trip if nothing is done. This problem can be solved by the AC IN Support mode. If the total demand for power exceeds the max external power supply, power can be added to AC OUT by means of the inverter. This means that the inverter adds power from the batteries, in parallel with the external power source.

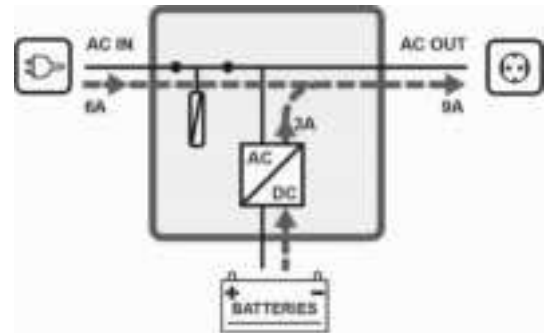
**CAUTION!**

The continuous load connected to AC OUT should never exceed

- **40A** for models 1500W, 2000W, 3000W,
- **85A** models 3500W, 4500W, 5000W.

Exceeding the max allowable output current may damage the product.

Note: Depending on national or local regulations regarding AC sources operating in parallel with the AC grid, AC IN support mode may not be allowed! Familiarize yourself with local regulations on this issue. AC power from the inverter will never be fed back into the AC grid.

See chapter 5 on page 25 for the required settings for all modes.

3.3 Protection

- **Overload or short circuit:** while in the inverter mode, the CombiMaster Inverter/Charger will shut down within 5 seconds of 200% overload or after 10 seconds 150%.
- **Transfer switch overload:** the transfer switch of the CombiMaster Inverter/Charger is protected against overload. When the current through the transfer switch of the CombiMaster Inverter/Charger is exceeding what it is rated for,
 - **30A** for models 1500W, 2000W, 3000W, or
 - **50A** for models 3500W, 4500W, 5000W, then the thermal breaker (item 8 on page 7) will disconnect the AC input.
- **High temperature:** if the temperature of the CombiMaster Inverter/Charger is too high, the inverter shuts down or the charger will reduce power. This will trigger the status LEDs and optionally a remote alarm. High temperature is most likely caused by heavy loads operating for a longer period, high ambient temperature or disrupted air flow (dust or too little space). When the temperature returns to normal operating range, the inverter powers up automatically or the charger resumes. See section 9.6 for details.
- **Battery low/high:** the CombiMaster Inverter/Charger warns for low or high battery voltages by triggering status LEDs and CZone/MasterBus alarms.



CAUTION!

The CombiMaster Inverter/Charger is not protected against:

- over voltage on the AC input;
- continuous overload on the AC output.

Make sure AC input is within the range of 90-140V_{AC} and the continuous load connected to AC OUT never exceeds

- **40A** for models 1500W, 2000W, 3000W,
- **85A** for models 3500W, 4500W, 5000W.

4 INSTALLATION

4.1 Unpacking

The delivery includes:

- CombiMaster Inverter/Charger
- 1× Temperature sensor with cable and plug
- 1× MasterBus terminator
- 1× RJ45-M12 Drop cable CZone (1m)
- Mounting bracket
- User and installation manual

After unpacking, check the contents for possible damage. Do not use the product if it is damaged. If in doubt, contact your Mastervolt dealer. Check from the identification label (see section 2.3) whether the battery voltage is the same as the nominal output voltage of the CombiMaster Inverter/Charger (e.g. 24V battery set for a 24V inverter/charger). Also check that the AC output voltage and output power of the CombiMaster Inverter/Charger complies with your system and loads.

4.2 Location

- The CombiMaster Inverter/Charger is designed for indoor use only.
- Ambient temperature
 - models 1500W, 2000W, 3000W, 3500W:
14°F to 140°F [-10°C to 60°C], power derating above 104°F [40°C].
 - models 4500W, 5000W:
14°F to 176°F [-10°C to 80°C], power derating above 104°F [40°C].
- Humidity: 5-95% non-condensing
- This device requires a minimum of 4" [100mm] of clearance on every side to ensure safety and proper ventilation
- If the CombiMaster Inverter/Charger is installed in the immediate vicinity of living areas, take into account that the fan(s) of the CombiMaster Inverter/Charger can produce noise when operating.
- The CombiMaster Inverter/Charger can be tabletop mounted (IP 21) as well as wall mounted (IP 23).
- The CombiMaster Inverter/Charger complies with FCC Class B notification: This equipment has been tested and found to comply with the limits for a Class B digital device, pursuant to part 15 of the FCC Rules. These limits are designed to provide reasonable protection against harmful interference in a residential installation. This equipment generates, uses and can radiate radio frequency energy and, if not installed and used in accordance with the instructions, may cause harmful interference to radio communications. However, there is no guarantee that interference will not occur in a particular installation. If this equipment does cause harmful interference to radio or television reception, which can be determined by turning the equipment off and on, the user is encouraged to try to correct the interference by one or more of the following measures:
 - Reorient or relocate the receiving antenna.
 - Increase the separation between the equipment and receiver.
 - Connect the equipment into an outlet on a circuit different from that to which the receiver is connected.
 - Consult the dealer or an experienced radio/TV technician for help.

Note: The changes or modifications not expressly approved by the party responsible for compliance could void the user's authority to operate the equivalent.

4.3 Batteries

Model	Recommended battery capacity
12V/1500W-60A	120–600 Ah
12V/2000W-100A	200–1000 Ah
12V/3000W-160A	320–1600 Ah
12V/3500W-200A	400–2000 Ah
24V/2000W-60A	120–600 Ah
24V/3000W-70A	140–700 Ah
24V/3500W-100A	200–1000 Ah
24V/4500W-120A-HT	240–1200 Ah
48V/5000W-70A-HT	140–700 Ah

Minimum, based on Mastervolt Gel batteries. If connecting batteries of a different manufacturer, make sure the manufacturer's recommendations are met.

4.4 Connection examples

These schematics illustrate the general placement of a standalone CombiMaster Inverter/Charger in a circuit. It is not meant to provide detailed wiring instructions for any particular electrical installation. For information on multi-unit configurations, see chapter 7.

4.4.1 Models 1500W, 2000W, 3000W

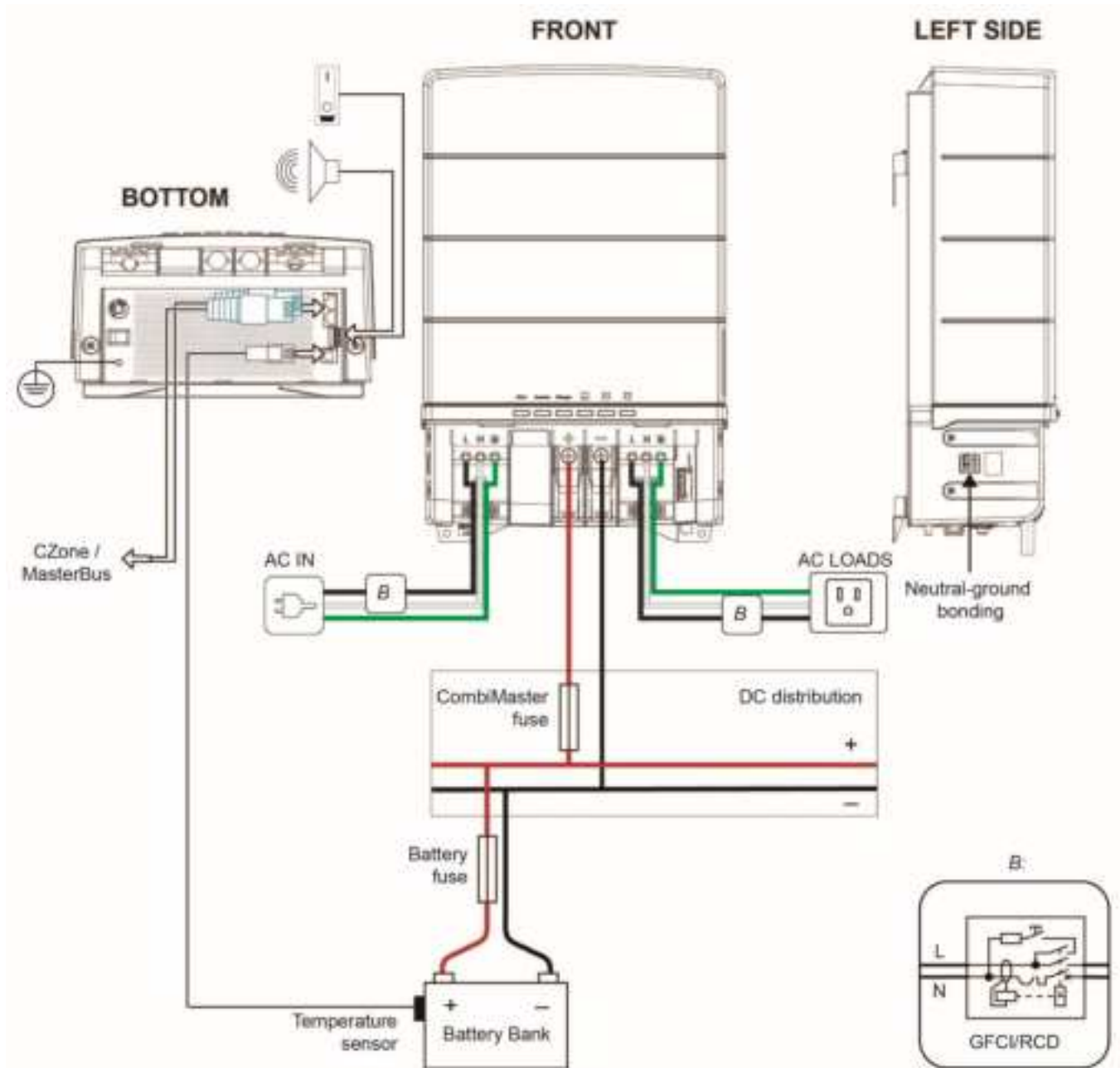

Figure 4: Installation drawing for models with product code: 35511500, 35512000, 35513000, 35522000, 35523000

4.4.2 Models 3500W, 4500W, 5000W

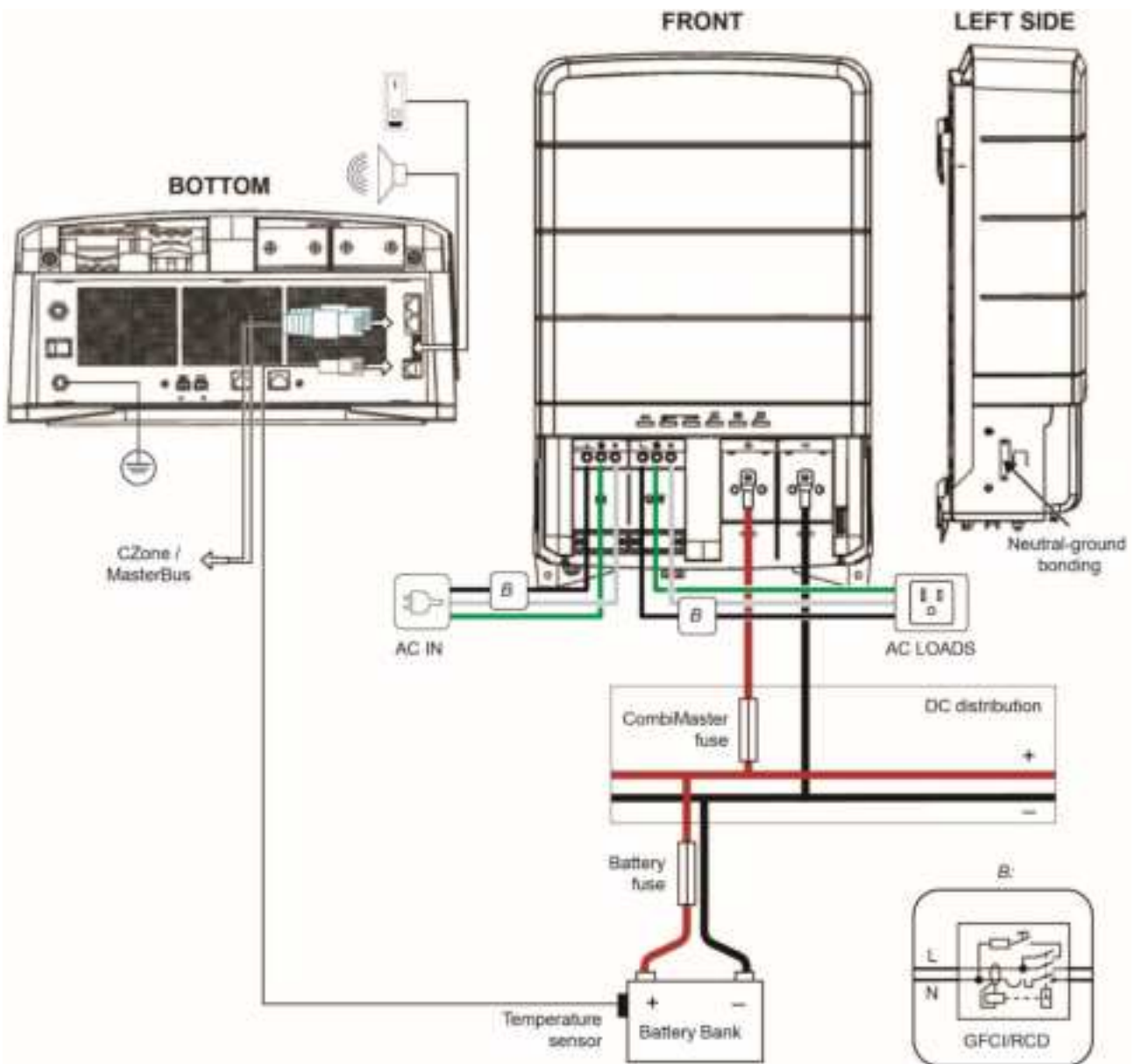

Figure 5: Installation drawing for models with product code: 35513500, 35523500, 35524500, 35545000

4.5 Wiring



WARNING!

The wire sizes stated in this manual are only guidelines. Fusing is based on the gauge and length of the cable, which in turn depend on the load connected to the CombiMaster Inverter/Charger. Always comply with all local rules and regulations.



WARNING!

Turn off the DC and AC power source during installation. Powered wires can spark when touching the CombiMaster Inverter/Charger DC or AC terminals.

4.5.1 DC wiring

Always keep your wire runs as short as practical to prevent low voltage shutdowns and to keep the DC breaker from nuisance tripping (or open fuses) because of increased current draw.

Model	DC cable cross section		Inline fuse
	<10ft [3m]	10-16ft [3-5m]	
12V/1500W-60A	AWG 1/0 [50 mm ²]	AWG 2/0 [70 mm ²]	200A
12V/2000W-100A	AWG 2/0 [70 mm ²]	AWG 3/0 [95 mm ²]	250A
12V/3000W-160A	AWG 3/0 [95 mm ²]	AWG 4/0 [120mm ²]	350A
12V/3500W-200A	AWG 4/0 [120 mm ²]	2 x AWG 2/0 [2 x 70 mm ²]	1x 400 or 2x 200A
24V/2000W-60A	AWG 2 [35 mm ²]	AWG 1/0 [50 mm ²]	130A
24V/3000W-70A	AWG 1/0 [50 mm ²]	AWG 2/0 [70 mm ²]	200A
24V/3500W-100A	AWG 2/0 [70 mm ²]	AWG 3/0 [95 mm ²]	250A
24V/4500W-120A-HT	AWG 3/0 [95 mm ²]	AWG 4/0 [120 mm ²]	300A
48V/5000W-70A-HT	AWG 1/0 [50mm ²]	AWG 2/0 [70 mm ²]	175A

Note: make sure that the fuse's voltage rating meets the battery voltage. Especially for a 48V system because most fuses do not exceed 32V.

Use cable lugs on the ends of the wires. These lugs should be crimped with a proper crimping tool. Recommended wire colors (refer to local rules):

Wire color	Meaning	Connect to:
Red	Positive	+ (POS)
Black or yellow	Negative	- (NEG)

Do not put anything between the battery cable ring lug and the battery post or the inverter's DC terminal. When connecting the battery cable to the battery post or inverter DC terminal, the cable should be placed directly against the inverter terminal or battery post. Incorrectly installed hardware causes a high resistance connection which could lead to poor inverter/charger performance and may affect the cable and terminal connections.

Run the cables next to each other to limit the electromagnetic field around the cables. The negative cable should be connected directly to the negative post of the battery bank or the ground side of a current shunt. Do not use the chassis frame as the negative conductor. Tighten securely. The positive cable must be fused and connected to the positive post of the battery bank. Use a fuse that matches the applied wire gauge and is rated at 125 to 150% of the full load current. The fuse with fuse-holder is available from your local Mastervolt distributor.

For more information on fuses, consult Blue Sea's *Wire, Fuse and Fuse Holder Selection Chart*.

[<http://assets.blueseas.com/files/resources/reference/20010.pdf>]

4.5.2 AC wiring



WARNING!

The ground wire offers protection only if the case of the CombiMaster Inverter/Charger is connected to the safety ground. Connect the ground terminal (PE / GND) to the hull or the chassis of the boat or vehicle that this CombiMaster Inverter/Charger is equipped on.



WARNING!

For safety reasons Ground Fault Circuit Interrupters (GFCIs), also known as Residual Current Devices (RCDs), must be integrated in the AC input *and* AC output of the CombiMaster Inverter/Charger. Always comply with all local rules and regulations.



CAUTION!

For the isolation transformer that is used at the AC input, choose a transformer with at least 2x the total inverter power of the units. Too small a transformer causes unstable behavior!

For a safe installation the correct wire cross section must be applied. Don't use a cross section that is smaller than indicated. When cables are longer than 10 feet [3m], the size should be increased (one size over) to compensate for cable losses. Maximum AC breaker size:

	Model 12/1500-60, 12/2000-100, 12/3000-160, 24/2000-60, 24/3000-70	12/3500-200, 24/3500-100, 24/4500-120, 48/5000-70
AC input circuit breaker	30A* (12 AWG [4mm ²] wire)	50A* (8 AWG [10 mm ²] wire)
AC output circuit breaker	40A (10 AWG [6 mm ²] wire)	85A (6 AWG [16 mm ²] wire)

* or less when the AC supply is rated for lower value

Recommended wire colors 120VAC single-phase (refer to local rules):

Color	Meaning	Must be connected to
Black	Hot or Line	L
White	Neutral	N
Green	Ground	

4.5.3 AC safety grounding



WARNING!

If installed in a head, galley, machinery space, or on a weather deck, Ground Fault Circuit Interrupters (GFCIs) of 30mA must be integrated in the AC input and AC output of the CombiMaster Inverter/Charger.

An Equipment Leakage Circuit Interrupter (ELCI) shall be installed within 10" of the shore power inlet.

Refer to locally applicable regulations regarding grounding of autonomous power systems.

Neutral to Ground Bonding

To ensure a correct operation of Ground Fault Circuit Interrupters (GFCIs), the AC output Neutral (N) connects to the Safety Ground (PE) –the so called neutral to ground bonding– when the AC input of the CombiMaster Inverter/Charger is disconnected from an external AC source. This default setting of the grounding system works well in most situations. However, depending on national or local regulations, neutral to ground bonding may not be allowed. In that case, this automatic switching feature must be disabled.

- **Models 1500W, 2000W, 3000W**

The selection of enabling/disabling automatic neutral to ground bonding in inverter mode, is done by positioning the grounding system jumper (located on the left side of the CombiMaster Inverter/Charger).

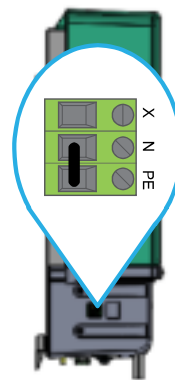

Default setting

To disable this automatic bonding, move the jumper to position X-N.

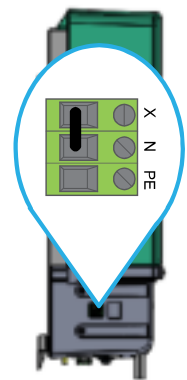

Bonding disabled

- **Models 3500W, 4500W, 5000W**

The selection of enabling/disabling automatic neutral to ground bonding in inverter mode is done by positioning the two M3x8 screws (located on the left side of the CombiMaster Inverter/Charger, behind a removable plate).

For a multi-unit configuration with single point neutral to ground bonding, please refer to the related Technical Bulletin. Technical Bulletins are published on the portal on the Mastervolt website.

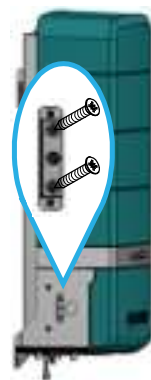

Default setting

To disable this automatic bonding, move the upper screw to the middle.

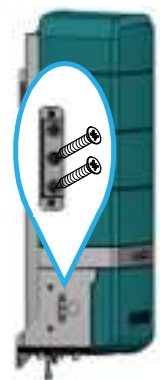

Bonding disabled

4.5.4 Network wiring (CZone/MasterBus)

The CombiMaster Inverter/Charger can be connected to a CZone or MasterBus network. For CZone, use an RJ45 CZone drop cable to connect to the CZone backbone. For MasterBus, use a MasterBus cable and daisy chain the CombiMaster Inverter/Charger to the other devices. Both networks need a terminating device on both ends of the network. Do not make ring networks. For more details on networks, please contact your Mastervolt dealer.

- **CZone network**

Points to consider:

- Up to 40 devices can be connected together on a single backbone.
- Make sure the CZone network has two terminating resistors, one at each open end of the backbone.
- The electric power for the network comes from a battery or power supply. Make sure that it delivers enough power and is positioned as close to the middle of the backbone run as possible to reduce voltage drop.
- Each device on the CZone network has a unique CZone address; the Dipswitch. This number is usually assigned automatically during configuration and must match the DIP switch settings on the CombiMaster Inverter/Charger.

- **MasterBus network**

Use an RJ45 MasterBus cable (not included) and daisy chain the CombiMaster Inverter/Charger to the other MasterBus devices, forming a local data network.

Points to consider:

- Connections between the devices are made by standard MasterBus cables. Mastervolt can supply these cables.
- Up to 63 MasterBus devices can be connected together.
- MasterBus needs a terminating device on both ends of the network.
- The electric power for the network comes from the connected devices according to the rule: 1powering / 3 non-powering. Spread the powering devices over the network
- Do not make ring networks.
- Do not make T-connections in the network.



CAUTION!

Never connect a non-MasterBus device to the MasterBus network directly! This will void warranty of all MasterBus devices connected.

For more details on networks, please contact your Mastervolt dealer.

4.6 Tools and materials needed

Make sure you have all the materials you need to install a CombiMaster Inverter/Charger:

- For CZone setup, a tee connector.
- For MasterBus setup, an RJ45 MasterBus cable.
- DC cables to connect the CombiMaster Inverter/Charger to the batteries and common negative. See section 4.5.1 for specifications.
- DC fuse holder with a DC fuse, to be integrated in the positive DC cable (as per ABYC recommendations).
- Screws/bolts (\varnothing 1/4" / 6mm) with plugs to mount the CombiMaster Inverter/Charger to a surface. Use mounting materials which are suited to carry the weight of the CombiMaster Inverter/Charger.
- AC cable to connect the AC input to an AC power source. See section 4.5.2 for specifications.
- Batteries. See section 4.3 for specifications.
- Appropriate and reliable cable terminals, cable lugs, battery terminals and cord end terminals.

We recommend as a minimum tool kit:

- Socket wrench to fix the main DC cables (M8 / $5/16$ ")
- Socket wrench to fix the Safety ground connection ($5/16$ ").
- Flat blade screwdriver to fix the screw terminals of the AC wiring.
- Tools to fix the screws / bolts (\varnothing 1/4" / 6mm) with plugs to mount the CombiMaster Inverter/Charger to a surface.
- Philips screwdriver to open the connection compartment.

4.7 Installation step-by-step

The drawings used in this section are based on the 3000W model. Where necessary, the difference is indicated.

Step 1. Turn off the electrical power.

Step 2. On a solid surface, mark the holes for the mounting bracket and secure the mounting bracket to the surface.

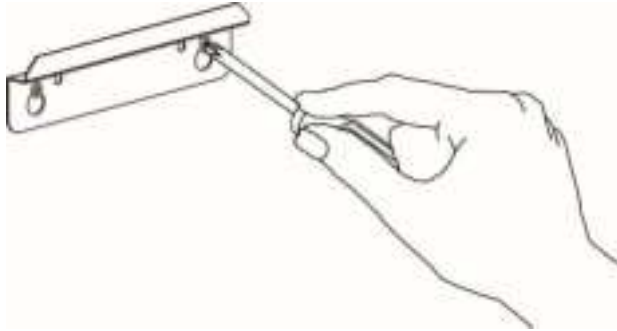

Wall
mounted



Tabletop
mounted

Note: Make sure that the mounting surface and material can support the weight of the CombiMaster Inverter/Charger.

Step 3. Place the CombiMaster Inverter/Charger over the mounting bracket and then downwards until it snaps into place.



Step 4. Secure the CombiMaster Inverter/Charger to the surface by tightening two screws at the lower side of the case as well.



Step 5. Connect the 5/16" grounding lug to the central grounding point.

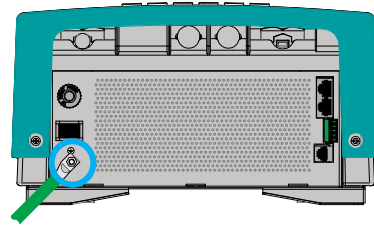

Step 6. Open the connection compartment by loosening the two screws at the bottom and then lifting the front cover plate.

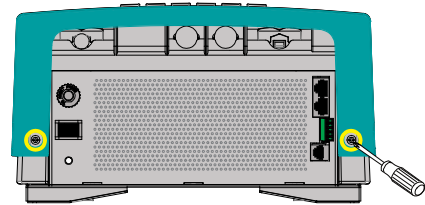

Step 7. Connect the AC wiring to the screw terminals. Tighten the cables with a strain relief. For larger cables, rotate the strain relief*:

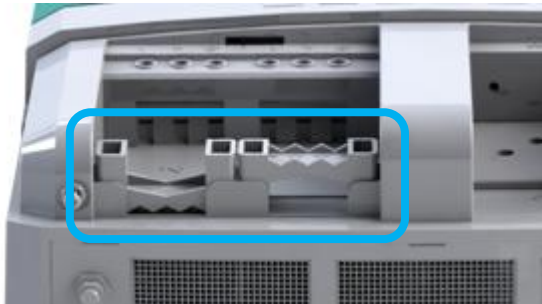

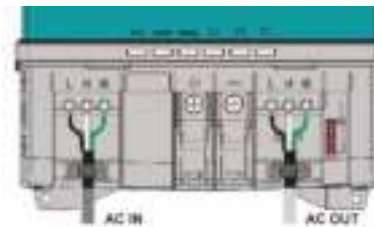

* Available on models 3500W, 4500W, 5000W.

Models 1500W, 2000W, 3000W:

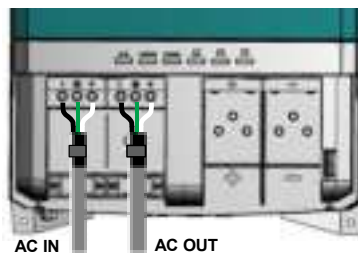

Models 3500W, 4500W, 5000W:



Pay attention to the positions of the N and  terminals, to avoid wrong connections.

- Step 8.** Integrate a fuse holder in the positive battery wire but do not place the fuse yet!
Fit crimp-on ring terminals to the DC cables.
Connect the DC cabling of the battery bank; positive to +, negative to – .

Models **3500W, 4500W, 5000W** offer two ways to connect DC cabling: one thick cable or two smaller diameter cables.

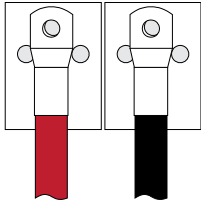

Use the center bolts to connect single DC cables.

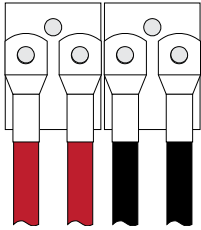

Use the outer bolts to connect double, side by side, DC cables.

Models 1500W, 2000W, 3000W:

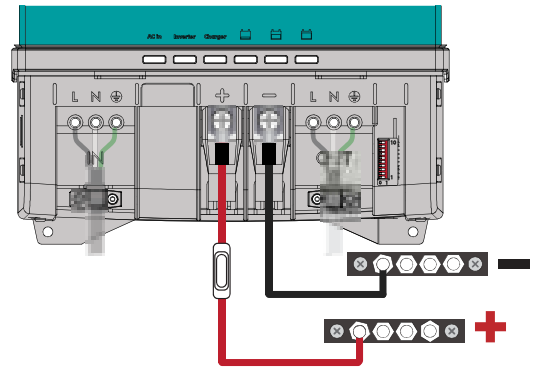

Models 3500W, 4500W, 5000W:

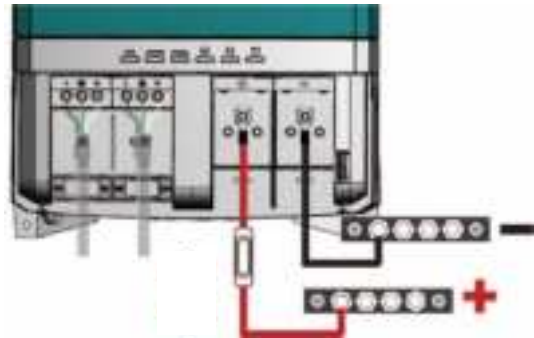

- Step 9.** Attach the battery temperature sensor to the casing of the battery bank. Then plug the temperature sensor cable into the “temp.sensor” jack.

Note: Lithium-ion batteries require no temperature sensor.

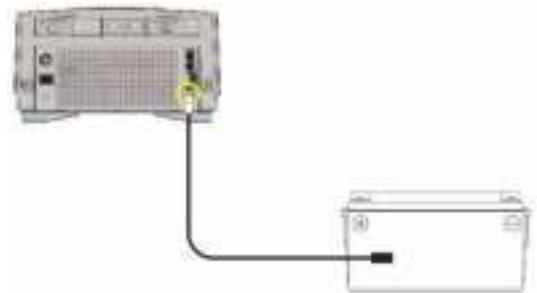

- Step 10.** On the left side of the CombiMaster Inverter/Charger check the grounding system jumper or busbar. Out of the box the setting meets US requirements for a standalone unit. See section 4.5.3 on page 17 for details.
- Step 11.** Option: Connect the CombiMaster Inverter/Charger to the CZone or MasterBus network. See section 4.5.4 for more information on network wiring.

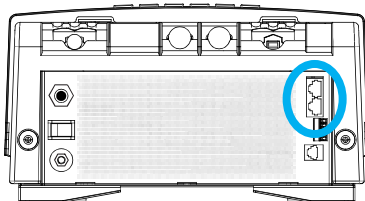

Adding the CombiMaster Inverter/Charger to a CZone network

- 1 Disconnect the backbone at the closest backbone connection and add in a tee connector.
- 2 Reconnect the backbone connection with the new tee connector in place.
- 3 Connect the RJ45 CZone drop cable to the black coupler on the tee and then plug the connectors into either of the communication ports of the CombiMaster Inverter/Charger.



Adding the CombiMaster Inverter/Charger to a MasterBus network

- 1 Disconnect a MasterBus cable or Terminator from the closest MasterBus device and connect it to the CombiMaster Inverter/Charger.
- 2 Connect the new MasterBus cable to the other MasterBus device and then connect to the CombiMaster Inverter/Charger.
- 3 Ensure that the network is properly terminated.



Step 12. Option: use a small screwdriver to change DIP switch settings. See section 5.1 on page 25.

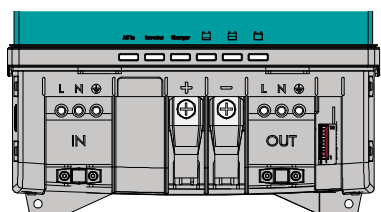

Note: if added to a CZone network, the DIP switches are used to set the CZone address.

Step 13. Option: connect external alarm or remote switch input. See section 4.8.

Step 14. Set the desired output voltage and other configuration settings using a remote control panel or the DIP switches, see chapter 5 on page 25.

Step 15. Check all wiring. If all wiring is OK: open the safety switch (if available) and place the inverter fuse.



WARNING!

When the fuse is placed, internal capacitors may cause a spark. This is normal.

Step 16. Close the connection compartment and fix the screws at the bottom.

Step 17. Close the safety switch (if available) and switch on the CombiMaster Inverter/Charger.

4.8 Accessories connector (dry contacts)

The screw terminal at the bottom side of the CombiMaster Inverter/Charger, offers the following contacts:

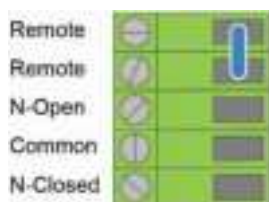

Remote	Minimum voltage 12V models: 10V
Remote	Remote switch input
N-Open	Minimum voltage 24V models: 16V
Common	Minimum voltage 48V models: 18V
N-Closed	Alarm output

4.8.1 Remote switch

By default, the upper two contacts (Remote) of the accessories connector are connected by a jumper to close the circuit. If desired, for example to switch off the CombiMaster Inverter/Charger to save on no load, remove the jumper and use these contacts to connect a remote switch that mimics the main On/Charge only switch.

- Either use the Remote contact to use the ignition lock (+Bat).

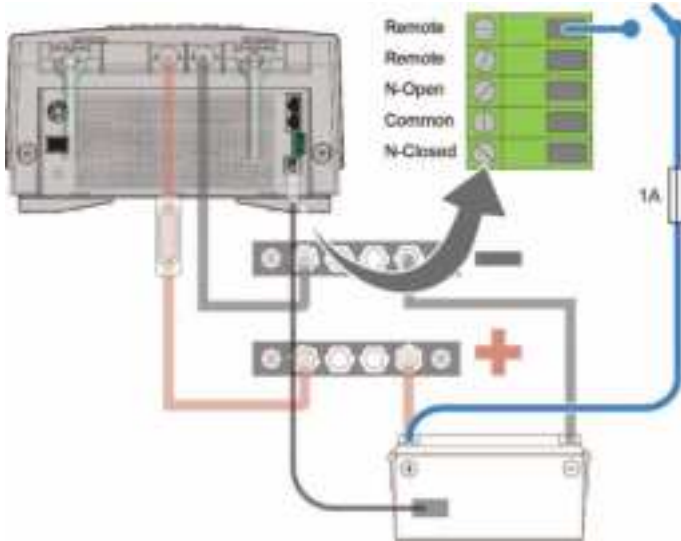

Connect the upper contact to the ignition lock (+Bat).



CAUTION!

To avoid short circuiting and damage to the CombiMaster Inverter/Charger, connect the remote input to +Bat only.

Connect a 1A fuse on the remote input.

Note: this way, the inverter can no longer be switched on or off by the "On/Charge only"-switch that is located on the bottom of the CombiMaster Inverter/Charger!

- Or use both contacts to connect an external switch.

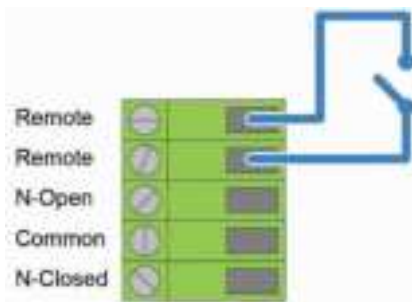

In this case, the CombiMaster Inverter/Charger's "On/Charge only"-switch must be in the on position (I). External switch closed = On, external switch open = Charge only.

4.8.2 Output

The lower three contacts of the accessories connector can be used to control external equipment, like an alarm or light, to indicate the occurrence of a CombiMaster Inverter/Charger alarm. The alarm outputs support *Normally Closed* and *Normally Open* systems and is either alarm triggered, or power level triggered.

Trigger	Condition	Contact state
Alarm	A fault is detected	N-Open and Common connected (CombiMaster Inverter/Charger off)
	No fault is detected	N-Closed and Common connected
Power level	Inverter power < power level setting	N-Open and Common connected (CombiMaster Inverter/Charger off)
	Inverter power > power level setting	N-Closed and Common connected

See also section 5.2.4 for the dry contact alarm function in the configuration settings.

Max load: 250VAC, 30VDC, 3A.

5 SETTINGS

Adjustment of the settings of the CombiMaster Inverter/Charger can be made in two different ways:

- By means of DIP switches.
- From a laptop connected to the CombiMaster Inverter/Charger via a Mastervolt USB Interface. Some settings, like the AC IN Limit setting for example, can only be changed in this way.



CAUTION!

Invalid settings of the CombiMaster Inverter/Charger can cause serious damage to your batteries and/or the connected load! Adjustment of settings must be carried out by authorized personnel only.

5.1 DIP switch settings

Use a small screwdriver to carefully set the required settings.

In a CZone network:

DIP switches 1 and 2 OFF.

DIP switches 3 to 10 must match the unique address used in the CZone network; the dipswitch (see the CZone Configuration Tool Instructions manual). At least one of DIP switches from 3 to 10 must be ON.

In a MasterBus network (or standalone):

DIP switch 1 ON.

DIP switch 2: ON = MasterBus Powering on
OFF = MasterBus Powering off.

DIP switches 3 to 5 are used for battery type selection:

DIP switch	3	4	5
Configurable via MasterAdjust (Flooded) ¹	0	0	0
Flooded (fixed)	0	0	1
AGM (fixed)	0	1	0
Gel (fixed)	0	1	1
MLI (fixed)	1	0	0
Constant voltage (13.25V) ²	1	1	1

The following table lists the settings for DIP switches 6 to 10.

DIP switch	6	7	8	9	10
Inverter frequency 60Hz	0				
Inverter frequency 50Hz	1				
AC input support mode off		0			
AC input support mode on		1			
AC voltage input window wide			0		
AC voltage input window narrow			1		
Energy saving mode off				0	
Energy saving mode on				1	
Parallel operation off					0
Parallel operation on*					1

* Parallel configuration applicable to models 3500W, 4500W, 5000W only.

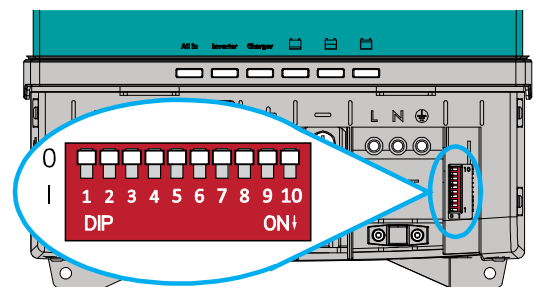

Figure 6. DIP switches (factory settings)

¹ If DIP switches 3, 4 and 5 are OFF, the settings suit a Flooded battery but can be changed in MasterAdjust.

² Constant voltage has no temperature compensation.

5.2 MasterBus configuration

MasterBus is a CAN based data network for communication between Mastervolt devices. When the CombiMaster Inverter/Charger is connected, open MasterAdjust on a Windows laptop or notebook connected to the MasterBus network via a Mastervolt USB interface. MasterAdjust software is available as free to download software on the Mastervolt website: www.mastervolt.com. The CombiMaster Inverter/Charger will be recognized by the MasterBus network automatically.

5.2.1 Monitoring tab

A remote panel (display) can be used to monitor the CombiMaster Inverter/Charger. The following table lists the parameters as shown in MasterAdjust.

Menu	Description	Default	Adjustable range
General			
Device state	The operation mode: Standby; Charging; Inverting; Supporting; Alarm		(read only)
AC IN Limit	Fuse setting of the AC input	30A/50A	5-30A/5-50A
Inverter button	Button to switch off/on the inverter	On	On, Off
Charger button	Button to switch off/on the charger	On	On, Off
DC IN/OUT			
Charger state	Charger state: Off, Bulk, Absorption, Float		(read only)
Battery voltage	Battery voltage		(read only)
Battery current	Battery current (minus is discharging)		(read only)
Battery temperature	Battery temperature (if not connected: ---)		(read only)
AC IN			
Input Voltage	AC input voltage		(read only)
Input Current	AC input current		(read only)
Input Frequency	AC input frequency		(read only)
Input Power	AC input power		(read only)
AC OUT			
Output Voltage	AC output voltage		(read only)
Output Current	AC output current		(read only)
Output Power	AC output power		(read only)
Output Frequency	AC output frequency		(read only)
Installer			
Dry contact*	Status alarm contact		(read only)
DC current	Battery current of this unit. In a multi-unit configuration the cluster current (total of all units) is shown by <i>Battery current</i> .		(read only)
Device error	Error code for support purposes		(read only)

* Parameters marked with a * are not available in CZone.

In addition to standalone unit monitoring information, the primary unit of a multi-unit configuration displays the cluster information.

Note: for a cluster, the *AC IN Limit* value is the total for all units in the cluster.

- **Cluster information for a parallel unit in single-phase**

Menu	Description
Cluster	
Cluster state	the configuration state of the cluster (should be <i>Activated</i>)
Cluster size	the number of CombiMaster Inverter/Charger units in parallel
Cluster L1 IN	
Input voltage	Mains input voltage of the cluster
Input current	Mains input current of the cluster
Input frequency	Mains input frequency of the cluster
Cluster L1 OUT	
Output voltage	Total AC output voltage of the cluster
Output current	Total AC output current of the cluster
Output frequency	Total AC output frequency of the cluster
Output power	Total AC output power of the cluster

- **Cluster information for a unit in split-phase**

Menu	Description
Cluster	
Cluster state	monitors the configuration state of the cluster
Cluster size	number of CombiMaster Inverter/Charger units in the cluster
Cluster L1/L2 IN	
Input voltage	Mains input voltage of the cluster on L1/L2
Input current	Mains input current of the cluster on L1/L2
Input frequency	Mains input frequency of the cluster on L1/L2
Cluster L1/L2 OUT	
Output voltage	Total AC output voltage of the cluster on L1/L2
Output current	Total AC output current of the cluster on L1/L2
Output frequency	Total AC output frequency of the cluster on L1/L2
Output power	Total AC output power of the cluster on L1/L2

- **Cluster information for a parallel unit in split-phase**

Menu	Description
Cluster	
Cluster state	monitors the configuration state of the cluster
Cluster size	number of CombiMaster Inverter/Charger units in the cluster
Cluster L1/L2 IN	
Input voltage	Mains input voltage on L1/L2
Input current	Mains input current on L1/L2
Input frequency	Mains input frequency on L1/L2
Cluster L1/L2 OUT	
Output voltage	Total AC output voltage of the cluster on L1/L2
Output current	Total AC output current of the cluster on L1/L2
Output frequency	Total AC output frequency of the cluster on L1/L2
Output power	Total AC output power of the cluster on L1/L2

5.2.2 Alarms tab

The following table lists the parameters as shown in MasterAdjust.

Menu	Description
Temperature high	The internal temperature of the CombiMaster Inverter/Charger is too high.
Fan error	An error has been detected in (one of) the fan(s).
Battery Temp.	Battery temperature too high / too low
DC high voltage	Battery voltage is too high.
DC low voltage	Battery voltage is too low.
Overload	The loads exceed the nominal inverter power
Device error	Internal CombiMaster Inverter/Charger error.
AC IN error	AC input voltage or frequency out of range

5.2.3 History tab

The following parameters are only shown in MasterAdjust.

Menu	Description
Inverter runtime*	Inverter mode operation hours
Charger runtime*	Charger mode operation hours

* Parameters marked with a * are not available in CZone.

5.2.4 Configuration tab

The configuration can be done in MasterAdjust, from a laptop or notebook connected to the CombiMaster Inverter/Charger via a Mastervolt USB Interface. See applicable user manuals for details. The following table lists the parameters as shown in MasterAdjust.

- Notes:**
- DIP switch settings overrule MasterBus settings. If DIP switches are not in their default setting, the corresponding MasterBus setting is greyed out.
 - To be able to make changes to the configuration via MasterBus, DIP switch 1 must be in the ON position.
 - Bulk, absorption and float settings are read only, unless battery type "user defined" is selected.

Value	Meaning	Default	Adjustable Range
Device			
Language*	Menu language of this device	English	English, Nederlands, Deutsch, Français, Castellano, Italiano, Norsk, Svenska, Suomi, Dansk
Name	Name of this device. This name will be recognized by all devices connected to the MasterBus network	CombiMaster	0-12 chars
Model	The CombiMaster Inverter/Charger model		(read only)
Lock config.*	Option to lock the configuration (installer level)	Off	On, Off
Factory reset button*	Button to restore the configuration's default values	Off	On, Off
CZone enabled	This checkbox is marked when the CombiMaster Inverter/Charger is setup to work in a CZone network	Off	(read only)
DIP Switches 1234567890*	Position of the DIP switches	0	(read only)

Value	Meaning	Default	Adjustable Range
Inverter			
Energy save mode	Option to enable Energy save mode (only available for standalone unit)	Off	On, Off
Frequency	Inverter frequency	60Hz	50, 60Hz
DC Low on*	Voltage level at which the inverter switches on (DC Low off alarm)	11.5 ¹⁾	10.7-12.5 ¹⁾
DC Low off	Voltage level at which the inverter switches off	10.2 ¹⁾	10.2-12.0 ¹⁾
Charger			
Max charge cur.	Maximum charging current	Model-dependent	0 – model-dependent
Battery type	Select the battery type (Individual adjustments in charge settings are only possible if "User defined" is selected here. For an overview of charging specifications, see section 9.2 on page 57)	Flooded	User defined, AGM, Gel, Flooded, Lithium-ion, Constant voltage
Constant voltage	Select the Constant output voltage	13.25V ¹⁾	12-15 ¹⁾
Bulk			
Voltage	Maximum Bulk voltage	14.25 ¹⁾	12-15 ¹⁾
Minimum time	Minimum time that the charger stays in bulk phase	2 min	0-600 min
Maximum time	Maximum time the bulk phase lasts before the charger transitions to absorption	480 min	0-600 min
Start bulk time	Voltage level at which to start the bulk timer	13.25 ¹⁾	12-15 ¹⁾
Absorption			
Voltage	Absorption voltage	14.25 ¹⁾	12-15 ¹⁾
Minimum time	Minimum time that the charger stays in absorption phase	15 min	0-600 min
Maximum time	Maximum time that the charger stays in absorption phase	240 min	0-600 min
Return Amps	Return amps (% of maximum charge current)	6%	0-100%
Float			
Voltage	Float voltage	13.25 ¹⁾	12-15 ¹⁾
Return to Bulk s	Delay time before the charger returns to Bulk after reaching the Return to Bulk voltage	30 s	0-600sec
Return to Bulk V	Bulk return voltage. If the battery voltage has dropped below this voltage, the charger will return to bulk phase	12.80 ¹⁾	12-15 ¹⁾
AC IN			
AC IN support	Option to enable AC input support mode	Off	On, Off
Max AC IN limit	Maximum value for the "AC IN Limit" option on the monitoring tab	30A [50A] ²⁾	0-30A [0-50A] ²⁾
Input window	AC voltage input window. If the AC input is subject to voltage drops and spikes, like when the AC source is a generator, then Wide is recommended.	Wide	Wide, narrow

Value	Meaning	Default	Adjustable Range
AC IN limits*			
AC IN Limit A*	Fuse pre-setting A	6A	0-30A [0-50A] ²⁾
AC IN Limit B*	Fuse pre-setting B	10A	0-30A [0-50A] ²⁾
AC IN Limit C*	Fuse pre-setting C	16A	0-30A [0-50A] ²⁾
Dry contact (installer level)			
Function	Select dry contact alarm function	Alarm	Alarm, Power level
Power Level	Inverter output power level	60%	0-100%
Delay on	Delay on	5s	0-300 seconds
Delay off	Delay off	5s	0-300 seconds
Cluster (installer level, models 3500W, 4500W, 5000W only)			
Phase system	Multi-unit configuration type	Single phase	Single phase, Split phase
Dev. per phase	Number of devices per phase	1	1-7
Confirm topology button	Button to confirm the number of devices		
Cluster topology	Monitors whether the selected number of devices equals the available number of devices		Approved, Rejected
Activate cluster button	Button to confirm the configuration		
Cluster state	Monitors the configuration state		Activated, Cluster conflict, Double device, Incomplete, Missing devices, Not activated, Replica, Standalone.
Processor 1			
Version	Firmware DSP version		(read only)
Revision	Product version		(read only)
Bootloader ver.	Firmware bootloader version		(read only)
Processor 2			
Version	Firmware MB version		(read only)
Bootloader ver.	Firmware bootloader version		(read only)

* Parameters marked with a * are not available in CZone.

¹⁾ These values are for a 12V system. For a 24V system, multiply by 2. For a 48V system, multiply by 4.

²⁾ Models 1500W, 2000W, 3000W have a 30A fuse. Models 3500W, 4500W, 5000W have a 50A fuse.

5.2.5 Events tab – System automation

A MasterBus device can be programmed to initiate an action at another connected device. This is very helpful in automation of your system but is not required. In MasterBus this is done by means of event-based commands. In the Events tab you can program the CombiMaster Inverter/Charger to act as an event source. Events which occur during the operation of the CombiMaster Inverter/Charger will then trigger actions from other products. The following parameters are shown in MasterAdjust.

Field	Meaning	Value
Event x source	Select an event that triggers an action, e.g. Battery pre low.	See <i>Event source</i> list
Event x target	Select the device that should take action, e.g. the generator.	System dependent
Event x command	Select the parameter that must be changed on the target device, e.g. Activate.	See command list of the selected device
Event x data	Data, e.g. On, is linked to the command.	Off, On, Copy, Copy Invert, Toggle

Table 1: MasterBus event parameters

The CombiMaster Inverter/Charger can be configured as an *event source*. An event source can initiate an *event command* and an *event action* by another device that is connected to the MasterBus.

Event source	Description
Inverting	The CombiMaster Inverter/Charger is in Inverter mode
Charging	The CombiMaster Inverter/Charger is in Charger mode
Supporting	The CombiMaster Inverter/Charger is in Supporting mode
Overload	The loads exceed the nominal inverter power
DC low voltage	The main battery voltage has dropped below the Low bat value
Alarm	A CombiMaster Inverter/Charger alarm has been triggered
AC IN present	AC input is present
Bulk	Charge phase Bulk
Absorption	Charge phase Absorption
Float	Charge phase Float
AC IN Limit A	AC input is set to 6A
AC IN Limit B	AC input is set to 10A
AC IN Limit C	AC input is set to 16A

Table 2: CombiMaster 120V Series MasterBus Event sources

When the CombiMaster Inverter/Charger is configured as an *event target* by another device, this device can initiate an *event command* and an *event action* to be performed by the CombiMaster Inverter/Charger.

Event command	Description
Inverter	Change the CombiMaster Inverter/Charger inverter state
Charger	Change the CombiMaster Inverter/Charger charger state
AC limit A	Fuse setting of the AC input is set to 6A (adjustable)
AC limit B	Fuse setting of the AC input is set to 10A (adjustable)
AC limit C	Fuse setting of the AC input is set to 16A (adjustable)
Bulk	Changes to charge phase Bulk
Absorption	Changes to charge phase Absorption
Float	Changes to charge phase Float
Stop Charge	Command to stop charging the battery

Table 3: CombiMaster 120V Series MasterBus Event commands

5.3 CZone configuration

The CZone® network is an NMEA 2000-compliant CAN-based system. Open the CZone Configuration Tool on a Windows laptop or notebook connected to the CZone network. Either do the configuration while connected to the network or use a prepared configuration file (.zcf). The CZone Configuration Tool can be downloaded from the CZone Portal.

Adding the CombiMaster 120V Series to a CZone system configuration

Precondition: This section assumes that a CZone system is already configured and the CZone Configuration Tool is open.

In the CZone Configuration Tool, from the Modules tab, press the **Add** button.

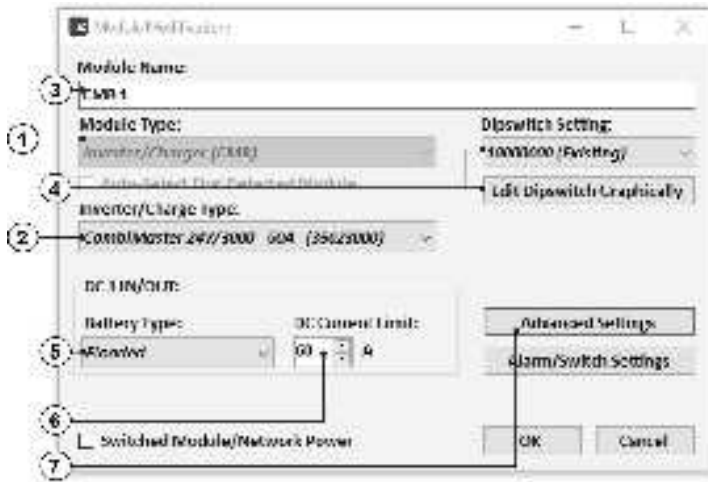

1. From the **Module Type** drop-down list select **Inverter/Charge**.
2. From the **Inverter/Charge Type** drop-down list select the required model and continue with the following steps.
3. Enter an understandable **Module Name**.
4. Each device on a CZone network has a unique CZone address; the **Dipswitch**. This number must match the physical DIP switch settings. When connected to the system: either select one from the drop-down list or edit graphically.
5. Select the **Battery Type**.

6. Enter the **DC Current Limit**.

7. Options:

- Press OK to save the settings and exit.
- Press **Alarm/Switch Settings** and continue with step 16.
- Press the **Advanced Settings** button and continue with the next step to configure advanced options.

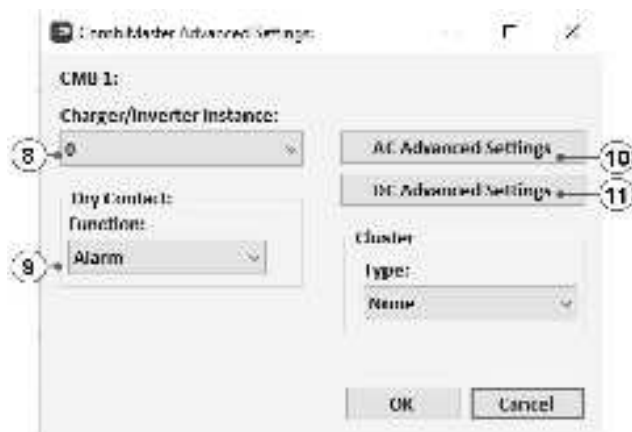

8. NMEA2000 **Instances** are used to differentiate between multiple monitoring sources.
9. From the **Function** drop-down list, select the required Dry Contact alarm function:
 - Power level (inverter output power level);
 - Alarm (has no additional settings).
10. Option: press **AC Advanced Settings** and go to step 12.
11. Option: press **DC Advanced Settings** and go to step 14.

Or press OK to save the settings and return to the Module Modification window.

Cluster settings are described in Step 11. of section 7.7.3 on page 51.

12. Check and adjust the AC settings. In Energy Save Mode the power consumption will be reduced when there is no load on AC OUT. Please note that small loads, such as the clock on a microwave oven, are most likely not to work in this mode. See section 3.2 for a description of Max AC IN Limit and AC IN Support. Supported PGNs are listed in section 9.4. For a description of instances and PGNs, please refer to the CZone Configuration Tool Instruction manual.
13. Press **OK** to return to the Advanced Settings window.
14. Check and adjust the DC settings. Note that this is only possible if in step 5 the option *User defined* is selected.
15. Press **OK** to return to the Advanced Settings window

16. Select the required Alarm Severities.
17. Press **OK**.

Optionally configure digital switching by adding Circuit Controls in the Circuits tab (e.g. a battery low switch can be used to start a generator). Write the configuration to the network to use the new configuration.



For more information, please refer to the CZone® Configuration Tool Instruction manual. Also see section 5.2 for a description of the same settings in MasterAdjust.

6 OPERATION

6.1 Switching on / charge only

The "On/Charge only"-switch on the bottom of the CombiMaster Inverter/Charger has two positions:

- On: Inverter and charger on (I)
- Charge only: Charger on, inverter off (O).

Note: When the "On/Charge only"-switch is in this position (O), it consumes 1mA DC power when not connected to AC. Switching off the inverter remotely, increases the DC power consumption. If it is necessary to put the CombiMaster Inverter/Charger out of operation, for winter storage for example, it is strongly recommended to switch the inverter off by the "On/Charge only"-switch

6.2 Status LEDs

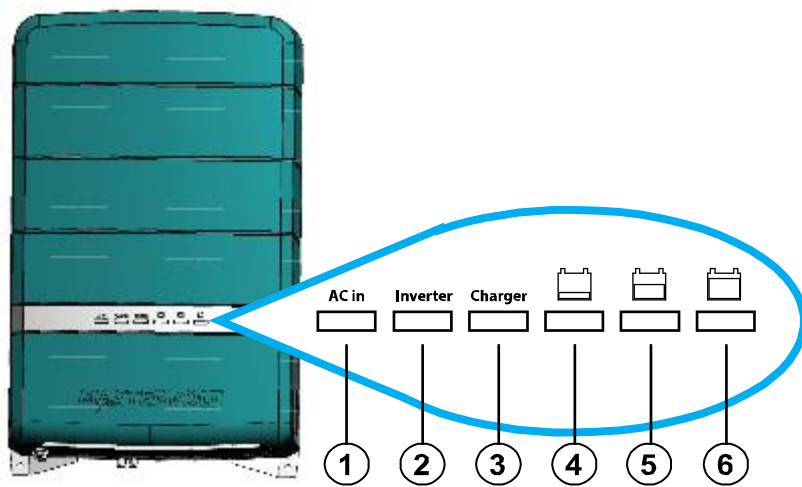

Figure 7: status LEDs

Off:

- ①: No AC input
- ②: Inverter off
- ③: Charger off

Green on:

- ①: AC input OK
- ②: Inverter on
- ③: Charger on
- ④: Charger in bulk phase
- ⑤: Charger in absorption phase
- ⑥: Charger in float phase
- ①+②: AC IN Support mode

Green blinking:

- ②: Inverter Energy save mode active

Green blinking for 5 seconds during start-up:

- ①: Single-phase standalone unit
- ②: Single-phase parallel unit
- ③: Split-phase L1 unit
- ④: Split-phase L2 unit

Red on:

- ①: AC input out of range
- ④: Battery voltage low warning/shutdown
- ⑥: Battery voltage high causing shutdown

Red blinking:

- ②: AC output overload
- ②+③: Shutdown by any other error, including overtemperature of the CombiMaster Inverter/Charger
- ⑤: Battery temperature (sensor) error

Refer to the fault-finding table on page 38 for possible causes of problems.

6.3 Remote control

The CombiMaster Inverter/Charger can also be monitored from a remote panel like the:

- SmartRemote or EasyView 5
- Touch 5, Touch 7 or Touch 10

Some advanced settings can only be adjusted from a laptop/notebook or PC connected to the CombiMaster Inverter/Charger via the Mastervolt USB Interface.

6.4 3-step+ charge process

Battery charging is accomplished in three automatic stages: BULK, ABSORPTION and FLOAT. The first step is the BULK phase, in which the output current of the charger is 100%, and the greater part of the capacity of the battery is rapidly charged. The current charges the batteries and gradually the voltage rises to the BULK voltage. The duration of this phase depends on the ratio of battery to charger capacity, and the battery state of charge.

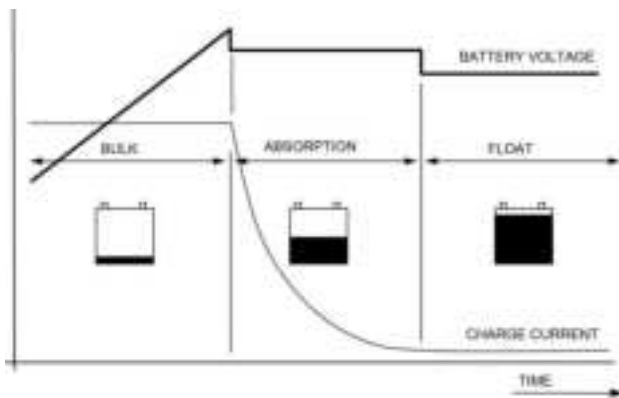

Figure 8: 3-step charge algorithm. See section 8.2 for detailed information.

The BULK phase is followed by the ABSORPTION phase. Absorption charging starts when the voltage on the batteries has reached the BULK voltage and ends when the battery is completely full. Battery voltage remains constant throughout this stage, and the charge current depends on the degree to which the battery was initially discharged, the battery type, the ambient temperature, etc. This stage lasts for 4 hours maximum. Once the battery is 100% full, the CombiMaster Inverter/Charger automatically switches over to the FLOAT phase.

Connected DC loads are powered directly by the charger. If the load exceeds the charger capacity, the required additional power comes from the battery, which will be progressively discharged until the charger automatically switches back to the bulk phase. Once consumption decreases, the charger goes back to normal operation of the 3-step+ charge system.

Connected to the CombiMaster Inverter/Charger, the batteries can be left unattended for weeks or months. One hour every 14 days the charger automatically switches to ABSORPTION to keep the battery running properly and prolong its life span. The 3-step+ charge system is also safe for all the connected equipment.



WARNING!

The Lithium-ion charging voltages on this charger fit the Mastervolt MLI batteries but do not necessarily fit other Li-ion batteries! Always follow the instructions provided by the battery manufacturer!

6.5 Temperature compensated charging

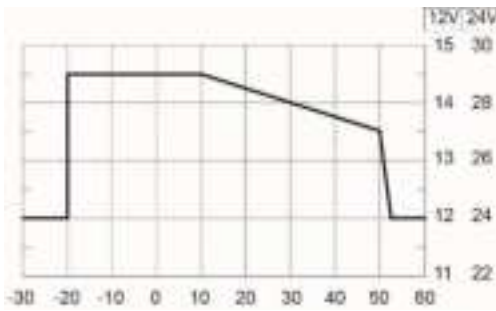

By installing the battery temperature sensor (for Lead Acid batteries only), the charge voltages are automatically adapted for deviating temperatures.

When the battery temperature is low, the charge voltage increases. On the other hand, when the battery temperature is high, the charge voltage is decreased. Overcharge and gassing are prevented this way. This will extend the life of your batteries.

Figure 9: Temperature compensated charging

6.6 Reset the thermal breaker after an overload

A thermal breaker protects the transfer switch of the CombiMaster Inverter/Charger against overload. Models 1500W, 2000W, 3000W have a 30A fuse. Models 3500W, 4500W, 5000W have a 50A fuse.

If the status LEDs indicate an overload, proceed as follows:

- Step 1. Turn off AC power.
- Step 2. Move the "On/Charge only"-switch of the CombiMaster Inverter/Charger to the "Charge only" position (○).
- Step 3. Disconnect the CombiMaster Inverter/Charger from any power source.
- Step 4. Disconnect all loads from the CombiMaster Inverter/Charger.
- Step 5. Investigate the cause of failure of the thermal breaker like overload or short-circuits.
- Step 6. Wait for at least two minutes and then reset the fuse by pushing the button at the bottom side of the CombiMaster Inverter/Charger.

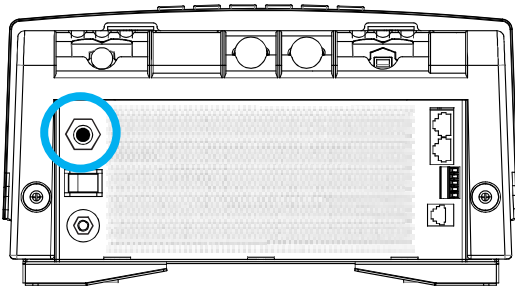

Step 7. Connect the CombiMaster Inverter/Charger to the power sources again.

Step 8. Move the "On/Charge only"-switch of the CombiMaster Inverter/Charger to the On position (|).

6.7 Maintenance

No specific maintenance to the CombiMaster Inverter/Charger is required. Examine your electrical installation on a regular basis, at least once a year. Defects such as loose connections, damaged wiring etc. must be corrected immediately.

If necessary, use a soft, clean cloth to clean the CombiMaster Inverter/Charger. Do not use any liquids or corrosive substances, such as solvents, alcohol, gasoline or abrasive components.

6.7.1 Decommissioning

If it is necessary to put the CombiMaster Inverter/Charger out of operation, follow the instructions in order of succession as described below:

- Step 1. Turn AC power off.
- Step 2. Remove the DC fuse(s) and disconnect the batteries.
- Step 3. Remove the AC fuse(s) of the AC input and/or disconnect the AC IN.
- Step 4. Open the connection compartment of the CombiMaster Inverter/Charger by loosening the two screws at the bottom and then lifting the front cover plate. The connectors for the battery, the AC and the remote panel are now visible.



WARNING!

Never remove the front panel while the CombiMaster Inverter/Charger is still connected to a power source!

- Step 5. Check with a suitable voltage meter whether the inputs and the outputs of the CombiMaster Inverter/Charger are voltage free.
- Step 6. Disconnect all the wiring.

Now the CombiMaster Inverter/Charger can be demounted in a safe way.

6.7.2 Storage and transportation

When not installed, store the CombiMaster Inverter/Charger in the original packing, in a dry and dust free environment.

7 PARALLEL AND SPLIT-PHASE SYSTEMS

7.1 General information



WARNING!

The information in this chapter is intended for qualified personnel. The installation should be performed by a Certified Electrical Technician to ensure a safe and trouble-free installation.

Note: To keep the drawings in this chapter clear and easy to read, the cable lengths have not been drawn in proportion to each other. Use AC cables of equal gauge and length and use DC cables of equal gauge and length, to every unit in the multi-unit configuration!

There are several reasons for a multi-unit configuration:

- If more output power is needed than one unit can supply.
- If 240V is needed. Two CombiMaster Inverter/Charger units can be connected in a split-phase configuration to deliver 240V for high-power loads like air-conditioning. Connecting two more units in parallel as well, increases the split-phase power.

Maximum system configuration:

Configuration type	12V/3500W-200A	24V/3500W-100A	24V/4500W-120A	48V/5000W-70A
Single-phase parallel	Up to 3 units: 120V/10.5kW	Up to 7 units: 120V/24.5kW	Up to 7 units: 120V/31.5kW	Up to 7 units: 120V/35kW
Split-phase	2 units: 240V/3.5kW	2 units: 240V/3.5kW	2 units: 240V/4.5kW	2 units: 240V/5kW
Split-phase with 2 units in parallel	2x2 units: 240V/14kW or 7kW per phase	2x2 units: 240V/14kW or 7kW per phase	2x2 units: 240V/18kW or 9kW per phase	2x2 units: 240V/20kW or 10kW per phase

Notes:

- Only CombiMaster Inverter/Charger units of the same model, with the same product code and same firmware version, can be used for parallel or split phase operation.
- Install the units close to each other (no more than 1ft apart) to prevent ground loops!
- Preferably, install the units next to each other rather than above each other, to prevent thermal influence.
- It is best practice to label the units (e.g. Primary, Replica1, Replica2) and L1 and L2.
- Use ONE battery bank whose capacity is suitable for the application!
- If single point neutral to ground bonding is required, please refer to the related Technical Bulletin. Technical Bulletins are published on the portal on the Mastervolt website.

7.2 Materials needed

Description (n = number of parallel units)	Single-phase parallel	Split-phase	Split-phase + 2 parallel
Multiple units of the same type and model	n	2	4
Temperature sensor with cable and plug	included	included	included
DC + cables of equal gauge and length	n	2	4
DC fuse	n	2	4
DC – cables of equal gauge and length	n	2	4
AC input cables of equal gauge and length	n	2	4
AC input breaker	n	2	4
AC output cables of equal gauge and length	n	2	4
AC output breaker	n	2	4
CZone drop cable (for a CZone network only)	included	included	included
MasterBus Terminator (for a new MasterBus network only)	included	included	included
MasterBus cables between units*	n-1	1	3
Communication cable*	n	2	4
Current Sharing cable*	n	0	4
Cable Strain Relief Bracket*	n	0	4

* Mastervolt offers various cable kits that contain this item. See the Mastervolt website for details.

7.3 Preparations

- Make sure that all power sources (AC and DC) are turned off.
- Make sure the "On/Charge only"-switch position is "Charge only" (●) on all units.



- Remove the front cover plate by loosening the two screws at the bottom, and make sure that all DIP switches are off on all units.

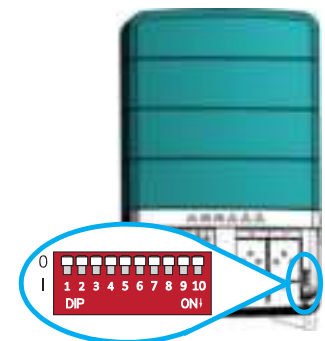

- By default, the Neutral (N) output automatically connects to the Safety Ground (PE) when the CombiMaster Inverter/Charger is disconnected from an external AC source. See also section AC safety grounding on page 17.

Refer to the related Technical Bulletin for more information on multi-unit configuration with single point neutral to ground bonding. Technical Bulletins are published on the portal on the Mastervolt website.



7.4 DC wiring

- Notes:**
- DC wiring is the same for parallel and split-phase systems.
 - Use ONE battery bank whose capacity is suitable for the application.
 - Always use the same length cables! Be aware that to keep the drawings in this chapter clear and easy to read, the cable lengths have not been drawn in proportion to each other.
 - * Integrate a fuse holder in the positive battery wire but do not place the fuse yet!

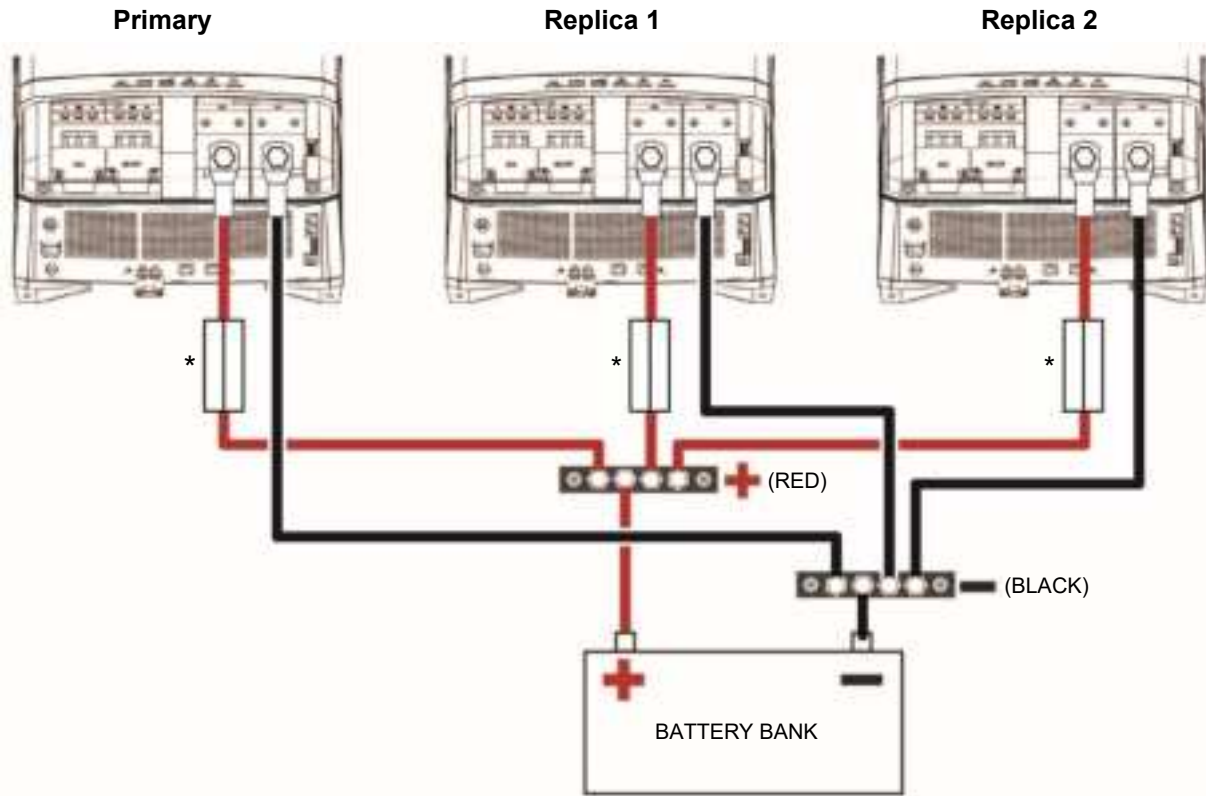

Figure 10: DC wiring example

7.5 AC wiring



CAUTION!

The AC input and output for each CombiMaster Inverter/Charger must be protected with properly sized circuit breakers that switch off simultaneously L and Neutral.

Note: In parallel configurations, always use cables of equal gauge and length! Different cable length in the AC wiring causes unequal power distribution through the CombiMaster Inverter/Charger. The following figure shows that cables with the same marking are the same length. Be aware that to keep the drawings further on in this chapter clear and easy to read, the cable lengths have not been drawn in proportion to each other!

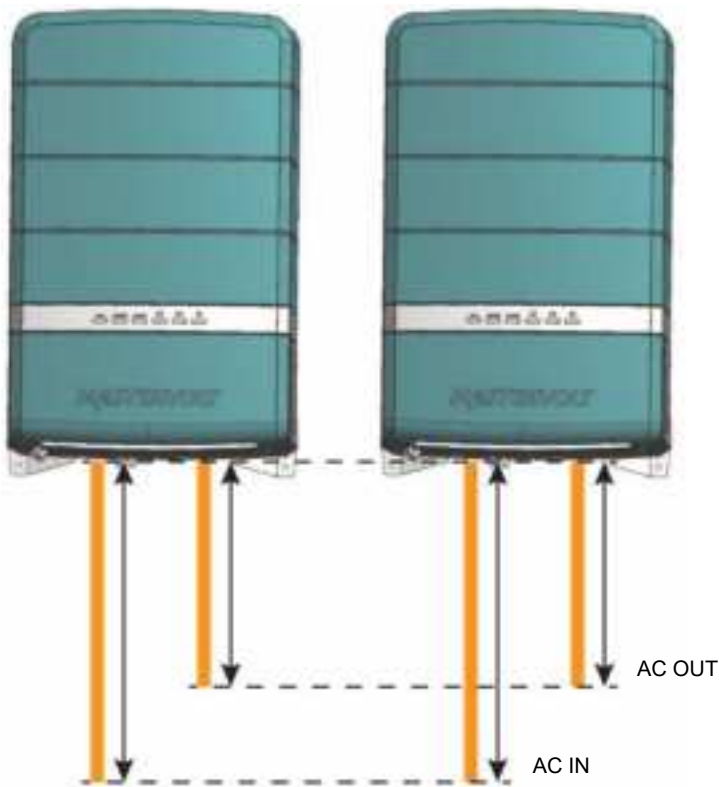

Figure 11: equal cable lengths

Recommended wire colors (refer to local rules):

120Vac single-phase		
Color	Meaning	Must be connected to
Black	Hot or Line	L
White	Neutral	N
Green	Ground	

240Vac split-phase		
Color	Meaning	Must be connected to
Black	L1	L
White	Neutral	N
Red	L2	L
Green	Ground	

7.5.1 AC wiring of single-phase parallel units

Connect the AC input L, PE and N wires to the AC IN screw terminals.

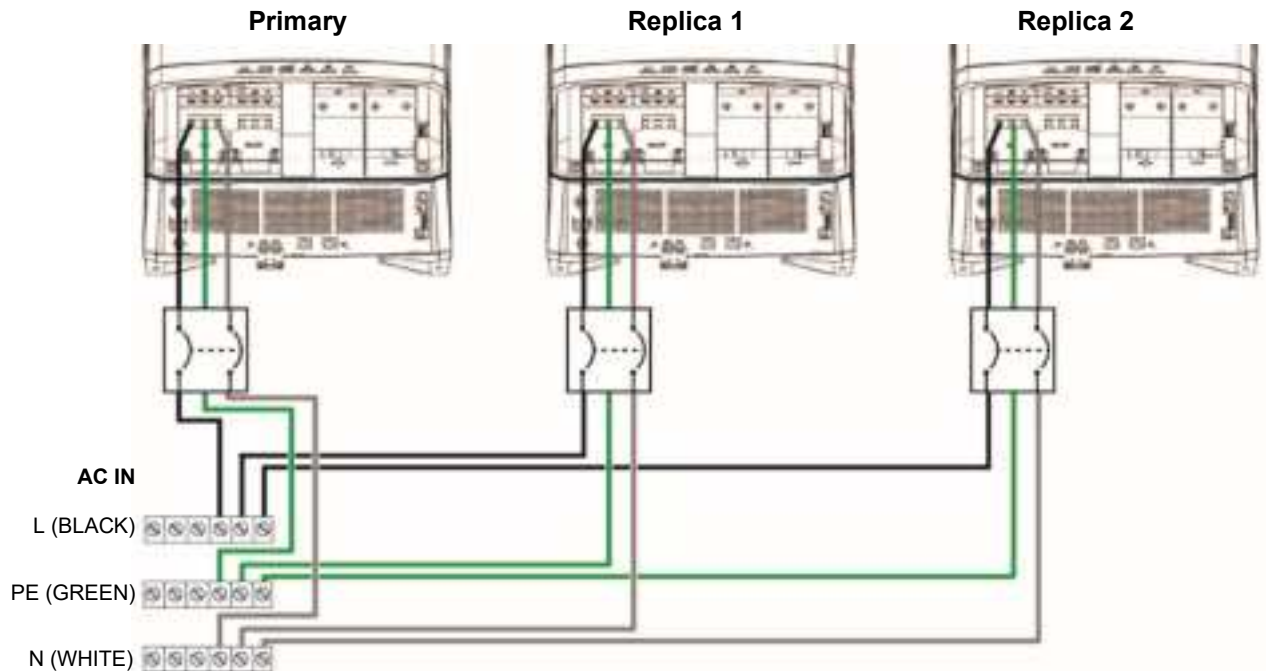

Figure 12: wiring single-phase AC IN

Connect the AC output L, PE and N wires to the AC OUT screw terminals.

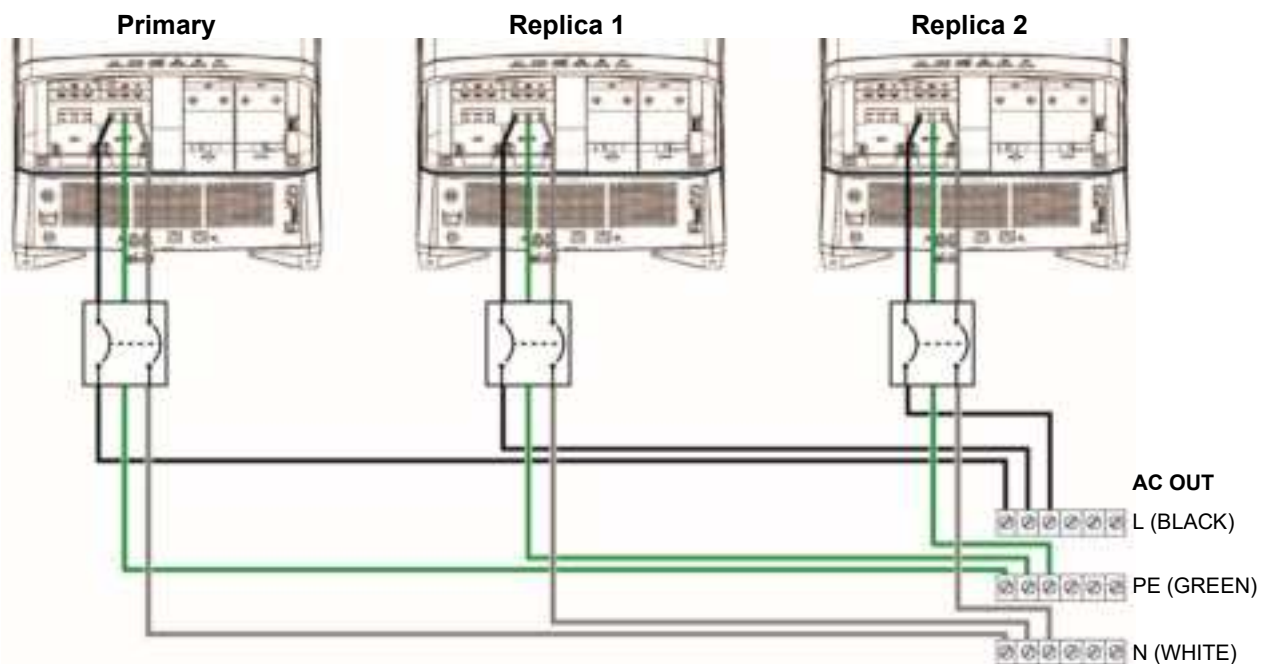

Figure 13: wiring single-phase AC OUT

7.5.2 AC wiring of split-phase units (one unit for each phase)

- Connect the AC input L1, L2, N and PE of each unit in split-phase by means of a busbar.
- An Equipment Leakage Circuit Interrupter (ELCI) must be installed with or in addition to the main (shore) power disconnect circuit breaker. Check locally applicable regulations on this matter, such as ABYC for marine applications.

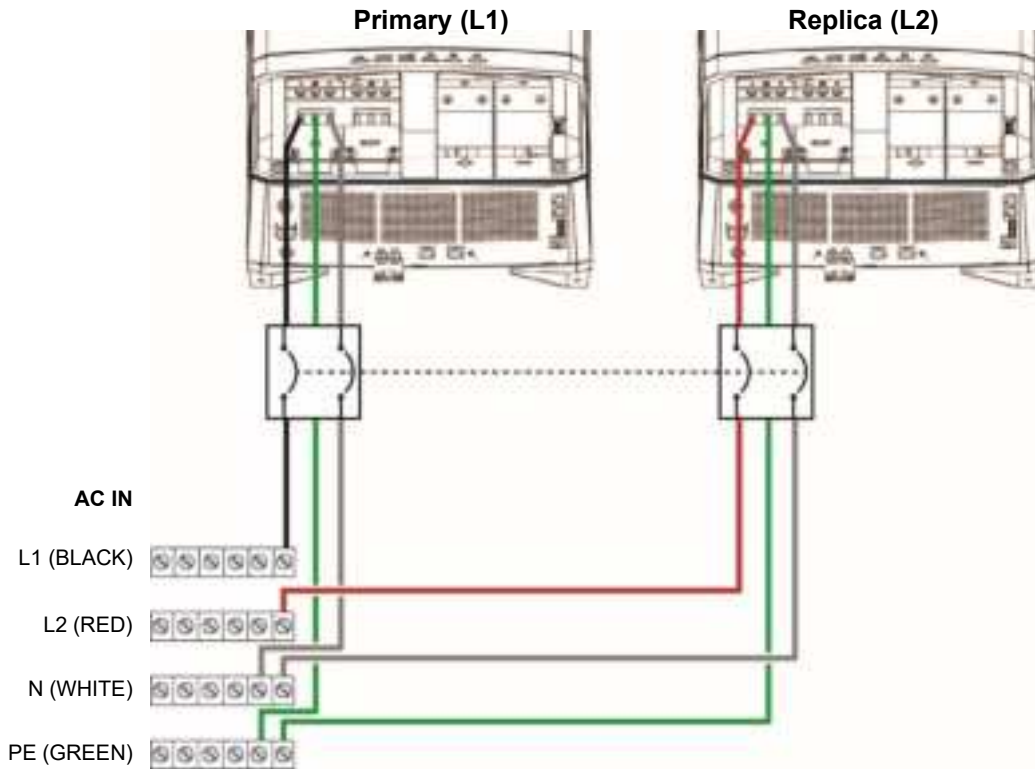

Figure 14: wiring split-phase AC IN

- Connect the AC output L1, L2, N and PE of each unit in split-phase by means of a busbar.
- The AC output of each unit must be protected by means of properly sized circuit breakers (85A max) that switch off simultaneously L1, L2 and Neutral.

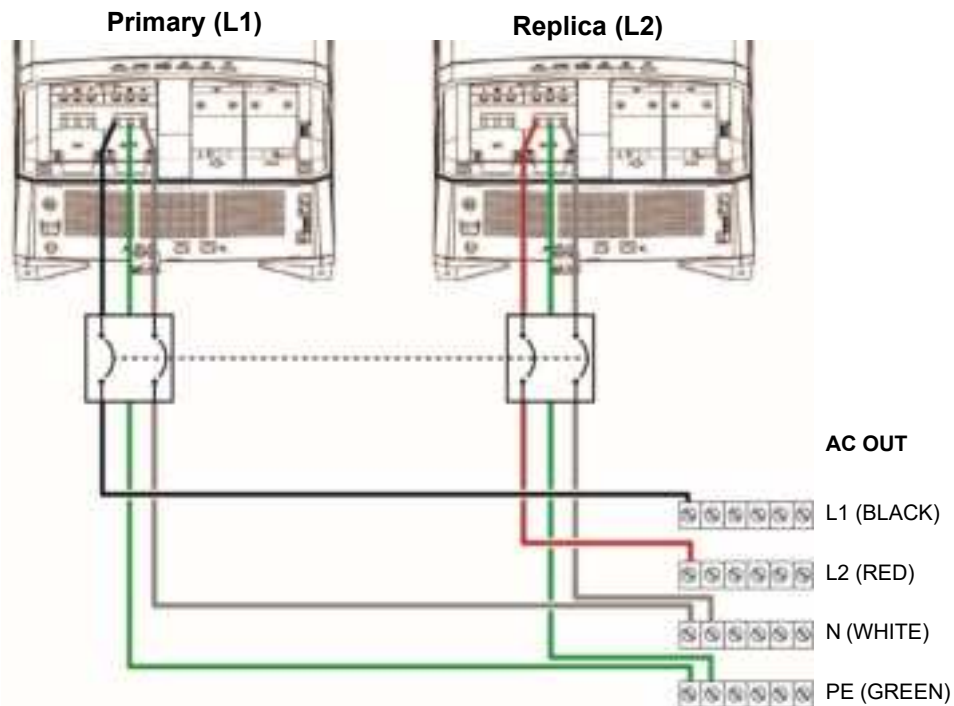

Figure 15: wiring split-phase AC OUT

- All AC loads must be protected by means of properly sized circuit breakers and a Ground Fault Circuit Interrupter (GFCI).

7.5.3 AC wiring of split-phase (two parallel units for each phase)

- Connect the AC input L1, N and PE of the Primary (L1) and Replica 1 (L1) unit in parallel by means of a busbar. The cables (length and wire gauge) must be identical.
- Connect the AC input L2, N and PE of the Replica 2 (L2) and Replica 3 (L2) unit in parallel by means of a busbar. The cables (length and wire gauge) must be identical.
- The AC input of each unit must be protected by means of properly sized circuit breakers (50A max) that switch off simultaneously L and Neutral.
- An Equipment Leakage Circuit Interrupter (ELCI) must be installed with or in addition to the main (shore) power disconnect circuit breaker. Check locally applicable regulations on this matter, such as ABYC for marine applications.

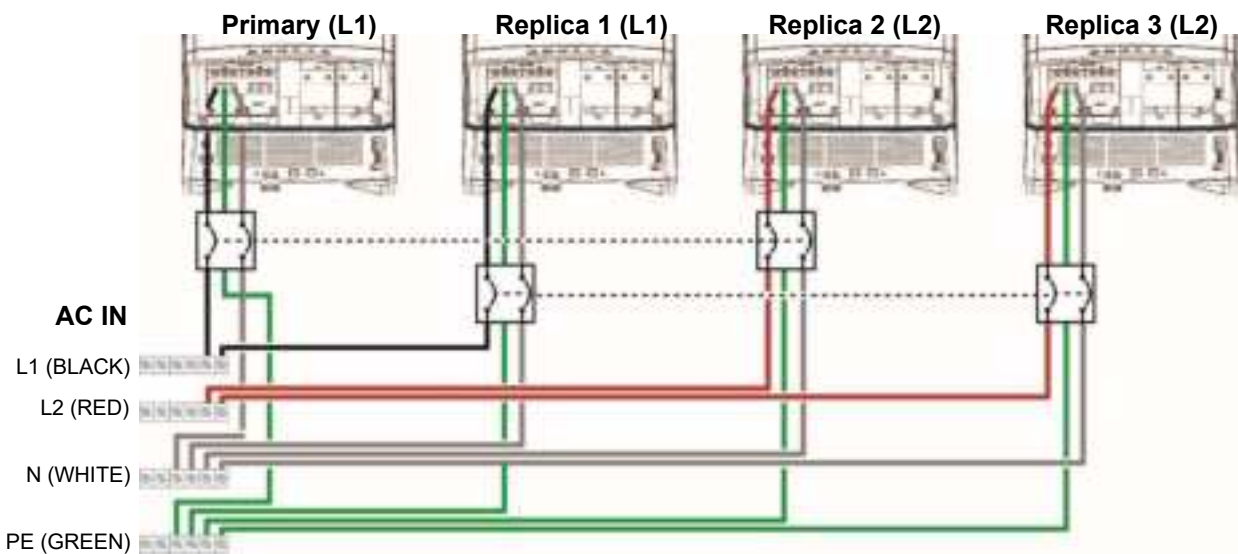

Figure 16: wiring split-phase + parallel AC IN

- Connect the AC output L1, N and PE of the Primary (L1) and Replica 1 (L1) unit in parallel by means of a busbar. The cables length and wire gauge must be identical.
- Connect the AC output L2, N and PE of the Replica 2 (L2) and Replica 3 (L2) unit in parallel by means of a busbar. The cable length and wire gauge must be identical.
- The AC output of each CombiMaster Inverter/Charger must be protected by means of properly sized circuit breakers (85Amax) that switch off simultaneously L1, L2 and Neutral.

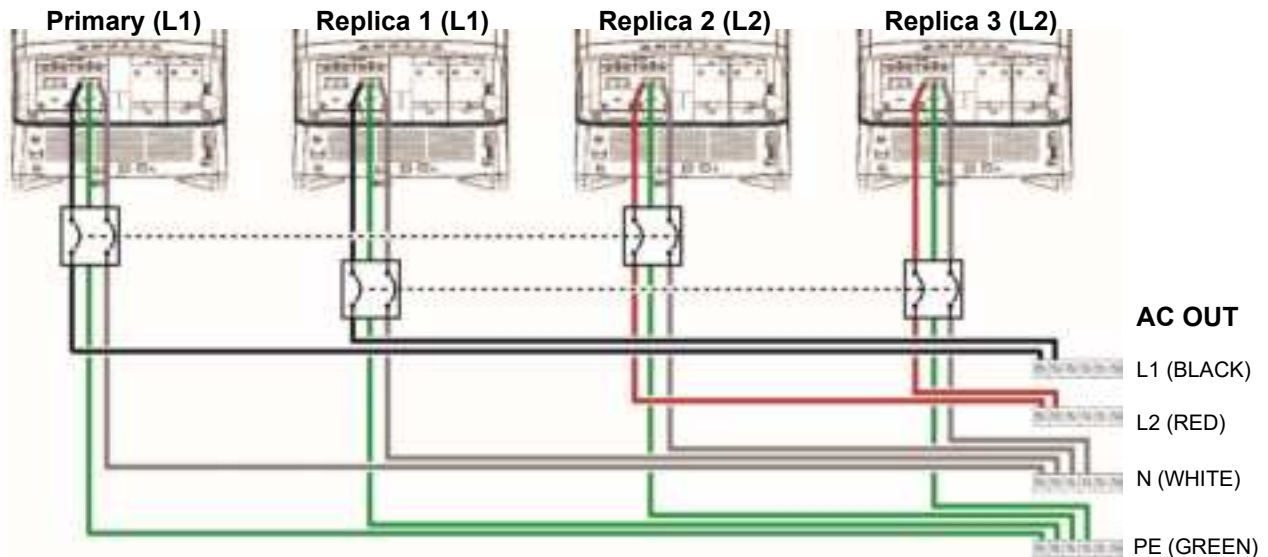

Figure 17: wiring split-phase + parallel AC OUT

All AC loads must be protected by means of properly sized circuit breakers and a Ground Fault Circuit Interrupter (GFCI).

7.6 Network wiring

7.6.1 Preparation

Parallel Current Sharing and cluster Communication cables are relatively short because stacked units should be installed in close proximity to each other. Connect the optional strain relief for parallel Current Sharing cables with two bolts to the bottom of the CombiMaster Inverter/Charger.

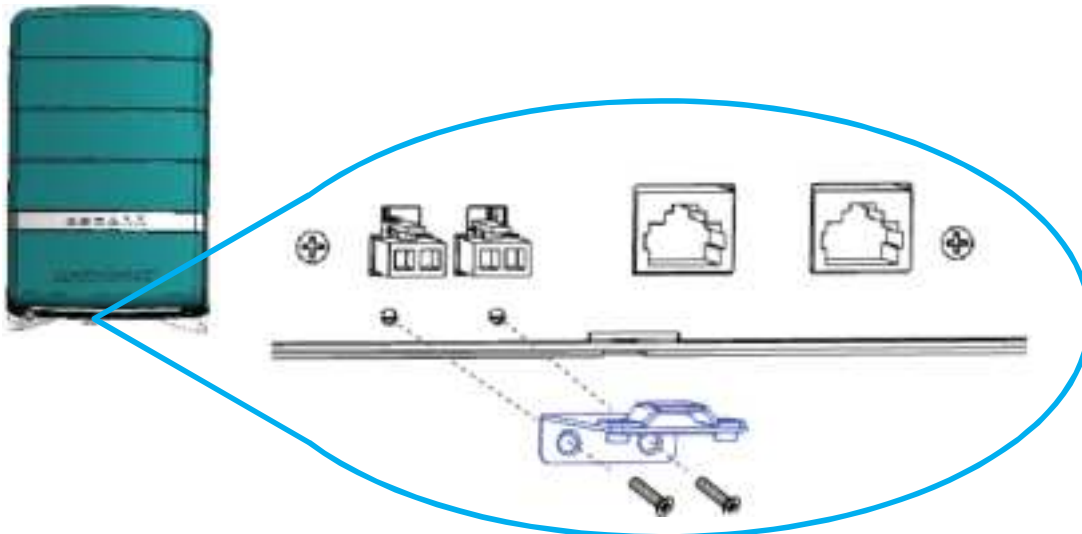

Figure 18: Attaching the strain relief at the bottom of a CombiMaster Inverter/Charger

7.6.2 Network wiring of single-phase parallel units

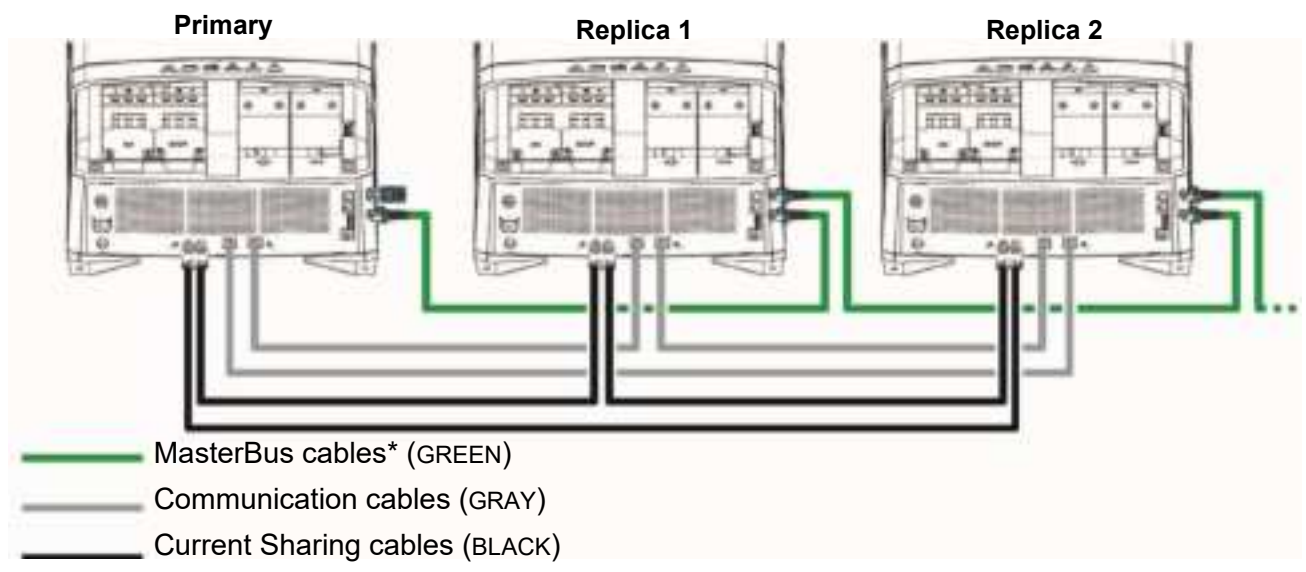

Figure 19: Three units in parallel – MasterBus network wiring

* In case of a CZone network, connect drop cables instead of MasterBus cables. Plug the connectors into either of the ports. In case of a MasterBus network, the MasterBus Terminator may be located somewhere else in the network. Ensure that the MasterBus or CZone network is properly terminated.

7.6.3 Network wiring of split-phase units

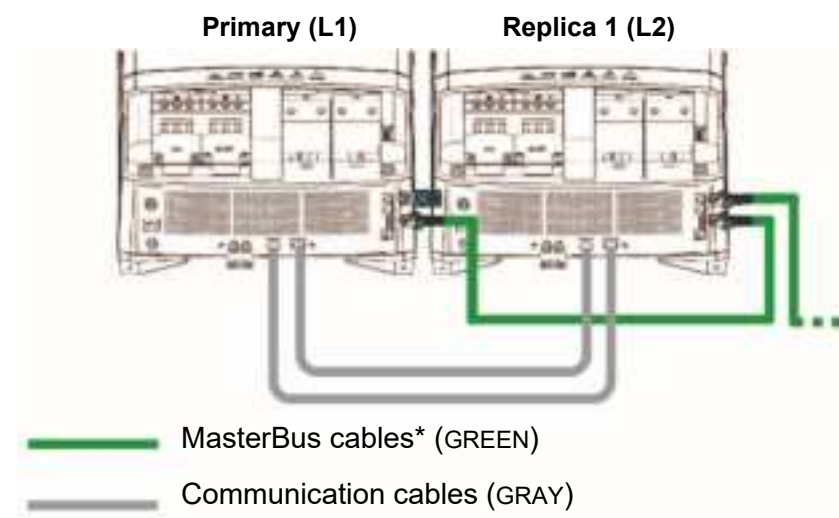

Figure 20: Two units in split-phase – MasterBus network wiring

* In case of a CZone network, connect drop cables instead of MasterBus cables. Plug the connectors into either of the ports. In case of a MasterBus network, the MasterBus Terminator may be located somewhere else in the network. Ensure that the MasterBus or CZone network is properly terminated.

7.6.4 Network wiring of two units in split-phase with two units in parallel

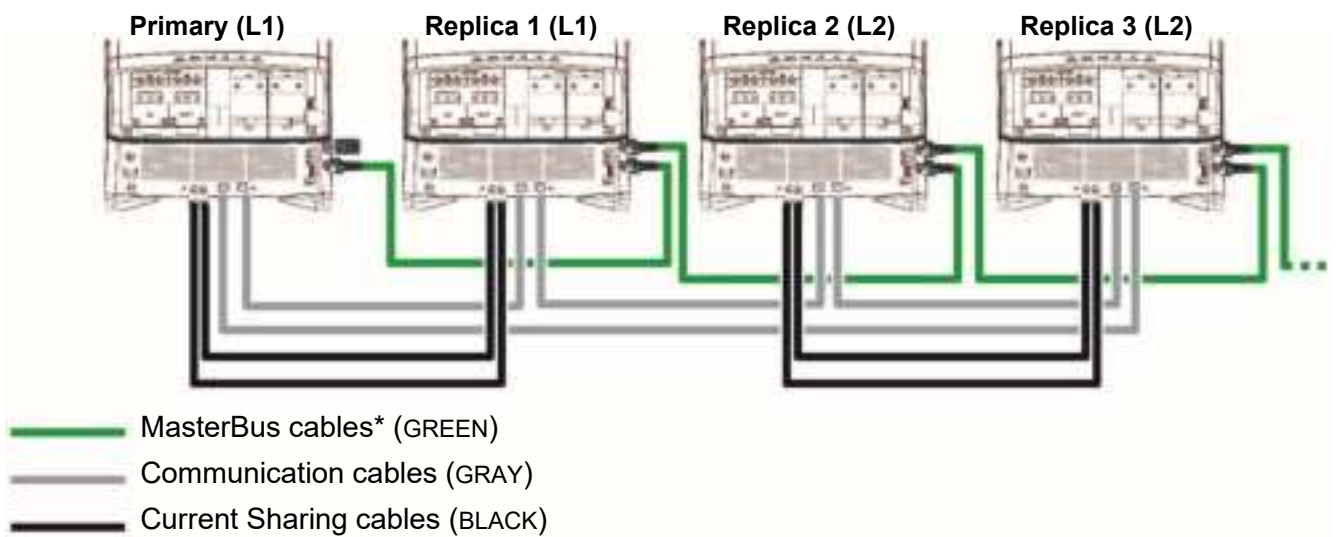

Figure 21: Two units in split-phase and two in parallel – MasterBus network wiring

* In case of a CZone network, connect drop cables instead of MasterBus cables. Plug the connectors into either of the ports. In case of a MasterBus network, the MasterBus Terminator may be located somewhere else in the network. Ensure that the MasterBus or CZone network is properly terminated.

7.7 Configuration and initial start-up

There are three methods of configuring the CombiMaster Inverter/Charger units:

- DIP switches; for a single-phase parallel configuration in a MasterBus system only
- MasterAdjust
- CZone Configuration Tool

7.7.1 DIP switches (for a single-phase parallel configuration in a basic MasterBus system)

- Step 1. Make sure that all power sources (AC and DC) are turned off.
- Step 2. Make sure the AC IN and AC OUT breakers are open.
- Step 3. Make sure the "On/Charge only"-switch position is "Charge only" (●) on all units.
- Step 4. Check all connections are firmly tightened.
- Step 5. On all units:
Set DIP switches 1 and 2 on for MasterBus operation.
Set DIP switch 10 on for parallel operation.
Set DIP switches 3 to 9 to fit the requirements.

Note: all units must have the same DIP switch settings!

MasterBus DIP switch settings	1	2	3	4	5	6	7	8	9	10
MasterBus operation off	0									
MasterBus operation on	1									
MasterBus powering off		0								
MasterBus powering on		1								
Configurable via MasterAdjust (Flooded by default)			0	0	0					
Flooded			0	0	1					
AGM			0	1	0					
Gel			0	1	1					
MLI			1	0	0					
Constant voltage (13.25V)			1	1	1					
Inverter frequency 60Hz						0				
Inverter frequency 50Hz						1				
AC input support mode off							0			
AC input support mode on							1			
AC voltage input window wide								0		
AC voltage input window narrow								1		
Energy saving mode off									0	
Energy saving mode on									1	
Parallel operation off										0
Parallel operation on										1

- Step 6. First install the DC fuses and then close the battery switch.
Check the DC voltage between plus and minus on each unit.
- Step 7. Close the connection compartment of each unit.
- Step 8. Switch all units on ("On/Charge only"-switch position is "On" (I)).
- Step 9. Check that LED 2 is blinking green for 5 seconds during start-up to verify that the unit is configured for parallel operation. *If LED 1 blinks green or if LEDs 2 and 3 are blinking red, check the DIP switches, cabling, and AC breakers are open. Then switch off all units, wait for 60 seconds and switch the units on again.*
- Step 10. Switch all units off ("On/Charge only"-switch position is "Charge only").
- Step 11. Close the AC OUT breaker of each unit.
- Step 12. Switch all units on ("On/Charge only"-switch position is "On" (I)).
- Step 13. Check if the units are working in inverter mode (LED 2 is on green).
- Step 14. Close the AC IN breaker of each unit.
- Step 15. Turn on the AC power source.
- Step 16. Check if the unit switches over to charger mode when 120V AC is applied to AC IN (LEDs 1 and 3 are on green).

7.7.2 MasterAdjust

- Step 1. Make sure that all power sources (AC and DC) are turned off.
- Step 2. Make sure the AC IN and AC OUT breakers are open.
- Step 3. Make sure the "On/Charge only"-switch position is "Charge only" (●) on all units.
- Step 4. Check all connections are firmly tightened.
- Step 5. On all units, set DIP switches 1 and 2 on for MasterBus operation.
- Step 6. First install the DC fuses and then close the battery switch.
Check the DC voltage between plus and minus on each unit.
- Step 7. Close the connection compartment of each unit.
- Step 8. Switch all units on ("On/Charge only"-switch position is " On" (I)).
- Step 9. At start-up all units will display an error (LEDs 2 and 3 will be blinking red). This is normal.

Note: Cluster settings are done in the unit chosen as Primary (L1) unit only. However, battery settings must be configured for all units separately.

- Step 10. In MasterAdjust, right-click the **USB:MasterBus device** and select **Login**.
- Step 11. Select **1=Installer** and enter the password.
- Step 12. Go to the **Configuration** tab of the unit that you want to make the L1 unit and give the unit a logical name.

- Step 13. From the **Phase System** drop-down list, select *Split phase* or *Single phase*.
- Step 14. With the **Dev. per phase** stepper, select PER PHASE the number of units in parallel (Primary + Replica). In our example this is 2.
- Step 15. Click the **Confirm topology** button to enable selection of the other units. Per phase one or more drop-down lists will appear. In our example there are 4 units in total.
- Step 16. From the **Device #** drop-down lists, select the required unit(s).
Note: pay attention to the phase the unit is attached to!
- Step 17. Click the **Activate cluster** button.
- Notice the **Cluster topology** and **Cluster state**.
Topology monitors the size of the cluster i.e., whether selected units is equal to selected number of devices.
State monitors the configuration state of the cluster, which can be:
- Incomplete; indicating not all devices have been selected yet
 - Not activated; indicating for all devices a unit has been selected. Clicking the Activate cluster button will bring the selected units into this cluster.
 - Activated; the units have successfully been placed into this cluster.
 - Standalone; no cluster 'topology' has been selected.
 - Replica; another device is cluster-primary, and this unit is part of that cluster.
 - Double device; a device has been selected more than once.
 - Missing devices; a selected device is no longer present on the MasterBus network.
 - Cluster conflict; an error is made in the selection of the cluster topology.

- Step 18. Configure battery type settings on the configuration page. Although, battery settings must be configured for all units separately, they must be the same for each unit!
- Step 19. Switch all units off ("On/Charge only"-switch position is "Charge only" (●)).
- Step 20. Wait for 60 seconds and switch the units on again.
- Step 21. Check the status of the LEDs during start-up to verify the configuration:
 - LED 1 green blinking 5 seconds: single-phase standalone
 - LED 2 green blinking 5 seconds: single-phase parallel
 - LED 3: green blinking 5 seconds: split-phase L1
 - LED 4: green blinking 5 seconds: split-phase L2
 - LED 2 and red 3 blinking: error. Check cabling, AC breakers are open, and cluster settings in MasterAdjust. Then switch off all units, wait for 60 seconds and switch the units on again.
- Step 22. Switch all units off ("On/Charge only"-switch position is "Charge only").
- Step 23. Close the AC OUT breaker of each unit.
- Step 24. Switch all units on ("On/Charge only"-switch position is "On" (I)).
- Step 25. Check if the units are working in inverter mode (LED 2 is on green).
- Step 26. Close the AC IN breaker of each unit.
- Step 27. Turn on the AC power source.
- Step 28. Check if the unit switches over to charger mode when 120V AC is applied to AC IN (LEDs 1 and 3 are on green).

7.7.3 CZone Configuration Tool

- Step 1. Make sure that all power sources (AC and DC) are turned off.
- Step 2. Make sure the AC IN and AC OUT breakers are open.
- Step 3. Make sure the "On/Charge only"-switch position is "Charge only" (●) on all units.
- Step 4. Check all connections are firmly tightened.
- Step 5. On all units, keep DIP switches 1 and 2 off for CZone operation. DIP switches 3 to 10 must match a unit's unique address used in the CZone network; the dipswitch. At least one of DIP switches from 3 to 10 must be on.
- Step 6. First install the DC fuses and then close the battery switch.
Check the DC voltage between plus and minus on each unit.
- Step 7. Close the connection compartment of each unit.
- Step 8. Switch all units on ("On/Charge only"-switch position is " On" (I)).
- Step 9. At start-up all units will display an error (LEDs 2 and 3 will be blinking red). This is normal.
- Step 10. Use the CZone Configuration Tool to configure the system. See section 5.3 on page 32 for the general CZone instructions.
- Step 11. When the CZone system is configured, including all CombiMaster Inverter/Charger units, create a cluster in a CZone network: In the CZone Configuration Tool, in the Modules tab, double-click the CombiMaster Inverter/Charger that will act as Primary unit.
- Step 12. The Module Modifications window appears. Click the **Advanced Settings** button.
- Step 13. From the **Cluster Type** drop-down list, select **Primary** and click the press **Configure Topology** button.
- Step 14. In the Cluster Configuration window, from the **Phase System** drop-down list, select **Single Phase** or **Split Phase**. Our example is a single-phase configuration.

The configuration will be shown as per below image.

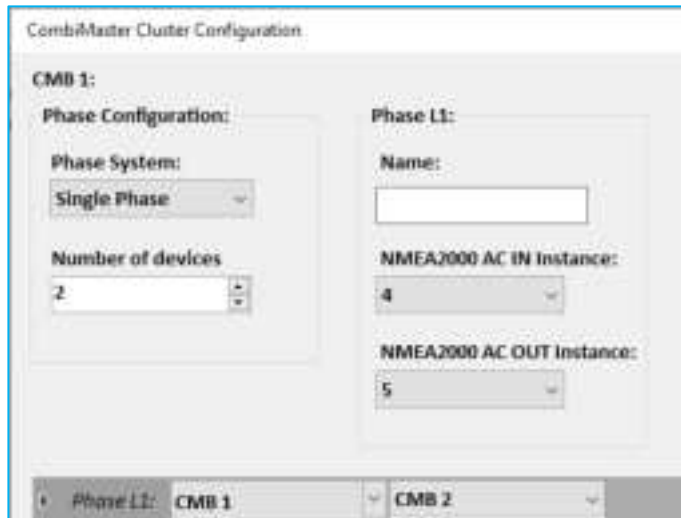

- Step 15. Enter the **Number of devices** (or *Devices per Phase* in case of a split phase configuration). In case of a split-phase configuration, this is the number of units per phase!
- Step 16. Enter a phase **Name**.
- Step 17. Select **AC IN/OUT Instances**. An instance is used to differentiate between multiple monitoring sources.
- Step 18. Select the cluster replicas from the Phase (L1) drop-down list(s).
- Step 19. Keep clicking **OK** until all dialog windows have disappeared.
- Step 20. Write the configuration to the network to use the new configuration.
To identify the Primary unit, go to the Meters tab. The CombiMaster Inverter/Charger with two or three AC IN/OUT Instances is the Primary unit.
- Step 21. Switch all units off ("On/Charge only"-switch position is "Charge only" (●)).
- Step 22. Wait for 60 seconds and switch the units on again.
- Step 23. Check the status of the LEDs during start-up to verify the configuration
LED 1 green blinking 5 seconds: single-phase standalone
LED 2 green blinking 5 seconds: single-phase parallel
LED 3: green blinking 5 seconds: split-phase L1
LED 4: green blinking 5 seconds: split-phase L2
LED 2 and red 3 blinking: error. Check cabling, AC breakers are open, and cluster settings in MasterAdjust. Then switch off all units, wait for 60 seconds and switch the units on again.
- Step 24. Switch all units off ("On/Charge only"-switch position is "Charge only").
- Step 25. Close the AC OUT breaker of each unit.
- Step 26. Switch all units on ("On/Charge only"-switch position is "On" (I)).
- Step 27. Check if the units are working in inverter mode (LED 2 is on green).
- Step 28. Close the AC IN breaker of each unit.
- Step 29. Turn on the AC power source.
- Step 30. Check if the unit switches over to charger mode when 120V AC is applied to AC IN (LEDs 1 and 3 are on green).

7.8 Breaking down a cluster

If a unit has to be removed from an existing cluster, use one of the following 3 procedures.

Using DIP switches:

- a) Make sure the AC IN and AC OUT breakers are open.
- b) Make sure the "On/Charge only"-switch position is "Charge only" (●) on all units.
- c) On the unit to be removed, set DIP switch 10 to the OFF position (0).
- d) Remove the Current Sharing and parallel Communication cables of the related unit.
- e) For the settings to take effect, reconfigure the cluster.

Using MasterAdjust:

- a) Make sure the AC IN and AC OUT breakers are open.
- b) Make sure the "On/Charge only"-switch position is "Charge only" (●) on all units.
- c) To return to fewer units per phase, change the *Dev. per phase* value and click *Confirm* topology again.
To breakdown a cluster, select *Single phase* and *1 Device per phase* and click the *Confirm* topology button.
To remove a replica unit from the cluster, go to the *Configuration* tab of the related unit and click the *Detach* button.
- d) Remove the Current Sharing and parallel Communication cables of the related unit.
- e) For the settings to take effect, reconfigure the cluster.

Using the CZone Configuration tool:

- a) Make sure the AC IN and AC OUT breakers are open.
- b) Make sure the "On/Charge only"-switch position is "Charge only" (●) on all units.
- c) To breakdown a cluster, go to the *Advanced Settings* of the *Primary* unit and from the *Cluster Type* drop-down list, select *None*.
- d) Remove the Current Sharing and parallel Communication cables of the related unit.
- e) For the settings to take effect, reconfigure the cluster.

8 TROUBLESHOOTING

If you cannot solve a problem using the fault-finding table, contact your Mastervolt dealer. Make sure you have the part and serial number at hand.

Malfunction	Possible cause	What to do
No output voltage and/or current	No AC input	Check AC wiring, check remote control panel.
	AC input out of range (< 75VAC)	Check input voltage.
	AC input frequency out of range	Check input frequency.
	Thermal breaker has tripped	Check the load and reset the fuse (see section 6.6).
	Overheating error	Check whether the air flow of the CombiMaster Inverter/Charger is blocked or the ambient temperature is too high. Reduce the connected load and let the CombiMaster Inverter/Charger cool down.
	External breaker or GFCI (RCD) has tripped	Check the external breaker at the AC output (if applied).
	Inverter is off	Check the "On/Charge only"-switch or the remote setting of the Inverter button.
Output voltage too low, charger supplies maximum current	Load connected to the batteries is larger than charger can supply.	Reduce load taken from the batteries.
	Batteries not 100% charged	Measure battery voltage. After some time this will be higher.
	Wrong setting of the charge voltage	Check settings (see chapter 5).
Charge current too low	Batteries almost fully charged	Nothing, this is normal when the battery is almost fully charged.
	High ambient temperature	Nothing; if ambient temperature is more than the setting limit, the charge current is automatically reduced.
	Low AC input voltage. At lower AC input voltages, the charge current is reduced.	Check AC input voltage.
Batteries not fully charged	Charge current too low	See "Charge current too low" in this table.
	Current to load is too high	Reduce load taken from the batteries.
	Battery temperature too low	Use the battery temperature sensor.
	Defective or old battery	Check battery and replace if necessary.
	Wrong setting of the charge voltage	Check settings (see chapter 5).

Malfunction	Possible cause	What to do
Battery low causing CombiMaster Inverter/Charger shutdown	Discharged battery	Connect AC input to recharge battery Note: when charging an empty battery from a different power source, like an alternator, the CombiMaster Inverter/Charger must be reset manually by switching the "On/Charge only"-switch off and on again.
Batteries are discharged too fast	Battery capacity reduced due to wastage or sulphation, stagnation	Charge and recharge a few times, this might help. Check battery and replace if necessary.
Batteries are too warm, gassing	Defective battery (short circuit in cell)	Check battery and replace if necessary.
	Battery temperature too high	Use the battery temperature sensor.
	Charge voltage too high	Check settings (see chapter 5).
No remote control display function.	Display is switched off.	Switch on display, refer to display manual.
	Error in the CZone/MasterBus wiring.	Check the CZone/MasterBus cables.
Slow or no remote control communication.	Error in the CZone/MasterBus wiring.	Check the CZone/MasterBus cables.
	No terminator placed at the ends of the CZone/MasterBus network.	Check if a terminator is placed on both ends of the network.
	CZone/MasterBus network is configured as a ring network.	Ring networks are not allowed. Check the connections of the network.

9 TECHNICAL DATA

Specifications are subject to change without prior notice.

9.1 Inverter specifications

Model	12V/ 1500W- 60A	12V/ 2000W- 100A	12V/ 3000W- 160A	24V/ 2000W- 60A	24V/ 3000W- 70A	12V/ 3500W- 200A	24V/ 3500W- 100A	24V/ 4500W- 120A	48V/ 5000W- 70A
Product code	35511500	35512000	35513000	35522000	35523000	35513500	35523500	35524500	35545000
Nominal battery voltage	12V	12V	12V	24V	24V	12V	24V	24V	48V
Inverter output voltage	120V (inverter only) or 90-140V (AC input support mode)					120V (inverter only) or 90-140V (AC input support mode) or 240V (split-phase)			
Continuous power @Tamb=77°F [25°C]	1500W	2000W	3000W	2000W	3000W	3500W	3500W	4500W	5000W
Continuous power @Tamb=104°F [40°C]	1500W	2000W	2600W	2000W	2600W	3500W	3500W	4500W	5000W
Continuous power @Tamb=140°F [60°C]	750W shutdown above 140°F	1000W shutdown above 140°F	1500W shutdown above 140°F	1000W shutdown above 140°F	1500W shutdown above 140°F	1750W shutdown above 140°F	1750W shutdown above 140°F	3375W	3750W
Continuous power @Tamb=176°F [80°C]	n/a	n/a	n/a	n/a	n/a	n/a	n/a	2250W shutdown above 176°F	2500W shutdown above 176°F
Max. peak load (10sec)	150%	150%	150%	150%	150%	150%	150%	150%	150%
Max. peak load (5sec)	200%	200%	200%	200%	200%	200%	200%	200%	200%
Output waveform	– True sine –								
Max. efficiency	91%	91%	91%	91%	91%	93%	93%	93%	93%
DC input voltage range	10-16V	10-16V	10-16V	20-32V	20-32V	10-16V	20-32V	20-32V	40-64V
Switch off voltage low battery	10.2V	10.2V	10.2V	20.4V	20.4V	10.2V	20.4V	20.4V	40.8V
Switch on voltage low battery	11.5V	11.5V	11.5V	23.0V	23.0V	11.5V	23V	23V	46V
Switch off voltage high battery	16V	16V	16V	32V	32V	16V	32V	32V	64V
Switch on voltage high battery	15V	15V	15V	30V	30V	15V	30V	30V	60V

Model	12V/ 1500W- 60A	12V/ 2000W- 100A	12V/ 3000W- 160A	24V/ 2000W- 60A	24V/ 3000W- 70A	12V/ 3500W- 200A	24V/ 3500W- 100A	24V/ 4500W- 120A	48V/ 5000W- 70A
Max. ripple on DC @ full load	15%	15%	15%	15%	15%	15%	15%	15%	15%
Nominal DC current at full load	150A	200A	300A	100A	150A	350A	175A	225A	125A
Recommended battery capacity	120-600Ah	200-1000Ah	320-1600Ah	120-600Ah	140-700Ah	400-2000Ah	200-1000Ah	240-1200Ah	140-700Ah
Frequency	– 50Hz / 60Hz (configurable) –								
No load DC power consumption									
Inverter off mode	<2mA	<2mA	<2mA	<2mA	<2mA	<1mA	<1mA	<1mA	<1mA
Energy saving mode	<10W	<10W	<10W	<10W	<10W	20W	25W	25W	30W
Normal operation mode	<30W	<30W	<30W	<30W	<30W	37W	47W	47W	57W

9.2 Charger specifications

Model	12V/ 1500W- 60A	12V/ 2000W- 100A	12V/ 3000W- 160A	24V/ 2000W- 60A	24V/ 3000W- 70A	12V/ 3500W- 200A	24V/ 3500W- 100A	24V/ 4500W- 120A	48V/ 5000W- 70A
Product code	35511500	35512000	35513000	35522000	35523000	35513500	35523500	35524500	35545000
Input voltage range	90 – 140V (derating below 90V)				90 – 130V (derating below 110V)				
Max AC input current	9A	16A	25A	19A	22A	32A	32A	38A	45A
Max. charge current @Tamb=104°F [40°C]	60A at 14.25V	100A at 14.25V	160A at 14.25V	60A at 28.5V	70A at 28.5V	200A at 14.25V	100A at 28.5V	120A at 28.5V	70A at 57V
Battery temperature sense	– Input present, sensor included –								
Battery temperature compensation	– Yes –								
Voltage sense	No	No	No	No	No	Yes*	Yes*	Yes*	Yes*
Battery types	– Flooded (default) / AGM / Gel / MLI / Constant voltage / User defined –								
Charge characteristic	– Mastervolt 3-step+, see the following table –								
Flat battery charge	Yes, reduced (25%) charge current at low (<9V/<18V) battery voltage					Yes, reduced (10%) charge current at low (<10V/<20V/<40V) battery voltage			

* automatically for multi-unit configurations

Note: the following charge specifications are based on Mastervolt batteries. Specifications for a given chemistry of a different manufacturer may vary. If connecting batteries of a different manufacturer, make sure the manufacturer's recommendations are met. Individual adjustments are possible if in the configuration the battery type "User defined" is selected. User defined batteries can only be configured through MasterAdjust or the CZone Configuration Tool.

Charging specifications	Battery type			
	Flooded (default)	GEL	AGM	Li-ion (MLI)
Bulk voltage*	14.40 V**	14.40 V**	14.40 V**	14.25 V**
Max bulk time	480 min	480 min	480 min	480 min
Min bulk time	120 s	120 s	120 s	120 s
Start bulk time at*	13.25 V**	13.25 V**	13.25 V**	13.25 V**
Return to bulk voltage*	12.80 V**	12.80 V**	12.80 V**	13.25 V**
Bulk return time	30 s	30 s	30 s	240 s
Absorption voltage*	14.25 V**	14.25 V**	14.25 V**	14.25 V**
Max abs. time	240 min	240 min	240 min	240 min
Min abs. time	15 min	15 min	15 min	15 min
Return amps	6% I max	6% I max	6% I max	6% I max
Float voltage*	13.25 V**	13.80 V**	13.80 V**	13.50 V**

* $\pm 1\%$

** For a 24 V CombiMaster Inverter/Charger, multiply the voltages by two. For 48 V, multiply by four.

9.3 Transfer system specifications

Model	12V/1500W-60A, 12V/2000W-100A, 12V/3000W-160A, 24V/2000W-60A, 24V/3000W-70A	12V/3500W-200A, 24V/3500W- 100A, 24V/4500W-120A, 48V/5000W-70A
AC input (switched*)	30A	50A
AC output (Max connected continuous load)	40A**	85A
AC input fuse	Yes, resettable thermal breaker (30A / 50A)	
Transfer speed	10ms for narrow input range, 20ms for wide range	
Transfer voltage range	– 90-140V –	
Transfer frequency range	– 40-65Hz –	
Power sharing	– Yes –	
AC IN Support	– Yes –	
Auto-synchronize with AC input	– Yes –	

* The internal transfer switch switches both the hot (live) and neutral.

** Exceeding the max. allowable output current may damage the CombiMaster Inverter/Charger.

9.4 Miscellaneous

Model	All models
Protection degree	IP 23 vertical wall mounted, IP 21 horizontal tabletop mounted
Safety class	IEC protection class I
Operating temperature See also section 9.6	-13°F to 140°F, derating above 104°F, shutdown above 140°F [-25°C to 60°C, derating above 40°C, shutdown above 60°C] HT Models 4500W, 5000W: -13°F to 176°F, derating above 104°F, shutdown above 176°F [-25°C to 80°C, derating above 40°C, shutdown above 80°C]
Storage temperature	-22°F to 158°F [-30 to 70°C] HT Models 4500W, 5000W: -22°F to 176°F [-30 to 80°C]
Pollution degree	3
Relative humidity	Max 95% relative humidity, not condensing.
Standards, approvals & listings	UL1741, UL1236, FCC Class B
Front panel display	Yes, shows AC input state, Inverter state, charger state
Battery temperature sensor	Yes
Cooling	Vario fans
Parallel stacking	Models 3500W, 4500W, 5000W only *
Split-phase configuration	Models 3500W, 4500W, 5000W only *
3-phase configuration	No
MasterBus powering	Yes
Protections	
Ignition protected	Yes, conforming to SAE J1171/ISO 8846
<i>AC input:</i>	
AC IN limit	Adjustable
Frequency monitoring	Relay disconnects when frequency is out of range
Voltage monitoring	Relay disconnects when voltage is out of range
<i>Output:</i>	
Short circuit protection	Yes (inverter only)
Overload protection	Yes (integrated resettable thermal breaker)
Over temperature protection	Yes
AC backfeed protection	Yes
Protocols	CZone, MasterBus

* To increase the total power or to produce 240V. For information on multi-unit configurations, see chapter 7.

9.5 CZone specifications

LEN (Load Equivalence Number): 0

PGN (Parameter Group Number):

PGN	Description	Fields
127503	AC Input Status	Voltage, Current, Frequency, Real Power
127504	AC Output Status	Voltage, Current, Frequency, Real Power
127507	Charger Status	Operating State, Charger Mode, Charge Enable/Disable
127508	Battery Status	Battery Voltage, Battery Current, Battery Case Temperature
127509	Inverter Status	Operating State, Inverter Enable/Disable

9.6 Characteristics

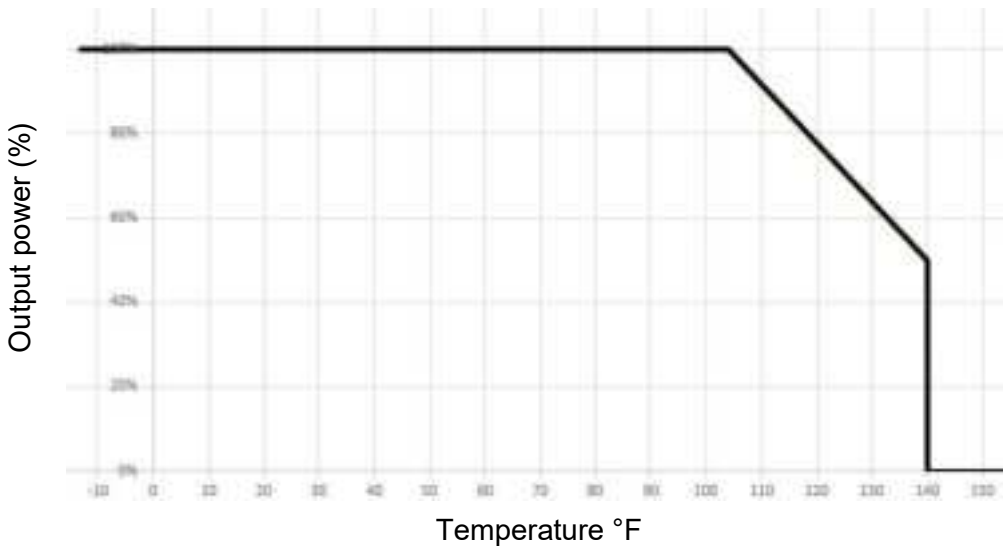

Figure 22. Output power vs temperature for models 1500W, 2000W and 3500W

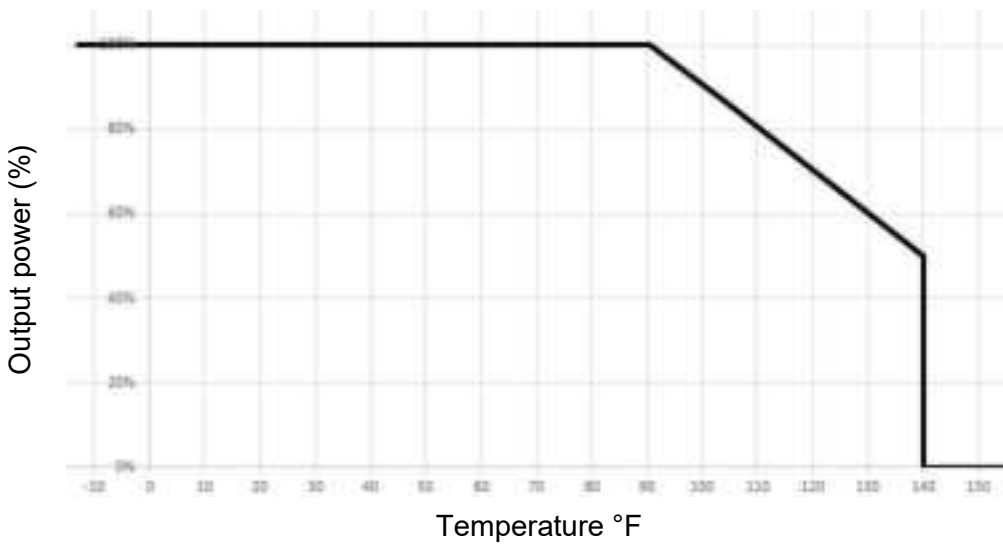

Figure 23. Output power vs temperature for models 3000W

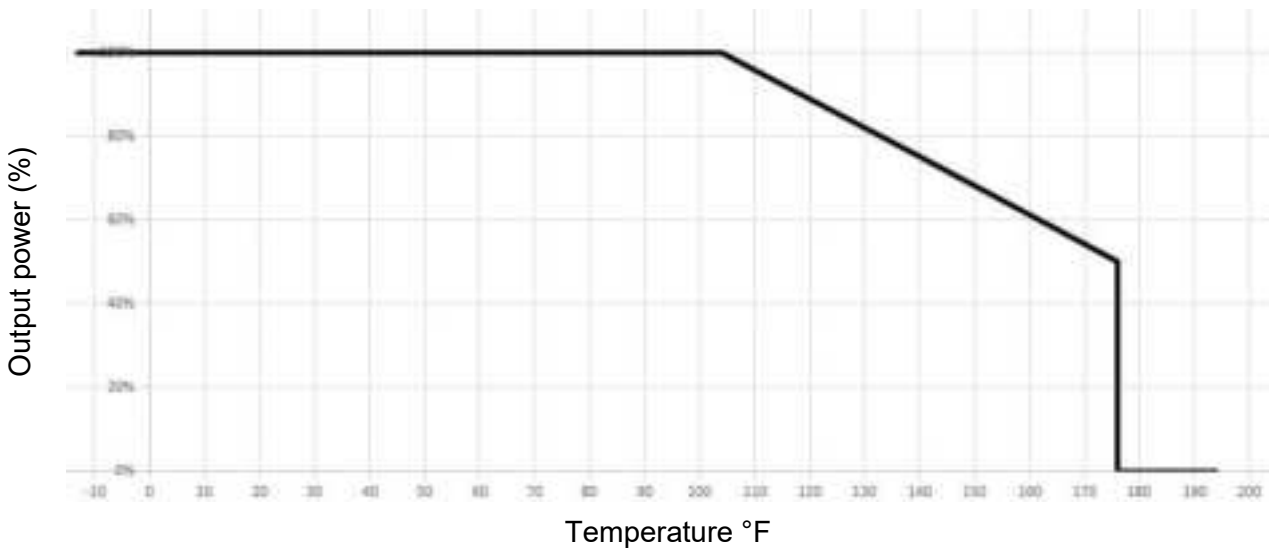

Figure 24. Output power vs temperature for models 4500W and 5000W

9.7 Dimensions

Model	Product code	h×w×d in inches [mm]	weight in lb [kg]
CombiMaster 12V/1500W-60A 120V	35511500	14.9 × 11.2 × 6.0 [378 × 284 × 153]	15 [7]
CombiMaster 12V/2000W-100A 120V	35512000		
CombiMaster 12V/3000W-160A 120V	35513000	17.6 × 11.2 × 6.0	20 [9]
CombiMaster 24V/2000W-60A 120V	35522000	[448 × 284 × 153]	
CombiMaster 24V/3000W-70A 120V	35523000		
CombiMaster 12V/3500W-200A 120V	35513500		
CombiMaster 24V/3500W-100A 120V	35523500	22.4 × 14.1 × 6.7	37 [17]
CombiMaster 24V/4500W-120A-HT 120V	35524500	[568 × 359 × 170]	
CombiMaster 48V/5000W-70A-HT 120V	35545000		

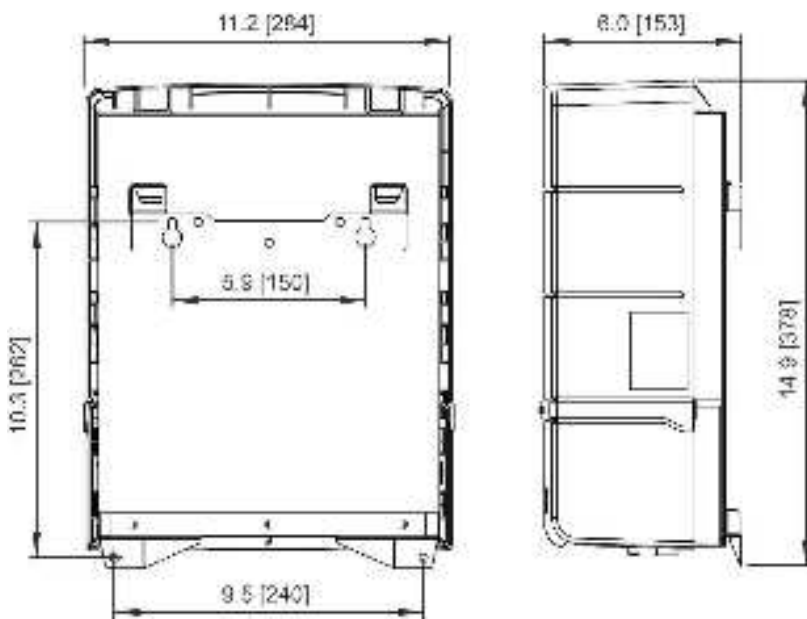

Figure 25. Dimensions in inches [mm] of model 1500W

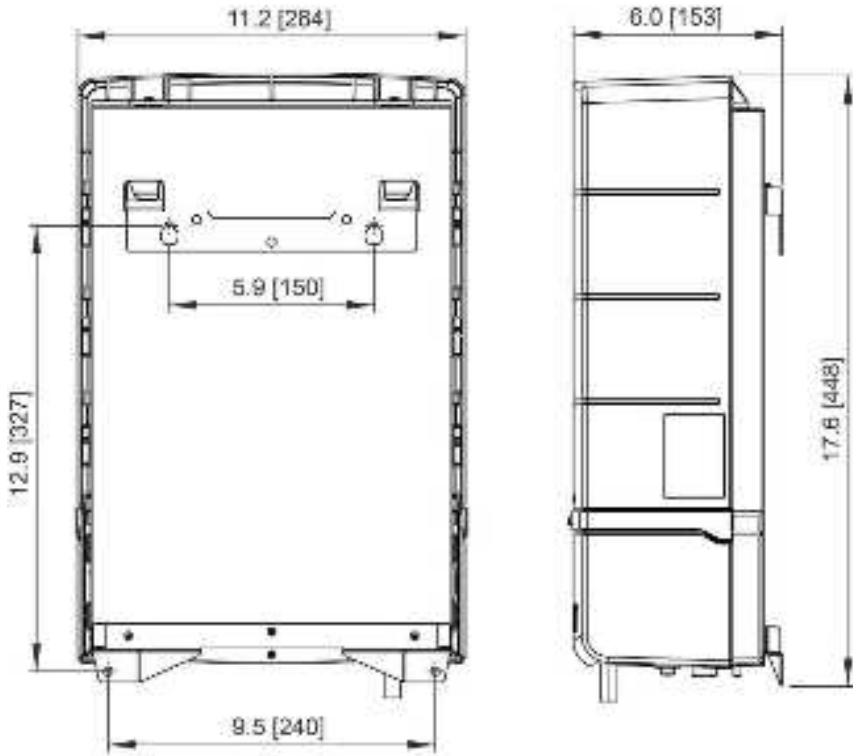
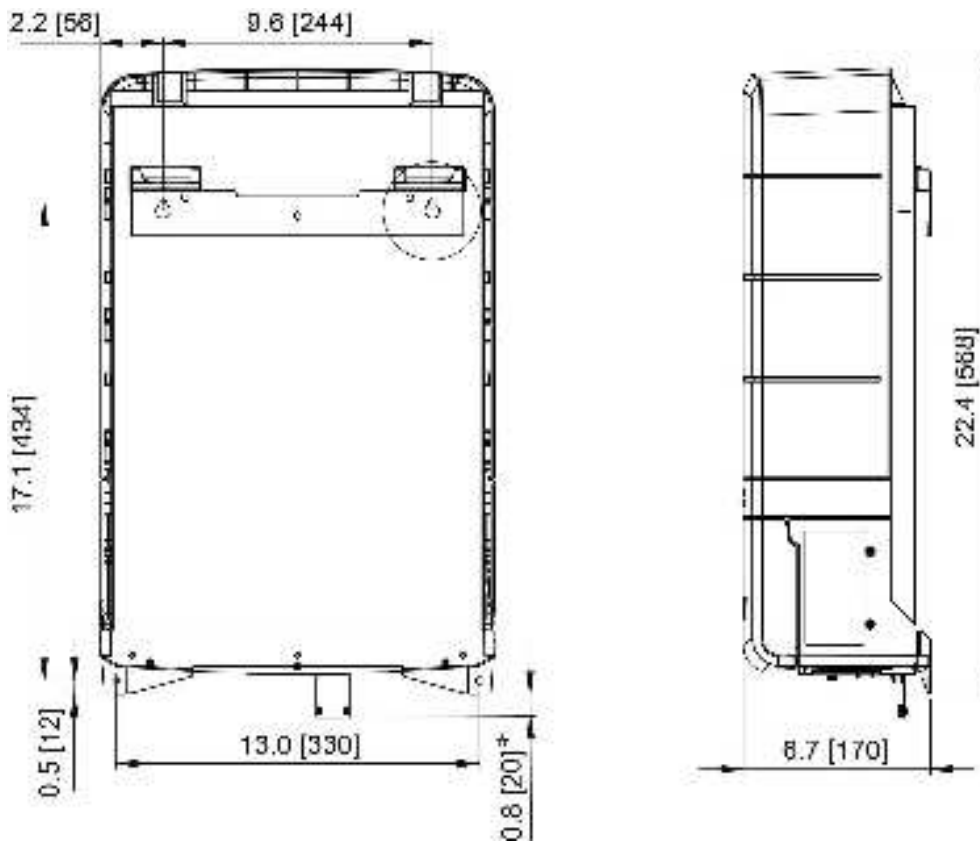

Figure 26. Dimensions in inches [mm] of models 2000W, 3000W



* strain relief for parallel stacking

Figure 27. Dimensions in inches [mm] of models 3500W, 4500W, 5000W



Europe, Middle East & Africa

Technical Support

T: +31 (0) 20 34 22 100

E: ts.emea@navicogroup.com

Location & Shipping

Navico Group EMEA

Snijdersbergweg 93

1105 AN Amsterdam

The Netherlands

Americas & Caribbean

Technical Support

T: +1 262 293 0600 / 800 307 6702

E: tech.mastervolt@navicogroup.com

Location & Shipping

Navico Group US

N85 W12545 Westbrook Crossing

Menomonee Falls, WI 53051

United States

Asia Pacific

Technical Support

T: +64 9 415 7261

E: technical.apac@navicogroup.com

Location & Shipping

Navico Group APAC

12 Rothwell Avenue

Rosedale, Auckland 0632

New Zealand

Document version: 10000015714/19 (August 25)

Copyright ©2025 Navico Group EMEA B.V. All rights reserved.