



**SMARTHEART**  
**Heart Rate Monitor**  
**Model: SE190**  
**USER MANUAL**

**CONTENTS**

**Introduction** .....2  
**Key Features** .....2  
 Watch .....2  
 LCD Display .....3  
**Getting Started** .....4  
 Unpacking the Watch .....4  
 Batteries .....4  
 Wearing the Chest Belt and Watch .....5  
 Transmission Signal .....6  
**Switching Between Main Modes** .....7  
**Clock Mode** .....7  
 Setting the Clock .....7  
**Clock Display Mode** .....8  
 2<sup>nd</sup> Time Zone Mode .....8  
**Alarm Mode** .....8  
 Setting the Alarm .....8  
 Activating / Deactivating the Alarm .....8  
 Turning the Alarm Sound off .....8

**User Mode** .....9  
 Activity Level .....9  
**About the Fitness Index** .....10  
 FitnessIndex.....10  
 View Fitness Index .....10  
**About the Smart Training Program (Timer Mode)**..10  
 Target Activity Levels .....11  
 Calculating Maximum / Lower / Upper Heart Rate Limit .11  
 Using the Smart Training Program .....12  
 View Data While Smart Training Program is Running .13  
 View Smart Training Program Records .....13  
**Heart Rate Alert** .....13  
**Stopwatch Mode (Chrono)** .....13  
 View Data While Stopwatch is Running .....14  
 View Stopwatch Records .....14  
**Training Information** .....15  
 How the Heart Rate Monitor Helps You .....15  
 Training Tips .....15  
**Specifications** .....16  
**Warnings** .....16  
 Aquatic and Outdoor Activities .....17  
 Tips for Keeping Your Watch Fit .....18  
**About Oregon Scientific** .....18  
**EU-Declaration of Conformity** .....18

## INTRODUCTION

Thank you for selecting the Oregon Scientific™ Heart Rate Monitor (SE190) as your sports fitness product of your choice.

This precision device includes the following features:

- Heart rate monitor with cordless transmission between watch and chest belt.
- Heart rate monitoring system when you go above or below your upper and lower heart rate limit.
- Visual or sound alert for heart rate thresholds during training.
- Memory stores heart rate figures during exercise.
- Smart Training Program enables you to complete exercise cycles effectively.
- Calorie consumption during and after exercise.
- Exercise profile - to calculate your personal heart rate limit for training.
- User profile - to calculate your fitness index.
- Stopwatch.
- Clock, calendar and alarm functions.
- Dual time zone.
- Chest belt included.
- Watch - up to 30 meters water resistant.
- Chest belt - splash-proof.

**IMPORTANT** The use of the SE190 watch is for sport purposes only and is not meant to replace any medical advice.

This manual contains important safety and care information, and provides step-by-step instructions for using this product. Read the manual thoroughly, and keep it in a safe place in case you need to later refer to it.

## KEY FEATURES

### WATCH

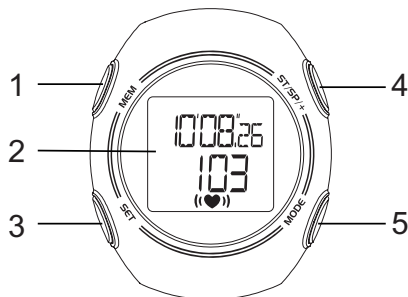



1. **MEM**: Display training records
2. LCD display
3. **SET**: Hold to enter the setting mode or go to the next setting item; or displays the calories burned in training
4. **ST / SP / +**: Monitors the training program and the stopwatch or changes a value in setting mode
5. **MODE**: Changes the operation mode

### LCD DISPLAY

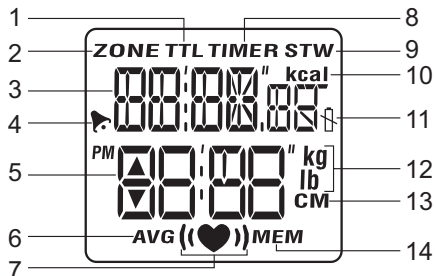

1. **TTL**: Total time
2. **ZONE**: 2<sup>nd</sup> time zone
3. **Small display**: Shows date / month / day of week / timer / stopwatch / sub-menu items
4. : Daily alarm
5. **Large display**: Shows current time / alarm time / zone time / menu items / heart rate
6. **AVG**: Average heart rate display
7. : Heart rate icon; : Heart rate target zone visual alert is out of range
8. **TIMER**: Timer zone
9. **STW**: Stopwatch mode
10. **kcal**: Calorie consumption display
11. : Battery status
12. **kg / lb**: Weight unit
13. **CM**: Height unit in centimeters
14. **MEM**: Exercise memory

## GETTING STARTED

### UNPACKING THE WATCH

When you unpack your SmartHeart SE190 Heart Rate Monitor, make sure to keep all the packing materials in a safe place, in case you need to later transport or return the product for servicing.

In this box, you will find:

- Heart rate monitor watch
- Chest belt
- 2 x CR2032 lithium batteries

**NOTE** Do not dispose this product as unsorted municipal waste. Collection of such waste separately for special treatment is necessary.

### BATTERIES

The unit uses a CR2032 lithium battery for the receiver watch and a CR2032 for the heart rate chest belt. Both are included with the units. When the battery of the receiver watch is running low,  will light up.

To replace the watch battery:

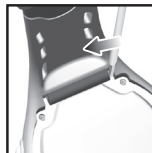

1. Turn the watch over so that you are looking at the back plate.
2. Disconnect the watchstrap as shown.

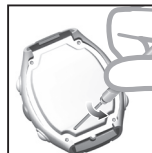

3. Using a small screwdriver remove the four screws that hold the back plate into position.
4. Remove the back plate and set it aside.

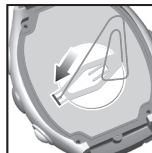

5. Using a thin blunt instrument, hook the release catch and lift the clip.
6. Remove the old battery.

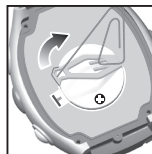

7. Slide the new battery into the compartment with the + side upwards.
8. Replace the battery clip.
9. Replace the back plate and screws.



To replace the chest belt battery:

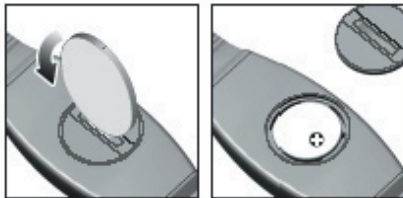

1. Locate the battery compartment on the back of the chest belt.
2. Using a coin, twist the compartment lid counter-clockwise until it clicks out of place and remove.
3. Remove the old battery.
4. Insert the new battery with the + side upwards.
5. Replace the battery compartment lid by twisting it clockwise until it is firmly in place.

#### IMPORTANT

- Non-rechargeable and rechargeable batteries must be disposed of properly. For this purpose, special containers are provided for non-rechargeable and rechargeable battery disposal at communal collection centers.
- Batteries are extremely dangerous when swallowed! Therefore, keep batteries away from infants. If a battery has been swallowed seek immediate

medical advice.

- The batteries supplied must not be recharged, reactivated by any other means, dismantled, put into fire or short-circuited.

#### WEARING THE CHEST BELT AND WATCH

##### CHEST BELT

The heart rate chest belt is used to count your heartbeat and transmit the data to the watch. To wear the chest belt:

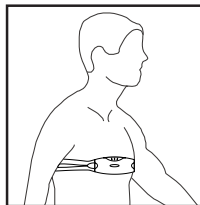

1. Wet the conductive pads on the underside of the chest belt with a few drops of water or a conductive gel to ensure solid contact.
2. Strap the heart rate chest belt across your chest. To ensure an accurate heart rate signal, adjust the strap until the belt sits snugly below your pectoral muscles.

##### TIPS

- The position of the chest belt affects its performance. Move the chest belt along the strap so that it falls above your heart. Avoid areas with dense chest hair.
- In dry, cold climates, it may take several minutes for the chest belt to function steadily. This is normal and should improve with several minutes of exercise.

**NOTE** If the watch is kept idle without receiving a heart rate signal for 5 minutes, the heart rate receiver will turn off.

## WATCH

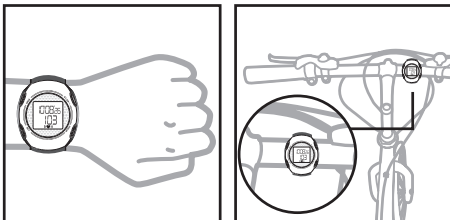

You can wear the receiver watch on your wrist or strap it to a bike or exercise machine. Please note that you may have to place some foam between the watch and the bike handlebar to get a secure fit.

## TRANSMISSION SIGNAL

The heart rate chest belt and watch have a maximum transmission range of about 62.5 centimeters (25 inches). ♥ flashes when the watch is receiving a signal from the chest belt.

In the event that you experience a weak signal (i.e.,

the watch heart rate monitor will only show "0") or your signal is disrupted by interference in the environment, follow the instructions below to identify and resolve the situation:

- Shorten the distance between the heart rate chest belt and watch.
- Re-adjust the position of the heart rate chest belt.
- Check the conductive pads are moist enough to ensure solid contact.
- Check the batteries. Low or exhausted batteries may adversely affect transmission range.

**WARNING** Signal interference may cause an incorrect or unstable heart reading to display. Signal interference in the environment can be due to electromagnetic disturbances. These may occur near high voltage power lines, traffic lights, overhead lines of electric railways, electric bus lines or trams, televisions, car motors, bike computers, some motor driven exercise equipment, cellular phones or when you walk through electric security gates.

**NOTE** If the watch is kept idle without receiving a heart rate signal for 5 minutes, the Heart Rate receiver will turn off.

## SWITCHING BETWEEN MAIN MODES

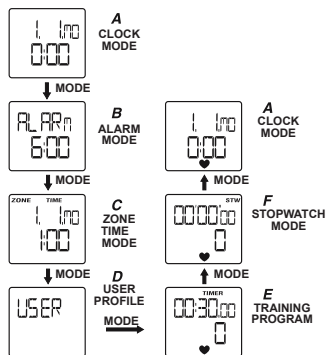

There are 6 main operating modes for clock time, alarm time, second zone time, user profile, training program and stopwatch. Press **MODE** to switch between modes.

**NOTE** You cannot run the Timer or Stopwatch at the same time. If you have been using the Timer and do not reset it after use, you will not be able to view the main mode stopwatch screen and vice-versa.

The modes are described in the sections that follow.

## CLOCK MODE

### SETTING THE CLOCK

The real-time clock is the default display for the watch. To set the real-time clock:

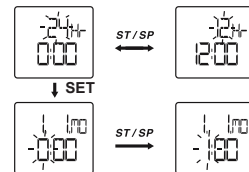

1. Press **MODE** to switch to Clock Mode.
2. Press and hold **SET** until the first setting flashes.
3. Press **ST / SP / +** to change the setting. Hold to speed through the options. Press **SET** to confirm and move on to the next setting.
4. Repeat step 3 to change other settings for this mode.
5. The setting sequence is 12 / 24 hour clock format, hour, minute, second, date format, year, month, date and 2nd time zone.

6. Press **MODE** to exit the setting mode at any time.

**NOTE** The clock is programmed with a 50-year auto-calendar, which means you do not need to reset the days of the week and dates each month.

## CLOCK DISPLAY MODE

You can change the 2<sup>nd</sup> time zone when you are in the Clock Display Mode.

### 2<sup>nd</sup> TIME ZONE MODE

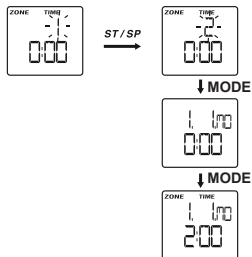

The second time zone mode is useful for keeping track of the time in another time zone. The time zone is set using the same procedure as the real-time clock.

Press **MODE** to enter the 2nd time zone.

## ALARM MODE

### SETTING THE ALARM

To set the alarm:



1. Press **MODE** to switch to Alarm Mode.
2. Press and hold **SET** until the first setting flashes.
3. Press **ST / SP / +** to change the

setting. Hold to speed through the options. Press **SET** to confirm the setting and move on to the next one.

4. Repeat step 3 to change other settings for this mode.
5. The setting sequence is hour and minute.

### ACTIVATING / DEACTIVATING THE ALARM

1. Press **MODE** to navigate to Alarm Mode.
2. Press **SET** to activate or deactivate the alarm.
  - ▶ appears when the alarm is activated and sounds at the set time every day.

### TURNING THE ALARM SOUND OFF

Press any key to turn the alarm sound off for the day. The alarm clock is still active and will sound again the following day, until the alarm function has been deactivated.





## USER MODE

To access the full benefits of the watch, set up your user profile before you exercise. This will automatically generate a fitness index. This calculation along with the calories consumed will help you track your progress over time.

To set the user profile:



1. Press **MODE** to switch to User Mode.
2. Press and hold **SET** until the first setting flashes.

3. Press **ST / SP / +** to change the setting. Hold to speed through the options. Press **SET** to confirm the setting and move on to the next one.
4. Repeat step 3 to change other settings for this mode.
5. The setting sequence is sex, age, unit for weight, weight, unit for height, height and activity level (0-2).
6. Press **MODE** to exit the setting mode at any time.

Once you complete your user profile, a fitness index will appear on the watch. Refer to the "About the Fitness Index" section for further information.

**NOTE** You must set up your user profile to use the calorie count features.

**NOTE** If the sex or age has been set, the Maximum Heart Rate (MHR) will be updated, as will the upper and lower limit for the target zone for both Timer and Stopwatch Mode.

## ACTIVITY LEVEL

The activity level is based on your own self-assessment of the amount of exercise you regularly perform.

ACTIVITY LEVEL	DESCRIPTION
0	Low – You do not usually participate in programmed recreation sports or exercise.
1	Medium – You are engaged in modest physical activity (such as golfing, horseback riding, table tennis, calisthenics, bowling, weight lifting or gymnastics) 2-3 times a week, totaling 1 hour per week.
2	High – You actively and regularly participate in heavy physical exercise (such as running, jogging, swimming, cycling, or skipping rope) or engage in vigorous aerobic exercise (such as tennis, basketball or handball).

## ABOUT THE FITNESS INDEX

### FITNESS INDEX

Your watch generates a fitness index based on your aerobic fitness. This index is dependent and limited by the body's ability to deliver oxygen to the working muscles in training. It is often measured by maximum oxygen uptake (VO2 Max), which is defined as the highest amount of oxygen that can be utilized when exercising at an increasingly demanding level. The lungs, heart, blood, circulatory system, and working muscles are all factors in determined VO2 Max. The unit of VO2 Max is ml/kg min.

The higher the index, the fitter you are. See the tables below for a rough guide to what your fitness index means:

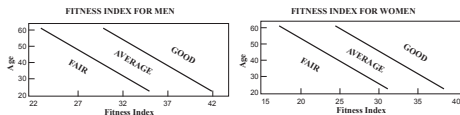

### VIEW FITNESS INDEX



Your fitness index will be displayed just after the user profile is entered. Or you can display your fitness index by pressing **MEM** while the user profile mode is displayed (all data in the user profile should be entered first).

### ABOUT THE SMART TRAINING PROGRAM (TIMER MODE)

The Smart Training Program enables you to complete exercise cycles effectively. It will guide you from a warm up to the end of your exercise program. In addition to monitoring your heart rate and alerting you whenever you fall out of the range for the selected upper / lower heart rate limit, the program allows you to check the calories consumed.

Different activities exercise the body in different ways and help you to achieve a variety of fitness goals. To accommodate this the Smart Training Program can be set to suit different exercise activities. For example, if you are running, your settings are likely to differ from those you would use when undertaking a weight training activity.

Also, the time you require to complete an exercise will vary. That is why you can change the exercise countdown time to suit you.

**NOTE** Once you have set your user profile, your lower and upper heart rate limit will be set automatically. However, you can manually change your upper and lower heart rate limit if the automatic setting does not suit you. If you change the target activity level your upper / lower and maximum heart rate will automatically be updated.

#### TARGET ACTIVITY LEVELS

	TARGET ACTIVITY	%MHR*	DESCRIPTION
0	Health Maintenance	65-78%	This is the lowest target activity level. It is good for beginners and those who want to strengthen their cardiovascular systems.
1	Aerobic Exercise	65%-85%	Increases strength and endurance. It works within the body's oxygen intake capability, burns more calories, and can be maintained for a long period of time.

2	Anaerobic Exercise	78-90%	Generates speed and power. It works at or above the body's oxygen intake capability, builds muscle, and cannot be maintained for a long period of time.
---	--------------------	--------	---

\* MHR = Maximum Heart Rate

#### CALCULATING MAXIMUM / LOWER / UPPER HEART RATE LIMIT

Before you begin any exercise program and to achieve maximum health benefits from your workout, it is important to know your:

- Maximum heart rate (MHR)
- Lower heart rate limit
- Upper heart rate limit

The unit is equipped with a training program to determine your own MHR, from which the upper and lower limits are set automatically throughout the training process. Or, you can manually calculate and set your own upper and lower limit using the following as a reference guide:

<b>MHR</b>	MHR = 220 - age
<b>LOWER LIMIT</b>	MHR x lower target activity %. E. g. Target activity is 0 Lower Limit = MHR x 65%
<b>UPPER LIMIT</b>	MHR x upper target activity % E. g. Target activity is 0 Upper Limit = MHR x 78%

### USING THE SMART TRAINING PROGRAM

Once you have entered all the settings for your user profile, you need to set the target activity and exercise time for your training in order for the Smart Training Program to effectively monitor your exercise performance.

**NOTE** The calorie counter will not be available during training if the settings in your user profile are not complete.

**NOTE** You cannot use the Smart Training Program if you are running the stopwatch.

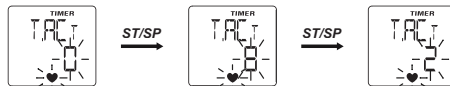

1. Press **MODE** to switch to Timer Mode.
2. Press and hold **SET** until the first setting flashes.
3. Press **ST / SP / +** to change the setting. Hold to speed through the options. Press **SET** to confirm the setting and move on to the next one.
4. Repeat step 3 to change other settings for this mode.
5. The setting sequence is target activity, lower and upper heart rate limit, alert ON / OFF, timer hour, timer minute.
6. Press **MODE** to exit the setting mode at any time.

TASK	INSTRUCTION
Start / stop timer	Press <b>ST / SP / +</b> .
Stop / reset timer	Press and hold <b>ST / SP / +</b> . Once you stop any countdown timer (training program) you cannot resume the timer (training program). It can only be restarted for another training session.

**NOTE** "TIMER" appears when you are in the timer display, or when timer is running in the background.

**NOTE** ( ( ) ) will flash when you exceed your upper or lower heart rate limit.

#### VIEW DATA WHILE SMART TRAINING PROGRAM IS RUNNING

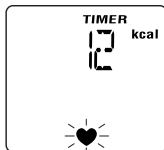

During the training period, press **SET** to view the calories burned.

**NOTE** You cannot use the stopwatch if you are running the Smart Training Program. The training program and stopwatch function can only be operated separately.

#### VIEW SMART TRAINING PROGRAM RECORDS

When the Smart Training Program has been paused or completed, press **MEM** to view the following records:

THE LENGTH OF EXERCISE TIME WITHIN THE TRAINING ZONE	TOTAL EXERCISING TIME AND AVERAGE HEART RATE	CALORIES BURNED
A rectangular display showing "TIME" at the top, a digital timer "00:25:23", an up arrow on the left, and a heart icon with "MEM" below it.	A rectangular display showing "TTL TIME" at the top, a digital timer "00:35:00", a large digital number "96" in the center, and "AVG" with a heart icon and "MEM" below it.	A rectangular display showing a large digital number "23" in the center, "kcal" to its right, and a heart icon with "MEM" below it.

#### HEART RATE ALERT

When the heart rate alert is activated, a sound alert, and flashing heart rate reading and up or down arrow will appear on the display to show which heart rate limit you have surpassed.

#### STOPWATCH MODE (CHRONO)

The stopwatch watch function is particularly beneficial to use when you are unsure how long your activity will take, or when you want to measure the time it takes to complete a task and your performance over that time.

To get the most out of your stopwatch function complete your user profile. If you have not completed the user profile you will be unable to use the calorie counter function.

To set the stopwatch:

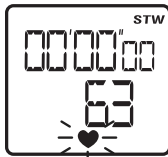

1. Press **MODE** to switch to Stopwatch Mode.
2. Press and hold **SET** until the first setting flashes.
3. Press **ST / SP / +** to change the setting. Hold to speed through the options. Press **SET** to confirm the setting and move on to the next one.
4. Repeat step 3 to change other settings for this mode.
5. The setting sequence is target activity, lower and upper heart rate limit, alert ON / OFF.
6. Press **MODE** to exit the setting mode at any time.

Press **MODE** to navigate to Stopwatch Mode. You can now perform the following functions:

TASK	INSTRUCTION
Start stopwatch	Press <b>ST / SP / +</b>
Pause / resume stopwatch	Press <b>ST / SP / +</b>
Stop / clear stopwatch	Press and hold <b>ST / SP / +</b>

**NOTE** The stopwatch begins measurement in min:sec:1/100 sec. After 59 minutes pass, the display will change to hrs:min:sec.

**NOTE** You cannot use the Smart Training Program if you are running the stopwatch.

**NOTE** ( ) will flash when you exceed your upper or lower heart rate limit.

#### VIEW DATA WHILE STOPWATCH IS RUNNING

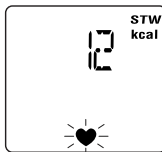

When the stopwatch is running press **SET** to view the calories burned.

**NOTE** With the exception of the Smart Training Program, the stopwatch will continue to operate in the background along with other functions. "STW" will flash to indicate the stopwatch is still active.

#### VIEW STOPWATCH RECORDS

When the stopwatch training has been paused or completed, press **MEM** to view the following records:

THE LENGTH OF EXERCISE TIME WITHIN THE TRAINING ZONE	TOTAL EXERCISING TIME AND AVERAGE HEART RATE	CALORIES BURNED

## TRAINING INFORMATION

### HOW THE HEART RATE MONITOR HELPS YOU

A heart rate monitor is the most important tool in cardiovascular health and an ideal training partner. It enables you to see and monitor results. This helps you assess your past performance, maximize your work out and adapt your future exercise program to achieve your desired goals in a safer and more effective way. When you exercise, the chest belt picks up your heartbeat and sends it to the watch. Now you can view your heart rate and start monitoring your performance based on your heart rate readings. As you get fitter, your heart will need to do less work and the speed of your heart rate will decrease. The reason for this is as follows:

- Your heart pumps blood to your lungs to obtain oxygen. Then, the oxygen rich blood will travel to your muscles. The oxygen is used as fuel and the blood leaves the muscles and returns to the lungs to begin the process again. As you get fit, your heart is able to pump more blood with every beat. As a result, your heart doesn't have to beat as often to get the necessary oxygen to your muscles.

### TRAINING TIPS

To gain the maximum benefit from your training program and ensure that you exercise safely, observe the following guidelines:

- Start with a well-defined training goal, such as to lose weight, keep fit, improve health or compete in a sporting event.
- Select a training activity you enjoy, and vary your training activities to exercise different muscle groups.
- Start slowly, and then gradually step up your work out as you become fitter. Exercise regularly. To maintain a healthy cardio-vascular system, 20-30 minutes three times a week is recommended.
- Always allow at least five minutes before and after exercising for warm-up and cool-down.
- The health maintenance zone has the lowest training intensity. It is good for beginners and those who want to strengthen their cardiovascular systems.
- The aerobic exercise zone increases strength and endurance. It works within the body's oxygen intake capability, burns more calories and can last longer.
- The anaerobic exercise zone generates speed and power. It works at or above the body's oxygen intake capability, builds more muscle and cannot be maintained for a long time.
- Measure your pulse after training. Then repeat the procedure again after three minutes. If it does not return to its normal resting rate, you may have trained too hard.
- Always check with your doctor before starting a vigorous training program.

## SPECIFICATIONS

TYPE	DESCRIPTION
<b>CLOCK</b>	
Time format	12 hr / 24 hr
Date format	DD / MM or MM / DD and days of the week
Year format	2001-2050 (auto-calendar)
Zone time	(+) 23 to (-) 23 hours
Stopwatch	00:00:00-99:59:59 (hrs:min:sec)
Alarm	Daily alarm, heart rate zone alert alarm
<b>STOPWATCH</b>	
Stopwatch	99:59:59 (HH:MM:SS)
Risolution	1/100 sec
<b>SMART TRAINING PROGRAM</b>	
Exercise timer	00:05 to 99:59 (default 00:30) (hr:min)
<b>PERFORMANCE TRACKING</b>	
Heart rate (HR) alarm	Sound / visual
HR measuring range	30 to 240 bpm (beats per minute)
Lower HR settable range	30 to 240 bpm (beats per minute)
Upper HR settable range	80-240 bpm (beats per minute)
Calories	0 to 9,999 kcal

## TRANSMISSION

Range	62.5 cm (25 inches) – may decrease with low battery
-------	---

## WATER RESISTANT

Watch	Not actuating keys to 30 meters (approx. 100 feet)
Chest belt	Splash-proof

## POWER

Watch	1 x CR2032 3V lithium battery
Chest belt	1 x CR2032 3V lithium battery

## OPERATING ENVIRONMENT

Operation temperature	5°C to 40°C (41°F to 104°F)
Storage temperature	-10°C to 70°C (14°F to 158°F)

## WARNINGS

To ensure you use your product correctly and safely, read these warnings and the entire user manual before using the product. The warnings given here provide important safety information and should be observed at all times.

- The product is a precision instrument. Never attempt to take this device apart. Contact the retailer or our customer service department if the product requires servicing.





- Do not touch the exposed electronic circuitry, as there is a danger of electric shock.
- Take precautions when handling all battery types.
- Remove the batteries before storing the product for a long period of time.
- Do not use the chest belt in aircrafts or hospitals. The use of radio frequency products can cause malfunctions in the control devices of other equipment.
- Do not bend or stretch the transmitter part of the chest belt.
- Check all major functions if the device has not been used for a long time. Maintain regular internal testing and cleaning of your device.
- Do not dispose this product as unsorted municipal waste. Collection of such waste separately for special treatment is necessary.
- Clean the watch and chest belt thoroughly after each training session. Never store the products when wet.
- Use a soft, slightly moistened cloth to clean the product. Do not use abrasive or corrosive cleaning agents, as these may scratch the plastic parts and corrode the electronic circuit.
- Avoid pressing the keys with wet fingers, under water, or in heavy rain, as this may allow water to gain entry into the electrical circuitry.

- Do not subject the product to excessive force, shock, dust, temperature changes, or humidity. Never expose the product to direct sunlight for extended periods. Such treatment may result in malfunction, a shorter electronic life span, damaged batteries, or distorted parts.
- Do not tamper with the internal components. Doing so will terminate the product warranty and may cause damage. The main unit contains no user-serviceable parts.
- Do not scratch hard objects against the LCD display as this may cause damage.
- Remove the batteries whenever you are planning to store the product for a long period of time.
- When replacing batteries, use new batteries as specified in this user manual. Do not mix new and old batteries, or batteries of different types.

#### AQUATIC AND OUTDOOR ACTIVITIES

The watch is water-resistant up to 30 meters. The chest belt is splash-proof and should not be worn for underwater activities.

When using the watch for aquatic or outdoor sports activities, observe the following guidelines:

- Do not press the keys under water or with wet fingers. All settings should be set before entering water.

- Rinse with water and mild soap after use.
- Do not use in hot water.

#### TIPS FOR KEEPING YOUR WATCH FIT

Keep your watch water resistant! Avoid chemicals (gasoline, chlorine, perfumes, alcohol, hair sprays, etc.). Rinse after use. Reduce exposure to heat. Have your watch serviced by an approved service center annually.

#### ABOUT OREGON SCIENTIFIC

Visit our website ([www.oregonscientific.com](http://www.oregonscientific.com)) to learn more about Oregon Scientific products such as digital cameras; MP3 players; children's electronic learning products and games; projection clocks; health and fitness gear; weather stations; and digital and conference phones.

The website also includes contact information for our Customer Care department in case you need to reach us, as well as frequently asked questions and customer downloads. We hope you will find all the information you need on our website, however if you're in the US and would like to contact the Oregon Scientific Customer Care department directly, please visit:

[www2.oregonscientific.com/service/default.asp](http://www2.oregonscientific.com/service/default.asp)

OR

Call 1-800-853-8883.

For international inquiries, please visit:

[www2.oregonscientific.com/about/international.asp](http://www2.oregonscientific.com/about/international.asp)

#### EU-DECLARATION OF CONFORMITY

Hereby, Oregon Scientific, declares that this SmartHeart Heart Rate Monitor (SE190) is in compliance with EMC directive 89/336/CE. A copy of the signed and dated Declaration of Conformity is available on request via our Oregon Scientific Customer Service.

