

GUIDELINES TO ENSURE PERFORMANCE

- If exposed to a liquid, wipe off the liquid and make sure that the area between the slider and the beam has completely dried-out before re-use
- This product complies with the EMC Directive. Note that in environments where electromagnetic interference exceeds EMC requirements defined in this directive, appropriate countermeasures are required to prevent interference with the measurement
- The optimal operating temperatures of the caliper is in the range 0-40°C (32-104°F), do not exceed this range by exposing the caliper to direct sunlight or below 0°C/32°F
- Do not attempt to disassemble the caliper
- Pay attention to protection against drops 

! NOTICE

- Do not disassemble, short-circuit, charge, expose to sunlight or heat the battery. Otherwise the battery content may leak, come in contact with the eyes, or cause battery heating or explosion
- Never directly touch leaked batteries
- If a battery is swallowed, immediately consult a doctor
- The outside and inside measuring jaws of this caliper have sharp edges. Handle it with great care to avoid injury

DISPOSAL GUIDE

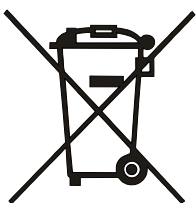

Disposal of used electrical and electronic equipment (applicable in the European Union and other European countries with separate collection systems)

- This symbol on the product or on its packing is based on WEEE directive (Directive on Waste Electric and Electronic Equipment), which is a regulation in EU member countries, and this symbol indicates that this product shall not be treated as household waste
- To reduce the environmental impact and minimize the volume of landfills, please cooperate in reuse and recycle

- For how to dispose the product, please consult local regulations and instructions
- Recycle batteries at your local recycling facility

TROUBLESHOOTING

Problem	Solution
Digits do not display correctly	Reset the caliper: turn off the caliper for 30s then turn it on.
Digits flashing	Battery low, please connect cable and do not use till it fully charged.

STRUCTURES

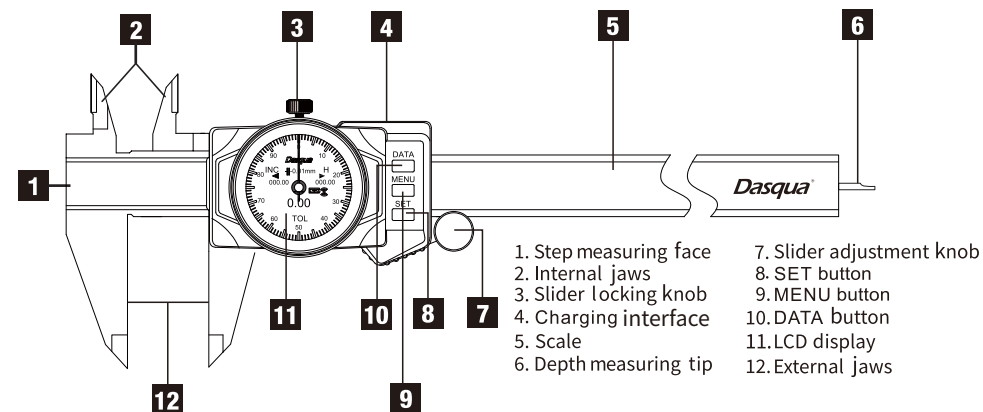

SPECIFICATION

- Measuring Range: 0-150mm/0-6", 0-200mm/0-8", 0-300mm/0-12"
- Resolution: 0.01mm/0.0005" /1/128"
- Data output: Bluetooth data output
- Power: Rechargeable lithium battery. Magnetic suction charging interface, DC5V/1000mA
- Battery Life: Battery life: approximately 500 complete charging cycles
- Low voltage alarm: display the "  " symbol
- Protection Level: IP67
 - 6- Completely prevent foreign objects from entering and completely prevent dust from entering
 - 7- Under the specified pressure, there should be no abnormality when penetrating into the water for a short time
- Operating Temperature: 0-40°C(32-104°F)
- Storage Temperature: -10-60°C(14-140°F)
- Maximum Humidity: unlimited
- CE Certificate: In conformity with EN 61326-1:2013
- RoHS Certificate: RoHS directive (EU) 2015/863 amending Annex II to Directive 2011/65/EU
- The automatic hibernation time is adjustable from 15s to 10 min. Within 8 hours, the caliper can still turn on by pulling. Beyond 8 hours, the system will be completely cut off and user needs to press "SET" button to turn on the caliper.

OPERATION INSTRUCTIONS

• DATA Button

1. Long press and hold the "DATA" key, and the screen will display "📶". At this time, the corresponding Bluetooth device should be ready for pairing
2. Short press the "DATA" key to send data

• MENU Button

Press "MENU" briefly to enter the menu:

1. Measurement unit setting: Short press the "SET" key, unit: 0.01mm → unit: 0.0005inch → unit: 1/128inch cycle selection
2. Screen brightness setting: Short press the "SET" key, select Bright → Night → Normal cycle
3. Screen sleep time interval: Short press the "SET" key, 15S → 30S → 1MIN → 2MIN → 5MIN → 10MIN cycle selection
4. Enabling/disabling the. "INC" function: Short press the "SET" key, INC: OFF → INC: ON (note: not supported for simultaneous activation with HOLD and TOL)
5. HOLD function enable/disable: Short press the "SET" key, HOLD: OFF → HOLD: ON (note: not supported for simultaneous activation with INC and TOL)
6. TOL function enable/disable: Short press the "SET" key, TOL : OFF → TOL : ON (note: not supported to be enabled simultaneously with INC and HOLD)
7. Display panel style selection: interface: 0 (pointer) → interface: 1 (digital)

After selecting the function, press and hold the "MENU" key, and the system will save the settings and return to the measurement mode.

• SET Button

Short press to set "0"; Press and hold for at least 3 seconds after turning on the computer to display "Shutting down" and then turn it off ;

Within 8 hours, the caliper can still turn on by pulling. Beyond 8 hours, the system will be completely cut off and user needs to press "SET" button to turn on the caliper.

When the INC function is activated, short press to enter the INC mode and set it to "0" at the current position. Short press again to return to the normal measurement mode

When the HOLD function is activated, short press to lock/unlock the displayed number (including pointer)

When the TOL function is activated, briefly press to enter/exit the TOL measurement mode;

1. After entering the TOL user interface, long press and hold the "MENU" key to activate the tolerance limit number. The activated digits are highlighted in red. At this time, every short press of the "MENU" key, the highlighted digits in red cycle through 0 → 9 → 0;
2. Press the "MENU" key twice in a row, and the red highlight will move to the next digit. After completing all digital settings, press and hold the "MENU" key again to exit the TOL limit setting. The measurement data within the tolerance limit range is highlighted in green

• Note:

1. The system automatically determines the upper and lower tolerance values based on the size of the set values
2. The system does not force the lower tolerance limit value to be located on the left side of the screen display, nor does it force the upper tolerance limit value to be located on the right side of the screen display
Location; In principle, we suggest setting a lower limit value on the left side of the screen display and an upper limit value on the right side of the screen display, which is more suitable for combined viewing habits
3. In the inch score measurement mode, the upper and lower tolerance values can only be presented in decimal form

DISPLAY DIAGRAM

• Start/shutdown screen



Long press and hold the SET key to operate

• Screen Sleep Interval

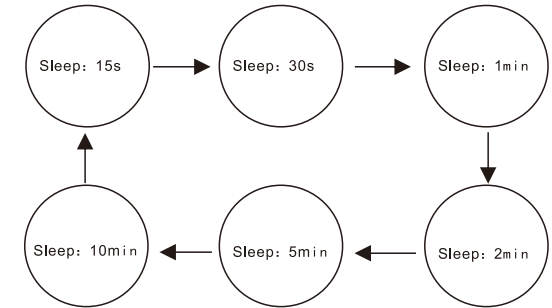

Short press the SET key to switch

• Switching measurement units

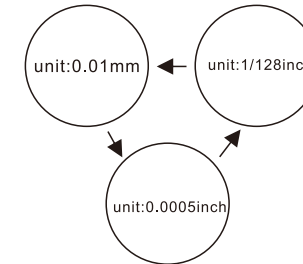

Short press the SET key to switch

• Screen brightness setting

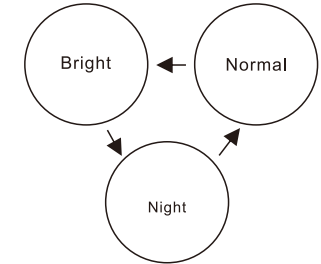

Short press the SET key to switch

• INC function activate/close

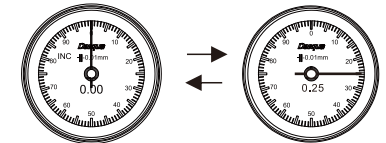
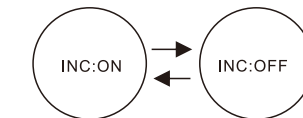

• HOLD function activate/close

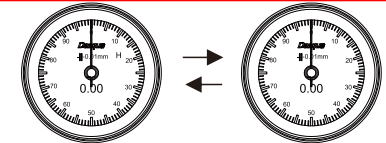
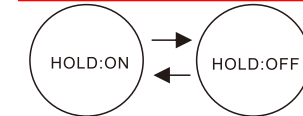

• TOL function activate/close

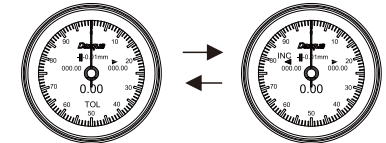
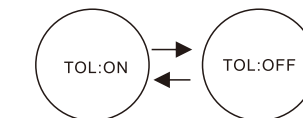

Short press the SET key to switch

After returning to the user interface, Short press the SET key to operate