

Grant Aerona

Smart Heat Pump System Controller

Installation & Operation Instructions



IMPORTANT NOTE FOR INSTALLERS

These instructions are intended to guide installers on the installation and commissioning of the Grant Aerona Smart Controller intended for use with Grant Aerona air source heat pumps. After installing the unit, leave these instructions with the user.

SPECIAL TEXT FORMATS

The following special text formats are used in these instructions for the purposes listed below:

! WARNING !

Warning of possible human injury as a consequence of not following this instruction.

! CAUTION !

Caution concerning likely damage to equipment or tools as a consequence of not following this instruction.

! NOTE !

Used for emphasis or information not directly concerned with the surrounding text but of importance to the reader.

PRODUCT CODES AND SERIAL NUMBERS COVERED

The serial numbers used on Grant Aerona Smart Controller consist of a ten digit numerical code.

For example:

1006986828

This serial number can be found on a label attached to the wiring centre.

! CAUTION !

Electric device under voltage!

Before any action related to the power supply (cables connection, device installation etc.) Check to ensure the controller is not connected to the mains power. Installation should be done by a person with appropriate electrical qualifications. Improper cable connection could result in controller damage. The controller must not be installed in steamy conditions or exposed to water, such as bath or shower room



GRANT ENGINEERING (UK) LIMITED

Frankland Road, Blagrove Industrial Estate, Swindon, SN5 8YU

Tel: +44 (0)1380 736920 Fax: +44 (0)1380 736991

Email: info@grantuk.com www.grantuk.com

This manual is accurate at the date of printing but will be superseded and should be disregarded if specifications and/or appearances are changed in the interests of continued product improvement. However, no responsibility of any kind for any injury, death, loss, damage or delay however caused resulting from the use of this manual can be accepted by Grant Engineering (UK) Limited, the author or others involved in its publication.

All goods sold are subject to our official Conditions of Sale, a copy of which may be obtained on application.

© Grant Engineering (UK) Limited. No part of this manual may be reproduced by any means without prior written consent.

Contents

1	INTRODUCTION	4	10	WI-FI HUB	35
1.1	General	4	10.1	General	35
1.2	Safety information	4	10.2	Connection to wiring centre	35
1.3	Information about documentation	4	10.3	Connection with internet	35
1.4	Storage of documentation	4	10.4	Econet24	36
1.5	Conditions of storage and transport	4	11	SERVICING	37
1.6	Product contents	4	11.1	Component replacement	37
1.7	Additional components	4	11.2	Accessories & spare parts	37
1.8	Customer Support Hub	4	12	EC DECLARATIONS OF CONFORMITY	38
2	TECHNICAL DATA	5	13	HEALTH AND SAFETY INFORMATION	39
2.1	Wiring centre	5	14	DISPOSAL AND RECYCLING	39
2.2	Touchscreen display	6	15	GUARANTEE	40
3	INSTALLATION	7	APPENDIX A - WIRED THERMOSTAT	42	
3.1	General	7	A.1	General	42
3.2	Regulations and Standards	7	A.2	Installation	42
3.3	Touchscreen display	7	A.3	Thermostat panel	42
3.4	Wiring centre	8	A.4	Pairing	43
3.5	Temperature sensors	8	A.5	Changing setpoint temperature	43
3.6	Connecting pumps	9	A.6	Hotel mode	43
3.7	Connecting 3-port mixing valves	9	A.7	Error codes	43
3.8	Connecting relays	9	APPENDIX B - WIRELESS THERMOSTAT AND RECEIVER	44	
3.9	Smart flow sensor	9	B.1	General	44
3.10	Room thermostat connection	9	B.2	Installing Wireless receiver	44
3.11	Connecting the Wi-fi Hub	9	B.3	Wireless thermostat	44
4	SYSTEM HYDRAULICS	10	B.4	Memory reset of the wireless receiver	45
4.1	Hydraulic Connections	10	B.5	Multiple Thermostat support	45
4.2	Installation Pack Summary	10	B.6	Thermostat Panel	45
4.3	Hydraulic controls	10	B.7	Hotel Mode	45
4.4	Hydraulic connections - Pack P	11	B.8	Alarms	45
4.5	Hydraulic connections - Pack Q	12	APPENDIX C - 3-PORT MIXER VALVE	46	
4.6	Hydraulic connections - Pack R	13	C.1	General	46
5	ELECTRICAL CONNECTIONS	14	C.2	Clockwise rotation	46
5.1	Connecting the wiring centre	14	C.3	ANTI-Clockwise rotation	47
5.2	Component connections	14	APPENDIX D - SMART IMMERSION RELAY	48	
5.3	Power supply failure	14	D.1	General	48
5.4	Wiring centre LAYOUT	15	D.2	Wiring	48
5.5	Electrical connections - Pack P	16	D.3	Smart Immersion functionality	48
5.6	Electrical connections - Pack Q	17	APPENDIX E - SMART FLOW SENSOR	49	
5.7	Electrical connections - Pack R	18	E.1	General	49
6	SYSTEM CONFIGURATION WITH TOUCHSCREEN DISPLAY	19	E.2	Installation	49
6.1	First switch-on	19	E.3	Electrical	49
6.2	System configuration Creator	19	E.4	Sensor configuration	49
6.3	Weather compensation	21	APPENDIX F - HOW TO VIDEOS	50	
6.4	Circuit control settings	22	F.1	Icons Overview	50
6.5	Common Settings	22	F.2	Setting up the controller	50
7	TOUCHSCREEN DISPLAY OPERATION AND SETTINGS	23	F.3	Setting the Circuit temperature	50
7.1	Touchscreen display	23	F.4	Setting the hot water temperature	50
7.2	Smart Controller operation	24	F.5	Setting the heating schedule	50
7.3	Circuit settings	24	F.6	Setting the Hot water schedule	50
7.4	Legionella protection	26	F.7	Adjusting the heating curve	50
7.5	Time schedules	26	F.8	Setting up Legionella protection	50
7.6	Heat pump schematic	27	NOTES	51	
7.7	System schematic	27			
7.8	Circuit control	28			
7.9	User settings menu	29			
7.10	Stored system settings	29			
8	SERVICE SETTINGS - INSTALLER	30			
8.1	Service Settings	31			
9	HEAT PUMP PARAMETERS INSTALLER	33			

1 Introduction

1.1 GENERAL

The Grant Aerona Smart Controller is intended for controlling a central heating and domestic hot water with a Grant Aerona heat pump. The controller may be used in domestic and light commercial applications.

1.2 SAFETY INFORMATION

Requirements concerning safety are listed in particular Sections of this instruction manual. Apart from these it is necessary to fulfil the following requirements:

- The controller should be installed by qualified installer only and in accordance with current Standards and Regulations.
- Before starting the installation, repairs or maintenance and during the execution of any connection works, it is necessary to switch off the mains power supply and make sure that no terminals and electrical wires are live.
- Even after turning off wiring centre terminals it can still be under a dangerous level of voltage.
- The controller can be utilised only in accordance with its intended use.
- Additional measures should be used in order to protect the central heating and DHW system against the results of controller failure or software errors. Particularly control measures which reduce DHW temperature in order to protect users against burns.
- Parameters should be set in accordance to the heating system design.
- The controller is not an intrinsically safe device. It means that in case of failure it can be a source of sparks or high temperature which can cause fire or explosion.
- Modification of the programmed parameters should be made only by the installer.
- Use only in central heating system made in accordance with currently valid regulations.
- Electrical system including the controller should be 3-wired and protected with fuse selected in accordance with used loads.
- The controller components cannot be used with damaged housing.
- Never make any modifications in controller components structure.
- The controller consists of two key elements: Touchscreen display and wiring centre. Any replaced components must be compatible.
- Keep children away from the controller.

1.3 INFORMATION ABOUT DOCUMENTATION

This manual is divided into two parts: for user and installer. Both parts contain important information significant for safety issues, hence the user should read both parts of the manual.

Grant UK are not responsible for any damages caused by failure to follow these instructions.

1.4 STORAGE OF DOCUMENTATION

This installation and operation manual, as well as any other applicable documentation, should be stored in a safe place for future reference.

1.5 CONDITIONS OF STORAGE AND TRANSPORT

The controller cannot be exposed to direct effects of weather, i.e., rain and sunlight. During transport, the device cannot be exposed to vibrations greater than typical for normal road transport.

1.6 PRODUCT CONTENTS

This Grant Aerona Smart Controller is supplied for assembly on installation and is carefully packed with packing materials.

Table 1-1: Product contents

Quantity	Item
1	Touchscreen display
1	Touchscreen display mounting plate
1	Touchscreen display cable (1m)
1	Controller wiring centre
1	Outdoor weather sensor
3	Water temperature sensors (2 x 2m, 1 x 4m)
1	Wi-Fi Hub Kit <ul style="list-style-type: none"> - Wi-Fi Module - Power Supply - ecoLINK Cable
1	Smart Flow sensor kit (including 1m cable)
1	Accessory & Fixing Pack <ul style="list-style-type: none"> - 6 x Wall plugs and screws - 6 x Cable clamps - 12 x Cable clamp screws - 2 x 10 pin pluggable terminal blocks - 2 x 14 pin pluggable terminal blocks - 2 x 4 pin pluggable terminal blocks - 2 x 2 pin pluggable terminal blocks
1	Heat Pump connection kit* <ul style="list-style-type: none"> - 2 x Flexible Hoses & 90° Elbow - 2 x Isolation Valves

* The Heat Pump connection kit will need to match the Heat pump model it is being installed with.

1.7 ADDITIONAL COMPONENTS

Grant UK offer a number of additional components compatible with the Aerona Smart Controller for consideration.

Table 1-2: Additional components

Part Code	Item
HPIDSMARTWRTR	Wireless thermostat (with receiver)
HPIDSMARTWRT	Wireless thermostat (no receiver)
HPIDSMARTRECEIVER	Wireless thermostat receiver
HPIDSMARTHRT	Wired thermostat
HPIDSMARTSEN2	Water temperature sensor with 2m cable
HPIDSMARTSEN4	Water temperature sensor with 4m cable
HPIDSMARTIMM	Immersion Heater Relay*

*supplied as part of Aerona Smart Controller installation packs

1.8 CUSTOMER SUPPORT HUB

Grant UK provides an online support centre for Heating Professionals and Homeowners to access post-installation care, advice and maintenance support for Grant products. Follow the QR codes below to access your relevant Customer Support Centre.



Homeowner



Professional

2 Technical Data

2.1 WIRING CENTRE

Table 2-1: Technical Data

Grant Aeron Smart Controller - Wiring Centre

Power supply	230V AC, 50Hz
Controller current consumption	0.4 A ³
Maximum rate current	6 (6) A
Protection class	IP 20 ⁴
Ambient Temperature	0 to 50° C
Storage temperature	0 to 65° C
Relative humidity	5 to 85% without water vapour condensation
Outdoor Weather Sensor working range	-40 to 110° C
Measurement accuracy: Water & Outdoor Weather Sensors	±2° C
Wiring centre dimensions	234mm x 225mm x 64mm
Standards	EN 60730-2-9. EN 60730-1
Software class	A, according to EN 60730-1
Protection class	IP 20
Installation method	Wall mounted

³ Current consumed only by the controller. Overall current consumption depends on number of devices

⁴ After installing all cable clamps.

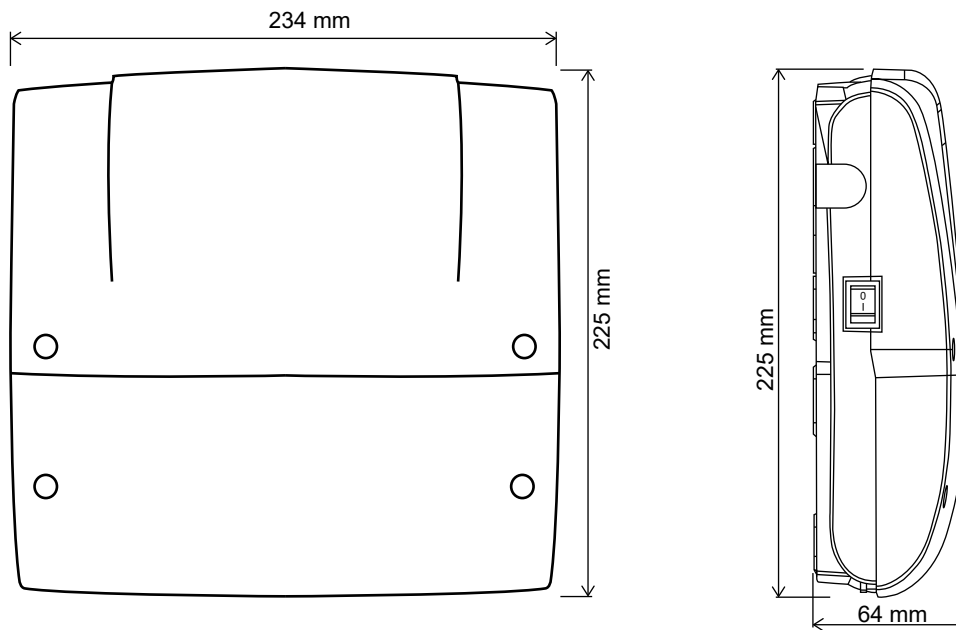

Figure 2-1: Wiring centre dimensions

2.2 TOUCHSCREEN DISPLAY

Table 2-2: Technical Data - Touchscreen Display

Grant Aeron Smart Controller - Touchscreen Display

Power supply	12V DC directly the Wiring centre
Touchscreen display current consumption	0.15A
Display	Touch screen, graphical 480px x 272px
Protection class	IP 20
Ambient temperature	0 to 50° C
Relative humidity	0 to 65° C
Touchscreen display dimensions	144mm x 97mm x 20mm
Standards	EN 60730-2-9, EN 60730-1
Software class	A, according to EN 60730-1
Installation method	Wall mounted

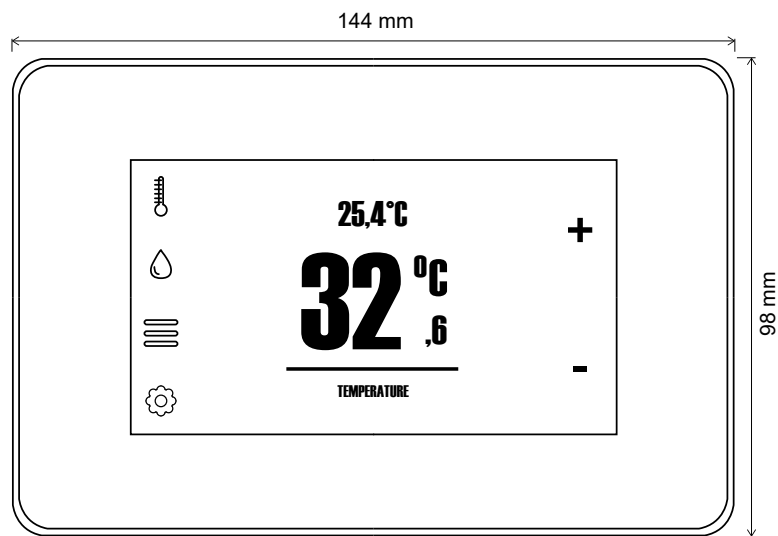

Figure 2-2: Touchscreen display dimensions

3 Installation

IMMEDIATE CONSIDERATION SHOULD BE GIVEN TO HYDRAULIC (REFER TO SECTION 4) AND ELECTRICAL (REFER TO SECTION 5) CONNECTIONS PRIOR TO INSTALLATION FOR WIRING CENTRE POSITIONING.

3.1 GENERAL

This Section gives details of the installation process for the Grant Aerona Smart controller.

These installation instructions must be read in conjunction with the Grant Aerona air source heat pump installation instructions (provided with the unit).

Before starting to install the Grant Aerona Smart controller please read the Health and Safety information given in Section 13 of these installation instructions.

Similarly, before starting any installation work on the Grant Aerona air source heat pump please read the Health and Safety information given in Section 14 of the Aerona³ installation instructions.

3.2 REGULATIONS AND STANDARDS

The installation of the Grant Aerona Smart controller and a Grant Aerona air source heat pump must be in accordance with the following recommendations, as applicable:

- Building Regulations for England and Wales, and Building Standards for Scotland
- Local Bylaws (check with the Local Authority for the area)
- Water Supply (Water Fittings) Regulations 1999
- MCS Installer Standards
- MIS3005-D The heat pump Standard (Design)
- MIS3005-I The heat pump Standard (Installation)
- MCS020 MCS Planning Standard

The installation should also be in accordance with the latest edition of the following standards and Codes of Practice:

- BS7671 and amendments
- BS EN 12831

3.3 TOUCHSCREEN DISPLAY

The touchscreen display is designed to be wall mounted. It must not be installed in steamy conditions such as a bath or shower room. The touchscreen display should be mounted at a height allowing comfortable operation, typically 1.5m above the floor. Refer to Figure 3.1.

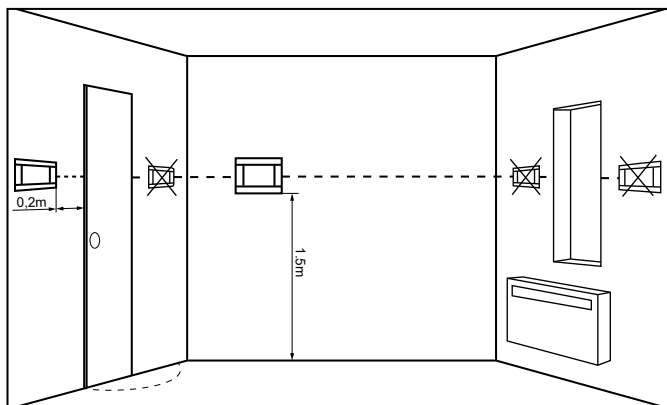

Figure 3-1: Touchscreen positioning

To reduce measurement disturbances avoid locations exposed to strong sunlight, with poor air circulation, near heating equipment, and directly at the door and windows, typically 200mm from the edge of the door.

! NOTE !

When selecting the cable connecting the touchscreen display with the wiring centre, you must use a cable with single wire resistance lower than 8Ω. Total cable length must not exceed 100m.

3.3.1 FITTING THE TOUCHSCREEN DISPLAY

The touchscreen display installation should be done according to the following guidelines:

1. Detach the mounting plate from the back of the touchscreen display. The plate is attached to the touchscreen with latches. Use a flat screwdriver to detach the plate. (See Figure 3-2)
2. Using a sharp tool cut out holes in four places of the cover for the screw terminals. (See Figure 3-3)

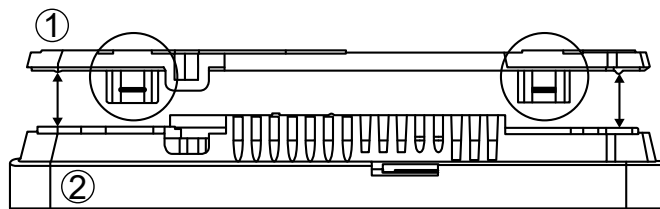

Figure 3-2: touchscreen display & back plate

3. Connect the cable to the screw terminal as described on the plate. Refer to Figure 3-4 The cable can be recessed in the wall or it can run over its surface - In this case the cable should be additionally placed in the cable channel.

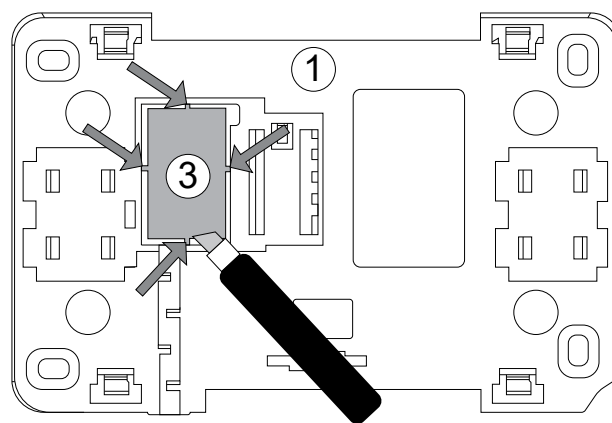

Figure 3-3: Mounting plate cutaway

4. Drill holes in the wall and use screws to fix the mounting plate in the chosen place of the wall, maintaining its proper position (Refer to Figure 3-4)
5. Attach the panel to the mounting plate using latches.w

! NOTE !

The touchscreen display connection cable can not be ducted with other electrical cables that are part of the building mains and should not be routed near devices that emit a strong Electromagnetic field

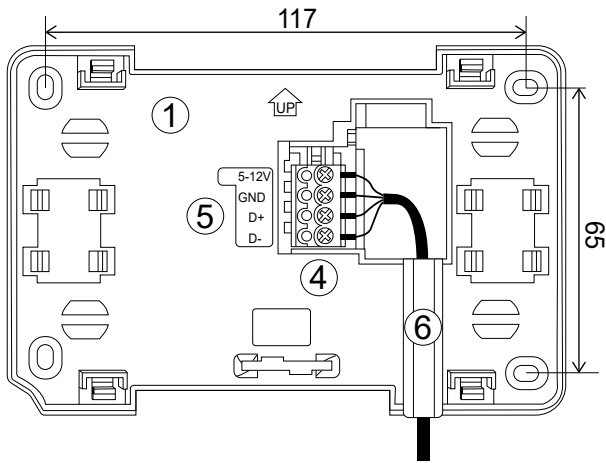

Figure 3-4: Mounting plate wiring

Table 3-1: Touchscreen display & mounting plate

No	Description
1	Touchscreen display mounting plate
2	Touchscreen display
3	Mounting plate cut-away
4	Screw terminal
5	Terminal connection guide
6	Cable Channel

3.4 WIRING CENTRE

The wiring centre should be located in a suitable and neutral position to avoid damage and tampering.

3.4.1 FITTING THE WIRING CENTRE

The wiring centre should be mounted on to a flat surface, e.g., wall.

1. Drill and fit 2 mounting points for the mounting holes provided on the upper Section of the back of the wiring centre. (See Figure 3-5).
2. Slot the wiring centre in place ensuring it is fully down.
3. Remove wiring centre lower front cover (via 2 screws) and mark position of lower 2 holes. (See Figure 3-5)
4. Remove wiring centre, drill and fit wall plugs
5. Set wiring centre back in position and fix controller with lower holes to secure in final position.
6. Ensure the wiring centre is securely in place and replace lower controller case front.

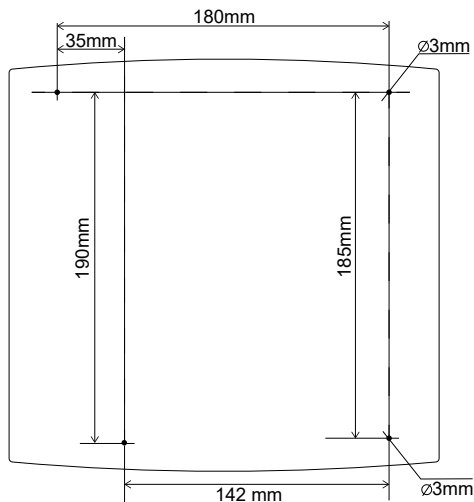

Figure 3-5: Wiring centre fixing centres

! NOTE !

Ensure to leave adequate access to the ON/OFF switch if the left side of the wiring centre is close to a side wall.

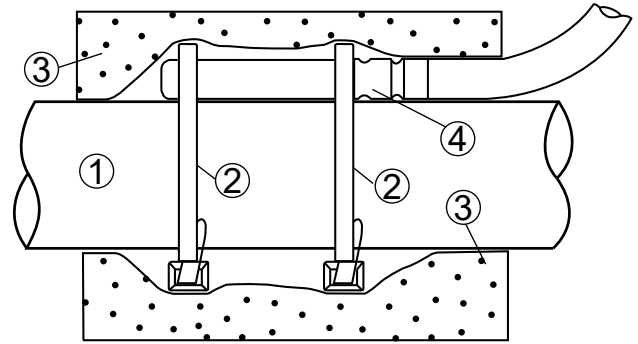

Figure 3-6: Circuit temperature sensor fitting

Table 3-2: Temperature Sensor installation

No	Description
1	Flow Pipe
2	Zip tie
3	Thermal insulation
4	Water Temperature sensor

3.5 TEMPERATURE SENSORS

The Smart Controller should be used only with the Grant supplied Outdoor and Water temperature sensors. At least one Water temperature sensor is necessary to activate the controller.

3.5.1 WATER TEMPERATURE SENSORS

The water temperature sensors should be installed in an area of the system relevant to their function. For heating circuits the most suitable location would be after controlled valves on the circuit flow to give the most accurate reading for the circuit.

Insulate the sensors affixed to the external surface of the pipe using thermal insulation covering the sensor together with the pipe. (Refer to Figure 3-6)

3.5.1 OUTDOOR WEATHER SENSOR

The Outdoor weather sensor is the only external sensor to be used with the Grant Aeron Smart Controller. It should:

- Be fixed to a coldest wall in the building, usually a north wall under the roof.
- Not be exposed to direct solar radiation or rain.
- Be fixed on a minimum height of 2m above the ground and in a distance of at least 1.5m from windows, chimneys and other heat sources which could interrupt the temperature measurement.
- Use a connecting cable with a cross section of at least 0.5 mm² and length of 25m. Polarity of wires is not important.

To fasten the external sensor to the wall.

1. Remove the front of the sensor housing. (Refer to Figure 3-7).
2. Position the rear part of the housing against the wall, mark and drill fixing holes.
3. Insert the supplied wall plugs, place the housing back into position and secure in place with the screws.

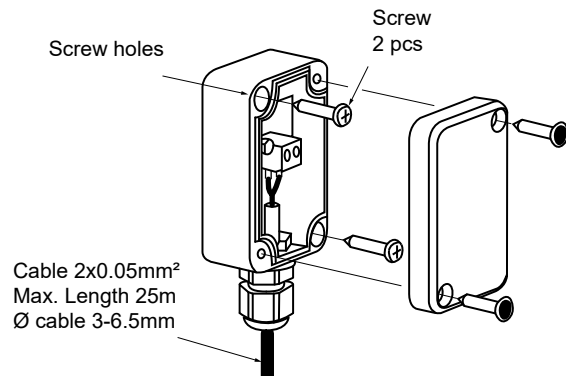

Figure 3-7: Outdoor weather sensor

3.5.3 TEMPERATURE SENSOR RESISTANCE

The accuracy of the temperature sensors can be checked by measuring their resistance at a given temperature. In case of significant differences between measured resistance value and values in Table below, the sensor should be replaced. (See Table 3-3)

Table 3-3: Temperature/Resistance chart

Water and Outdoor Weather sensors (10kΩ NTC)

Temp (°C)	Nom (Ω)
-30	175200
-20	96358
-10	55046
0	32554
10	19872
20	12488
30	8059
40	5330
50	3605
60	2490
70	1753
80	1256
90	915.4
100	677.3
110	508.30
120	386.60

3.6 CONNECTING PUMPS

Electrical connections from the circuit pumps to the controller should be according to the electrical schematics. See Section 4.

3.7 CONNECTING 3-PORT MIXING VALVES

The Grant Aerona Smart Controller should only be used with valve actuators equipped with limit switches and the 3-Port mixing valves can only be fitted as part of an adjustable circuit. Refer to Appendix C for further details on 3-Port mixing valves.

A water temperature sensor will also need to be installed after the mixing valve to measure the mixed water flow temperature for the circuit.

3.8 CONNECTING RELAYS

A relay for supplementary heating from a Buffer, Volumiser, Low Loss header and/or DHW cylinder can be used in conjunction with the Grant Aerona Smart controller.

They are to be connected via H1 (Buffer, Volumiser or Low Loss header) or H2 (DHW Cylinder) as the terminals are preset to the functions within the Smart Controller software.

Grant UK supply the Grant Smart Immersion relay as part of our installation packs. See Appendix D for further guidance on wiring specifics.

3.9 SMART FLOW SENSOR

The Grant smart flow sensor monitors the return flow rate to the heat pump. Refer to Appendix E for installation and configuration requirements.

3.10 ROOM THERMOSTAT CONNECTION

For optimum operation of the Grant Aerona Smart Controller each circuit within the system should have an individual thermostat assigned to it.

The room thermostats connect to the wiring centre and can utilise the weather compensation function to automatically adjust the flow temperature within the circuit to provide a consistent room temperature. The required temperature is set on the room thermostat of the circuit concerned.

It is recommended to use the touchscreen as a room thermostat.

3.10.1 ROOM THERMOSTAT WIRING

The Grant Aerona Smart controller can support multiple wired room thermostats (including the touchscreen display). You will need to ensure the correct polarity of the connections are respected when wiring the room thermostats/touchscreen display in parallel to the wiring centre. (Refer to Figure 3-8).

With the connections made you will need to pair and assign the room thermostats with their own address.

See Appendix A for installation and operation guidance.

! CAUTION !

Maximum length of wires should not exceed 30m. This length may be longer if the wires used have cross-section exceeding 0.5 mm².

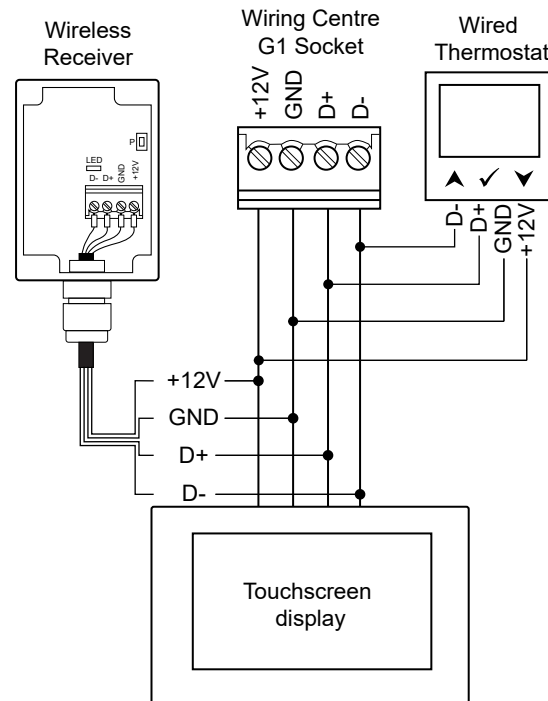

Figure 3-8: Wired and Wireless wiring schematic

3.10.2 WIRELESS ROOM THERMOSTAT

Connecting a wireless room thermostat requires connecting the wireless receiver to the G1 socket in the same fashion as the wired thermostat and pairing between the wireless receiver and thermostat. The wireless receiver can support up to 3 wireless thermostats.

See Appendix B for Installation and operation guidance.

! NOTE !

Close attention must be paid to the 4 connections (+12V, GND, D+ and D-). Ensure they match to corresponding wires from touchscreen display. (+12V is also referenced as VCC).

3.11 CONNECTING THE WI-FI HUB

The Wi-Fi hub should be connected between the USB socket and the G3 socket of the wiring centre using the ecoLINK cable supplied. Refer to Section 10 for installation and user guidance.

4 System Hydraulics

4.1 HYDRAULIC CONNECTIONS

The Grant Aerona Smart controller can be utilised in a number of ways via the Smart controller configuration creator and settings configuration.

The enclosed hydraulic schematics demonstrate typical setups associated with the Grant renewables price list installation packs - available from the Grant UK website.

Refer to the Grant Aerona Heat pump manual provided for further information regarding sealed system & DHW considerations.

Refer to Section 5.4, 5.5 and 5.6 for corresponding electrical connection drawings.

4.2 INSTALLATION PACK SUMMARY

4.2.1 INSTALLATION PACK P

Installation Pack P - Direct S-Plan with non pre-plumbed cylinder.

Table 4-1: Installation Pack P

Order code: HPIDR32PACKP

Flexi_Foot Kit

Mag One Filter

18L System Kit

32A Isolator

Grant Smart Immersion Relay

Refer to Section 4.4 for Hydraulic schematic.

4.2.2 INSTALLATION PACK Q

Installation Pack Q - Open Loop Direct using 3-Port Diverter and Mixing Valve with non pre-plumbed cylinder.

Table 4-2: Installation Pack Q

Order code: HPIDR32PACKQ

Flexi-Foot Kit

Mag One Filter

18L System Kit

32A Isolator

Grant Smart Immersion Relay

28mm 3 Port Diverter Valve

22mm 3 Port Mixing Valve

Refer to Section 4.5 for Hydraulic schematic.

4.2.3 INSTALLATION PACK R

Installation Pack R - Open Loop Direct using 3 Port Diverter Valve with non pre-plumbed cylinder.

Table 4-3: Installation Pack R

Order code: HPIDR32PACKR

Flexi-Foot Kit

Mag One Filter

18L System Kit

32A Isolator

Grant Smart Immersion relay

28mm 3 Port Diverter Valve

Refer to Section 4-6 for Hydraulic schematic.

4.3 HYDRAULIC CONTROLS

4.3.1 THERMOSTATIC PUMP BLOCKADE

Thermostatic pump blockade is a hydraulic control feature within a heating circuits setting that enables the Grant Aerona Smart controller to either switch a circuit pump/valve OFF (Pump blockade ON) or keep the circuit active (Pump blockade OFF) based on the status of the thermostat monitoring the circuit.

Refer to Section 7.8 for further details on how to activate and use this function.

4.3.2 CIRCUIT STOP FROM PRESET TEMP

'Circuit stop from Preset temp' is a hydraulic control feature within a mixing heating circuits setting that enables the Grant Aerona Smart controller to either switch a circuit pump/valve OFF (Circuit stop on Preset temp ON) or keep the circuit active (Circuit stop on Preset temp OFF) based on the status of the water temperature sensor on the flow in the circuit.

Refer to Section 7.8 for further details on how to activate and use this function.

Item	Description
1	Aerona ³ ASHP
2	Flexible hose ¹
3	Isolation valve ¹
4	Grant External Volumiser ²
5	Anti-Vibration Mounts ²
6	Flow sensor ¹
7	Grant Mag One magnetic filter kit ²
8	Wiring Centre Smart Controls ¹
9	Touch Screen Display ¹
10	Room thermostat - HPIDSMARTHRT (optional)
11	Motorized 2-Port valve (DHW)
12	Automatic air vent
13	Cylinder Immersion heater
14	DHW cylinder
15	Immersion heater relay ²
16	Drain point ²
17	Removable filling loop ²
18	Double check valve ²
19	Pressure gauge ²
20	Expansion vessel ²
21	Tundish ²
22	Pressure relief valve ²
23	Automatic bypass ²
24	Thermostatic Radiator valve
25	Motorized 2-Port valve (Radiator circuit)
26	Motorized 2-Port valve (UFH circuit)
27	Thermostatic mixing valve
28	UFH mixing set pump
29	UFH manifold

*Outputs available: 6, 10, 13 & 17 kW
¹Supplied with the HPIDR32SMART* Smart Controller Kit
²Supplied with HPIDR32PACK

! NOTE !

***30L external volumiser or low loss header are available as an optional component where there is insufficient system volume or where hydraulic separation is required (HPIDVOLEXT30/HPIDSYLLHKIT).

IMPORTANT

The below diagram shows the Flow (outlet) and Return (inlet) connection positions for HPID6R32 models ONLY.

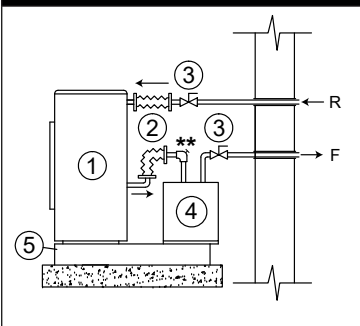

**Compression elbow c/w air vent (supplied with HPIDVOL30EXT6)

IMPORTANT

For positions of the Flow (outlet) and Return (inlet) connections on HPID10R32, HPID13R32 and HPID17R32 models, see above.

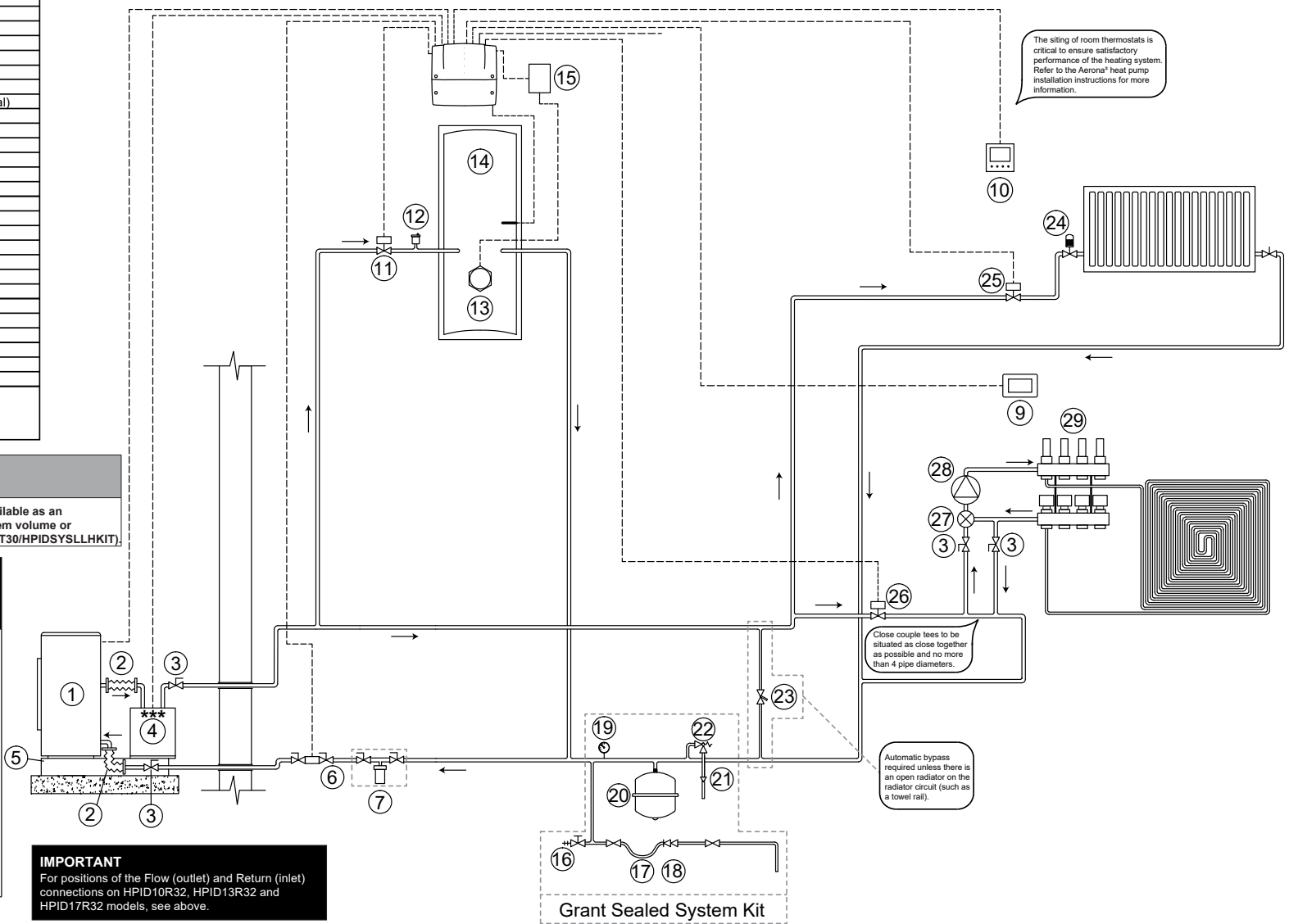

The siting of room thermostats is critical to ensure satisfactory performance of the heating system. Refer to the Aerona³ heat pump installation instructions for more information.

Close couple tees to be situated as close together as possible and no more than 4 pipe diameters.

Automatic bypass required unless there is an open radiator on the radiator circuit (such as a towel rail).

! NOTE !

Please refer to the Aerona³ ASHP installation instructions for details of the flow and return connections at the heat pump.

! NOTE !

This system schematic should be read in conjunction with the Grant Aerona Smart Control installation instructions and wiring diagram HPCS-P001E.

Item	Description
1	Aerona ASHP
2	Flexible hose ¹
3	Isolation valve ¹
4	Grant External Volumiser***
5	Anti-Vibration Mounts ²
6	Flow sensor ¹
7	Grant Mag One magnetic filter kit ²
8	Wiring Centre Smart Controls ¹
9	Touch Screen Display ¹
10	Room thermostat
11	Automatic air vent
12	Cylinder immersion heater
13	DHW cylinder
14	Immersion heater relay ²
15	Drain point ²
16	Removable filling loop ²
17	Double check valve ²
18	Pressure gauge ²
19	Expansion vessel ²
20	Tundish ²
21	Pressure relief valve ²
22	Automatic system bypass ²
23	Circulating pump
24	UFH manifold
25	3-Port diverted valve ²
26	Thermostatic radiator valve
27	3-Port mixing valve ²
28	Water sensor ¹

*Outputs available: 6, 10, 13 & 17 kW
¹Supplied with the HPIDR32SMART* Smart Controller Kit
²Supplied with HPIDR32PACKQ

! NOTE !

***30L external volumiser or low loss header are available as an optional component where there is insufficient system volume or where hydraulic separation is required (HPIDVOLEXT30/HPIDSYSLHKIT).

IMPORTANT

The below diagram shows the Flow (outlet) and Return (inlet) connection positions for HPID6R32 models ONLY.

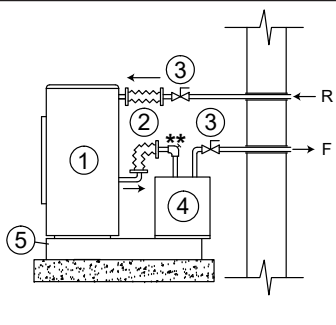

**Compression elbow c/w air vent (supplied with HPIDVOL30EXT6)

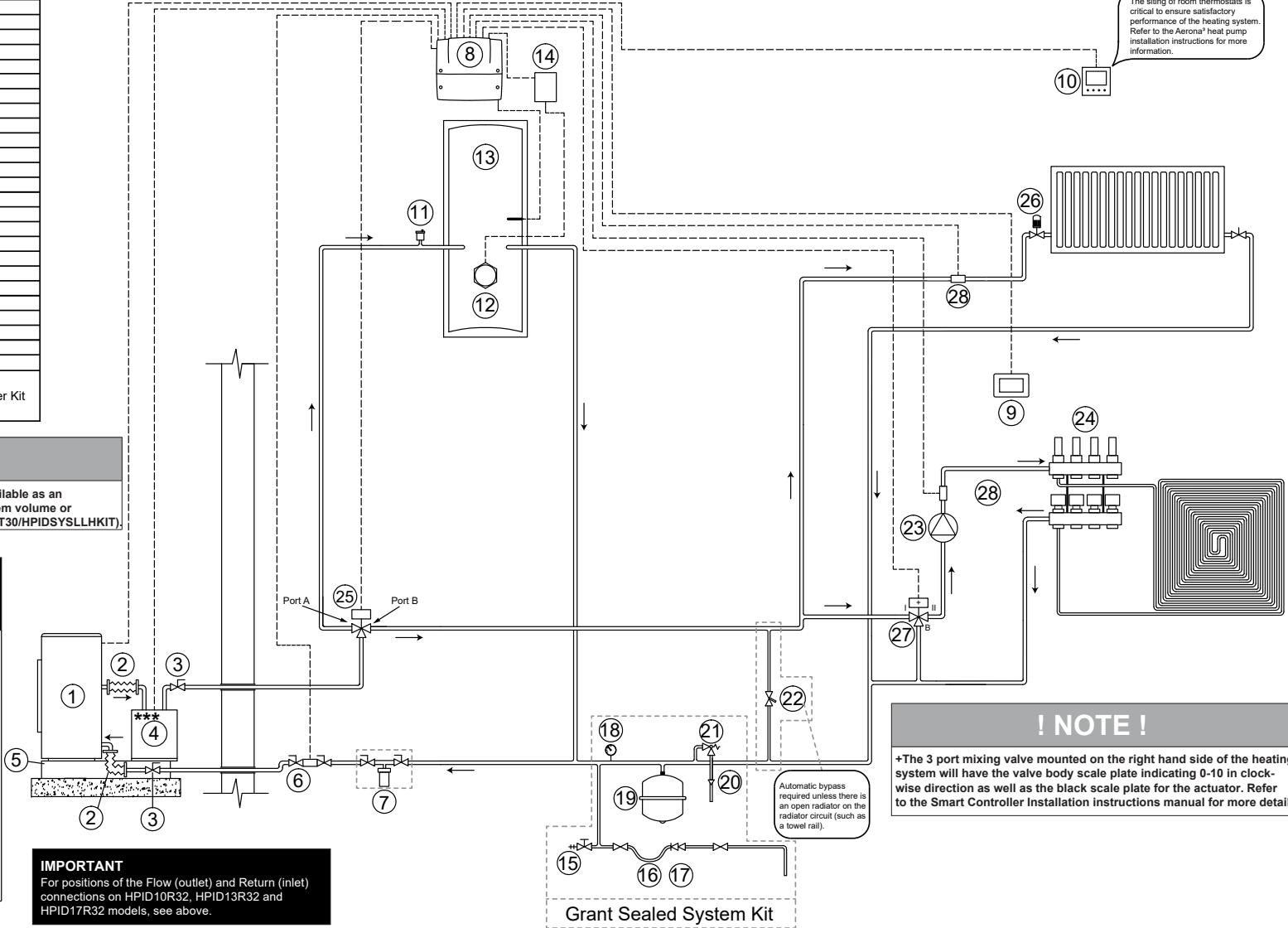

The siting of room thermostats is critical to ensure satisfactory performance of the heating system. Refer to the Aerona[®] heat pump installation instructions for more information.

Automatic bypass required unless there is an open radiator on the radiator circuit (such as a towel rail).

! NOTE !

+The 3 port mixing valve mounted on the right hand side of the heating system will have the valve body scale plate indicating 0-10 in clockwise direction as well as the black scale plate for the actuator. Refer to the Smart Controller Installation instructions manual for more detail.

IMPORTANT
 For positions of the Flow (outlet) and Return (inlet) connections on HPID10R32, HPID13R32 and HPID17R32 models, see above.

! NOTE !

Please refer to the Aerona ASHP installation instructions for details of the flow and return connections at the heat pump.

! NOTE !

This system schematic should be read in conjunction with the Grant Aerona Smart Control installation instructions and wiring diagram HPCS-Q001E.

Item	Description
1	Aerona ASHP
2	Flexible hose ¹
3	Isolation valve ¹
4	Grant External Volumiser***
5	Anti-Vibration Mounts ²
6	Flow Sensor ¹
7	Grant Mag One magnetic filter ²
8	Wiring Centre ¹
9	Touch Screen Display ¹
10	Room thermostat
11	Automatic air vent
12	Cylinder immersion heater
13	DHW cylinder
14	Immersion heater relay ²
15	Drain point ²
16	Removable filling loop ²
17	Double check valve ²
18	Pressure gauge ²
19	Expansion vessel ²
20	Tundish ²
21	Pressure relief valve ²
22	Automatic system bypass
23	Motorized 2-Port valve (Upstairs - Radiators)
24	Thermostatic Radiator Valve
25	3-Port diverter valve ²
26	Motorized 2-Port valve (UFH - Downstairs)
27	Thermostatic Mixing Valve
28	UFH Pump
29	UFH Manifold
30	Isolation valve

* Outputs available: 6, 10, 13 & 17 kW
¹ Supplied with the HPIDR32SMART* Smart Controller Kit
² Supplied with HPIDR32PACKR

! NOTE !

***30L external volumiser or low loss header are available as an optional component where there is insufficient system volume or where hydraulic separation is required (HPIDVOLEXT30/HPIDSYLLHKIT).

IMPORTANT
The below diagram shows the Flow (outlet) and Return (inlet) connection positions for HPID6R32 models ONLY.

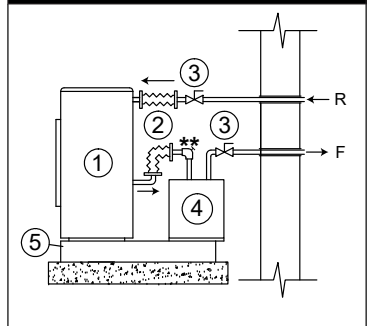

**Compression elbow c/w air vent (supplied with HPIDVOL30EXT6)

IMPORTANT
For positions of the Flow (outlet) and Return (inlet) connections on HPID10R32, HPID13R32 and HPID17R32 models, see above.

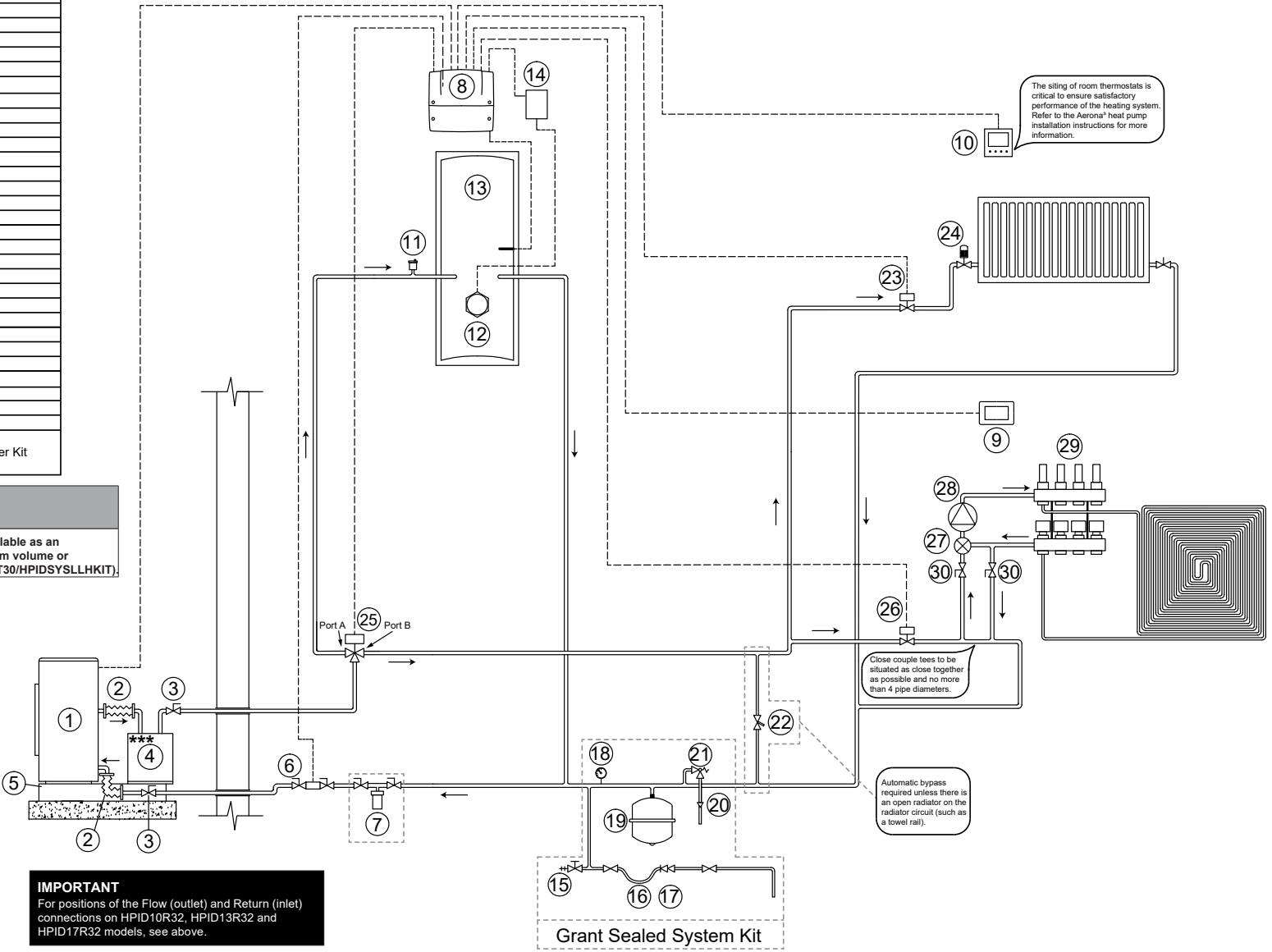

The siting of room thermostats is critical to ensure satisfactory performance of the heating system. Refer to the Aerona's heat pump installation instructions for more information.

Close couple tees to be situated as close together as possible and no more than 4 pipe diameters.

Automatic bypass required unless there is an open radiator on the radiator circuit (such as a towel rail).

! NOTE !

Please refer to the Aerona ASHP installation instructions for details of the flow and return connections at the heat pump.

! NOTE !

This system schematic should be read in conjunction with the Grant Aerona Smart Control installation instructions and wiring diagram HPCS-R001E.

5 Electrical Connections

5.1 CONNECTING THE WIRING CENTRE

The wiring centre is to be powered with 230V AC/50 Hz voltage. The electrical installation should be:

- Fused at 3A and earthed,
- Cable size to be 0.75mm² - 1mm².
- In accordance with current regulations, must be protected with a residual current protection device (RCD) with a rating In=30mA.

! WARNING !

All electrical scheme components should be connected only by qualified persons in accordance with applicable regulations. Follow safety precautions to prevent electrocution.

! WARNING !

After the wiring centre is turned off dangerous voltage on terminals may still be present. Before removing cover, disconnect the main power supply and use a Multimeter to check for voltage on terminals and leads.

For safety reasons, the wiring centre must be connected to a fused 230V AC power supply, with the sequence of connecting the live (L) and neutral (N) wires. Make sure that the L and N conductors are not crossed within the building's electrical system, e.g., in an electrical socket or junction box.

5.1.1 ELECTRICAL CONNECTIONS

All wiring connections should be made to the corresponding terminals on the pluggable terminal blocks supplied in the accessory and fixing pack.

1. Remove the terminal cover from the wiring centre housing. Refer to Figure 5-3

! NOTE !

Isolate any incoming voltages on connections before removing the wiring centre cover beginning to connect to the wiring centre.

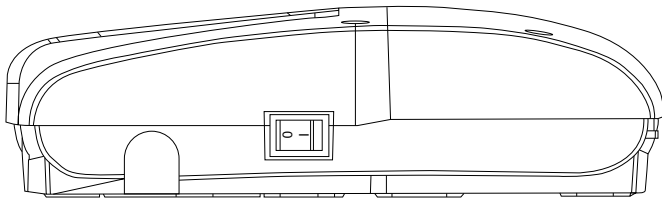

Figure 5-1: Power switch

2. Connect L & N wires of the supply to Terminals 1 & 2. Refer to Figure 5-3 for wiring centre terminal diagram.

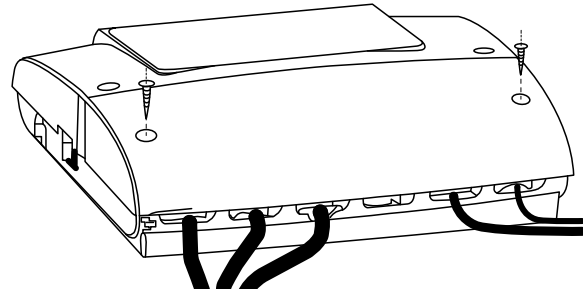

Figure 5-2: Wiring centre terminals cover

3. Connect the earth wire to the earth terminal strip inside the wiring centre housing.
4. Arrange the wires to prevent damaging the insulation by cutting it with cover edges or screws securing the cover.
5. Secure wire with cable clamp to prevent loosening from potential mechanical stress.

! WARNING !

The maximum length of the exposed wires extending from the outer cable sheath should not exceed 50mm. Connection cables should not be on contact with surfaces that exceed nominal operating temperature of 50°C.

! CAUTION !

All cable clamps must be fitted even if not all clamps are needed to maintain IP20.

! NOTE !

The wiring centre cover should always be in place before connecting the electrical supply.

5.2 COMPONENT CONNECTIONS

Electrical components of the planned system are to be connected to the wiring centre of the Grant Aeron smart controller. Refer to Section 5.4 for wiring centre layout.

With the adjustable circuits, mixing needs a water temperature sensor connected to monitor the mixed water entering the circuit to adjust accordingly. Table 5-1 displays the relation between the individual heating circuit and its associated component terminals.

Table 5-1: Circuit component connections

Heating Circuit	Pump/Valve	Mixer	Water sensor
1	H1-P	None	None
2	H2-P	H2-M	H2-S
3	H3-P	H3-M	H3-S

Refer to 5.5, 5.6 & 5.7 for example pack wiring schematics. For any further guidance on device connections or schematic drawings, please contact Grant UK.

5.3 POWER SUPPLY FAILURE

In case of power supply failure, the controller returns to the work mode in which it was working previously when the power supply is restored.

5.4 WIRING CENTRE LAYOUT

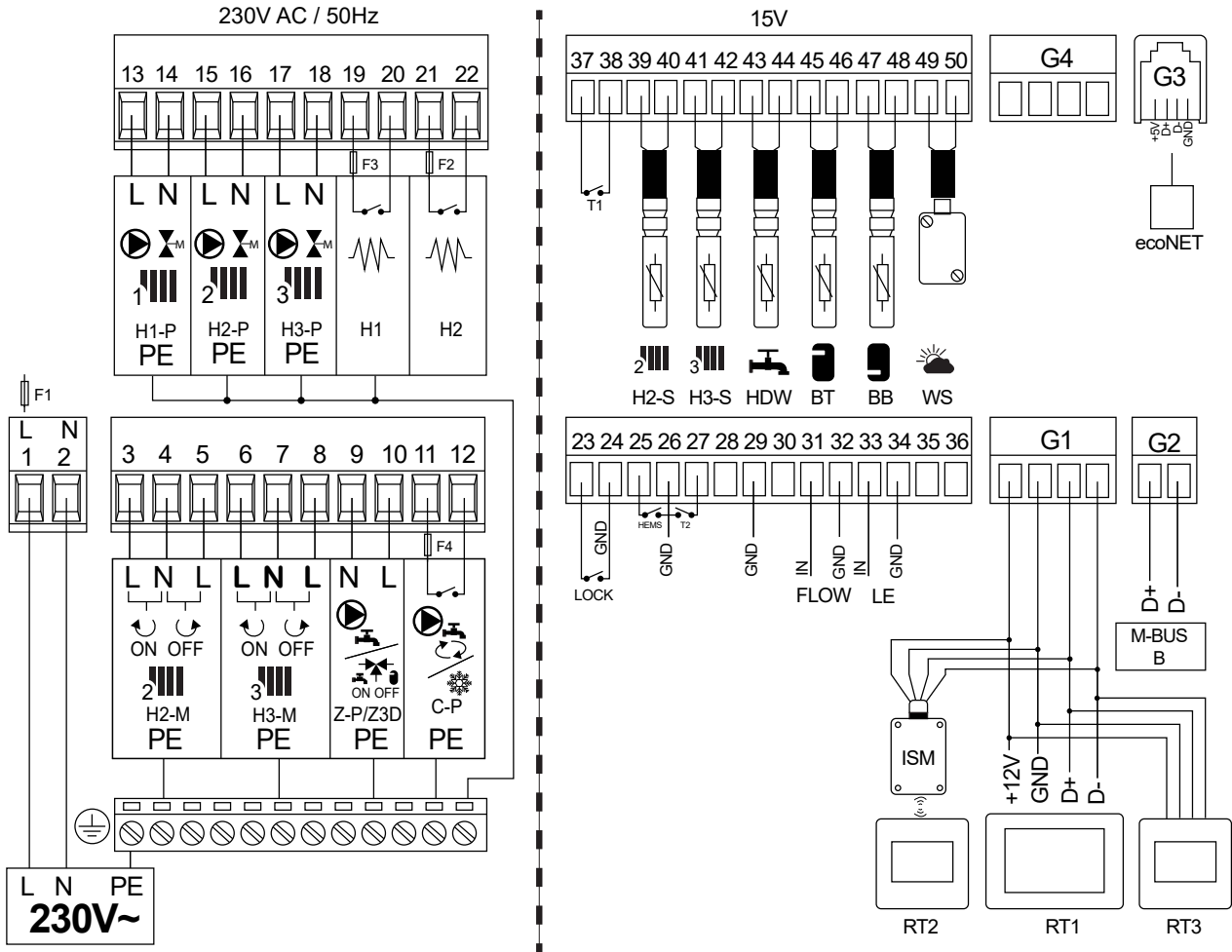

Figure 5-3: Wiring centre - Terminals

Table 5-2: Wiring Centre Terminals

Label	Terminal Numbers	Description
230V ~	1 & 2	Mains Live and Neutral
H2-M	3, 4 & 5	Circuit 2 Mixing valve - 2 x 230V Lives (ON and OFF) and Neutral
H3-M	6, 7 & 8	Circuit 3 Mixing Valve - 2 x 230V Lives (ON and OFF) and Neutral
Z-P/Z3D	9 & 10	DHW Pump/3-Port Diverter Valve
C-P	11 & 12	Secondary Circulation Pump
Flow	31 & 32	Flow sensor I/O & Ground
LE	33 & 34	Electricity Meter
G1	Terminal Set	Touchscreen & Thermostat connection terminals (RT1, RT2, RT3)
G2	M-BUS	Modbus connection to the Aerona Heat pump.
G3	G3 Socket	Connection port for ecoNET cable
G4	Terminal Set	+12V, Ground, D+, D-
H1-P	13 & 14	Circuit 1 230V Switched Live and Neutral
H2-P	15 & 16	Circuit 2 230V Switched Live and Neutral
H3-P	17 & 18	Circuit 3 230V Switched Live and Neutral
H1	19 & 20	Switch for Immersion Relay (Buffer)
H2	21 & 22	Switch for Immersion Relay (DHW Cylinder)
H2-S	39 & 40	Circuit 2 Water temperature sensor
H3-S	41 & 42	Circuit 3 Water temperature sensor
HDW	43 & 44	DHW Cylinder Water temperature sensor
BT	45 & 46	Buffer Upper Water temperature sensor
BB	47 & 48	Buffer Lower/Low Loss Header temperature sensor
WS	49 & 50	Outdoor Weather sensor
T1	37 & 38	External Volt-free switch for Circuit 2
T2	26 & 27	External Volt-free switch for Circuit 3
LOCK	23 & 24	Not used
HEMS	25 & 26	Not used

5.5 ELECTRICAL CONNECTIONS - PACK P

Grant UK Drawing Number: HPCS-P001E

Notes: Some Neutral and Earth connections have been excluded for clarity. Grant Smart Immersion relay to house 2 live connections. Ensure both are isolated prior to opening housing.

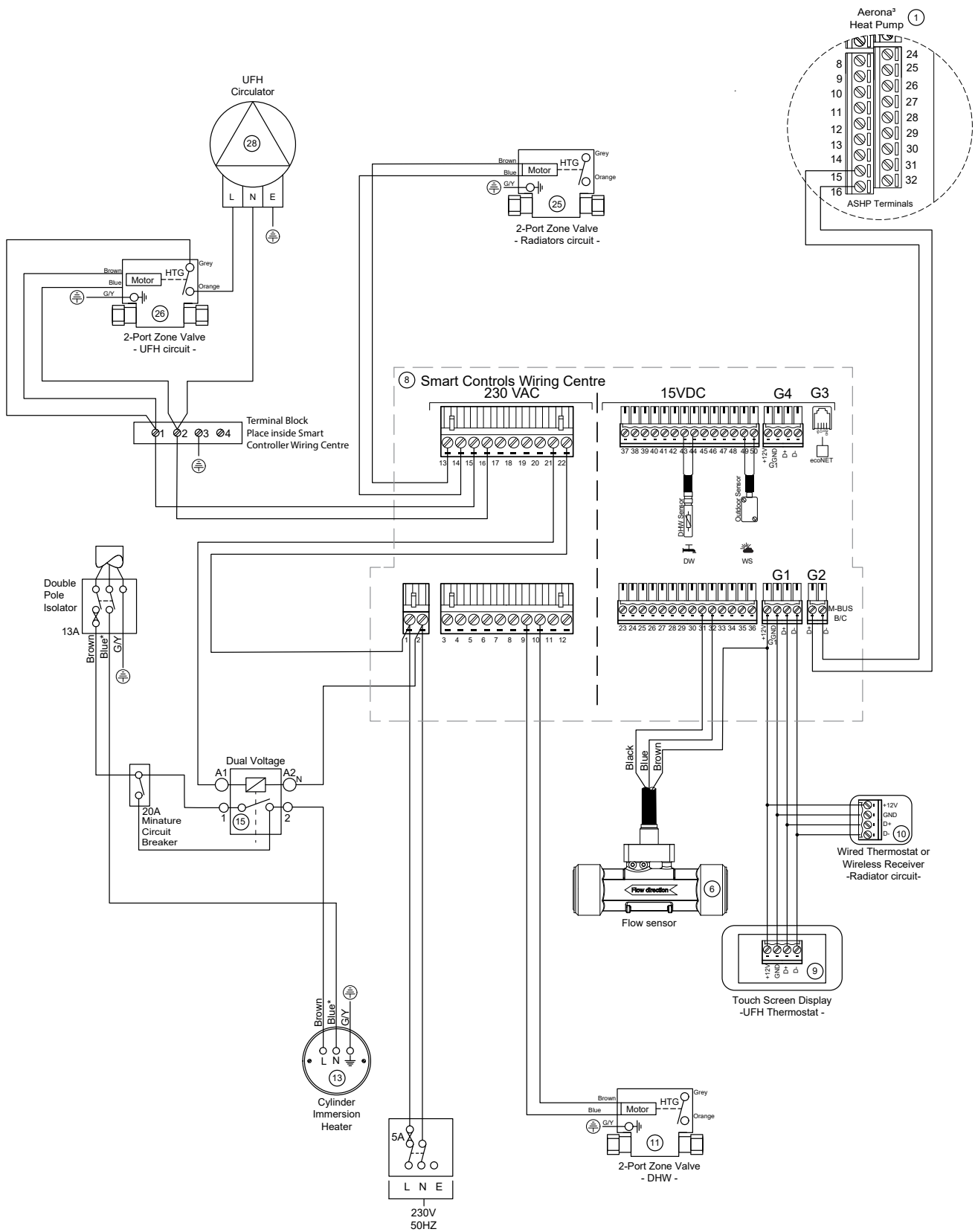

! NOTE !
 *Please ensure that neutrals are derived from the same supply to prevent spurious trips.

! NOTE !
 This wiring diagram should be read in conjunction with the Grant Aerona Smart Controls installation instructions and system schematic HPCS-P001S.

5.6 ELECTRICAL CONNECTIONS - PACK Q

Grant UK Drawing Number: HPCS-Q001E

Notes: Some Neutral and Earth connections have been excluded for clarity. Grant Smart Immersion relay to house 2 live connections. Ensure both are isolated prior to opening housing.

! NOTE !

**If the 3 port valve is mounted on the left side of the heating system, the actuator has to be mounted in reverse, hence the white wire will be connected to terminal 8, and the brown wire will be connected to terminal 6. Blue wire will remain in the same terminal.

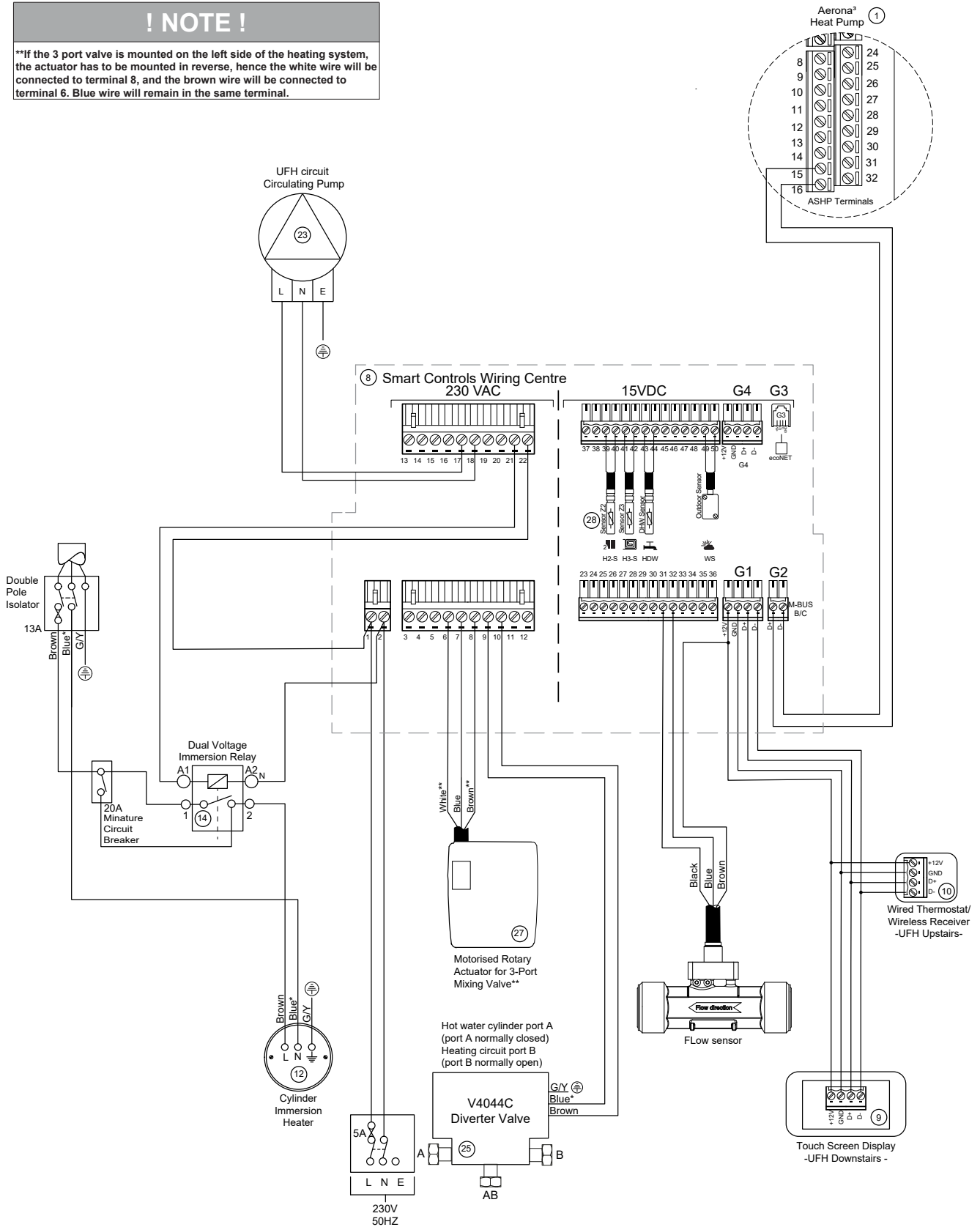

! NOTE !

*Please ensure that neutrals are derived from the same supply to prevent spurious trips.

! NOTE !

This wiring diagram should be read in conjunction with the Grant Aeronas Smart Controls installation instructions and system schematic HPCS-Q001S.

5.7 ELECTRICAL CONNECTIONS - PACK R

Grant UK Drawing Number: HPCS-R001E

Notes: Some Neutral and Earth connections have been excluded for clarity. Grant Smart Immersion relay to house 2 live connections. Ensure both are isolated prior to opening housing.

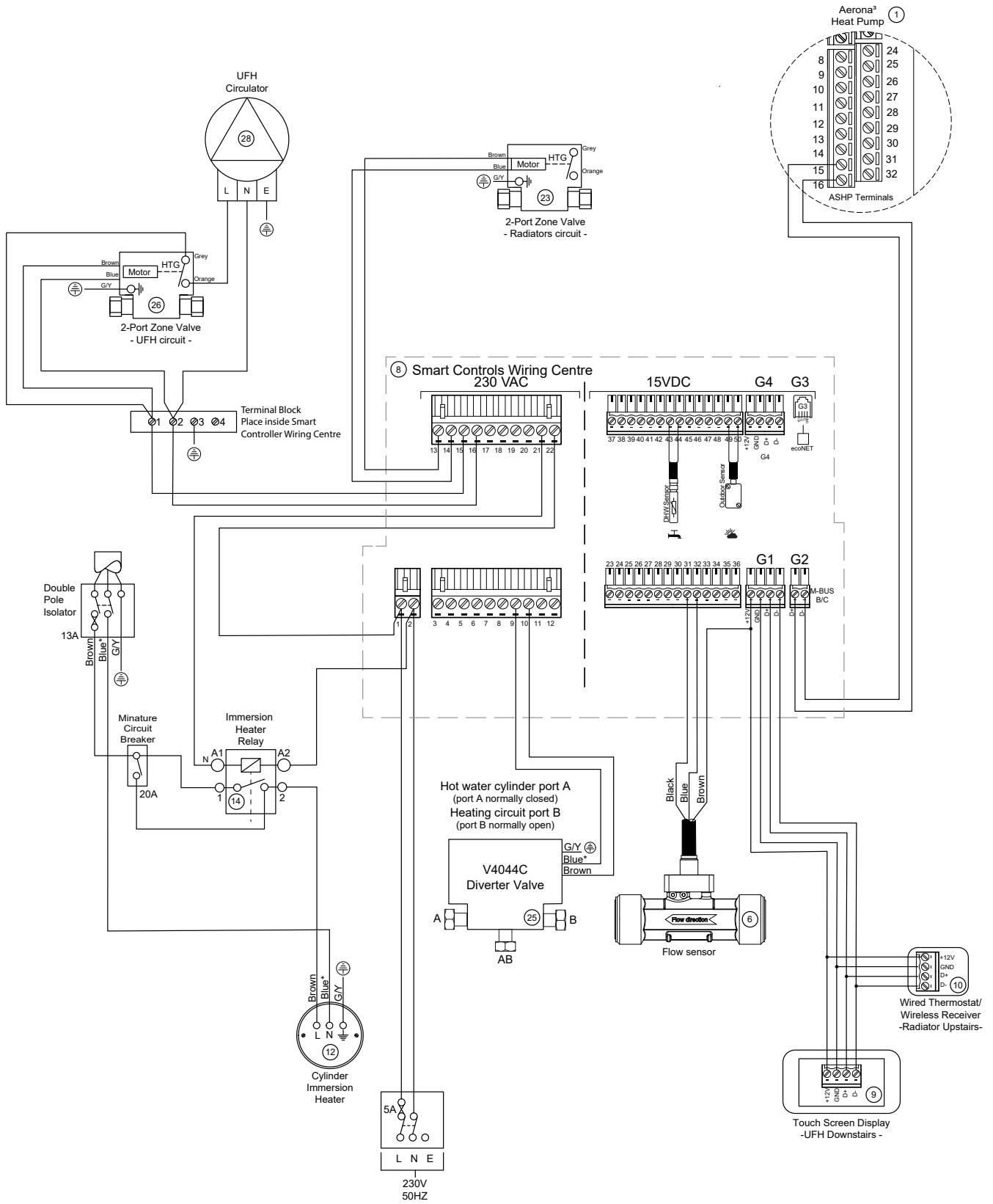

! NOTE !
 *Please ensure that neutrals are derived from the same supply to prevent spurious trips.

! NOTE !
 This wiring diagram should be read in conjunction with the Grant Aeronas Smart Controls installation instructions and system schematic HPCS-R001S.

6 System Configuration with Touchscreen display

6.1 FIRST SWITCH-ON

With installation completed, the Grant Aerona Smart controller will need to be configured:

1. Turn on the Grant Aerona Smart controller via the wiring centre power switch (Refer to Figure 5-1) and allow the software to cycle to the language selection panel. (Refer to Figure 6-1).

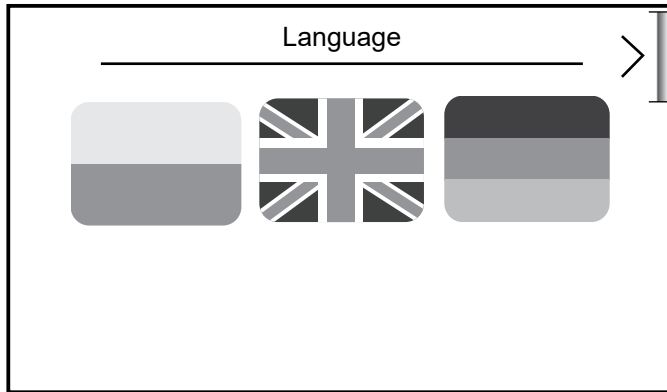

Figure 6-1: Language selection

2. Select required language preference and confirm with >.

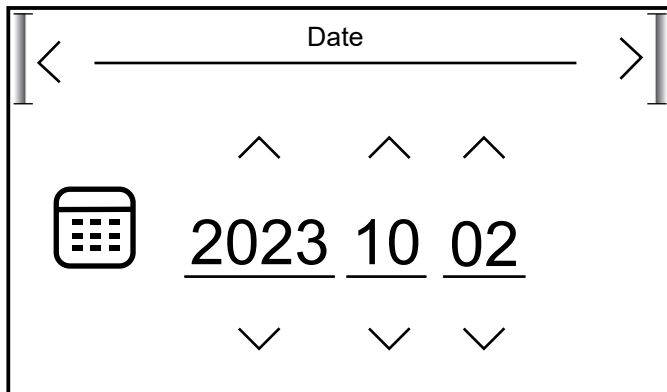

Figure 6-2: Setting date

3. Set the date. Tap the ^ & v to amend the values for year, day and month. Confirm with >. Refer to Figure 6-2.

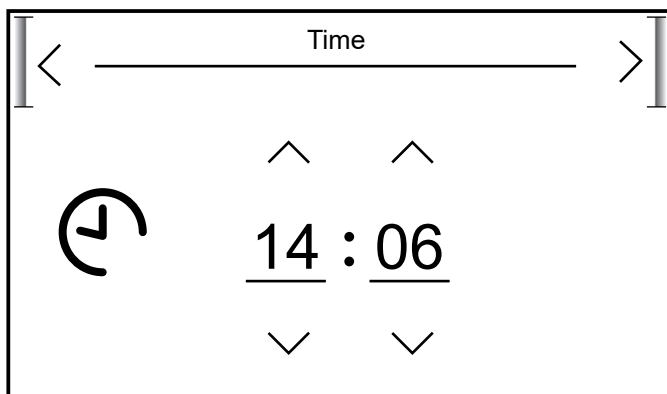

Figure 6-3: Setting time

4. Set the time. Tap the ^ & v to amend the time & confirm with >. Refer to Figure 6-3.
5. The touchscreen will progress to ask if you wish to start a configuration. Tap ✓ to start the configuration creator. Refer to Figure 6-4 and Section 6.2.

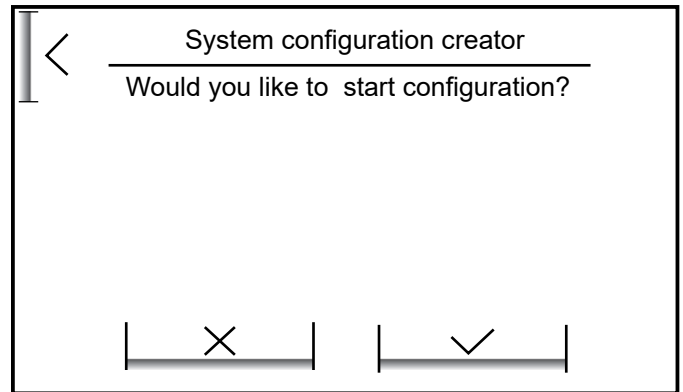

Figure 6-4: Configuration creator

6. If you tap X the controller will take you to the home screen and display 'No circuits defined'. Refer to Figure 6-5.

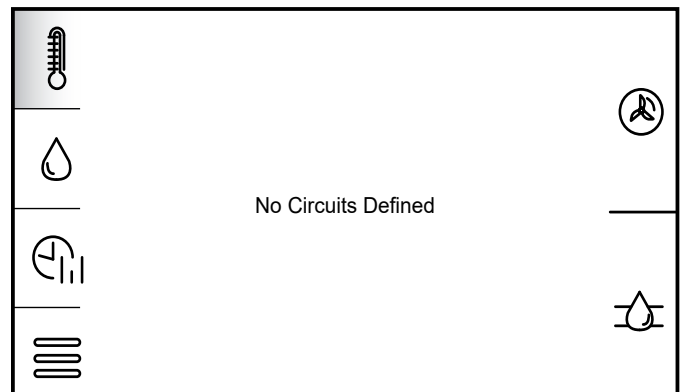

Figure 6-5: No circuits defined

7. To access the system configuration creator you need to access the settings menu / service settings menu. See Section 7 Table 7-1. The service settings password is 0000.

6.2 SYSTEM CONFIGURATION CREATOR

The Grant Aerona Smart Controller integrated system configuration creator will aid with the setup of the space heating and DHW system within the software of the touchscreen display. The steps in the configuration creator should reflect the system you have designed and electrically connected to the wiring centre. You must only configure components you have connected (Refer to Section 5 Figure 5-3 for wiring centre layout).

! NOTE !

Ensure you pay close attention to the devices you connect to the wiring centre and confirm for correct operation.

Using the system you have planned you can follow the system configuration creator steps to configure it within the Grant Aerona Smart controller. (Refer to Figure 6-6 for System configuration map).

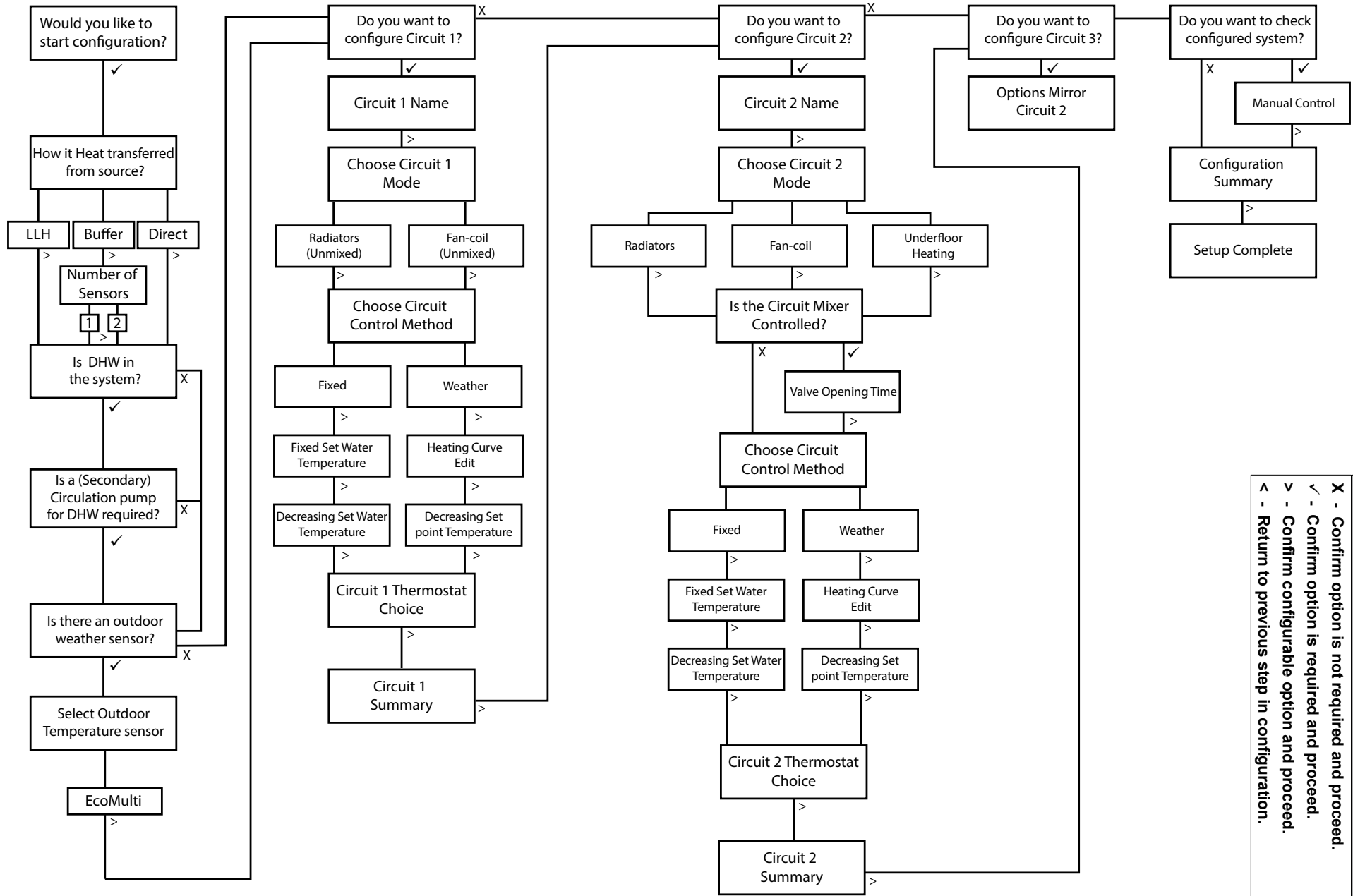

Figure 6-6: System Configuration Map

! NOTE !

- X - Confirm option is not required and proceed.
- ✓ - Confirm option is required and proceed.
- > - Confirm configurable option and proceed.
- < - Return to previous step in configuration.

- Would you like to start configuration?**
 If a system has already been Configured you will be prompted to confirm you wish to overwrite the previous setup.
- How is heat transferred from the source?**
 Confirm if you are using a Buffer/Volumiser, Low Loss Header that the Grant Aeron Smart controller will manage or if heat is transferred directly to the primary circuit.
- Is DHW in the system?**
 The Grant Aeron Smart controller will manage the DHW cylinder as well as prioritize DHW on a demand.
- Is Circulation pump for DHW in system?**
 This would be enabled if you require the Grant Aeron Smart controller to manage a secondary circulation pump.
- Is Outdoor temperature sensor in the system?**
 This will enable the weather control features of the Grant Aeron Smart controller.
- Source of Outdoor temperature sensor**
 Assign an Outdoor temperature sensor. The 'ecoMULTI' is the outdoor weather sensor supplied with your Grant Aeron Smart Controller kit and should be the only option you choose. Refer to Section 3.4.1.
- Do you want to Configure circuit 1, 2 or 3?**
 Configuration of Heating circuits. Circuit 1 is non-mixing and this is indicated with a note that Circuit 1 can not have a mixer.
- Circuit Name**
 To amend the name of a circuit e.g., 'Ground Floor' tap the change name button which will open a qwerty keyboard. To finish tap the enter key.
- Choose circuit mode**
 Assign the heating emitter type for the circuit. This could be 'Radiators' or 'Underfloor heating'.
- Choose circuit control method**
 Assign a control method from either 'fixed' or 'weather' control. Individual circuits can be assigned differing methods and can be amended later via the Circuit settings within the system settings menu.
- Fixed Set point water temperature (Fixed Control)**
 The circuit will operate on a fixed flow temperature. This is the default day flow temperature.
- Decreasing set point water temperature (Fixed Control)**
 This is the temperature the system flow will drop by on scheduled night/unattended periods.
- Heating curve edit (Weather Control)**
 Configure the heating curve for the calculative weather control adjustments for set-point temperatures. Refer to 6.4 for further information on editing the heating curve.
- Decreasing set point temperature (Weather Control)**
 This is the temperature the system flow will drop by on scheduled night/unattended periods.
- Will circuit be controlled with a Mixer?**
 Confirm if the circuit will be controlled by a motorised mixing valve. (Not applicable to Circuit 1)
- Mixing valve opening time**
 Configure the valve opening time to allow the software to be able to calculate the opening times for correct temperature mixing. (Refer to Appendix C for further information on the mixing valve).
- Circuit thermostat choice**
 Configure a thermostat to a circuit. A circuit could be uncontrolled, use the touchscreen display or a wired/wireless thermostat. If a wired/wireless is chosen, the touchscreen display will begin the pairing wizard to be followed to pair the individual thermostat to this circuit. Refer to Section 7.3.1.4. We recommend at least one circuit be controlled by the supplied touchscreen display.

- Circuit Summary**
 The circuit summary displays the parameters you have defined. The circuit structure displays as a pump but is a 230V switched live output (labelled on the wiring centre as H1-P, terminals 13 and 14). This could be connected to a 2-Port motorised valve as is common in the UK. (Refer to Section 5, Figure 5-3).
- Do you want to check configured system?**
 Confirming will activate the manual control function (Refer to Section 8 and Figure 8-2) on the touchscreen display. The components that you have configured via the creator will be shown on the screen. There will be both an icon on the operational button area and the terminal block numbers to which they should be wired to on. Refer to Section 5 for the terminal blocks and associated devices that they control. Tapping the icon will switch the internal relay and send a relevant voltage to activate.

6.3 WEATHER COMPENSATION

6.3.1 HEATING CURVE

Weather compensation can be enabled if an Outdoor Weather sensor is connected. The Outdoor Weather sensor should be enabled and select Regulation method as 'Weather'.

The circuit water target temperature is calculated based on the ambient temperature outside the building. The colder it is outside, the higher the water temperature in the circuit will be.

The heating curve is configured per circuit either during system configuration or via the service menu of the controller.

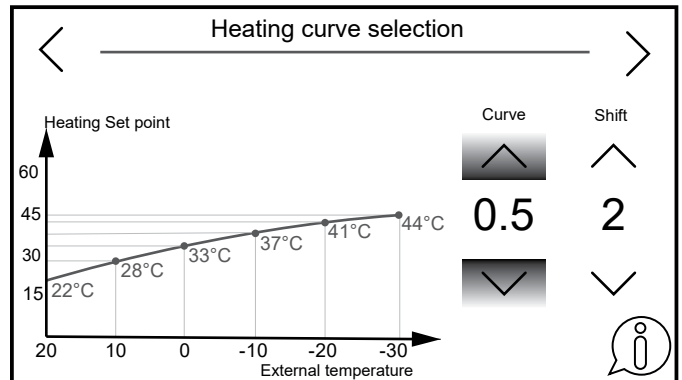

Figure 6-7: Heating curve adjustment

The heating curve selection will provide the line graph representing required target water temperature against outdoor air temperature (Refer to Figure 6-7).

- Tap \wedge or \vee of 'Curve' to align the curve to set a 45°C @ -5°C 'External temperature' as a starting point. Refer to Table 6-1 for recommended heating curve settings.
- To further adjust should the temperature points not be satisfactory, Tap \wedge or \vee of 'Shift' to move the set curve up or down.

Table 6-1: Recommended Heating Curve

Heat Emitter	Initial Curve Setting
Fan-Coil	1.2 - 1.6
Radiators	1.2 - 1.6
Underfloor	0.2 - 0.6

Refer to Section 6.3.2 for advice on how to further alter the heating curve.

The Grant Aeron Smart Controller can increase or decrease the Heat pump target flow temperature, calculated in accordance with the heating curve, if it exceeds the temperature range for the given circuit set in controller service menu.

6.3.2 HEATING CURVE ADJUSTMENT

The heating curve is adjustable and should be reviewed to ensure both comfort and economy.

The heating curve is set as part of the initial system configuration when configuring 'Weather' control but can be edited after the system configuration has been completed. Refer to Section 7.3.1.3 to access the heating curve setting adjustment, Figure 6-7 and Appendix F.7 for a QR code link to a how to video on adjusting the circuit heating curve.

Guidelines for adjusting a heating curve

- If the outdoor temperature drops, and the room temperature increases, the selected heating curve value is too high.
- If the outdoor temperature drops, and the room temperature drops as well, the selected heating curve value is too low.
- If during frosty weather the room temperature is comfortable, but when it gets warmer the room is too cold, it is recommended to increase the Heating curve shift and to select a lower heating curve.
- If during frosty weather the room temperature is too cold, and when it gets warmer the room is too hot, it is recommended to decrease the Heating curve shift and to select a higher heating curve.

Poorly insulated buildings or the use of traditional steel radiators require setting higher heating curves. Well insulated buildings and/or low temperature heat emitters e.g. Underfloor heating, heating curves will have a lower value.

6.4 CIRCUIT CONTROL SETTINGS

6.4.1 FIXED CIRCUIT CONTROL (Not weather compensated)

If the heat emitter size is known, set the required water temperature in the circuit using parameter 'Fixed preset water temperature', e.g., at a value of 50 °C. The value should allow the room to reach the required temperature.

After connecting the room thermostat, it is necessary to set a value of decrease in the Decreasing fixed water temperature parameter, e.g., to 3 °C. This value should be selected by trial and error. Upon activation of the room thermostat, the target circuit temperature will be decreased, which, if proper decrease value is selected will stop rise of temperature in the heated room.

6.4.2 WEATHER COMPENSATED CIRCUITS (Not Fixed)

The Outdoor weather sensor must be installed and configured to be able to use weather control. Using Heating curve shift, set target room temperature following the formula: Preset room temperature = 20°C + heating curve shift.

In this setup, it is possible to connect a room thermostat which will equalise the inaccuracy of set heating curve, if the selected heating curve value is too high. In such case, it is necessary to set the value of parameter Decreasing fixed water temperature, e.g., to 2 °C.

When the target temperature of the room thermostat is achieved, the Heat pump target flow temperature will be decreased, when pump blockade for that circuit is off. If pump blockade is on, the circuit pump/valve will close (if installed).

6.5 COMMON SETTINGS

After the system has been configured, check and if needed amend some common settings within the Heat pump parameters menu via the touchscreen display (Refer to Table 6-2).

To access the Heat pump parameters menu:

1. Tap the Settings menu and select 'Service settings' and enter the password: **1234**. Refer to Table 7-1 and Section 9 for full Heat pump parameters listing.

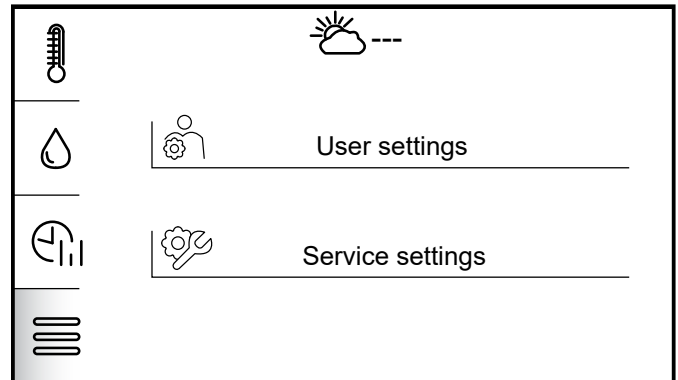

Figure 6-8: Settings menu

Table 6-2: Heat Pump parameters

Parameter No.	Parameter Title	Setting Value
Heat pump Set points		
21 00	Weather Comp	Off
Frost protection		
43 10	Frost Ambient Temp	Frost Ambient Temp on
43 11	Start Temp	4°C
43 12	Hys of Ambient Temp	3°C
43 20	Frost Flow Temp	ON
43 21	Start Temp	4°C
43 22	Hys of Flow Temp	3°C
Relay output settings		
51 07	DHW Cylinder Sensor	Off
51 09	Amb Temp Ext Sensor	Off
51 11	Buffer Temp Sensor	Off
51 15	Modbus	On

7 Touchscreen Display Operation and Settings

7.1 TOUCHSCREEN DISPLAY

The display is a capacitive touch screen and parameters are edited by touching the selected symbol or area on the display screen.

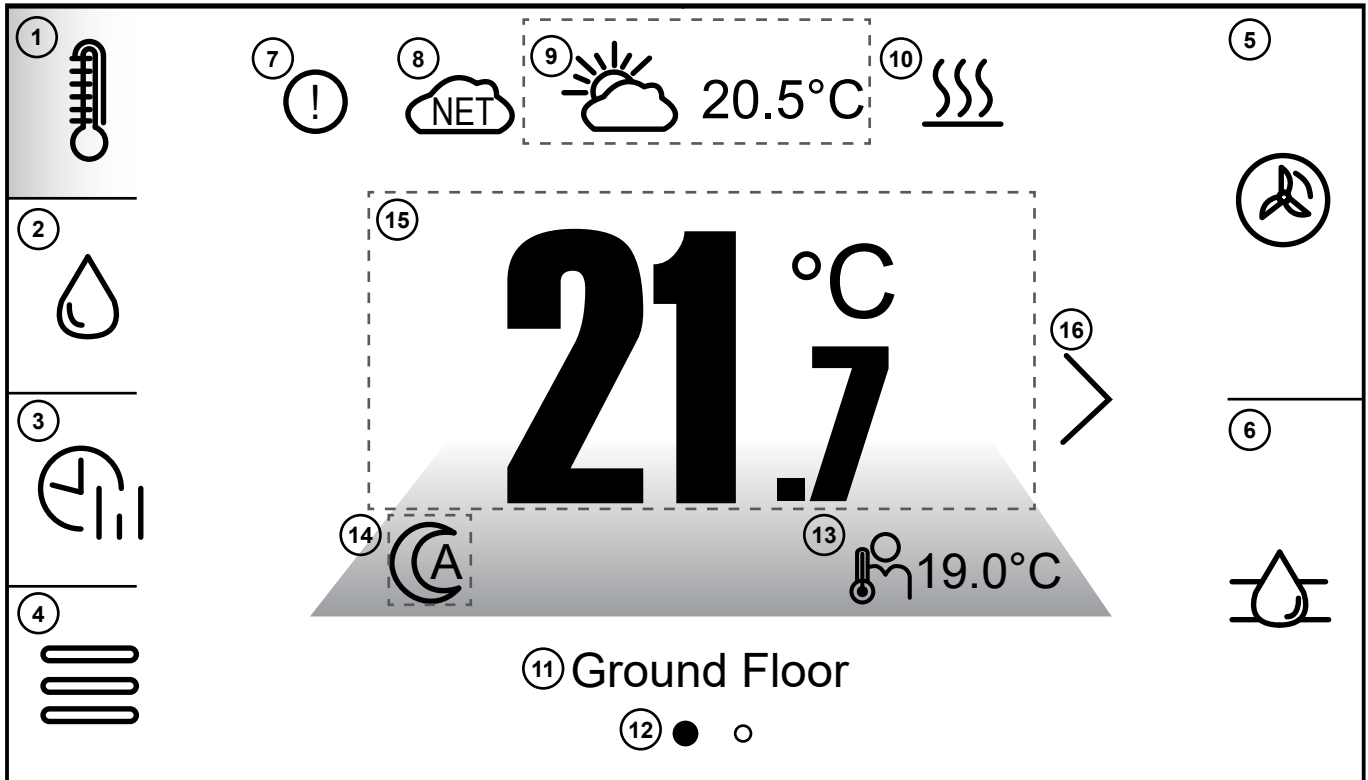

Figure 7-1: Display home screen example

Table 7-1: Touch screen

Number	Symbol	Description
1		Tap to access Heating circuit controls. Refer to Section 7.3.1.1
2		Tap to access DHW system controls. Refer to Section 7.3.2.1
3		Tap to access Schedule settings for Heating circuit(s), DHW cylinder and Heat Pump. Refer to Section 7.5.
4		Tap to access to Settings menu. Refer to Section 7.9
5		Tap to view Heat pump schematic. Refer to Section 7.6
6		Tap to access active system schematic. Refer to Section 7.7.
7		Indicates there are active alarms on the Smart controller.
8		Indicates active connection to EcoNet24 external server.
9		Outdoor temperature value (If outdoor weather sensor support is enabled in the service menu). Tap to view and amend Smart Controller work mode. Refer to Section 7.3.3.
10		Indicates an active heat demand.
11	Ground Floor	Circuit title/name
12		Circuit panes available (if more than 1 installed).
13		Circuit user set value.
14		Current circuit work mode. Tap to quick access the circuit work mode screen. Refer to 7.3.1.2 & 7.3.2.2
15	21.7°C	Current circuit temperature. Tap to access Circuit settings. Refer to 7.3.1 & 7.3.2.
16		Tap to move between multiple circuits (if installed) - The touchscreen can also be swiped to change circuits.

7.2 SMART CONTROLLER OPERATION

7.2.1 MAIN HEAT SOURCE

The Grant Aerona Smart controller manages the operation of the heat pump by activating or deactivating it according to demand for DHW or the space heating circuits.

7.2.2 HEAT CIRCUITS

The Grant Aerona Smart controller can manage the operation of one non-adjustable and up to two adjustable heat circuits. Water temperature in circuits can set as a fixed flow temperature or by weather, i.e., water temperature in the circuit is calculated in accordance with a temperature from the external temperature sensor. Despite varying outdoor temperature, a room temperature in heated rooms is kept on a set level.

- Dependent circuits – A thermostat assigned for many circuits. For example, temperature readings on a installed panel affect operation of both radiator and underfloor circuits. Commonly one Thermostat in a central location.
- Independent circuit – Connecting thermostats to measure room temperature independently and affecting assigned circuits. It is the way to obtain independency of the circuits, e.g., in case when one part of the building is used for the whole year and the second part is used periodically, e.g., for rent.

If multiple circuits are being controlled you can navigate between them with a swipe of the screen either to the left or the right.

7.2.3 DOMESTIC HOT WATER

The Smart Controller manages the operation of the Heat Pump and heating of a DHW cylinder up to a user set temperature. DHW operation can be programmed in time intervals with a minimum operation for disinfection mandatory. While the Smart Controller can also control a DHW secondary circulating pump, their use is not recommended to minimise wasted energy and running costs.

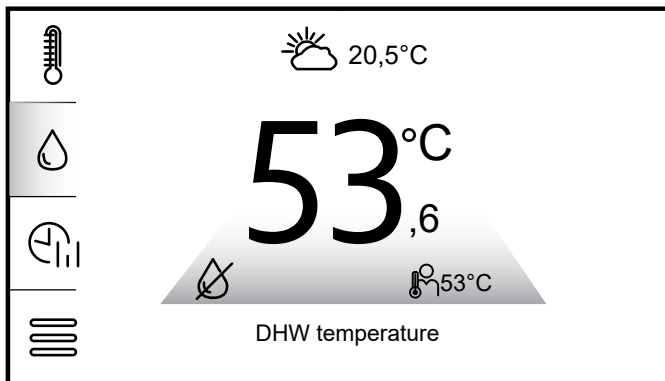

Figure 7-2: DHW temperature display example

! NOTE !

The change of the colour under the current value of the temperature of the circulation and DHW cylinder indicates whether the temperature is below (blue), above (red) or the same (green) as the target temperature. Grey indicates the DHW function is Off.

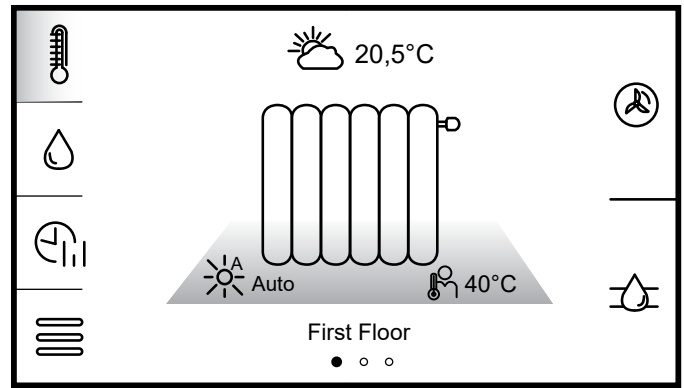

Figure 7-3: Thermostatically uncontrolled circuit display

! NOTE !

The circuit is not controlled by a thermostat if a heat emitter icon is displayed on the circuit temperature display screen.

7.3 CIRCUIT SETTINGS

Tapping the screen on the displayed information of the DHW or a heating circuit you are viewing (if more than 1 heat circuit installed) will open the circuit settings panel. This will display various options that can be edited. Refer to Figure 7-4.

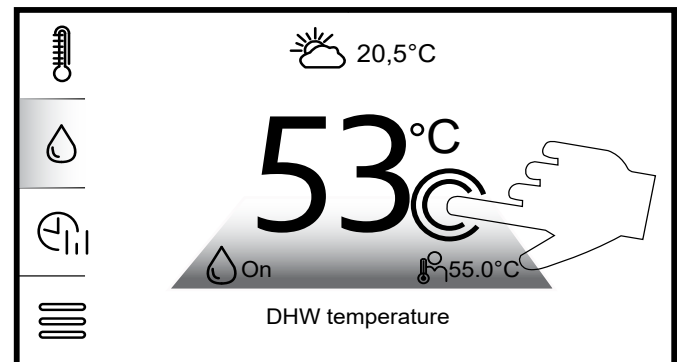

Figure 7-4: Circuit settings access on touch-screen

7.3.1.1 HEAT CIRCUIT SETTINGS

Entering Heat circuit settings will display options the used can edit for the heating circuit. Refer to Figure 7-5.

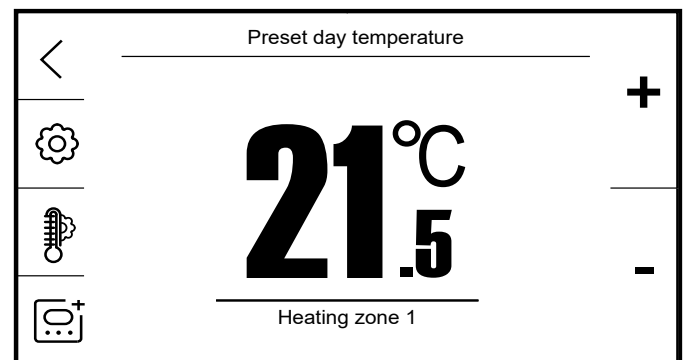







Figure 7-5: Heating circuit settings example





Table 7-2: Heating circuit settings

Button	Function description
	Navigate back to previous screen.
	Tap to amend Circuit work mode
	Tap to view & amend circuit details
	Tap to amend circuit thermostat choice
	Increase required circuit temperature
	Decrease required circuit temperature

7.3.1.2 CIRCUIT WORK MODE

The Circuit work mode sets the circuit to operate as per the consumer preference.

Table 7-3: Heating circuit work modes

Button	Function description
	Auto - Day/Night temperatures based on user schedule
	Off - Circuit will not be heated
	Day Mode - Circuit set to preset day temperature
	Night Mode - Circuit set to preset night temperature

7.3.1.3 HEATING CIRCUIT DETAILS

The heating circuit details panel will display settings of the circuit which you are viewing/editing. Refer to Figure 7-5.

- Circuit name – Name of the circuit, e.g., “Ground Floor”.
- Hysteresis – The value between when a thermostat switches off and back on. The parameter is only available when a thermostat is assigned to the circuit.
- Preset day temperature – The target air temperature for when the circuit is set to/scheduled to be in day mode (occupied). The parameter is available for editing only when a thermostat is assigned to the circuit.
- Preset night temperature (**Setback temperature**) – The target air temperature for when the circuit is set to/scheduled to be in night mode (overnight/unoccupied). The parameter is available for editing only when a thermostat is assigned to the circuit. The setback temperature should be configured to the ideal comfort level minus the temperature value shown in Table 7.4 below (based on heat emitters configured).

Table 7.4: Recommended setback air temperatures

Heat Emitter	Night mode setback value(°C)
Fan-Coil	3
Radiators	3
Underfloor Heating	1

- Heating curve – Adjust the heating curve and shift. Refer to Section 6.3.

7.3.1.4 HEATING CIRCUIT THERMOSTAT CHOICE





Circuit thermostat choice will allow a circuit thermostat to be reassigned. You will be prompted to confirm you wish to overwrite any existing thermostats installed. The options are: None, Control panel, Wired thermostat, Wireless thermostat.

- None: No Thermostat assigned
- Control Panel: Thermostat within Touchscreen display.
- Wired Thermostat: Wired thermostat (See Appendix A).
- Wireless Thermostat: Paired Wireless Thermostat (See Appendix B).

7.3.2.1 DHW SETTINGS

As per Figure 7-4 when on the DHW (if installed) you will navigate to the DHW settings.





Table 7-5: DHW settings panel

Button	Function description
	Navigate back to previous screen.
	Tap to amend DHW work mode
	Tap to access DHW additional settings
	Increase required circuit temperature
	Decrease required circuit temperature

7.3.2.2 DHW WORK MODE

DHW work modes give selectable modes as per the consumer preference but also have a optional boost function should the consumer wish (in the event of an expected increase in system demand).

Table 7-6: DHW work modes

Button	Function description
	Navigate back to previous screen.
	Boost - Tap to create a temporary DHW demand. Cylinder will be raised to user set value and then stop.
	On - DHW demand on temperature fall by hysteresis (Refer to Section 7.3.2.3)
	Off - Cylinder will not be heated
	Schedule - On/Off based on User schedule

Tapping 'Boost' will create a temporary DHW demand. The icon colour will change and remain blue until the cylinder reaches user set temperature. If you wish to stop this, Tap the boost icon again. The icon will change to grey to indicate it is off. If the cylinder is within its optimum temperature range the boost function will not activate

7.3.2.3 DHW ADDITIONAL SETTINGS

DHW additional settings provides a sub menu for the DHW cylinder hysteresis parameters & Legionella protection (If additional heater is configured - Refer to Section 7.4).

DHW Hysteresis is the amount of temperature drop from the user set temperature in the cylinder before the system will demand more heat in a scheduled ON time period.

If the hysteresis setting is too low this can cause potential cycling of the heat demand in an scheduled ON period. Too high can cause the cylinder to not reach desired temperature and higher energy useage.

7.3.3 CONTROLLER WORK MODE

The Grant Aerona Smart Controller work mode of the controller is selected by tapping the currently displayed symbol on the main screen in the place where the value of the outdoor temperature is displayed. (Refer to Table 7.1).

Table 7-7: Controller work mode

Mode	Description
AUTO	Automatically switches on or off the heating-cooling mode (Cooling not available with Aerona R32 heat pump range), depending on the external temperature.
SUMMER	Adjustable circuit performs the cooling function. (Cooling not available with Aerona R32 heat pump range)
WINTER	Adjustable circuit performs the heating function.

7.4 LEGIONELLA PROTECTION

The Grant Aerona Smart controller has the function to provide protection against legionella by executing a scheduled temperature increase. This is executed on a weekly basis from within the Grant Aerona Smart controller settings.

For protection against legionella the DHW cylinder needs to be periodically raised to a minimum of 60°C to ensure it is sterilised of any present legionella bacteria.

Care must be given to vulnerable people who may be exposed to potentially life-threatening legionella. This group of people include the elderly, pregnant women, young children and those with breathing difficulties. Where legionella disinfection is required more frequently than once a week, this must be provided by other means.

It is important that this decision is based on the welfare of the occupants and not on energy saving measures.

! WARNING !

If the hot water stored in the cylinder has not been used for a prolonged period of time (e.g., a few days) and has not been stored at 60°C, then it is important that the temperature is raised to at least 60°C for a period of one hour before using the hot water.

7.4.1 ENABLING DHW HEATER SUPPORT

'DHW heater' support must be enabled within the system settings menu of the controller for 'disinfection' to be available.

1. Tap the Settings Menu button.
2. Tap 'Service settings' and input the password: '0000'. Tap 'Enter' to confirm.
3. Tap 'Installation controller'.
4. Swipe the touchscreen to move down and tap 'Heaters'
5. Tap the button next to 'DHW Heater' to enable heater support.
6. Tap and set 'DHW Delay' to '75mins' and confirm. (To prevent the Immersion heater from operating during a scheduled DHW demand period).
7. Tap '<' to navigate back.

7.4.2 CONFIGURING LEGIONELLA SETTINGS

Once DHW heater support has been enabled:

1. Navigate to the DHW circuit screen.
2. Tap the displayed temperature for the cylinder to enter the DHW circuit settings.
3. Tap 'DHW additional settings' (Refer to Table 7-5).
4. Tap the button next to 'disinfection'. This will expand the display for the individual settings for legionella protection for configuration.
 - 'Day' - Day to execute Legionella protection.
 - 'Start Hour' - Time to start.
 - 'Preset temp' - Temperature for DHW cylinder to heat to. (Should not exceed 60°C).

! NOTE !

Legionella protection works independently of the DHW cylinder schedule and will start even if DHW cylinder is scheduled off.

7.4.3 LEGIONELLA DISINFECTION SCHEDULING

Legionella disinfection should be scheduled in a window that is a minimum of 1 hour after a DHW demand and in a setback heating demand period e.g. Overnight. This is to avoid the least amount of loss in the heating circuits.

The Legionella protection can not be run twice in a week should the schedule be changed within the settings.

7.5 TIME SCHEDULES

The Grant Aerona Smart Controller allows for programmable time schedules for the Heating Circuit(s), DHW and the Heat pump itself.

In the situation when the consumer is not at home or at night, the controller can decrease the amount of supplied heat which affects electric consumption.

Time schedules can be set separately for each day of the week or copied across multiple days. If the space is unoccupied Monday to Friday for the same time periods the user could set the hours for Monday and then apply to multiple days.

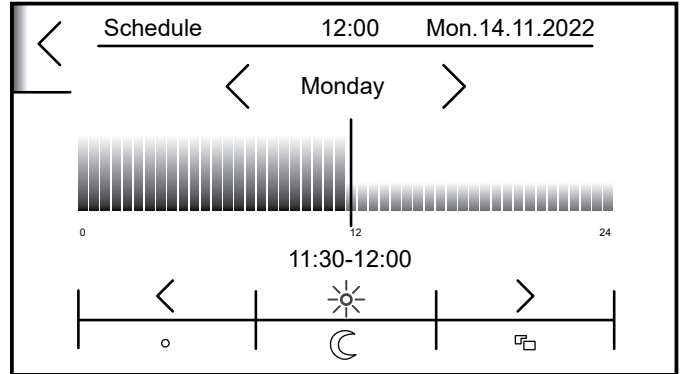

Figure 7-6: Heating time schedule interface

! NOTE !

The ON/OFF time schedule is defined separately for the heat pump and DHW cylinder.

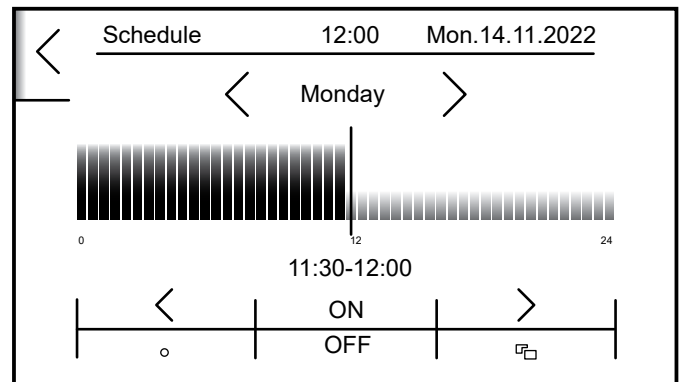

Figure 7-7: DHW/Heat pump time schedule interface

Table 7-8: Time schedule controls

Button	Function description
	Navigation Arrows - Weekday selection and time period selection. Navigate the required day or move selected time period in the specified direction.
	Copy to - Copy the currently set schedule to one or multiple days
	Preset Night mode (Setback Temperature) - Target night temperature for circuits will be applied if a thermostat is assigned to the circuit. If not, the decrease will be set to the value of the Water temperature decrease.
	Preset Day mode - Target day temperature setting for circuits will be applied, if a thermostat is assigned to the circuit.
ON	Option is Configured 'ON'
OFF	Option is Configured 'OFF'

7.5.1 HEATING CIRCUIT SCHEDULE

The schedule for the heating circuit(s) controls the specific time period at which the target day and night temperatures are applied.

To amend a heating schedule:

1. Tap the time schedule menu (Refer to Figure and Table 7-1). The schedule icon is available regardless of which circuit or device you are currently viewing.
2. Tap the heating circuit you wish to amend from the options.
3. Modify the day if different to current by tapping navigation arrow. Refer to Figure 7-6.
4. Tap the night mode function and use the navigation buttons to move to the first time period you wish to change (if more than one).
5. Tap day mode and use the right navigational button to alter the time periods. Switch between day and night mode for unoccupied portions of the day.
6. After defining the required time schedule it can be applied to multiple days. Tap 'Copy to' and tap the days required. Refer to Table 7-8. Confirm with ✓.

7.5.2 DHW SCHEDULE

The schedule for the DHW cylinder will turn the cylinder heating function from the heat pump on or off on the selected time period. If the cylinder temperature falls below hysteresis value in an off time period the heat pump will not activate.

To amend the DHW schedule:

1. Tap the time schedule menu (Refer to Figure and Table 7-1). The schedule icon is available regardless of which circuit or device you are currently viewing.
2. Tap 'DHW'.
3. Modify the day if different to current by tapping navigation arrow. Refer to Figure 7-7.
4. Tap the 'OFF' function and use the navigation button to move to the first time period you wish to change. (if more than one).
5. Tap 'ON' and use the right navigational button to alter the time periods. Switch between 'ON and 'OFF' to create multiple intervals based on end-user requirements
6. After defining the required time schedule it can be applied to multiple days. Tap 'Copy to' and tap the days required. Confirm with ✓. Refer to Table 7-8.

We recommend to schedule up to 4 x 1 hour on periods in a day with a minimum gap of 1 hour between each.

7.5.3 HEAT PUMP SCHEDULE

The schedule for the heat pump will disable the heat pump from activating in the off periods

To amend the Hheat pump schedule:

1. Tap the time schedule menu (Refer to Figure and Table 7-1). The schedule icon is available regardless of which circuit or device you are currently viewing.
2. Tap 'Heat source'.
3. Modify the day if different to current by tapping navigation arrow. Refer to Figure 7-7.
4. Tap the 'OFF' function and use the navigation button to move to the first time period you wish to change. (if more than one).
5. Tap 'ON' and use the right navigational button to alter the time periods. Switch between 'ON and 'OFF' to create multiple intervals based on end-user requirements
6. After defining the required time schedule it can be applied to multiple days. Tap 'Copy to' and tap the days required. Confirm with ✓. Refer to Table 7-8.

We recommend you leave the Heat pump enabled 'ON' at all times. This does not mean the heat pump will be running continually.

! NOTE !

The heat pump schedule will override all other schedules and could cause unwanted heat loss within the space heating or DHW circuits.

7.6 HEAT PUMP SCHEMATIC

The heat pump schematic gives a visual preview of the basic operating functions of the heat pump such as working status, Flow/return temperatures as well as being able to configure the operating mode of the heat pump in relation to the system installed.

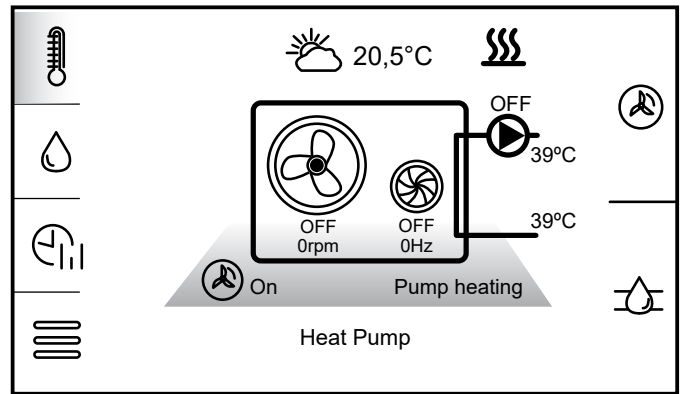





Figure 7-8: Heat pump scheme interface

The heat pump operating modes are accessed by tapping the heat pump scheme icon. Refer to Table 7-9 and Figure 7-8.

Table 7-9: Heat Pump Status

 ON	The heat pump is turned on.
 OFF	The heat pump is turned off regardless of the conditions in the system.
 SCHEDULE	The heat pump is switched on and off according to the set time schedule for the heat pump.

7.7 SYSTEM SCHEMATIC

The system scheme display shows the scheme of the installed and configured system. Icons will change from white to green to indicate they are active such as a motorised valve or the Heat pump. Refer to Figure 7-9 for system schematic example.

Installed diverter valves will indicate via the symbol which direction it is causing the heat to travel. Mixer valves will display a % figure to show their open status.

The system schematic also displays water temperatures from installed sensors (DHW Cylinder, Buffer, Low-Loss Header, Water temperature sensors on adjustable circuits).

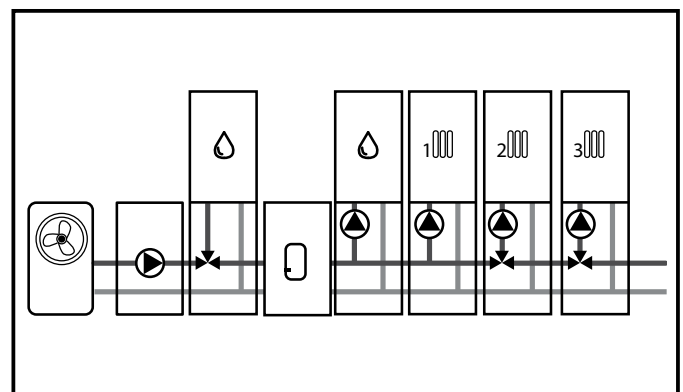

Figure 7-9: System schematic display

! NOTE !

The view of the system schematic depends on the enabled support for the individual circuits, DHW cylinder or buffer installed.

7.8 CIRCUIT CONTROL

The 3 available heating circuits in the Grant Aerona Smart controller are connected and controlled via the following terminals within the wiring centre (Refer to section 5).

Table 7-10: Circuit terminals

Heating circuit	230V Pump/Valve Terminals
1	13(L) & 14(N)
2	15(L) & 16(N)
3	17(L) & 18(N)

Each heating circuit can either have a circulation pump or motorised valve connected to it.

In a conventional system the thermostat (or sensor) will stop the pump or close valve when the actual circuit air temp reaches the target circuit air temp.

7.8.1 THERMOSTATIC PUMP BLOCKADE

If a thermostat has been installed on any heating circuit, you have the following choices in how to control that circuit:

- With pump blockade 'ON'** - Each heating circuit thermostat will control the circuits circulation pump or motorised valve (whichever is installed) for that circuit based on the air temperature the sensor/thermostat is monitoring.
- With pump blockade 'OFF'** - The heating circuit will continue to have circulation pump or motorised valve enabled (whichever is installed) but the smart controller will drive down the flow temperature to the minimum value to maintain the target air temperature within the circuit i.e the circuit remains active. This option would be best suited for open loop room optimisation.

7.8.1.1 ENABLE THERMOSTATIC PUMP BLOCKADE

To enable Thermostatic pump blockade for a circuit:

- Tap the Settings menu and then 'Service settings'. Enter the password: 0000 on the keypad provided and tap 'Enter'. Refer to Table 7-1 and Section 8 for full Service settings parameters listing.

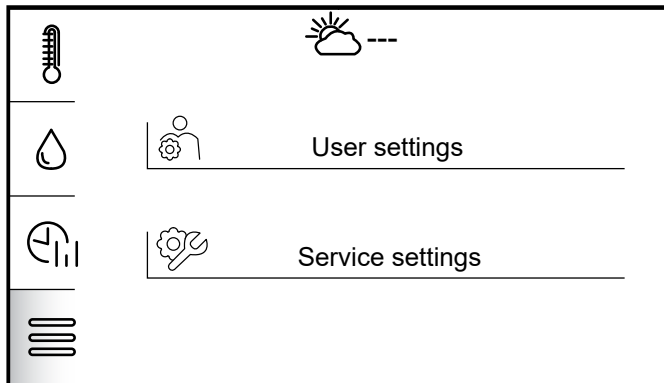

Figure 7-10: Service Settings menu

- Tap 'Installation controller'
- Swiping the Touchscreen display scroll down to the desired circuit and select by tapping. (Refer to Figure 7-11).

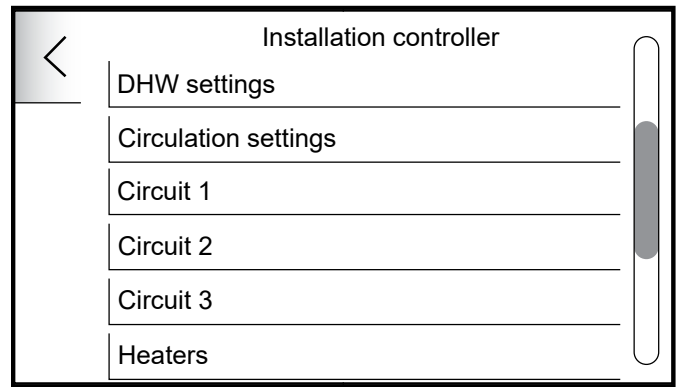

Figure 7-11: Installation controller menu

- Swiping the touchscreen display scroll down to 'Thermostatic pump blockade'. Tap the icon to switch on. (Refer to Figure 7-12)

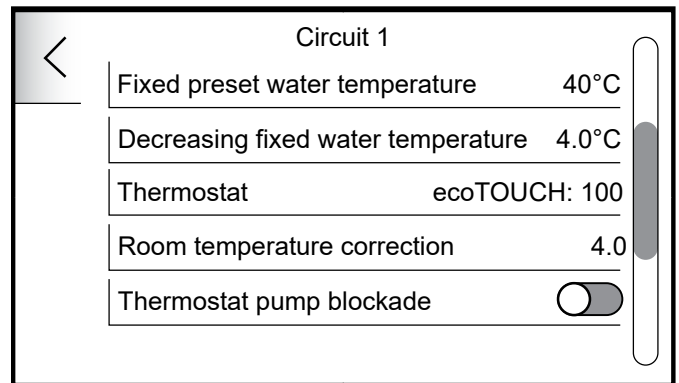

Figure 7-12: Edit Circuit 1 settings

Tap the < button to navigate backwards to the home screen.

7.8.2 CIRCUIT STOP FROM PRESET TEMP

If a water temperature sensor has been installed on a mixing circuit, you have the ability to control that circuit based on the circuit flow temperature value.

- With Circuit stop from preset Temp 'ON'** - The water temperature sensor will monitor the water temperature of the flow into the circuit from the heat pump and directly control the circuits circulation pump or motorised valve closed when the target water temperature is achieved.
- With Circuit stop from preset Temp 'OFF'** - The heating circuit will continue to have circulation pump or motorised valve enabled (whichever is installed) but the smart controller will drive down the flow temperature to the minimum value to maintain the target water temperature within the circuit i.e the circuit remains active. This option would be best suited for open loop room optimisation.

7.8.2.1 ENABLE CIRCUIT STOP FROM PRESET TEMP

To enable Circuit stop from preset temp for a circuit:

- Tap the Settings menu and then 'Service settings'. Enter the password: 0000 on the keypad provided and tap 'Enter'. Refer to Table 7-1 and Section 8 for full Service settings parameters listing.
- Tap 'Installation controller'
- Swiping the Touchscreen display scroll down to the desired circuit and select by tapping. (Refer to Figure 7-11).
- Swiping the touchscreen display scroll down to 'Circuit stop from Preset temp'. Tap the icon to switch on. (Refer to Figure 7-13).

! NOTE !

'Pump only' will need to be enabled. If a mixer is installed, 'Circuit stop from preset temp' will not be available.

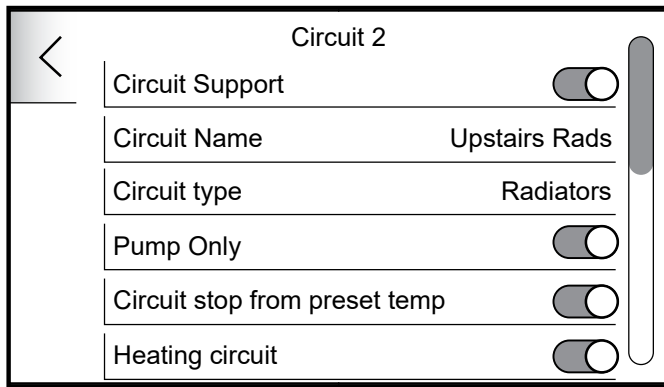

Figure 7-13: Edit Circuit 2 settings

Tap the < button to navigate backwards to the home screen. Irrespective of whether pipe sensors are used or not, the space heating performance can be adjusted based on user comfort levels using either the Smart controller or via ecoNET24. (Refer to Section 6.3.2 for Heating curve adjustment guidance)

7.9 USER SETTINGS MENU

User settings can be accessed via the settings menu from the touchscreen display. (Refer to Figure and Table 7-1 and Figure 7-14).

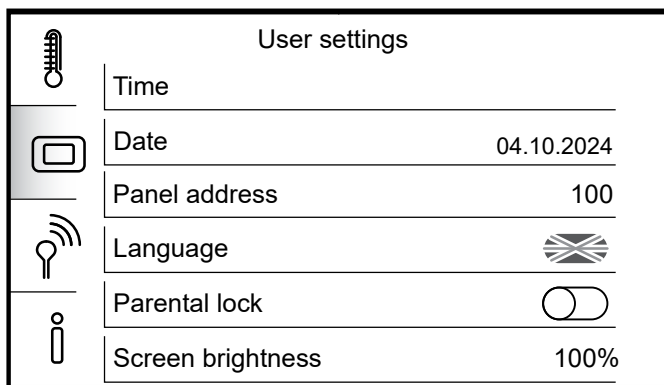

Figure 7-14: User settings menu

- Time - Time will synchronise with paired thermostats.
- Date
- Panel Address
- Language - Menu language selection.
- Parental Lock - The lock will activate after 5 minutes of inactivity. Unlocking the screen is possible after pressing down the screen for 5 seconds.
- Screen Brightness
- Screen saver - Choose screen saver display: None, Empty, Time, Time and Temps.
- Time to screen saver on
- Brightness in screen saver.
- Alarm sound - Enable/Disable Alarm sounds.
- Key sound - Enable/Disable Key sounds.
- Panel temperature correction.

! NOTE !

The temperature in the room should be measured with an additional temperature sensor and the difference between this measurement and the temperature value displayed by the Touchscreen display should be entered into the value of this parameter.

Tapping the radio icon symbol (Refer to Figure 7-14):

- ecoNET configuration wizard - Wizard configuration of the Wi-Fi Hub.
- ecoNET status - LAN - connection status of Wi-Fi and ecoNET web services
- Wi-Fi settings - configuration of connection with Wi-Fi Hub. Connection of Wi-Fi and its configuration is described in this manual. Parameters that should be set by the user: SSID, Security type and network access password.

Tapping the **i** symbol (Refer to Figure 7-14):

- Displays diagnostic information about the operation of the controller, Alarms list, Firmware version and updating (e.g., serial number) UID and ISM .

7.10 STORED SYSTEM SETTINGS

The Grant Aeron Smart controller can store and recall a default system setting scheme within its memory.

Once the system has been installed and commissioned the applied settings (including demand schedules and Legionella protection) can be stored within the Grant Aeron Smart controller. This can be recalled if a setting is perhaps inadvertently changed causing issues with the system.

7.10.1 SAVE A SYSTEM DEFAULT

To store the currently set system as a default you will need to:

1. Tap the Settings menu and tap 'Service settings'. Input the relevant password on the keypad and tap enter. (Password: 0000 - Refer to Section 8).
2. Tap 'Installation controller'.
3. Swipe the screen to scroll down to the bottom and tap 'Default settings'.
4. Tap 'Save current settings as default'.

7.10.2 RESTORE SYSTEM DEFAULT

To restore the currently saved default to the Smart Controller:

1. Tap the Settings menu and tap 'Service settings'. Input the relevant password on the keypad and tap enter. (Password: 0000 - Refer to Section 8).
2. Tap 'Installation controller'.
3. Swipe the screen to scroll down to the bottom and tap 'Default settings'.
4. Tap 'Restore default'.

Any paired thermostats will need to be re-paired after a system default has been restored. The memory will clear if unpowered for an extended period of time.

Service Settings (Password: 0000)
Installation control
System configuration creator
Alarm list

Weather sensor
External temp. sensor support
Temp. sensor source
SUMMER mode activation temperature
WINTER mode activation temperature

Main heat source
DHW temp. correction
Circuit temp. Correction
Set-point temp. correction – heating

Heaters
Buffer heater
DHW heater

Flow meter
Flow meter
Specific Heat capacity
Time detect*
Time alarm erase*
No flow detection threshold*
No flow detection hyst.*
Pulse rate
Pulse counting time*
Too often alarm*

Installation control
Manual control
Weather sensor
Hydraulic scheme
Main heat source
Buffer settings*
Low Loss Header settings*
DHW settings
Circulation settings*
Circuit 1-3
Heaters
Flow meter*
Additional Modules
Default settings

Buffer settings
Buffer operation type
Preset temperature
Preset temperature hysteresis
Heating installation start temp.

Low Loss Header settings
Additional temp. sensor
Water preset temperature
Preset temperature hysteresis

DHW settings
DHW support

Circulation settings
Circulation support
Circulation operation time
Circulation pause time
Start from temperature
Pump start temperature

Default settings
Restore default settings
Save current settings as default

Circuit 1
Circuit support
Circuit name
Regulation method
Work mode
Heating circuit
Fixed preset water temperature
Decreasing fixed water temperature
Heating Curve
Decrease water temperature
Thermostat
Room temperature correction
Thermostat pump blockade*

Circuit 2&3
Circuit support
Circuit name
Circuit type
Pump only
Circuit stop from preset Temp.
Heating circuit
Regulation method
Work mode
Decrease water temperature
Minimal Temp.
Maximum Temp.
Heating curve
Thermostat
Room temperature correction
Thermostat pump blockade
Valve Opening Time (UFH)
Mixer deadband zone (UFH)
Proportional range (UFH)
Intergration time constant (UFH)

8 Service Settings - Installer

Figure 8-1: System settings menu map

! NOTE !
 Items within the menu will change depending on configured system.

8.1 SERVICE SETTINGS

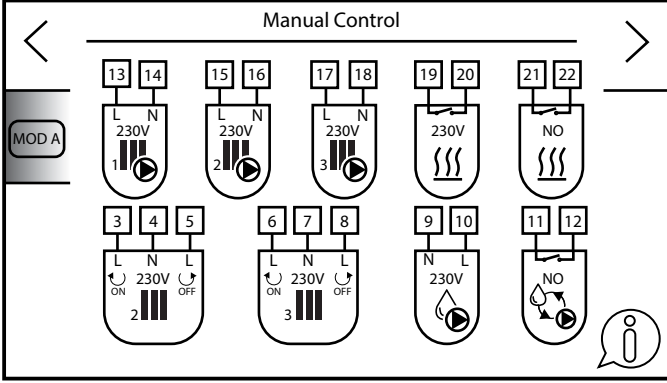
Parameter	Description
Installation control	Top level menu function (See previous page)
System configuration creator	The creator assists with the configuration of the parameters of the controller when it is started. Depending how you answer each question, subsequent questions about the parameters may differ. (Refer to Section 6) Note: All parameters in the creator are available in the service menu.
Alarm list	Displays a list of alarms reported by the controller.
Manual control	<p>The manual control menu enables activation of individual heating system components to conduct operation tests. Turning on or off particular selected device is done by tapping the symbol on the screen.</p> <p>Note: the controller does not check protection logic, so this menu should be used with awareness of starting outputs in order to avoid damaging the controller and devices connected to its terminals. Long and uncontrolled operation of devices (e.g., pumps) may result in damage.</p>  <p style="text-align: center;">Figure 8-2: Manual Control</p>
Weather sensor	<p>The menu contains settings for an weather external sensor.</p> <ul style="list-style-type: none"> External temp. sensor support - enabling or disabling support for the external (weather) temperature sensor. Temp. sensor source - selection of external temperature sensor depending on its connection: ecoMULTI, Heat pump. Summer mode activation temperature - ambient temperature at which summer mode is activated. Winter mode activation temperature - ambient temperature at which summer mode is deactivated.
Hydraulic Scheme	Selection of a supported hydraulic system scheme for the heat pump. Options: Direct, Buffer, Low Loss Header.
Main heat source	<p>This menu contains settings related to the heat pump.</p> <ul style="list-style-type: none"> DHW temp. correction - increase of the target DHW temperature in heating mode. Circuit temp. correction - Adjustable Circuit temperature correction value. Set-point temp correction – heating – increase of the target heat pump temperature in heating mode.
Buffer settings (if selected)	<p>This menu contains settings for the heat buffer.</p> <ul style="list-style-type: none"> Buffer operation type - selection of the number of sensors with which the buffer will work. To choose from: One sensor, Two sensors. Preset temperature - Target buffer temperature value. Preset temperature hysteresis - Temperature value drop from preset temperature at which the buffer is heated. Heating installation start temp. - Temperature value at which the circuit pumps will be switched on.
Low Loss Header settings (if selected)	<p>This menu relates to settings for a Low Loss Header.</p> <ul style="list-style-type: none"> Additional temp. sensor – Enable Low Loss Header temperature sensor connected to the controller (lower buffer temperature sensor). If the operation is switched off, the temperature value is measured on the return. Preset temperature – Target temperature of water in the Low Loss Header. Preset water hysteresis – Temperature value drop from preset temperature at which the Low Loss Header is heated.
DHW settings	<p>This menu relates to settings for the DHW cylinder.</p> <ul style="list-style-type: none"> DHW Cylinder – enable/disable DHW cylinder
Circulation settings (DHW)	<p>This menu contains parameters related to the operation of a DHW secondary circulation pump.</p> <ul style="list-style-type: none"> Circulation support - turn on/off Secondary circulation support. Circulation operation time - the DHW circulation pump operation time. It determines the working time after a break in the circulation pump operation. The DHW circulation pump operates periodically. Circulation pause time - the DHW circulation pump pause time. Defines the time interval between activations of the circulation pump. The DHW circulation pump operates periodically. Start from temperature - activation or deactivation of the circulation pump operation depending on the DHW cylinder temperature. Pump start temperature - in order to save energy, the circulation pump will be turned off when the temperature of the DHW cylinder is lower than the Pump start temp.
We do not recommend the use of Secondary circulation in domestic installations.	

! NOTE !

When configuring the system for the first time, it is recommended to use the system configuration creator.

! NOTE !

During the initial setup the smart controller disables support for all heating circuits, DHW cylinder, buffer, and circulation pumps. Depending on the hydraulic system used, these circuits must be turned on.

Parameter	Description
Circuit 1	<p>This menu contains parameters related to operating the non-adjustable circuit. The non-adjustable circuit 1 preset temperature will be automatically increased in order to guarantee heat for adjustable circuits 2 and 3.</p> <ul style="list-style-type: none"> • Circuit support - turn on or off circuit support. • Circuit name - name of the circuit set by user. • Circuit type - This menu contains parameters related to selecting the type of a non-adjustable circuit. <ul style="list-style-type: none"> - Radiators - Fan-coil • Regulation Method <ul style="list-style-type: none"> - Fixed - constant set temperature of water in the non-adjustable circuit is maintained. - Weather - Water temperature is related to Outdoor weather sensor. Outdoor weather sensor required • Work Mode <ul style="list-style-type: none"> - OFF - Day – setting higher target circuit temperature. - Night – setting lower target circuit temperature. - Schedule – Day or Night mode is set depending on the time schedule. • Heating circuit - switching the Heating Circuit On/Off. • Fixed preset water temperature - Heat pump stops when fixed preset water temperature is reached. • Decreasing fixed water temperature - If Regulation method is fixed value of temperature decrease for night mode. • Heating Curve - View and adjust the heating curve for the circuit if the circuit is weather compensated • Decrease water temperature - Flow temperature drop when in night mode if the circuit is weather compensated. • Thermostat - Thermostat in control of circuit. Assignable options: None, Room panel, Wireless thermostat, Wired thermostat. • Room temperature correction – with thermostat support enabled automatic correction of room temperature is carried out in accordance with the following formula: <ul style="list-style-type: none"> - Target temperature with correction = Target temperature of the circuit + (Target temperature of the thermostat assigned to the circuit minus Current temperature of the thermostat assigned to the circuit) x Room temperature correction. - By default, the Room temperature correction value is 4.0, and the value range is 0 - 10. It is necessary to find appropriate value of the Room temperature correction. The higher the coefficient, the greater the correction of target circuit temperature. If the setting is “0”, the target circuit temperature is not corrected. Note: setting a value of the room temperature coefficient too high may cause cyclical fluctuations of the room temperature. • Thermostat Pump Blockade - Parameters for the circuit pump being disabled when a room thermostat is active for the circuit. Refer to Section 7.8. <ul style="list-style-type: none"> - OFF - When the target air temperature is met or exceeded, the circuit pump is not disabled. - ON - When the target air temperature is met or exceeded, the circuit pump is disabled.
Circuit 2 & 3	<p>Circuit 2 & 3 contain similar functions to Circuit 1 and are dynamic based on the configured system. Below are additional options for Circuit 2 and 3.</p> <ul style="list-style-type: none"> • Circuit type - This menu contains parameters related to selecting the type of a adjustable circuit. <ul style="list-style-type: none"> - Radiators - Fan-coil - Underfloor heating • Pump only - Enables or disables the mixing function on the circuit. <ul style="list-style-type: none"> - No – The circuit is mixer controlled. (Options for Mixer setup will be available in the Circuit menu) - Yes – The circuit is not mixer controlled. (Circuit stop from preset temp will become active). • Circuit stop from preset temp - Parameters for a circuit pump being disabled based on water temperature values. <ul style="list-style-type: none"> - No – When the target water temperature value is exceeded, the circuit pump/valve is not disabled. - Yes – when the target water temperature value is exceeded, the circuit pump/valve is disabled. • Minimum temperature - Minimum target water temperature in the adjustable circuit. • Maximum temperature - Maximum target water temperature in the adjustable circuit. If the Maximum temperature is greater than 60°C, the controller will take 60°C as a maximum value. • Valve opening time - The time between fully open and closed on installed mixing valve. • Mixer deadband zone - Temperature insensitivity of mixer adjustment. • Proportional Range - Mixer actuator proportional movement. • Integration time constant - Time for actuator reaction for temperature deviation.
Heaters	<p>This menu contains parameters related to the operation of the DHW heater and buffer heater support.</p> <ul style="list-style-type: none"> • Buffer heater - enabling or disabling the buffer heater support. • Buffer heater (delay) - delay time for switching on the buffer heater after a heat pump demand. • DHW heater - enabling or disabling the DHW heater support. Output to Smart Immersion Relay. Refer to • DHW heater (delay) - delay time for DHW heater ON from DHW demand start. <p>The options below apply to both buffer and/or DHW heater support when configured.</p> <ul style="list-style-type: none"> • Outside temp to activate the heater - external temperature value beyond which the DHW heater will be activated. • Outside temp force the heater - external temperature value at which the heater support will be permanently switched on during heat pump operation.
Flow meter	<p>This menu contains parameters related to the operation of the flow meter operation and the detection of no flow. Refer to Appendix E.</p> <ul style="list-style-type: none"> • Flow meter - Flow detection is performed by selected option. (Default/Pulse) • Default flow meter - default flow in the circuit, when exceeded, a no-flow alarm will be reported. • Specific Heat Capacity - Coefficient of liquid used to transfer heat. • Time detect - time after which the no-flow alarm will be reported. • Time alarm erase - time after which the no-flow alarm will be reset. The controller will not report an alarm. • No flow detection threshold - flow value below which the alarm “Flow error” will be reported. • No flow detection hysteresis - if the actual flow rises above the value of No flow detection threshold plus No flow detection hysteresis, the “Flow error” alarm will be turned off. • Pulse rate - Flow sensor pulse rate to calculate flow. • Pulse counting time - Flow sensor pulse count time duration. • Too often alarm - too frequent no-flow alarm detection threshold. It allows to limit the frequent reporting of the no-flow alarm.
Default Settings	<p>This menu saves and recalls stored defaults applied by the consumer.</p> <ul style="list-style-type: none"> • Restore default settings - Recall and apply saved default settings. • Save current settings as default - Saves the current setup of the Grant Aerona Smart controller to memory.

9 Heat Pump Parameters - Installer

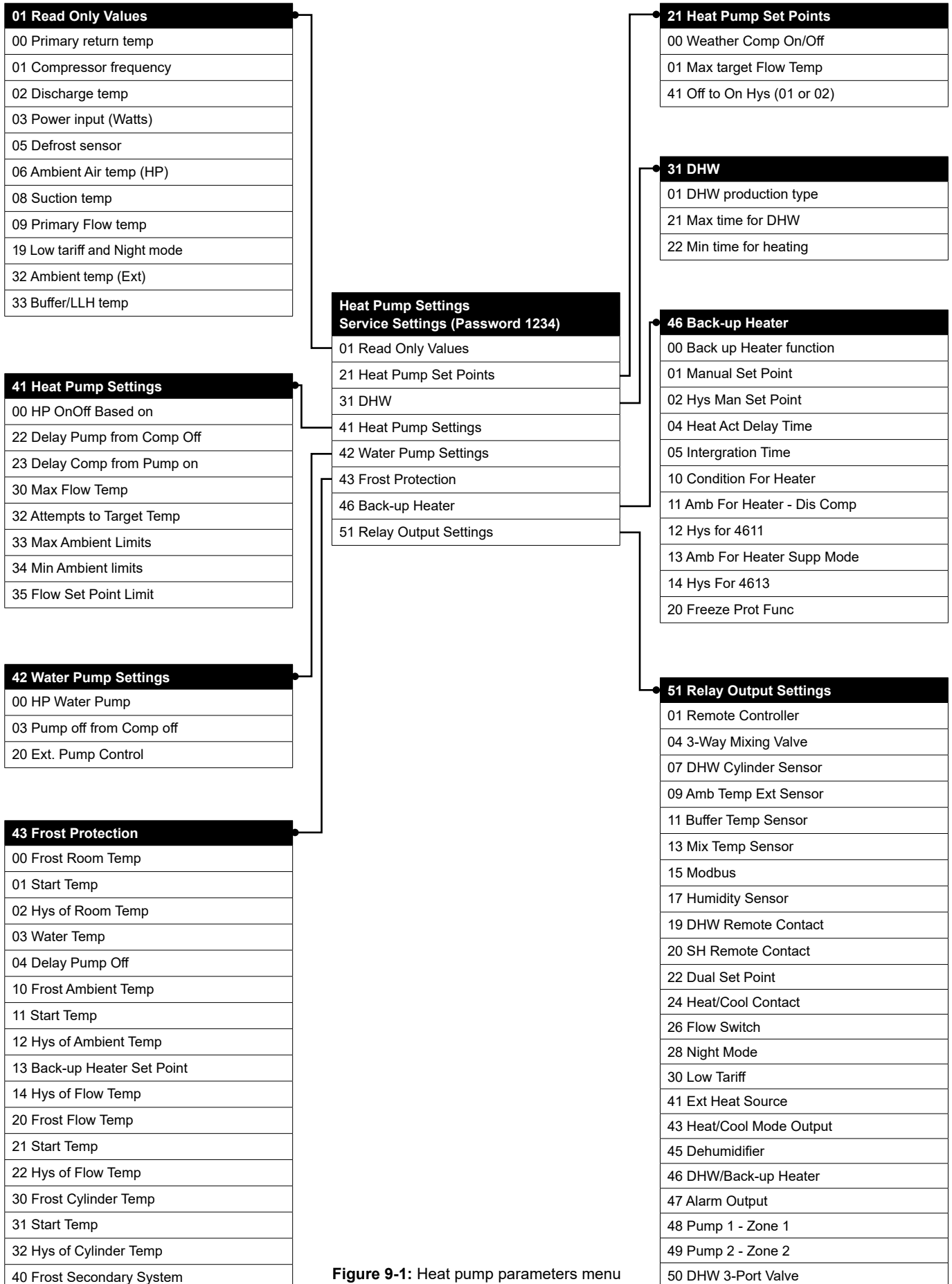

Figure 9-1: Heat pump parameters menu

Parameter	Description
01 Read only Values	Heat Pump operating conditions - Displayed information directly from the Heat pump.
21 Heat Pump Set Points	21 00 - Enable/Disable Weather Compensation on Heat Pump (Do not enable) 21 01 - Setting for the Maximum Target Flow temperature (Smart controller adjusts automatically) 21 41 - Hysteresis set point to enable the Heat pump
31 DHW	31 01 - Heat pump priority on DHW demand 31 21 - Max time the Heat pump can run for a DHW demand 31 22 - Minimum time for a Space heating demand
41 Heat Pump Settings	41 00 - Heat Pump control based on selected set point 41 22 - Delay time for Pump off after compressor off 41 23 - Delay time for Compressor on after Pump on 41 30 - Maximum Flow temperature set point for Heating and DHW 41 32 - Set the max number of attempts for Heat pump to reach target temperature 41 33 - Maximum ambient temperature at which the Heat pump will operate 41 34 - Minimum Ambient temperature at which the Heat pump will operate 41 35 - Flow set point limits
42 Water Pump Settings	42 00 - Operation settings of Water pump 42 03 - Delay time of Water pump OFF from Compressor OFF 42 20 - Operation settings for an external secondary Water pump
43 Frost Protection	43 00 - Frost Detection based on room temperature 43 01 - Start Temperature set point for frost protection based on room temperature 43 02 - Hysteresis of room temperature to activate frost protection based on room temperature 43 03 - Temperature set point of circulated water 43 04 - Time delay for water pump to be deactivated on frost protection end 43 10 - Frost detection based on ambient temperature 43 11 - Start temperature for Frost protection on Ambient Temperature 43 12 - Hysteresis of Ambient temperature 43 13 - Temperature Set point for Back-Up Heater 43 14 - Flow Temperature Hysteresis 43 20 - Enable/Disable Frost protection on Outgoing flow temperature 43 21 - Start Temperature for 43 20 43 22 - Hysteresis of 43 20 43 30 - Enable/Disable Frost protection on DHW Cylinder temperature 43 31 - Start temperature for 43 30 43 32 - Hysteresis for 43 30 43 40 - Frost Secondary System - Frost Protection for a slave heat pump connected in cascade.
46 Backup Heater	46 00 - Enable/Disable Back-up Heater 46 01 - Back-up Heater Temperature Set point 46 02 - Hysteresis for Back-up Heater cylinder 46 04 - Delay time for Back-up Heater activation 46 05 - Intergration time for starting the heater 46 10 - Power condition of Back-up Heater 46 11 - Ambient temperature for enabling Heater & Disable compressor 46 12 - Hysteresis for 46 11 46 13 - Ambient temperature to activate Heater Supplementary mode 46 14 - Hysteresis for 46-13 46 20 - Enable/Disable Freeze Protection Function
51 Relay Output settings	Enable/Disable Heat Pump terminal PCB relays as listed - Refer to Figure 9-1

10 Wi-Fi Hub

10.1 GENERAL

The Wi-Fi hub enables the Grant Aerona Smart Controller to be accessed and operated remotely via the Internet or app. Users can monitor the operation of the Grant Aerona Smart controller and modify some operation parameters with the use of a computer, Tablet or mobile phone. Essential features of the module include:

- Communication with econet24.com external server provides access to Smart Controller via Internet.
- Support Wi-Fi wireless network access.
- Preview of the current operation parameters of the Smart Controller in readable and clear “tiles”.
- Visual diagrams indicating current operation of the installed hydraulic system.
- Preview and edit options of most user and service parameters of the controller.
- Registration of operation parameters and alarm conditions of the controller.
- E-mail notifications of alarm conditions of the main controller.

The mobile app is available from Google play or IOS store and can be downloaded using the QR codes below.



ecoNET.apk (Android)



ecoNET.app (IOS)

10.2 CONNECTION TO WIRING CENTRE

The hub has to be connected with G3 socket on the wiring centre with the use of ecoLINK interface cable. The ecoLINK interface cable and adapter are a part of the Wi-Fi hub set within your Grant Aerona Smart controller kit.

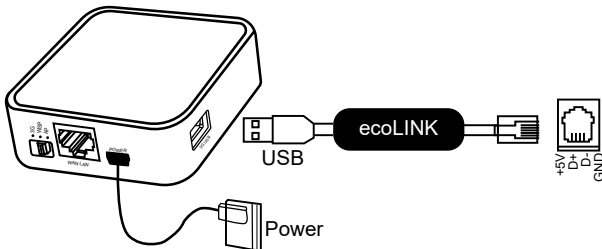

Figure 10-1: ecoLINK Cable connection

10.3 CONNECTION WITH INTERNET

Connect the power adapter plug to the mini USB Port socket and 3G USB Port to the ecoLINK interface. A Ethernet cable will be required between the RJ45 Ethernet Port and ADSL router, switch and modem. The ethernet cable does not have to be used if connected via Wi-Fi wireless network access.

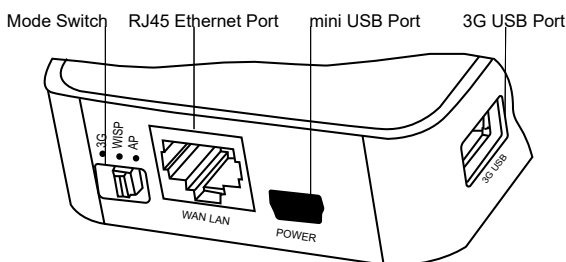

Figure 10-2: Connection ports

The Mode Switch can be set in any position.

After the power is on, hub requires approx. 1 minute in order to load the operational system. The module will then indicate its condition via the LED. In a connection between hub with a main controller is active, a “connection with controller” indicator lights up.

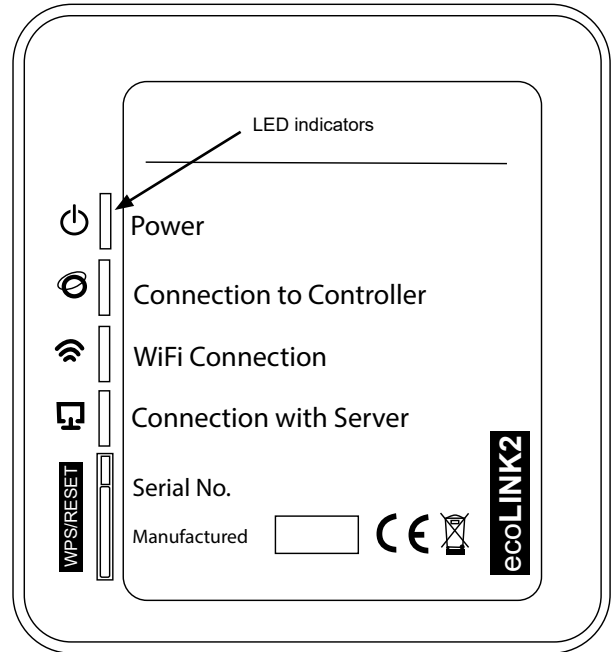

Figure 10-3: Web Module

Table 10-1: LED description

LED	ON/OFF Condition
	Status of Power.
	Active connection to the Aerona Smart Controller.
	Connection to Wireless Network
	Connection to ecoNET24 external server

! NOTE !

The Wi-Fi hub requires active DHCP server connection. Manual IP assignment for the hub is not supported.

Wi-Fi access parameters will need to be entered into the touchscreen display via the User settings menu for the hub to be able to make a wireless connection. (Refer to Section 7.9)

10.4 ECONET24

The Wi-Fi hub connects to ecoNET24 via an external server connection. This provides access to the controller via the Internet.

You will need an account to log into the the external server, visit www.econet24.com on a web browser to register.

10.4.1 FIRST CONNECTION

Ensure the Wi-Fi hub will need is connected to the Internet and connected with the external server ('Server connection' LED indicator is active).

The device UID (which is obtained via User settings menu in Device Diagnostics) will be needed as part of the registration process. Refer to Section 10.4.2 for details.

On a web browser visit www.econet24.com. When registering you will be prompted to validate the device UID. If the system correctly validates the UID number, the registration will progress. Complete the form with the data of the user.

- Controller UID
- Controller label – enter any name for the Smart Controller.
- Remote access to the controller – enables remote access to view and edit controller parameters.
- Controller installation address – check that the Smart Controller address is the same as residential address.
- Alarm notifications – E-mail notifications of alarms can be sent to a designated address.

! NOTE !

To use the app you will need to register via Website first.

For a reminder of a password for an existing account, select FORGOT PASSWORD and enter your email. A password reminder will be sent to your email account.

10.4.2 HOW TO OBTAIN THE UID

Follow the steps to obtain the UID.

1. When the heating circuit control interface is shown (see figure 7-1), tap settings menu. Refer to Table 7-1 and Figure 10-4.

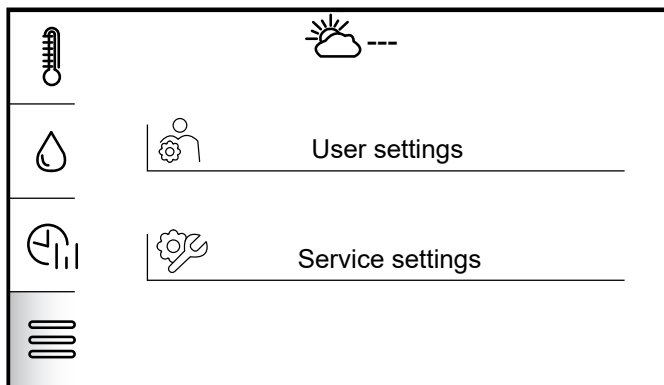

Figure 10-4: Settings selection.

2. Then tap the User settings. Refer to Figure 10-5.

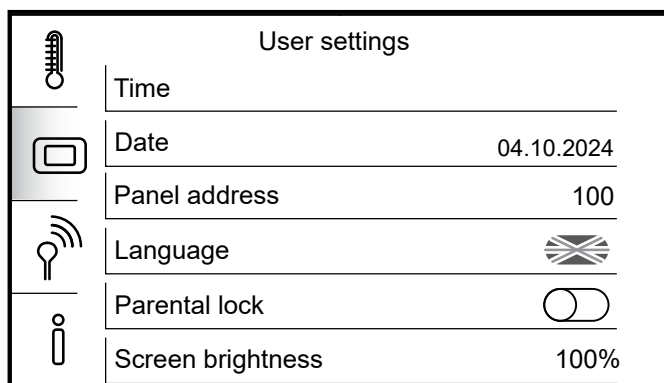

Figure 10-5: User settings menu.

3. Tap the information icon at the bottom. Refer to Figure 10-6.

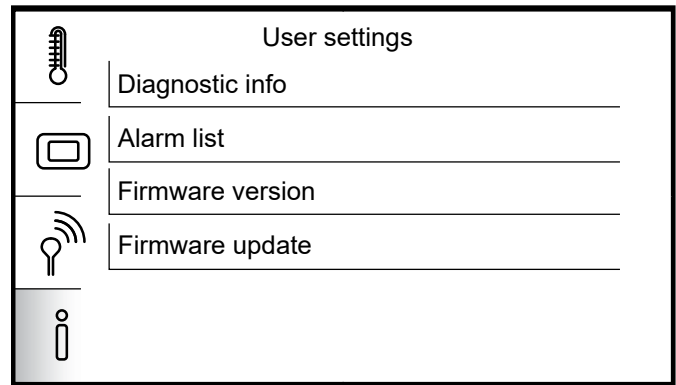

Figure 10-6: Controller information options.

4. Then tap 'Firmware version'. Refer to Figure 10-7.

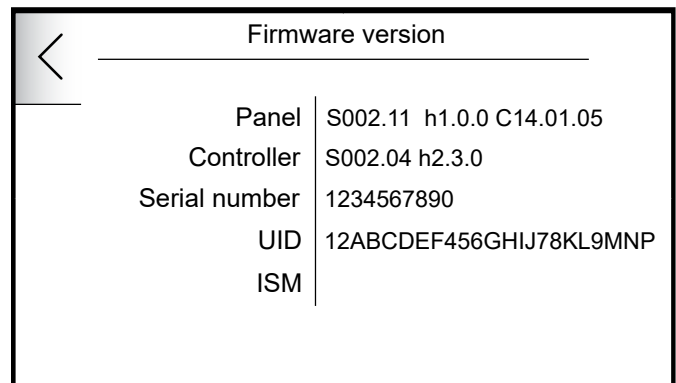

Figure 10-7 Firmware version and UID.

10.4.3 RESTORING TO DEFAULT

If you should experience any issues during setup or the user forgets their details for logging in the Wi-Fi hub, it is possible to restore default data with the use of the WPS/Reset button on the hub housing.

- Push and hold WPS/RESET for at least 10 seconds.
- Release the WPS/RESET button. LED indicator above should flash several times.
- Wait for approx. 2 minutes.
- The hub will automatically start up and connect with the Internet using default username and password.

! NOTE !

Default username: admin, password: admin

11 Servicing

11.1 COMPONENT REPLACEMENT

11.1.1 MAIN FUSE

The main fuse is located under the wiring centre cover, next to the terminals on the high-voltage side. This is a 250V 5 x 20mm 6.3A 'T' type AC fuse. A spare fuse is located under the cover of the wiring centre on the low-voltage terminals side.

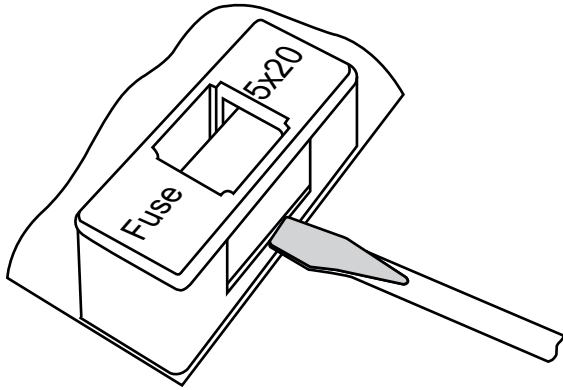

Figure 11-1 Mains fuse replacement

In order to remove fuse lift fuse holder with flat-blade screwdriver and pull out the fuse. Refer to Figure 11-1.

11.1.2 TOUCHSCREEN DISPLAY REPLACEMENT

When replacing the touchscreen display make sure that its software is compatible with software in the wiring centre. The compatibility is kept if the first number of software in the touchscreen display and wiring centre are the same.

11.1.3 WIRING CENTRE REPLACEMENT

Requirements are analogous to the control panel.

11.2 ACCESSORIES & SPARE PARTS

Grant UK offer the individual components to the Smart Controller system should the need arise.

Table 11-1: Accessories & Spare Parts List

Part Code	Item
HPIDSMARTWRTR	Wireless thermostat (with receiver)
HPIDSMARTWRT	Wireless thermostat (no receiver)
HPIDSMARTRECEIVER	Wireless thermostat receiver
HPIDSMARTHRT	Wired thermostat
HPIDSMARTSEN2	Water temperature sensor with 2m cable*
HPIDSMARTSEN4	Water temperature sensor with 4m cable*
HPIDSMARTWSEN	Outdoor Weather Sensor*
HPIDSMARTFLO	Smart Flow sensor**
HPIDSMARTIMM	Immersion Heater Relay**
HPIDSMARTHUB	Smart Controller Wi-Fi Hub*
HPID120	3-Port Diverter valve
HPID122	3-Port Valve body**
HPID123	Motorised valve actuator**

* - supplied as part of Aerona Smart controller kit

** - supplied as part of a Aerona Smart controller installation pack

12 EC Declarations of Conformity



UKCA - Safety Declaration of Conformity

This declaration is made under the sole responsibility of the following Manufacturer. The Manufacturer declares that the following product conforms to the requirements of the UK Legislation and Regulations as detailed below.

The Technical Construction Files are retained at the Manufacturer's location.

Product: Grant Smart Controls

Model: GRANTSMARTCONKIT

In accordance with the following directive(s) or Regulation(s), provided that the products are installed and used in accordance with our instructions:

S.I. 2016/1101: Electrical Equipment (Safety) Regulations 2016

S.I. 2016/1091: Electromagnetic Compatibility Regulations 2016

S.I. 2012/3032: The Restriction of the Use of Certain Hazardous Substances in Electrical and Electronic Equipment Regulations 2012

following the provisions of:

BS EN 60730-2-9:2010

BS EN 660730-1:2016-A1:2019

BS EN 50581: 2012

Place of Issue
Date of issue

United Kingdom
13 December 2023

Technical File Compiler and
Authorised Signatory

A handwritten signature in black ink, appearing to read "Neil Sawers".

Neil Sawers
Commercial Technical Manager

Grant Engineering (UK) Ltd

Frankland Road | Blagrove | Swindon | SN5 8YG
+44(0)1380 736920 | info@grantuk.com | www.grantuk.com

REGISTERED IN ENGLAND No: 3196757. REGISTERED OFFICE: AS ABOVE

GUK13122023 UKCA DoC GSCK

13 Health and Safety Information

13.1 GENERAL

The Health and Safety information given in this Section relates to the Grant Aeronas smart controller only.

For details of the Health and Safety Information for the heat pump, refer to Section 14 of the Aeronas³ installation and servicing instructions supplied.

For details of the Health and Safety Information for any other heating appliances being used, refer to the instructions supplied with the appliance.

Under the Consumer Protection Act 1987 and Section 6 of the Health & Safety at Work Act 1974, we are required to provide information on substances hazardous to health (COSHH Regulations 1988).

14 Disposal and Recycling

14.1 DIRECTIVE WEEE 2012/19/EU

Purchased product is designed and made of materials of the highest quality.

The product meets the requirements of the Directive 2012/19/EU of 4 July 2012 on waste electrical and electronic equipment (WEEE), according to which it is marked by the symbol of crossed-out wheeled bin (like below), meaning that product is subjected to separate collection.

Responsibilities after finishing a period of using product:

- Dispose of the packaging and product at the end of their period of use in an appropriate recycling facility,
- Do not dispose of the product with other unsorted waste,
- Do not burn the product.
- By complying with the above obligations of controlled disposal of waste electrical and electronic equipment, you avoid harmful impact on the natural environment and threats to human health.

15 Guarantee

You are now the proud owner of an Aerona Smart Controller for use with the Grant Aerona Air Source Heat Pump which has been designed to give years of reliable, trouble free operation.

Grant Engineering (UK) Limited guarantees the manufacture of the Aerona Smart Controller including all electrical and mechanical components supplied with it for a period of **twelve months from the date of installation**⁴, provided that the Smart Controller and the air source heat pump with which it is being used have been installed in full accordance with the installation and servicing instructions issued.

This will be extended to a total period of **two years** if the Smart Controller is registered with Grant Engineering (UK) Limited **within thirty days of installation**⁴, and it is checked, along with the associated valves, sensors, etc. when the heat pump is serviced at twelve monthly intervals³. See main Terms and Conditions below.

Registering the product with Grant Engineering (UK) Limited

Please register your Smart Controller with Grant Engineering UK Limited **within thirty days of installation**. To do so visit www.grantuk.com and click the 'Register Product' link in the top right-hand corner of the home page, where you can register your Smart Controller for a further **twelve months** guarantee (giving **two years** from the date of installation). This does not affect your statutory rights¹.

If a fault or defect occurs within the manufacturer's guarantee period

If your Smart Controller should fail within the guarantee period, you must contact Grant Engineering (UK) Limited, who will arrange for the repair under the terms of the guarantee, providing that the Smart Controller and the heat pump with which it is being used have been correctly installed, commissioned and serviced (if the appliance has been installed for more than twelve months) by a competent person and the fault is not due to tampering, system water contamination, misuse, trapped air or the failure of any external components not supplied by Grant Engineering (UK) Limited, e.g. pipework, etc.

This two-year guarantee only applies if the Smart Controller is registered with Grant Engineering (UK) Limited within thirty days of installation⁴ and is checked along with the associated valves, sensors, etc. when the heat pump is serviced after twelve months.

In the first instance

Contact your installer or commissioning engineer to ensure that the fault does not lie with the system components, discharged batteries in wireless thermostats, or any incorrect settings of the Smart Controller that falls outside of the manufacturer's guarantee otherwise a service charge could result. Grant Engineering (UK) Limited will not be liable for any charges arising from this process.

If a fault covered by the manufacturer's guarantee is found

Ask your installer to contact Grant Engineering (UK) Limited, Service Department on +44 (0)1380 736920 who will arrange for a competent service engineer to attend to the fault.

Remember - before you contact Grant Engineering (UK) Limited

Ensure the Smart Controller and the air source heat pump with which it is being used have been installed, commissioned and serviced by a competent person in accordance with the installation and servicing instructions.

Ensure the problem is not being caused by the heating system, discharged batteries in wireless thermostats, or any incorrect settings of the controls.

Free of charge repairs

During the **two year** guarantee period no charge for parts of labour will be made, provided that the Smart Controller and the air source heat pump with which it is being used have been installed and commissioned correctly in accordance with the manufacturer's installation and servicing instructions, it was registered with Grant Engineering (UK) Limited within thirty days of installation⁴ and, for Smart Controllers and air source heat pumps over twelve months old, details of annual service is available³.

The following documents must be made available to Grant Engineering (UK) Limited on request:

- Proof of purchase
- Commissioning Report Form
- Service documents
- System Design Criteria

Chargeable repairs

A charge may be made (if necessary following testing of parts) if the cause of the breakdown is due to any fault(s) caused by the plumbing or heating system, e.g. contamination of parts due to system contamination, sludge, scale, debris or trapped air. See 'Extent of manufacturer's guarantee' below.

Extent of manufacturer's guarantee:

The manufacturer's guarantee does NOT cover the following:

- If the Smart Controller has been installed for over two years.
- If the Smart Controller and/or the air source heat pump with which it is being used have not been installed, commissioning, or serviced by a competent person in accordance with the installation and servicing instructions.
- The serial number has been removed or made illegible.
- Fault(s) due to accidental damage, tampering, unauthorized adjustment, neglect, misuse or operating the Smart Controller and/or the air source heat pump contrary to the manufacturer's installation and servicing instructions.
- Damage due to external causes such as bad weather conditions (flood, storms, lightning), fire, explosion, accident or theft.
- Fault(s) due to incorrectly sized expansion vessel(s), incorrect vessel charge pressure or inadequate expansion on the system.
- Fault(s) caused by external electrics and external components not supplied by Grant Engineering (UK) Limited.
- Air source heat pump servicing, de-scaling or flushing.
- Checking and replenishing system pressure.
- Electrical cables and plugs, external controls not supplied by Grant Engineering (UK) Limited.
- Heating system components, such as radiators, pipes, fittings, pumps and valves not supplied by Grant Engineering (UK) Limited.
- Instances where the Smart Controller has been un-installed and re-installed in another location.
- Use of spare parts not authorised by Grant Engineering (UK) Limited.
- Consumable items including, but not limited to, batteries, antifreeze and biocide inhibitor.
- The replacement of batteries in wireless thermostat.
- The cost and provision of any specialist access equipment, or any associated costs, required to inspect, repair, service or replace any units not installed in accordance with these installation instructions, irrespective of whether the heat pump is deemed to be at fault or not.

Terms of manufacturer's guarantee

The Company shall mean Grant Engineering (UK) Limited.

The Smart Controller and the heat pump with which it is being used must be installed by a competent installer and in full accordance with the relevant Codes of Practice, Regulations and Legislation in force at the time of installation.

The Smart Controller is guaranteed for two years from the date of installation⁴, providing that after twelve months the annual service has been completed³ and the heat pump registered with the company within thirty days of the installation date⁴. Any work undertaken must be authorised by the Company and carried out by a competent service engineer.

Proof is provided that the system has been flushed or chemically cleaned where appropriate (refer to BS 7593) and that the required quantity of a suitable corrosion inhibitor added.

Proof of annual servicing (including the checking of any expansion vessels and pressure relief valves) must be provided if and when requested by the Company.

IMPORTANT Grant Engineering (UK) Limited **strongly recommends** that a Grant Mag-One in-line magnetic filter/s (or equivalent⁶) is fitted in the heating system pipework. This should be installed and regularly serviced in accordance with the filter manufacturer's instructions.

This guarantee does not cover breakdowns caused by incorrect installation, neglect, misuse, accident or failure to operate the Smart Controller and/or heat pump in accordance with the manufacturer's installation and servicing instructions.

The Smart Controller is registered with the Company within thirty days of installation. Failure to do so does not affect your statutory rights¹.

The balance of the guarantee is transferable providing the installation is serviced prior to the dwelling's new owners taking up residence. Grant Engineering (UK) Limited must be informed of the new owners's details.

The company will endeavour to provide prompt service in the unlikely event of a problem occurring but cannot be held responsible for any consequences of delay however caused.

This guarantee applies to Grant Engineering (UK) Limited Smart Controllers purchased and installed on the UK mainland, Isle of Wight, Channel Islands and Scottish Isles only². Provision of in-guarantee cover elsewhere in the UK is subject to agreement with the company.

All claims under this guarantee must be made to the Company prior to any work being undertaken. Invoices for call out/repair work by any third party will not be accepted unless previously authorised by the Company. Proof of purchase and date of installation, commissioning and service documents must be provided on request.

If a replacement Smart Controller is supplied under the guarantee (due to a manufacturing fault) the product guarantee continues from the installation date of the original Smart Controller and not from the installation date of the replacement⁴.

- The replacement of a Smart Controller under this guarantee does not include any consequential costs.

Foot notes

1. Your statutory rights entitle you to a one-year guarantee period only.
2. The UK mainland consists of England, Scotland and Wales only. Please note that for the purposes of this definition, Northern Ireland, Isle of Man and Scilly Isles are not considered part of the UK mainland.
3. We recommend that your Smart Controller and the air source heat pump with which it is installed are serviced every twelve months (even when the guarantee has expired) to prolong the lifespan and ensure it is operating safely and efficiently.
4. The guarantee period will commence from the date of installation, unless the installation date is more than six months from the date of purchase, in which case the guarantee period will commence six months from the date of purchase.
5. As measured by gauss. The Mag One magnetic filter has a Gauss measurement of 12000.

Version 1.0 - December 2023

Appendix A Wired Thermostat

A.1 GENERAL

The Grant Wired thermostat is designed to provide individual circuit control via the Grant Aeronia Smart Controller.

The thermostat is installed in a suitable location to monitor the circuit, e.g., Ground floor hallway, and is designed to maintain a target temperature.

The thermostat on the backlit LCD display shows information about the circuit temperature value, selected operating mode, current time with simultaneous clock synchronization with the main controller.

A.2 INSTALLATION

The thermostat is intended for installation only in a dry, habitable location and should be mounted to the wall. After choosing the place of installation, make sure that:

- The selected location is free of excessive humidity and the ambient temperature of the thermostat should be within the range of 0 to 40°C,
- The chosen location should ensure free air circulation and should be located away from heat-emitting sources, e.g., electronic equipment, fireplace, heater and direct sunlight.
- The thermostat should be mounted at a height enabling convenient operation, typically 1.5m above the floor. (Refer to Figure 3-1)

The thermostat should be screwed to the wall with mounting screws. Access to the screw holes is obtained by opening and removing the back cover of the thermostat. A flat screwdriver can be used to open the cover.

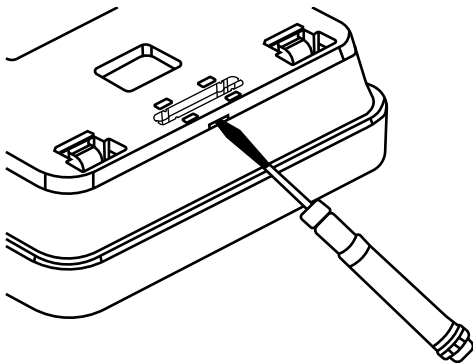

Figure A-1: Wired thermostat back access

The cover is screwed to the selected location of the wall with the appropriate position (UP), as shown in the Figure below. The hole spacing can be determined by attaching the cover to the wall.

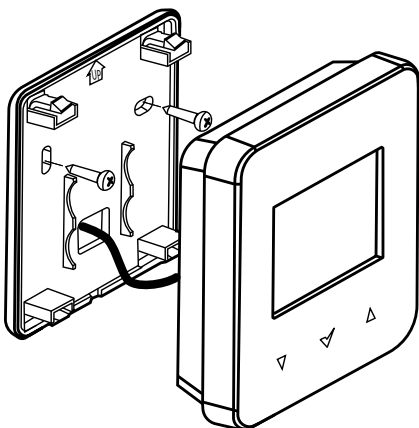

Figure A-2: Wired thermostat wall fixing

Before reattaching the cover, lead the wire connecting the thermostat with the wiring centre through the hole. The cable must be recessed into the wall. The cable can not be routed together with the electrical cables of the building. The cable should not run in the vicinity of devices emitting strong electromagnetic fields. Then attach the thermostat to the mounting frame using the clips.

The VCC, GND, D+, D- terminals of the thermostat should be connected to the transmission socket of the main controller. Refer to Figure A-3.

! NOTE !

A 4-core cable with a cross-Section of min. 0.5 mm².

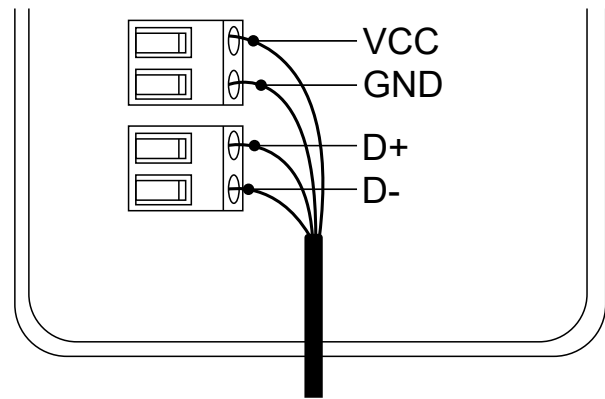

Figure A-3: Wired Thermostat Wiring

! NOTE !

Close attention must be paid to the 4 connections for Voltage, Ground and Polarity. Ensure they match to corresponding wires from touchscreen panel

A.3 THERMOSTAT PANEL

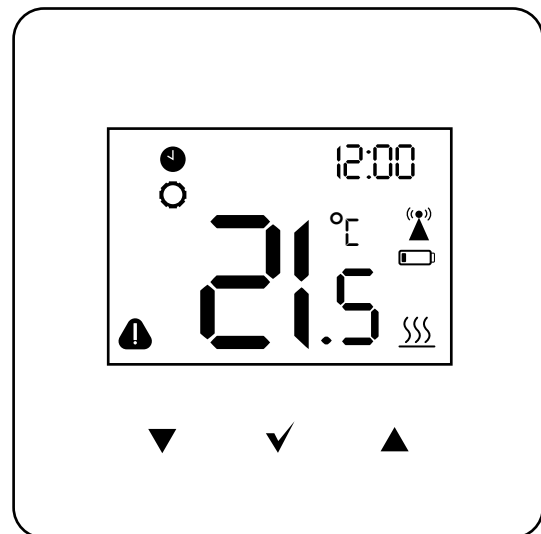











Figure A-4: Wired (& Wireless) thermostat panel LCD

Table A-1: Wired (& Wireless) thermostat LCD symbols

Symbol	Symbol description
	Alarm symbol
	Schedule - Thermostat is schedule managed
	Parameter editing
	Heat demand
	Radio signal (Wireless Thermostat only)
	Low battery indicator (Wireless Thermostat only)
	Decrease parameter
	Confirm
	Increase parameter

A.4 PAIRING

The wired thermostat should be connected as part of the Smart Controller configuration creator for the circuit that the thermostat will measure. To pair again you can follow this within the individual circuit settings to re-pair to the Grant Aeron Smart controller.

- Access the circuit you wish to pair with a wired thermostat panel from the Circuit settings within the System settings menu (Refer to Section 8) and select the Thermostat option from the menu and confirm you wish to overwrite if a thermostat is already present on the circuit.
- The pairing wizard will begin and will instruct you to set up the desired wired thermostat into pairing mode.
- Follow the on-screen prompts. Hold the up and down buttons simultaneously for 2 seconds. The screen will change to display you have entered the user menu where you then select parameter 03 in the user menu of the thermostat. "PAr" will be displayed on the screen. After accepting with button, the pairing will start (the word "PAr" begins to flash).
- Confirmation of the pairing will be confirmed by the message "END" and "Succ" on the thermostat.
- After pairing a room thermostat holding the tick down will return you first to the previous menu and then the back to the main screen in 2 second intervals.

A.5 CHANGING SETPOINT TEMPERATURE

Tapping the up or down arrows will prompt the thermostat into the check/editing of target temperature causing the current target saved temperature to flash.

The first tap of the arrow will trigger the edit temperature function but will not change the value. Tapping the arrow again will then change the value either up or down. Tapping the tick will confirm, save and exit.

Not confirming a new target with 5 seconds of inactivity will cause the thermostat to exit the editing mode without changing the target temperature.

! NOTE !

Holding the up or down arrows for more than 2 seconds will cause a fast change to the parameter.

A.6 HOTEL MODE

Hotel mode can disable the wired thermostats ability to change the Smart Controller parameters and schedules. We recommend this be activated to avoid conflicting programmed settings between the wired thermostat and the Grant Aeron Smart controller.

1. To access the service menu press and hold the down arrow and the confirmation tick capacitive buttons for 2 seconds. After which you will need to enter the number sequence 1410 and confirm with the tick.
2. To enter the password you will need to cycle each of the 4 digits with the up or down arrow and confirm that digit with the tick. On the confirmation of the fourth digit you will continue to the service menu.
3. Navigate to parameter 2 and select Hotel mode with the tick. Default setting for hotel mode is off and the arrows will cycle through options. Ensure On is visible and confirm.
4. Holding the tick for 2 seconds will save and exit the menu back to the main screen.

A.7 ERROR CODES

The Grant Aeron Smart controller communicates alerts to the thermostat panels when present in the system. Refer to Table A-2 for determining the fault.

Table A-2: Thermostat alarm codes

Code	Alert description
1	Outside temperature sensor error
2	1 - No communication with the controller
3	No compatibility of programs
4	3 - Panel temperature sensor error
5	DHW sensor error
6	Upper buffer temperature sensor error
7	6 - Lower buffer temperature sensor error
8	Circuit 2 temperature sensor error
9	Circuit 3 temperature sensor error
10	Anti-freeze active
12	No communication with the thermostat
13	No communication with thermostat circuit 1
14	No communication with thermostat circuit 2
15	No communication with thermostat circuit 3
16	15 - alarm from digital input
17	No flow detected
18	Too often no flow detected
20	19 - No communication with heat pump module
21	Circuit 4 temperature sensor error (not used)
22	Circuit 5 temperature sensor error (not used)
23	Circuit 6 temperature sensor error (not used)
24	Circuit 7 temperature sensor error (not used)
25	No communication with thermostat circuit 4 (not used)
26	No communication with thermostat circuit 5 (not used)
27	No communication with thermostat circuit 6 (not used)
28	No communication with thermostat circuit 7 (not used)
98	Service alarm
100-140	Alarms from heat pump

Appendix B

Wireless Thermostat and Receiver

B.1 GENERAL

The Grant Wireless receiver & thermostat are designed to provide wireless circuit control via the Grant Aeron Smart controller.

The thermostat should be installed in a suitable location to monitor the circuit, e.g., First floor hallway, and is designed to maintain a target temperature. by sending a radio signal to the module connected to the wireless receiver.

The thermostat on the backlit LCD display shows information about the circuit temperature value, selected operating mode, current time with simultaneous clock synchronization with the touchscreen display.

B.2 INSTALLING WIRELESS RECEIVER

The wireless receiver should be mounted on a wall near the installation location of the wiring centre. If the radio connection is poor, try placing the wireless receiver in other places. Moving the wireless receiver even by a few centimetres can affect the quality of the connection.

! NOTE !

Placing a wireless receiver in a metal casing, e.g. a mounting box, a metal boiler casing, etc. will block the radio signal and thus interfere with the operation.

The radio module should be screwed to the wall with mounting screws. Access to holes for screws is obtained after unscrewing the cover of this module. Refer to Figure B.1.

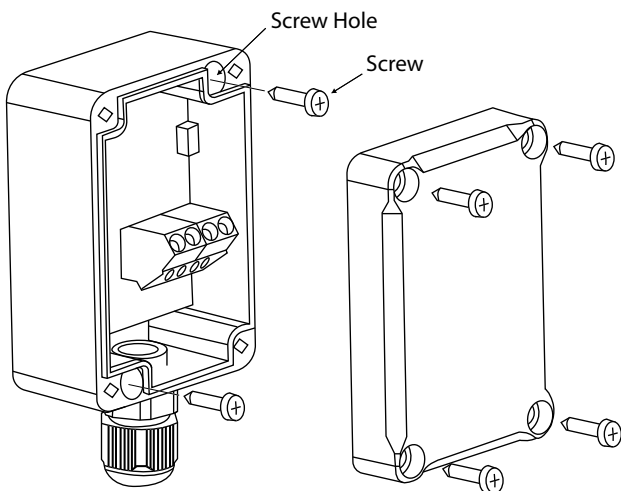

Figure B-1: Wireless receiver wall fixings

Terminals D +, D-, GND, 12VDC of the Wireless receiver should be connected to the G1 socket of the wiring centre.

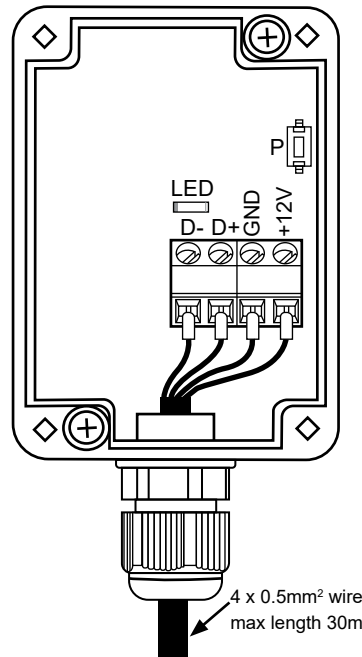

Figure B-2: Wireless receiver wiring

! NOTE !

Ensure the correct polarity of the connection of the D+, D- signals and the GND, +12V power supply between the thermostat and the wiring centre. Incorrect connection may lead to damage to the main controller or errors in its operation.

The maximum cable length depends on the cross-section of the wires. For a 0.5 mm² wire, it should not exceed 30m. The cross-section should not, however be less than 0.5 mm².

B.3 WIRELESS THERMOSTAT

The wireless thermostat is intended for installation only in a dry habitable location and should be placed on a flat surface (as a free-standing device) in a room representative for a given heating circuit. After choosing the place of installation, make sure that:

- The selected location is free of excessive humidity and the ambient temperature of the thermostat should be within the range of 5..35°C.
- The chosen location should ensure free air circulation and should be located away from heat-emitting sources, e.g., electronic equipment, fireplace, heater and direct sunlight.
- The selected place must not cause interference or a lack of radio signal.

B.3.1 INSERTING OR REPLACING THE BATTERIES

To insert or replace the battery, remove the back cover of the thermostat housing.

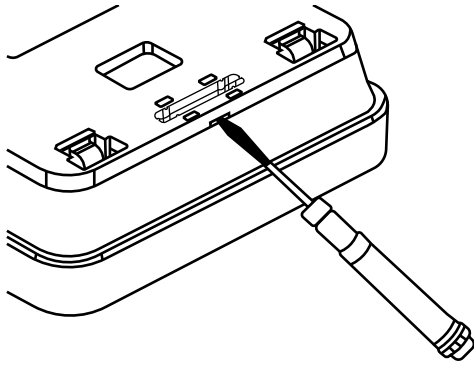

Figure B-3: Wireless Thermostat back access

When inserting the batteries, the battery poles have to be positioned correctly. Check thermostat moulding for guidance.

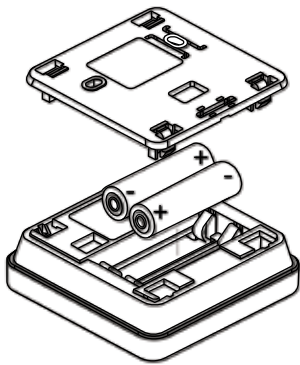

Figure B-4: Battery placement

It is recommended to use alkaline batteries to power the thermostat. The thermostat working time depends on the quality of the batteries used. Refer to Appendix A, Figure A-4 and Table A-1 for low battery indicator symbol.

B.3.2 PAIRING THE ROOM THERMOSTAT WITH THE WIRELESS RECEIVER

With the wireless receiver connected to the wiring centre you will need to pair with a wireless thermostat. Follow the steps to access the individual circuit controls and begin the pairing wizard. Refer to Section A4.

! NOTE !

Until the pairing with the wireless receiver on the thermostat screen is complete, the alarm and radio symbols are permanently displayed.

- Similar to the wired thermostat, hold the up and down buttons simultaneously for 2 seconds. The screen will change to display you have entered the user menu where you then select parameter 03 in the user menu of the thermostat. "PAR" will be displayed on the screen. After accepting with button, the pairing will start (the word "PAR" begins to flash).
- Confirmation of the pairing will be confirmed by the message "END" and "Succ" on the thermostat. The alarm and radio symbols are also no longer visible on the thermostat screen.

The structural elements of the building, the layout and equipment of rooms, the amount of electronic equipment, the distance between the wireless receiver and the thermostat all affect the quality of the radio signal.

Therefore when choosing a place to install the thermostat, take into account the obtained signal level in the selected location by observing the symbol on thermostat screen. If the symbol:

- is not displayed - Connection has been established
The symbol is shown only briefly during active radio communication with the wireless receiver.

- flashing - There is no connection or there is a weak signal and you should choose a different place to install the thermostat or add a signal repeater.

! NOTE !

The value of the radio signal strength can be read in parameter 30 of the thermostat user menu.

If the radio connection to the thermostat is lost, the Smart Controller will go into an operating mode without a thermostat after a few minutes.

After establishing the radio connection with the thermostat in the touchscreen display Information menu in the Software versions tab, the thermostats will be shown as a Wireless thermostat, with the version of the software displayed.

Connecting the wireless receiver to the wiring centre again does not require pairing if the thermostats have previously been paired.

B.4 MEMORY RESET OF THE WIRELESS RECEIVER

To perform a memory reset, hold down the P button in the receiver for approximately 8 seconds. The LED will blink after releasing the button confirming the action.

After performing a reset any required thermostats will need to be re-paired.

B.5 MULTIPLE THERMOSTAT SUPPORT

The wireless receiver can operate with up to 3 wireless thermostats. Pairing multiple thermostats with the wireless receiver will require setting an individual address for each of the thermostats.

The address for the thermostat is set in the user menu in the same way as initial pairing and select parameter 35. Each thermostat should set to a different address in the range 1..3.

The individual address settings can be checked in the main controller Diagnostic information menu, where the individual thermostats will be displayed as: T1, T2, T3.

B.6 THERMOSTAT PANEL

Refer to Appendix A3 for setting thermostat panel information

B.7 HOTEL MODE

Refer to Appendix A.6 for setting Wireless thermostat to hotel mode.

B.8 ALARMS

Refer to Appendix A.7 for error codes for wired and wireless thermostat panels.

Appendix C - 3-Port Mixer Valve

C.1 GENERAL

The Grant Aeron Smart controller can manage the temperature of an adjustable circuit with the use of a motorised rotary actuator mounted on a 3 port valve.

When configuring the system using the creator, if you choose to use a mixing valve the creator will prompt for a valve opening time. This value is the time the actuator would take to move fully from one end of its movement spectrum to the other under nominal power and is used to calculate movement for mixing.

C.2 CLOCKWISE ROTATION

C.2.1 ASSEMBLY

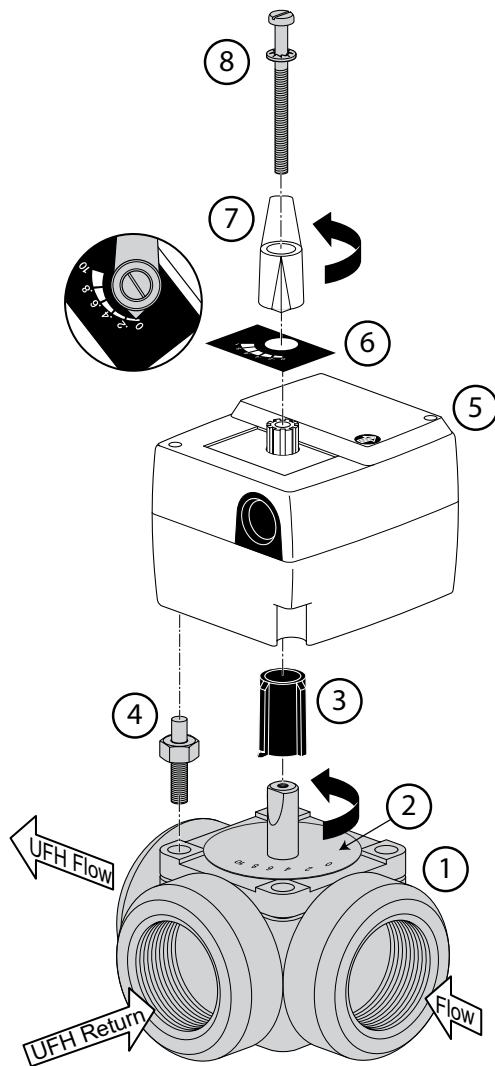

Figure C-1: Motorised Actuator and 3-Port Valve

Table C-1: Motorised Actuator and 3-Port Valve

Number	Description
1	3-Port valve
2	Body scale plate
3	Valve drive adaptor
4	Anti-rotation peg
5	Motorised actuator
6	Actuator scale plate
7	Rotary handle
8	Fixing Screw

To correctly assemble the 3-Port Mixing valve you will need to:

1. Ensure the clutch of the motorised actuator is disengaged allowing for free movement with the rotary handle. To disengage, place a screwdriver into the slot available, press down and turn clockwise. You will have disengaged when the arrow is facing the direction of the hand. Refer to Figure C-2.

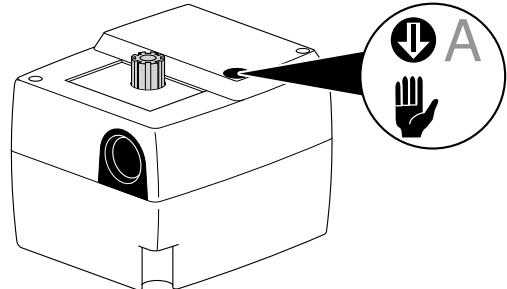

Figure C-2: Actuator gearing latch switch

2. Ensure actuator scale plate is in position and set as per Figure C-1. i.e. '0' to the left.
3. Fit the valve lever (supplied with the actuator) onto the splined shaft end. Rotate lever anticlockwise as far as possible. If necessary, remove and refit lever to point to '0' position on the scale.
4. Unscrew, remove and discard the fixing screw and blue handle attached to the supplied 3-port valve body
5. Fit the grey drive adaptor onto the 3-port valve spindle and turn until the pointer is facing the 0 position on the valve body scale plate. (The drive adaptor will only attach in one position).
6. Slot the Anti-rotation peg in place.

! NOTE !

If the Anti-rotation peg is not fitted the motorised actuator will spin in place and not turn the valve as required.

7. Place the motorised actuator onto the valve aligning the drive adaptor and ensure the Anti-rotation peg slots into the actuator body.
8. Insert the fixing screw through the rotary handle and fasten to a maximum torque pressure of 0.8Nm.
9. Reset the clutch of the actuator following step 1 to make the arrow point to A (Auto). If enabled the rotary handle will be locked in place.

C.2.2 WIRING

The electrical cable supplied with the actuator is connected as follows:

Table C-2: Electrical cable wiring

Colour	Description
Brown	230V drive to close the valve
White	230V drive to open the valve
Blue	230V neutral

The motorised actuator is connected via the 2 lives and 1 neutral connection to the wiring centre of either H2-M (Circuit 2) or H3-M (Circuit 3). The live connections power the motor in either direction to open or close the valve as required. Refer to Section 5 Figure 5-1 for wiring centre schematic.

For example for circuit 2:

- H2-M On (Terminal 3) - White
- H2-M Off (Terminal 5) - Brown

C.3 ANTI-CLOCKWISE ROTATION

C.3.1 ASSEMBLY

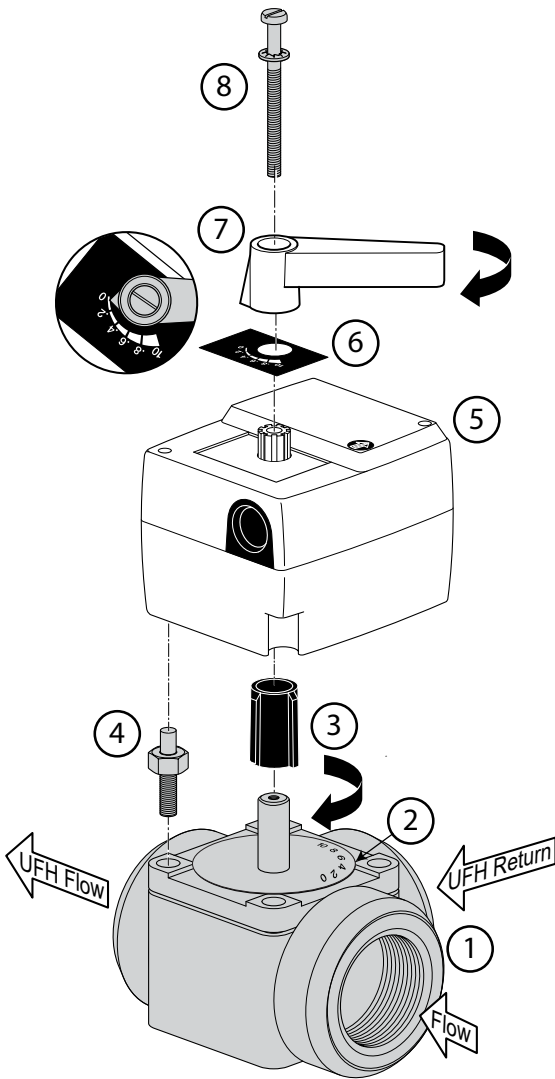

Figure C-3: Motorised Actuator and 3-Port Valve

To correctly assemble the 3-Port Mixing valve you will need to:

1. Ensure the clutch of the motorised actuator is disengaged allowing for free movement with the rotary handle. To disengage, place a screwdriver into the slot available, press down and turn clockwise. You will have disengaged when the arrow is facing the direction of the hand. Refer to Figure C-2.
2. Ensure actuator scale plate is in position and set as per Figure C-3. i.e. '0' to the right.
3. **Fit the valve lever (supplied with the actuator) onto the splined shaft end. Rotate lever clockwise as far as possible. If necessary, remove and refit lever to point to '0' position on the scale.**
4. Unscrew, remove and discard the fixing screw and blue handle attached to the supplied 3-port valve body.

! NOTE !

The body scale plate is reversible and should be checked to ensure correct orientation.

5. Remove the scale plate from the valve body. Carefully prise the circlip from the shaft. Lift the scale plate off, turn it over and refit with the '0' in the 3 o'clock position. Refit circlip.
6. Fit the grey drive adaptor onto the 3-port valve spindle and turn until the pointer is facing the 0 position on the valve body scale plate. (The drive adaptor will only attach in one position).

7. Slot the Anti-rotation peg in place.

! NOTE !

If the Anti-rotation peg is not fitted the motorised actuator will spin in place and not turn the valve as required.

8. Place the motorised actuator onto the valve aligning the drive adaptor and ensure the Anti-rotation peg slots into the actuator body.
9. Insert the fixing screw through the rotary handle and fasten to a maximum torque pressure of 0.8Nm.

Reset the clutch of the actuator following step 1 to make the arrow point to A (Auto). When Auto is enabled the rotary handle will be locked in place.

C.3.2 WIRING

The electrical cable supplied with the actuator is connected as follows

Table C-3: Electrical cable wiring

Colour	Description
Brown	230V drive to open the valve
White	230V drive to close the valve
Blue	230V neutral

The motorised actuator is connected via the 2 lives and 1 neutral connection to the wiring centre of either H2-M (Circuit 2) or H3-M (Circuit 3). The live connections power the motor to move in either direction to open or close the valve as required. Refer to Section 4 Figure 4-1 for wiring centre schematic.

For example for circuit 3

- H3-M On (Terminal 6) - Brown
- H3-M Off (Terminal 8) - White

Appendix D - Smart Immersion Relay

D.1 GENERAL

The Grant Smart Immersion relay is designed to provide a switch relay between the Grant Aerona Smart Controller and an installed immersion heater. The Grant Aerona Smart controller utilises the relay to provide a Legionella protection regime.

An additional Immersion relay will be required to control a supplementary immersion heater fitted in a volumiser, buffer or Low Loss header.

D.2 WIRING

The Grant Aerona Smart Immersion relay is connected to H1 (Terminals 19 and 20) or H2 (Terminals 21 and 22). H1 is for use with an immersion heater installed in a external volumiser or Low Loss header, while H2 is dedicated for the DHW immersion heater. (Refer to Section 5 for Terminal schematics)

A secondary power source independent of the Grant Aerona Smart controller to activate the immersion heaters must be provided for each relay used.

D.2.1 DHW CYLINDER IMMERSION HEATER

Connecting the Smart Immersion relay to a DHW immersion heater will provide a legionella protection regime. Refer to Section D.3 for further guidance.

A switch (MCB) is provided to manually override the relay (only to be activated by a competent person). This will allow the cylinder to be heated by the immersion heater only should there be a failure of the heat pump and/or Grant Aerona Smart controller. Refer to Figure D-1 for Dual voltage example with external switch.

D.2.1 SUPPLEMENTARY IMMERSION HEATER

Connecting the Grant Aerona Smart controller to a external volumiser or Low Loss header can provide supplementary assistance to meet a space heating demand. Refer to Figure D-1 for additional wiring requirements when connected in conjunction with a cylinder immersion.

D.3 SMART IMMERSION FUNCTIONALITY

D.3.1 LEGIONELLA PROTECTION

Legionella protection can be scheduled on a weekly basis to heat the DHW cylinder to 60°C. Legionella disinfection should be scheduled in a window that is a minimum of 1 hour after a DHW demand and in a setback heating demand period e.g. Overnight. This is to avoid the least amount of loss in the heating circuits.

The Legionella protection can not be run twice in a week should the schedule be changed within the settings.

See Section 7.4 for Legionella protection.

D.3.2 SUPPLEMENTARY HEATING

The Grant Aerona Smart controller can enable supplementary heating using the immersion heater in an external volumiser or Low Loss header.

The software enables the user to configure the time delay for the immersion heater to switch on after a specific demand has begun. Refer to Section 8 - Heaters for the settings of the time delay as well as temperature activation set points.

! WARNING !

There will 2 mains supplies within the Immersion relay enclosure. Ensure both are isolated before removing the cover.

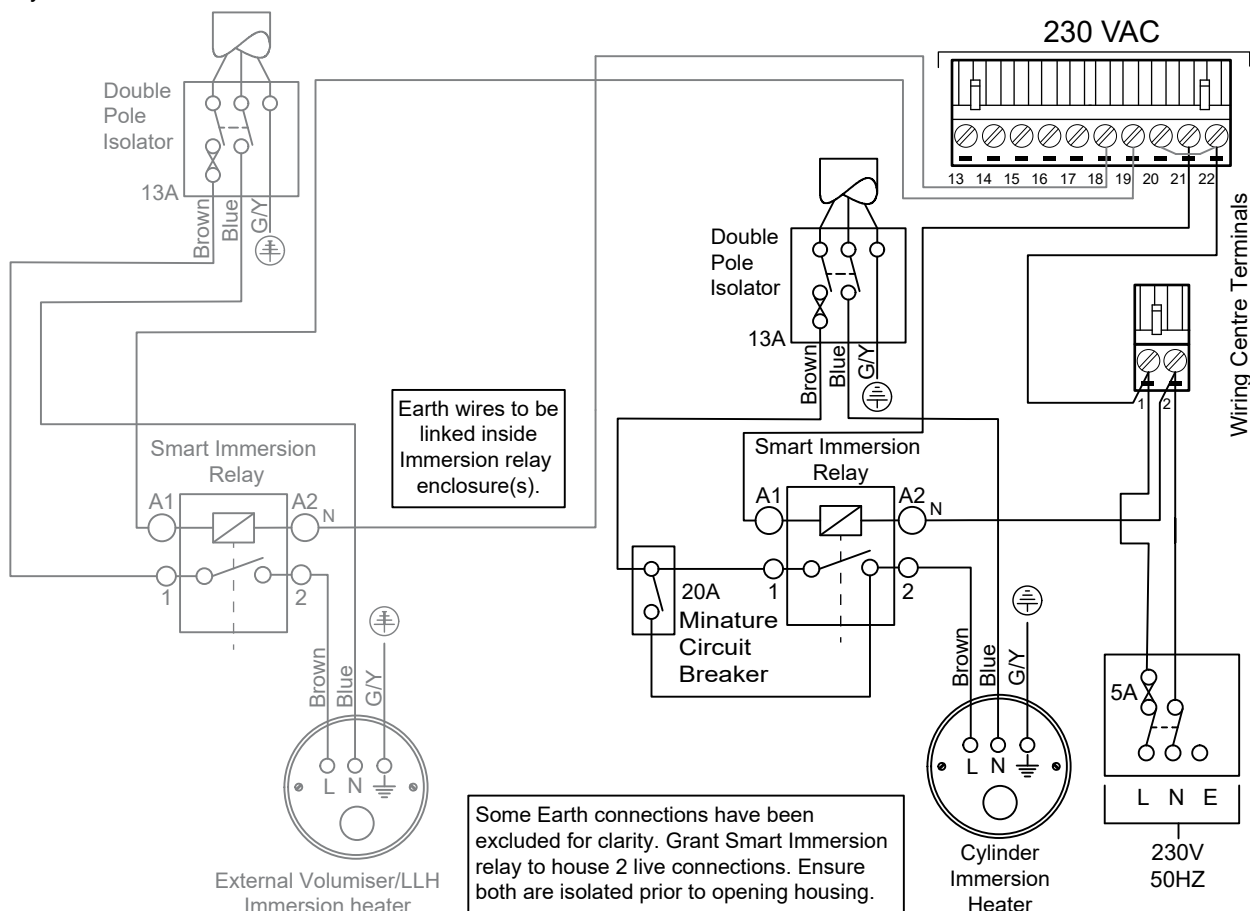

Figure D-1: Immersion relay examples

Appendix E - Smart Flow Sensor

E.1 GENERAL

The Grant Smart Flow sensor is designed to measure the flow rate within the installed system to determine the power output and the coefficient of performance (COP). Over time the function will also show the running SCOP.

E.2 INSTALLATION

The Grant Smart Flow sensor should be installed in a location that limits any interference to the measurements given to the Grant Aerona Smart controller. We recommend the minimum system pressure to be 1.4 bar to avoid damage from bubble formation and cavitation. You must take all due care to avoid water hammers during both installation and normal operation.

! CAUTION !

The sensor in the measuring tube of the Grant Flow sensor should not be exposed to mechanical loads.

For the optimum measurement accuracy the Grant Aerona Smart Flow sensor should be installed as per A in Figure E-1. Vertically with increasing flow allows for the discharge of bubbles upwards and no danger of dirt or sediment deposits within a completely filled pipeline.

Position B would be suitable when installing horizontally but interference from vortices created by bends can occur.

Position C is unsuitable due to being the top of the circuit and misreadings from bubbles formation and possible run empty.

Position D would be unsuitable again from possible run empty and bubble discharge moving back through the flow sensor.

Ensure isolation valves are set in a fully open position and not used control flow.

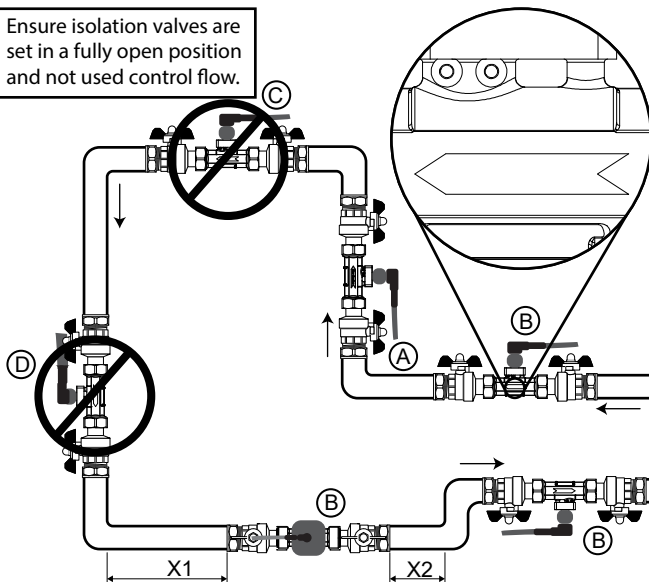

Figure E-1: Smart Flow sensor positioning

Table E-1: Calming Section measurements

Inlet Section (X1)	Outlet Section (X2)
Minimum 10x DN	Minimum 5 DN

For example, for a pipe diameter of 28mm:

10 x 28mm = 280mm straight pipe before inlet to flow sensor before any bend or fitting

5 x 28mm = 140mm straight pipe after outlet of flow sensor before any bend or fitting.

! NOTE !

Changes in pipe diameter should be treated the same as bends and have suitable calming sections.

The Smart flow sensor should be fitted on the return to the heat pump and be after the Grant Mag One filter, observing the calming section required for the inlet. When a suitable location has been determined:

1. Install suitable pipe fittings.
2. Ensure the flow sensor is correctly positioned as shown by the flow indicator on the outer body.
3. Insert the flow sensor with the O-rings as supplied.
4. Ensure the O-rings are correctly positioned on each end of the flow sensor before fitting the valve union nuts.

! CAUTION !

Avoid over tightening the union nuts and ensure to apply an equal counter force the union nut by using the hexagon of the Smart Flow sensor (Maximum torque of 15Nm). Ensure the electrical connection is pointing upwards or outwards.

E.3 ELECTRICAL

The Grant Smart Flow sensor is supplied with a pre-wired 5 core cable and connector.

- Align the connector with the flow sensor, taking note of the key.
- Insert and secure with the nut. Do not force or overtighten beyond hand tight.

Refer to Table E-2 and Section 5 pack schematics for wiring connections.

Table E-2: Smart Flow sensor wire connections

Wire Colour	Terminal Connection
Brown (Voltage)	+12V (G1 or G4)
White (Not connected)	-
Blue (Ground)	Terminal 32
Black (Signal)	Terminal 31
Grey (Not connected)	-

E.4 SENSOR CONFIGURATION

Once installed the Grant Aerona Smart controller will need to be configured to use the Smart Flow sensor. You will need to access the flow sensor settings. This is found in service settings (Refer to Section 8).

Table E-3: Smart Flow Sensor configuration settings

Parameter	
Flow Meter	Pulse
Specific Heat Capacity	4.180
Time detect(seconds)	120
Time alarm erase(seconds)	30
No flow detection threshold (M ³ /h)	0.1
No flow detection hysteresis (M ³ /h)	0.1
Pulse rate	200
Pulse counting time(seconds)	1
Too often alarm	3

Appendix F - How to Videos

F.1 ICONS OVERVIEW

QR CODE	DESCRIPTION
	<p>A video guide to provide a clear overview of the Grant Aerona Smart controller Home screen icons and what they represent.</p> <ul style="list-style-type: none"> • Heating circuits • DHW • Scheduling • Settings • Heat pump schematics • System schematics

F.5 SETTING THE HEATING SCHEDULE

QR CODE	DESCRIPTION
	<p>A video guide for how to access, create and copy a schedule for a heating circuit.</p> <ul style="list-style-type: none"> • Heating circuits • Scheduling • Setback

F.2 SETTING UP THE CONTROLLER

QR CODE	DESCRIPTION
	<p>A video guide to demonstrate the Grant Aerona Smart controller and its in-built system configurator.</p> <ul style="list-style-type: none"> • Heating Circuits • DHW • Outdoor Temperature Sensor • Setback • Weather control • Heating Curve • System configuration • System settings

F.6 SETTING THE HOT WATER SCHEDULE

QR CODE	DESCRIPTION
	<p>A video guide for how to access, create and copy a schedule for DHW.</p> <ul style="list-style-type: none"> • DHW • Scheduling

F.3 SETTING THE CIRCUIT TEMPERATURE

QR CODE	DESCRIPTION
	<p>A video guide for how to amend the required air temperature for a heating circuit.</p> <ul style="list-style-type: none"> • Heating Circuits

F.7 ADJUSTING THE HEATING CURVE

QR CODE	DESCRIPTION
	<p>A video guide for how to access and adjust the heating curve of a selected heating circuit.</p> <ul style="list-style-type: none"> • Heating circuit • Weather control • Heating curve • System settings

F.4 SETTING THE HOT WATER TEMPERATURE

QR CODE	DESCRIPTION
	<p>A video guide for how to amend the required water temperature for a DHW cylinder.</p> <ul style="list-style-type: none"> • DHW

F.8 SETTING UP LEGIONELLA PROTECTION

QR CODE	DESCRIPTION
	<p>A video guide for how to enable and set the Legionella protection.</p> <ul style="list-style-type: none"> • DHW • Legionella protection • Heater support • System settings

Notes



GRANT ENGINEERING (UK) LIMITED

Frankland Road, Blagrove Industrial Estate, Swindon, Wiltshire, SN5 8YG
Tel: +44 (0)1380 736920 Fax: +44 (0)1380 736991
Email: info@grantuk.com www.grantuk.com