



INSTALLATION AND OPERATION MANUAL

Reverse Osmosis system
Condair ML RO 100-1500 series

Thank you for choosing Condair

Installation date (MM/DD/YYYY):

Commissioning date (MM/DD/YYYY):

Site:

Model:

Serial number:

Manufacturer

Condair A/S
Parallevej 2, DK-8680 Ry
phone +45 8788 2100
condair.dk@condair.com, www.condair.dk

Proprietary Notice

This document and the information disclosed herein are proprietary data of Condair A/S. Neither this document, nor the information contained herein shall be reproduced, used, or disclosed to others without the written authorization of Condair A/S, except to the extent required for installation or maintenance of recipient's equipment.

Liability Notice

Condair A/S does not accept any liability due to incorrect installation or operation of the equipment or due to the use of parts/components/equipment that are not authorized by Condair A/S.

Copyright Notice

© Condair A/S All rights reserved.

Technical modifications reserved

Contents

1	General information	5
1.1	Foreword	5
1.2	Health and safety	6
1.3	Hygiene	6
1.3.1	Guidelines to ensure your system stays clean and prevent the growth of Legionella	7
1.4	Intended use	8
1.5	Ensure safe operation	8
1.6	Warranty	9
1.7	Delivery and storage	9
1.8	Correct method of lifting	9
1.9	Disposal	9
1.10	Disinfection	10
2	Product overview	11
2.1	ML RO description	11
2.2	Inlet water quality requirements	12
2.3	ML RO 100 - Piping Diagram	13
2.3.1	ML RO 100 - Part specification	14
2.4	ML RO 300 - Piping Diagram	15
2.4.1	ML RO 300 - Part specification	16
2.5	ML RO 500 - Piping Diagram	17
2.5.1	ML RO 500 - Part specification	18
2.6	ML RO 800 - Piping Diagram	19
2.6.1	ML RO 800 - Part specification	20
2.7	ML RO 1000 - Piping Diagram	21
2.7.1	ML RO 1000 - Part specification	22
2.8	ML RO 1500 - Piping Diagram	23
2.8.1	ML RO 1500 - Part specification	24
2.9	Optional equipment for ML RO	25
2.10	Rating plate and markings	26
2.11	Electrical schematic diagrams	26
3	Installation	27
3.1	Important notes on installation	27
3.1.1	Qualification of personnel	27
3.1.2	Safety	27
3.1.3	Tools needed for installation work	28
3.1.4	Positioning and installation notes	28
3.2	Positioning the pump station	29
3.2.1	Drain	30
3.2.2	Water connection	30
3.3	Electrical installation	31

4	Commissioning	32
4.1	Tools and materials for commissioning work	32
4.2	Installing the inlet filter	33
4.3	Insert RO membrane	34
4.4	Install RO tank breathing filter	34
4.5	Basic set-up of the controller	35
4.6	Option setup	38
4.7	RO membrane flush and startup	40
4.8	Adjusting the reverse osmosis	42
4.8.1	Explanation of technical terminology	42
4.8.2	Water quality	43
4.8.3	Adjustment of outlet amount	44
4.8.4	Adjustment of permeate amount	45
5	Operation	46
5.1	Overview control unit	46
5.2	Equipment protection	47
5.3	Alarm messages	48
5.4	Operational messages	49
5.5	Controller menu	50
5.5.1	Start page - basic settings	50
5.5.2	Operation and menu page	51
5.5.3	Alarms messages	52
5.5.4	Pump setup	52
5.5.5	Pages for the EC monitoring and regulation (option)	53
5.6	Weekly inspection	53
6	Maintenance	54
6.1	Important notes on maintenance	54
6.2	Maintenance work	55
6.3	Preventive spare parts chart	56
6.4	Weekly check list	57
6.5	Troubleshooting	58
6.5.1	Malfunction with error indication	58
6.5.2	Resetting the error indication	59
6.5.3	Malfunction without error indication	60
7	Product data	61
7.1	Water supply preconditions	61
7.2	Product specifications	62
8	Declaration of conformity	63
9	Appendix	64
9.1	MODBUS communication TCP/IP	64
9.2	Water softener MACH 2030, 2060, 2100 & CP 213S	66
9.2.1	Installation instructions	66
9.2.2	Start-up procedure	67
9.2.3	Declaration of conformity water softening units	69

1 General information

1.1 Foreword

This manual has been written to ensure the safe use, performance and longevity of the equipment, and is intended for use by engineers and properly trained technical personnel. Please read this manual thoroughly before specifying, designing or installing an ML-System from Condair A/S. Keep for future reference.

As our policy is one of continuous research and development, we reserve the right to amend, without notice, the specifications provided in this document. Condair A/S does not guarantee nor accept liability for the accuracy of information in this document.



DANGER! **Danger of electric shock!**

Installations and electrical connection must only be done by trained technicians and according to local standards.

High voltages, danger of electric shock! Touching live parts may cause severe injury or death.



WARNING!

Do not retighten/unscrew hoses while the system is pressurised!

The system start-up must be carried out or monitored by persons approved and trained by Condair. Errors in the start-up phase may ultimately result in illness, injury and death of humans.



CAUTION!

Do not use oil, grease, glue, Teflon, silicone, O-ring lubrication, etc. when assembling pipes or hose connections. All of these products can lead to the growth of bacteria and thus pose health risks.

Only approved lubricant is: **Dishwashing liquid**.

Always wash your hands and wear clean disposable gloves while assembling parts in direct contact with water.

Do not remove dust protection caps on pipe and hose ends until just before assembly.

Do not fasten the pump station or hoses/pipes to vibrating installations

When fitting water filters, RO membranes, hoses and other components in direct contact with water, wash your hands and wear sterile disposable gloves or touch only the packing foil to keep the filter and RO membranes bacteria-free.

1.2 Health and safety

Installation, maintenance, repair work or decommissioning should only be carried out by appropriately qualified and properly trained technical personnel. The users are responsible for ensuring their suitability. The customer is responsible for ensuring that the installation of the equipment complies with all local regulations.

Any risks or hazards relating to the system, including during installation and maintenance, should be identified by a competent health and safety representative who is responsible for introducing effective control measures.

All ideograms, signs and markings applied to the unit must be observed and kept in a readable state.

1.3 Hygiene

Please observe the local health and safety executive's technical guidance on the control of Legionellosis in water systems.

The user is responsible for ensuring that the water system complies with local regulations, byelaws and guidelines (such as the HSE ACoP L8, VDI 6022, ISO 22000, HACCP or equivalent). If inadequately maintained, the RO system can support the growth of microorganisms, including the bacterium that causes Legionnaires' disease.

The ML RO is produced according to the ISO 22000 standards, which means that we have considered all aspects of this equipment to reduce the risk of Legionnaires' disease and other similar conditions. However, the user is responsible for ensuring that the installation, operation and maintenance work on the equipment is performed in a manner ensuring that the system stays clean!

Any risks or hazards relating to the system, including during installation and maintenance, should be identified by a competent health and safety representative who is responsible for introducing effective control measures.



The ML RO must be installed, operated and maintained in accordance with this manual. Failure to do so could result in contamination that might cause Legionnaires' disease, which can be fatal.



To prevent water stagnation and microbial contamination, the ML RO power supply should be left switched on. If the system is switched off for more than 48 hours, the pipework and system must be disinfected as per the instructions, and a full risk assessment must be undertaken to ensure safe operation.

1.3.1 Guidelines to ensure your system stays clean and prevent the growth of Legionella

- Carry out a risk assessment of the water system using a competent person, and implement an appropriate monitoring and control programme.
- Initiate procedures for checking the UV system, cleaning tanks, changing filters, disinfection etc.
- The ML RO must be connected to a clean, potable mains water supply.
- Enter into a service contract that suits your company.
- Stop the system if polluted drinking water is found in your area.
- Avoid water temperatures between 25°C and 45°C that favour the growth of Legionella.
- Do not stop the system unless it is faulty or leaking (avoid water stagnation)
- Refrain from closing nozzles or sections, unless there is leakage or a fault (avoid water stagnation)
- Disinfect the high-pressure system at least once a year and after every maintenance or repair. Always carry out a complete system disinfection if it has been turned off for more than 48 hours.
- Have water samples taken and tested for harmful bacteria at least once a year.
- Conduct follow-up measurements until the system is clean if bacteria have been detected in the system.

The Condair service team can help

Condair has expert technicians who can provide:

- Bacteriological troubleshooting on site *
- Cleaning and disinfecting
- Preventive maintenance
- Repair and fault finding
- Training and guidance

*Condair uses a quick method for measuring bacterial activity in the water: the approved and patented BactiQuant. Once the water sample has been taken, we can read the bacteriological quality of the water within 30 minutes, and disinfect the system if necessary.

Condair follows the guidelines in VDI 6022 for CFU counts in humidifiers. The CFU count in the humidification water must not exceed 150 CFU/ml, corresponding to a maximum BQ value of 40.

Please contact your local Condair representative for further information about our services.

1.4 Intended use

The ML RO is designed for producing RO water and delivering this from its holding tank at a pressure of 3 bars. Any other, or further, application is not considered use for the intended purpose. Condair A/S cannot be made liable for any damage or injury attributable to inattentive, inappropriate, negligent or incorrect operation of the equipment, whether or not caused deliberately.

Operation of the equipment in the intended manner requires that all the information in this installation and operation manual be observed (in particular the safety instructions).

Potential danger related to the ML RO



Risk of electric shock! A person may come in contact with live parts when the pump station/control unit is open. Touching live parts may cause severe injury or death.

Prevention: Before carrying out any work on the system, disconnect power and water supply.



Poorly maintained RO systems may be hazardous.

Prevention: read, understand and follow maintenance guidelines to ensure your system stays safe.



Water produced from a RO system is very aggressive and can cause metals to corrode quickly. The RO system should always be connected to piping / equipment suitable for handling RO water.

1.5 Ensure safe operation

If it is suspected that safe operation has been compromised, the ML RO should immediately be shut down and secured against accidental power-up.

Shut down the ML RO if:

- ML RO components are damaged, worn or very soiled.
- The ML RO does not work correctly.
- Joints, pipes or hoses are leaking.

No modifications must be made on the ML RO without the manufacturer's consent. All persons working with the ML RO must report any alterations made to the ML RO to the owner immediately.

Use only original accessories and spare parts available from your Condair representative.

1.6 Warranty

ML RO parts are covered by a two-year warranty from the invoice date with the exception of the replacement parts listed in the routine maintenance section ([chapter 6](#)). Failure to observe the manufacturer's installation and maintenance recommendations and instructions will invalidate the warranty. Condair A/S cannot be made liable for damage or injury attributable to failure to observe the manufacturer's installation and maintenance recommendations and instructions.

1.7 Delivery and storage

To ensure consistent quality, each ML RO is tested and preserved before leaving the factory. If put into storage prior to use, the ML RO must be covered and protected from physical damage, dust, frost and rain. It is recommended that the ML RO be kept in its transit packaging for as long as possible prior to installation.

Inspection upon receipt: remove the transit packaging and inspect the unit to ensure that no damage has occurred during transit. Any visible damage must be reported to your Condair distributor immediately. If the unit is put into storage, the packaging should be replaced.

1.8 Correct method of lifting

Lifting or handling must only be carried out by trained and qualified personnel. Ensure that the lifting operation has been properly planned and risk-assessed, and that all equipment has been checked by a skilled and competent health and safety representative.

The customer is responsible for ensuring that operators are trained in handling heavy goods, and to enforce the relevant lifting regulations. Refer to the weights and measures in [chapter 7.2](#) for system weight.

1.9 Disposal

You must observe local laws and regulations when disposing of your ML RO at the end of its working life. The pumps and piping are constructed from stainless steel which may be fully recycled.

1.10 Disinfection

Depending on the system hygiene, it is advised that preventative disinfection fluid is added to the ML RO water tank at an appropriate frequency, but at least once a year.

Condair A/S recommends adding the disinfection fluid SANOSIL S010 AG 5% (our code: 155404000) to the tank, desired concentration 0.1%. SANOSIL is safe, non-toxic and eco-friendly which provides a prophylactic, disinfection dose and is effective against all types of microorganisms, including Legionella and E.coli.

Please read the Maintenance section (see [chapter 6](#)) for more information on disinfection.

If you are in any doubt about the suitability of water quality, please contact your Condair distributor who will be happy to support you.

2 Product overview

2.1 ML RO description

The reverse osmosis system (from now on called RO) with reservoir tank is for removal (>95%) of salts and minerals in tap water.

The systems are developed by Condair A/S with focus on reliable and hygienically correct solutions. The system uses a membrane separation process in which water molecules can pass through the membrane, while the majority of salts and minerals are retained and thereafter flushed out the drain.

The system components are fitted on an "easy-to-place" base frame. The ML RO 100 and 300 have 55 l (15 gal) holding tank for the produced RO water, mounted directly on the pump frame. The holding tanks of ML RO 500, 800, 1000 and 1500 are placed on separate frames (200 l (53 gal), 500 l (132 gal), 1000 l (264 gal)).

There are two or three pumps on the pump frame: The RO pump(s) which pumps the raw water through the RO membrane at a pressure of 8-12 bar and into the RO water tank. RO water transfer pump, which delivers pressurized RO water to the consumer at 3.5 bar.

All components exposed to water are made of corrosion-resistant material. All hoses are steel-reinforced and drinking water-approved.

Both the transfer and RO pump are directly mounted on their electric motors. Power is supplied to the 3-phase asynchronous motors via a magnet-operated protective motor switch.

The transfer pump is protected against dry running by the level sensor in the RO tank that stops the system if the tank is empty.

A pressure switch just after the inlet filter protects the RO pump from dry running.

The control unit consists of a touch display and a PLC mounted in the IP 65-rated electrical cabinet.

From the touch screen, the operator can change settings, adjust alarm limits and view hour counters, logged alarms, etc.

The ML RO's are delivered assembled, tested, and ready to use.

2.2 Inlet water quality requirements

The quality of the water being used in the ML RO system should be checked prior to system commissioning. Condair A/S recommends that the ML RO system is connected to a clean, potable (drinking water quality) mains water supply. If the inlet water does not meet the quality specified in the preconditions table, it may be necessary to install additional water treatment.

Preconditions	
ML RO 100 consumption and inlet pressure	200 l/h @ 2.5-7 bar (dynamic)
ML RO 300 consumption and inlet pressure	600 l/h @ 2.5-7 bar (dynamic)
ML RO 500 consumption and inlet pressure	700 l/h @ 2.5-7 bar (dynamic)
ML RO 800 consumption and inlet pressure	1100 l/h @ 2.5-7 bar (dynamic)
ML RO 1000 consumption and inlet pressure	1400 l/h @ 2.5-7 bar (dynamic)
ML RO 1500 consumption and inlet pressure	2100 l/h @ 2.5-7 bar (dynamic)
Connection inlet	G 3/4"
Connection outlet	G 3/4"
Water supply	Potable water quality
Hardness: ML RO 100, 300	max. 20 °dH
Hardness: ML RO 500, 800, 1000, 1500	max. 1 °dH
Conductivity	120-1000 µS/cm
Free chlorine	0,1 mg/L
TDS	max. 625 mg/l
Silt index	max. 3.0
KMnO ₄	max. 10 mg/l
Fe	max. 0.2 mg/l
Mn	max. 0.05 mg/l
NTU	max. 1.0
Temperature of inlet water	max. 40°C Recommended max 15°C (hygienic precaution)

2.3 ML RO 100 - Piping Diagram

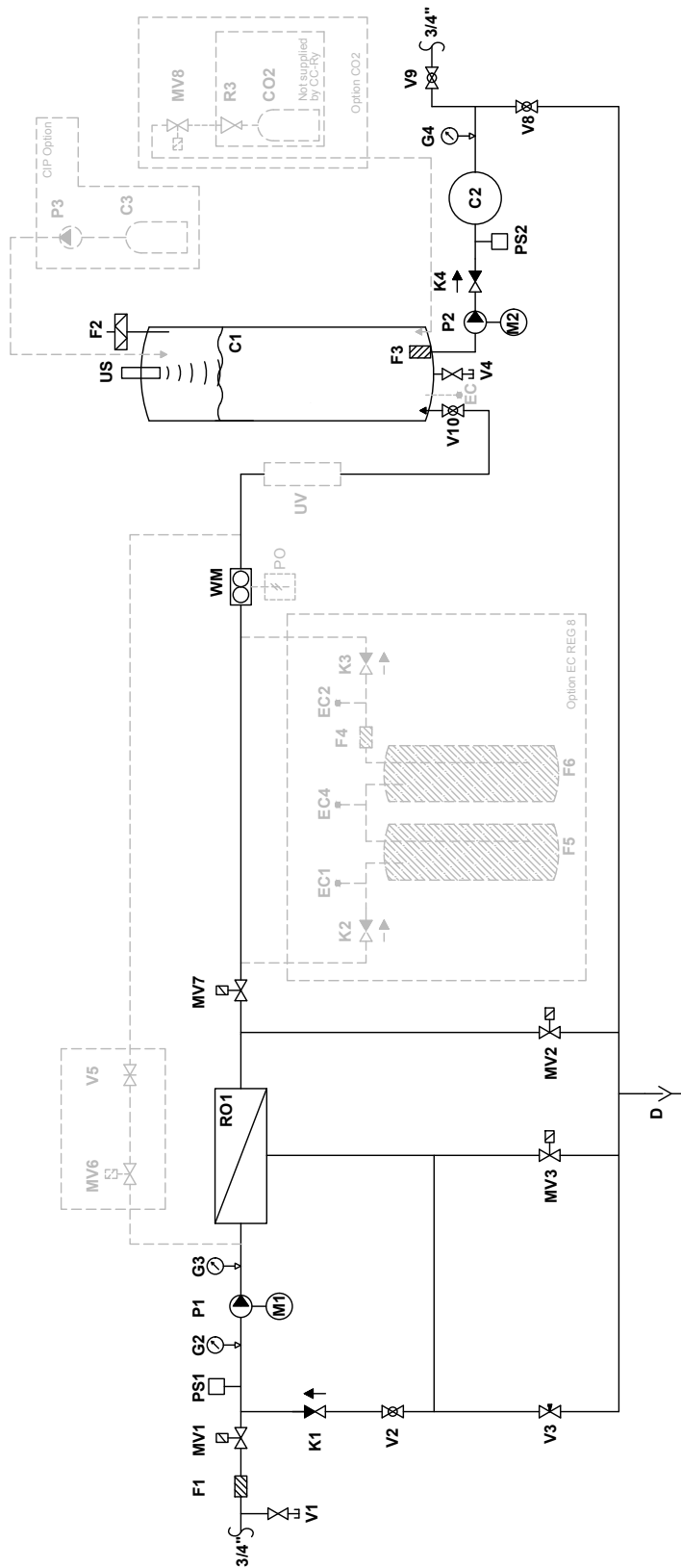

Fig. 1: ML RO 100 - Piping Diagram

2.3.1 ML RO 100 - Part specification

C1	Permeate tank, 55 l
C2	Hydrophore, 8 l
D	Drain pipe, 3/4" RG
F1	Filter 20", 5 µm
F2	Sterile breathing filter 0.2 µm
F3	Suction filter
G2	Pressure gauge, inlet pressure RO pump 0-10 bar
G3	Pressure gauge, RO pump pressure 0-10 bar
G4	Pressure gauge, 0-10 bar
K1	Check valve 16 bar, reverse pressure max 0,1 bar
K4	Check valve
M1/P1	RO pump
M2/P2	Feed pump
MV1	ON/OFF valve, 0-10 bar
MV2	Valve for flushing at start-up
MV3	Valve for membrane flushing
MV7	ON/OFF valve
PS1	Pressure switch, pre-adjusted to 0.5 bar
PS2	Pressure switch, type CS
RO1	RO membrane in stainless steel housing
US	Ultra sound level sensor
V1	Test water tap 1/8"
V2	Ball valve for pressure adjustment
V3	Needle valve for concentrate outlet adjustment
V4	Test water tap 1/8"
V8	Ball valve
V9	Ball valve
V10	Ball valve
WM	Water meter for permeate

Misc. options

MV6	(Option)	Valve for raw water mix, 0-10 bar
UV	(Option)	UV system
V5	(Option)	Needle valve

CO₂ option

CO ₂	(Option)	CO ₂ container
MV8	(Option)	Valve for CO ₂
R3	(Option)	CO ₂ pressure regulator

CIP option

C3	(Option)	CIP container, 1 l plastic bottle
P3	(Option)	CIP pump

EC REG 8 option

EC1	(Option)	Conductivity sensor
EC2	(Option)	Conductivity sensor
EC4	(Option)	Conductivity sensor
F4	(Option)	Filter 5", 5 µm
F5	(Option)	Mixbed, ion exchange bottle (acquired locally)
F6	(Option)	Mixbed, ion exchange bottle (acquired locally)
K2	(Option)	Check valve
K3	(Option)	Check valve

EC option

EC	(Option)	Conductivity sensor
----	----------	---------------------

PO option

PO	(Option)	Pulse output for water meter
----	----------	------------------------------

2.4 ML RO 300 - Piping Diagram

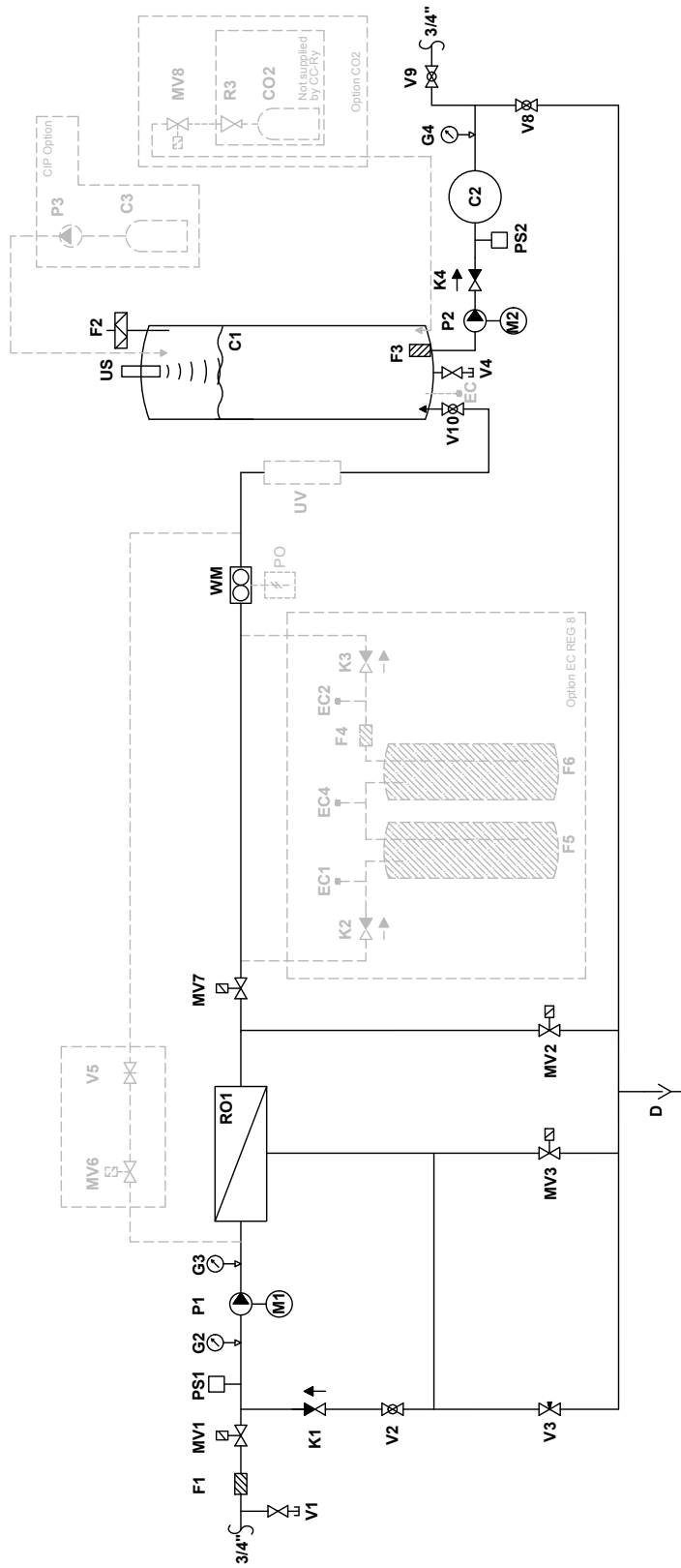

Fig. 2: ML RO 300 - Piping Diagram

2.4.1 ML RO 300 - Part specification

C1	Permeate tank, 55 l
C2	Hydrophore, 8 l
D	Drain pipe, 3/4" RG
F1	Filter 20", 5 µm
F2	Sterile breathing filter 0.2 µm
F3	Suction filter
G2	Pressure gauge, inlet pressure RO pump 0-10 bar
G3	Pressure gauge, RO pump pressure 0-10 bar
G4	Pressure gauge, 0-10 bar
K1	Check valve 16 bar, reverse pressure max 0,1 bar
K4	Check valve
M1/P1	RO pump
M2/P2	Feed pump
MV1	ON/OFF valve, 0-10 bar
MV2	Valve for flushing at start-up
MV3	Valve for membrane flushing
MV7	ON/OFF valve
PS1	Pressure switch, pre-adjusted to 0.5 bar
PS2	Pressure switch, type CS
RO1	RO membrane in stainless steel housing
US	Ultra sound level sensor
V1	Test water tap 1/8"
V2	Ball valve for pressure adjustment
V3	Needle valve for concentrate outlet adjustment
V4	Test water tap 1/8"
V8	Ball valve
V9	Ball valve
V10	Ball valve
WM	Water meter for permeate

Misc. options

MV6	(Option)	Valve for raw water mix, 0-10 bar
UV	(Option)	UV system
V5	(Option)	Needle valve

CO₂ option

CO ₂	(Option)	CO ₂ container
MV8	(Option)	Valve for CO ₂
R3	(Option)	CO ₂ pressure regulator

CIP option

C3	(Option)	CIP container, 1 l plastic bottle
P3	(Option)	CIP pump

EC REG 8 option

EC1	(Option)	Conductivity sensor
EC2	(Option)	Conductivity sensor
EC4	(Option)	Conductivity sensor
F4	(Option)	Filter 5", 5 µm
F5	(Option)	Mixbed, ion exchange bottle (acquired locally)
F6	(Option)	Mixbed, ion exchange bottle (acquired locally)
K2	(Option)	Check valve
K3	(Option)	Check valve

EC option

EC	(Option)	Conductivity sensor
----	----------	---------------------

PO option

PO	(Option)	Pulse output for water meter
----	----------	------------------------------

2.5 ML RO 500 - Piping Diagram

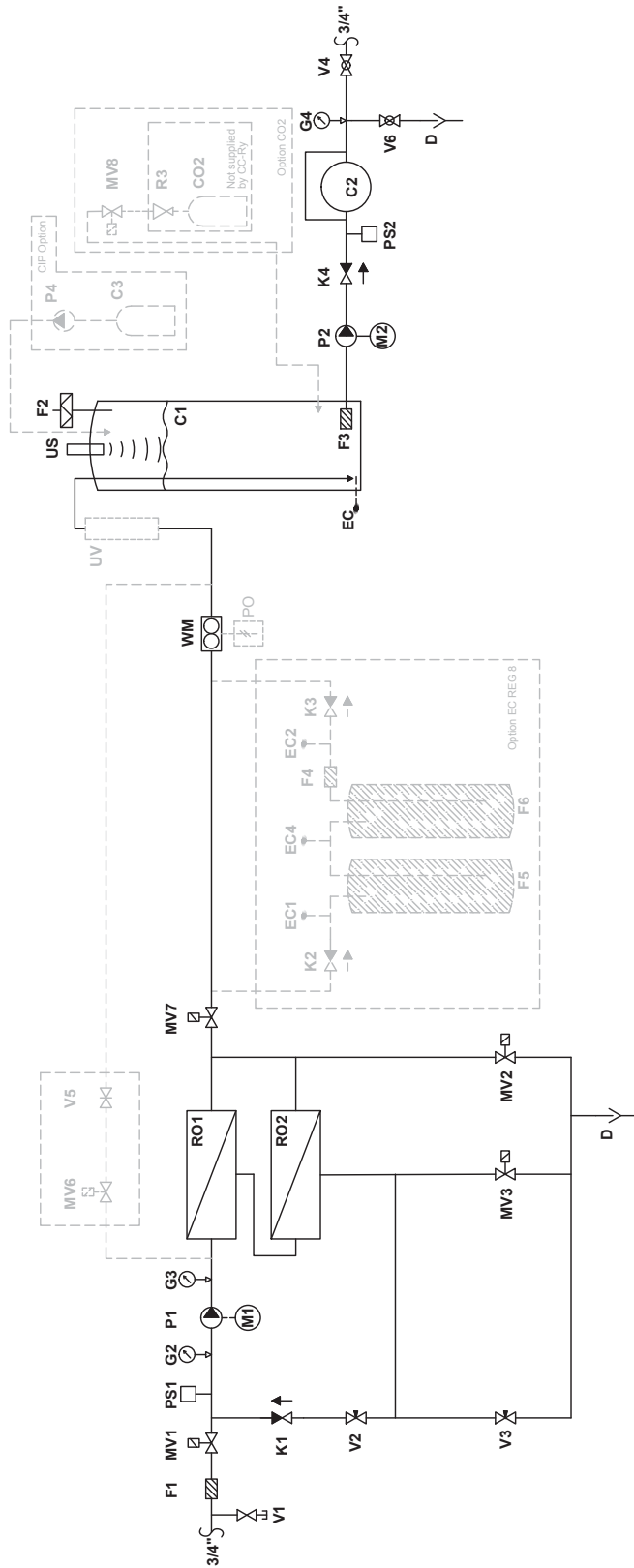

Fig. 3: ML RO 500 - Piping Diagram

2.5.1 ML RO 500 - Part specification

C1	Permeate tank, 200 l, external on stand
C2	Hydrophore, flowthrough, 8 l
D	Drain pipe, 3/4" RG
F1	Filter 20", 5 µm
F2	Sterile breathing filter 0.2 µm
F3	Suction filter
G2	Pressure gauge, inlet pressure RO pump 0-10 bar
G3	Pressure gauge, RO pump pressure 0-10 bar
G4	Pressure gauge, 0-10 bar
K1	Check valve
K4	Check valve
M1/P1	RO pump
M2/P2	Feed pump
MV1	ON/OFF valve, 0-10 bar, 3/4"
MV2	Valve for flushing at start-up
MV3	Valve for membrane flushing
MV7	ON/OFF valve
P2	PAHT high pressure pump 70 bar
PS1+2	Pressure switch, pre-adjusted to 0.5 bar
RO1-2	RO membrane in stainless steel housing
US	Ultra sound level sensor
V1	Test water tap 1/8"
V2	Valve for pressure adjustment
V3	Needle valve for concentrate outlet adjustment
V4	Ball valve
V6	Drain valve
WM	Water meter for permeate

Misc. options

MV6	(Option)	Valve for raw water mix, 0-10 bar
UV	(Option)	UV system
V5	(Option)	Needle valve

CO₂ option

CO ₂	(Option)	CO ₂ container
MV8	(Option)	Valve for CO ₂
R3	(Option)	CO ₂ pressure regulator

CIP option

C3	(Option)	CIP container, 1 l plastic bottle
P3	(Option)	CIP pump

EC REG 8 option

EC1	(Option)	Conductivity sensor
EC2	(Option)	Conductivity sensor
EC4	(Option)	Conductivity sensor
F4	(Option)	Filter 5", 5 µm
F5	(Option)	Mixedbed, ion exchange bottle (acquired locally)
F6	(Option)	Mixedbed, ion exchange bottle (acquired locally)
K2	(Option)	Check valve
K3	(Option)	Check valve

EC option

EC	(Option)	Conductivity sensor
----	----------	---------------------

PO option

PO	(Option)	Pulse output for water meter
----	----------	------------------------------

2.6 ML RO 800 - Piping Diagram

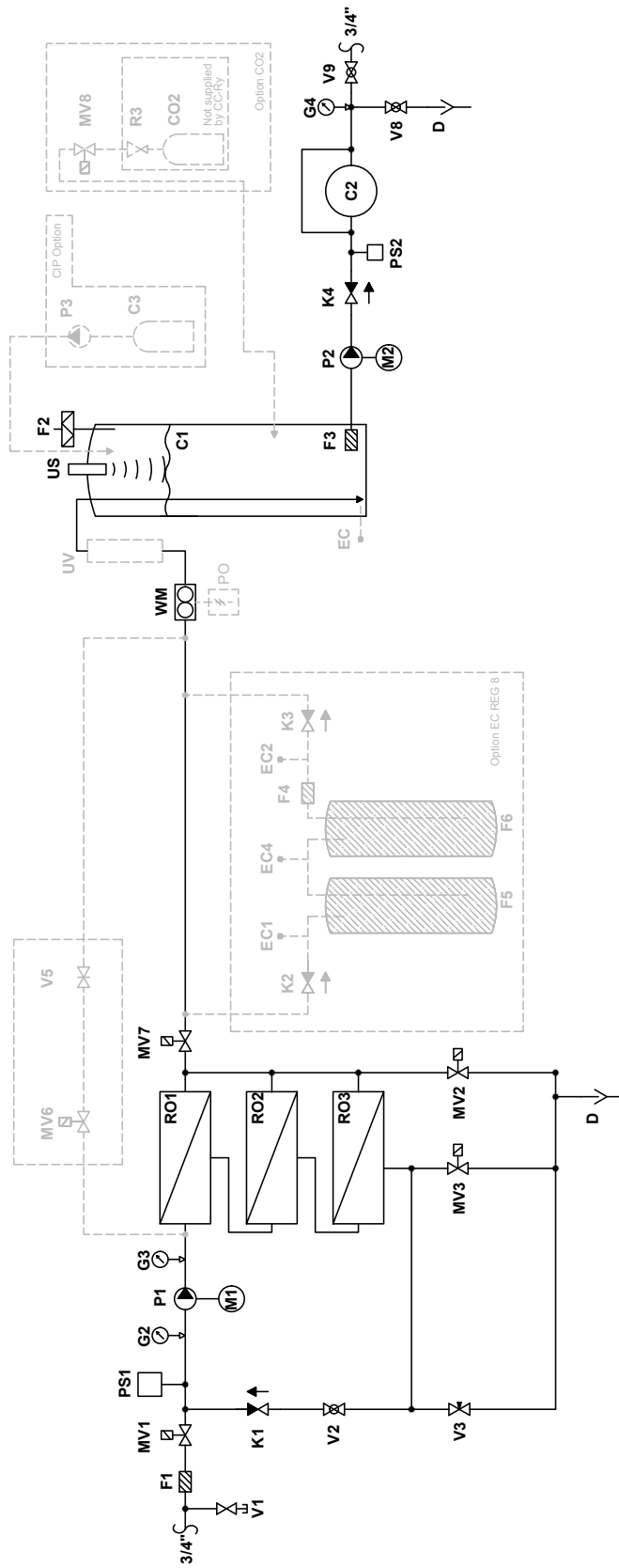

Fig. 4: ML RO 800 - Piping Diagram

2.6.1 ML RO 800 - Part specification

C1	Permeate tank, 500 l, external on stand
C2	Hydrophore, flowthrough, 8 l
D	Drain pipe, 3/4" RG
F1	Filter 20", 5 µm
F2	Sterile breathing filter 0.2 µm
F3	Suction filter
G2	Pressure gauge, inlet pressure RO pump 0-10 bar
G3	Pressure gauge, RO pump pressure 0-10 bar
G4	Pressure gauge, 0-10 bar
K1	Check valve 16 bar, back pressure max 0,1 bar
K4	Check valve
M1/P1	RO pump
M2/P2	Feed pump
MV1	ON/OFF valve, 0-10 bar
MV2	Valve for flushing at start-up
MV3	Valve for membrane flushing
MV7	ON/OFF valve
PS1	Pressure switch, pre-adjusted to 0.5 bar
PS2	Pressure switch, type CS
RO1-3	RO membrane in stainless steel housing
US	Ultra sound level sensor
V1	Test water tap 1/8"
V2	Ball valve for pressure adjustment
V3	Needle valve for concentrate outlet adjustment
V8	Ball valve
V9	Ball valve
WM	Water meter for permeate

Misc. options

MV6	(Option)	Valve for raw water mix, 0-10 bar
UV	(Option)	UV system
V5	(Option)	Needle valve

CO₂ option

CO ₂	(Option)	CO ₂ container
MV8	(Option)	Valve for CO ₂
R3	(Option)	CO ₂ pressure regulator

CIP option

C3	(Option)	CIP container, 1 l plastic bottle
P3	(Option)	CIP pump

EC REG 8 option

EC1	(Option)	Conductivity sensor
EC2	(Option)	Conductivity sensor
EC4	(Option)	Conductivity sensor
F4	(Option)	Filter 5", 5 µm
F5	(Option)	Mixedbed, ion exchange bottle (acquired locally)
F6	(Option)	Mixedbed, ion exchange bottle (acquired locally)
K2	(Option)	Check valve
K3	(Option)	Check valve

EC option

EC	(Option)	Conductivity sensor
----	----------	---------------------

PO option

PO	(Option)	Pulse output for water meter
----	----------	------------------------------

2.7 ML RO 1000 - Piping Diagram

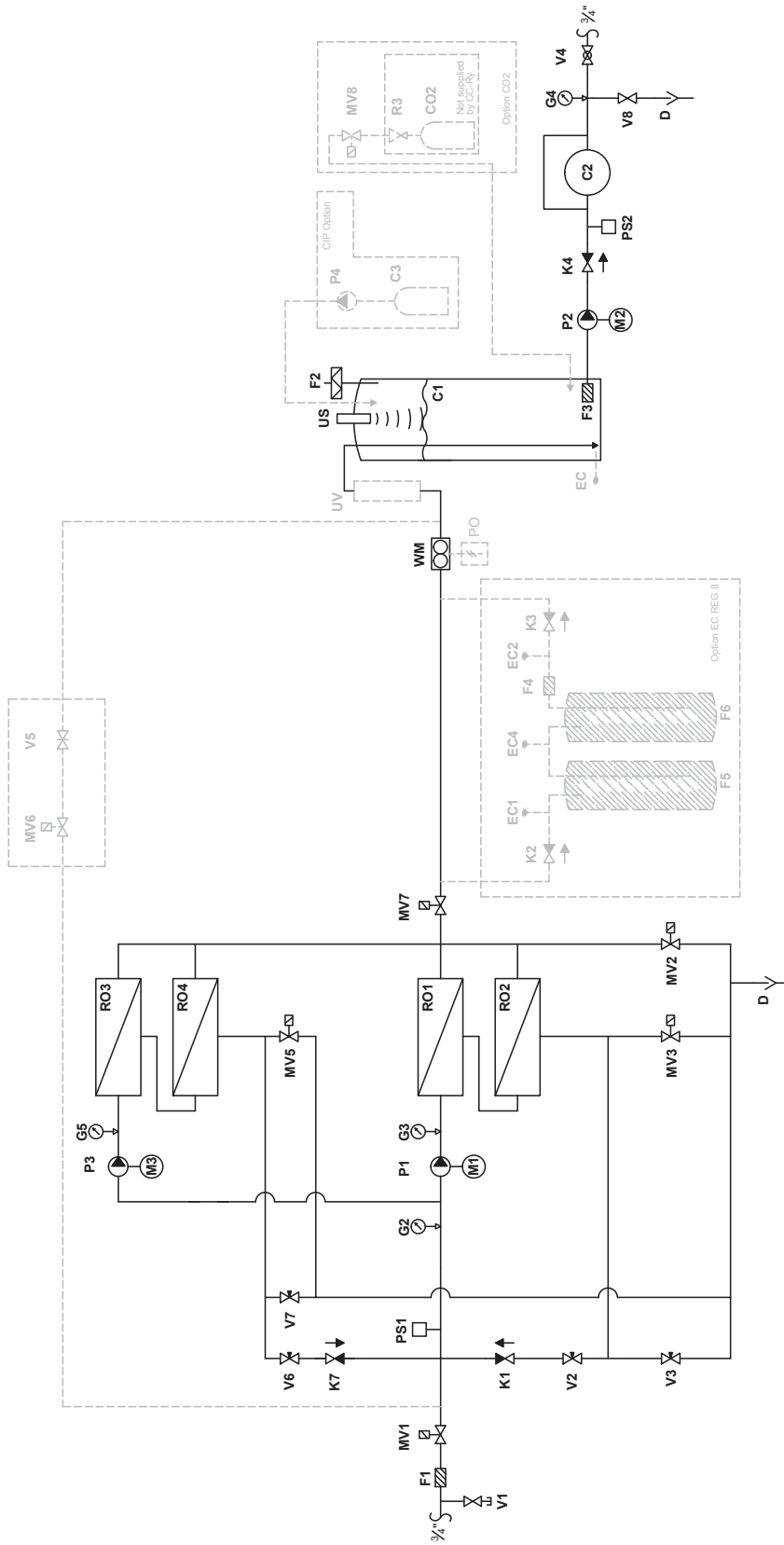

Fig. 5: ML RO 1000 - Piping Diagram

2.7.1 ML RO 1000 - Part specification

C1		Permeate tank, 500 l, external on stand
C2		Hydrophore, flowthrough, 8 l
D		Drain pipe, 3/4" RG
F1		Filter 20", 5 µm
F2		Sterile breathing filter 0.2 µm
F3		Suction filter
G2		Pressure gauge, inlet pressure RO pump 0-10 bar
G3+G5		Pressure gauge, RO pump pressure 0-10 bar
G4		Pressure gauge
K1		Check valve 16 bar, back pressure max 0,1 bar
K4		Check valve
M1/P1		RO pump
M2/P2		Feed pump
M3/P3		RO pump
MV1		ON/OFF valve, 0-10 bar
MV2		Valve for flushing at start-up
MV3+MV5		Valve for membrane flushing
MV7		ON/OFF valve
PS1		Pressure switch, pre-adjusted to 0.5 bar
PS2		Pressure switch, type CS
RO1-4		RO membrane in stainless steel housing
US		Ultra sound level sensor
V1		Test water tap 1/8"
V2+V6		Valve for pressure adjustment
V3+V7		Needle valve for concentrate outlet adjustment
V4		Ball valve
V8		Drain valve
WM		Water meter for permeate

Misc. options

MV6	(Option)	Valve for raw water mix, 0-10 bar
UV	(Option)	UV system
V5	(Option)	Needle valve

CO₂ option

CO ₂	(Option)	CO ₂ container
MV8	(Option)	Valve for CO ₂
R3	(Option)	CO ₂ pressure regulator

CIP option

C3	(Option)	CIP container, 1 l plastic bottle
P4	(Option)	CIP pump

EC REG 8 option

EC1	(Option)	Conductivity sensor
EC2	(Option)	Conductivity sensor
EC4	(Option)	Conductivity sensor
F4	(Option)	Filter 5", 5 µm
F5	(Option)	Mixedbed, ion exchange bottle (acquired locally)
F6	(Option)	Mixedbed, ion exchange bottle (acquired locally)
K2	(Option)	Check valve
K3	(Option)	Check valve

EC option

EC	(Option)	Conductivity sensor
----	----------	---------------------

PO option

PO	(Option)	Pulse output for water meter
----	----------	------------------------------

2.8 ML RO 1500 - Piping Diagram

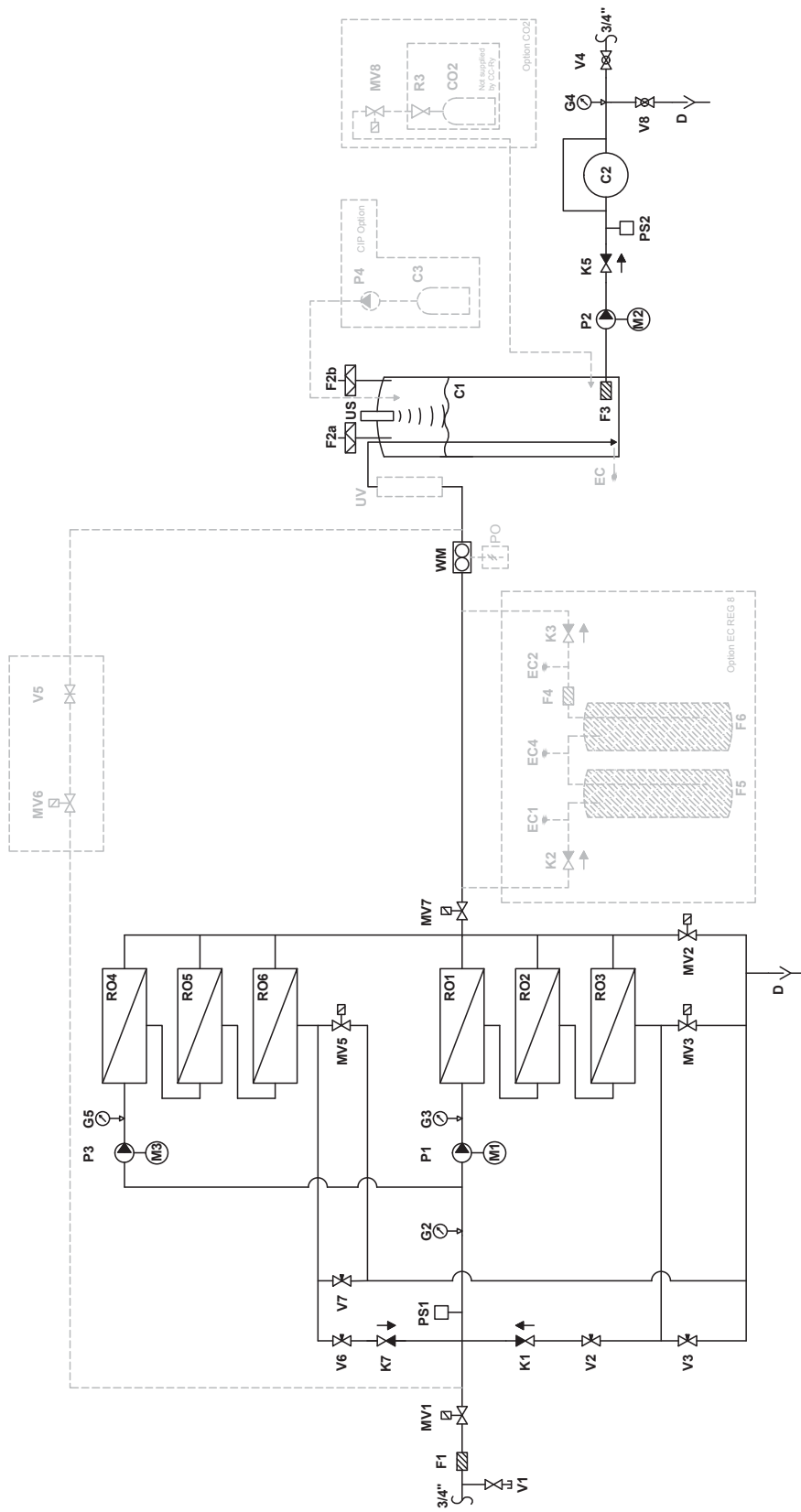

Fig. 6: ML RO 1500 - Piping Diagram

2.8.1 ML RO 1500 - Part specification

C1		Permeate tank, 500 l, external on stand
C2		Hydrophore, flowthrough, 18 l
D		Drain pipe, 3/4" RG
F1		Filter 20", 5 µm
F2a+b		Sterile breathing filter 0.2 µm
F3		Suction filter
G2		Pressure gauge, inlet pressure RO pump 0-10 bar
G3+G5		Pressure gauge, RO pump pressure 0-10 bar
G4		Pressure gauge
K1		Check valve 16 bar, back pressure max 0,1 bar
K5		Check valve
M1/P1		RO pump
M2/P2		Feed pump
M3/P3		RO pump
MV1		ON/OFF valve, 0-10 bar
MV2		Valve for flushing at start-up
MV3+MV5		Valve for membrane flushing
MV7		ON/OFF valve, 0-10 bar
PS1		Pressure switch, pre-adjusted to 0.5 bar
PS2		Pressure switch, type CS
RO1-6		RO membrane in stainless steel housing
US		Ultra sound level sensor
V1		Test water tap 1/8"
V2+V6		Valve for pressure adjustment
V3+V7		Needle valve for concentrate outlet adjustment
V4		Ball valve
V8		Drain valve
WM		Water meter for permeate

Misc. options

MV6	(Option)	Valve for raw water mix, 0-10 bar
UV	(Option)	UV system
V5	(Option)	Needle valve

CO₂ option

CO ₂	(Option)	CO ₂ container
MV8	(Option)	Valve for CO ₂
R3	(Option)	CO ₂ pressure regulator

CIP option

C3	(Option)	CIP container, 1 l plastic bottle
P4	(Option)	CIP pump

EC REG 8 option

EC1	(Option)	Conductivity sensor
EC2	(Option)	Conductivity sensor
EC4	(Option)	Conductivity sensor
F4	(Option)	Filter 5", 5 µm
F5	(Option)	Mixedbed, ion exchange bottle (acquired locally)
F6	(Option)	Mixedbed, ion exchange bottle (acquired locally)
K2	(Option)	Check valve
K3	(Option)	Check valve

EC option

EC	(Option)	Conductivity sensor
----	----------	---------------------

PO option

PO	(Option)	Pulse output for water meter
----	----------	------------------------------

2.9 Optional equipment for ML RO

Optional and ancillary equipment can be divided into the two groups:

– **ML RO options:**

Added features which are intergrated into the controller of the ML RO or placed on its frame, e.g UV filter, conductivity measurement, ultra-pure water (mixed bed), CIP system, CO₂ adding.

– **Pre-treatment:**

Stand-alone systems for improving the water quality in order to meet the inlet water quality requirements for the ML RO, e.g. booster pump, non-return valve, silt/pre-filter, carbon filter and softener. Ask your local Condair dealer for additional information on pre-treatment equipment.

Preconditions	
UV - Lamp	Adding a UV lamp ensures a high level of hygiene in the produced RO water. Condair a/s strongly recommends having a UV lamp when the RO Water is to be used in a adiabatic humidifier.
ML EC REG 1 Conductivity sensor (in RO tank)	Measuring the conductivity (µS) of the RO water in the RO tank, incl. Hi/Low alarms.
ML EC-REG 2 (inlet water mixer)	Mixes inlet water in the produced water from the RO membrane in order to raise the conductivity of the RO water.
ML EC-REG 6 (CO ₂ mixer)	Mixes CO ₂ in the produced water from the RO membrane in order to increase RO water conductivity (CO ₂ tanks and regulator are not included).
ML EC-REG 7 Mixed bed, preparation for 1 mixed bed filter	1 mixed-bed bottle connection with sensors, alarms and CO ₂ Adding to the tank (CO ₂ tanks and regulator are not included).
ML EC-REG 8 Mixed bed, preparation for double mixed bed filter	2 mixed-bed bottle connection with sensors, alarms and CO ₂ Adding to the tank (CO ₂ tanks and regulator are not included) Note: Having 2 mixed-bed bottles gives you an early warning when to change the bottle and minimizes the risk of salt breakthroughs.
Log option	Creates a logfile from the EC measurements (Note: Needs one EC-reg option).
BAS/BMS integration Modbus TCP/IP	Displays the operating humidity and alarm status of the system via a TPC/IP protocol.
CIP (clean-in-place)	Function that adds a small amount of disinfection into the water circuit, to prevent bacterial growth.
PLC webserver access	Access to the PLC's homepage from a standard browser. Displays the operating status and humidity for each zone.
Pulse generator for water meter	The water meter is equipped with a pulse emitter which can be linked to tele-reading systems, the PLC and to M-Bus networks.

2.10 Rating plate and markings

The rating plate is placed in the upper left corner on the side of the control cabinet (when facing the front).



Fig. 7: Rating plate

A label with the internal order number and electrical schematic diagram number is placed on the inside of the left-hand cabinet hatch (when facing the front) on the control cabinet.

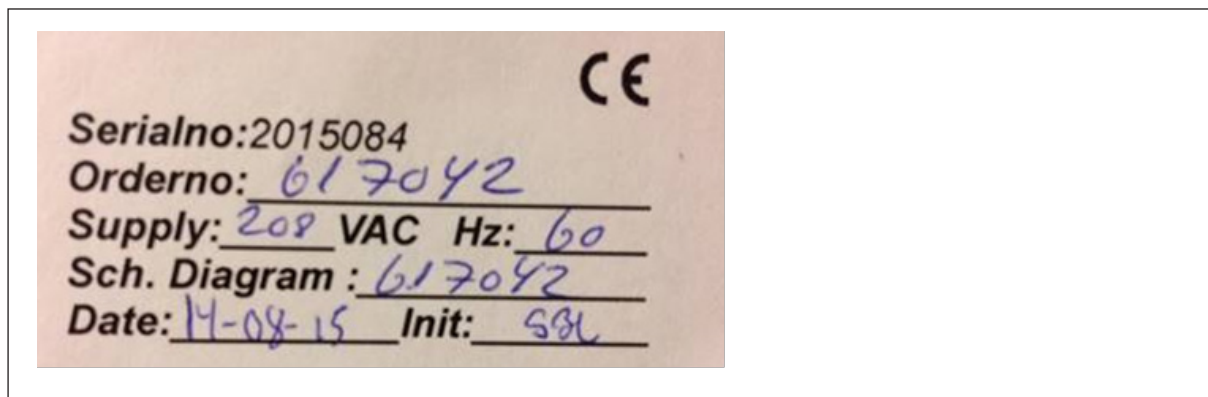

Fig. 8: Label with the internal order number and electrical schematic diagram number

2.11 Electrical schematic diagrams

A copy of the electrical schematic diagrams is placed on the backside of the hatch inside the control panel.

3 Installation

3.1 Important notes on installation



WARNING!

Do not retighten/unscrew hoses while the system is pressurised!



CAUTION!

Do not use oil, grease, glue, Teflon, silicone, O-ring lubrication, etc. when assembling pipes or hose connections.

All of the above products can act as food for bacteria and are thus pose health risks.

Only approved lubricant: Dish soap.

Wash your hands before or wear clean gloves while assembling parts in direct contact with water. Keep dust covers on pipes and hoses until just before assembly.



CAUTION!

Do not fasten the pump station or hoses/pipes to vibrating installations.

3.1.1 Qualification of personnel

All installation work must be performed only by persons familiar with the ML RO system and sufficiently qualified for such work. All work on electric installations must only be performed by adequately qualified electricians.

3.1.2 Safety

The pump station and any control units may only be connected to the mains after all installation work has been completed. All statements relating to correct positioning and installation must be followed and complied with. When installing components of the ML RO, use the materials and hoses supplied with the unit. In case of doubt, please contact your Condair supplier.

3.1.3 Tools needed for installation work

- Screwdriver set
- Bubble level
- Polygrip pliers
- Wire cutters
- Spanner set
- Tape measure
- Marker
- Box cutter

3.1.4 Positioning and installation notes

Please observe the following on positioning and installation:

- The pump station must be installed only in a location with a drain in the floor.
- The site must be freely accessible with sufficient space for convenient operation and maintenance (min. free space around the MLRO: laterally 0.5 m, 0.8 m front / back).
- The pump station is designed for operation in a frost-free and dry environment, never outdoors.
- Do not install the pump station in exposed locations or locations with heavy dust loads.
- The pump station is designed for installation on a load-bearing floor.

3.2 Positioning the pump station

Before positioning the ML RO pump and tank, it is important to consider the position of water treatment equipment in the room prior to installing the ML RO.

The water treatment installation parts should be installed in the order shown in the figure below. Please note that the combination of water treatment systems will vary from one installation to the next due as a result of water quality and regulatory requirements in the given location.

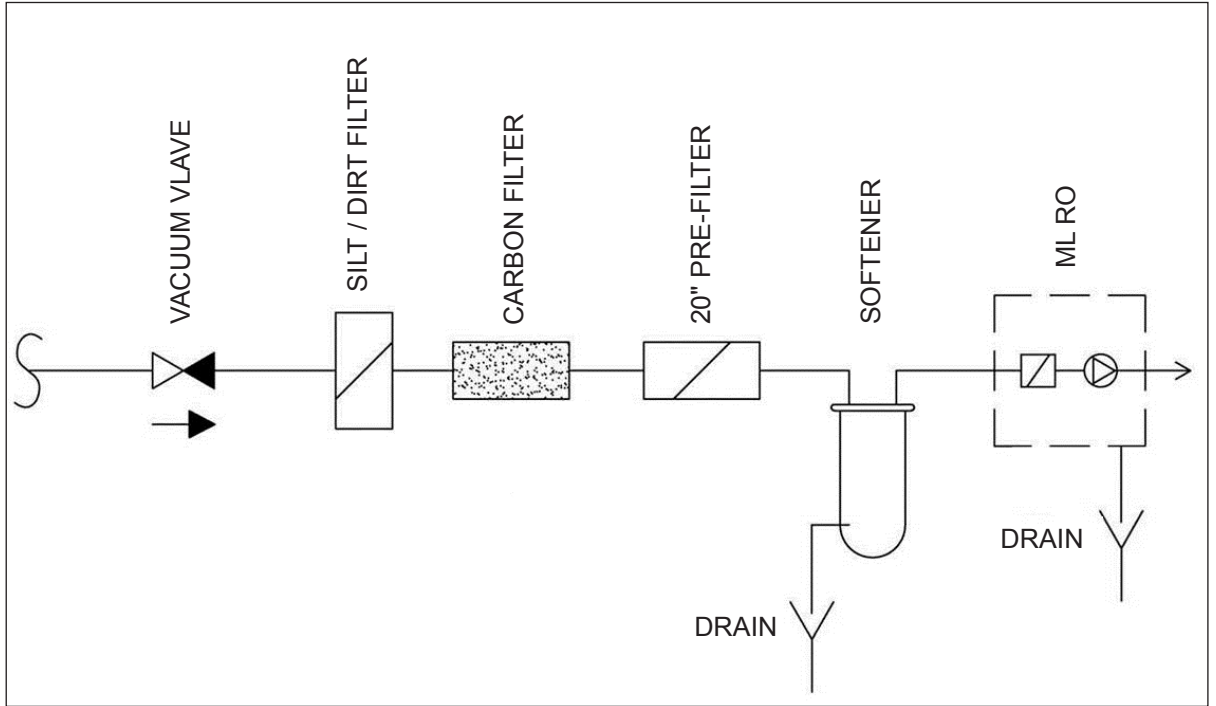

Fig. 9: Positioning water treatment equipment

Start by examining the types of water treatment systems to be installed and read their installation instructions as regards location and any requirements for supply and drainage.

Mark the location of the different systems in the room and note any missing supply or drains for the systems. Make sure you have the necessary fixing equipment available: cable ties, cable trays, screws and wall anchors.

Place the ML RO on a hard floor with a drain

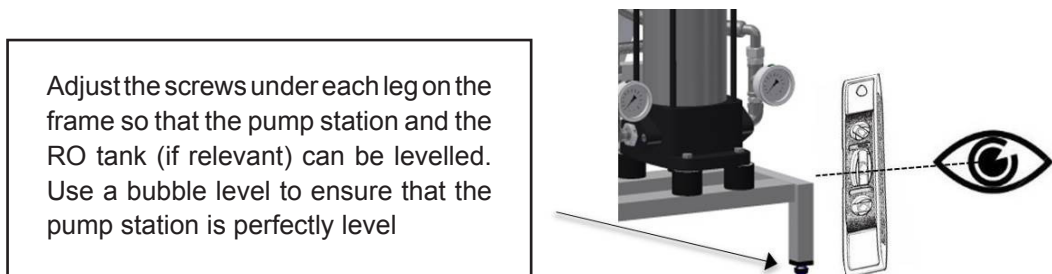

Fig. 10: Adjusting the pump station

3.2.1 Drain

Connect the ML RO to the floor drain with a tube or hose of a 3/4" RG female in the drain connector. On ML RO 500, 800, 1000 and 1500, the drain from MV4 on the RO tank must also be led to a drain – either directly or be connected to the drain connector D.

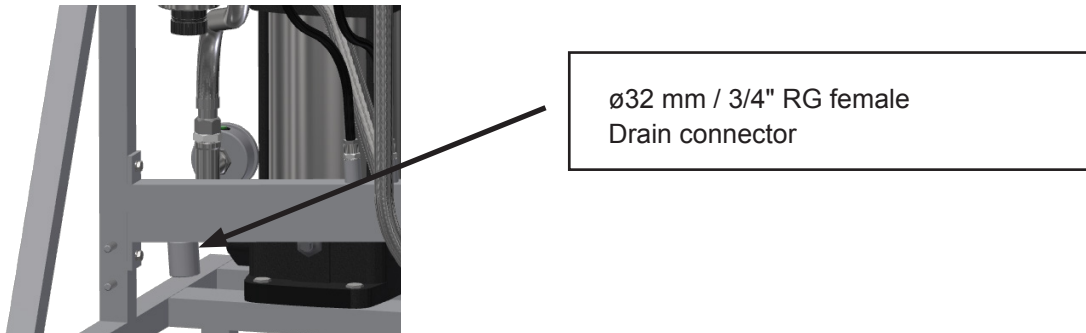

Fig. 11: Drain connection

- Remove protecting plug (yellow) from drain connector.
- Connect drain hose to water outlet connector (ø32 mm) and lead the drain hose down to an open funnel with a constant down-slope.
- Fix drain hose in its position, so it cannot move during operation.

The drain must have an appropriate down-slope to allow the water to flow freely and without pressure from the drain connector

3.2.2 Water connection



WARNING!

Do not open and fill hoses, pumps, filters or tanks with water if the system is not to be started immediately after installation (48 hours). Stagnant water acts as a breeding ground for potentially dangerous micro-organisms.

Before connecting the ML RO to the water supply of the building or the water treatment system, it must be ensured that the incoming water is as clean as possible. This is done by running a hose from the supply to the drain and open the shut-off valve completely. Let the water run for at least ten minutes. Shut off the water again and connect ML RO to the water supply with the supplied hose (3/4", 1.5 m).

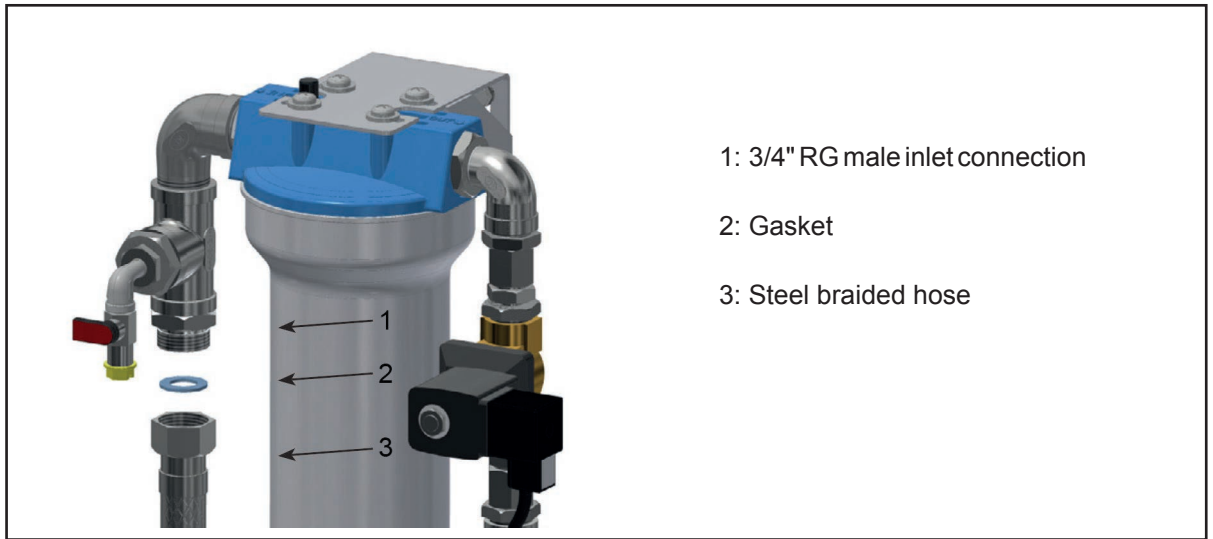

Fig. 12: Water connection

Connect the RO tank (only ML RO 500, 800, 1000 and 1500)

All hoses to the internal connections are supplied with ML RO and requires that the RO tank is placed right next to the pump station.

3.3 Electrical installation



DANGER!
Danger of electric shock!

Installations and electrical connection must only be done by trained technicians and according to local standards.

High voltages, danger of electric shock! Touching live parts may cause severe injury or death.

All Connections must be made according to the electrical documentation which is found inside the control unit of the electrical cabinet / main box.

4 Commissioning



The system start-up must be carried out or monitored by persons approved and trained by Condair. Errors in the start-up phase may ultimately result in illness, injury and death of humans.



When fitting water filters, RO membranes, hoses and other components in direct contact with water please, wear sterile gloves or touch only the packing paper to keep the filter bacteria-free.

Remember to wash your hands!



Commissioning of the pump should be the last thing performed at an installation site. When the pump has run with water and the preservation fluid (windscreen wash) has been flushed out, it should always be kept on (summer and winter) in order to keep the system hygienically clean by allowing it to run its automatic flushing and UV routine.

4.1 Tools and materials for commissioning work

- Screwdriver set (remember small screwdriver for terminals)
- Polygrip pliers
- Spanner set
- Bucket with litre measure
- Residual hardness test kit, quick method onsite test ML-part: 150400000
- Total hardness test kit, quick method onsite test ML-part: 150401000
- Chlorine-sensitive test strips, quick method onsite test ML-part: 155407200
- Conductivity meter
- BQ water analyses set ML part: 155600010
- Multi-meter (Volt, Amp)

Disconnect the power before starting any commissioning work. Turn the main power switch and the start button to the off position.

4.2 Installing the inlet filter

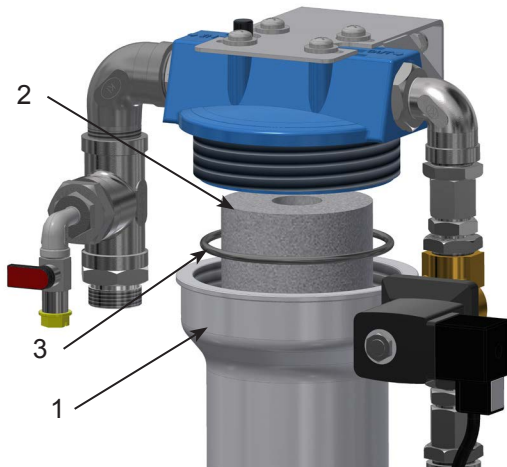

Fig. 13: Inlet filter housing and filter

Insert filter

- Unscrew the filter housing [1] using a filter wrench.
- Insert the filter [2], and make sure that it is centered on the guide knob at the bottom of the filter housing.
- Tighten the filter as much as possible by hand and then use the filter wrench to tighten approx. 1/4 turn.
- Slowly open the water supply
- If the filter housing is hard to tighten or leaks, unscrew it and check that the filter is centered, the O-ring (3) is undamaged and the sealing surface is smooth and free of dirt.

Note: Do not touch the filter with your bare hands (slide it out of the packing directly into the filter housing).

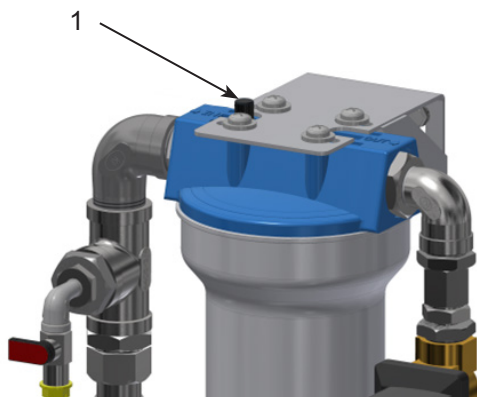
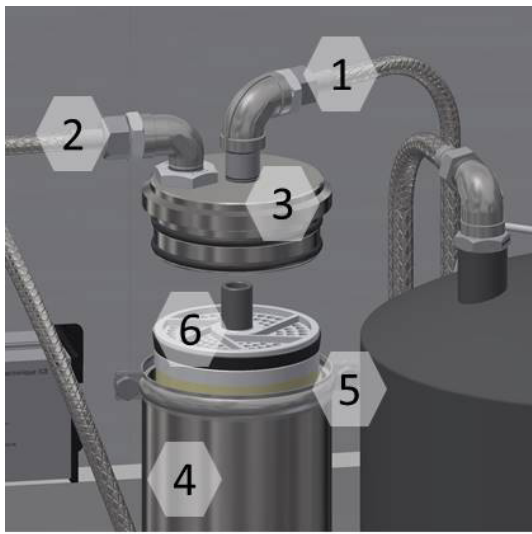

Fig. 14: Air-vent button, inlet filter

Airing filter:

- Slowly open the water supply (tap) to the ML RO
- Bleed the filter by pushing down the air-vent button (1) on the filter top until water leaks continuously.
- Release the air-vent button.

4.3 Insert RO membrane



1: Outlet tube
2: Inlet tube
3: Membrane tube, end cap
4: Membrane tube
5: hose clamps
6: membrane

Start by loosening the hose clamp (5) and then remove the end cap (3) of the membrane tube. Let the membrane (6) slide into the membrane tube (4). Make sure that the O-ring on the membrane is facing up (protect the membrane against bacteria, hold on the membrane packaging bag).

Press the membrane all the way to the bottom. If there is no resistance at the end, or if the membrane is very difficult to press down, the reason may be that the inner O-rings in the membrane tube end cap are out of place or have fallen out.

Check that both the outer and inner O-rings at the end cap (top and bottom) are in place and undamaged. Now press the end cap in place and reinstall the hose clamp.

Note: Do not use grease or the like to lubricate the O-rings. Moisture with water instead.

Fig. 15: Membrane detail

4.4 Install RO tank breathing filter

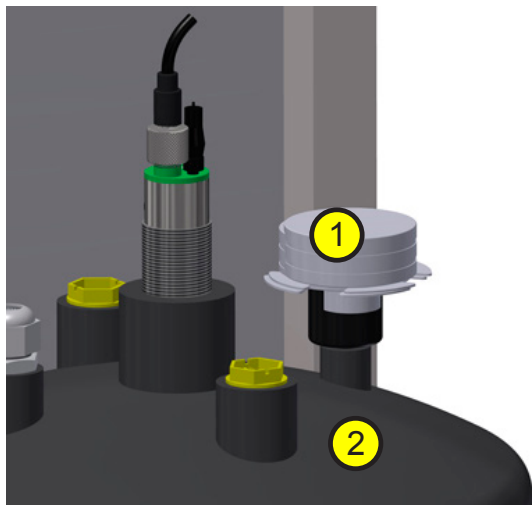

1: Sterile breathing filter
2: RO tank

Remove the yellow protective cap from the RO tank filter adapter (shaped like a small cup).

Unpack the filter (1) and moisten the O-ring with running water.

Avoid touching the nipple and the O-ring with your bare hands.

Press the sterile breathing filter into the filter adapter.

Fig. 16: RO tank breathing filter

Note: Before the pump is started for the first time, the controller must be set up and a membrane cleaning preformed, follow the steps in [chapter 4.5](#).

4.5 Basic set-up of the controller



Fig. 17: Control cabinet

- 1: Display (D2)
- 2: ON/Standby/OFF (S1)
- 3: Reset/Start (S1/P1)
- 4: Keyhole
- 5: Main power switch (S3)

- Put S1 in OFF position
- Start the controller by turning the power switch S3 in ON position
- The display lights up the start center → ► START

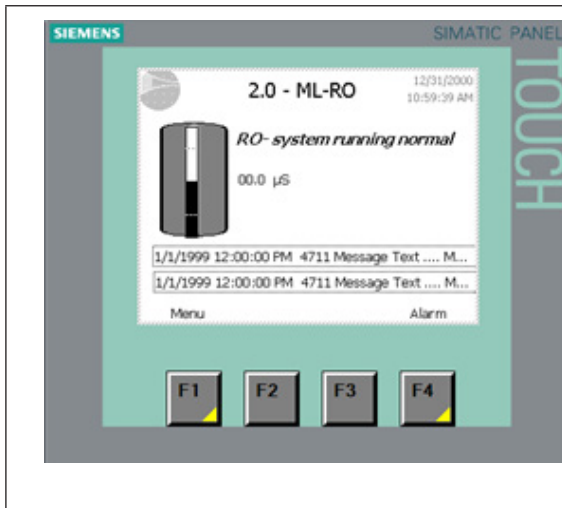

Screen 2.0 - ML-RO

When power is switched on the start / home screen appears.

- Press <F1> to go to the menu.

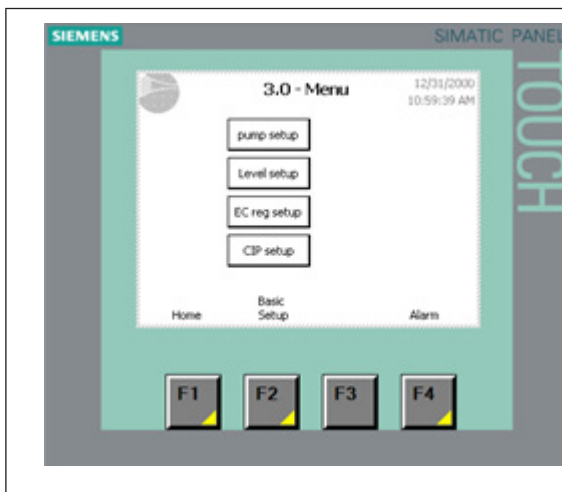

Screen 3.0 - Menu

- Press <F2> to go to Basic setup

Use master password: 8599

When a password is required in order to change parameters, a screen will appear where the password can be entered. Change to numerical keyboard by means of the keys 0-9. Once the password has been entered, the system is unlocked at the relevant level for five minutes.

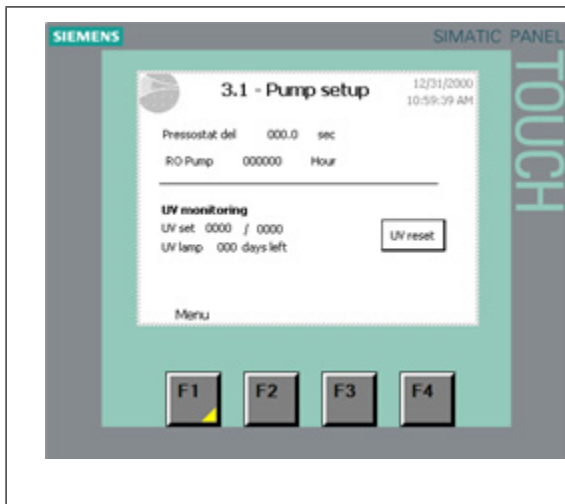

Screen 3.1 - Pump setup

Pressostat delay preset to 30 sek

Running hours of the RO pump.

UV monitoring only appears if option has been chosen.

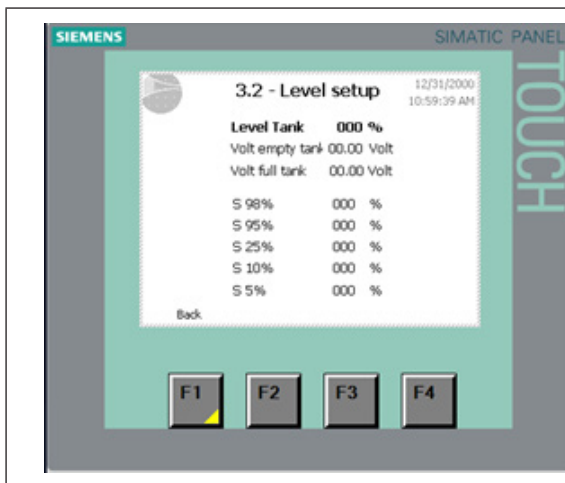

Screen 3.2 - Level setup

Do not touch the preset values as this could cause malfunctions and damage to the equipment.

If the ultrasonic level sensor is replaced remember to measure and enter new values for Volt of empty and full tank (measured at the terminals in the control cabinet).

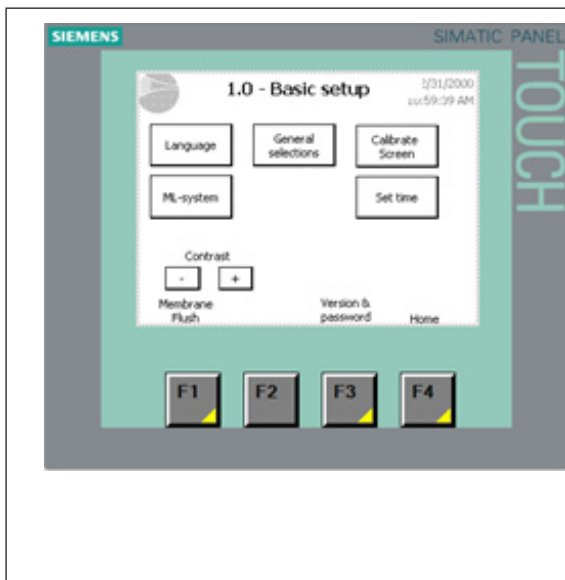

Screen 1.0 - basic setup

The Basic setup page provides access to pages and choice of functions:

- Language (press button to toggle between the preinstalled languages)
- General options
- Screen calibration (follow instructions on screen)
- Time/date
- Software version and administration of passwords
- Set the screen contrast with - / +
- **press F3 to go to version and password**

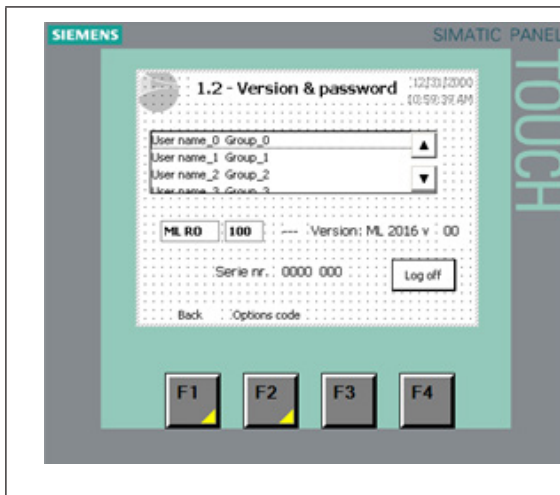

Screen 1.2 - Select sections

Check type and size chosen are the same as nameplate on the unit, if not choose correct size in the dropdown menu.

Check Serial number is correct.

If a Modbus or Log option has been acquired press F2 options code.

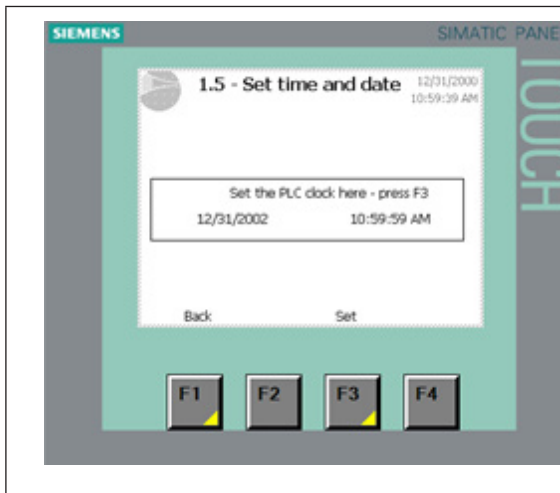

Screen 1.5 - Set time and date

- set the time and date press F3

4.6 Option setup

If no options has been acquired go to RO flush.

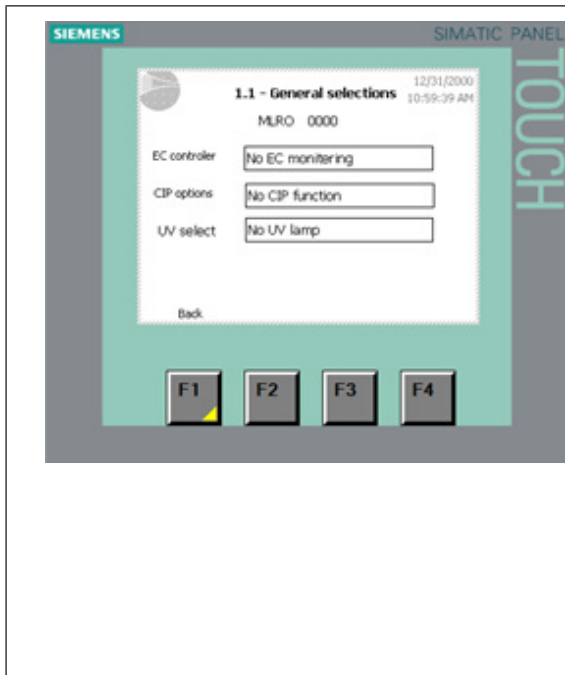

Screen 1.1 - General selections

Select options – be aware that the options here also require hardware changes to the pump station. When an option is chosen the setup button for the option appears on screen 3.0 menu.

EC controller

- 0 = Without EC option
- 1 = EC measuring in tank
- 2 = EC controller (ML EC Reg2/6)
- 3 = With 1 MixBed and ML EC Reg6
- 4 = With 2 MixBed and ML EC Reg6

CIP yes / no

UV yes / no (settings appears on 3.1)

- Press <F1> to go back.

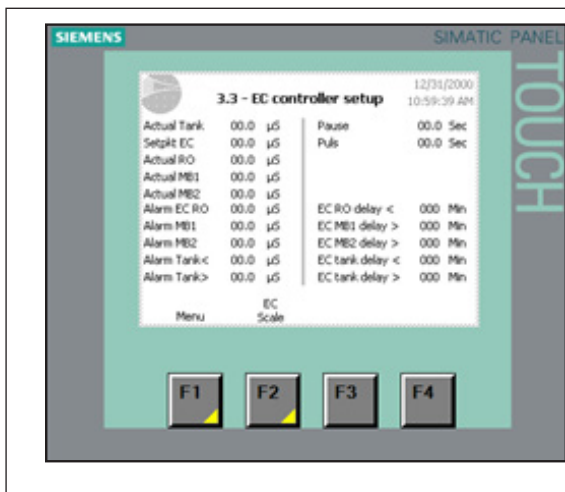

Screen 3.3 - EC controller setup

Setup of alarm limits and alarm delay for the EC alarms (option).

Shows the EC regulation parameters.

Please read the EC-REG manual for detailed information.

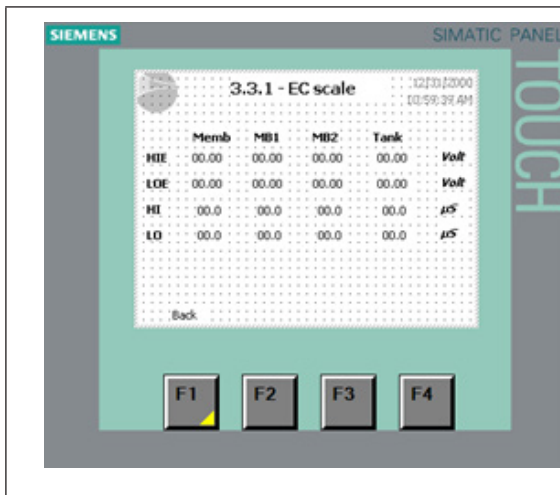

Screen 3.3.1 - EC scale

Parameters for scaling the three optional EC sensors.

Please read the EC-REG manual for detailed information.

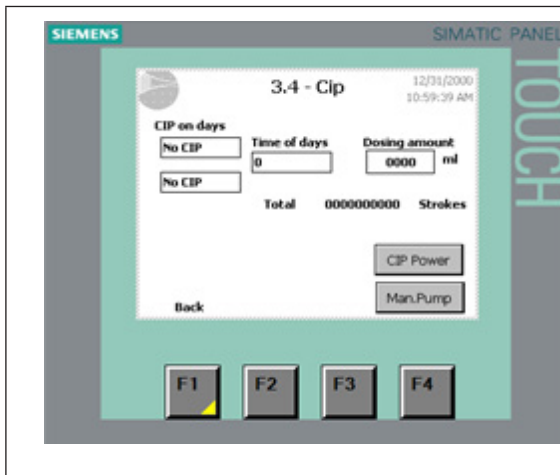

Screen 3.4 - CIP

The CIP option will dose a small amount of disinfection (SANOSIL) into the RO tank once or twice per week at a preset time.

Choose **days** e.g. Monday and Friday, **Time of day** to CIP e.g. 7 PM, and the **CIP amount** (see CIP manual)

All choices are made in the dropdown menus.

Please read the CIP manual for detailed information.

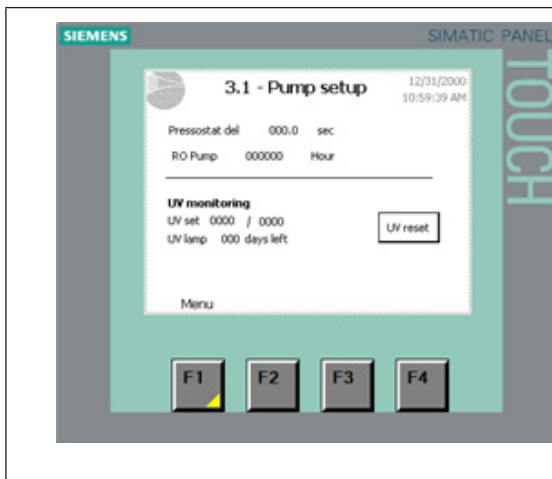

Screen 3.1 - Pump setup

If the UV option has been selected UV monitoring appears at the 3.1 pump setup screen.

UV set 0000 / 0000: the value on the right is a measured power value going into the UV lamp, this value will drop if the UV lamp malfunctions. The number on the left has to be adjusted every time the UV bulb is changed. Push the number and put in a value approx. half the value on the right.

When the UV reset button is pushed the 365 day countdown is reset.

4.7 RO membrane flush and startup



CAUTION!

The first time a new pump and/or RO membrane is to be used, it is important to flush out any preservation fluids so that they do not end up in the high-pressure system.

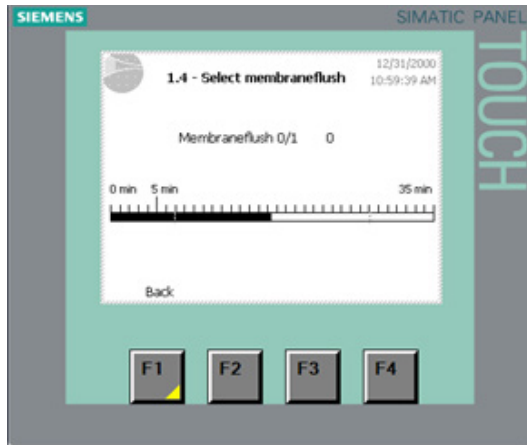

Screen 1.4 - Select membraneflush

- Within the basic setup screen 1.0 press <F1> to select membraneflush.
- tap on "0" and change it to "1"
 - Normal mode = 0
 - Membrane flush = 1 (**remember to put back in normal mode after flushing**).
- Turn switch <S1> to "1"
- RO pump will now start and the flush program will run for 35 minutes.
- Check the RO pump is running in the correct direction, if not stop the pump and have the phases sequence changed.
- Monitor the pump during flushing.

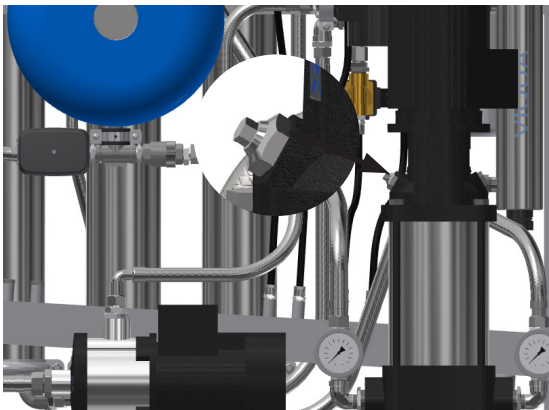
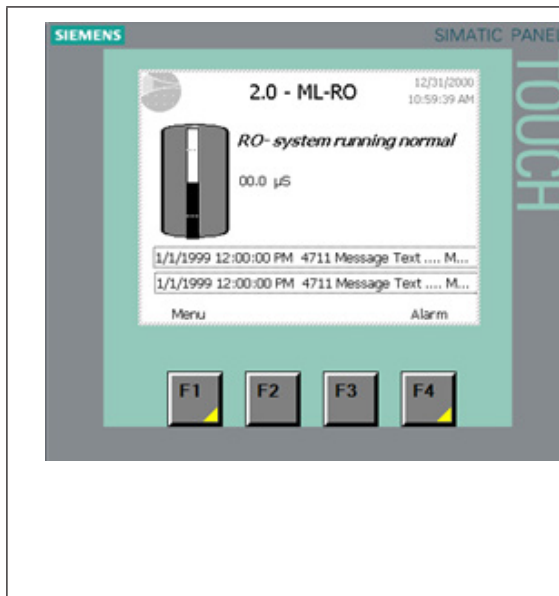

Fig. 18: Venting

If the RO pump does not build pressure or is noisy, it must be vented.

Open the small centre bleeding screw on the RO pump to fill the pump with water and vent any air. Close the valve again.

Note: After a few seconds, the air should be out of the system. If not, please repeat the procedure.



Screen 2.2 - ML-RO

The RO system is now ready for operation.
 Note: Now it's time to adjust the RO, if this is not done before starting the normal operation, the membranes could be damaged.

Normal operation page.

- Shows a status line.
- The level in the tank is shown in 4 steps (not a linear presentation)
- The actual EC in tank is shown (option)

In case an alarm or message is triggered, a bar will appear across the screen showing the message.

4.8 Adjusting the reverse osmosis

4.8.1 Explanation of technical terminology

Permeate:

Processed, desalinated water which is produced by the ML RO system and supplied to the reservoir tank.

Concentrate:

The water led to the outlet. This water contains salts and minerals that have been removed from the water.

Feed water:

The water which is led directly to the ML RO.

TDS:

The amount of dissolved salts, measured in mg/l.

Conductivity:

The designation of the water's salt concentration measured in ($\mu\text{S}/\text{cm}$). The lower the value, the higher the water quality.

Membranes:

Is the system filter which desalinates the feed water using high pressure.

RO:

The abbreviation for reverse osmosis.

Level sensor:

A sensor which emits a signal when the RO system must either be started or stopped, and it stops the transport pump in case of dry running of the reservoir tank.

Softening:

A pre-filter which softens the water, i.e. it removes hardness from the water.

4.8.2 Water quality

The feed water, which is to be treated in the ML RO system, must be of drinking water quality. Please read requirements for inlet water in [chapter 2.2](#) and in [chapter 7.1](#).

If there are doubts about the raw water composition, a water analysis must be made. The ML RO must be connected to a water pressure of minimum 2.5 bar and maximum 7 bar. The quality of the treated water will be less than 20 µS/cm at 10°C.

The ML RO will be adjusted from the factory to the following parameters

ML RO 100 - 300	20 °dH / 10°C	Permeate/concentrate ratio: approx. 50/50
ML RO 500 - 1500	1 °dH / 10°C	Permeate/concentrate ratio: approx. 75/25

Water quality (contact Condair for technical advice)		
Content	Symptom	Preventive action
TOC, BOC and COD	Can cause slimy as well as firm hard film.	Can in some cases be micro-filtrated or removed by means of a carbon filter.
Iron, Manganese (ocher)	Precipitation of iron gives a reddish-brown film and precipitation of manganese gives a black deposit.	Sand filter – oxidation, softening, greensand.
Calcium, magnesium (hard water)	The membrane scales.	Softening, antiscalant
Silica	The membrane scales.	Antiscalant.
SDI (silt)	The membranes get clogged.	Microfiltration (absolute), ultrafiltration, flocculation.
Oil	The membrane is greasy from oil.	Carbon filter.
Particles	The membrane gets clogged due to hard deposits.	Microfiltration.
Chlorine, pesticides, organic solvents	Membrane deformed. Permeate capacity and quality changed and cannot be CIP-cleaned back to the original capacity. The deformation is not visible.	Free chlorine shall be removed by active carbon filter and chemical cleaning, either with thiosulphate or sulphite.
Bacteria	Membrane is clogged by slime.	Chlorination + de-chlorination, UV, micro-filtration 0.2 µS/cm and ultra- filtration.

4.8.3 Adjustment of outlet amount

Important! Read the entire chapter before adjustment is started.

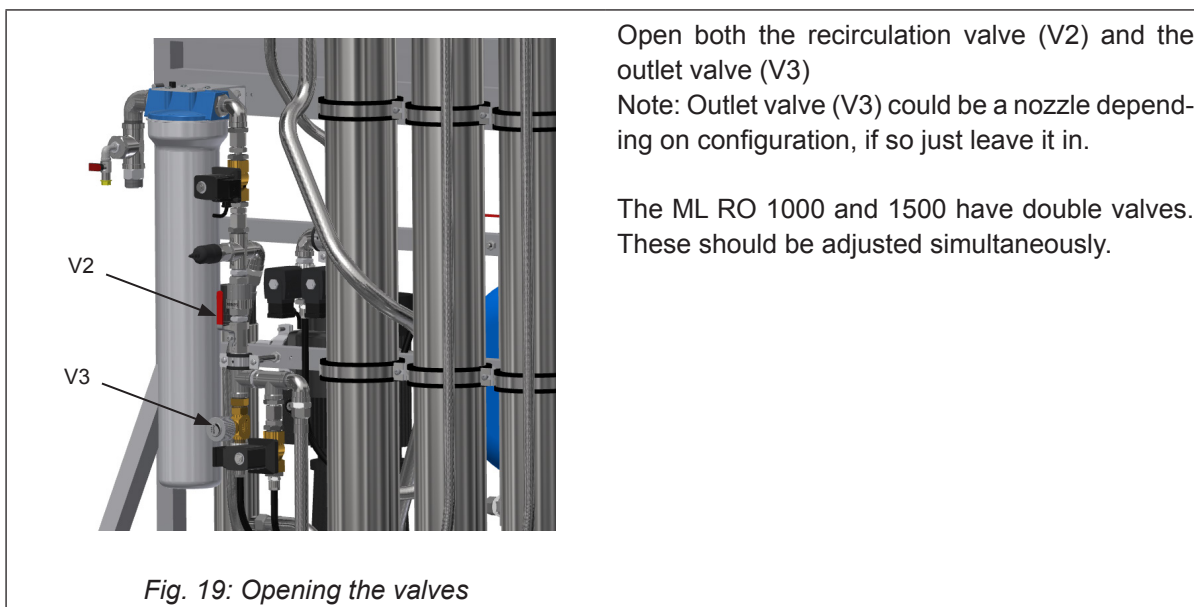

The outlet (concentrate) amount must be adjusted. Which amount is suitable on your system depends on the feed-water quality. Too high water recovery will damage the system membranes. On condition that the raw water complies with the water quality requirements, it can operate at a recovery rate of 70-80% with softening depending on the amount of organic material in the water

ML RO type	Max Permeate capacity (l/h) *	Outlet amount (l/h) (with softened water)		Outlet amount (l/h) (with tap water)	
		Surface water (75% recovery)	Groundwater (80% recovery)	Surface water (50% recovery)	Groundwater (55% recovery)
100	100	33	25	100	82
300	275	92	69	275	225
500	500	167	125	- **	- **
800	750	250	188	- **	- **
1000	1000	335	250		
1500	1500	500	375		

* For every degree the inlet water is below 10°C, the permeate capacity (l/h) must be adjusted down with 3%.

** We recommend always using softening for ML RO 500, ML RO 800, ML RO 1000, ML RO 1500, as the water consumption and wear on membranes will be relatively high. However, local water conditions may in some cases justify running without. Please ask Condair for advice.

Ex.: ML RO 500 with 80% recovery

$$\text{Outlet amount l/h} = \frac{100 \times \text{Permeate capacity l/h}}{\text{Recovery\%}} - \text{Permeate capacity l/h}$$

$$\text{Outlet amount} = \frac{100 \times 500}{80} - 500 = 167 \text{ l/h}$$

Start the RO system and adjust the outlet so the desired amount of outlet water has been obtained.

4.8.4 Adjustment of permeate amount

- Adjust the permeate amount of the recirculation valve. Adjust the amount of permeate produced to Max Permeate capacity (l/h) of the specific system remember to temperature withdraw 3% from Max Permeate capacity (l/h) for every degree the inlet water is below 10°C
E.g. if the feed water temperature is 8°C, for an ML RO 300 it means that the permeate capacity will be 6% below the normal 275 l/h, i.e. 258 l/h.
- When the requested pressure and permeate capacities have been obtained, check again if the outlet amount has been adjusted correctly.
Note: The system must be started and stopped two times, and then the flow must be re-checked. The valves can then be readjusted if necessary.
- Check on the RO pump outlet manometer that it shows the correct operating pressure, 6-10 bar. Please note that the operating pressure may vary by different temperatures and capacities.
- Now check the quality of the processed water on the permeate hose; the conductivity must be below 20 µS/cm (conductivity meter is available as optional equipment).
- Check that the outlet water is below 1000 µS/cm.
- Check that the ML RO automatically starts and produces treated water.
- Check if the ML RO automatically shuts down by too low feed water pressure or lacking feed water supply. This is done by slowly closing the feed water supply while the ML RO is in operation. When the water supply has been interrupted, the ML RO must stop automatically within 10 sec. In order to put the ML RO back into operation, the water supply must be re-established and the reset button pushed once. The ML RO will automatically revert back to normal operation! The system is now commissioned and ready for use.

5 Operation

Persons operating the ML RO's controller must have read and understood this manual. Knowing and understanding the contents of the manual is a basic requirement for protecting the personnel against any kind of danger, to prevent faulty operation and to operate the unit safely and correctly.

All safety notes in the installation and operation manual for the ML RO must be observed and adhered to.

All work described in this controller manual may only be carried out by properly trained personnel which is authorised by the customer.

If you have questions after reading this documentation, please contact your Condair representative who will be happy to assist you.

5.1 Overview control unit

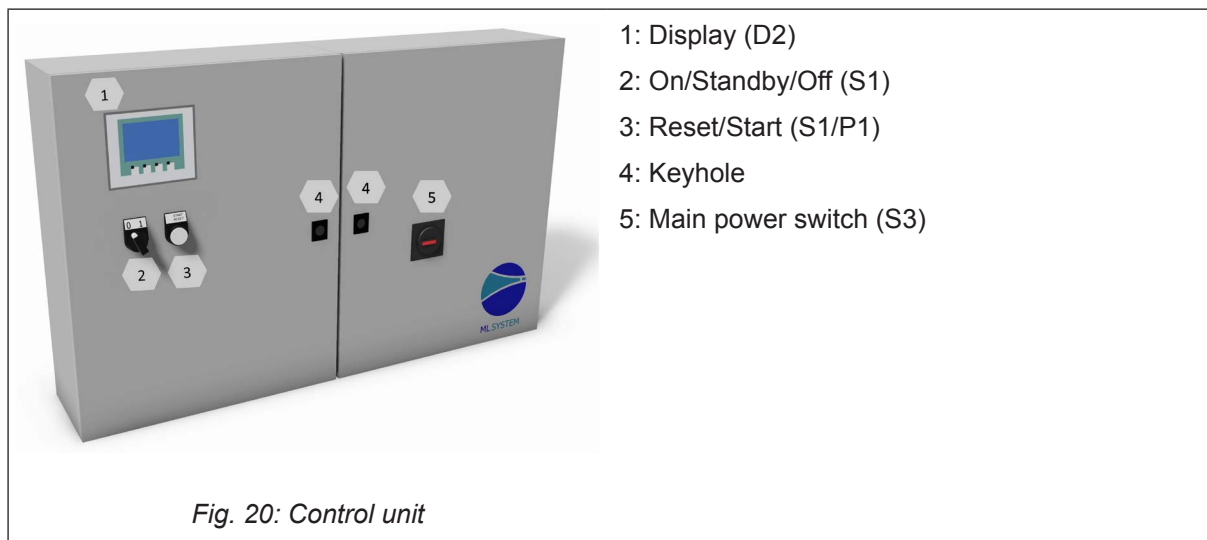

5.2 Equipment protection

Pressure switch (inlet water)

The ML RO has a pressure switch which monitors the inlet water pressure.

If the inlet water pressure drops, the controller will stop the pump, thus protecting it against dry running.

If the water pressure drops, the screen will display "PM Water pressure too low".

Thermal motor relay

Both electrical motors are protected against overheating by a thermal motor relay.

Description of touch screen

The screen has four F keys. Each of the keys are used to navigate between the different screen images. When these are used, the individual key function is indicated in the description directly above the key.

The touch screen can be operated by gently tapping the relevant screen "buttons" with your finger.

To change a numerical value tap the value on the touch screen, this will make the numerical keyboard pop-up and the new value can be entered. Hit enter to save.

Protection against unwanted changes

The control unit settings are password-protected against unwanted changes. The different user groups have different passwords and different rights.

- **User** (no password): can read operational information and alarms.
- **User 1** (password 1234): as above + changing of set points.
- **Technician** (password 197): as above + changing of operational parameters and choice of membrane rinse.
- **Master** (password 8599): as above + selectable options.
- **Condair tech** (xxxx): as above + factory / service menu.

When a password is required in order to change parameters, a screen will appear where the password can be entered. Parameters can be changed using the numerical keyboard (keys 0-9).

Once the password has been entered, the system is unlocked at the relevant level for five minutes.

5.3 Alarm messages

This page shows alarms and operational messages. The alarm display contains information about when an alarm was triggered and when it was reset. The page shows active alarms and previous alarms. Please note that the system does not have a backup memory, which means that previous alarms will be lost in case of power failure.

Water pressure too low

The water pressure on the water inlet to the pump station is too low. The alarm triggers if the sensor detects water pressure lower than 0.5 bar.

Tank Full

The water level in the tank is too high – lower the water level and reset the system. Check that the inlet valve MV1 closes tightly when the system is idle.

CIP overdosing last day (option)

The CIP self-monitoring system has detected a possible overdosing. Please call for service.

EC too high after mixedbed

EC too high RO membrane

Water quality – EC too low

Water quality – EC too high

Add-on BOX EC reg error

The box detected does not match the chosen box.

Add-on BOX CIP error

The box detected does not match the chosen box.

Add on BOX EC comm.error

Network error, check power to Add on box and network cables

Add-on BOX CIP comm.error

Network error, check power to Add-on BOX and network cables.

5.4 Operational messages

CIP pump error (option)

General pump error.

CIP too low dosing (option)

Possible under dosing of CIP fluid detected, check CIP bottle and for air in the system.

UV lamp error (option)

There is an error on the UV lamp.

UV lamp getting old (option)

21 days to recommended renewal of the UV bulb.

UV lamp error too old

Replace UV lamp and reset service interval.

Water level below start level

The water level in the tank is too low for the transfer pump to start. Once an adequate level has been reached, the system will start automatically.

Mixedbed 1 must be changed

Mixedbed 1 must be replaced.

5.5 Controller menu

5.5.1 Start page - basic settings

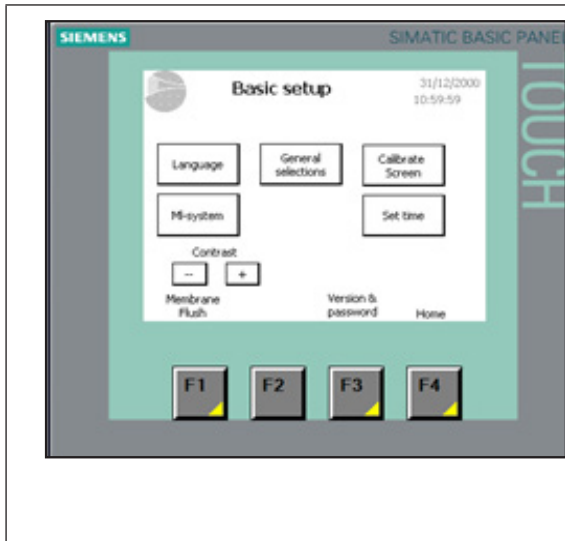

Basic setup

The Basic setup page provides access to pages and choice of functions:

- Language
- General options
- Screen calibration
- Time/date
- Software version and administration of passwords

Once these choices have been made, press OK to continue.

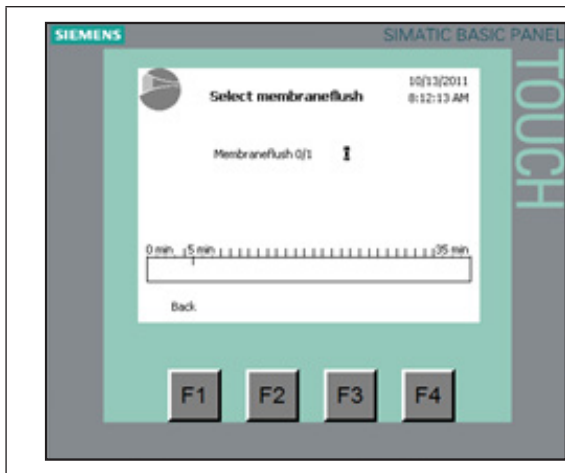

Select membraneflush

Choose whether membrane flush has to be used.

2 – Waiting for a selection to be made.

1 – Run flush of RO membranes (takes at least 35 min.).

0 – Run normal operation.

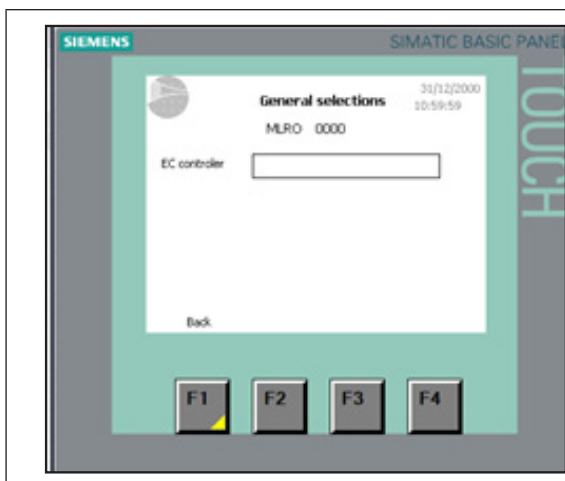

General selections

Select options – be aware that the option also requires hardware changes to the pump station.

EC controller

0 = Without EC option

1 = EC measuring in tank

2 = EC controller (ML EC Reg2/6)

3 = With MixBed and ML EC Reg6

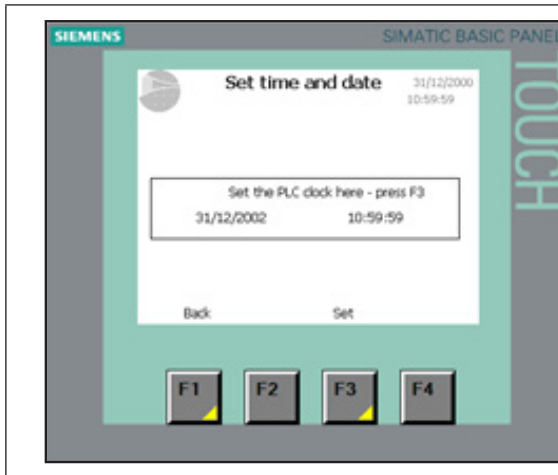

Set time and date

Set time and date. Then press <F3>.

5.5.2 Operation and menu page

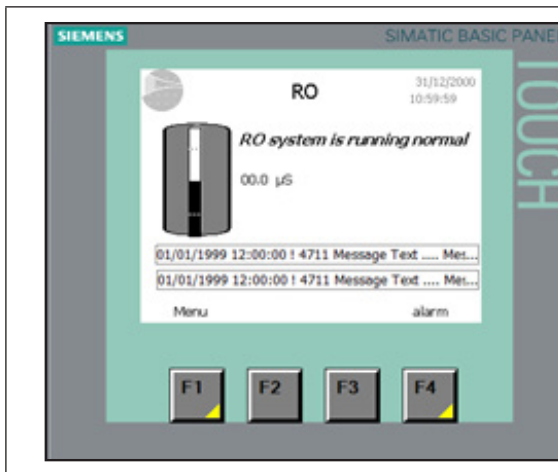

Normal operation page

- Shows a status line.
- The level in the tank is shown in 4 steps (not a linear presentation)
- The actual EC in tank is shown (option)

In case an alarm or message is triggered, a bar will appear across the screen showing the message. Access to the menu page – the alarm page.

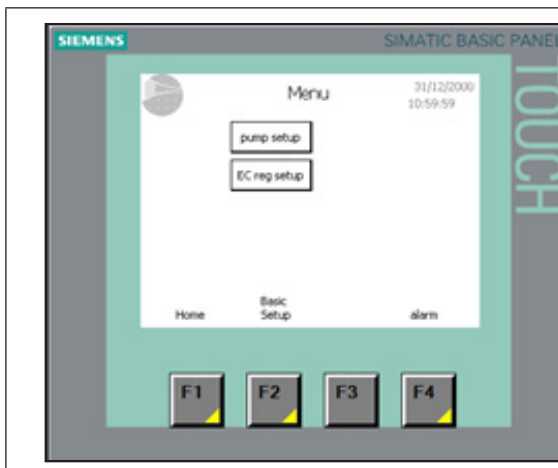

Menu

Gives access to the pump setup and to the EC regulator setup (option).

And access back to the Basic setup.

5.5.3 Alarms messages

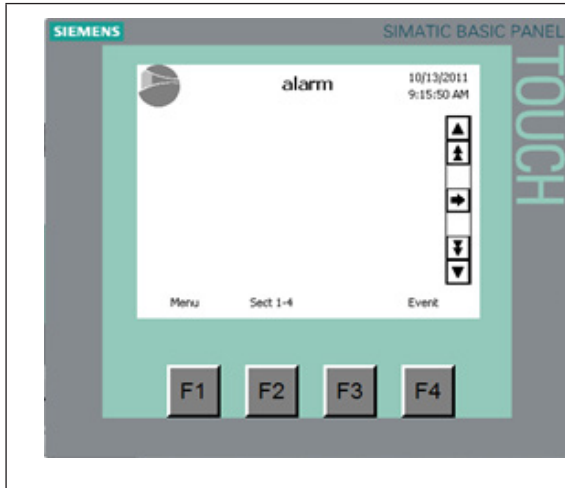

Alarm

All alarms and operational messages are shown, showing the time at which they occurred and the time when the alarm stopped.

Please note that the alarm log will be reset after a power cut.

5.5.4 Pump setup

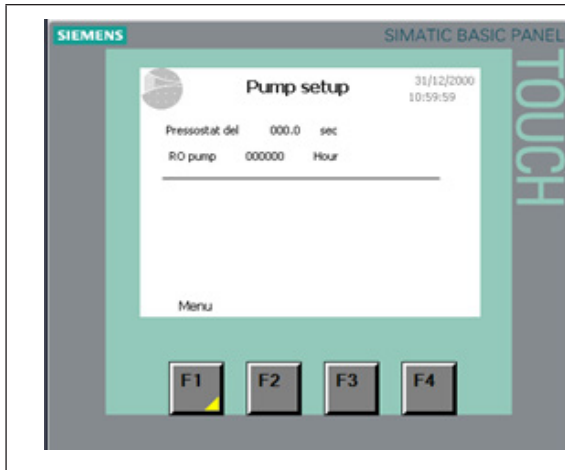

Pump setup

- Pressostat delay
- Hour counters for the pumps show the total running time.

5.5.5 Pages for the EC monitoring and regulation (option)

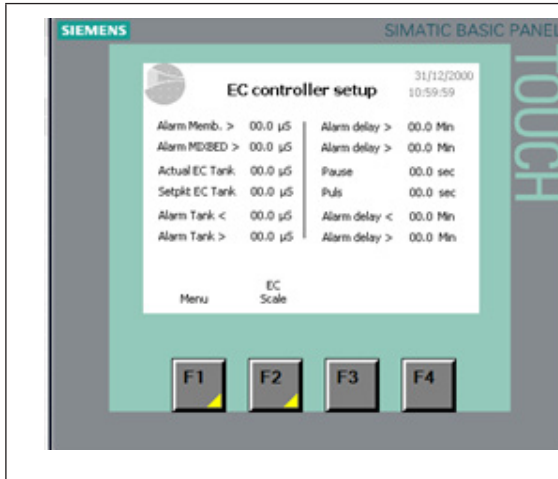

EC controller setup

Setup of alarm limits and alarm delay for the EC alarms (option).

Shows the EC regulation parameters.

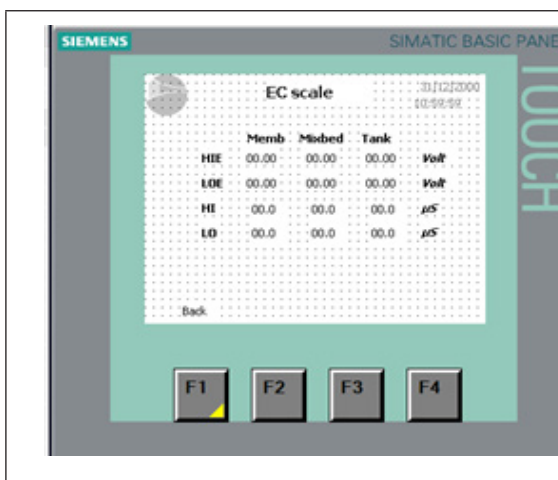

EC scale

Parameters for scaling the three optional EC sensors.

5.6 Weekly inspection

During operation, the ML RO and the humidification system have to be inspected weekly. On this occasion, check the following:

- Entire system for leakage
- Electric installation for damage
- Operating display for warning or error messages
- UV filters
- Pressure drop over inlet filter
- Water treatment systems such as carbon filter, softener

If the inspection reveals any irregularities (e.g. leakage, error indication) or any damaged components take the ML RO out of operation. Have a qualified specialist or Condair service technician correct the damage or malfunction.

Fill in the "Service form for weekly monitoring of humidifying systems" provided in [chapter 6.4](#) of this manual. Failing to do so could affect your warranty.

6 Maintenance

6.1 Important notes on maintenance

Qualification of personnel

All maintenance work must only be carried out by qualified and trained personnel authorised by the owner. Maintenance and repair of the electrical installation of the Condair ML RO must only be carried out by qualified personnel (e.g. electrician) who are aware of possible dangers and implications. It is the owner's responsibility to verify proper qualifications of the personnel.

General note

The instructions and details for maintenance work must be followed. Only maintenance work described in this documentation may be carried out. Use only original ML-System spare parts to uphold the system warranty.

Safety

Before maintenance is initiated, the ML RO must be taken out of operation in accordance with instructions in the section "Taking the ML RO out of operation". Protect the system against unintentional switch-on. The ML RO must be serviced at the intervals described in this manual and cleaning and disinfection must be performed by trained and instructed personal.



Poorly maintained RO systems may endanger health if used to supply an adiabatic humidification system. Therefore it is mandatory to observe the specified maintenance intervals and to carry out maintenance and cleaning in strict accordance with the instructions.

6.2 Maintenance work

To ensure safe, hygienic and economic operation of the ML RO, vital components must be checked and maintained periodically according to the table below. The maintenance intervals and maintenance work stated below are guideline values. Local conditions, quality of the water, etc. could influence the maintenance intervals. After having carried out the maintenance work, fill in the maintenance checklist, sign it and reset any maintenance indications. The relevant personnel is responsible for any maintenance work not carried out.

Service, to be carried out	Half year	Each year	Every 2 years	Every 4 years
Review of the system				
Testing of the system's overall function	X	X	X	X
Meter reading of water consumption (if present)	X	X	X	X
Reading of pump running hours	X	X	X	X
Logbook registration	X	X	X	X
Control weekly monitoring checklist	X	X	X	X
Water treatment system / incoming water				
Analysis of water hardness (in case of water softening)	X	X	X	X
Pump unit				
Replacement of filter(s)	X	X	X	X
Check the condition of the pump (pressure & noise)	X	X	X	X
Testing of solenoid valves and replacement if necessary	X	X	X	X
Check Hydro membrane pressure, and adjust to 1 bar if necessary. Make sure the membrane is not punctured.		X	X	X
Functional testing of high pressure gauge	X	X	X	X
Functional testing of pressure switch (pressostat)	X	X	X	X
Testing of ON/OFF valve and replacement if necessary	X	X	X	X
Reverse osmosis systems/RO				
Measurement of conductivity at inlet, outlet and drain	X	X	X	X
Testing of overall function and settings for the RO system	X	X	X	X
Leak testing	X	X	X	X
Performance test (vol. produced water compared to drain water)	X	X	X	X
Testing of valves	X	X	X	X
Replacement of sterile breather filter		X	X	X
Evaluation of membrane, replacement if necessary	X	X	X	X
Disinfection / cleaning of tank	X	X	X	X
UV system				
Functional testing of UV systems	X	X	X	X
Cleaning of quartz glass on UV systems	X	X	X	
Replacement of UV-lamp		X	X	X
Replacement of quartz glass				X
Control units				
Transfer relay replacement		X	X	X
Testing of contact K1 and replacement if necessary		X	X	X
Hygiene				
Extraction of water sample from pump (Bacterie test)	X	X	X	X
Cleaning / Disinfection of the system	X	X	X	X

6.3 Preventive spare parts chart

Defined preventive replacement of spare parts in connection with service:

Service		MLRO100	MLRO300	MLRO500	MLRO800	MLRO1000	MLRO1500	Technical lifetime	Service B every half year	Service C every year	Service D every 2nd year	Service E every 4th year
Designation	Part number											
Water filter												
Filter 5 µm 20"	104551000	1 BCDE	1 BCDE	1 BCDE	1 BCDE	1 BCDE	1 BCDE	6 months	Change	Change	Change	Change
O-ring for water filter	430020050	1 DE	1 DE	1 DE	1 DE	1 DE	1 DE	24 months	Check	Check	Change	Change
Air Filter												
Sterile breather filter 0,2 µm	104581000	1 CDE	1 CDE	1 CDE	1 CDE	1 CDE	1 CDE	12 months	Check	Change	Change	Change
UV Filter												
19 W S2Q-PA/2 light pipe	104595000	1 CDE	1 CDE	1 CDE				12 months	Check	Change	Change	Change
26 W S5Q-PA/2 light pipe	104596000				1 CDE	1 CDE		12 months	Check	Change	Change	Change
39 W S8Q-PA/2 light pipe	104597000						1 CDE	12 months	Check	Change	Change	Change
Quartz UV System												
19 W QS-330 Quartz	104583000	1 CDE	1 CDE	1 CDE				48 months	Check	Check	Check	Change
26 W QS-463 Quartz	104584000				1 CDE	1 CDE		48 months	Check	Check	Check	Change
26 W / 46 W QS-810 Quartz	104586000						1 CDE	48 months	Check	Check	Check	Change
RO membrane												
4" for ML RO: µS < 250	150460000		1 E	1 E	1 E	1 E	1 E	95%	Check	Check	Check	Check
2.5" for ML RO: µS < 250	150465000	1 E						95%	Check	Check	Check	Check
4" for ML RO: µS > 250	686020010		1 E	1 E	1 E	1 E	1 E	95%	Check	Check	Check	Check
2.5" for ML RO: µS > 250	686020005	1 E						95%	Check	Check	Check	Check
Electrical control system												
Print frame relay	680010177	1 CDE	1 CDE	1 CDE	1 CDE	1 CDE	1 CDE	12 months		Change	Change	Change
Contactora (K1) Siemens	349010205	1 E	1 E	1 E	1 E	1 E	1 E	48 months		Check	Check	Change
On/off valve												
On/off valve	106521000	1 E	1 E	1 E	1 E	1 E	1 E	48 months	Check	Check	Check	Overhaul
Water sample												
Water sample	155605000	2 BCDE							Use for Service	Use for Service	Use for Service	Use for Service

6.5 Troubleshooting

Qualification of personnel

Have faults eliminated by qualified and trained personnel only. Malfunctions caused by the electrical installation must only be repaired by authorized personnel (e.g. electrician).

Safety

When eliminating faults, the ML RO must be taken out of operation and prevented from further inadvertent operation.

Make sure the power supply to the ML RO is disconnected and the water supply is cut off.

6.5.1 Malfunction with error indication

Error message	Cause	Remedy
Tank full	Tank maximum level / overflow has been detected.	RO pump running? Check if the motor start relay is jammed.
	Inlet valve [MV1] leaks.	Change / repair valve.
	Level sensor error.	Check setting in the software is correct for the tank size. Replace level sensor.
Inlet water pressure too low	The inlet water pressure is too low (below 0.5 bar at sensor) or inlet filter clogged	Check the inlet pressure at maximum flow for pump station according to specs. Replace inlet filter.
	The Inlet water pressure is too low for short periods (if inlet pressure and flow seems ok when measured)	Check the water installation for periodically high consumption e.g. cleaning, tank filling and maintenance work.
	Defect inlet pressure switch [PS]	Replace pressure switch.
EC too high after mix-bed	The selected alarm limit is reached.	Mixed bed filter full, replace filter. Alarm limit set incorrectly (screen 3.3). Alarm delay to short. EC scaling needs to be done (screen 3.3.1).
EC too high RO membrane	The selected alarm limit is reached.	Membrane warning or RO loop needs to be adjusted. Alarm limit set incorrectly (screen 3.3). Alarm delay to short. EC scaling needs to be done (screen 3.3.1).
Water quality – EC too low or too high	The selected alarm limit is reached.	Alarm limit set incorrectly (screen 3.3). EC scaling needs to be done. (screen 3.3.1).

Error message	Cause	Remedy
CIP overdosing last day	Self-monitoring system detects the CIP pump has been running to much in 24 hours cycle.	Press reset and check CIP pump for errors. Protected reset.
CIP pump error	General error detected.	Vent the CIP-pump, listen for noise and check pressure. Protected reset.
CIP pump low dosing	Insufficient CIP volume detected.	Check / refill CIP fluid. Air the CIP-pump.
UV lamp error	UV-Bulb or power supply error.	Replace UV-bulb. Check/replace power supply/transformer.
UV lamp getting old	Less than 3 weeks to UV lamp should be serviced.	Plan service. Reset timer.
UV lamp too old	Time to service UV lamp.	Service the UV lamp according to guide.
Add-on BOX EC-reg error	The choices made in the controller does not match the box detected in the network.	Change setting in controller.
Add-on BOX CIP error	The choices made in the controller does not match the box detected in the network.	Change setting in controller.
Add-on BOX (EC or CIP) commen error	Lost communication to Add-on BOX.	Power to EC box disconnected. Network cable to EC box disconnected.

6.5.2 Resetting the error indication

Press the reset button underneath the touch screen.

Note: If the fault has not been eliminated, the error indication reappears after a short while.

6.5.3 Malfunction without error indication

The following table provides malfunctions that do not trigger messages about the cause of the malfunction or information on how to eliminate the source of the malfunction.

Malfunction	Cause	Remedy
Control unit is switched on but the display does not show anything.	Main power supply is off.	Switch power on.
	Fuses of the power supply line blown.	Have an electrician replace fuses of the power supply line.
	Fuse of control unit blown.	Have an electrician replace fuse of the control unit.
	Display or control board defective.	Have a Condair service technician replace the display or the control board.
	Thermal motor projection relay activated.	Motor overheated, pump damaged/ blocked, check pump is running freely. Check power consumption at full load corresponds to motor specification.

7 Product data

7.1 Water supply preconditions

Preconditions	ML RO 100	ML RO 300	ML RO 500	ML RO 800	ML RO 1000	ML RO 1500
Water supply	Drinking water quality 2.5-7 bar at 200 l/h	Drinking water quality 2.5-7 bar at 600 l/h	Drinking water quality 2.5-7 bar at 700 l/h	Drinking water quality 2.5-7 bar at 1100 l/h	Drinking water quality 2.5-7 bar at 1400 l/h	Drinking water quality 2.5-7 bar at 2100 l/h
Water hardness	max. 20 °dH		max. 1 °dH			
Conductivity	250-1000 µS/cm					
Free chlorine	0.1 mg/l					
TDS	max. 625 mg/l					
Silt index	max. 3					
KMnO ₄	max. 10 mg/l					
Fe	max. 0.2 mg/l					
Mn	max. 0.05 mg/l					
NTU	max. 1.0					
Recommended inlet water temperature	15 °C					
Max. inlet water temperature	max. 40°C					

7.2 Product specifications

	ML RO 100	ML RO 300	ML RO 500	ML RO 800	ML RO 1000	ML RO 1500
Capacity (inlet water temperature 15 °C)	100 l/h	275 l/h	500 l/h	750 l/h	1000 l/h	1500 l/h
Permeate quality (µS/cm)	5 < EC <30	5 < EC <30	5 < EC <30	5 < EC <30	5 < EC <30	5 < EC <30
Permeate concentrate ratio	approx. 50/50 %	approx. 50/50 %	approx. 75/25 %	approx. 75/25 %	approx. 75/25 %	approx. 75/25 %
Reservoir tank	50 l	50 l	200 l	500 l	500 l	500 l
Frame size (LxWxH)	860x700x1600 mm	860x700x1600 mm	860x700x1600 mm	1400x700x1600 mm	1400x700x1600 mm	1400x700x1600 mm
Size, reservoir tank (LxWxH)	---	---	600x600x1540 mm	790x790x1400 mm	790x790x1400 mm	790x790x1400 mm
Weight pump station	110 kg	115 kg	220 kg	250 kg	270 kg	320 kg
Weight separate tank	---	---	35 kg	39 kg	39 kg	39 kg
Sound pressure level, dB(A)	< 75	< 75	< 80	< 80	< 80	< 75
Supply voltage	3x400V AC+GDN+N 50 Hz, 1.6 kW, 16 A	3x400 VAC+GDN+N 50 Hz, 2.1 kW, 16 A	3x400 VAC+GDN+N 50 Hz, 2.1 kW, 16 A	3x400 VAC+GDN+N 50 Hz, 2.1 kW, 16 A	3x400 VAC+GDN+N 50 Hz, 3.1 kW, 16 A	3x400 VAC+GDN+N 50 Hz, 3.1 kW, 16 A
	3x230 VAC+GDN+N 50 Hz, 1.6 kW, 16 A	3x230 VAC+GDN+N 50 Hz, 2.1 kW, 16 A	3x230 VAC+GDN+N 50 Hz, 2.1 kW, 16 A	3x230 VAC+GDN+N 50 Hz, 2.1 kW, 16 A	3x230 VAC+GDN+N 50 Hz, 3.2 kW, 16 A	3x230 VAC+GDN+N 50 Hz, 3.2 kW, 16 A
	3x208 VAC+GDN+N 60 Hz, 1.4 kW, 16 A	3x208 VAC+GDN+N 60 Hz, 1.8 kW, 16 A	3x208 VAC+GDN+N 60 Hz, 1.8 kW, 16 A	3x208 VAC+GDN+N 60 Hz, 1.8 kW, 16 A	3x208 VAC+GDN+N 60 Hz, 2.6 kW, 16 A	3x208 VAC+GDN+N 60 Hz, 2.6 kW, 16 A
Dissolved salt removal	>95%	>95%	>95%	>95%	>95%	>95%
Water connection tap water	3/4" RG	3/4" RG	3/4" RG	3/4" RG	3/4" RG	3/4" RG
Water connection RO water	3/4" RG	3/4" RG	3/4" RG	3/4" RG	3/4" RG	3/4" RG
Water connection drainage	3/4" RG	3/4" RG	3/4" RG	3/4" RG	3/4" RG	3/4" RG
Outgoing pressure RO water	3.0-4.2 bar	3.0-4.2 bar	3.0-4.2 bar	3.0-4.2 bar	3.0-5.0 bar	3.0-4.2 bar

8 Declaration of conformity



EC - Declaration of Compliance

Manufacturer:

Condair A/S
Parallelvej 2
8680 Ry

We hereby declare, that the following pump systems for humidification purposes:

ML RO 100; ML RO 300; ML RO 500; ML RO 800; ML RO 1000; ML RO 1500;
HP 100; HP 200 VFD; HP 300; HP 500; HP 500 VFD; HP 800; HP 800 VFD; HP 1300 VFD
HP RO 100; HP RO 200 VFD; HP RO 300; HP RO 500; HP RO 500 VFD; HP RO 800; HP RO 800 VFD
MLP 100; MLP 300; MLP 500; MLP 800; MLP 1000; MLP 2x800; MLP 2x1000; MLP 3x800; MLP 3x1000
MLP RO 100; MLP RO 300; MLP RO 500; MLP RO 800
MLP HRO 100; MLP HRO 300
MLPD 300; MLPD 500; MLPD 1000;
MLPG 100; MLPG 300; MLPG 500; MLPG 800; MLPG 1000;

are manufactured in accordance with the following EC directives:

- 2006/42/EC, Directive on machinery
- 2014/30/EC, EMC (ElectroMagnetic Compatibility) Directive
- 2014/35/EC, The low voltage directive
- 2011/65/EC, ROHS Directive on the restriction of the use of certain hazardous substances in electrical and electronic equipment.

The following harmonized standards have been applied:

- EN ISO 12100:2011, Safety of machinery – General principles for design – Risk assessment and risk reduction
- EN ISO 13849-1:2008, Safety of machinery – Safety-related parts of control systems – Part 1: General principles for design.
- EN 55022:2011+AC, Information technology equipment – Radio disturbance characteristics – Limits and methods of measurement
- EN 60204-1:2006 + amendments, Safety of machinery – Electrical equipment of machines – Part 1: General requirements

The following international standards and technical specifications are used:

- IEC 60034-1 ed. 12.0, Rotating electrical machines - Part 1: Rating and performance
- IEC 60034-5 ed. 4.1, Rotating electrical machines - Part 5: Degrees of protection provided by the integral design of rotating electrical machines (IP code) – Classification
- IEC 60034-6 ed. 2.0, Rotating electrical machines - Part 6: Methods of cooling (IC Code)
- IEC 60034-8 ed. 3.1, Rotating electrical machines - Part 8: Terminal markings and direction of rotation
- IEC 60320 ed. 2.1, Appliance couplers for household and similar general purposes - Part 1: General requirements

DK-Ry, November 26, 2015



Lasse Andresen, Technical Manager

Condair A/S
Parallelvej 2, DK-8680 Ry
Tel. +45 8788 2100
www.condairsystems.dk

9 Appendix

9.1 MODBUS communication TCP/IP

ML-System humidification controls with PLC control is available with an option that allows connection to CTS / BMS systems via Modbus TCP / IP.

The physical connection is made with a standard Ethernet cable that connects the PLC controller with a standard RJ45 connector.

The option includes changes in the software, and a list of setup and the addresses of parameters to be transferred between the PLC system and CTS / BMS.

The connection gives actual humidity for each section and general information about the system status. And it is possible to change setpoint from the BMS system. In addition, there is also a current "status" integer that describes the plant's operational status so alarms can be transferred to the BMS.

The modbus TCP / IP connection is set up with ML-System's PLC as Server/(slave) – and the BMS as a client/(master).

IP PLC: 192.168.135.220 mask 255.255.255.0
Connect ID 1
Port 502
MB Data addresser 40001 – 40033
Dataformat Integer (int)

Setpoint 1	R	Integer	40001	%RH
Setpoint 2	R	Integer	40002	%RH
Setpoint 3	R	Integer	40003	%RH
Setpoint 4	R	Integer	40004	%RH
Setpoint 5	R	Integer	40005	%RH
Setpoint 6	R	Integer	40006	%RH
Setpoint 7	R	Integer	40007	%RH
Setpoint 8	R	Integer	40008	%RH
Setpoint 9	R	Integer	40009	%RH
Setpoint 10	R	Integer	40010	%RH
Setpoint 11	R	Integer	40011	%RH
Setpoint 12	R	Integer	40012	%RH
Humidity 1	W	Integer	40013	%RH
Humidity 2	W	Integer	40014	%RH
Humidity 3	W	Integer	40015	%RH
Humidity 4	W	Integer	40016	%RH
Humidity 5	W	Integer	40017	%RH
Humidity 6	W	Integer	40018	%RH
Humidity 7	W	Integer	40019	%RH
Humidity 8	W	Integer	40020	%RH
Humidity 9	W	Integer	40021	%RH

Humidity 10	W	Integer	40022	%RH
Humidity 11	W	Integer	40023	%RH
Humidity 12	W	Integer	40024	%RH
Tank level	W	Integer	40025	%
Actual flow	W	Integer	40026	l/h (lb/h)
EC Ro	W	Integer	40027	µS
EC MB1	W	Integer	40028	µS
EC MB2	W	Integer	40029	µS
EC tank	W	Integer	40030	µS
Status mode	W	Integer	40031	
On/Off	W	Bool	40032.1	
alarm generel	W	Bool	40032.2	
Level in tank ok	W	Bool	40032.3	
Water pressure low	W	Bool	40032.4	
Pump overheated	W	Bool	40032.5	
Pump2 overheated	W	Bool	40032.6	
tank overfull	W	Bool	40032.7	
UV error	W	Bool	40032.8	
UV age warning	W	Bool	40032.9	
UV age alarm	W	Bool	40032.10	
Sensor error	W	Bool	40032.11	
MaxHyg error	W	Bool	40032.12	
Cip Alarm	W	Bool	40032.13	
EC RO alarm	W	Bool	40032.14	
EC MB1 alarm	W	Bool	40032.15	
EC MB2 alarm	W	Bool	40032.16	
EC tank high alarm	W	Bool	40033.1	
EC tank low alarm	W	Bool	40033.2	
Too many pump stopped	W	Bool	40033.3	
Internal setpoint	W	Bool	40033.4	
Not used	W	Bool	40033.5	
Not used	W	Bool	40033.6	
Not used	W	Bool	40033.7	
Not used	W	Bool	40033.8	
Not used	W	Bool	40033.9	
Not used	W	Bool	40033.10	
Not used	W	Bool	40033.11	
Not used	W	Bool	40033.12	
Not used	W	Bool	40033.13	
Not used	W	Bool	40033.14	
Not used	W	Bool	40033.15	
Not used	W	Bool	40033.16	

9.2 Water softener MACH 2030, 2060, 2100 & CP 213S

9.2.1 Installation instructions

1. Remove the cardboard packaging from the individual parts.
2. The system consists of two filters, a salt reservoir, drain/salt hoses as well as connecting pieces incl. O-rings and silicone.



3. Fit the enclosed O-rings on the black plastic/brass connecting pieces and lubricate with silicone from the small tube. Then install the connecting pieces shown in the pictures below.



4. Make sure there are no mechanical impurities following the installation work. If necessary, flush the pipework before installing the system.
5. Install the drain hose on the head of the water softener in the associated drain connector and tighten the nut by hand, see below.



1. Outlet, soft water
2. Inlet, raw water
3. Tube for floor drain (thick, transparent)
4. Tube for salt reservoir (thin, black)
5. Connecting pieces

6. Connect the salt hose to the water softener head in the associated pipe connection and tighten the nut by hand. The drain hose and the salt hose must not be exchanged as they have individual dimensions.
7. Then install pressure hoses for raw water and soft water outlet, respectively, on the system (1 and 2 in the photo above).

8. Lead the drain hose to the floor drain.
9. The salt reservoir is provided with an overflow connector which is lead to the floor drain.



10. The system is now ready for start-up.
Note: There must always be a floor drain to avoid damage caused by leakage.

9.2.2 Start-up procedure

1. Check that the number on the standard-installed meter disc corresponds to the hardness on site. If not, the meter disc must be replaced. Order the correct meter disc from KINETICO or from your supplier.

Adjustment of salt valve in salt reservoir

2. To obtain the right setting of the adjustment tube, a certain number of tabs must be removed (the yellow plastic part in the photo to the right). This is done using a sharp knife, removing the tabs individually with the knife – cut in the longitudinal direction under the tabs. Keep the number or letter that is to be the setting point as the top tab.
3. Adjust the float in the following manner: the numbers for the float are indicated on the adjusting rod (photo to the right). The top edge of the float must be aligned with the number strip. (Note: With CP 213s, the bottom edge of the float applies). The holder of the salt valve must be positioned horizontally above the valve and the adjusting rod must be parallel with the valve tube, i.e. the adjusting pipe must not be twisted.



4. When installing the salt valve, be careful not to drop it down into the cylinder. If it is dropped, the float may sink and give an incorrect setting. Place the valve in such a way that the bent 3/8" pipe is placed along the back of the salt well away from the cylinder wall. Now press the 3/8" bent pipe into the notch, so that it extends 25 mm from the brine cylinder (see photo to the right).
5. The valves on the outlet sides and the bypass valve (if installed) must be closed.
6. Open the valves on the inlet sides slightly so that the filter slowly fills with water. At the same time, the brine tank will be filled with water by means of the brine valve.
7. First, set one and then the other tank in backwash mode for a while to vent any air from the system. Do this by pressing down the Phillips screw at the centre of the automatics while turning it clockwise. Check that the water runs out of the outlet hose to the drain.
8. When any air has been vacated from the system, start the filter (black dot, 12 or 6 o'clock position) by turning Phillips screw again.
9. Then open the valve on the outlet and inlet side fully.

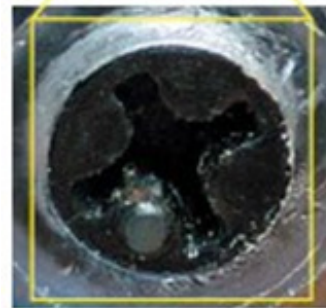

10. Check that the water runs into the salt container vat until the brine valve on the tank closes. Check that the water is above the mesh plate.
11. Fill the tank with salt tablets.
12. Normally, there must be so much salt in the salt reservoir that the water is completely covered - top up with salt.
13. The system is now ready for operation and will produce softened water right away.

9.2.3 Declaration of conformity water softening units

DECLARATION OF CONFORMITY FOR CE CERTIFICATION

In Accordance to ISO/IEC Guide 22

For

WATER SOFTENING UNITS

MANUFACTURER: Kinetico Incorporated
10845 Kinsman Road
Newbury, OH 44065
Phone: 440.564.9111 Fax: 440.564.4407

MODEL NUMBERS: 2020C, 2025S, 2030S, 2050S, 2060S, 2100S, 2175S,
4050S, 2060S OD, 2100S OD, HT613, HT618, HT621,
CC206C, CC208C, 2175S, CP213S OD, CP216S OD

REPORT NUMBERS: AAAQ1594-01S

DIRECTIVE: Low Voltage Directive (72/23/EEC), 1973; including
Amendment (93/68/EEC), 1993

STANDARD: EN 14743 – Water Equipment Inside Buildings: Softeners –
Requirements for Performance, Safety and Testing

TEST FACILITY: F-Squared Laboratories
26501 Ridge Rd.
Damascus, MD 20872

The water softening units, model numbers 2020C, 2025S, 2030S, 2050S, 2060S, 2100S, 2175S, 4050S, 2060S OD, 2100S OD, HT613, HT618, HT621, CC206C, CC208C, 2175S, CP213S OD, CP216S OD are in effective conformance to the Directive and Standard referenced above.

Authorized By:



Thomas P. Goshe
Standards and Regulatory Compliance Manager
Kinetico Incorporated
June 10, 2010

Notes



Warranty

Condair Inc. or Condair Ltd. (depending on the entity that supplied the product, and hereinafter collectively referred to as CONDAIR) warrant for a period of two years after installation or 30 months from the manufacturer's ship date, whichever date is earlier, that CONDAIR's manufactured and assembled products, not otherwise expressly warranted, are free from defects in materials and workmanship. Notwithstanding the foregoing, the products listed below have an alternate warranty period:

- GS/GSTC Series heat exchanger(s) are warranted to be free from defects in materials and workmanship for a period of 3 years from installation or 40 months from the manufacturer's ship date, whichever is earlier.
- SAM-e Short Absorption Manifolds, except for the coupling seals, are warranted to be free from defects in materials and workmanship for a total period of 10 years from the manufacturer's ship date.
- Humilife RH humidifiers are warranted to be free from defects in materials and workmanship for a period of 5 years from the manufacturer's ship date. CONDAIR may, at its discretion, replace individual components or Humilife RH units as a whole.
- Spare Parts used for repairs are warranted for the balance of the term of the warranty on the original humidifier or 90 days, whichever is longer.
- No warranty is made against corrosion, deterioration, or suitability of substituted materials used as a result of compliance with government regulations.

CONDAIR's obligations and liabilities under this warranty are limited to furnishing replacement parts to the customer, F.O.B. CONDAIR's factory. The replacement parts are warranted for the balance of the term of the warranty on the original humidifier or 90 days, whichever is longer. Procedure:

1. Customer Requests Warranty as per instructions on the CONDAIR Warranty Form.
2. CONDAIR reviews the warranty claim and will respond in one of two ways:
 - a. Warranty Accepted – Replacement Part or credit granted.
 - b. Warranty Declined – Response with justification will be provided to the customer.
3. In some cases, CONDAIR may request the part to be returned, freight prepaid by the customer, as part of the warranty acceptance or warranty determination process. Some reasons include:
 - a. Part must be analyzed to determine the root cause of failure.
 - b. Part must be returned to the supplier for claim/investigation.

When parts are requested to be returned, replacement parts will be sent by CONDAIR to the customer against an invoice from CONDAIR paid by the customer. The cost of the replacement parts will be reimbursed to the customer with a credit note after the parts are received and analyzed by CONDAIR, if the warranty is accepted.

The warranties set forth herein are in lieu of all other warranties expressed or implied by law. No liability whatsoever shall be attached to CONDAIR until said products have been paid for in full and then said liability shall be limited to the original purchase price for the product. Any further warranty, with the exception of a purchased extended warranty described below, must be in writing, and signed by an officer of CONDAIR.

CONDAIR makes no warranty and assumes no liability unless the equipment is installed in strict accordance with the installation manual in effect at the date of purchase, and by properly qualified and licensed professionals capable of installing such equipment.

CONDAIR makes no warranty and assumes no liability whatsoever for consequential damage or damage resulting directly from misapplication, incorrect sizing, or lack of proper maintenance of the equipment.

CONDAIR makes no warranty and assumes no liability whatsoever for damage to the products, humidifier, supply lines, drain lines, steam distribution systems, or the building as a whole caused by freezing.

CONDAIR reserves the right to change the design, specifications, and performance criteria of its products without notice or obligation.

Extended Warranty

Extended warranties are available to purchase under the conditions listed above. Extended warranties must be purchased at the time of the original equipment order.



www.condairparts.com

Buy authentic Condair
parts factory direct.

Would you recommend Condair?
Take our two question survey.



U.S.A.
1021 6th Street
Racine, WI 53403

CANADA
2740 Fenton Road
Ottawa, Ontario K1T 3T7

TEL: 1.866.667.8321
EMAIL: na.info@condair.com
WEBSITE: www.condair.com

