

AERIC

DEHUMIDIFIER

USER'S MANUAL

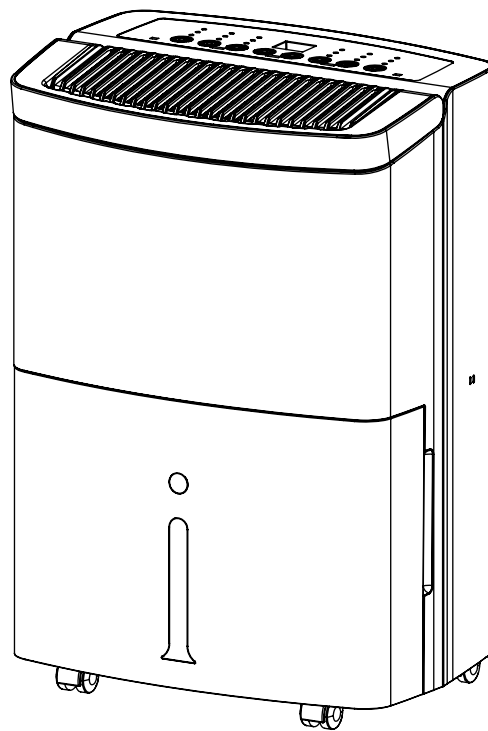

Model: AERD351P

TABLE OF CONTENTS

IMPORTANT SAFETY INTRODUCTIONS.....	1-10	MAINTENANCE	14
IDENTIFICATION OF PARTS	11	FUNCTION EXPLANATION	14
FUNCTION EXPLANATION.....	11-12	TROUBLESHOOTING.....	15
OPERATING INSTRUCTIONS.....	13	WARRANTY	16
CONTINUOUS DRAINAGE	13-14		





Please read the manual carefully before using the appliance.

IMPORTANT SAFETY INTRODUCTIONS

















READ THIS MANUAL

Inside you will find many helpful tips on how to use and maintain your dehumidifier properly. Just a little preventive care on your part can save you a great deal of time and money over the life of your dehumidifier. You'll find many answers to common problems in the chart of troubleshooting tips. If you review our chart of Troubleshooting. Tips first, you may not need to call for service at all.

To prevent injury to the user or other people and property damage, the following instructions must be followed. Incorrect operation due to ignoring of instructions may cause harm or damage. The seriousness is classified by the following indications.

 WARNING	This symbol indicates the possibility of death or serious injury.		
 CAUTION	This symbol indicates the possibility of injury or damage to property.		
	Never do this.		Always do this.

WARNING

 Plug in power plug properly.	 Do not operate or stop the unit by inserting or pulling out the power plug.	 Do not damage or use an unspecified power cord.
<ul style="list-style-type: none"> Otherwise, it may cause electric shock or fire due to excess heat generation. 	<ul style="list-style-type: none"> It may cause electric shock or fire due to heat generation. 	<ul style="list-style-type: none"> It may cause electric shock or fire. If the power cord is damaged, it must be replaced by the manufacturer or an authorised service centre or a similarly qualified person in order to avoid a hazard.
 Always install circuit breaker and a dedicated power circuit.	 Do not operate with wet hands or in damp environment.	 Do not direct airflow at room occupants only.
<ul style="list-style-type: none"> Incorrect installation may cause fire and electric shock. 	<ul style="list-style-type: none"> It may cause electric shock. 	<ul style="list-style-type: none"> This could damage your health.
 Always ensure effective grounding	 Do not allow water to run into electric parts.	 Do not modify power cord length or share the outlet with other appliances.
<ul style="list-style-type: none"> Incorrect grounding may cause electric shock. 	<ul style="list-style-type: none"> It may cause failure of machine or electric shock. 	<ul style="list-style-type: none"> It may cause electric shock or fire due to heat generation.
 Unplug the unit if strange sounds, smell, or smoke comes from it.	 Do not use the socket if it is loose damaged.	 Do not open the unit during operation.
<ul style="list-style-type: none"> It may cause fire and electric shock. 	<ul style="list-style-type: none"> It may cause fire and electric shock. 	<ul style="list-style-type: none"> It may cause electric shock.
 Keep firearms away.	 Do not use the unit close to heating appliances.	 Do not use the unit near flammable substances, pressurised container (eg aerosol cans), or combustibles, such as gasoline, benzene, thinner, etc.
<ul style="list-style-type: none"> It may cause fire. 	<ul style="list-style-type: none"> It may cause fire and electric shock. 	<ul style="list-style-type: none"> It may cause an explosion or fire.
 Ventilate room before operating dehumidifier if there is a gas leakage from another appliance.	 Do not disassemble or modify unit.	
<ul style="list-style-type: none"> It may cause explosion, fire and, burns. 	<ul style="list-style-type: none"> It may cause failure and electric shock. 	

IMPORTANT SAFETY INTRODUCTIONS

CAUTION

<p>⊘ When the air filter is to be removed, do not touch the metal parts of the unit.</p>	<p>⊘ Do not put a pet or house plant where it will be exposed to direct air flow.</p>	<p>⊘ Do not use in the room containing sulphur, gas or oil.</p>
<ul style="list-style-type: none"> • It may cause an injury. 	<ul style="list-style-type: none"> • This could injure the pet or plant. 	<ul style="list-style-type: none"> • It may cause an explosion or fire.
<p>⊘ Do not use strong detergent such as wax or thinner but use a soft cloth.</p>	<p>⊘ Do not clean the dehumidifier with water.</p>	<p>⊘ Do not use for special purposes.</p>
<ul style="list-style-type: none"> • Appearance may be deteriorated due to change of product color or scratching of its surface. 	<ul style="list-style-type: none"> • Water may enter the unit and degrade the insulation. It may cause an electric shock. 	<ul style="list-style-type: none"> • Do not use this dehumidifier to preserve precision devices, food, pets, plants, and art objects. It may cause deterioration of quality, etc.
<p>⊘ Stop operation and close the window in storm or hurricane.</p>	<p>⊘ When the unit is to be cleaned, switch off, and turn off the circuit breaker.</p>	
<ul style="list-style-type: none"> • Operation with windows opened may cause wetting of indoor and soaking of household furniture. 	<ul style="list-style-type: none"> • Do not clean unit when power is on as it may cause fire and electric shock, it may cause an injury. 	
<p>⊘ Always insert the filters securely. Clean filter once every two weeks.</p>	<p>⊘ Hold the plug by the head of the power plug when taking it out.</p>	<p>⊘ Turn off the main power switch when not using the unit for a long time.</p>
<ul style="list-style-type: none"> • Operation without filters may cause failure. 	<ul style="list-style-type: none"> • It may cause electric shock and damage. 	<ul style="list-style-type: none"> • It may cause failure of product or fire.
<p>⊘ Do not place obstacles around air-inlets or inside of air-outlet.</p>	<p>⊘ Do not place heavy object on the power cord and ensure that the cord is not compressed.</p>	<p>⊘ Do not drink water drained from dehumidifier.</p>
<ul style="list-style-type: none"> • It may cause failure of appliance or accident. 	<ul style="list-style-type: none"> • There is danger of fire or electric shock. 	<ul style="list-style-type: none"> • It contains contaminants and could make you sick.
<p>⊘ Use caution when unpacking and installing. Sharp edges could cause injury.</p>	<p>⊘ If water enters the unit, turn the unit off at the power outlet and switch off the circuit breaker. Isolate supply by taking the power-plug out and contact a qualified service technician.</p>	

CAUTION

- This appliance is not intended for use by persons (including children) with reduced physical, sensory or mental capabilities, or lack of experience and knowledge, unless they have been given supervision or instruction concerning use of the appliance by person responsible for their safety.
- Children should be supervised to ensure that they do not play with the appliance.
- If the SUPPLY CORD is damaged, it must be replaced by the manufacturer, its service agent or similarly qualified persons in order to avoid a hazard.
- The appliance shall be installed in accordance with national wiring regulations.
- Do not operate your dehumidifier in a wet room such as a bathroom or laundry room.
- The appliance with electric heater shall have at least 2 feet space to the combustible materials.
- Contact the authorised service technician for repair or maintenance of this unit.

IMPORTANT SAFETY INTRODUCTIONS

WARNING

Avoid fire hazard or electric shock. Do not use an extension cord or an adaptor plug. Do not remove any prong from the power cord.

Grounding type wall receptacle

Do not, under any circumstances, cut, remove, or bypass the grounding prong.



Power supply cord with 3-prong grounding plug and current detection device

PLACEMENT

At least 7.9 inches (20 cm) air space between front/rear/left/right sides of dehumidifier and adjacent obstacle and at least 24 inches (61 cm) air space between top side of dehumidifier and adjacent obstacle should be maintained during normal operation.

WARNING

For Your Safety

Do not store or use gasoline or other flammable vapors and liquids in the vicinity of this or any other appliance.

WARNING

Prevent Accidents

To reduce the risk of fire, electrical shock, or injury to persons when using your dehumidifier, follow basic precautions, including the following:

- Be sure the electrical service is adequate for the model you have chosen. This information can be found on the serial plate, which is located on the back of the the cabinet.
- Be sure the dehumidifier has been securely and correctly installed according to the installation instructions in this manual. Save this manual for possible future use in removing or installing this unit.
- When handling the dehumidifier, be careful to avoid cuts from sharp metal fins on front and rear coils.

WARNING

Electrical Information

The complete electrical rating of your new dehumidifier is stated on the serial plate. Refer to the rating when checking the electrical requirements.

- Be sure the dehumidifier is properly grounded. To minimize shock and fire hazards, proper grounding is important. The power cord is equipped with a three-prong grounding plug for protection against shock hazards.
- Your dehumidifier must be used in a properly grounded wall receptacle. If the wall receptacle you intend to use is not adequately grounded or protected by a time delay fuse or circuit breaker, have a qualified electrician install the proper receptacle. Ensure the receptacle is accessible after the unit installation.
- **Do not use an extension cord or an adapter plug.**

IMPORTANT SAFETY INTRODUCTIONS

WARNING

- All wiring must comply with local and national electrical codes and be installed by a qualified electrician. If you have any question regarding the following instructions, contact a qualified electrician.
- Check available power supply and resolve any wiring problems before installation and operation of this unit.
- Only install and operate this appliance as outlined in this instruction manual. At all times, use care when using this appliance.
- The appliance shall be installed in accordance with national wiring regulations.
- The appliance should be transported upright or on its side. Any internal circuit water should be emptied before moving. Do not turn on the appliance for at least one hour before starting it.
- Do not store anything on top of the appliance, especially heavy or hot objects.
- Do not store the appliance covered with plastic bags.
- Please follow the regulations and guidelines for proper disposal of packaging as well as electrical devices in your area. Check with your local authority or retailer for recycling options.
- Do not place the unit in front of curtains or drapes in case they fall against the back air intake.
- This appliance is for household use only.

WARNING

- Do not wet the housing or control panel.
- Do not cover the air outlet while in use.
- Do not place objects or let any person sit on top of the unit.
- Do not attempt to remove any part of the casing unless by an authorised technician.
- Remove the plug from the socket if the unit is not being used for long periods of time.
- Use only the correct power supply AC 115V~60Hz.

SPECIFICATIONS

Figures noted, in the contents are for reference only; variation may result due to application in different countries or regions, and shall be based on the best of practical operation.

Voltage/Frequency	AC 115V~60Hz
Refrigerant Type	R32
Working Temperature	41°F - 89.6°F (5°C - 32°C)
Working Humidity	30% - 90%RH

NOTE

Wiring diagram affixed inside the rear panel

NOTE

Waste electrical products should not be disposed of with household waste. Please recycle where facilities exist. Check with your local authority or retailer for recycling advice.



IMPORTANT SAFETY INTRODUCTIONS

WARNING (FOR USING R32 REFRIGERANT ONLY)

- READ THE MANUAL CAREFULLY BEFORE USING THE APPLIANCE.
- Stagnation of possible leaks of refrigerant gas in unventilated rooms could lead to fire or an explosion hazard should the refrigerant come in contact with electric heaters, stoves or other sources of ignition.
- Use care when storing the appliance to prevent mechanical faults.
- Only persons authorized by an accredited agency certifying their competence to handle refrigerants in compliance with sector legislation should work on refrigerant circuits.
- Do not use means to accelerate the defrosting process or to clean, other than those recommended by the manufacturer.
- The appliance shall be stored in a room without continuously operating ignition sources (for example: open flames, an operating gas appliance) and ignition sources or (for example: an operating electric heater) close to the appliance.
- Do not pierce or burn.
- Be aware that refrigerants may not contain an odour.
- Compliance with national gas regulations shall be observed.
- Keep ventilation openings clear of obstruction.
- The appliance shall be stored so as to prevent mechanical damage from occurring.
- A warning that the appliance shall be stored in a well-ventilated area where the room size corresponds to the room area as specified for operation.
- Any person who is involved with working on or breaking into a refrigerant circuit should hold a current valid certificate from an industry-accredited assessment authority, which authorizes their competence to handle refrigerants safely in accordance with an industry recognized assessment specification.
- Servicing shall only be performed as recommended by the equipment manufacturer.
- Maintenance and repair requiring the assistance of other skilled personnel shall be carried out under the supervision of the person competent in the use of flammable refrigerants.
- DO NOT modify the length of the power cord or use an extension cord to power the unit.
- DO NOT share a single outlet with other electrical appliances. Improper power supply can cause fire or electrical shock.
- Please follow the instruction carefully to handle, install, clear or service the dehumidifier to avoid any damage or hazard. Flammable Refrigerant R32 is used within dehumidifier. When maintaining or disposing the dehumidifier, the refrigerant (R32) shall be properly recovered and not discharged into the air.
- No open fire or device which may generate spark/arc shall be around dehumidifier to avoid causing ignition of the flammable refrigerant used. Please follow the instruction carefully to store or maintain the dehumidifier to prevent mechanical damage from occurring.
- Flammable refrigerant R32 is used in dehumidifier. Please follow the instruction carefully to avoid any hazard.







A2L



IMPORTANT SAFETY INTRODUCTIONS

Explanation of symbols displayed on the unit (For the unit adopts R32 Refrigerant only)

	WARNING	This symbol shows that this appliance used a flammable refrigerant. If the refrigerant is leaked and exposed to an external ignition source, there is a risk of fire.
	CAUTION	This symbol shows that the operation manual should be read carefully.
	CAUTION	This symbol shows that a service personnel should be handling this equipment with reference to the installation manual.
	CAUTION	This symbol shows that information is available such as the operating manual or installation manual.

WARNING (FOR USING R32 REFRIGERANT ONLY)

1. Transport of equipment containing flammable refrigerants
See transport regulations.
2. Marking of equipment using signs
See local regulations.
3. Disposal of equipment using flammable refrigerants
See national regulations.
4. Storage of equipment/appliances
The storage of equipment should be in accordance with the manufacturer's instructions.
5. Storage of packed (unsold) equipment
Storage package protection should be constructed such that mechanical damage to the equipment inside the package will not cause a leak of the refrigerant charge. The maximum number of pieces of equipment permitted to be stored together will be determined by local regulations.
6. Information on servicing
 - a) Checks to the area: Prior to beginning work on systems containing flammable refrigerants, safety checks are necessary to ensure that the risk of ignition is minimized. For repair to the refrigerating system, the following precautions shall be complied with prior to conducting work on the system.
 - b) Work procedure: Work shall be undertaken under a controlled procedure so as to minimize the risk of a flammable gas or vapour being present while the work is being performed.
 - c) General work area: All maintenance staff and others working in the local area shall be instructed on the nature of work being carried out. Work in confined spaces shall be avoided. The area around the workspace shall be sectioned off. Ensure that the conditions within the area have been made safe by control of flammable material.
 - d) Checking for presence of refrigerant: The area shall be checked with an appropriate refrigerant detector prior to and during work, to ensure the technician is aware of potentially flammable atmospheres. Ensure that the leak detection equipment being used is suitable for use with flammable refrigerants, i.e. non-sparking, adequately sealed or intrinsically safe.

IMPORTANT SAFETY INTRODUCTIONS

- e) Presence of fire extinguisher: If any hot work is to be conducted on the refrigeration equipment or any associated parts, appropriate fire extinguishing equipment shall be available to hand. Have a dry powder or CO2 fire extinguisher adjacent to the charging area.
- f) No ignition sources: No person carrying out work in relation to a refrigeration system which involves exposing any pipe work that contains or has contained flammable refrigerant shall use any sources of ignition in such a manner that it may lead to the risk of fire or explosion. All possible ignition sources, including cigarette smoking, should be kept sufficiently far away from the site of installation, repairing, removing and disposal, during which flammable refrigerant can possibly be released to the surrounding space. Prior to work taking place, the area around the equipment is to be surveyed to make sure that there are no flammable hazards or ignition risks. No Smoking signs shall be displayed.
- g) Ventilated area: Ensure that the area is in the open or that it is adequately ventilated before breaking into the system or conducting any hot work. A degree of ventilation shall continue during the period that the work is carried out. The ventilation should safely disperse any released refrigerant and preferably expel it externally into the atmosphere.
- h) Checks to the refrigeration equipment: Where electrical components are being changed, they shall be fit for the purpose and to the correct specification. At all times the manufacturer's maintenance and service guidelines shall be followed. If in doubt consult the manufacturer's technical department for assistance. The following checks shall be applied to installations using flammable refrigerants:
- The charge size is in accordance with the room size within which the refrigerant containing parts are installed;
 - The ventilation machinery and outlets are operating adequately and are not obstructed;
 - If an indirect refrigerating circuit is being used, the secondary circuit shall be checked for the presence of refrigerant;
 - Marking to the equipment continues to be visible and legible. Markings and signs that are illegible shall be corrected;
 - Refrigeration pipe or components are installed in a position where they are unlikely to be exposed to any substance which may corrode refrigerant containing components, unless the components are constructed of materials which are inherently resistant to being corroded or are suitably protected against being so corroded.
- i) Checks to electrical devices: Repair and maintenance to electrical components shall include initial safety checks and component inspection procedures. If a fault exists that could compromise safety, then no electrical supply shall be connected to the circuit until it is satisfactorily dealt with. If the fault cannot be corrected immediately but it is necessary to continue operation, an adequate temporary solution shall be used. This shall be reported to the owner of the equipment so all parties are advised. Initial safety checks shall include:
- That capacitors are discharged: this shall be done in a safe manner to avoid possibility of sparking;
 - That there no live electrical components and wiring are exposed while charging, recovering or purging the system;
 - That there is continuity of grounding.
7. Repairs to sealed components

IMPORTANT SAFETY INTRODUCTIONS

- a) During repairs to sealed components, all electrical supplies shall be disconnected from the equipment being worked upon prior to any removal of sealed covers, etc. If it is absolutely necessary to have an electrical supply to equipment during servicing, then a permanently operating form of leak detection shall be located at the most critical point to warn of a potentially hazardous situation.
- b) Particular attention shall be paid to the following to ensure that by working on electrical components, the casing is not altered in such a way that the level of protection is affected. This shall include damage to cables, excessive number of connections, terminals not made to original specification, damage to seals, incorrect fitting of glands, etc.
 - Ensure that apparatus is mounted securely.
 - Ensure that seals or sealing materials have not degraded such that they no longer serve the purpose of preventing the ingress of flammable atmospheres. Replacement parts shall be in accordance with the manufacturer's specifications.

▲ NOTE: The use of silicon sealant may inhibit the effectiveness of some types of leak detection equipment. Inherently safe components do not have to be isolated prior to working on them.

8. Repair to inherently safe components

Do not apply any permanent inductive or capacitance loads to the circuit without ensuring that this will not exceed the permissible voltage and current permitted for the equipment in use.

Inherently safe components are the only types that can be worked on while live in the presence of a flammable atmosphere. The test apparatus shall be at the correct rating. Replace components only with parts specified

by the manufacturer. Other parts may result in the ignition of refrigerant in the atmosphere from a leak.

9. Cabling

Check that cabling will not be subject to wear, corrosion, excessive pressure, vibration, sharp edges or any other adverse environmental effects. The check shall also take into account the effects of aging or continual vibration from sources such as compressors or fans.

10. Detection of flammable refrigerants

Under no circumstances shall potential sources of ignition be used in the searching for or detection of refrigerant leaks. A halide torch (or any other detector using a naked flame) shall not be used.

11. Leak detection methods

The following leak detection methods are deemed acceptable for systems containing flammable refrigerants. Electronic leak detectors shall be used to detect flammable refrigerants, but the sensitivity may not be adequate, or may need re-calibration. (Detection equipment shall be calibrated in a refrigerant-free area.) Ensure that the detector is not a potential source of ignition and is suitable for the refrigerant used. Leak detection equipment shall be set at a percentage of the LFL of the refrigerant and shall be calibrated to the refrigerant employed and the appropriate percentage of gas (25 % maximum) is confirmed. Leak detection fluids are suitable for use with most refrigerants but the use of detergents containing chlorine shall be avoided as the chlorine may react with the refrigerant and corrode the copper pipe-work. If a leak is suspected, all naked flames shall be removed/ extinguished. If a leakage of refrigerant is found which requires brazing, all of the refrigerant shall be recovered from the system, or isolated (by means of shut off valves) in a part of the system remote from the leak. Oxygen free nitrogen (OFN) shall then be purged through the system both before and during the brazing process.

IMPORTANT SAFETY INTRODUCTIONS

12. Removal and evacuation

When breaking into the refrigerant circuit to make repairs or for any other purpose conventional procedures shall be used. However, it is important that best practice is followed since flammability is a consideration. Opening of the refrigeration systems shall not be done by brazing. The following procedure shall be adhered to:

- Remove refrigerant;
- Purge the circuit with inert gas;
- Evacuate;
- Purge again with inert gas;
- Open the circuit by cutting or brazing.

The refrigerant charge shall be recovered into the correct recovery cylinders. The system shall be flushed with OFN to render the unit safe. This process may need to be repeated several times. Compressed air or oxygen shall not be used for this task.

Flushing shall be achieved by breaking the vacuum in the system with OFN and continuing to fill until the working pressure is achieved, then venting to atmosphere, and finally pulling down to a vacuum. This process shall be repeated until no refrigerant is within the system. When the final OFN charge is used, the system shall be vented down to atmospheric pressure to enable work to take place. This operation is absolutely vital if brazing operations on the pipe-work are to take place.

Ensure that the outlet for the vacuum pump is not close to any ignition sources and there is ventilation available.

13. Charging procedures

In addition to conventional charging procedures, the following requirements shall be followed.

- Ensure that contamination of different refrigerants does not occur when using charging equipment. Hoses or lines shall be as short as possible to minimize the

amount of refrigerant contained in them.

- Cylinders shall be kept upright.
- Ensure that the refrigeration system is earthed prior to charging the system with refrigerant.
- Label the system when charging is complete (if not already).
- Extreme care shall be taken not to overfill the refrigeration system.
- Prior to recharging the system it shall be pressure tested with OFN. The system shall be leak tested on completion of charging but prior to commissioning. A follow up leak test shall be carried out prior to leaving the site.

14. Decommissioning

Before carrying out this procedure, it is essential that the technician is completely familiar with the equipment and all its detail. It is recommended good practice that all refrigerants are recovered safely. Prior to the task being carried out, an oil and refrigerant sample shall be taken in case analysis is required prior to re-use of reclaimed refrigerant. It is essential that electrical power is available before the task 's commenced.

- a) Become familiar with the equipment and its operation.
- b) Isolate system electrically.
- c) Before attempting the procedure ensure that: Mechanical handling equipment is available, if required, for handling refrigerant cylinders; All personal protective equipment is available and being used correctly; The recovery process is supervised at all times by a competent person; Recovery equipment and cylinders conform to the appropriate standards.
- d) Pump down refrigerant system, if possible.
- e) If a vacuum is not possible, make a manifold so that refrigerant can be removed from various parts of the system.
- f) Make sure that cylinder is situated on the

IMPORTANT SAFETY INTRODUCTIONS

scales before recovery takes place.

- g) Start the recovery machine and operate in accordance with manufacturer's instructions.
- h) Do not overfill cylinders. (No more than 80 % volume liquid charge).
- i) Do not exceed the maximum working pressure of the cylinder, even temporarily.
- j) When the cylinders have been filled correctly and the process completed, make sure that the cylinders and the equipment are removed from site promptly and all isolation valves on the equipment are closed off.
- k) Recovered refrigerant shall not be charged into another refrigeration system unless it has been cleaned and checked.

15. Labelling

Equipment shall be labelled stating that it has been de-commissioned and emptied of refrigerant. The label shall be dated and signed. Ensure that there are labels on the equipment stating the equipment contains flammable refrigerant.

16. Recovery

When removing refrigerant from a system, either for servicing or decommissioning, it is recommended good practice that all refrigerants are removed safely.

When transferring refrigerant into cylinders, ensure that only appropriate refrigerant recovery cylinders are employed. Ensure that the correct number of cylinders for holding the total system charge is available. All cylinders to be used are designated for the recovered refrigerant and labelled for that refrigerant

(i.e. special cylinders for the recovery of refrigerant). Cylinders shall be complete with pressure relief valve and associated shut-off valves in good working order.

Empty recovery cylinders are evacuated and, if possible, cooled before recovery occurs. The recovery equipment shall be in good working order with a set of instructions concerning the equipment that is at hand and shall be suitable for the recovery of flammable refrigerants.

In addition, a set of calibrated weighing scales shall be available and in good working order. Hoses shall be complete with leak-free disconnect couplings and in good condition. Before using the recovery machine, check that it is in satisfactory working order, has been properly maintained and that any associated electrical components are sealed to prevent ignition in the event of a refrigerant release. Consult manufacturer if in doubt.

The recovered refrigerant shall be returned to the refrigerant supplier in the correct recovery cylinder, and the relevant Waste Transfer Note arranged. Do not mix refrigerants in recovery units and especially not in cylinders. If compressors or compressor oils are to be removed, ensure that they have been evacuated to an acceptable level to make certain that flammable refrigerant does not remain within the lubricant. The evacuation process shall be carried out prior to returning the compressor to the suppliers. Only electric heating to the compressor body shall be employed to accelerate this process. When oil is drained from a system, it shall be carried out safely.

IDENTIFICATION OF PARTS

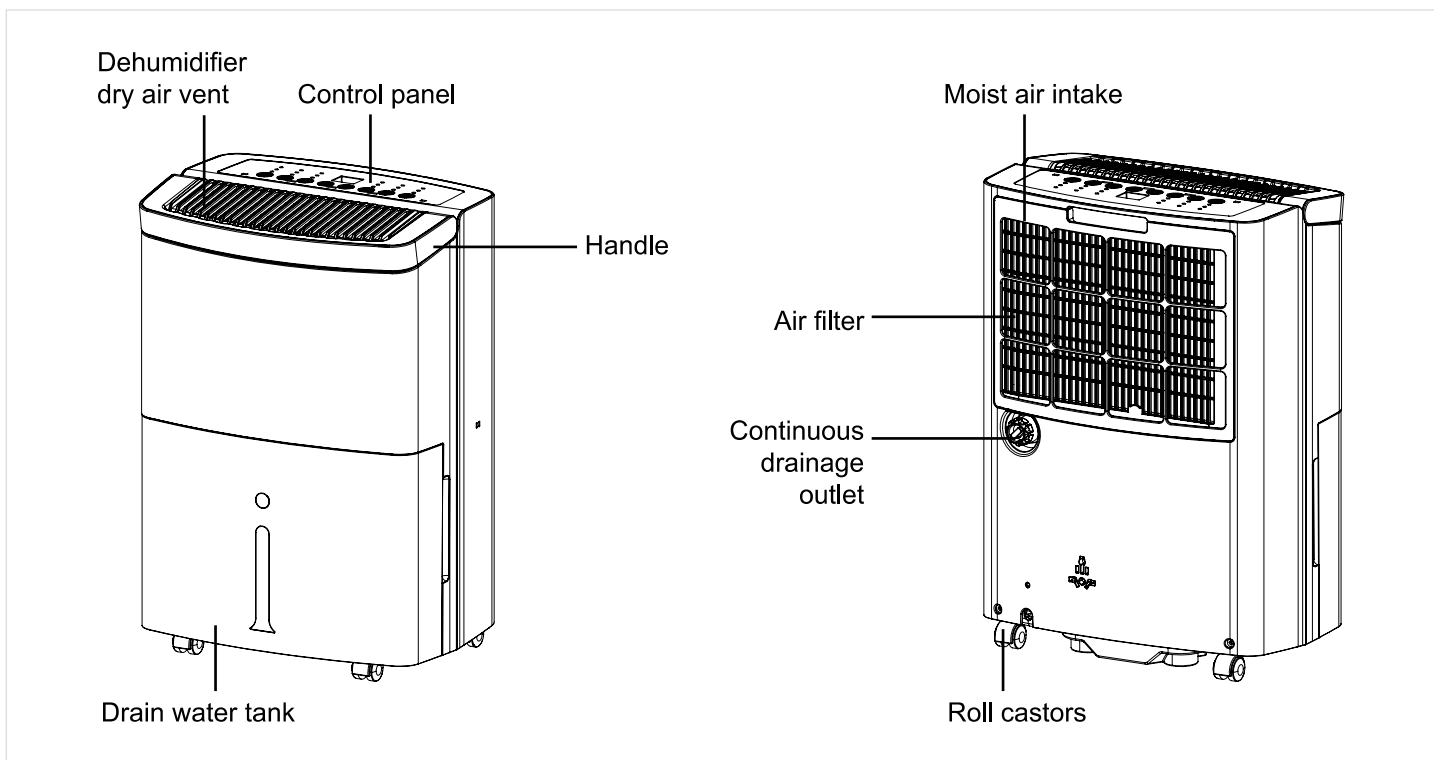

FUNCTION EXPLANATION

CONTROL PANEL

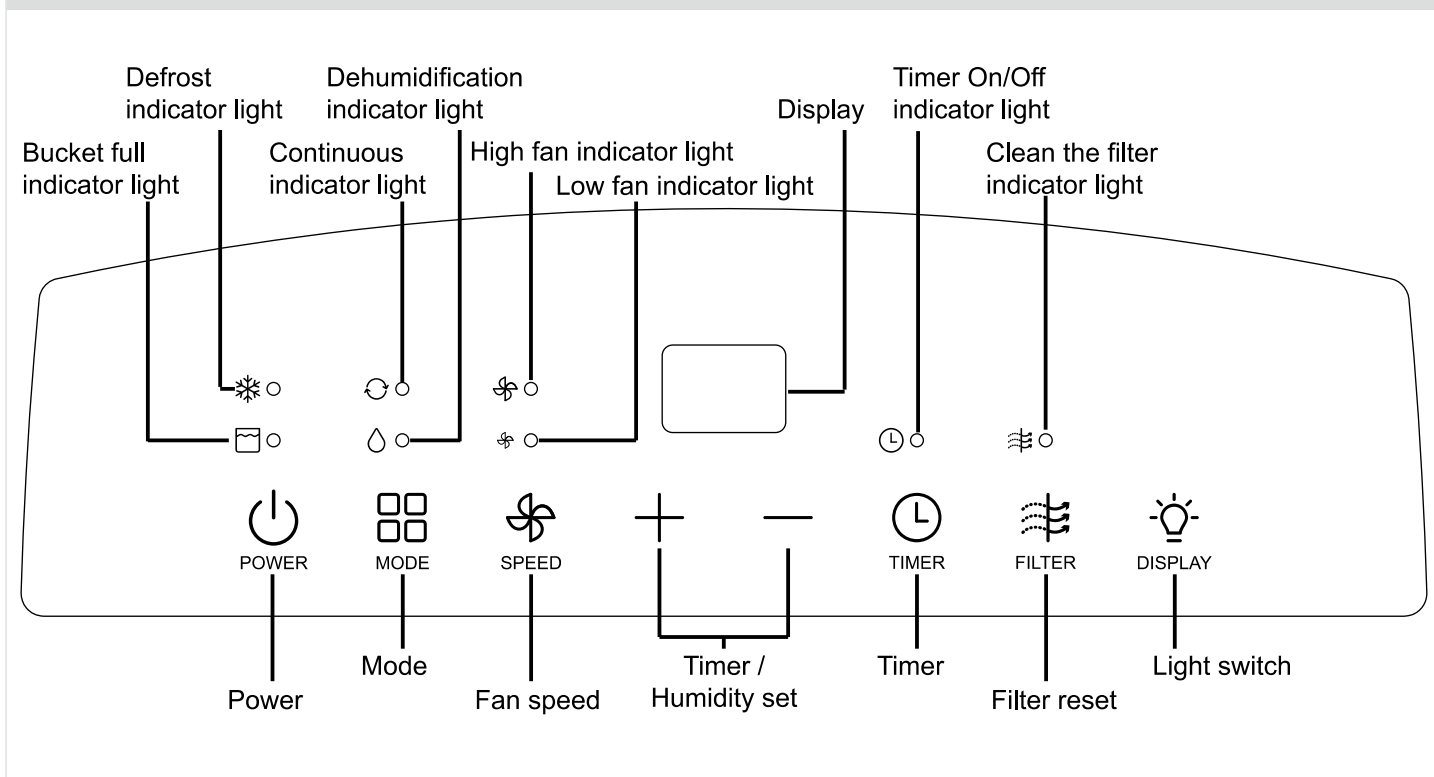

FUNCTION EXPLANATION

DISPLAY

Displays the current room humidity as a percent, or the hours remaining in a Time Delay. The corresponding indicator light will illuminate.

POWER BUTTON

Press the Power button to turn On/Off the dehumidifier.
NOTE: Turning off power by pressing the Power button does NOT disconnect the appliance from the power supply.

MODE CONTROL BUTTON

The Mode Control has 2 settings:

- Dehumidification
- Continuuou: Humidity cannot be set in this function.

The settings are adjusted with Mode Control button. A light will indicate which setting is currently being used.

FAN SPEED BUTTON

The Fan Speed Control has 2 settings: High and Low. Press the Fan Speed button to toggle among the two speeds. The corresponding fan speed indicator will illuminate.

TIMER

Program a time from (1 - 24 hours) for the dehumidifier to turn Off or On. When a Time Delay is programmed, the Timer indicator light will illuminate.

- Auto turn off :
With machine in running mode, press timer button for or setting timer control. Press " + " or " - " to select number of hours you would like the unit to function before it automatically shuts off.
Note: After a few seconds, the display will return to the current humidity
- Auto turn on :
With machine in stand by mode, press timer button for setting timer control. Press " + " or " - " to select number of hours before the unit automatically starts running.
Note: After a few seconds, the display will show the remaining hours of power-on, and other indicators will turn off.

HUMIDITY/TIMER SET BUTTONS (+ and -)

Adjusts the Humidity or Hours in Time Delay.

To Set the Humidity Level:

The humidity can be set between 30% RH and 90% RH. The humidity can be adjusted in increments / decrease of 5% by each press of a button.

Press the + / - buttons to select the desired Relative Humidity (RH).

NOTE: After setting the humidity level, the display will revert to the current humidity after a few seconds have passed.

FILTER RESET BUTTON

After 250 hours of operation, the indicator light will glow to remind you to clean the filter. Remove the filter and clean it. Press Filter reset button to turn off the light and Reset the filter alarm. See "AIR FILTER CLEANING STEPS".

LIGHT SWITCH BUTTON

Press this button to turn the top panel lights on and off.

BUCKET FULL

When the water collection bucket is full the indicator illuminates to remind you to empty the bucket.

DEFROST

When the room temperature is low, the dehumidifier enters defrost mode and the indicator illuminates.



NOTE

When operating the dehumidifier for extended periods (greater than 12 hours continuously) the dehumidifier will operate for 12 hours on then 1 hour off in order to reset the system. During the off period, "SA" will show in the display window for 3 seconds when pressing the button, and then resume to the settings. The unit will restart automatically after the hour is complete.

OPERATING INSTRUCTIONS

START OPERATION

1. Insert the plug into a suitable wall socket. The dehumidifier is suitable for operation on an electricity supply having the same voltage as that shown on its rating label.

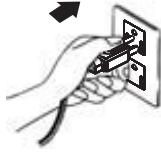

2. Before operation, make sure to remove the complimentary direct drainage hose from the front tank. Then, ensure that the water tank is properly inserted and flush with the unit. If the "Bucket Full" indicator illuminates, simply pull out the tank to ensure that the float lever is able to move freely, and then reinsert the water tank (the float switch is located on the right side of the tank).

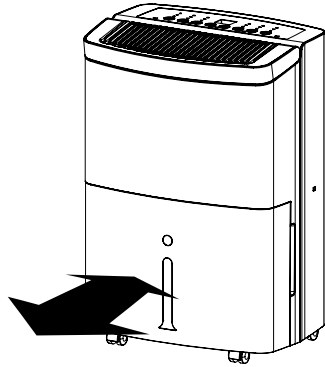

WHEN WATER TANK FULL LAMP IS ON

When the water tank is full the machine will stop and the "Water tank Full" light will illuminate. The water tank should be carefully removed from the machine by sliding it outwards from the front of the machine and it should be emptied. When the empty tank is replaced properly into the machine, the machine will start up and run normally.



Please use both hands to carefully empty the water tank.

DEFROST

When operating in low temperatures (less than 53.6°F (12°C)) the surface of the evaporator will accumulate frost and effect the efficiency of the dehumidifier. When this happens the machine will go into periodic defrost mode automatically. This is quite normal. Defrost lamp will come on. The unit will operate in temperatures down to 41°F (5°C). Defrost time may vary. If the dehumidifier freezes up turn the unit off for a few hours and then restart. It is not recommended to use the dehumidifier in temperatures below 41°F (5°C).

CONTINUOUS DRAINAGE

- The function of continuous drainage can be started in following steps:

1. Prepare hose to drain out water.

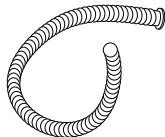

2. Take out drain cover from the drainage outlet.
3. Remove the soft rubber stopper inside the drain cover, put it into the bucket for storage.

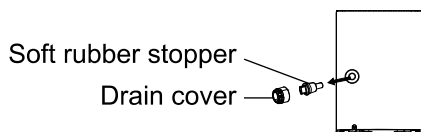

4. Make the hose go through the drain cover.

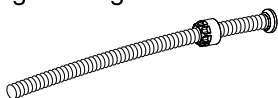

5. Connect the hose to the drain port.

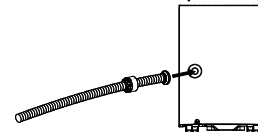

6. Screw the drain cover back to the drainage outlet.

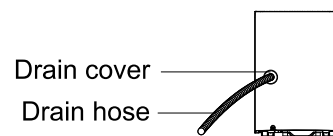

7. Place the bucket on its original location.

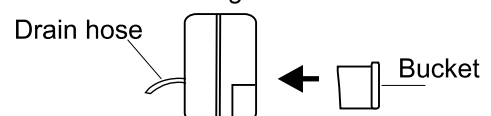

CONTINUOUS DRAINAGE

- **The Proper Way To Place The Water Drainage Hose**

When using continuous drainage, the hose must be placed below the drainage hole. Avoid uneven surfaces and do not "kink" the hose.

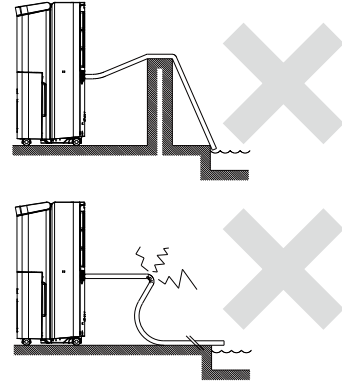
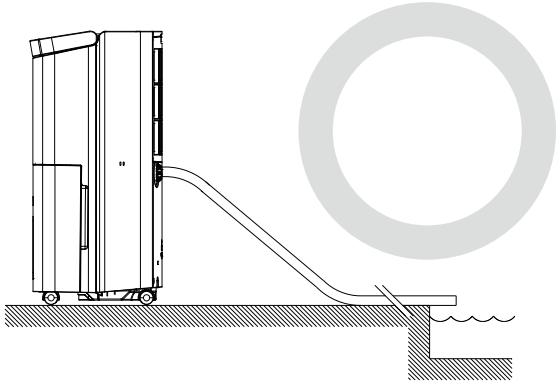

MAINTENANCE

Please make sure the dehumidifier is unplugged before servicing or cleaning the machine, for safety reasons!

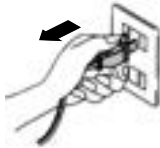

CLEAN THE SHELL

- Wipe the shell using soft and clean cloth.
- If the dehumidifier is very dirty, please use mild detergent then wipe off the detergent with half dried cloth.
- Do not wash the machine with a hose, for risk of electrical hazard.

CLEAN THE AIR FILTER

The purpose of the air filter is to filter the dust and other particles in the air and to protect the inner components of your dehumidifier. If the filter is blocked the usage of the electricity will be greater than normal and there is a risk of overheating. To ensure proper functioning of the unit, clean the filter at a minimum every two weeks. Do not use in a dusty environment.

- **Cleaning Steps :**

- Pull out the filter gently.

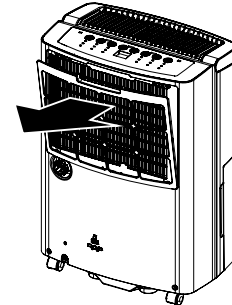

- Clean the filter by vacuum cleaner or washing with clean water then dry the filter using dry cloth.

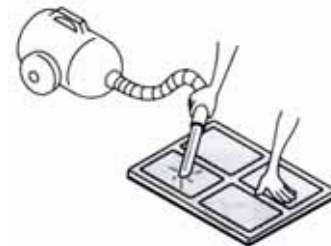

- Place the filter back to it's position.

FUNCTION EXPLANATION

Please unplug the machine when there is something wrong. Contact customer service 888-984-2766 immediately. Do not disassemble the dehumidifier yourself !

TROUBLESHOOTING GUIDE

The following cases may not always be a malfunction, please check this guide before asking for service.

Problem	Possible causes	Solution
• Dehumidifier doesn't work	• Electricity shutdown or low voltage	• Connect the appliance to the correct supply source
	• Bad plug or a wire is broken	• Contact customer service to repair or replace*
• Fan doesn't work	• Motor is broken	• Contact customer service to repair or replace*
• Compressor doesn't work	• Low voltage	• Connect the appliance to the correct supply source
	• Still under the 3 min. compressor reset protection	• Wait until it goes back to function after 3 min.
	• Compressor is broken	• Contact customer service to repair or replace*
• Can not dehumidify or the dehumidification volume is too low	• Filter is dirty	• Clean filter
	• Refrigerant is leaking	• Detect the leakage and fill with refrigerant.*
	• Low temp. and humidity	• Normal
• Loud noise and vibration	• Uneven floor	• Place the appliance on a flat, stable, heat-resistant surface.
	• Motor or compressor is loose	• Tighten screws
	• Sound of flowing water	• Normal, it is the sound when the refrigerant is flowing
• Evaporator is frosted	• Filter is too dirty	• Clean filter
	• environment temp. is too low	• Stop use temporarily
• Dehumidification water overflows	• Drain bucket could be broken broken	• Contact customer service to repair or replace*
	• Micro switch could be broken broken	• Contact customer service to repair or replace*
• The water tank full lamp on	• The water tank is full	• Pour the water and reposition the water tank correctly
	• The water tank is not correctly installed	• Reposition the water tank correctly
• LED display "E1"	• The temperature sensor is open or short circuit.	• Contact customer service to repair or replace*
• LED display "E2"	• The tube sensor is open or short circuit.	• Contact customer service to repair or replace*

***Caution: Do not attempt to repair, disassemble or modify the appliance. There are no user-serviceable parts inside. We suggest you to contact your service agent or a professional electrician for any help.**

WARRANTY

LIMITED CARRY IN APPLIANCE WARRANTY

This product is warranted to be free from manufacturer's defects in material and workmanship, provided that the unit is used under the normal operating conditions intended by the manufacturer.

This warranty is available only to the person to whom the unit was originally sold by manufacturer or by an authorized distributor of manufacturer, and is non-transferable.

TERMS OF WARRANTY

Plastic parts, are warranted for thirty (30) days only from purchase date, with no extensions provided.

FIRST 24 Months:

During the first twenty-four (24) months, any functional parts of this product found to be defective, will be repaired or replaced, at warrantor's option, at no charge to the ORIGINAL purchaser. Please keep your purchase receipt as a warranty proof of purchase date.

To obtain service, see contact information below:

Tel: 888-984-2766

Email: contactus@aerichome.com

or RETURN TO THE STORE WHERE PURCHASED FOR REPLACEMENT.

EXCLUSIONS

Save as herein provided by manufacturer, there are no other warranties, conditions, representations or guarantees, express or implied, made or intended by manufacturer or its authorized distributors and all other warranties, conditions, representations or guarantees, including any warranties, conditions, representations or guarantees under any Sale of Goods Act or like legislation or statute is hereby expressly excluded. Save as herein provided, manufacturer shall not be responsible for any damages to persons or property, including the unit itself, howsoever caused or any consequential damages arising from the malfunction of the unit and by the purchase of the unit, the purchaser does hereby agree to indemnify and hold harmless manufacturer from any claim for damages to persons or property caused by the unit.

As some states do not allow the limitation or exclusion of incidental or consequential damages, or do not allow limitation on implied warranties, the above limitations and exclusions may not apply to you. This warranty gives you specific legal rights, and you may also have other rights that vary from state to state.

GENERAL PROVISIONS

No warranty or insurance herein contained or set out shall apply when damage or repair is caused by any of the following:

- 1) Power failure.
- 2) Damage in transit or when moving the appliance.
- 3) Improper power supply such as low voltage, defective house wiring or inadequate fuses.
- 4) Accident, alteration, abuse or misuse of the appliance such as inadequate air circulation in the room or abnormal operating conditions (extremely high or low room temperature).
- 5) Use for commercial or industrial purposes (ie. If the appliance is not installed in a domestic residence).
- 6) Fire, water damage, theft, war, riot, hostility, acts of God such as hurricanes, floods, etc.
- 7) Service calls resulting in customer education.

AERIC LLC
Ramsey New Jersey 07446
USA