

Smart Wall Socket User Guide

Notes Before Installation

1. Wi-Fi Only support a 2.4GHz network (802.11 b/g/n)
2. Neutral wire Required.
3. Basic electrical wiring knowledge or experience required, or please consult a professional electrician.
4. Do not access more than the maximum power of the device design
5. ON/OFF Button also can be used as reset button, long press to reset your smart socket to factory defaults. Only do this if you are sure you want to erase all your settings

Specifications

Type	Smart Wall Socket
Model	KS-6045
Power supply mode	Neutral+Live Wire
Rated Current	15A(Max)
Rated Voltage	AC110-125V-50/60Hz
Load Power	Single 1500W Total 2500W Inductive Load<2000W
USB Output	5V/2.1A
Wireless Frequency	2.4GHz
Wireless Standard	IEEE802.11 b/g/n

Indicator	Status	Description
Green	Rapidly blink	Ready for connection (Default Mode ON)
Green	Slowly blink (Times over 3S)	Ready for connection (AP Mode ON)
Red/White	OFF	Turn the light off
Red/White	ON	Turn the light on
Green	Flash Slowly	No Internet

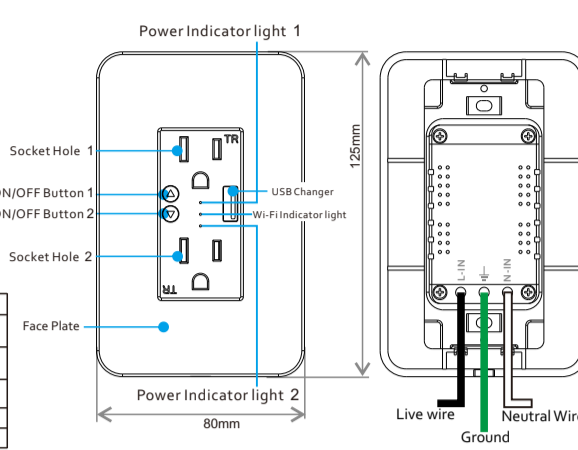

Safety Notice:

- Cut off the power before installation
- Please use it only when it's installed with RCD or current leakage protector at home

Smart Home

Installation Guide

STEP 1

Turn off circuit breaker
Find your socket's control in your circuit breaker and turn it off, ensure the socket power off completely.

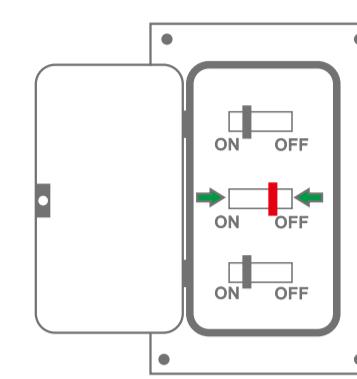

STEP 2

Remove the original socket
In the wall cassette, find the neutral wire line wire and ground wire.

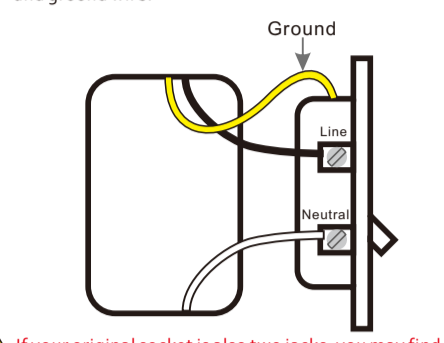

Warning: If your original socket is also two jacks, you may find 4 or 5 wires. Please find the neutral wires Line wires and ground wires. This smart socket only needs to use the neutral wires Line wires and ground wires, other lines do not need to be connected

STEP 3

Label your wires
Mark or record the corresponding line before removing the old socket

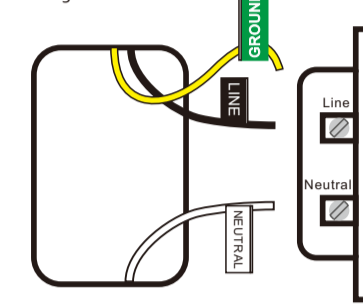

Usually:
White represents the neutral line
Black represents the fire line
Green or yellow or a single bare copper wire representing the ground wire
The above is for reference only and cannot be used as a standard.

STEP 4

Install socket
Use wire-nuts to connect the socket wires to your home wires, following the diagram. Be careful to match line. Then remove the stickers, screw the socket into the wall. And attach the faceplate.

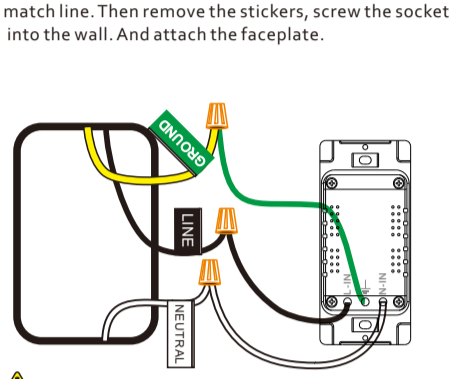

Warning: For safety, please connect the ground wire

STEP 5

Turn on circuit breaker
Turn on your socket's power from the circuit breaker. Press the socket a few times to make sure it works.

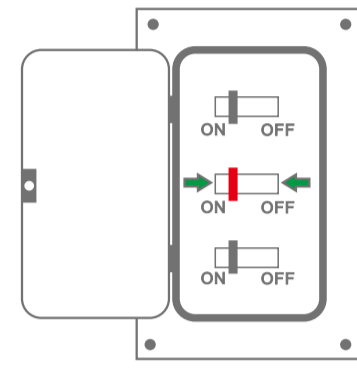

STEP 6

Check the Wi-Fi light
Tap NEXT when the Wi-Fi indicator light blinks

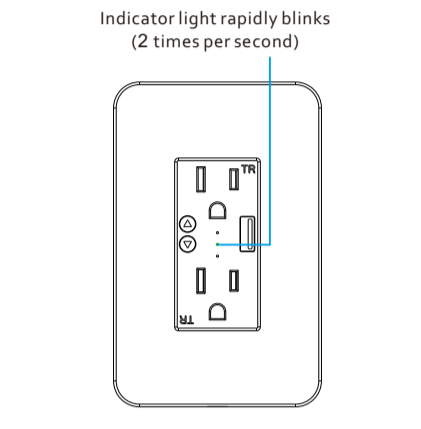

Install the "Smart Life" APP

Step A: Find out "Smart Life" app in Apple app store, Google Play, or scan the QR code below and install it.



The free app "Smart Life" is compatible with mobile devices that support iOS 8.0 above, Android 4.4 above

Step B: Enter the register interface, input the email address/phone number for getting the verification code to register an account. Please just login if you already have a Smart Life account.

Step C: Add the switch to Smart Life APP
Note: This smart socket can only support 2.4G network and cannot work with 5.0G network. please check if your home network is 2.4G and make sure that your phone has been connected to your Wi-Fi home network

(1) Tap "+" button on top right corner to add device, the tap "Electrical Outlet" to enter next page.

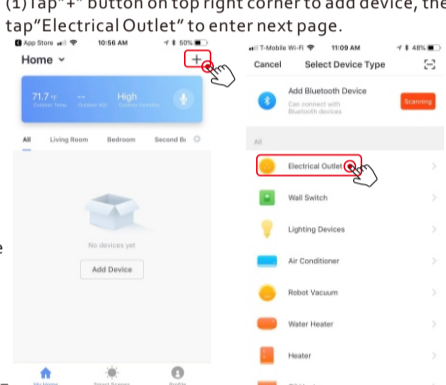

Default Mode(Recommend)

Indicator light rapidly blinks (2 times per second)

Step 1. Make sure the indicator blinks rapidly, if not, hold the anyone ON/OFF button for 7 seconds for reset.

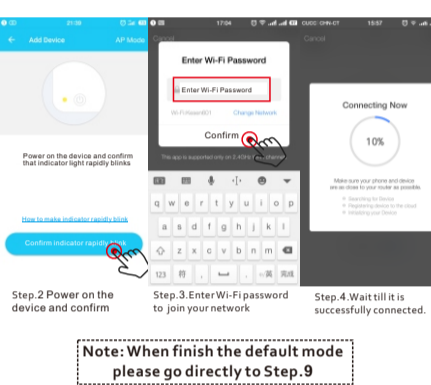

AP Mode(Alternative)

Indicator light slowly blinks (1 time every 3 seconds)

Step 1. When the indicator blinks rapidly, press and hold the anyone ON/OFF button for another 7 seconds, the indicator will blink slowly.

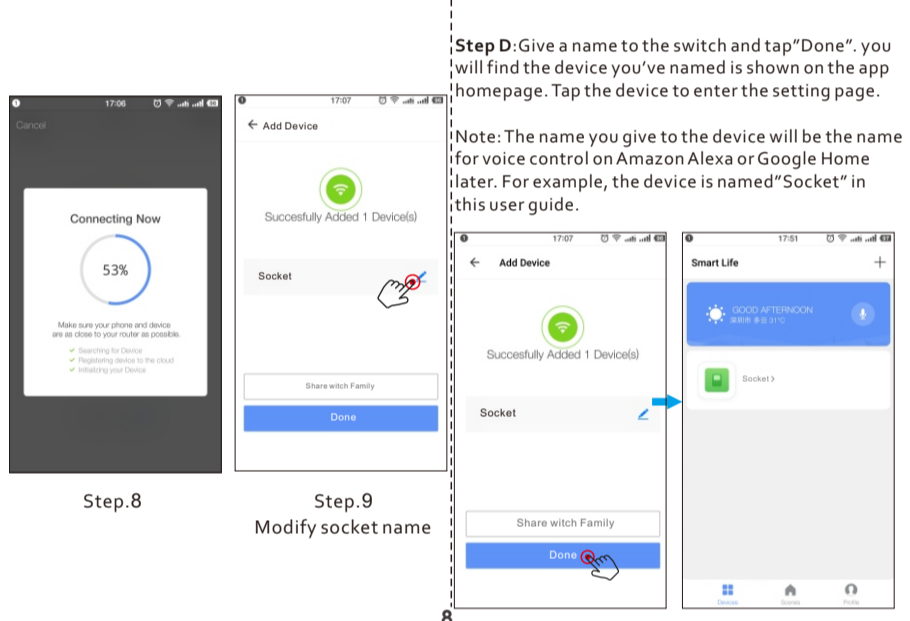
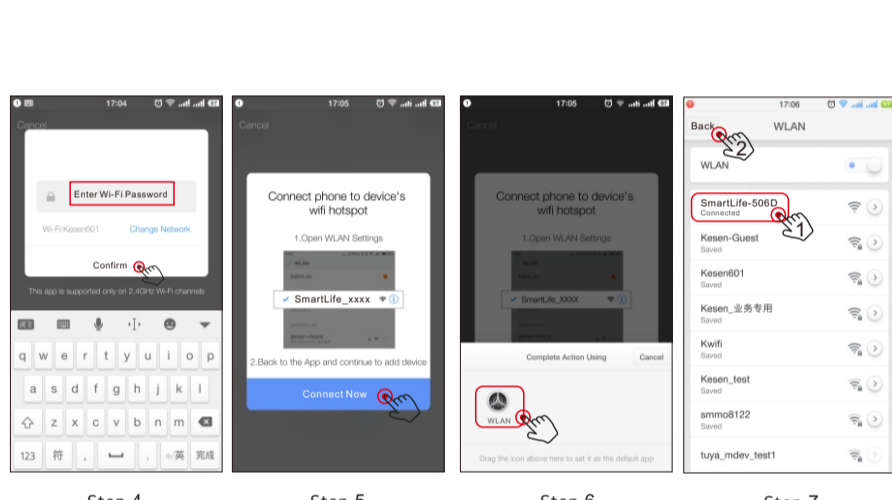
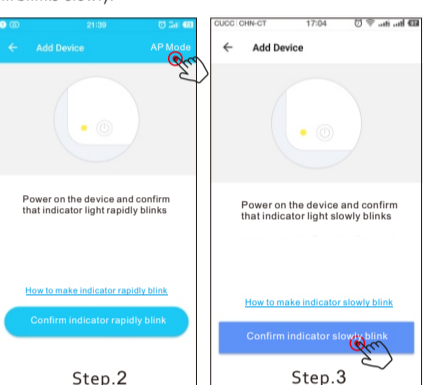

After completing Part Two, you can control the socket with Smart Life APP on this setting page now.

note:
Two socket holes can be controlled separately, long press "Socket1 or Socket2 font" to rename

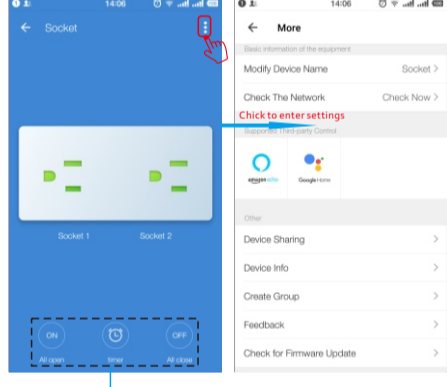

Try timer function to easily set up schedule to turn on/off smart socket.

Note:
Two socket holes can be individually timed

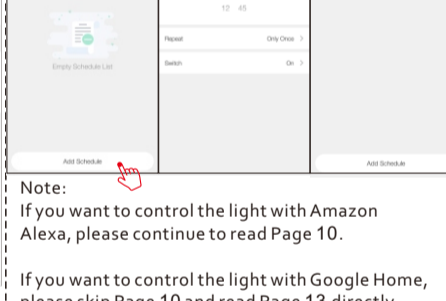

Try on/off and timer functions on the app to control the socket.

How to control the switch with Amazon Alexa?

Please make sure that your Alexa APP is connected to Amazon Echo, and both work together successfully under your Wi-Fi home network.

Step .A: Log in your Alexa APP, tap top left corner, and tap "Skills".

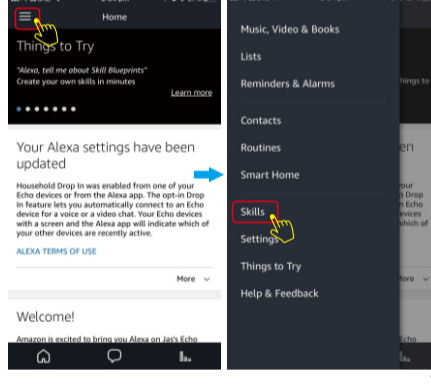

Step .B: Type "Smart Life", find "Smart Life" form the search result and tap to enable the skill.

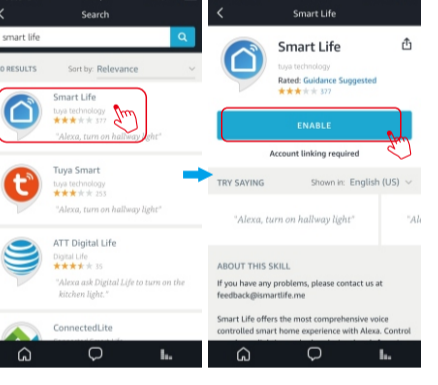

Step .C: Enter your account and password of "Smart Life" app, tap "Link now", then tap "Authorize" on the next page to bind Smart Life account to Alexa

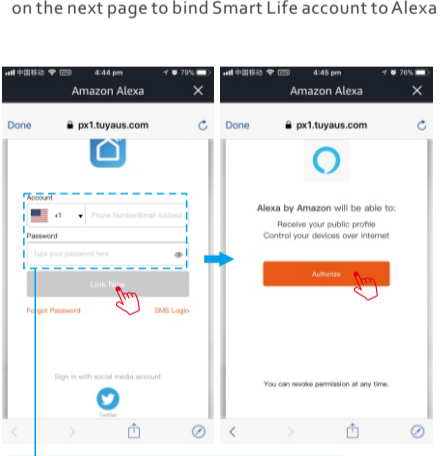

Step .D: Once your Smart Life account is successfully bound to Alexa, the following page will pop up. Tap "Done" on top left corner, the tap "DISCOVER DEVICES" on the next page.

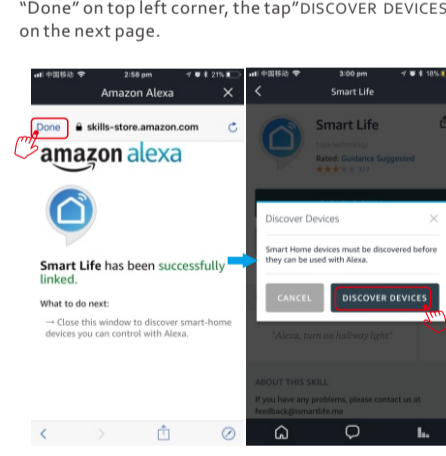

Step .E: Wait a few seconds for Alexa to detect the switch from Smart Life app, and you will find the device named "Socket" has been paired to Alexa APP from "Smart Life" APP.

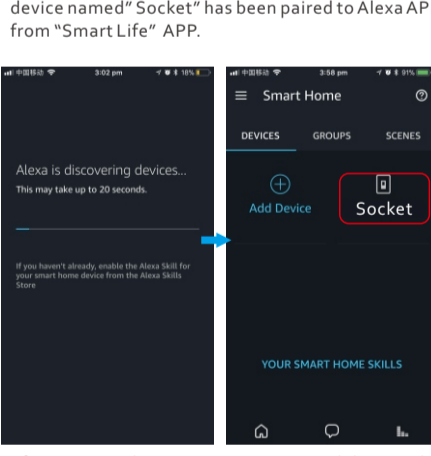

Step .F: Now you are able to control the socket via Amazon Alexa.



How to control the switch with Google Home?

- Have downloaded the Google Home app
- Have registered your Google Account (only support US account)
- Have paired Smart Socket with Smart Life App and named with simply and easily recognizable name.
- Have finished setting up Google Home

Step .A: Open your Google Home APP, tap "Home Control" on the left side bar page.

Step .B: Tap "+" button on the button right to enter next page.



Step .D: Enter your account and password of "Smart Life" app, tap "Link now", then tap "Authorize" on the next page to bind Smart Life account to Google Home.

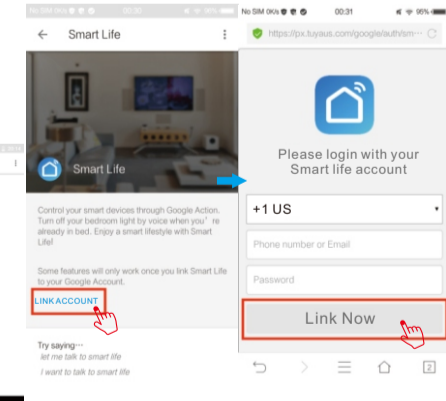

Step .E: You will find that Google Home has found the device named "Socket" on this page.

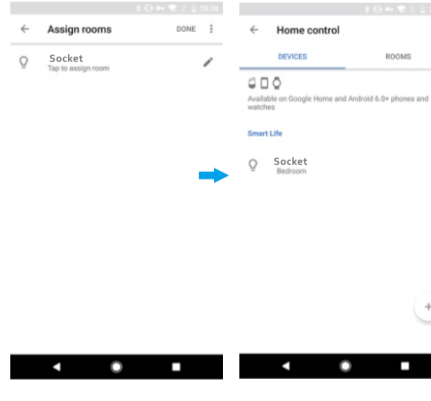

Step .F: Now you are able to control the socket via Google Home.



How to control the switch with IFTTT?

Step .A: Visit the IFTTT official website on your PC and sign in with your IFTTT account.

Step .B: Search for "Smart Life", and then click "Smart Life" service.

Step .C: Click "Connect", then login your Smart Life ID and then tap "Link Now".

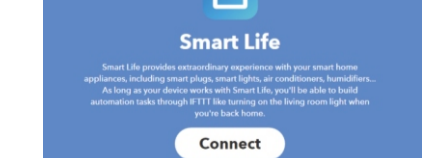

Instructions: 2 methods to use IFTTT with the product.

Method 1: On Smart Life service page, choose an existing Applet you need, turn on it and then finish the configuration.

Method 2: Create a new Applet on your own. Click My Applets at the top and then click "New Applet" at the right top corner of the webpage to create a new Applet.

Step .A: Create a Trigger. Tap "this" to choose a Trigger. You can search for "Weather Underground" to choose a Trigger.

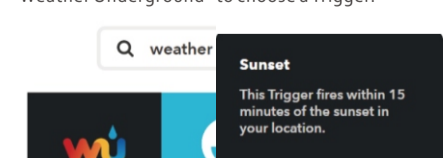

Step .D: Successfully connect your IFTTT account to your Smart Life ID. You are ready to enjoy the IFTTT service of the product now.

We select "Sunset" as the Trigger.

Step .B: Create an Action. Tap "this" to choose a Trigger. You can search for "Smart Life" to choose a Smart Life Action.

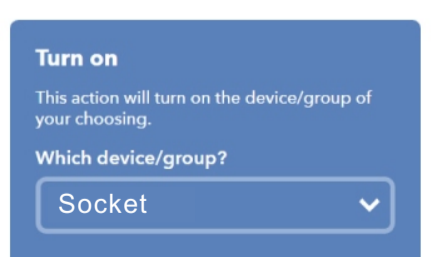

FAQ

Please note when adding device:

1. Confirm device is powered on.
2. Confirm device is waiting for network configuration.
3. Confirm that device, smart phone and router are as close to each other.
4. Make sure the network function of router and smart phone are unlocked.
5. Confirm the entered router password is correct.
6. Confirm adding device is under 2.4G Wi-Fi channel. Enable the broadcast and not allow to hide Wi-Fi.
7. Confirm that router's encryption method is WPA2-PSK and authentication type is AES, or both are set up as automatic.
8. Confirm that Wi-Fi name contains letters. It is created as a result.
9. If router's connected device reach the amount limit. Please try to turn off some devices Wi-Fi function and configure again.

10. If router enables MAC address filter, please try removing the device form MAC filter list and make sure router is allowing device to be connected.

11. Device and smart phone must be in the same Wi-Fi environment when adding device. After successful adding, device can be control via mobile network.

12. How to share my device with family?
Open App, enter into "shared device", tap "add sharing" to share device with family.

13. How to add device?
Two methods to add device: "Default Mode" and "AP Mode". "Default Mode" is set up as default and can switch to "AP Mode"

14. Why can't I control the load after installing the product?
1. Please check if the wiring is correct.
2. Please check if there is a neutral line in the cassette (neutral line is required)
3. Please check if the connected load exceeds the maximum value of the device.

FCC NOTE 1: This device complies with Part 15 of the FCC Rules. Operation is subject to the following two conditions:
(1) this device may not cause harmful interference,
(2) this device must accept any interference received, including interference that may cause undesired operation. The manufacturer is not responsible for any radio or tv interference caused by unauthorized modifications or change to this equipment. Such modifications or change could void the user's authority to operate the equipment. This equipment has been tested and found to comply with the limits for a Class B digital device, pursuant to part 15 of the FCC Rules. These limits are designed to provide reasonable protection against harmful interference in a residential installation. This equipment generates, uses and can radiate radio frequency energy and, if not installed and used in accordance with the instructions, may cause harmful interference to radio communications. However, there is no guarantee that interference will not occur in a particular installation. If this equipment does cause harmful interference to radio or television reception, which can be determined by turning the equipment off and on, the user is encouraged to try to correct the interference by one or more of the following measures:

- Reorient or relocate the receiving antenna.
- Increase the separation between the equipment and receiver.
- Connect the equipment into an outlet on a circuit different from that to which the receiver is connected.
- Consult the dealer or an experienced radio/TV technician for help.

RF warning statement: To maintain compliance with FCC's RF exposure guidelines, this equipment should be installed and operated with a minimum distance of 50cm between the radiator and your body.

17