



INSTRUCTION MANUAL

CabKing-8V1



IMPORTANT SAFETY INSTRUCTIONS



READ ALL INSTRUCTIONS FIRST



For your own safety, be sure to read, understand and follow all warnings, safety rules and instructions in this instruction manual and on the machine before use. Failure to do so can result in serious personal injury.

 **WARNING:** This machine includes products that can expose you to chemicals including nickel, which is known to the State of California to cause cancer. For more information, go to www.P65Warnings.ca.gov.

This warning applies to the 80# and 220# diamond wheels, and the 360# full face diamond lap.

SETUP SAFETY

- ⇒ **KNOW YOUR POWER TOOL.** Read this instruction manual carefully. Learn the applications, limitations, specific warnings, and hazards related to this machine.
- ⇒ **KEEP GUARDS IN PLACE AND SECURED.** Never operate this machine without hoods. Make sure all guards are operating and properly secured before each use.
- ⇒ **INTENDED FOR INDOOR USE ONLY.**
- ⇒ **AVOID DANGEROUS ENVIRONMENTS.** Do not use this machine near gasoline or other flammable liquids.
- ⇒ **MAKE SURE MACHINE IS SECURELY MOUNTED.** Abide by the proper mounting instructions before connecting the tool into a power supply.
- ⇒ **USE ONLY RECOMMENDED ACCESSORIES.** The use of improper accessories on this machine may cause risk of injury.
- ⇒ **CHECK FOR DAMAGED PARTS.** Before use of this machine, always check for any damaged guards or parts to determine that it will operate properly and perform its intended function. Check for proper alignment of moving parts, binding of moving parts, breakage of parts, mounting and any other conditions that may affect its operation. A guard or other part that is damaged must be properly replaced through the manufacturer of this machine to avoid risk of injury.

- ⇒ **USE ONLY IDENTICAL CABKING PARTS FOR REPLACEMENT PARTS.** Use of any other parts may create a hazard or cause product damage.

ELECTRICAL SAFETY

- ⇒ **USE ONLY GROUNDED OUTLET OR GFCI OUTLET.** All electrical cords must either be securely grounded, connected to a surge protected outlet, or preferably, connected to a GFCI (Ground Fault Circuit Interrupter) outlet. A GFCI is highly recommended to prevent electric shock. Do NOT use an extension cord.
- ⇒ **DON'T ABUSE THE CORD.** Never carry the machine by the cord or yank it to disconnect from receptacle. Keep cord away from heat, oil and sharp edges.

USAGE SAFETY

- ⇒ **NEVER DISCONNECT MOTOR, LAMP OR PUMP WITH WET HANDS.** Though the motor is sealed, you must make sure to keep all electrical connections dry. Avoid touching the pump when connected to the power.
- ⇒ **ALWAYS WEAR PROPER EYE PROTECTION.** Enclosed are safety goggles to protect you from any debris that may fly out while grinding. We recommend wearing the enclosed goggles or safety glasses with side shields. Everyday eyeglasses are NOT safety glasses. If anyone is around the machine while it is in use, they must wear safety glasses.
- ⇒ **WEAR PROPER APPAREL.** Do not wear any loose clothing, gloves, neckties or jewelry that can get caught in the machine's moving parts. Long hair must be secured with a rubber band or hair tie.
- ⇒ **KEEP WORK AREA WELL LIT, CLEAN, AND UNCLUTTERED.**
- ⇒ **ADULT SUPERVISION IS REQUIRED AT ALL TIMES.** Never leave the machine running unattended.
- ⇒ **DO NOT TOUCH MOTOR HOUSING.** Avoid contact with the motor housing when in use. The motor is totally enclosed and non-ventilated so it produces high temperatures. The running temperature can reach around 220°F.
- ⇒ **DO NOT OPERATE THIS MACHINE WHILE UNDER THE INFLUENCE OF DRUGS, ALCOHOL OR ANY MEDICATION.**

- ⇒ **NEVER RUN WHEELS DRY.** Make sure there is adequate water used while grinding so that rock dust is not formed. This dust may contain chemicals that can be hazardous to your lungs if inhaled and is known to cause cancer, birth defects or other reproductive harm. To reduce your exposure to these chemicals, work in a well ventilated area and wear a face or dust mask if the grinding operation is dusty.
- ⇒ **USE ONLY WATER AS COOLANT.**
- ⇒ **SOME ROCKS CONTAIN POISONOUS ELEMENTS.** Avoid grinding rocks that contain uranium, mercury, lead, arsenic, etc. Be certain you know the material you are grinding.
- ⇒ **DO NOT FORCE THE TOOL** or attachment to do a job it is not designed to do.
- ⇒ **DIRECTION OF FEED.** Be aware of the wheel rotation direction. **ALWAYS EASE THE WORKPIECE AGAINST THE RESIN WHEELS.** A harsh impact can break the wheel. Use light pressure when starting to grind. Too much pressure can cause the wheel to crack.
- ⇒ **NEVER GRIND MORE THAN ONE WORKPIECE AT A TIME.**
- ⇒ **NEVER START THE MACHINE IF A WHEEL IS IN CONTACT WITH A WORKPIECE.**
- ⇒ **WHEELS CONTINUE TO SPIN AFTER TURN OFF** eventually slowing to a stop.
- ⇒ **AVOID AWKWARD OPERATIONS AND HAND POSITIONS.** Make sure you have good balance while working on this machine. A sudden slip could cause your hand to move into the wheel.
- ⇒ **ALWAYS STAY ALERT.** You must be focused while working on this machine. It is possible for stones to catch on the wheels and be ejected out of the grinding area.

MAINTENANCE SAFETY

- ⇒ **ALWAYS DISCONNECT POWER BEFORE SERVICING.** Disconnect machine, lamp and water pump from power before making adjustments and when not in use.
- ⇒ **DO NOT OPEN MOTOR.** No user serviceable parts inside.
- ⇒ **CLEAN AND DRY MACHINE AFTER USE.**

SAVE THESE INSTRUCTIONS

TABLE OF CONTENTS

SAFETY INSTRUCTIONS.....	2
PARTS LIST.....	6
ASSEMBLY INSTRUCTIONS.....	7
SETTING UP THE WATER SYSTEM.....	9
FINAL ASSEMBLY.....	10
MAINTENANCE.....	11
MACHINE USAGE.....	12
THE ART OF CABBING.....	14
WATER SYSTEM PARTS.....	15
OPTIONAL ACCESSORIES.....	16
TROUBLESHOOTING.....	18
WARRANTY INFO.....	19

PARTS LIST



1



2



3



4



5



6



7



8



9



10



11



12



13



14



15

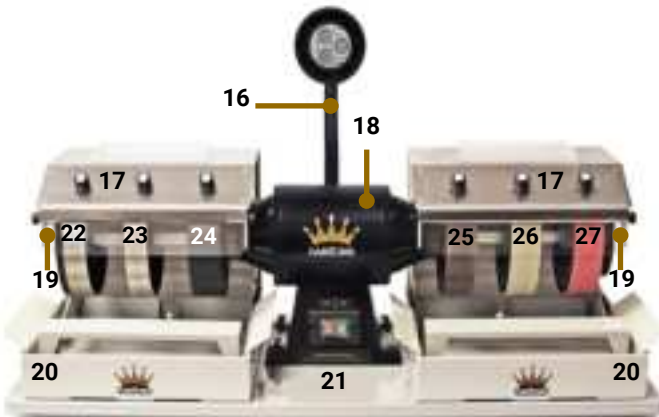

PART #	DESCRIPTION	QTY
1	INSTRUCTION MANUAL <i>PLEASE READ ENTIRE MANUAL</i>	1
2	APRON	1
3	GOGGLES	1
4	SHAFT WRENCH	1
5	PAN SPLASH GUARD	4
6	HAND REST	2
7	STONE TRAY	2
8	DRIP PAN TUBING	2
9	INNER SIDE PANEL	2
10	OUTER SIDE PANEL	2
11	WATER PUMP	1
12	WATER PUMP FOOTSWITCH	1
13	CANVAS POLISH PAD	1
14	DIAMOND PASTE	1
15	8" DIAMOND LAP - 360#	1
16	LAMP	1
17	HOOD	2
18	MOTOR	1
19	WHEEL SPLASH GUARD	2
20	DRIP PAN	2
21	BASEBOARD	1
22	80# GRINDING WHEEL	1
23	220# GRINDING WHEEL	1
24	280# RESIN WHEEL	1
25	600# RESIN WHEEL	1
26	1200# RESIN WHEEL	1
27	3000# RESIN WHEEL	1

ASSEMBLY INSTRUCTIONS

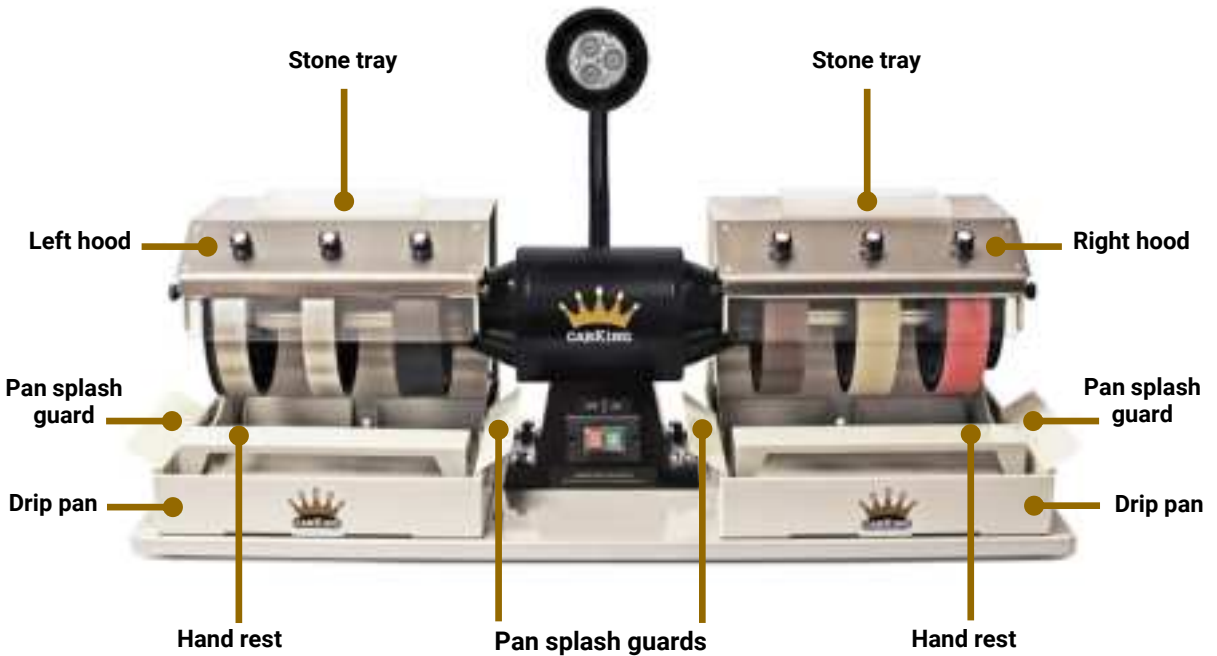

FIG. A

1. Refer to FIG. A above for assembly instructions. Determine a suitable, well lit location for your CabKing-8V1. You will need a sturdy table or workbench that has 4 feet width X 2 feet depth of clear space. The CabKing-8V1 is a heavy machine that weighs approximately 150lbs once assembled. We highly suggest assembling this machine with two people.
2. There are three boxes that contain components of your machine; the motor box, the baseboard, hood, pan, light, and accessory box, and the box that contains the wheels. Do not throw away any packaging until you are completely set-up.
3. Open the box that contains the baseboard and accessories. Remove all loose foam and accessories. Check to make sure all parts are present both on the machine and in the accessory box according to the parts listed on the opposite page. If you find any missing or damaged parts, call us immediately at (630) 366-6129 or email us at info@cabking.com.
4. Place the baseboard on your predetermined location. Make sure the board lays flat on the surface. Leave a few inches of clearance behind the machine to allow for power cords and water tubes.

5. Remove the top nuts and washers located on the four bolts sticking through the baseboard (FIG. B). Keep these aside, you will need them for the motor. Remove the plastic protectant from the baseboard.



FIG. B

6. Install the lamp onto the baseboard. To do this, open the lamp box and take out the lamp, rubber seal and three Phillips screws. Using the pre-drilled holes in the baseboard as a template, secure the lamp with the three Phillips screws, making sure the rubber seal is between the baseboard and the lamp. The lamp's power cord needs to be facing away from the motor (FIG. C).

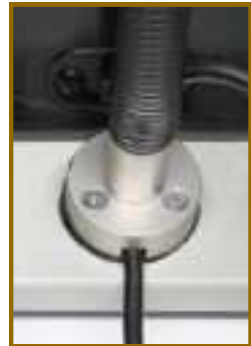
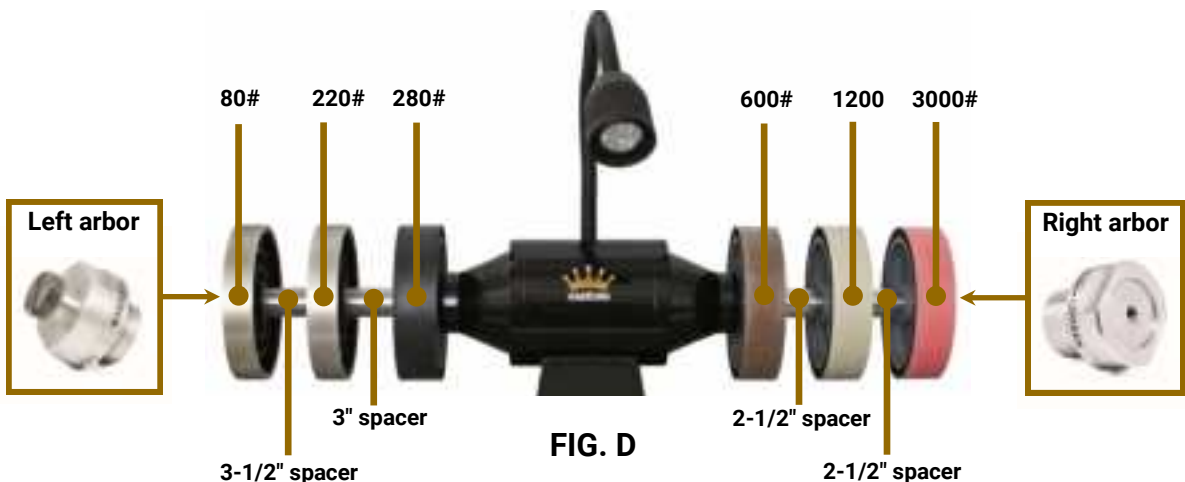

FIG. C

7. Remove the motor from its box by lifting the motor straight upwards by its black housing. Do not lift the motor by its shafts. The motor comes in its own crate for shipping purposes. There is an included wrench inside the crate. Use this to remove the nuts that secure the motor in the crate.

8. Once the motor is removed from the crate, place it onto the four bolts found on the baseboard. Make sure to align the motor so it is parallel to the board, then take the washer and nuts you placed aside earlier and tighten them onto the bolts using the same wrench used to take the motor off the board.

9. **Wheel installation** – Refer to FIG. D below for step 9. There are two arbors that are included with your CabKing. The left arbor is located at the end of the left motor shaft. The right arbor is located at the end of the right motor shaft. Unscrew and remove the left and right arbors from the motor shafts using the included shaft wrench. Remove the spacers that are included on the shafts. Install the wheels and spacers onto the shafts according to FIG. D below. Once the wheels and spacers are properly installed, replace and tighten the arbors onto the shafts using the shaft wrench.



10. Place the two drip pans on the baseboard. The drip pans are not fixed in place, allowing you to move them as needed. Insert the left and right stainless steel hoods into the grooves located inside the drip pans.
11. Place the clear stone trays on top of the hoods and insert the hand rests into the drip pans. Secure the pan splash guards onto both sides of the drip pans. Adjust the position of the pan splash guards according to the water splash.
12. Attach the stainless steel, inner side panels to the hoods. They magnetically attach for easy installation. Install one side panel on the left hood and the other on the right hood, closest to the motor (FIG. E).
13. Optionally, attach the outer side panels to the hoods. Like the inner side panels, they magnetically attach for easy installation. Install one side panel on the left hood and the other on the right hood, furthest from the motor (FIG. F). Simply move the black side spray tube upwards to attach and remove the side panels. These outer side panels help control the water splash, however not installing them provides easier access to the diamond lap and canvas pad.



FIG. E

FIG. F

SETTING UP THE WATER SYSTEM

The CabKing-8V1 water system is a single-pass system, meaning not re-circulating. **DO NOT SET-UP THE WATER SYSTEM AS A RE-CIRCULATING SYSTEM.** Read further about the CabKing water system on page 15 after set-up.

14. Slide the drip pan tubes into the drip pans. Secure the connection with the spring clip (FIG. G). Tug on the tubes slightly to make sure they are secured. Place the unconnected ends of the tubes in a large, 5 gallon empty bucket (not included), drain hole, or wherever you want the dirty water to drain out. You must have the drip pan tubes pointing downward to allow gravity to drain the water from the drip pans. If the tubes aren't angled downward, the drip pans will fill up with water.
15. **MAKE SURE WATER PUMP IS NOT CONNECTED TO POWER SUPPLY.** Connect the water intake system by pushing the two clear tubes installed in the hoods into the black T-junction, located on the end of the clear tube connected to the water pump (FIG. H). Remove the protective backing from the T-junction and place the sticky, adhesive side to the baseboard, behind the motor. Tug on these tubes slightly to make sure they are secured. Place the water pump in a separate, large 5 gallon bucket (not included) filled fully with clean water (FIG. I). The length from the bucket to the unit should not be more than 6 feet.



FIG. G



FIG. H



FIG. I

FINAL ASSEMBLY

16. Install the two clear wheel splash guards onto the hoods (FIG. J). Twist the water control knobs located on the left and right hoods to the off position according to the directions on the knobs (FIG. J). Twist the two side valves on the side spray tubes to the off position. When the black arrow on the side valves are pointed to the left, they are in the off position.
17. Connect both the motor and lamp power cords to a surge protected outlet, or preferably a GFCI (Ground Fault Circuit Interrupter) outlet. While not required, a GFCI is recommended to prevent electric shock and can be purchased at your local hardware store. Though the motor is sealed, you must make sure to keep all electrical connections dry.
18. Attach the water pump power cord to the footswitch cord. The footswitch turns the water pump on and off. Connect the footswitch cord to a surge protected power outlet. **ALWAYS UNPLUG FOOTSWITCH FROM POWER SOURCE WHEN NOT IN USE.** Avoid touching the water pump when power is on. **NEVER UNPLUG OR TOUCH POWER CORDS WITH WET HANDS.**
19. **MAKE SURE THE WHEELS ARE NOT IN CONTACT WITH ANY PARTS BEFORE TURNING ON THE MACHINE SO THAT THE WHEELS SPIN FREELY.** You can now turn on the machine. The wheels spin at 1800RPM. It is typical for the motor to produce a winding sound when starting up and a mild humming sound during use.
20. Start the water drip by pressing on the footswitch. Turn the six water control knobs to the on position. Our unique water system allows you to drip water on each wheel individually. You can adjust the water flow rate to your preference with the water control knobs. While in use, make sure there is enough water dripping so that the wheels do not become dry. **NEVER RUN WHEELS DRY.** To use the side spray for the canvas pad and diamond lap, turn to page 13.
21. You are now ready to use the CabKing-8V1. **READ THE REST OF THIS INSTRUCTION MANUAL, ESPECIALLY THE SAFETY INSTRUCTIONS, BEFORE USE TO AVOID RISK OF INJURY.**



FIG. J

MAINTENANCE

The CabKing-8V1 is designed as a maintenance-free unit. There are no belts, pulleys, gears, or parts to actively maintain, however all parts should be cleaned manually and periodically with soap and clean water. **DO NOT PUT ANY PARTS IN THE DISHWASHER.**

Changing the wheels – The wheels included with the CabKing-8V1 are 8" diameter with 1" arbor holes. The CabKing-8V1 only uses wheels with 1" arbor holes. Color of wheel hub may vary. Using the included shaft wrench, remove the arbors located at the end of the motor shaft, slide off the wheels and replace with new ones. We highly recommend lubricating the shaft with oil, lithium grease or WD-40 every time you change wheels. This helps prevent the shaft from rusting and ease in future wheel removal. Should you have difficulty removing the wheels, we suggest securing the arbor with the shaft wrench and manually spinning the wheel in the opposite direction. The opposing force should loosen the wheel. When removing the last wheel, sometimes the arbor can get stuck in the wheel hub. Simply spin the wheel towards you, which will remove both the wheel and arbor, then tap out the arbor using a cylindrical object.

LED light bulb – The light bulb installed in the lamp is LED and will last a long time. Should you need a replacement, you will need to purchase this LED light bulb directly through us at cabking.com. The LED light bulb installed in the CabKing lamp is specially designed for this machine and can't be found elsewhere. Written and visual instructions on how to change the LED light bulb will be provided with the replacement bulb.

LED bulb specifications: Voltage: 90-240V. Output current: 300Ma. Brightness: 200-300LM. Bulb style: G5.3 bi-pin base.



MACHINE USAGE

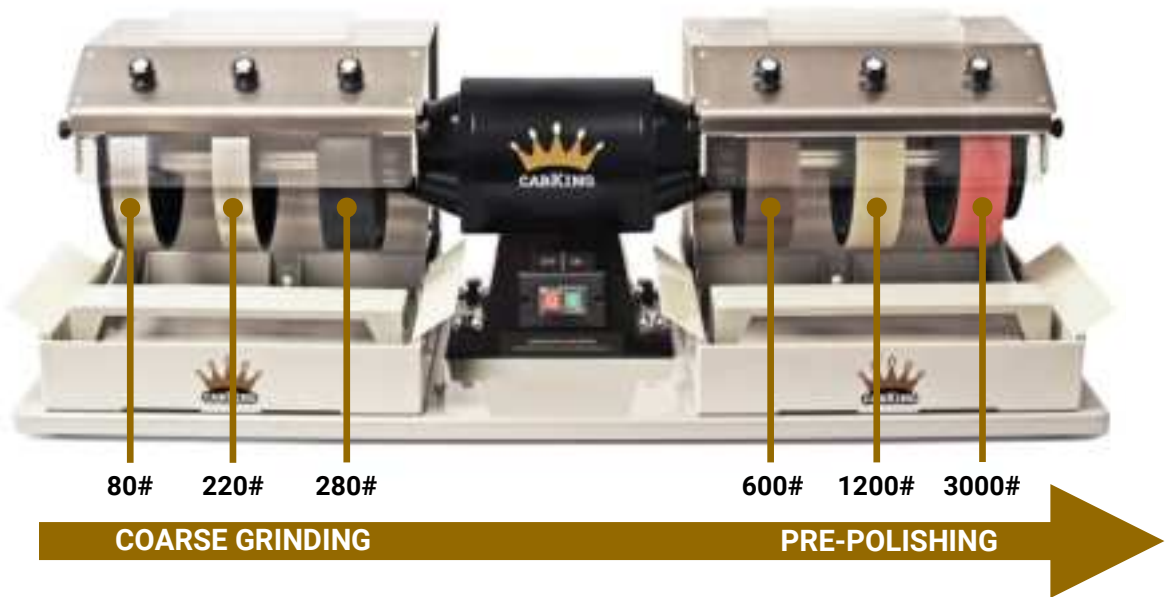

The CabKing-8V1 is configured with two electroplated diamond wheels, four resin diamond wheels, one diamond disc and one canvas polishing pad. The direct drive motor on the CabKing-8V1 eliminates belts and other exterior motor parts to maintain or replace. The water system is unique and allows you to independently control the water spray on the wheels. Always use adequate water while in use to avoid running the wheels dry. If the wheels become covered with stone residue, increase the water flow. We recommend wearing the included apron to keep you from getting wet while you work.

Another advantage to our water system is that you can adjust the spray direction on each wheel. This allows you to use wheels of different widths. Do this by locating the y-split, which is located under the hood. Adjust the two nozzles that are inserted into the y-split by twisting to the left or right (FIG. K).



FIG. K

The CabKing-8V1 grinds and polishes all kinds of shapes and design of rock, glass, synthetic material and metal. The most popular use is making cabochons. The general process of making a cabochon on the CabKing-8V1 is described on pages 13 and 14.

Grinding – Start with the electroplated diamond wheels on the left shaft to complete the grinding process. The grinding process shapes your cabochon and removes any surface irregularities so that the stone can be smoothed and polished. Hold your stone free hand or on a dop stick. Begin with the 80# electroplated diamond wheel. Completely grind the surface of the stone using adequate water. If the stone is not ground thoroughly, scratching will occur. Making sure that all scratches are removed is the most important part of grinding a cabochon. Frequently dry your cabochon with a paper towel or clean rag to reveal the remaining scratches while you work. Repeat this process for the 220# electroplated diamond wheel.

Pre-polishing – Once you are done grinding and shaping your cabochon on the electroplated diamond wheels, proceed to the resin wheel sequence. Resin wheels sand and smooth away flat spots, scratches and tiny bumps that are left behind from the grinding wheels in your stone, resulting in a pre-polished cabochon.

Important notes: The supplied CabKing resin wheels are formulated to be used exclusively together in sequence. To avoid scratching or uneven grinding/polishing, do not mix and match other brands of resin wheels with the CabKing resin wheels. **PLEASE READ THE RESIN WHEEL NOTICES DOCUMENT THAT IS INCLUDED WITH THIS INSTRUCTION MANUAL.**

Polishing – To put the final polish on your stone, attach the included canvas polishing pad by screwing it into the right arbor, while the machine is turned off. Using the included 14,000 mesh diamond paste syringe, apply a series of small dots, randomly throughout the pad, starting from the center of the pad, moving to the outer edge of the pad. Using your finger, smear the small dots into the canvas polishing pad. While diamond paste puts a bright, shiny polish on most stones, there are other ways to polish your stones such as using diamond powder or cerium oxide.

Now that the canvas polishing pad is charged with the diamond paste, it is ready for use. Most diamond pastes can be used without water however, you may use water while your polishing if you find that your work piece is overheating. This typically happens with softer material. To use with water, aim the black side spray tube to the center of the disc. Always aim the side spray tube to the center of the disc so that when the disc is spinning, the water will spread evenly throughout the whole surface. Adjust the water drip to your preference by moving the side spray tube to the left or right. Adjust the spray direction by moving the white nozzle that is inserted into the side spray tube to the left or right (FIG. L). **Important note:** Only use one mesh per canvas polishing pad. Do not mix different mesh on the same canvas polishing pad or scratching may occur.



FIG. L

If you plan to insert your polished cabochon into a jewelry finding, you will need to put a flat on the backside of your cabochon. Included with your machine is an 8" diamond lap to do this. The lap is diamond electroplated with 360# and pre-bound to an acrylic backing plate with 1/2" arbor hole. Install the lap by removing the slotted bolt from the left arbor with a screwdriver, turning clockwise. Place the lap onto the lip of the arbor, then secure the lap by replacing the slotted bolt, turning counter-clockwise. Make sure the slotted bolt is tight and secure. You may use other types of diamond laps, such as ones with metal backing plates. The diamond lap must be used with water. Just like the canvas polishing pad, aim the black side spray tube to the center of the disc and adjust the water drip to your preference by moving the side spray tube and white nozzle to the left or right (FIG. M).



FIG. M

Important note: The canvas polishing pad is to be used on the right shaft. The diamond lap is to be used on the left shaft.

THE ART OF CABBING

The art of cabbing involves experimentation, since every stone is different. As you progress, you may find that different grits are necessary depending on your stone and application. Searching the internet or joining local lapidary clubs will help you with your understanding and experience. As with all stone cutting and cab making, practice and experimentation are the keys to success.

**Transform
rocks ...**



into gems!



CABKING WATER SYSTEM PARTS

One of the key features to the CabKing-8V1 is the single pass, contamination-free water system. The water system will remain trouble-free as long as you use a fresh, clean supply of water. Do this by using a separate intake water bucket from the drainage bucket. A fresh supply of water will protect you from cross-contamination of grit which can occur in re-circulating systems that use a bubbler or geyser. With fresh water, the pump and intake tubes will stay clean and unobstructed so there will be enough water pressure. The water pump is rated at 30watts, 605GPH, 8.2ftHmax. We recommend using a minimum 5 gallon bucket for both the water pump and drainage. You will typically go through an average of 1-2 gallons of water per hour, with the water control knobs on a light to medium drip. Monitor the water level in the bucket to make sure the water pump is always submerged in water. **THE WATER PUMP SHOULD NOT BE RUN DRY.**

By design, all water system parts can be easily disassembled by pulling off or unscrewing and cleaned with soapy water. For routine maintenance, keep the nozzles, y-split and tubing clean with a small wire brush or the included pipe cleaner.

DO NOT SET-UP THE WATER SYSTEM AS A RE-CIRCULATING SYSTEM. THIS WILL VOID YOUR WARRANTY. This means putting the drip pan tubes into the same bucket of water as your water pump. Doing so will void your warranty and you also risk cross-contamination of grit, which may result in scratches on your stone. The grit will eventually build up in the water control valves, nozzles and tubing which will restrict water flow and potentially clog the water system parts.

Underneath each hood are three y-splits with two nozzles in each, three needle valves and clear tubing that connects to each needle valve. The clear tubing measures 1/4" outer diameter X 1/8" inner diameter. See image below to identify parts.

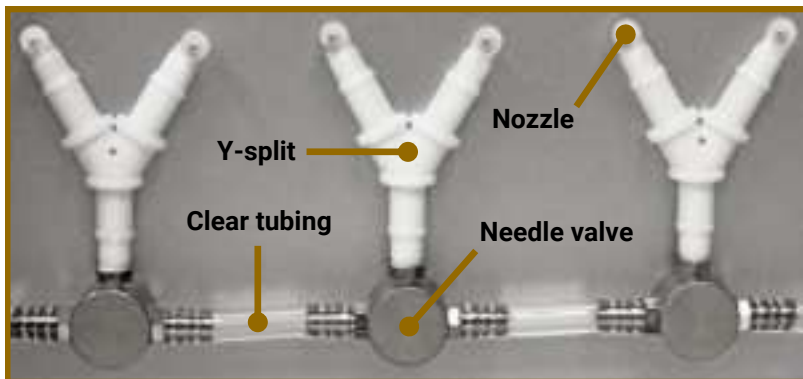

OPTIONAL ACCESSORIES

All CabKing-8V1 accessories can be purchased directly at cabking.com

8" Trim Saw Attachment

This trim saw attachment allows you to cut, grind and polish with just one machine. It fits onto either shaft of the CabKing-8V1 and comes with one 8" diameter sintered saw blade, which allows you to work right out of the box.



8" Diamond Grinding Wheels

Our nickel electroplated diamond wheels are used for rough grinding and pre-forming your material. Each wheel comes with a plastic hub in a variety of different grits. These are the 80# and 220# wheels that originally came with your unit.



8" Resin Wheels

Our resin wheels are used for finer grinding and forming, cabbing and contour grinding. Each wheel has a medium density foam backing with a plastic hub in a variety of different grits. These are the 280#, 600#, 1200# and 3000# wheels that originally came with your unit.



8" Diamond Laps

These diamond laps are used on the left shaft of the CabKing-8V1 to perform both rough and fine grinding on stones and glass. Each lap comes with a 1/2" arbor hole that is pre-bound to an acrylic backing plate. We have a variety of different grits available. This is the 360# diamond lap that originally came with your unit.



OPTIONAL ACCESSORIES

6" Full Face Diamond Laps

These full face diamond laps are used on the right shaft of the CabKing-8V1 to give you a flat surface for grinding and pre-forming your material. Each lap comes with a 1/4"-20 thread in a variety of different grits.



6" Canvas Polishing Pad

This untreated canvas polishing pad is used for polishing stones, glass and synthetic material on the right shaft of the CabKing-8V1. Each pad comes with a 1/4"-20 thread and needs to be charged with diamond paste or diamond powder before use.



Diamond Paste

Our diamond paste provides an excellent medium for polishing stones, glass and synthetic material. The paste is conveniently packaged in color-coded disposable syringes for easy mesh identification. Charge the canvas polishing pad with our diamond paste and receive excellent results.



Wheel Spacers

These aluminum spacers are used in-between the wheels on the CabKing-8V1. Get the spacing you desire with extra spacers. 1/8", 1/2", 3/4" and 1" sizes are available.



TROUBLESHOOTING

PROBLEM	RECOMMENDED SOLUTION
PARTS ARE MISSING OR DAMAGED	CONTACT US DIRECTLY BY CALLING (630) 366-6129 OR SEND US AN EMAIL AT INFO@CABKING.COM.
MOTOR IS HOT	THIS IS NORMAL. BY DESIGN, THE MOTOR IS TOTALLY ENCLOSED AND NON-VENTILATED SO IT PRODUCES HIGH TEMPERATURES. THE TEMPERATURE RANGE IS 190°F - 220°F. AVOID CONTACT WITH THE HOUSING.
MOTOR MAKES A RATTLING SOUND	THIS NOISE CAN BE COMMON AND WILL EVENTUALLY WORK ITSELF OUT WITH PROLONGED MACHINE USAGE. IT IS NOT A SERIOUS PROBLEM UNLESS THERE IS A VIBRATION ASSOCIATED WITH IT.
MOTOR VIBRATES OR SHAKES	MAKE SURE THE WHEELS ARE PROPERLY BALANCED. THIS CAN BE FIXED BY TAKING THE WHEELS OFF OF THE SHAFT AND REALIGNING THEM. MAKE SURE THE SHAFTS ARE TIGHTENED.
WATER CONTROL KNOBS KEEP SPINNING	TIGHTEN THE SET SCREW LOCATED INSIDE THE KNOBS USING A FLAT HEAD SCREWDRIVER.
WHEELS DON'T TURN	MAKE SURE POWER IS CONNECTED AND MACHINE IS TURNED ON. MAKE SURE THE WHEELS ARE NOT OBSTRUCTED. IF THE WHEELS ARE CAUGHT ON SOMETHING BEFORE YOU TURN ON THE MOTOR, THERE WILL NOT BE ENOUGH MOMENTUM TO START SPINNING.
WATER FLOW IS WEAK OR DOESN'T FLOW AT ALL	MAKE SURE THERE IS ENOUGH WATER IN THE BUCKET WITH THE WATER PUMP. MAKE SURE THE WATER PUMP IS CONNECTED TO A POWER SUPPLY. MAKE SURE ALL WATER TUBES ARE CONNECTED PROPERLY. CLEAN NOZZLES AND Y-SPLITS WITH THE INCLUDED PIPE CLEANER.
DRIP PANS DO NOT DRAIN	SHAKE THE DRIP PAN TUBES TO START THE FLOW WHILE TILTING THE DRIP PANS UPWARDS. MAKE SURE THE DRIP PAN TUBES ARE ANGLED DOWNWARDS. TUBES SHOULD ALSO BE CUT TO LENGTH AFTER SETTING UP THE UNIT. CLEAN THE DRIP PAN OUTSPOUT.
NOZZLE / WATER SYSTEM PARTS ARE LOOSE OR FALL OFF	WE SUGGEST USING TEFLON TAPE AND WRAPPING THE PORTION OF THE NOZZLE THAT IS INSERTED INTO THE Y-SPLIT WITH ENOUGH TAPE TO SECURE THE FIT.

ONE YEAR MANUFACTURER WARRANTY

This CabKing-8V1 is warranted by the manufacturer to be free from defect for the period of one full year from the purchase date.

What does this warranty cover?

This warranty covers all mechanical and structural parts of the CabKing-8V1, such as the motor, water pump, baseboard, etc.

What does this warranty not cover?

This warranty does not cover any consumable goods such as diamond abrasives, light bulbs and/or polishing pastes. This warranty also does not cover any abuse, misuse, intentional damage, incorrect usage, failure to take care of the machine, improperly following the instructions, servicing by someone other than CabKing personnel and/or theft/loss.

Who is covered under this warranty?

This warranty only covers the original purchaser of the equipment. It is non-transferrable.

What is the warranty period?

The warranty is in force for one year from the date of purchase. Please retain the original invoice of your machine for proof of warranty or register your CabKing-8V1.

Need our warranty service?

Contact us directly and we will assist you. You can either call us at (630) 366-6129 or email us at info@cabking.com. Shipping to us will be at your expense. If your machine is determined to be under warranty, we will pay for return shipping. You must PROVE that you are under warranty by providing us with the original invoice of your machine or by registering your CabKing-8V1 to receive our warranty service.



Protect your investment and extend this manufacturer's warranty another 1-2 years! For purchase and more details, visit cabking.com or call (630) 366-6129.

Important note: You have up to 45 days from the purchase date of this CabKing machine to add this extended warranty.

Manufactured by: REENTEL International Inc., 44 Plaza Dr., Westmont, IL 60559 - USA



Manufactured Using Foreign & Domestic Parts By

**Reental International Inc.
44 Plaza Dr.
Westmont, IL 60559 - USA**

CabKing Helpline

(630) 366-6129

Email

info@cabking.com

Website

cabking.com



facebook.com/TheCabKing



instagram.com/CabKing



youtube.com/CabKing