

***Robot***<sup>®</sup>

**Roomba**<sup>®</sup>

Clean Base™ Automatic Dirt Disposal

For Roomba® i Series Robot Vacuums

Owner's Guide

# Safety Information

## Important Safety Information

This owner's guide includes information for Regulatory Model(s): ADE-N1 and ADE-N2.

### SAVE THESE INSTRUCTIONS

**⚠ WARNING:** When using an electrical appliance, basic precautions should always be followed, including the following:











### READ ALL INSTRUCTIONS

**⚠ WARNING:** To reduce the risk of injury or damage, read and follow the safety precautions when setting up, using and maintaining your robot.

This appliance can be used by children aged from 8 years and above and persons with reduced physical, sensory or mental capabilities or lack of experience and knowledge if they have been given supervision or instruction concerning use of the appliance in a safe way and understand the hazards involved. Children shall not play with the appliance. Cleaning and user maintenance shall not be made by children without supervision.

**⚠ WARNING: Cancer and Reproductive Harm – [www.P65Warnings.ca.gov/product](http://www.P65Warnings.ca.gov/product)**

**⚠** This is the safety alert symbol. It is used to alert you to potential physical injury hazards. Obey all safety messages that follow this symbol to avoid possible injury or death.

- |  |   |  |   |  |
|--|---|--|---|--|
|  Risk of electric shock |  Class II equipment      |  Rated power output, d.c. |  Read operator's manual        |  General symbol for recycling |
|  Risk of fire           |  For indoor use only     |  Rated power input, d.c.  |  Keep out of reach of children | <b>BFP</b> Backfeed Protection   |
|  Separate Supply Unit   |  Rated power input, a.c. |  |   |  |

**WARNING:** Indicates a hazardous situation that, if not avoided, could result in death or serious injury.

**CAUTION:** Indicates a hazardous situation that, if not avoided, could result in minor or moderate injury.

**NOTICE:** Indicates a hazardous situation that, if not avoided, could result in property damage.

#### GENERAL



## WARNING

- This product is not a toy. Small children and pets should be supervised when the product is operating.
- Do not sit or stand on this product.
- This product comes with a region approved power supply cord and is designed to be plugged into a standard household AC power outlet only. Do not use any other power supply cord. For replacement cords, please contact Customer Care to ensure proper selection of country specific power supply cord.
- Do not disassemble or open the dirt disposal unless instructed to do so. There are no user serviceable parts inside. Refer servicing to qualified service personnel.
- Risk of electric shock, use indoors in dry location only.
- Do not handle this product with wet hands.
- Store and operate this product in room temperature environments only.

#### AUTOMATIC DIRT DISPOSAL



## WARNING

- To reduce the risk of electric shock, unplug your dirt disposal before cleaning.

- Do not pour any liquids into the device and do not immerse in water.
- Do not use outdoors or on wet surfaces.
- Do not allow to be used as a toy. Close attention is necessary when used by or near children.
- Use only as described in this manual.
- Do not use with damaged cord or plug. If appliance is not working as it should, has been dropped, damaged, left outdoors, or dropped into water, return it to a service center.
- Do not handle plug or appliance with wet hands.
- Do not put any object into openings. Do not use with any opening blocked; keep free of dust, lint, hair, and anything that may reduce air flow.
- In order to avoid a hazard due to inadvertent resetting of the thermal cut-out, this appliance must not be supplied through an external switching device, such as a timer, or connected to a circuit that is regularly switched on and off by the utility.

## NOTICE

- Product may not be used with any type of power converter. Use of power converters will immediately void the warranty.
- If you live in an area prone to electrical storms, it is recommended that you use additional surge protection. Your dirt disposal may be protected with a surge protector in the event of severe electrical storms.
- Do not use without dust bag and/or filters in place.
- To properly maintain your dirt disposal, do not place foreign objects inside and ensure it is clear of debris.
- Always disconnect your robot from the dirt disposal before cleaning or maintaining it.

# About Your Clean Base™ Automatic Dirt Disposal

## Front View

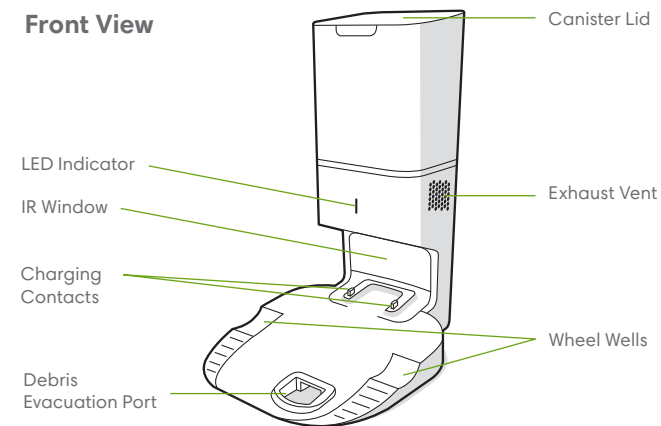

## Top View

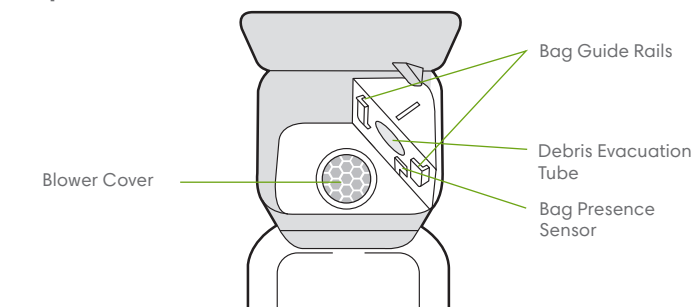

## Back View

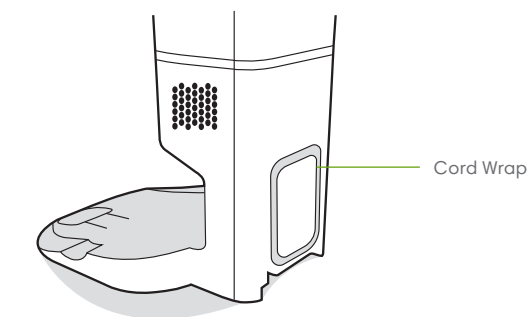

## Bottom View

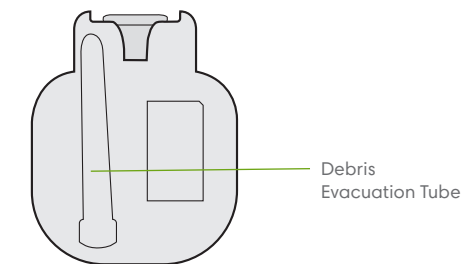

# Using Your Automatic Dirt Disposal

## Positioning the Clean Base™ Automatic Dirt Disposal

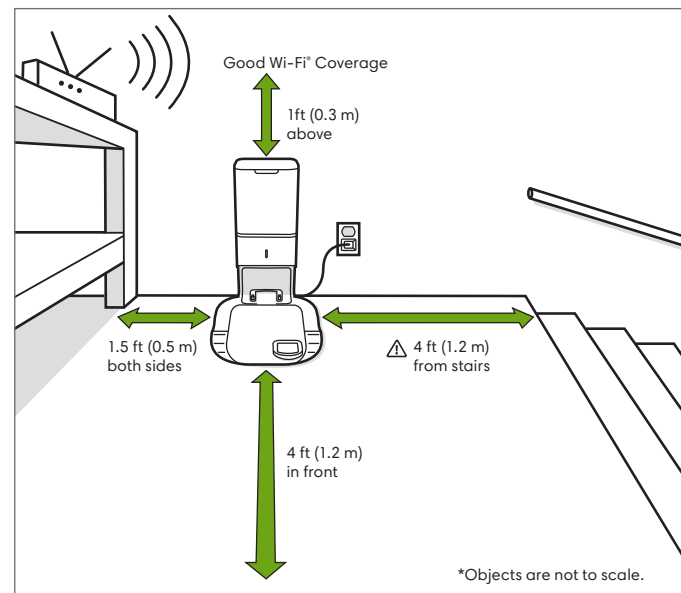

**⚠ WARNING:** To prevent the risk of your robot falling downstairs, ensure that the charging station is placed at least 4 feet (1.2 meters) away from stairs.

## About Your Automatic Dirt Disposal

While cleaning, your robot will automatically return to the dirt disposal to empty its bin and recharge as needed.

The dirt disposal's LED indicator will turn solid red when a new bag is needed. If a clog is detected, the dirt disposal will trigger additional attempts to automatically clear the clog.

**Note:** If you place your robot on the dirt disposal by hand, it will not empty automatically. In this case, use the iRobot HOME App or the button on your robot to manually empty your robot's bin.

## Care and Maintenance

### Care and Maintenance Instructions

To keep your dirt disposal running at peak performance, follow these care procedures:

Dock Part	Care Frequency	Replacement frequency
Bags	-	Bags should be replaced when prompted by the LED indicator / app
Charging Contacts IR Window	Once every month	-
Blower Cover inside canister	Once every month (remove debris from blower cover)	-

**Note:** iRobot manufactures various replacement parts and assemblies. If you think you need a replacement part, please contact iRobot Customer Care for more information.

## Replacing the Bag

1 Lift up on the canister lid to open.

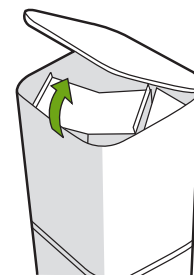

2 Pull up on the plastic card to remove the bag from the canister.

**Note:** This will seal the bag so dust and debris cannot escape.



3 Discard the used bag.

4 Install a new bag, sliding the plastic card into the guide rails.

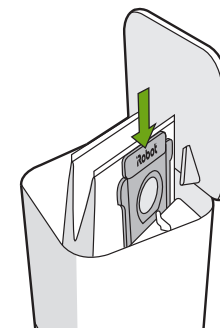

5 Press down on the lid making sure it is completely closed.

**Note:** To achieve optimal performance with your robot and automatic dirt disposal, clean and/or replace your robot's filter as needed.

## Cleaning the IR Window and Charging Contacts

Inspect the sensors and charging contacts to make sure they are clear of debris. Wipe with a clean, dry cloth.

**Note:** Do not spray cleaning solution directly onto sensors or into sensor openings.

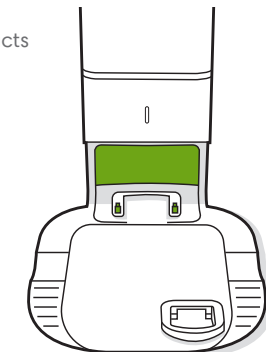

## Removing Debris from Blower Cover

Inspect blower cover for any lint or debris built-up, and wipe with a clean dry cloth to remove.

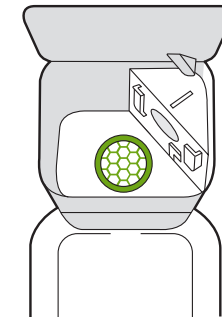

# Troubleshooting

Your dirt disposal will tell you if something is wrong via an LED indicator on the front of the canister and through the iRobot HOME App.

LED Indicator	Common Error	How to Fix
Solid Red	Bag full or missing	<ol style="list-style-type: none"> <li>1. Replace bag if it is full or missing.</li> <li>2. Make sure the bag is securely inserted.</li> <li>3. If problem persists, remove any debris from the port on the bottom of your robot and the dirt disposal.</li> </ol>
Blinking Red	There is a leak or a clog in the dock evacuation path	<ol style="list-style-type: none"> <li>1. Make sure the canister lid is pushed down and firmly sealed. Tap the  button on your robot to manually empty the bin.</li> <li>2. Remove any debris from the port on the bottom of your robot and dirt disposal.</li> <li>3. Unplug the dirt disposal from the wall. Place it on its side and inspect the debris evacuation tube for debris. If necessary, remove the tube to clear any debris.</li> </ol>

# iRobot Customer Care

## USA & Canada

If you have questions or comments about your dirt disposal, please contact iRobot before contacting a retailer.

You can start by visiting [global.irobot.com](http://global.irobot.com) for support tips, frequently asked questions and information about accessories. This information can also be found in the iRobot HOME App. If you need further assistance, call the US Customer Care team at **(877) 855-8593**.

### iRobot USA Customer Care Hours

- Monday to Friday, 9AM – 9PM Eastern Time
- Saturday and Sunday 9AM – 6PM Eastern Time

## Outside USA & Canada

Visit [global.irobot.com](http://global.irobot.com) to:

- Learn more about iRobot in your country
- Get hints and tips to improve your product performance
- Get answers to questions
- Contact your local support center

# Regulatory Information

This device complies with part 15 of the FCC Rules and ICES-003. Operation is subject to the following two conditions: 1) This device may not cause harmful interference, and 2) this device must accept any interference received, including interference that may cause undesired operation.

This device complies with Industry Canada license-exempt RSS standard(s). Operation is subject to the following two conditions: 1) This device may not cause interference, and 2) this device must accept any interference, including interference that may cause undesired operation of the device.

- Changes or modifications not expressly approved by iRobot Corporation could void the user's authority to operate the equipment.
- This equipment has been tested and found to comply with the limits for a Class B digital device, pursuant to part 15 of the FCC Rules as well as ICES-003 Rules. These limits are designed to provide reasonable protection against harmful interference in a residential installation. This equipment generates, uses and can radiate radio frequency energy and, if not installed and used in accordance with the instructions, may cause harmful interference to radio communications. However, there is no guarantee that interference to radio communication will not occur in a particular installation. If this equipment does cause harmful interference to radio or television reception, which can be determined by turning the equipment off and on, the user is encouraged to try to correct the interference by one or more of the following measures:
  - Reorient or relocate the receiving antenna.
  - Increase the separation between the equipment and receiver.

- Connect the equipment into an outlet on a circuit different from that to which the receiver is connected.
- Consult the dealer or an experienced radio/TV technician for help.
- Under Industry Canada regulations, this radio transmitter may only operate using an antenna of a type and maximum (or lesser) gain approved for the transmitter by Industry Canada. To reduce potential radio interference to other users, the antenna type and its gain should be so chosen that the equivalent isotropically radiated power (e.i.r.p.) is not more than the necessary for successful communication.
- FCC Radiation Exposure Statement: This product complies with FCC §2.1093(b) for portable RF exposure limits, set forth for an uncontrolled environment and is safe for the intended operation as described in this manual.
- ISED Radiation Exposure Statement: This product complies with the Canadian Standard RSS-102 for portable RF exposure limits, set forth for an uncontrolled environment and is safe for the intended operation as described in this manual.





©2018 iRobot Corporation, 8 Crosby Drive, Bedford, MA 01730 USA. All rights reserved.  
iRobot, Roomba, and Virtual Wall are registered trademarks of iRobot Corporation.  
HomeBase+ is a trademark of iRobot Corporation. Wi-Fi and the Wi-Fi logo are  
registered trademarks of Wi-Fi Alliance.

