

1

Kit 145309

TOYOTA Land Crusier 300, 5-dr SUV, 21-



ISO 11154-E

1 KIT

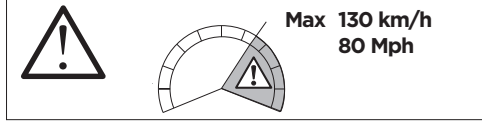
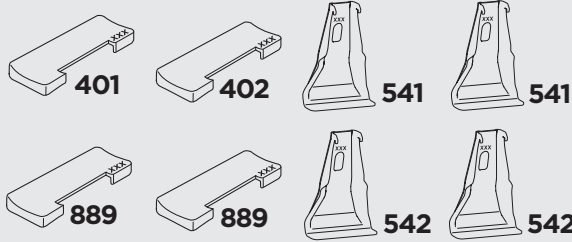
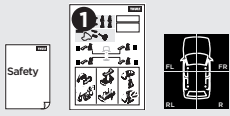

2 FOOT PACK

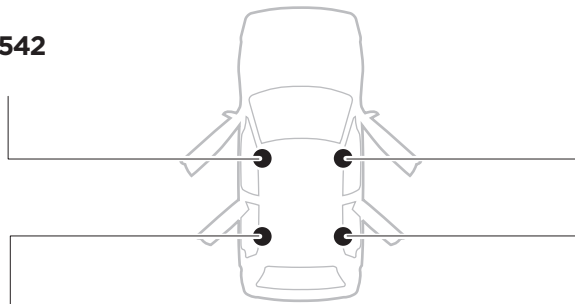
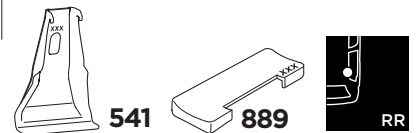
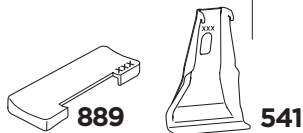
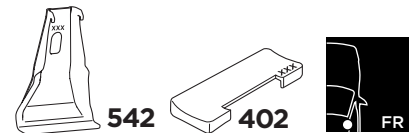
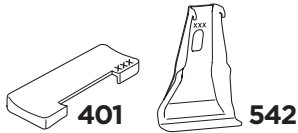
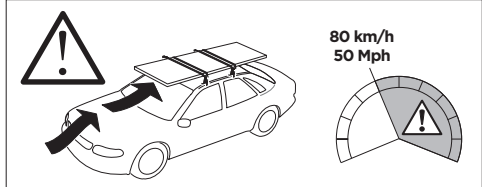
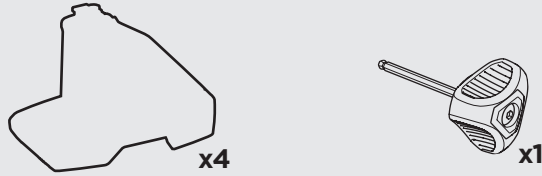

1



x4

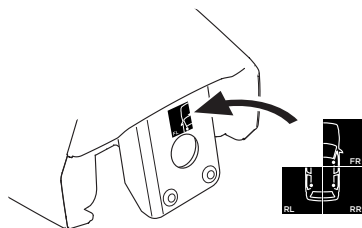
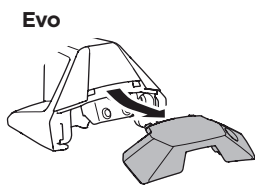

2

x4

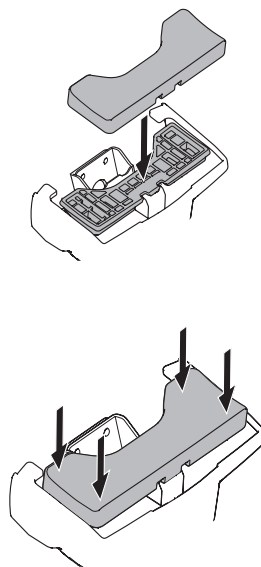

3

x4

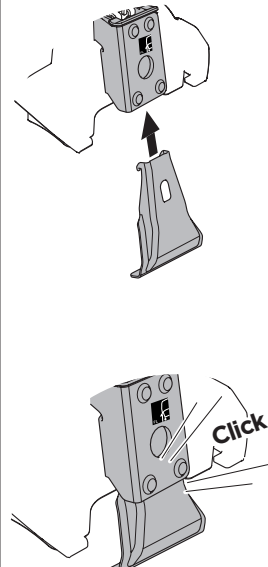



THULE WingBar Evo	THULE WingBar Edge	THULE WingBar	THULE SquareBar Evo	Evo X (scale)	Edge X (scale)
TOYOTA Land Cruiser 300, 5-dr SUV, 21-				59,5	N/A
THULE ProBar Evo	THULE SlideBar Evo				X (mm/inch)
TOYOTA Land Cruiser 300, 5-dr SUV, 21-				1246 mm / 49"	

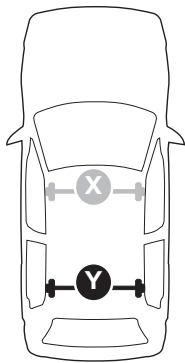

THULE WingBar Evo	THULE WingBar Edge	THULE WingBar	THULE SquareBar Evo	Evo Y (scale)	Edge Y (scale)
TOYOTA Land Cruiser 300, 5-dr SUV, 21-				56,5	N/A
THULE ProBar Evo	THULE SlideBar Evo				Y (mm/inch)
TOYOTA Land Cruiser 300, 5-dr SUV, 21-				1216 mm / 47 7/8"	

	W (mm/inch)	Z (mm/inch)
TOYOTA Land Cruiser 300, 5-dr SUV, 21-	750 mm / 29 1/2"	430 mm / 16 7/8"

