



# LUMINAR EVERYDAY 59250 2ft LED Linkable Plant Grow Light Owner's Manual

[Home](#) » [LUMINAR EVERYDAY](#) » LUMINAR EVERYDAY 59250 2ft LED Linkable Plant Grow Light Owner's Manual



## Contents

- [1 LUMINAR EVERYDAY 59250 2ft LED Linkable Plant Grow Light Owner's Manual](#)
- [2 Owner's Manual & Safety Instructions](#)
- [3 IMPORTANT SAFETY INFORMATION](#)
- [4 Grounding](#)
- [5 110-120 VAC Double Insulated Lights: Lights with Two Prong Plugs](#)
- [6 Extension Cords](#)
- [7 Symbology](#)
- [8 Specifications](#)
- [9 Mounting Instructions](#)
- [10 Suspended Mounting](#)
- [11 Surface Mounting](#)
- [12 Maintenance](#)
  - [12.1 WARNING](#)
- [13 Parts List and Diagram](#)
- [14 Limited 90 Day Warranty](#)
- [15 WARRANTIES, EXPRESS OR IMPLIED, INCLUDING THE WARRANTIES OF MERCHANTABILITY AND FITNESS.](#)
- [16 Read More About This Manual & Download PDF:](#)
- [17 Documents / Resources](#)
- [18 Related Posts](#)





## LUMINAR EVERYDAY 59250 2ft LED Linkable Plant Grow Light Owner's Manual

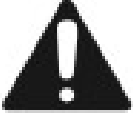

### Owner's Manual & Safety Instructions

Save This Manual Keep this manual for the safety warnings and precautions, assembly, operating, inspection, maintenance and cleaning procedures. Write the product's serial number in the back of the manual near the assembly diagram (or month and year of purchase if product has no number). Keep this manual and the receipt in a safe and dry place for future reference.

## WARNING SYMBOLS AND DEFINITIONS

	<p>This is the safety alert symbol. It is used to alert you to potential personal injury hazards. Obey all safety messages that follow this symbol to avoid possible injury or death.</p>
 DANGER	<p>Indicates a hazardous situation which, if not avoided, will result in death or serious injury.</p>
 WARNING	<p>Indicates a hazardous situation which, if not avoided, could result in death or serious injury.</p>
 CAUTION	<p>Indicates a hazardous situation which, if not avoided, could result in minor or moderate injury.</p>
NOTICE	<p>Addresses practices not related to personal injury.</p>

## IMPORTANT SAFETY INFORMATION

To reduce the risk of FIRE, ELECTRIC SHOCK, OR INJURY TO PERSONS:

1. Install only according to these instructions. Improper installation can create hazards.
2. Avoid electric shock. Keep plugs and receptacles dry. Use only on GFCI-protected circuits.
3. Suitable for damp locations.
4. This product is not suitable for recessed installation in ceilings or on buildings. Do not install on radiant heat ceilings.
5. Wear ANSI-approved goggles and heavy-duty work gloves during installation.
6. Keep work area clean and well lit. Cluttered or dark areas invite accidents.
7. Do not operate the Light in explosive atmospheres, such as in the presence of flammable liquids, gases or dust. The Light generates sparks which may ignite the dust or fumes.
8. The Light's plug must match the outlet. Never modify the plug in any way. Do not use any adapter plugs with the Light. Unmodified plugs and matching outlets will reduce risk of electric shock.

9. Do not abuse the Power Cord. Never use the Cord for unplugging the Light. Keep cord away from heat, oil, sharp edges or moving parts. Damaged or entangled cords increase the risk of electric shock.
10. Maintain the Light. Check for breakage of parts and any other condition that may affect the Light's operation. If damaged, have it repaired before use. Many accidents are caused by poorly maintained items.
11. Maintain labels and nameplates on the Light. These carry important safety information. If unreadable or missing, contact Harbor Freight Tools for a replacement.
12. This product is not a toy. Keep it out of reach of children.
13. Do not install directly over a heat source (stove, etc.).
14. People with pacemakers should consult their physician(s) before use. Electromagnetic fields in close proximity to heart pacemaker could cause pacemaker interference or pacemaker failure.
15. The warnings, precautions, and instructions discussed in this instruction manual cannot cover all possible conditions and situations that may occur. It must be understood by the operator that common sense and caution are factors which cannot be built into this product, but must be supplied by the operator.

## Grounding



TO PREVENT ELECTRIC SHOCK AND DEATH FROM INCORRECT GROUNDING WIRE CONNECTION:

Check with a qualified electrician if you are in doubt as to whether the outlet is properly grounded.

Do not modify the power cord plug provided with the Light. Never remove the grounding prong from the plug. Do not use the Light if the power cord or plug is damaged. If damaged, have it repaired by a service facility before use. If the plug will not fit the outlet, have a proper outlet installed by a qualified electrician.

## 110-120 VAC Double Insulated Lights: Lights with Two Prong Plugs

1. To reduce the risk of electric shock, double insulated equipment has a polarized plug (one blade is wider than the other). This plug will fit in a polarized outlet only one way. If the plug does not fit fully in the outlet, reverse the plug. If it still does not fit, contact a qualified electrician to install the proper outlet. Do not change the plug in any way.

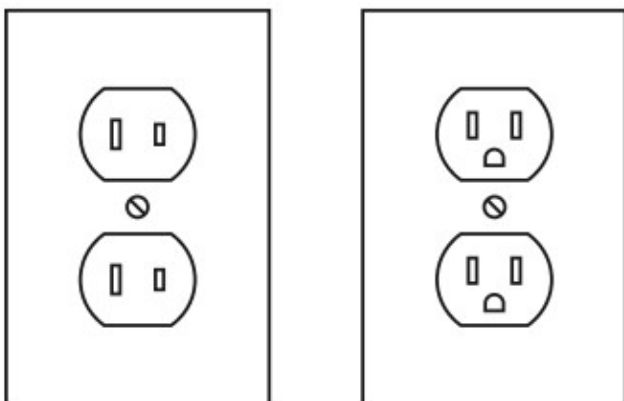

**Outlets for 2-Prong Plug**

2. Double insulated tools may be used in either of the 120 volt outlets shown in the preceding illustration. (See Outlets for 2-Prong Plug.)

## Extension Cords

1. Grounded Lights require a threewire extension cord. Double Insulated Lights can use either a two or three wire extension cord.
2. As the distance from the supply outlet increases, you must use a heavier gauge extension cord.  
Using extension cords with inadequately sized wire causes a serious drop in voltage, resulting in loss of power and possible tool damage. (See Table A.)





**TABLE A: RECOMMENDED MINIMUM WIRE GAUGE FOR EXTENSION CORDS\* (120 VOLT)**

NAMEPLATE AMPERES  (at full load)	EXTENSION CORD LENGTH				
	25'	50'	75'	100'	150'
0 – 2.0	18	18	18	18	16
2.1 – 3.4	18	18	18	16	14
3.5 – 5.0	18	18	16	14	12
5.1 – 7.0	18	16	14	12	12
7.1 – 12.0	16	14	12	10	–
12.1 – 16.0	14	12	10	–	–
16.1 – 20.0	12	10	–	–	–

\* Based on limiting the line voltage drop to five volts at 150% of the rated amperes.

3. The smaller the gauge number of the wire, the greater the capacity of the cord. For example, a 14 gauge cord can carry a higher current than a 16 gauge cord.
4. When using more than one extension cord to make up the total length, make sure each cord contains at least the minimum wire size required.
5. If you are using one extension cord for more than one tool, add the nameplate amperes and use the sum to determine the required minimum cord size.
6. If you are using an extension cord outdoors, make sure it is marked with the suffix "W-A" ("W" in Canada) to indicate it is acceptable for outdoor use.
7. Make sure the extension cord is properly wired and in good electrical condition. Always replace a damaged extension cord or have it repaired by a qualified electrician before using it.
8. Protect the extension cords from sharp objects, excessive heat, and damp or wet areas.

## Symbology

	Double Insulated		Read the manual before set-up and/or use.
<b>VAC</b>	Volts Alternating Current		WARNING marking concerning Risk of Fire. Do not cover ventilation ducts. Keep flammable objects away.
<b>A</b>	Amperes		WARNING marking concerning Risk of Electric Shock. Properly connect power cord to appropriate outlet.
	WARNING marking concerning Risk of Eye Injury. Wear ANSI-approved safety goggles with side shields.		

## Specifications

Electrical Rating	120 VAC / 60Hz / 19W / 0.172A
Receptacle Load	1.8A
Power Cord Length	5 ft.

This device complies with part 15 of the FCC Rules. Operation is subject to the following two conditions: (1) This device may not cause harmful interference, and (2) this device must accept any interference received, including interference that may cause undesired operation.

**Note:** This equipment has been tested and found to comply with the limits for a Class B digital device, pursuant to part 15 of the FCC Rules. These limits are designed to provide reasonable protection against harmful interference in a residential installation. This equipment generates, uses and can radiate radio frequency energy and, if not

installed and used in accordance with the instructions, may cause harmful interference to radio communications. However, there is no guarantee that interference will not occur in a particular installation. If this equipment does cause harmful interference to radio or television reception, which can be determined by turning the equipment off and on, the user is encouraged to try to correct the interference by one or more of the following measures:

- Reorient or relocate the receiving antenna.
- Increase the separation between the equipment and receiver.
- Connect the equipment into an outlet on a circuit different from that to which the receiver is connected.
- Consult the dealer or an experienced radio/TV technician for help.

## Mounting Instructions



Read the ENTIRE IMPORTANT SAFETY INFORMATION section at the beginning of this document including all text under subheadings therein before set up or use of this product.

## Suspended Mounting

1. Select a suitable location for hanging the Grow Light. The Grow Light must be hung from a sturdy mounting surface able to support the weight of the fixture.

CAUTION! Do not install the Grow Light into drywall.

WARNING! TO PREVENT SERIOUS INJURY: Verify that installation surface has no hidden utility lines before drilling or driving screws.

2. Mark mounting locations 23.6" apart on mounting surface.

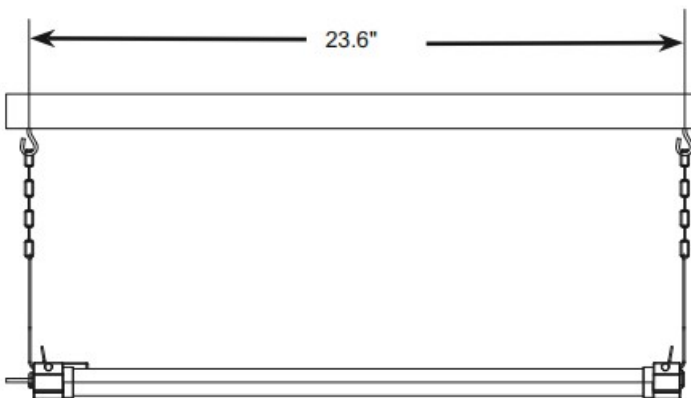

3. Drill 1/8" holes in mounting locations.
4. Thread J Hooks into holes.



5. Add chains to V Hooks.



6. Attach V Hooks to Grow Light.

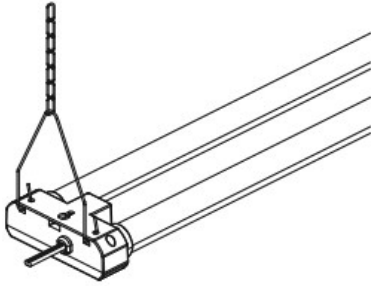

7. Hang the Chain on the J Hook.

8. Connect no more than eight Grow Lights together.

9. Plug power cord into 120VAC grounded receptacle. Turn on Power Switch(es).

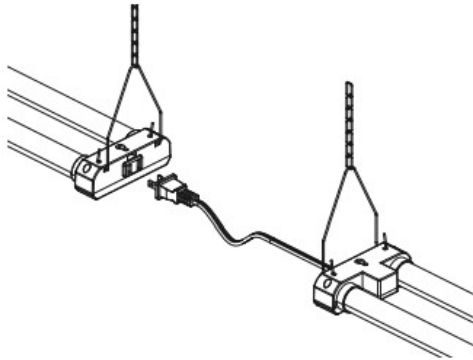

## Surface Mounting

1. Mark mounting locations 22.6! apart on mounting surface.

2. Drill 1/8! holes in mounting locations.

3. Thread Screws into holes, leaving Screw heads extending 0.1! from mounting surface.

4. Align large ends of keyholes on Grow Light with Screws on mounting surface.

5. Slide Grow Light toward small ends of keyholes to secure.

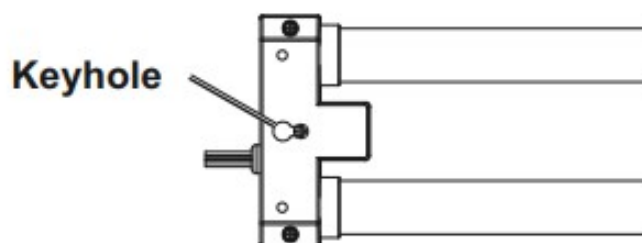



6. Connect no more than eight Grow Lights together.
7. Plug power cord into 120VAC grounded receptacle. Turn on Power Switch(es).

## Maintenance



Procedures not specifically explained in this manual must be performed only by a qualified technician



### **WARNING**

**TO PREVENT SERIOUS INJURY FROM ACCIDENTAL OPERATION:**

Unplug the Light from its electrical outlet before performing any procedure in this section.

**TO PREVENT SERIOUS INJURY FROM LIGHT FAILURE:**

Do not use damaged equipment. If damage is noted, have the problem corrected before further use.

1. **BEFORE EACH USE**, inspect the general condition of the Grow Light. Check for:
  - loose hardware
  - misalignment or binding of moving parts
  - damaged cord/electrical wiring
  - cracked or broken parts
  - any other condition that may affect its safe operation.
2. **PERIODICALLY**, clean the Diffuser Cover with nonabrasive glass cleaner and a clean cloth.



**WARNING! TO PREVENT SERIOUS INJURY:** If the supply cord of this light is damaged, it must be replaced only by a qualified service technician.

## Parts List and Diagram

Part	Description	Qty
1	Triangle V Hook	2
2	Chain	2
3	J Hook	2
4	Screw	2
5	Grow Light	1

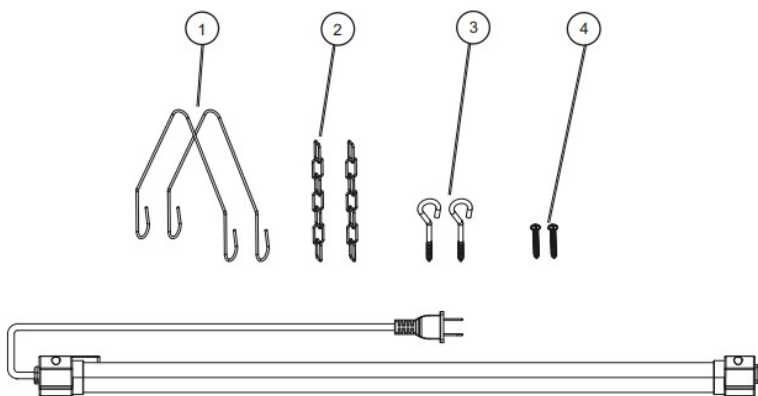

#### Record Product's Serial Number Here:

**Note:** If product has no serial number, record month and year of purchase instead.

**Note:** Some parts are listed and shown for illustration purposes only, and are not available individually as replacement parts. Specify UPC 193175463784 when ordering parts.

#### Limited 90 Day Warranty

Harbor Freight Tools Co. makes every effort to assure that its products meet high quality and durability standards, and warrants to the original purchaser that this product is free from defects in materials and workmanship for the period of 90 days from the date of purchase. This warranty does not apply to damage due directly or indirectly, to misuse, abuse, negligence or accidents, repairs or alterations outside our facilities, criminal activity, improper installation, normal wear and tear, or to lack of maintenance. We shall in no event be liable for death, injuries to persons or property, or for incidental, contingent, special or consequential damages arising from the use of our product. Some states do not allow the exclusion or limitation of incidental or consequential damages, so the above limitation of exclusion may not apply to you. THIS WARRANTY IS EXPRESSLY IN LIEU OF ALL OTHER

## WARRANTIES, EXPRESS OR IMPLIED, INCLUDING THE WARRANTIES OF MERCHANTABILITY AND FITNESS.

To take advantage of this warranty, the product or part must be returned to us with transportation charges prepaid. Proof of purchase date and an explanation of the complaint must accompany the merchandise.

If our inspection verifies the defect, we will either repair or replace the product at our election or we may elect to refund the purchase price if we cannot readily and quickly provide you with a replacement. We will return repaired products at our expense, but if we determine there is no defect, or that the defect resulted from causes not within the scope of our warranty, then you must bear the cost of returning the product.

This warranty gives you specific legal rights and you may also have other rights which vary from state to state

***Read More About This Manual & Download PDF:***

### Documents / Resources

	<p><a href="#">LUMINAR EVERYDAY 59250 2ft LED Linkable Plant Grow Light [pdf] Owner's Manual</a> 59250, 2ft LED Linkable Plant Grow Light, 59250 2ft LED Linkable Plant Grow Light</p>
--	--