



## COMFIER JR-2201 Smart Skipping Rope User Manual

[Home](#) » [COMFIER](#) » COMFIER JR-2201 Smart Skipping Rope User Manual 



# COMFIER

JR-2201 Smart Skipping Rope  
User Manual

With speed indication light function



## Contents

- 1 [JR-2201 Smart Skipping Rope](#)
- 2 [Product Specification](#)
- 3 [Product Feature](#)
- 4 [Product LCD display](#)
- 5 [Display in different modes](#)
- 6 [Installation of the Jump Rope](#)
- 7 [App Operation](#)
- 8 [Short ball Skipping](#)
- 9 [Other App functions](#)
- 10 [Offline storage function](#)
- 11 [Caution and Maintenance](#)
- 12 [Battery and replacing](#)
- 13 [Tips for battery:](#)
- 14 [Warranty](#)
- 15 [Extend Warranty for Free](#)
- 16 [Documents / Resources](#)
- 17 [Related Posts](#)

## JR-2201 Smart Skipping Rope

Please read the instructions carefully before using the jump rope.

### Product Specification

Product Size	Φ37.5x 164mm
Product Weight	0.21 kg
LCD Display	19.6 x 8.1mm
Power	2xAAA
USB cable	N/A
Max. Jumps	9999 times
Max. Time	99 Mins 59 Seconds
Min. Jump	1 time
Min. Time	1 seconds
Auto off Time	5 Mins

### Product Feature

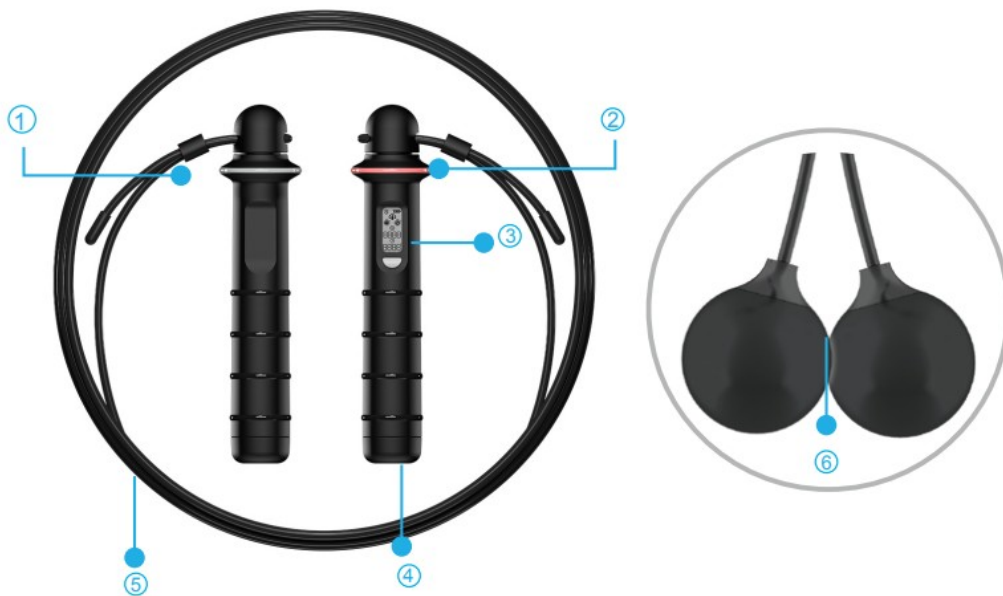

1. Power on & off/Reset/Mode Button
2. Indication light(Main handle only)
3. LCD display
4. Batter cover
5. PVC rope
6. Short ball

**Product LCD display**

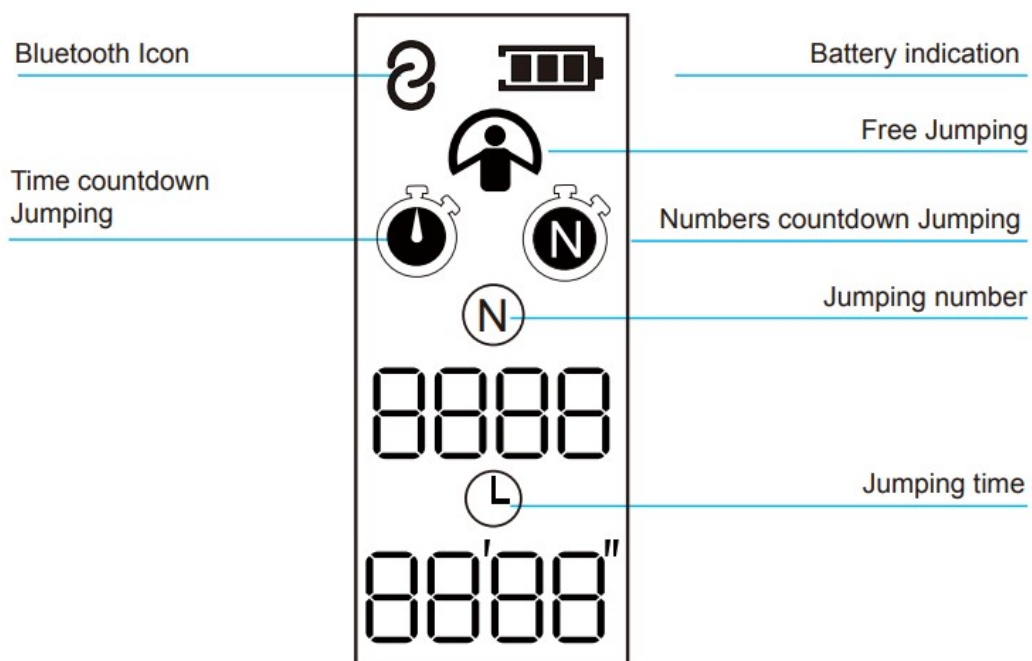

**Display in different modes**



1. Time Countdown Mode

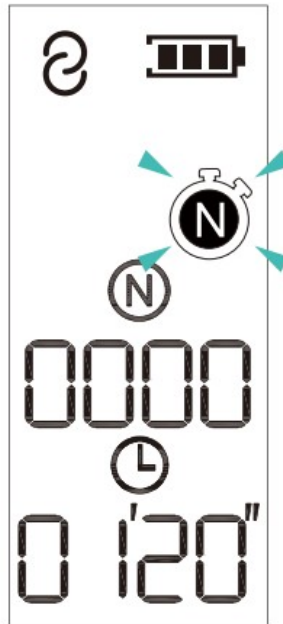

2. Numbers Countdown Mode



3. Free Skipping Mode

## Installation of the Jump Rope

The jump handle and the rope/short ball are packed separately in the box, please follow below steps to assemble rope/Short ball to match with handle and adjust the length accordingly.

Main handle installation:

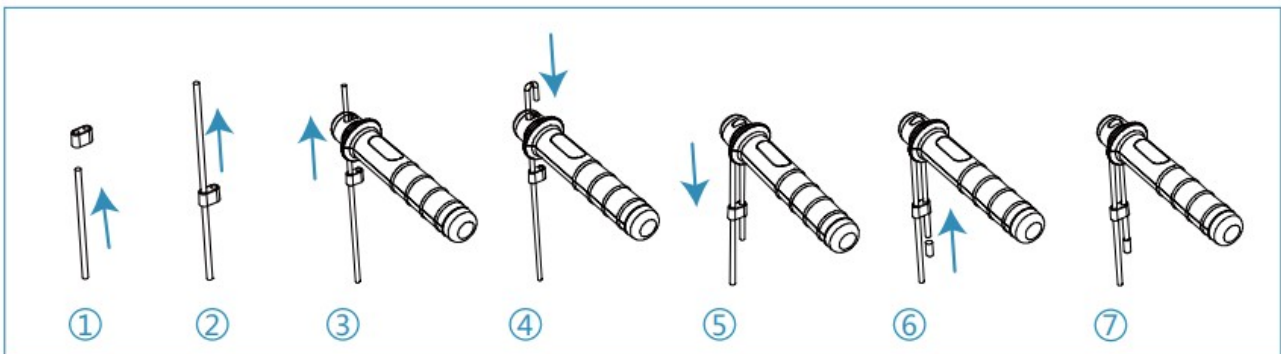

Vice handle installation:

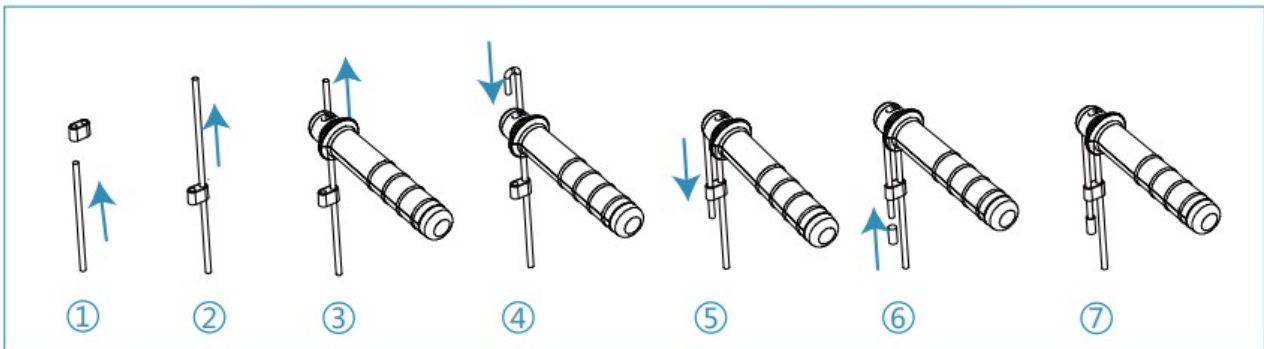

Battery installation:

Remove the bottom cap and install 2 AAA batteries into the handle, make sure the batteries are placed in the correct polarity.

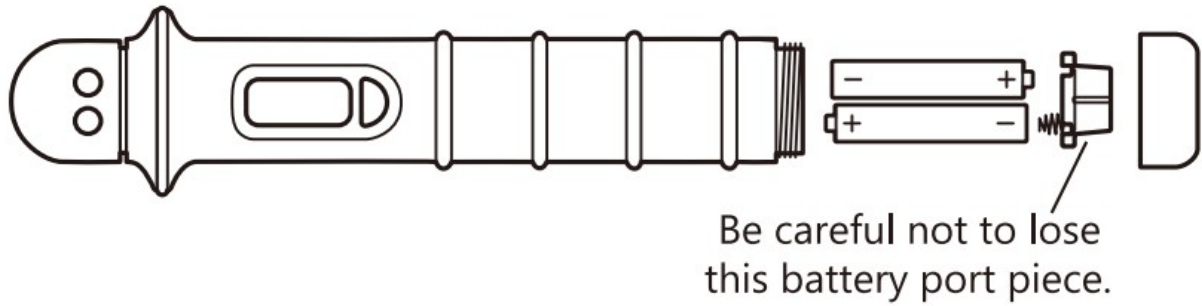

## App Operation

1. Before starting using the jump rope, please download App: COMFIER from App store or Google play. Or scan below QR code to download the App.

	
<a href="https://apps.apple.com/cn/app/comfier/id1602455699">https://apps.apple.com/cn/app/comfier/id1602455699</a>	<a href="https://play.google.com/store/apps/details?id=com.ruikang.comfier">https://play.google.com/store/apps/details?id=com.ruikang.comfier</a>

2. During your installation for the App,

iOs: make sure to accept permission requirement on Bluetooth, and allow the authorization for version 10.0 and above.

Android: make sure to accept permission of GPS & Location.

Note: It is required by Google that all the smart phones operated with Android Ver. 6.0 or above must ask for the permission of location if any BLE device could be scanned and linked through Bluetooth. Any private information would not be collected by the App. You can also refer to the official document of Google for more information: <https://source.android.com/devices/blue>–

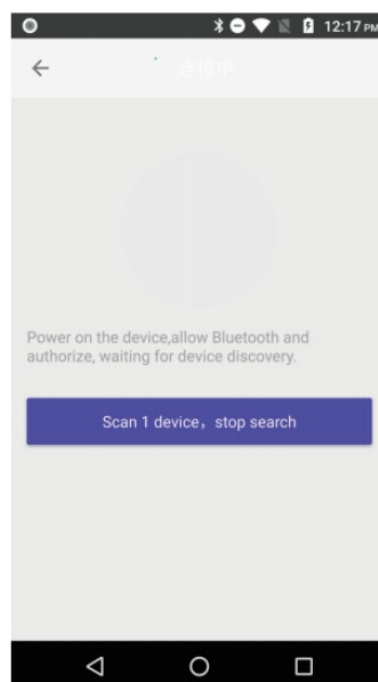
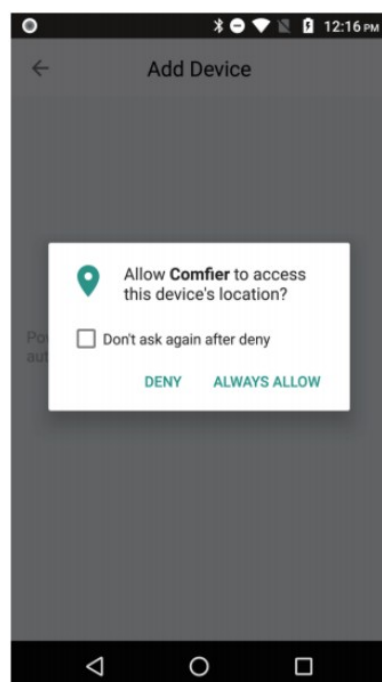

3. Open COMFIER App, fill in your personal info, and start the App.

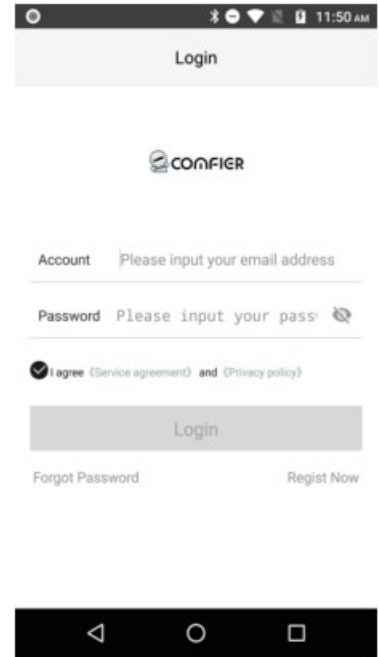
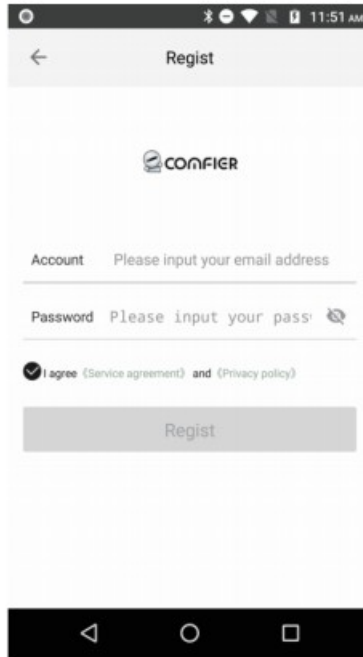

4. COMFIER will automatically pair the jump rope, you can check the main interface on the App to check the status of connection.

- “Connected” shown on the main interface means successful pairing.
- “Disconnected” shown on the main interface means unsuccessful pairing. In this condition, please press “Account” → “Device” → “+” to add the device manually

5. Click the mode you need on the main interface on the App to start your jumping;

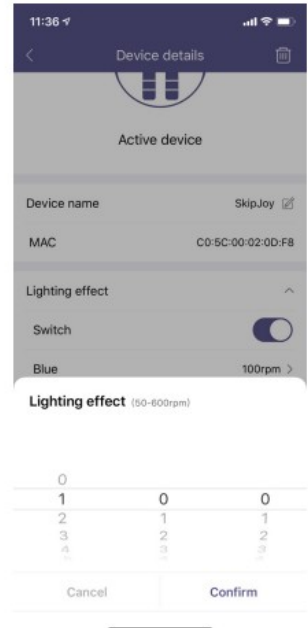
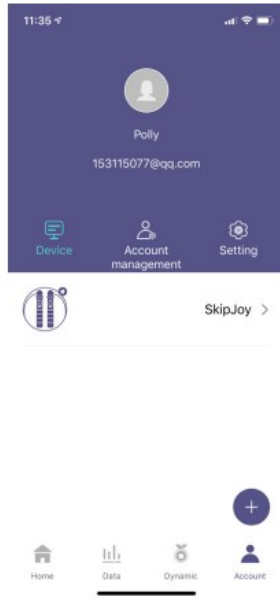
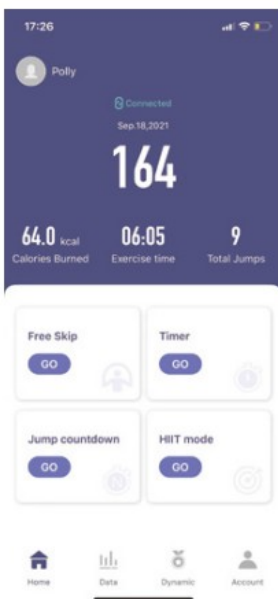

**Light indication function:**

When Light effect is Switch on, LED will light up cycling through Red, Green and blue once when beginning and ending exercise.

During skipping, each color represents a specific speed:

**Red:** >200 jumps/min,

**Blue:** 160-199 jumps/min

**Green:** 100-159 jumps/min

**Remark:** You can change and update different speed value for each light color via device details page.

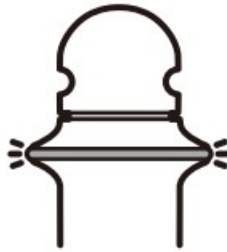

## Jump Modes:

### Free Jumping/Time countdown/ Numbers countdown

1. Without App: you can keep pressing the button for about 3 seconds to shift the mode you need from above three modes.

2. With App: you have four modes for options:

Free Jumping/Time countdown/Numbers countdown/Training mode

### Free Jumping:

Jump the rope freely and there is no limit on time and number of skipping.

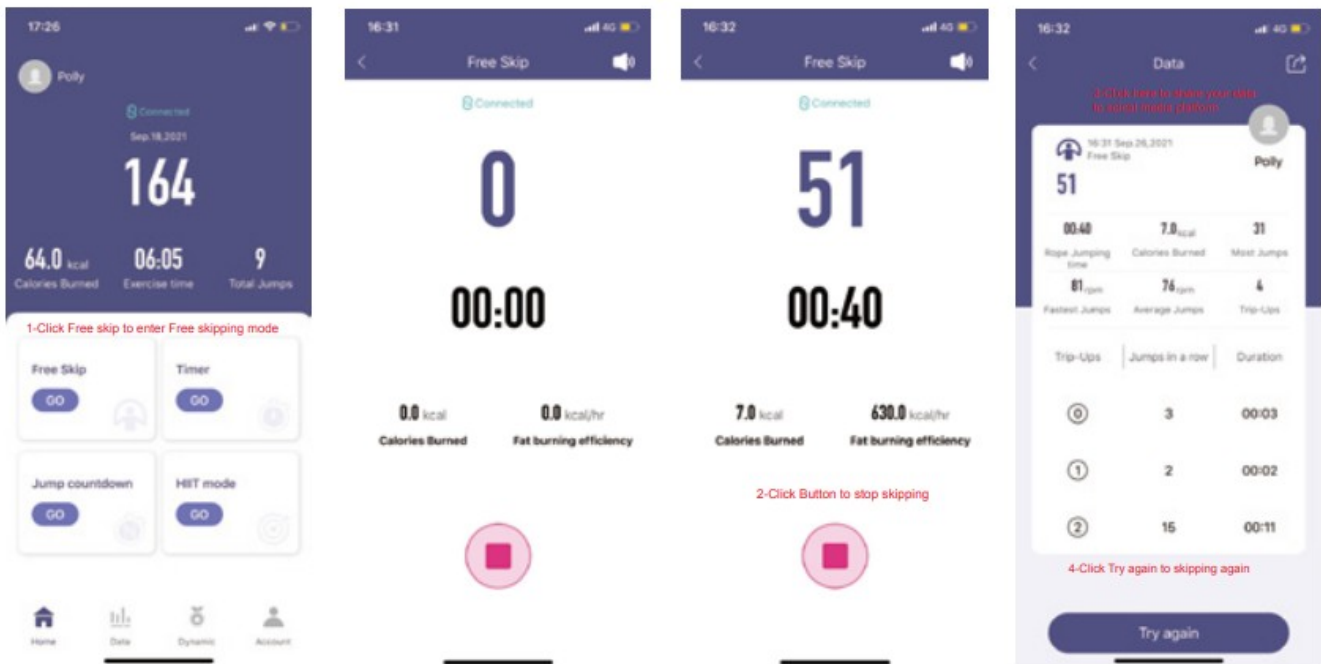

### Time countdown Jumping:

- set the total jumping time.
- options for time can be set on App: 30 sec, 1 min, 5 min, 10 min, and customized time;
- Without the App, the rope will use the last countdown setting of time from the App.



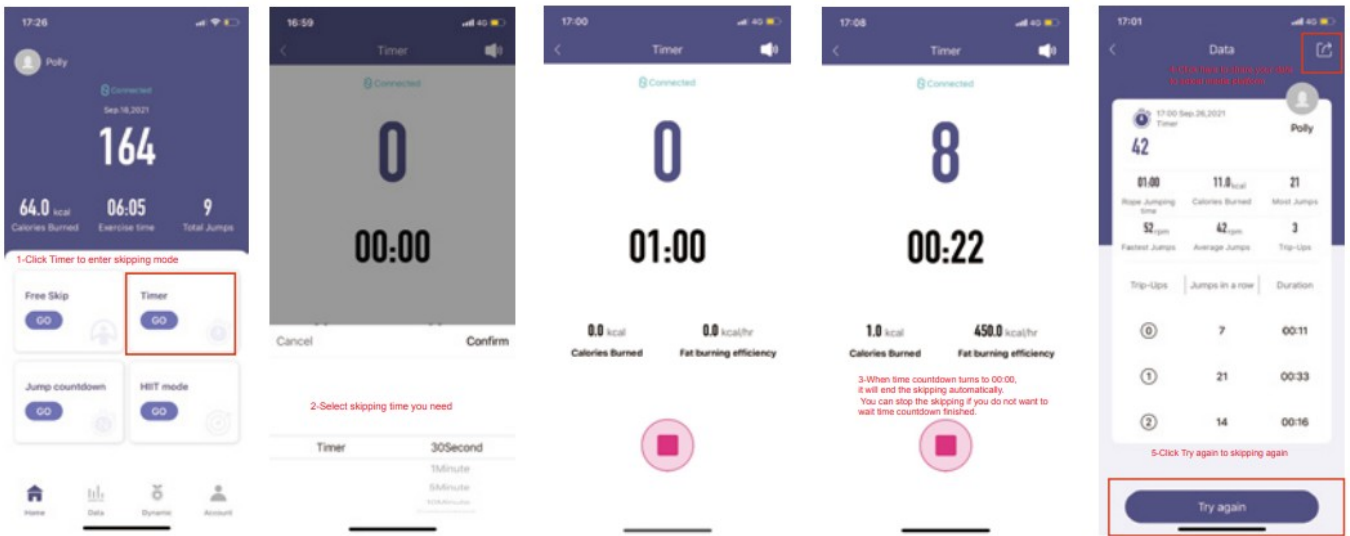

### Numbers countdown Jumping:

- set the total jumps;
- options for number of jumps can be set on App: 50, 100, 500, 1000 and customized number of jumps.
- Without the App, the rope will use the last countdown setting of time from the App.

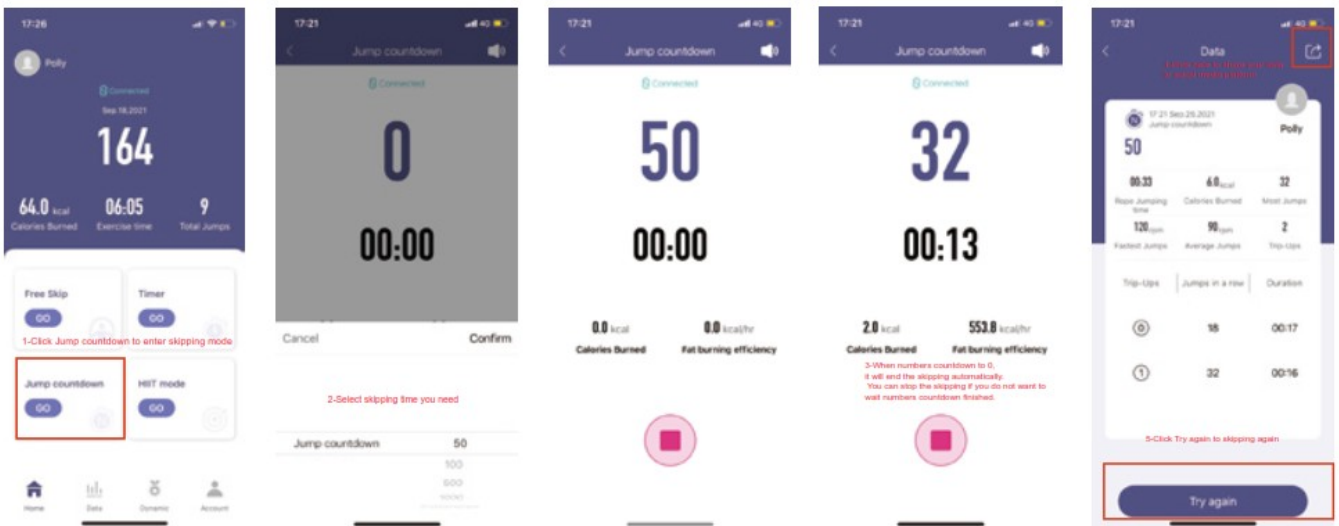

### HIIT Mode:

- set the total jumps;
- options for number of jumps can be set on App: 50, 100, 500, 1000 and customized number of jumps.
- Without the App, the rope will use the last countdown setting of time from the App.

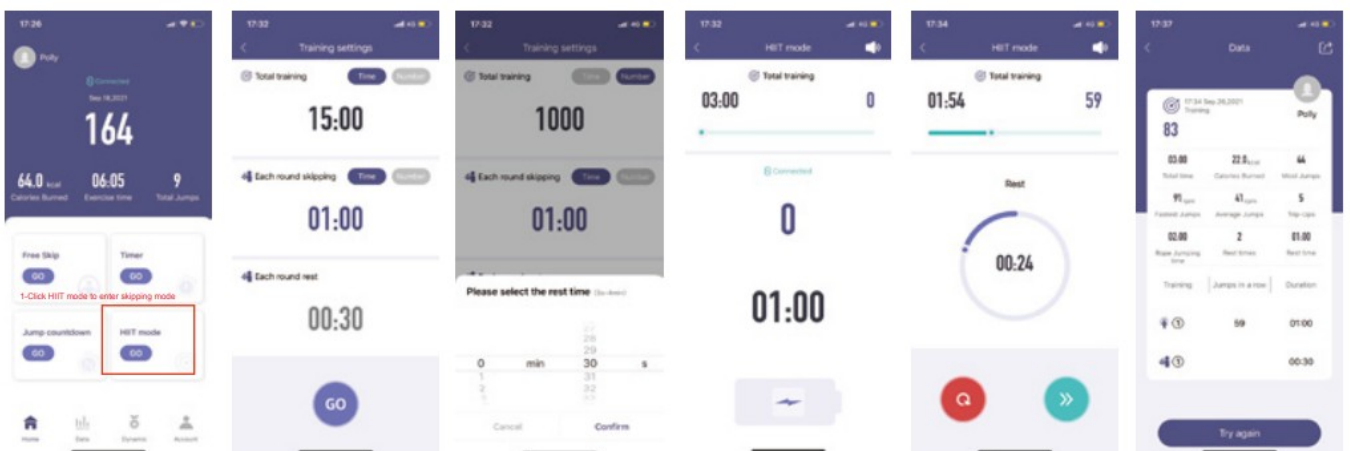

### Remarks:

HIIT mode is a training mode, please select suitable time and numbers setting according to your own body health status.

### Short ball Skipping



For skipping beginners, or in order to avoid sound noise using rope for skipping, you can use short ball instead of rope for skipping.

Calorie burning: Skipping 10 min = Running 30min;

## Other App functions

1 & 2: Voice reporting function:

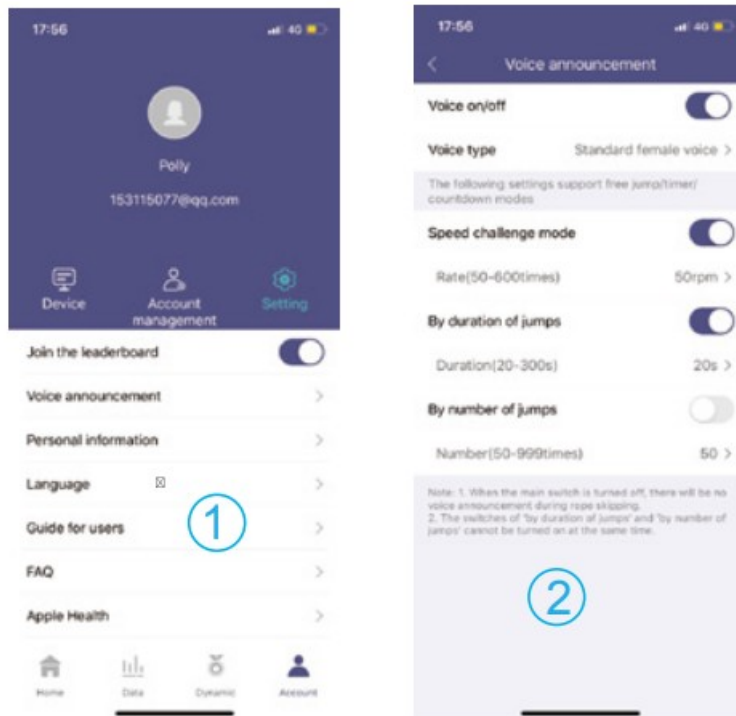

3: Medal Wall function

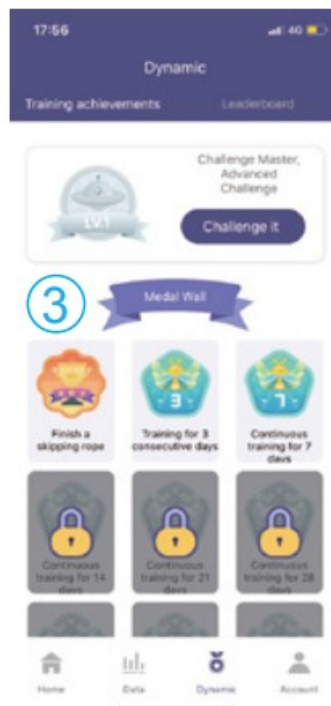

4 & 5: Challenge function

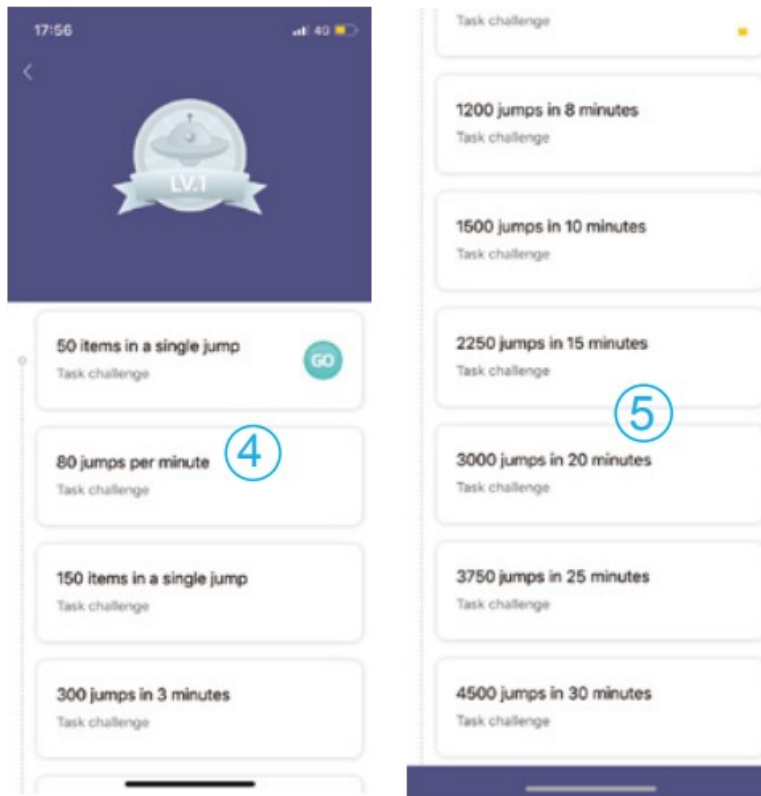

6: Ranking function

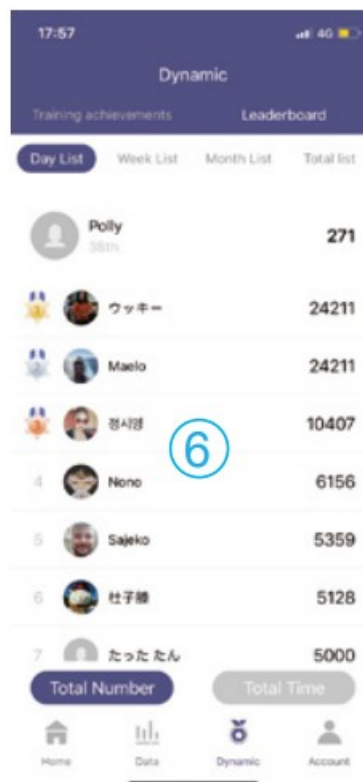

Remarks: More interesting functions for the Skipjoy will come soon.

## Offline storage function

Without the running of App, the data of your jumping will be recorded temporarily by the rope and synchronized with the App after re-connection.

### Reset the rope

Press the button on the back of the LCD display for 8 seconds, the rope will be reset. The LCD will show all the signals for 2 seconds and then shut down.

Press the button again to enter the normal use.

## Caution and Maintenance

- Do not put the rope in very wet or hot environment.
- Avoid hitting or dropping the rope violently, otherwise damage may occur.
- Treat the rope with care as it is an electronic instrument.
- Do not immerse the handle into water or use it while raining, because it is not water-proof and damage may occur to the built-in electronic device.
- The rope is only used for the purpose of physical exercise. Do not use it for other purposes.
- Be careful when using the rope to avoid any injuries, and children under 10 are suggested to use the rope under the watch of parents.

## Battery and replacing

Battery: The rope has 2\*AAA batteries which could sustain normal use of about 35 days (calculated based on a daily use of 15 minutes, actual using time varies according to the environment and time of use). The typical stand-by time is 33 days (experimental data of the manufacturer under the temperature 25 °C and humidity 65%RH).

Battery replacing: If "Lo" appears on the display, the batteries are too weak and need to be replaced. You require 2x 1.5 V batteries, AAA type.

### Tips for battery:

- For the better life span of the batteries, do not leave the rope with batteries for a long time. Keep the batteries out of reach of children.
- When you do not use the rope for a long time, it is suggested to take out the batteries.
- Do not mix old and new batteries, with different compositions or of different brands in order to prevent possible leakage explosion.
- Do not heat or deform the batteries or expose to fire.
- Waste batteries should not be disposed of with household waste.
- Please check with your local authority for battery recycling advice.



Waste electrical products should not be disposed of with household waste. Please recycle



where facilities exist. Check with your local Authority or retailer for recycling advice.

**NOTE:** This equipment has been tested and found to comply with the limits for a Class B digital device, pursuant to part 15 of the FCC Rules. These limits are designed to provide reasonable protection against harmful interference in a residential installation. This equipment generates uses and can radiate radio frequency energy and, if not installed and used in accordance with the instructions, may cause harmful interference to radio communications. However, there is no guarantee that interference will not occur in a particular installation. If this equipment does cause harmful interference to radio or television reception, which can be determined by turning the equipment off and on, the user is encouraged to try to correct the interference by one or more of the following measures:

- Reorient or relocate the receiving antenna.
  - Increase the separation between the equipment and receiver.
  - Connect the equipment into an outlet on a circuit different from that to which the receiver is connected.
  - Consult the dealer or an experienced radio/TV technician for help
- Changes or modifications not expressly approved by the party responsible for compliance could void the user's authority to operate the equipment. This device complies with Part 15 of the FCC Rules. Operation is subject to the following two conditions:

1. this device may not cause harmful interference, and
2. this device must accept any interference received, including interference that may cause undesired operation.

FCC ID: 2AP3Q-RS2047LB



## Warranty

If you have any issue about the product, please feel free to contact us by sending email to [supportus@comfier.com](mailto:supportus@comfier.com). We will strive to provide the best service possible within 24 hours.

### **30 days unconditionally return**

Comfier product can be returned to receive a full refund for any reason within 30 days. Please contact our customers service ([supportus@comfier.com](mailto:supportus@comfier.com)), our staff will contact you within 24 hours.

### **90 days return/replace**

Comfier product can be returned / replaced within 90 days if the product break down in the period of proper use.

### **12 months Warranty**

If the product breaks down within 12 months in the period of proper use, customers can still seek for the relevant product warranty to get it replaced.

### **Attention!**

No warranty will be given to any force majeure or man-made causes for a defective product, such as improper care, personal tear down and willful damage, etc.

## Extend Warranty for Free

1) Enter the following URL or scan the QR code below to find COMFIER facebook page and like it, enter "Warranty" to messenger to extend your warranty from 1 year to 3 years.



<https://www.facebook.com/comfiermassager>

OR 2) Send message "Warranty" and email us [supportus@comfier.com](mailto:supportus@comfier.com) to extend your warranty from 1 year to 3 years.

COMFIER TECHNOLOGY CO.,LTD.

Address:573 BELLEVUE RD

NEWARK, DE 19713 USA

[www.facebook.com/comfiermassager](https://www.facebook.com/comfiermassager)

[supportus@comfier.com](mailto:supportus@comfier.com)

[www.comfier.com](http://www.comfier.com)



Tel: (248) 819-2623

Monday-Friday 9:00AM-4:30PM

## Documents / Resources



[COMFIER JR-2201 Smart Skipping Rope](#) [pdf] User Manual  
JR-2201, Smart Skipping Rope, JR-2201 Smart Skipping Rope, Skipping Rope, Rope

[Manuals+.](#)