

BROTHER PT-D410 ADVANCED LABEL MAKER



# Brother PT-D410 Advanced Label Maker User Manual

[Home](#) » [Brother](#) » Brother PT-D410 Advanced Label Maker User Manual 

## Contents

- [1 Brother PT-D410 Advanced Label Maker](#)
- [2 PT-D410](#)
- [3 Product Safety Guide](#)
- [4 Before Use](#)
- [5 Use the Label Maker](#)
  - [5.1 Print from Your Computer](#)
  - [5.2 Application Installation](#)
- [6 Basic Operations](#)
- [7 Symbols and Frames](#)
- [8 Error Messages](#)
- [9 Troubleshooting](#)
- [10 Contact Information](#)
- [11 Frequently Asked Questions](#)
- [12 Video- Product Overview](#)
- [13 References](#)
- [14 Related Posts](#)



**Brother PT-D410 Advanced Label Maker**

**ORGANIZING  
MADE EASY!**



## PT-D410

Thank you for purchasing the PT-D410 (hereafter referred to as “the Label Maker”). Your PT-D410 produces professional, high-quality, durable labels. In addition, the variety of tape cartridges available allows you to print labels with different widths and exciting colors.

Please read this guide, including the Product Safety Guide, before using this Label Maker. After reading this guide, keep it in a safe place.



D02BAV001

For FAQs, troubleshooting, and to download software and manuals, visit [support.brother.com](http://support.brother.com).

## Supplies

Brother TZe Tape Cassette	Available widths: 3.5 mm, 6 mm, 9 mm, 12 mm, 18 mm
Head Cleaning Tape Cassette	TZe-CL4

## Product Safety Guide

## Safety Precautions

Be sure to read this section before using the product. It contains important safety instructions. We recommend that you keep this document nearby for future reference.

- For servicing, adjustments, or repairs, contact Brother Customer Service or your local Brother dealer.
- If the product operates abnormally or any error occurs, or if any cable is damaged, turn off the product, disconnect all cables, and contact Brother Customer Service or your local Brother dealer.
- We assume no responsibility for damages arising from earthquakes, fire, other disasters, actions of third parties, the user's intentional or negligent operation, misuse, or operation under other special conditions.
- We assume no responsibility for damage (such as losses, loss of business profit, lost profits, business disruptions, or a lost means of communication) that may result from the use of, or inability to use, the product.
- We assume no responsibility for damages that may result from incorrect operation of the product by connecting incompatible equipment or using incompatible software.
- We assume no responsibility for any damages or lost profit arising from the use of labels created with this product, the disappearance or change of data due to failure, repair, or consumables and we do not accept any claim from a third party.
- Brother reserves the right to make changes without notice in the specifications and materials contained herein. Furthermore, Brother shall not be responsible for any damages (including consequential) caused by reliance on the materials presented, including but not limited to typographical and other errors relating to the publications.
- For more information about the available software, see the User's Guide on the Brother support website at [support.brother.com](https://support.brother.com).
- The latest version of your product documentation is available on the Brother support website at [support.brother.com](https://support.brother.com).
- The available models, accessories, and supplies may vary depending on the country or region.
- This product is approved for use in the country or region of purchase only.

**WARNING** Failure to observe instructions and warnings could result in death or serious injuries.

- DO NOT operate, charge, or store the Label Maker, AC Adapter, USB Cable, and Alkaline Batteries in the following locations (otherwise a fire, electrical shock, smoke, or damage may occur):
  - Near water, such as in a bathroom or near a water heater, or in an extremely humid or cold location.\*
  - In a location where it is exposed to rain or moisture.
  - In an extremely dusty location.
  - In an extremely hot location, such as near open flames, heaters, or in direct sunlight.
  - In a closed car in direct sunlight.
  - In a location where condensation may form.
  - At a high altitude.
  - During a thunderstorm.
- DO NOT use the Label Maker with a foreign object in it. If water, a metal object, or any other foreign object enters the Label Maker, disconnect the AC Adapter and remove the batteries (if installed), and then contact your local Brother dealer for repairs.
- If foreign objects are inserted into the Label Maker or its slots, connectors, ports, or Battery Compartment, stop using the Label Maker, turn off the power, and then disconnect each cable or remove the batteries (if installed).

- Stop using the Label Maker if there are noticeable abnormalities such as smell, heat, noise, deformities, or discoloration.
- DO NOT use a damaged AC Adapter.
- To avoid damaging the Label Maker, AC Adapter, USB Cable, or Alkaline Batteries, DO NOT:
  - Place heavy objects on them.
  - Dissamble or modify them.
  - Drop or hit them.
  - Allow them to get wet, for example, by handling them with wet hands or spilling liquids on them.
- DO NOT allow babies and children to play with the plastic bag that contained the Label Maker.
  - Dispose of the bag or keep it away from babies and children. There is a risk of suffocation.
  - \* For more information, see the “Specifications” section in your model’s User’s Guide.
- DO NOT forcibly bend or pull the USB Cable or AC Adapter.
- DO NOT touch the AC Adapter or plug with wet hands, otherwise an electrical shock may occur.
- Use only the specified AC Adapter.
- Use only the AC Adapter and USB Cable included with your Label Maker. Failure to do so may result in an injury to yourself or others, or damage to the Label Maker, or other property. Brother does not assume any responsibility for any accident or damage resulting from not using the specified AC Adapter and USB Cable.
- DO NOT connect the included AC Adapter and USB Cable to other products.
- Use the AC Adapter with standard electrical sockets (AC 100 V – 240 V 50/60 Hz).
- Insert the plug firmly into the electrical outlet.
- DO NOT use the batteries if they are damaged or leaking.
- Keep batteries away from infants. If batteries are ingested, contact emergency services immediately.
- DO NOT use sharp objects, such as tweezers or a metallic pen, to remove or replace batteries.
- If liquid (electrolyte) from the batteries gets into eyes, wash them immediately with clean water. Contact emergency services immediately.
- DO NOT solder connections to the batteries.
- DO NOT use the batteries with the polarity (+) (-) reversed.
- DO NOT connect the + and – terminals with metal objects such as wire.
- DO NOT incinerate the batteries or dispose of them with household waste.
- Keep fingers and other body parts away from the Cutter unit.
- DO NOT touch the Cutter unit’s blade or insert your fingers inside the
- Tape Exit Slot, otherwise fingers and other body parts may be injured.
- DO NOT touch any metal parts near the Print Head. The Print Head becomes very hot during and immediately after use. DO NOT touch it directly with your hands.

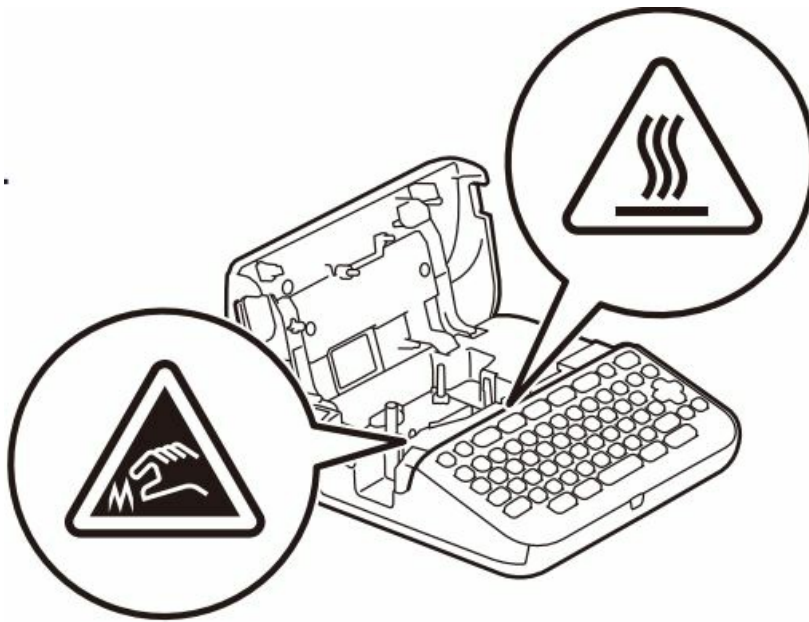

**CAUTION** Failure to observe instructions and warnings could result in minor or moderate injuries. Label Maker, USB Cable, AC Adapter, Alkaline Batteries

- Use only the specified AA alkaline batteries (LR6).
- DO NOT use combinations of old and new batteries or combinations of different types, charging levels, manufacturers, or models.
- DO NOT drop the Label Maker when removing it from the box or relocating it, otherwise you may get injured.
- Be careful when closing the Tape Cassette Compartment Cover. There is a risk of injury if your finger gets pinched between the upper and lower parts of the cover.
- When you are not using the Label Maker, store it out of the reach of children. In addition, do not allow children to put the Label Maker parts or labels in their mouths. If any object has been swallowed, seek medical attention immediately.
- DO NOT leave the Label Maker or any tape within the reach of babies and children.
- Store the Label Maker on a flat, level, and stable surface.
- Remove the batteries and disconnect the AC Adapter if you do not intend to use the printer for an extended period of time.
- DO NOT press on the Liquid Crystal Display (LCD).
- When disconnecting the AC Adapter from the electrical outlet, always hold the AC Adapter.
- DO NOT overload an electrical circuit with the AC Adapter.
- DO NOT open the Tape Cassette Compartment Cover when operating the Cutter unit.
- DO NOT apply excessive pressure to the Cutter unit.

## Before Use

### LCD and Keyboard

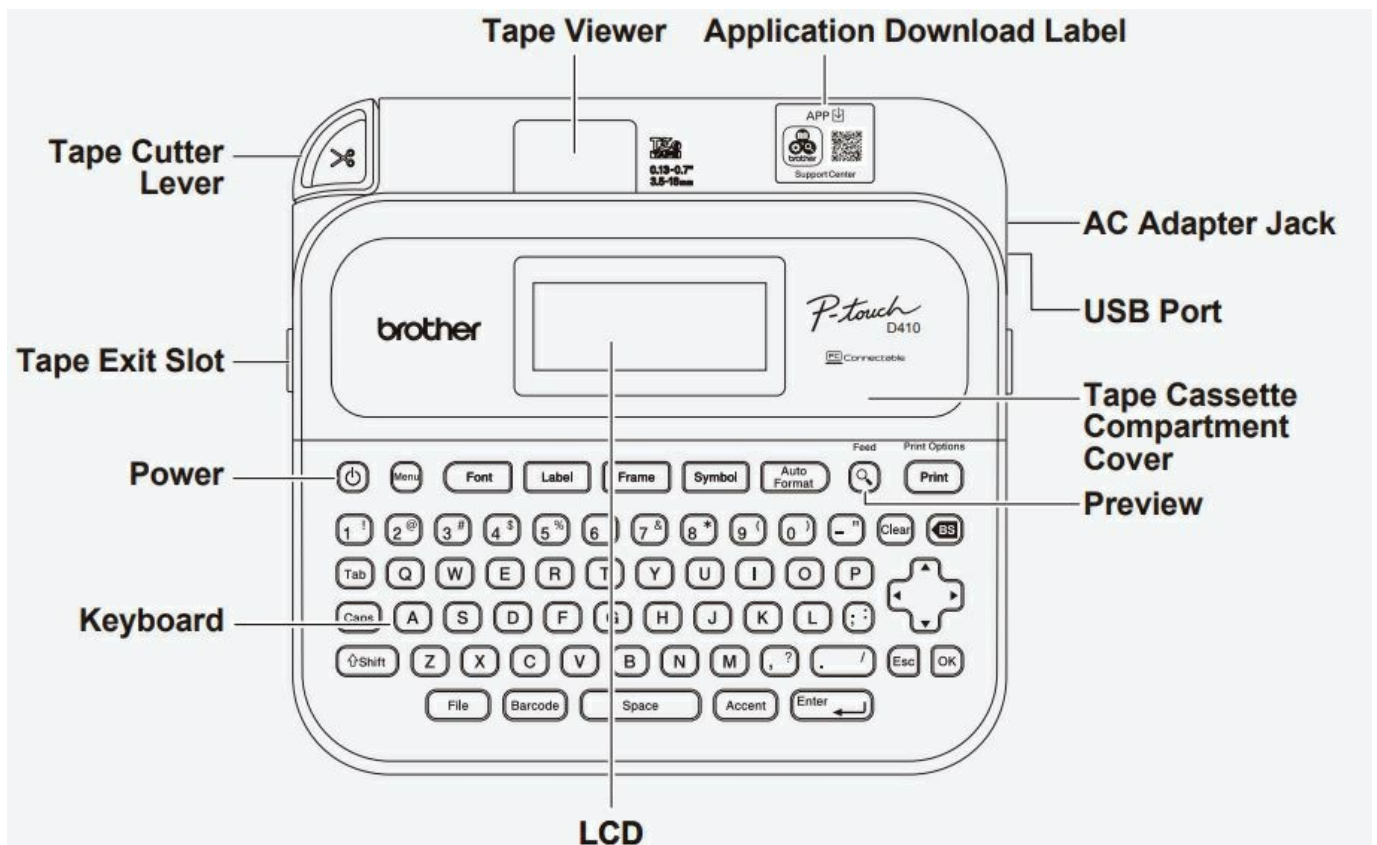

- 1. Caps mode
- 2-4. Font Style Icons
- 5. Label Length
- 6. Block number
- 7. Line number
- 8. Cursor
- 9. Return mark

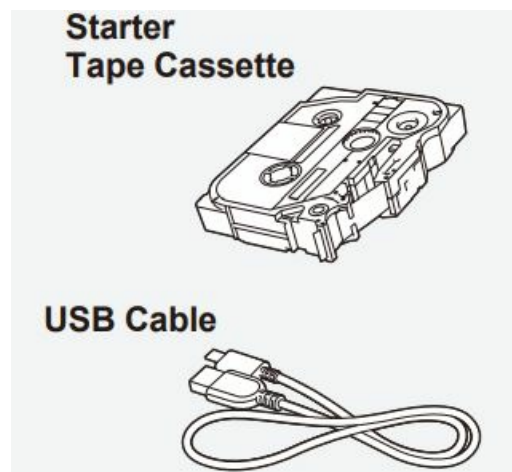

LCD

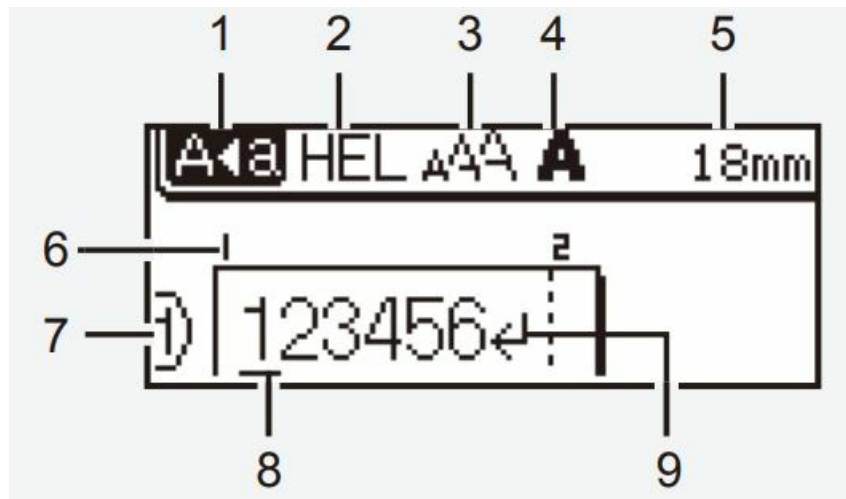

The components included in the box may differ depending on your country or region.

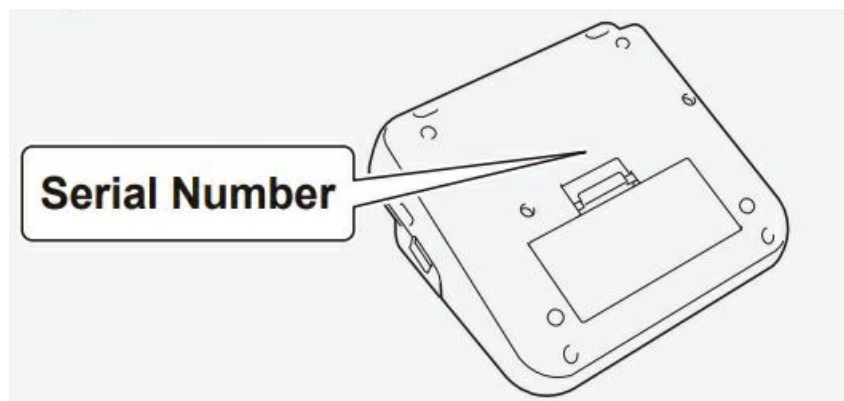

### Install Batteries or Connect the AC Adapter

Remove the protective material (first use only) before using the Label Maker.

#### Batteries

- When using the AC Adapter (AD-E001A):
  - Insert the Adapter cord plug into the AC Adapter Jack on the side of the printer.
  - Insert the plug into the nearest standard electrical outlet. For memory backup, we recommend using AA alkaline batteries (LR6) together with the AC Adapter.
- To safeguard and back up the Label Maker's memory, when the AC Adapter is unplugged, keep AA alkaline batteries (LR6) installed in the Label Maker.
- When power is disconnected for more than two minutes, all text and format settings will be cleared. Any text files stored in the memory will also be cleared.
- Remove the batteries if you do not intend to use the Label Maker for an extended period of time.
- Dispose of the batteries at an appropriate collection point, not in the general waste stream. In addition, be sure to observe all applicable federal, state, and local regulations.

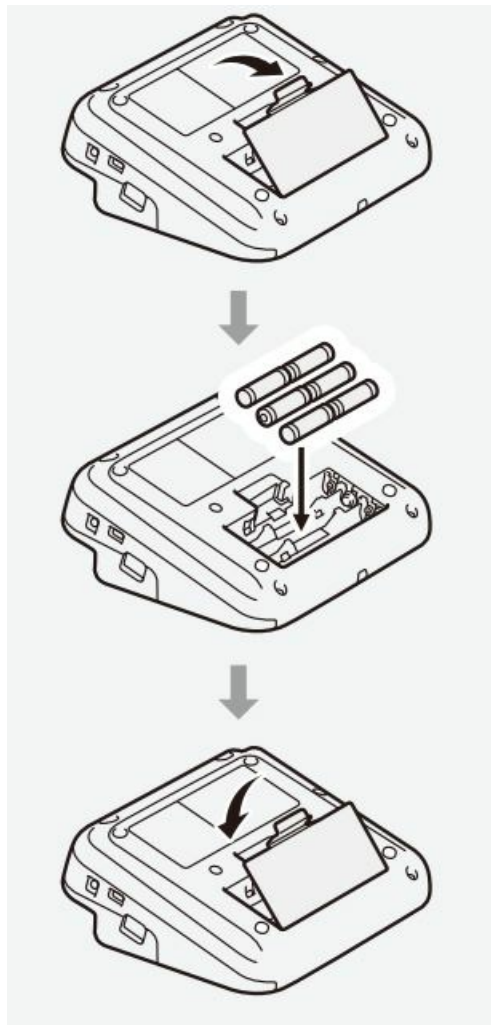

### AC Adapter

- When storing or discarding the batteries, wrap them (for example with cellophane tape), to prevent them from short-circuiting.

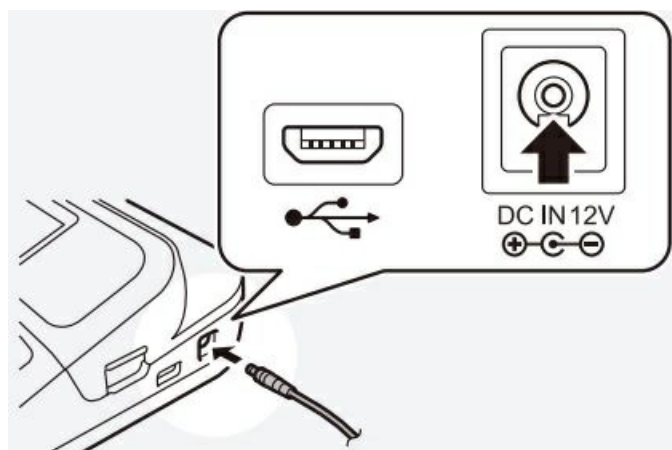

### (Battery insulation example)

1. Cellophane tape
2. Alkaline battery



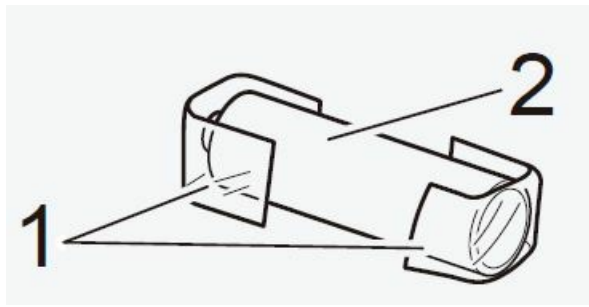

### Insert the Tape Cassette

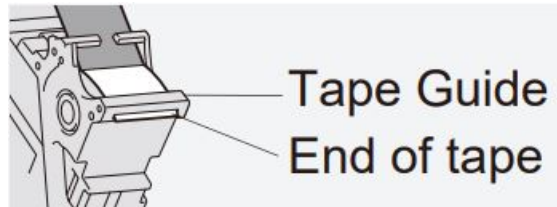

- After the tape passes under the Tape Guide, pull the tip to remove any slack in the tape.
- Make sure the tape is not caught in the Label Maker when inserting or removing the Tape Cassette.

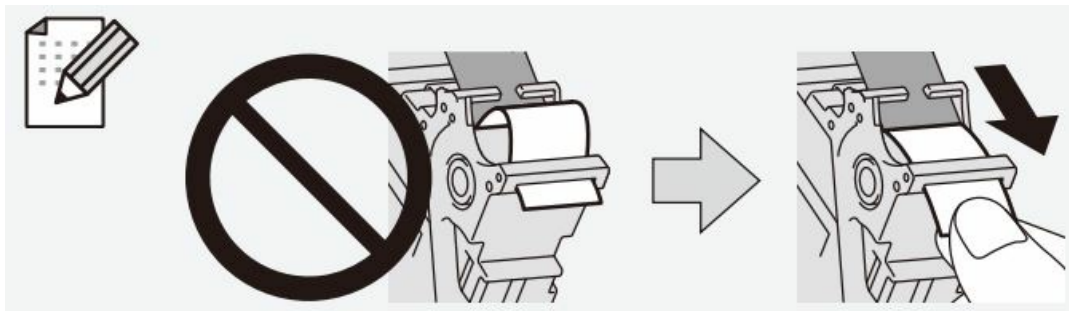

- Insert the Tape Cassette following the illustration under the Tape Cassette Compartment Cover. Confirm that the tip of the tape is pointed at the Tape Exit Slot.
- Press the Tape Cassette into the Label Maker until it locks into place and then close the Tape Cassette Compartment Cover.

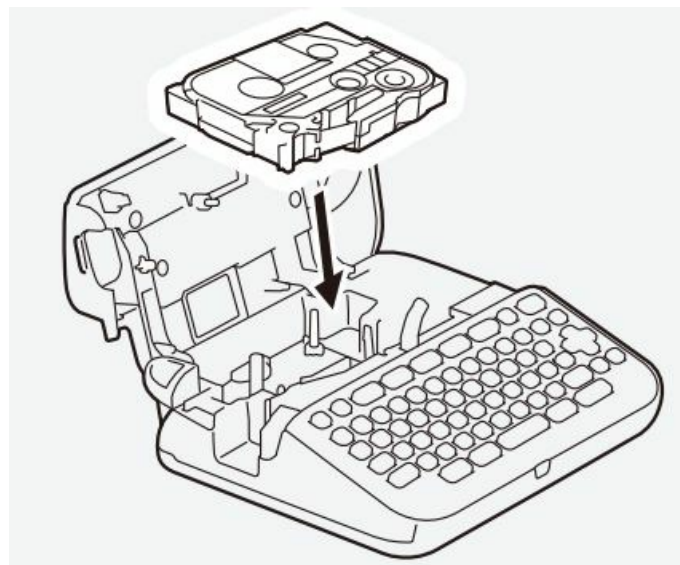

### Turn the Power ON or OFF

- **Power on:** Press



- **Power off:** Press and hold until the Label Maker turns off.
- **To print from the Label Maker, go to** Print from the Label Maker
- **To print from your computer, go to** Print from Your Computer



## Use the Label Maker

### Print from the Label Maker

- STEP 1 Enter Text
- STEP 2 Preview Labels
- STEP 3 Print Labels

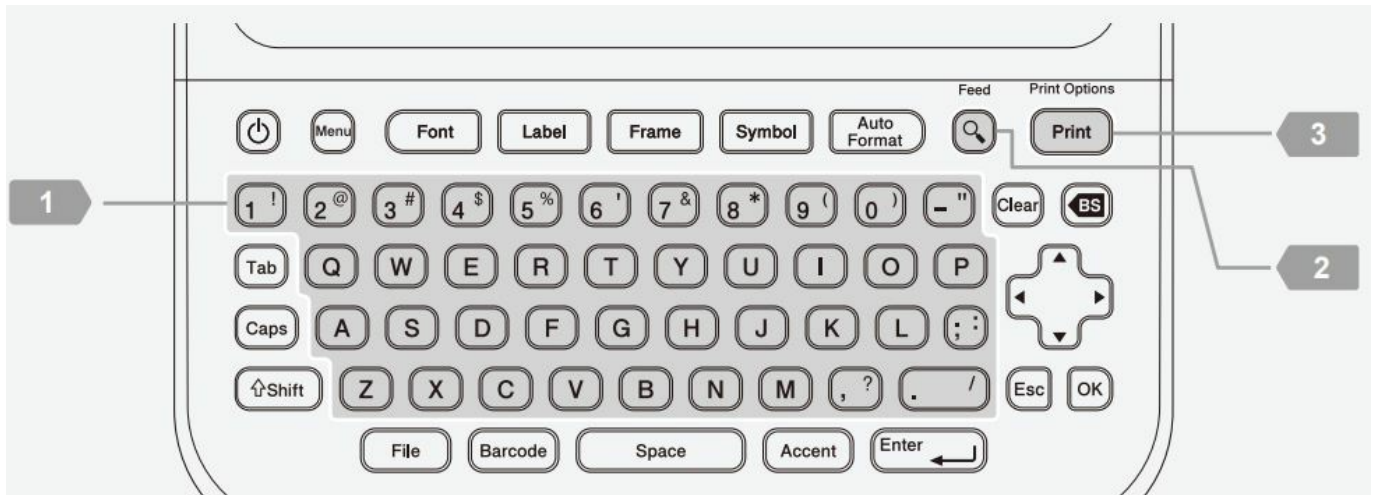

### Print from Your Computer



<http://install.brother>

## Windows

- In your browser's address bar, type [install.brother](http://install.brother). Download and install the Printer Driver and P-touch Editor by following the on-screen instructions.

## Mac



- Download P-touch Editor from the App Store to print from your
- Mac. You do not need to download and install any drivers.

<b>Printer Driver</b>	Software required to print from a Label Maker using a Windows computer.
<b>P-touch Editor</b>	Label creation software for computers. This application comes with built-in drawing tools that allow you to print a wide variety of custom labels in complex layouts with text of different fonts and styles, frames, imported images, barcodes, and more.

- When printing from your computer, you must connect the Label Maker and computer with the included USB Cable.
- This Label Maker does not support Wi-Fi connections.

## Application Installation



































- Download the applications from the App Store or Google Play™:

	<b>Support Center App</b>	This app provides access to setup information, product manuals, FAQs, and troubleshooting tips.	
-------------------------------------------------------------------------------------	---------------------------	-------------------------------------------------------------------------------------------------	---------------------------------------------------------------------------------------

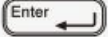





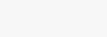







## Basic Operations





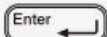

[support.brother.com/manuals](http://support.brother.com/manuals)

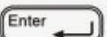



## Initial Settings

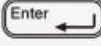



Language Settings		<p>Set your language.</p> <p> →  /   → [Language] →  / </p> <p>→   → Select a language →  / </p>
Unit Settings		<p>Set the unit for various types of adjustments.</p> <p> →  /   → [Unit] →  /  →</p> <p>  → [inch] / [mm] →  / </p>
LCD Contrast		<p>Adjust the LCD contrast.</p> <p> →  /   → [Adjustment] →  /</p> <p> →   → [LCD Contrast] →   →</p> <p>[-2] to [+2] →  / </p>





### Enter Text

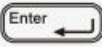

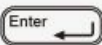



New Line		<p>Press  to start a new line.</p> <p>Maximum number of lines for each tape width:</p> <p>18 mm: five lines  12 mm: three lines  9 mm, 6 mm: two lines  3.5 mm: one line</p>
Block	 + 	<p>Use this feature to include multiple lines or font sizes on a single label.</p> <p>Maximum: 5 blocks.</p>
Delete Text and Format	 or 	<p>Delete text and formatting.</p> <p>Delete one character at a time </p> <p>Delete all characters</p> <p> →   → [Text Only] →  / </p> <p>Delete all text and formatting.</p> <p> →   → [Text &amp; Format] →  /</p> <p></p>

Tab		Insert a tab. Maximum length: 100 mm
Tab Length		Set the tab length.  → ▼▲ → [Tab Length] → ◀▶ → Select a value →  / 
Upper-Case Lower-Case		Switch between upper-case and lower-case characters.





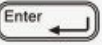































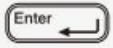

Label Length		Set the label length. <b>[Auto]</b> : Automatically adjusts the label length to the length of the text.  → ▼▲ → [Length] → ◀▶ → [Auto] / Set a value →  / 
--------------	-----------------------------------------------------------------------------------	---------------------------------------------------------------------------------------------------------------------------------------------------------------------------------------------------------------------------------------------------------------------------------------------------------------------------------------------------------------------------------------------------------------------

Symbol Characters		Inserts symbols, units, and pictures.  → ▼▲ → Select a category →  /  → ▼▲▶ → Select a symbol →  / 
-------------------	-------------------------------------------------------------------------------------	-------------------------------------------------------------------------------------------------------------------------------------------------------------------------------------------------------------------------------------------------------------------------------------------------------------------------------------------------------------------------------------------------------------------------------------------------------------------------------------------------------------------------------------------------

Accented Characters		Select text you wish to convert to accented characters. Enter characters →  → ◀▶ → Select an accent →  / 
---------------------	-------------------------------------------------------------------------------------	-------------------------------------------------------------------------------------------------------------------------------------------------------------------------------------------------------------------------------------------------------------------------------------------------------------------------------------------------------------------------

Frame		Select a decorative frame to add to your label.  → ▼▲ /  → Select a frame category →  /  → ▼▲▶ → Select a frame →  / 
-------	-------------------------------------------------------------------------------------	----------------------------------------------------------------------------------------------------------------------------------------------------------------------------------------------------------------------------------------------------------------------------------------------------------------------------------------------------------------------------------------------------------------------------------------------------------------------------------------------------------------------------------------------------------------------------------------------------------------------------------------------

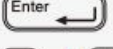
## Change Font

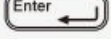
Change Font		<p>Change the label font, size, width, style, and alignment.</p> <p> →  /  →  → Select a font type →  → [Size] →  → Select the font height →  → [Width] →  → Select the font width →  → [Style] →  → Select the font style →  → [Align] →  → Select the font alignment →  / </p>
Change Font Line By Line	 + 	<p>Change the line font, size, width, style, and alignment.</p> <p> → Move the cursor to the line you want to change →  +  →  → [Font] →  → Select a font type →  → [Size] →  → Select the font height →  → [Width] →  → Select the font width →  → [Style] →  → Select the font style →  → [Align] →  → Select the font alignment →  / </p>
Auto Fit Style		<p>Automatically adjust the text size to fit the label length.</p> <p><b>[Text Size]:</b> Adjust to the length of the label.</p> <p><b>[Text Width]:</b> Adjust by condensing the character width by half.</p> <p> →  /  → [Auto Fit Style] →  /  →  → [Text Size] / [Text Width] →  / </p>











## Set Margins



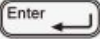

















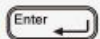































Set Margins	<div style="border: 1px solid black; border-radius: 5px; padding: 2px; display: inline-block;">Label</div>	<p>Set the margins before and after an entered character.</p> <p><b>[Small Margin]:</b> Initial margin is approx. 23 mm, and then 2 mm margins are inserted before and after the text of each label.</p> <p><b>[Large Margin]:</b> Insert an initial margin of approx. 25 mm is inserted before and after the text of each label.</p> <p><b>[Chain]:</b> Select this setting when printing multiple labels. The initial margin is approx. 23 mm, and then 2 mm margins are inserted before and after the text of each label.</p> <p><b>[No Cut]:</b> Select this setting when printing multiple parts or when printing on special tape.</p> <p><b>[Special Tape]:</b> Select this setting when printing on special tape.</p> <p><div style="border: 1px solid black; border-radius: 5px; padding: 2px; display: inline-block;">Label</div> → ▼▲ → [Cut Option] → ◀▶ → Select the margin type → <div style="border: 1px solid black; border-radius: 5px; padding: 2px; display: inline-block;">OK</div> / <div style="border: 1px solid black; border-radius: 5px; padding: 2px; display: inline-block;">Enter ↵</div></p>
-------------	------------------------------------------------------------------------------------------------------------	---------------------------------------------------------------------------------------------------------------------------------------------------------------------------------------------------------------------------------------------------------------------------------------------------------------------------------------------------------------------------------------------------------------------------------------------------------------------------------------------------------------------------------------------------------------------------------------------------------------------------------------------------------------------------------------------------------------------------------------------------------------------------------------------------------------------------------------------------------------------------------------------------------------------------------------------------------------------------------------------------------------------------------------------------------------------------------------------------------------------------

### Set Auto Format Layouts

Template	<div style="border: 1px solid black; border-radius: 5px; padding: 2px; display: inline-block;">Auto Format</div>	<p>Set specific template designs.</p> <p><div style="border: 1px solid black; border-radius: 5px; padding: 2px; display: inline-block;">Auto Format</div> → ▼▲ → [Templates] → <div style="border: 1px solid black; border-radius: 5px; padding: 2px; display: inline-block;">OK</div> / <div style="border: 1px solid black; border-radius: 5px; padding: 2px; display: inline-block;">Enter ↵</div></p> <p>→ ▼▲ → Select a template category → <div style="border: 1px solid black; border-radius: 5px; padding: 2px; display: inline-block;">OK</div> / <div style="border: 1px solid black; border-radius: 5px; padding: 2px; display: inline-block;">Enter ↵</div></p> <p><div style="border: 1px solid black; border-radius: 5px; padding: 2px; display: inline-block;">Enter ↵</div> → ▼▲ → Select a template → <div style="border: 1px solid black; border-radius: 5px; padding: 2px; display: inline-block;">OK</div> / <div style="border: 1px solid black; border-radius: 5px; padding: 2px; display: inline-block;">Enter ↵</div></p> <p><div style="border: 1px solid black; border-radius: 5px; padding: 2px; display: inline-block;">Enter ↵</div> → ▼▲ → [Font] → ◀▶ → Select a font type → ▼▲ → [Style] → ◀▶ → Select a style → <div style="border: 1px solid black; border-radius: 5px; padding: 2px; display: inline-block;">OK</div> / <div style="border: 1px solid black; border-radius: 5px; padding: 2px; display: inline-block;">Enter ↵</div> → Enter text → <div style="border: 1px solid black; border-radius: 5px; padding: 2px; display: inline-block;">OK</div> / <div style="border: 1px solid black; border-radius: 5px; padding: 2px; display: inline-block;">Enter ↵</div></p>
Block Layout	<div style="border: 1px solid black; border-radius: 5px; padding: 2px; display: inline-block;">Auto Format</div>	<p>Set Block Layout patterns.</p> <p><div style="border: 1px solid black; border-radius: 5px; padding: 2px; display: inline-block;">Auto Format</div> → ▼▲ → [Block Layouts] → <div style="border: 1px solid black; border-radius: 5px; padding: 2px; display: inline-block;">OK</div> / <div style="border: 1px solid black; border-radius: 5px; padding: 2px; display: inline-block;">Enter ↵</div></p> <p>→ ▼▲ → Select the tape width → <div style="border: 1px solid black; border-radius: 5px; padding: 2px; display: inline-block;">OK</div> / <div style="border: 1px solid black; border-radius: 5px; padding: 2px; display: inline-block;">Enter ↵</div></p> <p>→ ▼▲ → Select a block layout → <div style="border: 1px solid black; border-radius: 5px; padding: 2px; display: inline-block;">OK</div> / <div style="border: 1px solid black; border-radius: 5px; padding: 2px; display: inline-block;">Enter ↵</div> → ▼▲ → [Font] → ◀▶ → Select a font type → ▼▲ → [Align] → ◀▶ → [Left] / [Center] / [Right] / [Just]</p> <p>→ ▼▲ → [Frame] → ◀▶ → [On] / [Off] → <div style="border: 1px solid black; border-radius: 5px; padding: 2px; display: inline-block;">OK</div> / <div style="border: 1px solid black; border-radius: 5px; padding: 2px; display: inline-block;">Enter ↵</div> → Enter text → <div style="border: 1px solid black; border-radius: 5px; padding: 2px; display: inline-block;">OK</div> / <div style="border: 1px solid black; border-radius: 5px; padding: 2px; display: inline-block;">Enter ↵</div></p>























## Print Labels

Preview		Use this feature to preview the label before printing.
Print		<p>Start printing.</p> <p>When printing a single label:</p> <p> →  /  / </p> <p>When printing multiple labels:</p> <p> →   → Select a print quantity →  /  / </p>

Numbering Print		<p>Set this feature when printing consecutive alphanumeric characters.</p> <p>Enter alphanumeric characters →  +  →   → [Numbering] →  /  →   → Set the start position →  /  →   → Set the end position →  /  →   → Select a print quantity →  /  / </p>
Mirror Print		<p>Print reversed from left to right. Print on clear tape and attach it to the inside of glass to create a label that can be read from the outside.</p> <p>Enter text →  +  →   → [Mirror] →  /  →  /  / </p>
Barcode Printing		<p>Create a barcode and print it.</p> <p> →   → [Protocol] →   → Select a Protocol →   → [Width] →   → [Small] / [Large] →   → [Under#] →   → [On] / [Off] →  /  → Enter barcode data →  /  → [Print] →   → Select a print quantity →  /  / </p>

## Other



Tape Feed	 + 	<p>Feed approx. 23 mm of tape to remove any slack. Tape may have some slack when it is loaded.</p> <p> + </p>
Save		<p>Save your labels and access them later to edit and print them, as well as overwrite and save edited data. Maximum data: 50 files Maximum character count per file: 280 characters</p> <p>Create a label →  →  → [Save] →  /  →  → Select a save destination →  / </p>
Reset	 +  + 	<p>Reset the internal memory. For example, to reset the Label Maker or delete any saved label data.</p> <p>Turn off the machine. Press and hold down  and . While holding down  and , press  once and then release  and .</p>

For more information, see the User's Guide on the Brother support website at [support.brother.com](http://support.brother.com).

## Symbols and Frames

### Symbol Examples



### Auto Format Layouts Examples



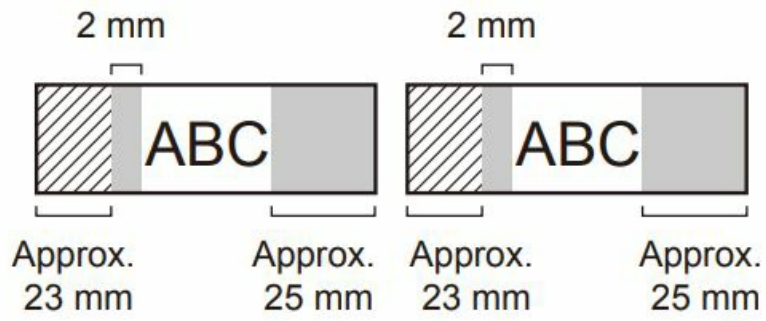

### Small Margin

When the label length is approx. 23 mm or more

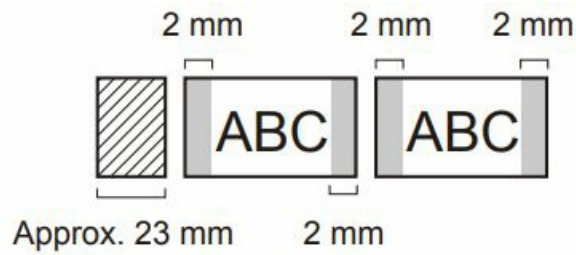

### Small Margin

When the label length is approx. 23 mm or less

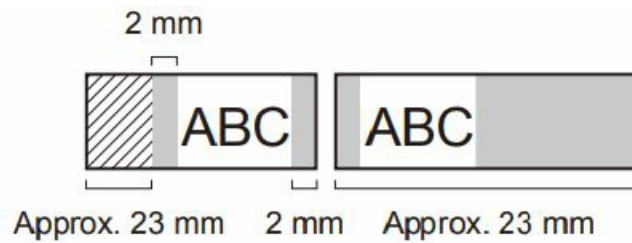

### Chain

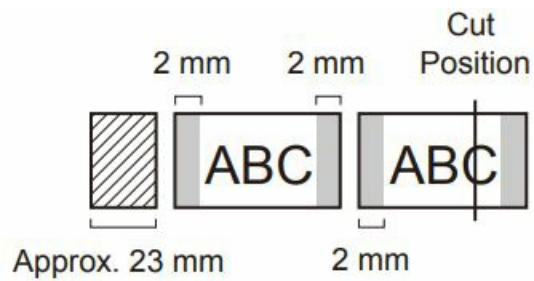

### No Cut

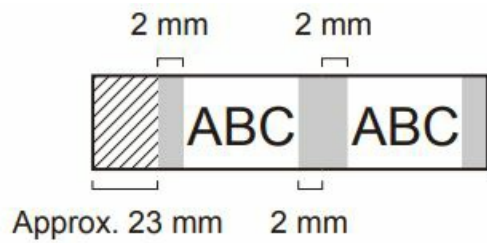

## Special Tape

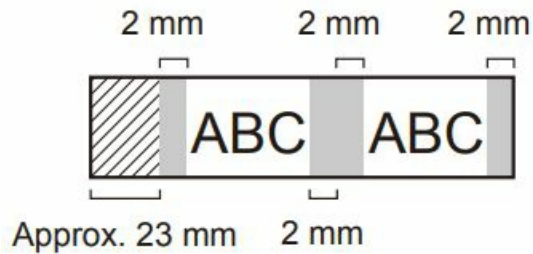

## Error Messages

Message	Cause/Remedy
Check no. of digits entered	The number of digits entered in the barcode data does not match the number of digits set in the barcode parameters. Enter the correct number of digits.
Cutter error	The Tape Cutter Lever was pressed while trying to print or feed the tape. If the tape is jammed in the Cutter unit, remove the tape. Turn the Label Maker off and then on again before continuing.
Length limit	The printed label length using the text entered is longer than 999 mm. Edit the text so that the label length is less than 999 mm.
Text too long	The printed label length using the text entered is longer than the length setting. Edit the text to fit within the set length or change the length setting.
System error XX	Contact Brother Customer Service.



## Troubleshooting





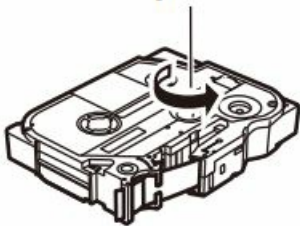

If you need additional help, visit [support.brother.com](https://support.brother.com).

Problem	Solution
The Label Maker does not print.	<ul style="list-style-type: none"> <li>• Check that the Tape Cassette is inserted correctly.</li> <li>• If the Tape Cassette is empty, replace it. To order supplies and accessories, visit <a href="http://www.brother-usa.com">www.brother-usa.com</a>.</li> <li>• Check that the Tape Cassette Compartment Cover is securely closed.</li> <li>• Check that the Label Maker is on.</li> <li>• Check that the correct printer driver is installed when printing from a computer.</li> <li>• Connect the Label Maker to your computer using the USB Cable (included) when printing from a computer.</li> <li>• If the Print Head is dirty, clean it with a cotton swab or with the optional Print Head Cleaning Cassette (TZe-CL4).</li> </ul>

Problem	Solution
<ul style="list-style-type: none"> <li>• The tape does not feed correctly.</li> <li>• The tape gets stuck inside the Label Maker.</li> </ul>	<ul style="list-style-type: none"> <li>• If the tape is bent, cut off the bent section.</li> <li>• If the tape is jammed, remove the Tape Cassette, remove the jammed tape, and then cut any damaged tape.</li> <li>• Check that the end of the tape exits through the Tape Guide.</li> <li>• Confirm that the tape is pointed at the Tape Exit Slot.</li> <li>• Remove the Tape Cassette and insert it again.</li> </ul>
The screen is locked, or the Label Maker does not operate normally.	Refer to the <b>Basic Operations</b> section in this guide and reset the Label Maker's internal memory to the factory settings. If resetting the Label Maker does not solve the problem, disconnect the AC Adapter and remove the batteries for more than 10 minutes.
The LCD remains blank after turning on the power.	Check that the batteries are correctly installed or that the AC Adapter included with your Label Maker is correctly connected.
The LCD messages are displayed in a foreign language.	Refer to the <b>Basic Operations</b> section in this guide to select your desired language.
The Label Maker stops while printing a label.	<ul style="list-style-type: none"> <li>• Replace the Tape Cassette if striped tape is visible, as this indicates that you have reached the end of the tape.</li> <li>• Replace all batteries or connect the AC Adapter directly to the Label Maker.</li> </ul>
Previously saved label files are not available.	All files saved in the internal memory are deleted if the batteries are weak or the AC Adapter is disconnected.

<ul style="list-style-type: none"> <li>• I cannot install the Printer Driver even if I follow the correct procedure.</li> <li>• I cannot see my printer listed in P-touch Editor even though I have installed the Printer Driver.</li> </ul>	<p>If you cannot use your Label Maker even though you have installed the Printer Driver:</p> <ol style="list-style-type: none"> <li>1. Download the Printer Driver Uninstaller from your model's page at <a href="http://support.brother.com">support.brother.com</a>.</li> <li>2. Use the Printer Driver Uninstaller to remove the printer information.</li> <li>3. Run the Printer Driver Installer again and follow the on-screen instructions to proceed with the installation.</li> </ol>
<p>The ink ribbon is separated from the ink roller.</p>	<p>If the ink ribbon is broken, replace the Tape Spool Cassette. If it is not, leave the tape uncut and carefully remove the Tape Cassette, and then wind the loose ink ribbon back onto the spool.</p> <p style="text-align: center;"><b>Spool</b></p> 

Problem	Solution
<p>Printed barcodes or QR codes cannot be read.</p>	<ul style="list-style-type: none"> <li>• Change the tape. (Recommended: Black on white tape)</li> <li>• Enlarge the barcodes or QR codes using the barcode application, if possible.</li> </ul>
<p>I do not know the firmware version of the Label Maker.</p>	<p>Confirm the firmware version by pressing the following keys:</p> <p style="text-align: center;">  → ▼▲ → [Version Information] →  /  </p> <p>[Version Information] /</p>

<p>When the label is printed, there is too much margin (space) on both sides of the text.</p>	<ul style="list-style-type: none"> <li>Refer to the <b>Set Margins</b> section in this guide and select [Small Margin] [Chain] or [No Cut] for smaller margins. When you set [Small Margin], the label maker feeds approx. 23 mm of leader tape before every new label.</li> </ul> <p>To save tape, set the [Chain] setting. After the last label prints, press</p> <p> and  to feed the tape, and then press the Tape Cutter Lever .</p> <ul style="list-style-type: none"> <li>The Label Maker feeds approx. 23 mm of tape before every new label. When printing multiple labels, you can reduce the blank space on the second and subsequent labels.</li> </ul> <p>Select the [Chain] setting in the optional print settings. Then, print your labels and leave the last label in the Label Maker until you are ready to print a new label.</p> <p> and </p> <ul style="list-style-type: none"> <li>After the last label prints, press  and  simultaneously to feed the tape, and then eject and cut the last label. Note that the Label Maker will feed approx. 23 mm of tape before the next new label when you use this method.</li> </ul>
<p>The font size cannot be increased.</p>	<p>The font is already the maximum size for the width of the label. Or, the label length has been set, so there is a limit on the font size to prevent exceeding the set length.</p>
<p>When multiple labels are printed, the last label is cut incorrectly.</p>	<p>When Chain Print is enabled, feed the tape to eject the last printed label, and then press the Tape Cutter Lever to cut the label manually.</p>

Problem	Solution
<p>I cannot update the printer's firmware using the P-touch Update Software, Transfer Express, or Mac Update Tool.</p>	<p>Restart the printer and then try to update the firmware again. Do not press any buttons during the firmware update.</p>

## Contact Information

Visit [www.brother.com](http://www.brother.com) for contact information on your local Brother office.

## Frequently Asked Questions

What is the Brother PT-D410 Advanced Label Maker?

The Brother PT-D410 Advanced Label Maker is a versatile labeling machine designed to create professional-looking labels for various applications.

How does the Brother PT-D410 Advanced Label Maker work?

The Brother PT-D410 Advanced Label Maker operates by printing text and designs on adhesive labels, offering a wide range of customization options.

What are the key features of the Brother PT-D410 Advanced Label Maker?

The Brother PT-D410 Advanced Label Maker features a QWERTY keyboard, one-touch keys for easy formatting, a graphical display, and the ability to print labels up to 18mm wide.

Can the Brother PT-D410 Advanced Label Maker connect to a computer?

Yes, the Brother PT-D410 Advanced Label Maker can connect to a computer via USB for seamless label design and printing.

Is the Brother PT-D410 Advanced Label Maker suitable for home or office use?

The Brother PT-D410 Advanced Label Maker is ideal for both home and office environments, offering efficient labeling solutions for various needs.

What type of labels can be used with the Brother PT-D410 Advanced Label Maker?

The Brother PT-D410 Advanced Label Maker is compatible with a range of TZe tape cassettes in different colors and sizes, providing flexibility in label creation.

Does the Brother PT-D410 Advanced Label Maker support different font styles and sizes?

Yes, the Brother PT-D410 Advanced Label Maker offers multiple font styles, sizes, and frames to customize labels according to individual preferences.

Can the Brother PT-D410 Advanced Label Maker print barcodes?

The Brother PT-D410 Advanced Label Maker has the capability to print barcodes, making it suitable for organizing inventory or creating asset tags.

Is it easy to navigate through the menu options on the Brother PT-D410 Advanced Label Maker?

With its intuitive interface and user-friendly design, navigating menu options on the Brother PT-D410 Advanced Label Maker is straightforward and simple.

Does the Brother PT-D410 Advanced Label Maker have a built-in memory for storing label designs?

Yes, the Brother PT-D410 Advanced Label Maker includes built-in memory that allows users to save frequently used label templates for quick access.

Can labels created with the Brother PT-D410 Advanced Label Maker withstand different environmental conditions?



Labels made with the Brother PT-D410 Advanced Label Maker are durable and resistant to water, fading, abrasion, and extreme temperatures, ensuring long-lasting quality.

Are there any accessories available for the Brother PT-D410 Advanced Label Maker?

Various accessories such as carrying cases, AC adapters, and additional tape cassettes are available to complement the functionality of the Brother PT-D410 Advanced Label Maker.

### Video- Product Overview



[Download the PDF User Manual for Brother PT-D410 Advanced Label Maker video.mp4](#)

### References

- [User Manual](#)

[Manuals+](#), [Privacy Policy](#)

This website is an independent publication and is neither affiliated with nor endorsed by any of the trademark owners. The "Bluetooth®" word mark and logos are registered trademarks owned by Bluetooth SIG, Inc. The "Wi-Fi®" word mark and logos are registered trademarks owned by the Wi-Fi Alliance. Any use of these marks on this website does not imply any affiliation with or endorsement.