

## TOTTE SY-KF630004US-01HDN-001

# TOTTE Smart Bidet Toilet Seat Instruction Manual

Model: SY-KF630004US-01HDN-001

## 1. INTRODUCTION

This manual provides detailed instructions for the installation, operation, and maintenance of your TOTTE Smart Bidet Toilet Seat. Please read this manual thoroughly before installation and use to ensure proper function and safety. Keep this manual for future reference.

The TOTTE Smart Bidet Toilet Seat offers advanced features including an auto open/close lid, heated seat, instant warm water, warm air dryer, remote control, and multiple wash modes, all designed for enhanced hygiene and comfort.

## 2. SAFETY INFORMATION

**WARNING: To reduce the risk of fire, electric shock, or injury, observe the following:**

- Do not allow the water supply hose to contact with the power plug, socket, or power cord.
- Avoid excessive condensation, leading to fire, electric shock, overheating, or short circuit.
- Do not sit on the lid for extended periods.
- Do not use in low temperature rooms.
- Do not set the toilet seat temperature to "off" during cold weather to prevent freezing. Follow the instructions in the manual and always disconnect the power supply.
- This may result in electric shock, fire, or injury.
- This appliance can be used by children aged 8 years and above and persons with reduced physical, sensory or mental capabilities or lack of experience and knowledge if they have been given supervision or instruction concerning use of the appliance in a safe way and understand the hazards involved. Children shall not play with the appliance. Cleaning and user maintenance shall not be made by children without supervision.

**Cleaning and Maintenance Requirements:**

- Do not use a dry cloth or tissue paper to wipe the unit.

- Do not use strong detergents, abrasive cleaners, or those containing benzene or alcohol on the bidet seat.
- Do not spray water directly onto the unit.
- If the cleaner may enter the water unit and cause malfunctions, close the water supply valve and clean the water inlet and filter.

### **3. PACKAGE CONTENTS**

Verify that all components are present before beginning installation:

- TOTTE Smart Bidet Toilet Seat
- Wireless Remote Control
- Mounting Plate
- 7/8" and 3/8" T-Valve
- Bolts and Nuts (2 sets)
- Stainless Steel Plates (2)
- Water Hose
- Stainless Steel Micro-Filter
- User Manual

# AUTOMATIC OPEN & CLOSE



*Image: All components included with the TOTTE Smart Bidet Toilet Seat.*

## 4. INSTALLATION GUIDE

Follow these steps to properly install your smart bidet toilet seat. Ensure the toilet is clean and dry before starting.

### 4.1 Confirm Toilet Size

Before installation, confirm your toilet dimensions match the bidet seat. The bidet seat is designed for elongated toilets. An electrical outlet must be available near the toilet.

# CONFIRM YOUR TOILET SIZE

Please Check the Size Data Carefully Before Purchasing!



We offer 7/8'' and 3/8'' American standard T-joints.

Image: Toilet size compatibility diagram.

## 4.2 Mounting the Seat

1. Remove your existing toilet seat.
2. Insert the black nuts into the toilet bowl holes.
3. Place the mounting plate over the nuts, ensuring it is centered.
4. Place the stainless steel plates over the mounting plate.
5. Insert and tighten the screws to secure the mounting plate.
6. Slide the bidet toilet seat onto the mounting plate until it clicks into place.

# Confirm Your Toilet Size

Please Check the Size Data Carefully Before Purchasing!

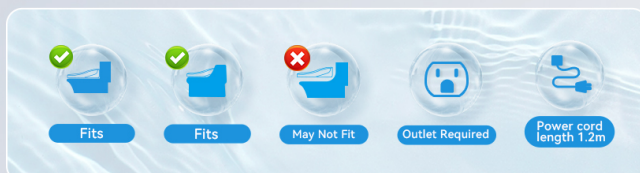

We offer 7/8'' and 3/8'' American standard T-joints.



Image: Visual guide for bidet seat installation steps.

### 4.3 Water Connection

1. Turn off the water supply to your toilet.
2. Disconnect the existing water supply hose from the toilet tank.
3. Install the provided T-valve between the toilet tank and the water supply line.
4. Cut the provided water hose to the appropriate length.
5. Connect one end of the water hose to the stainless steel micro-filter.
6. Connect the other end of the micro-filter to the bidet seat's water inlet.
7. Connect the remaining end of the water hose from the micro-filter to the T-valve.
8. Slowly turn on the water supply and check for leaks.



Image: Stainless steel micro-filter and water connection diagram.

### 4.4 Power Connection

Plug the bidet seat's power cord into a grounded electrical outlet. Ensure the outlet is within reach and is a standard 110V AC outlet.

### 4.5 Installation Video

Your browser does not support the video tag.

## 5. OPERATING INSTRUCTIONS

Your TOTTE Smart Bidet Toilet Seat can be operated using the wireless remote control or the side panel buttons.

### 5.1 Auto Open/Close Lid

The bidet seat features radar sensor technology. The lid will automatically open as you approach and close automatically after 120 seconds of inactivity, providing a hands-free experience.

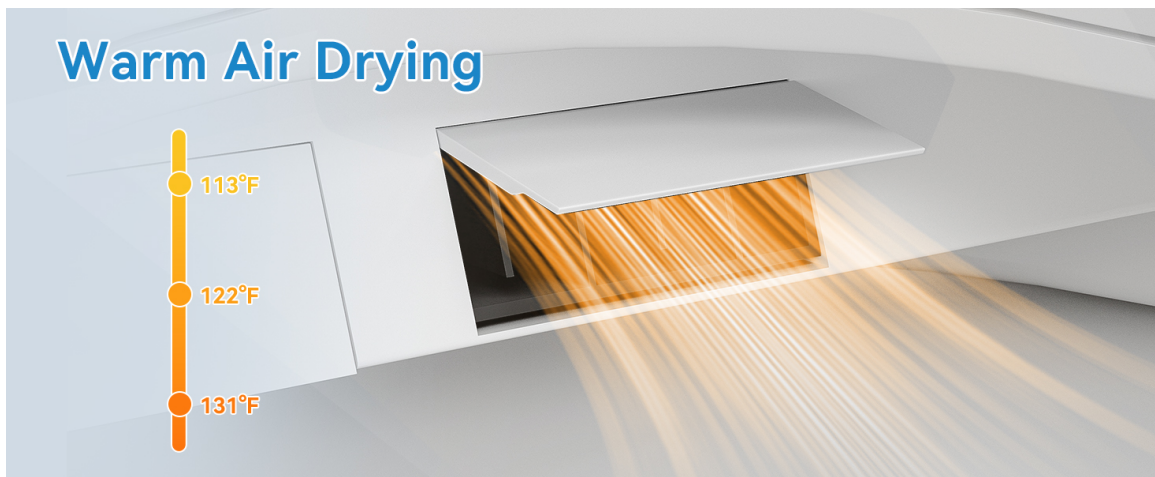

Image: Automatic lid opening and closing feature.

### 5.2 Remote Control Functions

The wireless remote control allows you to manage all features of the bidet seat. Ensure the remote is kept in a convenient location.

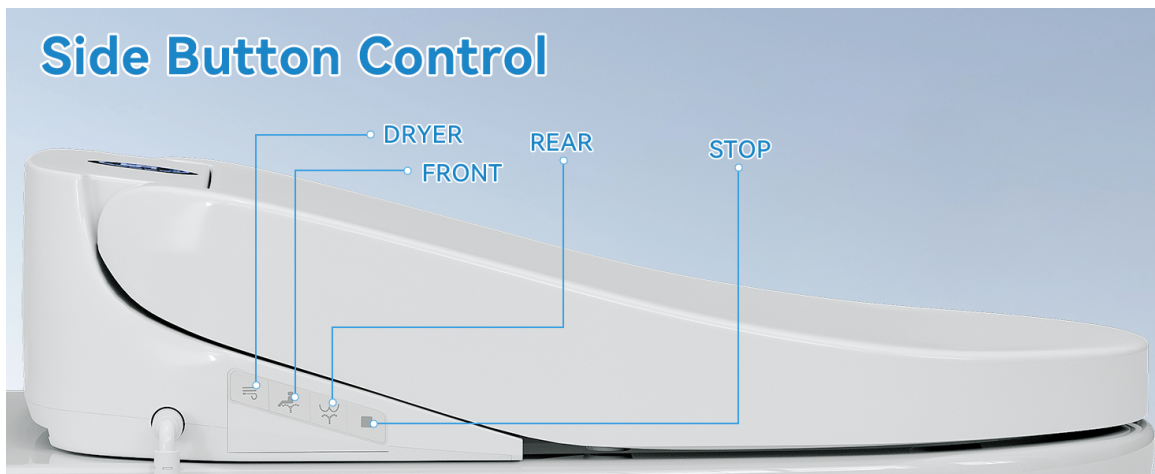

Image: Wireless remote control layout and functions.

Your browser does not support the video tag.

Video: Demonstration of the remote control functions for the bidet seat.

### 5.3 Side Button Control

For basic operations, buttons are located on the side panel of the bidet seat.

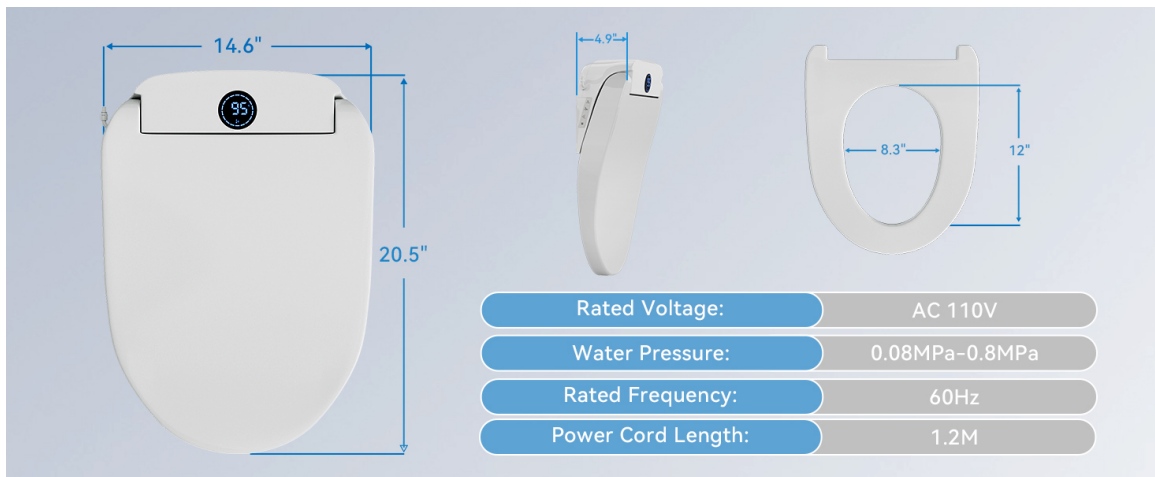

*Image: Side button controls for dryer, front wash, rear wash, and stop.*

## 5.4 Wash Modes

The bidet seat offers a comprehensive wash system with various modes:

- **Posterior Wash:** Standard rear cleansing.
- **Feminine Wash:** Gentle front cleansing.
- **Oscillating Wash:** Nozzle moves back and forth for wider coverage.
- **Water Massage:** Alternating water pressure for a soothing experience.
- **Gentle Wash:** Suitable for children or sensitive users.
- **SPA Mode:** Alternating hot and cold water wash.

## Instant Hot Water

Unlimited hot water supply and constant temperature washing

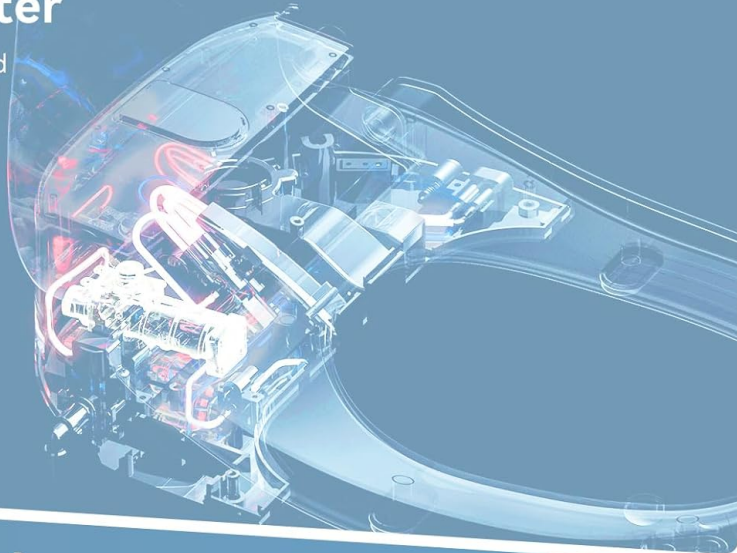

## 5 Cleaning Modes

SPA: Alternating hot and cold water wash



Image: Instant hot water feature and different cleaning modes.

### 5.5 Heated Seat & Warm Air Dryer

Enjoy comfort with the heated seat, adjustable to multiple temperature levels (90°F, 97°F, 104°F). After washing, the warm air dryer provides a hands-free drying experience, also with adjustable temperatures (113°F, 122°F, 131°F).



Image: Heated seat and warm air drying temperature settings.

## 5 Reasons to Choose TOTTE Bidet Seat



- Ⓐ Automatic lid opening/closing
- Ⓒ No Filter Replacement Required
- Ⓓ Upgraded Instant Heating Tech
- Ⓔ Various Wash modes
- Ⓕ Energy Saving Mode

VS

- Manual lid opening/closing
- Frequent Filter Replacement
- Unstable Water Temperature
- Single Cleaning Method

Others

Ours

Image: Ergonomically designed heated seat with 3-speed adjustment.

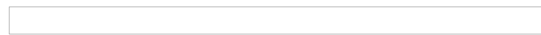

Image: Warm air drying feature with adjustable temperature levels.

### 5.6 Night Light & ECO Mode

A soft-glowing LED night light illuminates the bowl for easy navigation in the dark. Activate ECO mode to conserve energy by reducing power consumption during periods of inactivity.



*Image: Night light and other smart features.*

## 5.7 Functional Video

Your browser does not support the video tag.

*Video: Overview of the TOTTE Smart Bidet Toilet Seat's various functions.*

## 6. MAINTENANCE

### 6.1 Nozzle Cleaning

The bidet features self-cleaning nozzles that activate before and after each use to ensure hygiene. For additional cleaning, use the remote control to extend the nozzle and gently wipe with a soft cloth and mild detergent.

### 6.2 Stainless Steel Micro-Filter

The built-in stainless steel micro-filter effectively traps sediment and impurities from the water. This filter is permanent and does not require replacement. Periodically inspect the filter for any visible debris and clean if necessary by flushing with water.

### 6.3 General Cleaning

Wipe the exterior of the bidet seat with a soft, damp cloth and a mild, non-abrasive cleaner. Avoid using harsh chemicals or abrasive materials that could damage the surface.

## 7. TROUBLESHOOTING

- **No water spray:** Ensure the water supply valve is fully open and the filter is not clogged. Check if the power is connected and the unit is turned on.
- **Nozzle not extending:** Verify that the body sensor is activated (if applicable) and that a wash mode has been selected on the remote or side panel.
- **Heated seat not working:** Check the seat temperature setting on the remote control. Ensure the power is connected.
- **Lid not auto opening/closing:** Ensure the radar sensor is clean and unobstructed. Check power connection.
- **Water leakage:** Turn off the water supply immediately. Check all connections for tightness. If leakage persists, contact customer support.

## 8. SPECIFICATIONS

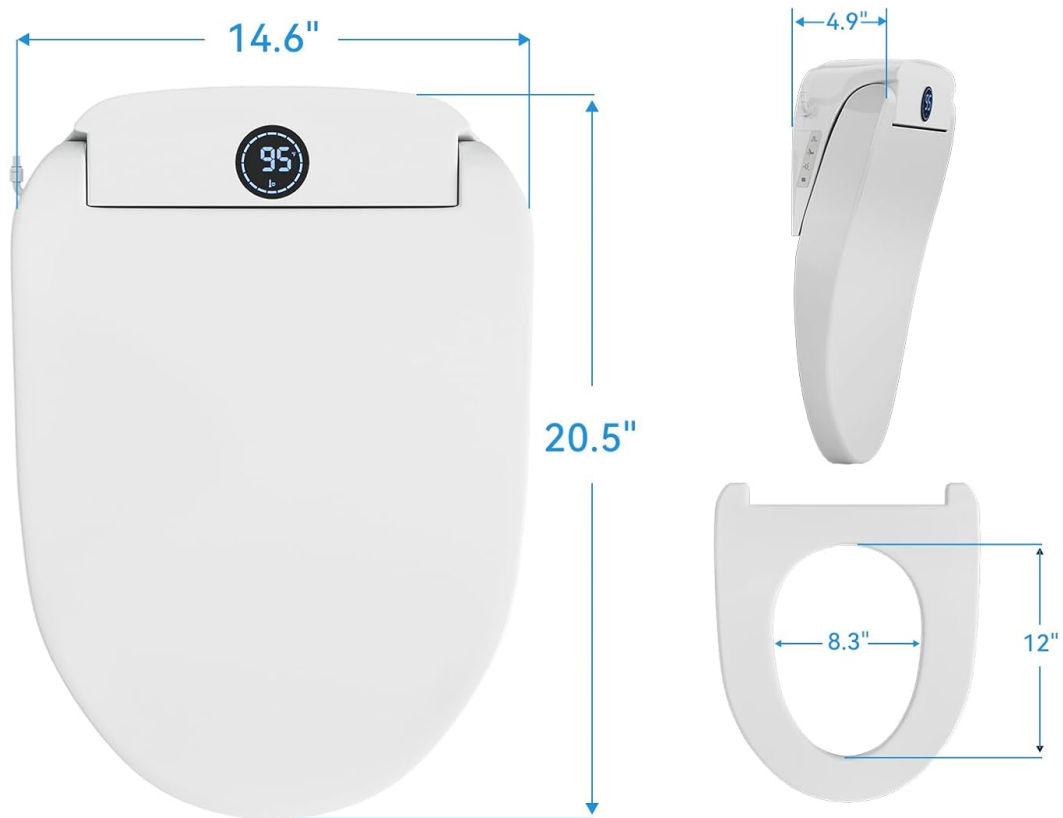

Rated Voltage:

AC 110V

Water Pressure:

0.08MPa-0.8MPa

Rated Frequency:

60Hz

Power Cord Length:

1.2M

*Image: Product dimensions and electrical specifications.*

Feature	Specification
Model Number	SY-KF630004US-01HDN-001
Color	White
Style	Elongated
Material	Polypropylene (PP)
Product Dimensions	20.5"L x 14.6"W
Item Weight	10.73 pounds (4.88 Kilograms)
Rated Voltage	AC 110V
Rated Frequency	60Hz
Water Pressure	0.08MPa-0.8MPa
Power Cord Length	1.2M

## 9. WARRANTY AND SUPPORT

TOTTE products are manufactured with high-quality materials and undergo strict quality control. For warranty information, technical support, or any questions regarding your product, please refer to the contact information provided on the product packaging or the official TOTTE website.

© 2025 TOTTE. All rights reserved.