



[Manuals.plus](#) /

> [Aphyni](#) /

> Aphyni 20-inch White Low Profile Ceiling Fan with LED Light and Remote Control User Manual

Aphyni FSD-Fan Light

Aphyni 20-inch White Low Profile Ceiling Fan with LED Light and Remote Control User Manual

Model: FSD-Fan Light | Brand: Aphyni

1. INTRODUCTION

Thank you for choosing the Aphyni 20-inch White Low Profile Ceiling Fan with LED Light. This modern flush mount fan combines efficient air circulation with versatile lighting options, controlled conveniently via remote or a smart app. Its sleek design is ideal for spaces with lower ceilings, providing both comfort and style. This manual provides essential information for safe installation, operation, and maintenance of your new ceiling fan.



20" 7-Blade Ceiling Fan with Light Remote & App Control







-  2-Hour Timer
-  6-Speed Fan Control
-  Soft Night Light Mode
-  10-100% Dimmable
-  3000K-6500K
-  F/R Forward/Reverse

Image 1: Aphyini 20-inch 7-Blade Ceiling Fan with Light, Remote & App Control in a living room setting.

2. SAFETY INFORMATION

Please read all instructions carefully before installation and use. Failure to follow these instructions may result in electric shock, fire, or personal injury.

- Always disconnect power at the circuit breaker before installation or servicing.
- All electrical wiring must be in accordance with national and local electrical codes. If you are unsure about wiring, consult a qualified electrician.
- Ensure the mounting structure can support the weight of the fan.
- Do not operate the fan with damaged wiring or if the fan is visibly damaged.
- Keep hands, clothing, and other objects away from the fan blades during operation.

3. PACKAGE CONTENTS

Verify that all components are present and undamaged before proceeding with installation.

- Ceiling Fan Light
- Instruction Manual (this document)
- Mounting Hardware (Self-tapping Screws, Expansion Tubes, S Hook, Canopy Screws, Remote Control Screw Kit, Cable Protector)

- Remote Control
- Remote Control Organizer

Product Size

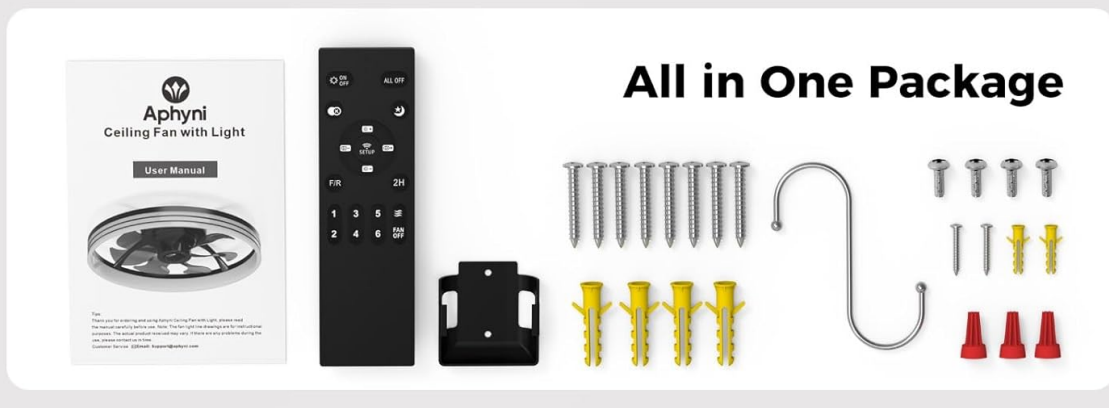
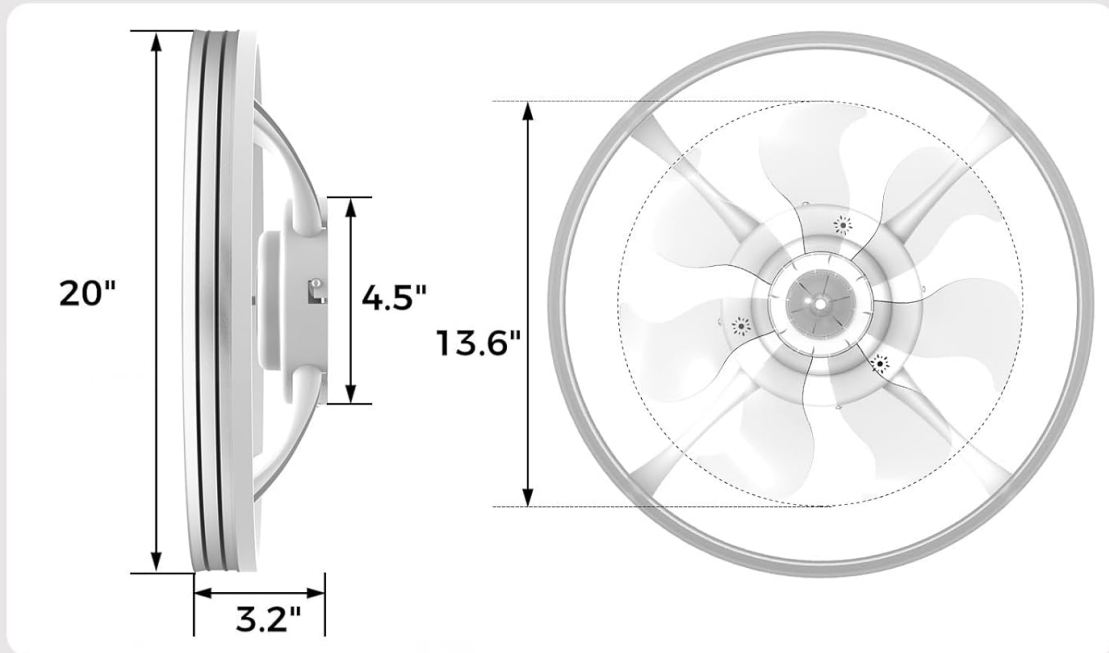

Image 2: Overview of the Aphyni Ceiling Fan and included accessories.

4. SETUP AND INSTALLATION

Follow these steps for proper installation. It is recommended to have two people for installation.

1. **Prepare the Mounting Location:** Ensure the power is off at the circuit breaker. Install the mounting bracket securely to the ceiling junction box.
2. **Attach the S-Hook:** For easier wiring, attach the provided S-hook to the mounting bracket. This allows the fan to hang while you connect the wires.
3. **Connect Electrical Wires:** Carefully connect the fan's electrical wires to the household wiring according to local electrical codes (typically black to black, white to white, and ground to ground). Secure connections with wire nuts.
4. **Mount the Fan:** Align the fan with the mounting bracket slot and rotate it to lock it into place. Secure the fan to the bracket using the provided screws.

Your browser does not support the video tag.

Video 1: Detailed installation guide for the Aphyni Ceiling Fan Light.



Relaxing Sleep Experience



Gentle Night Light



Energy Efficient

Image 3: Visual representation of the ceiling fan installation process.

5. OPERATING INSTRUCTIONS

5.1 Remote Control & Smart App

Your Aphyni ceiling fan can be controlled using the included 2.4G remote control or a mobile app. The remote offers 360° signal reception without interference from obstacles.

- **Remote Control:** Insert batteries and use the buttons to control light and fan settings.
- **Smart App:** Download the dedicated app to your mobile device (Android/iOS). Follow the app's instructions for pairing and setup.

Your browser does not support the video tag.

Video 2: Demonstration of remote control functions for the Aphyni Ceiling Fan Light.

5.2 Light Functions

The integrated LED light offers customizable illumination:

- **3 Color Lighting Modes:** Choose between 3000K (warm white), 4000K (neutral white), and 6500K (cool white) to suit your preference.
- **Stepless Dimming:** Adjust brightness from 10% to 100% for the perfect ambiance.
- **Memory Function:** The light will remember your last setting when turned off and on.



Image 4: Illustrates the adjustable color temperature and stepless dimming features of the LED light.

5.3 Fan Speeds

The 7-blade design and powerful DC motor provide 6 adjustable wind speeds, from a gentle breeze to strong airflow, with quiet operation (low noise experience).



Image 5: Depicts the 6-speed wind control settings for the fan.

5.4 Reversible Function

Utilize the reversible function for year-round comfort:

- **Summer Mode (Downdraft):** Creates a cooling breeze by pushing air downwards.
- **Winter Mode (Updraft):** Helps circulate warm air throughout the room by drawing air upwards.



Image 6: Visual explanation of the fan's reversible airflow for summer and winter.

5.5 Timer Function

Set a 2-hour timer for automatic shut-off, perfect for bedtime or when leaving a room.

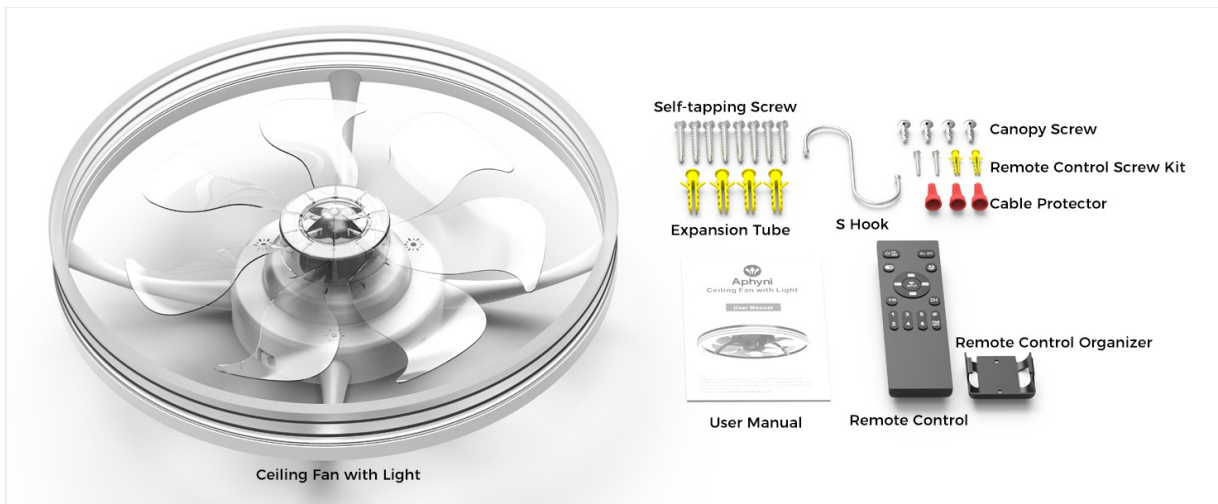

Image 7: Illustrates the 2-hour smart timer setting.

6. MAINTENANCE

Regular maintenance ensures optimal performance and longevity of your ceiling fan.

- **Cleaning:** Wipe the fan and light fixture with a soft, damp cloth. Do not use abrasive cleaners or solvents.
- **Blade Cleaning:** Gently clean the fan blades to prevent dust buildup, which can affect airflow and balance.
- **Inspection:** Periodically check all connections and mounting hardware to ensure they are secure.

7. TROUBLESHOOTING

If you encounter any issues, refer to the following common problems and solutions:

Problem	Possible Cause	Solution
Fan does not operate	No power supply; Loose wiring; Remote control battery dead	Check circuit breaker; Ensure all wires are securely connected; Replace remote control batteries.
Light does not turn on	Loose wiring; LED driver issue	Check light wiring connections; Contact customer support if LED driver is suspected.
Fan makes excessive noise	Loose mounting screws; Unbalanced blades	Tighten all mounting screws; Ensure blades are clean and free of obstructions.
Remote control not working	Batteries dead; Not paired correctly	Replace batteries; Refer to pairing instructions in the full manual or app.

8. SPECIFICATIONS

Feature	Detail
Brand	Aphyni
Model Name	FSD-Fan Light
Color	White
Material	Plastic
Product Dimensions	20"L x 20"W x 4.6"H
Item Weight	6.19 pounds

Feature	Detail
Installation Type	Flush Mount
Control Method	App, Remote
Light Source Type	LED
Light Color	Warm white (3000K), Neutral white (4000K), Cool white (6500K)
Brightness	4000 Lumen (10-100% Dimmable)
Number of Fan Speeds	6
Special Features	Air circulation, Customizable Lighting, Memory Function, Quiet Operation
Voltage	120 Volts
Wattage	40 watts
Indoor/Outdoor Usage	Indoor

9. WARRANTY AND SUPPORT

Aphyni provides a **5-year warranty** for this product. For any questions, technical assistance, or warranty claims, please contact our **24/7 customer support**.

Additional protection plans may be available for purchase:

- 3-Year Protection Plan
- 4-Year Protection Plan
- Complete Protect (monthly billing)