

## Manuals+

[Q & A](#) | [Deep Search](#) | [Upload](#)

manuals.plus /

› [Hisense](#) /

› [Hisense HW-K60J 6kg Fully Automatic Washing Machine User Manual](#)

## Hisense HW-K60J

# Hisense HW-K60J 6kg Fully Automatic Washing Machine User Manual

Model: HW-K60J

## 1. IMPORTANT SAFETY INFORMATION

Please read all instructions carefully before using the appliance and retain them for future reference. Always follow basic safety precautions to reduce the risk of fire, electric shock, and injury to persons.

- Ensure the washing machine is properly grounded.
- Do not operate the machine if it is damaged or malfunctioning.
- Keep children and pets away from the appliance during operation.
- Do not wash items that are soiled with flammable substances.
- Unplug the appliance before cleaning or performing any maintenance.

## 2. PRODUCT OVERVIEW

The Hisense HW-K60J is a 6kg fully automatic washing machine designed for efficient and convenient laundry care. Its compact and slim design makes it suitable for various living spaces.

### Key Features:

- **6kg Capacity:** Ideal for 1-3 person households.
- **Slim Design:** With a width of approximately 50cm, it fits into narrow spaces.
- **Quick Wash:** A 14-minute cycle for lightly soiled items.
- **Shower Water Flow:** Creates a powerful, three-dimensional water current for thorough cleaning.
- **Unique Pulsator:** Designed to prevent clothes from tangling while effectively removing dirt.
- **Stainless Steel Tub:** Features a concave-convex design to tackle stubborn stains.
- **Air Dry Function:** Reduces drying time by using air circulation.
- **Reservation Function:** Schedule your wash cycle to finish at a convenient time.

- **Detergent Dispenser:** Automatically foams and dispenses detergent for gentle and effective cleaning.



Figure 2.1: Top-down view of the Hisense HW-K60J 6kg washing machine.

# Hisense



Figure 2.2: Front view of the washing machine, emphasizing its 6kg capacity, shower water flow, compact size, and air dry feature.

## 3. SETUP

Proper installation is crucial for the optimal performance and longevity of your washing machine. Please ensure sufficient space and correct connections.

### 3.1 Installation Requirements

- **Dimensions:** Width 50cm, Depth 52cm, Height 91cm.
- **Space:** Allow at least 10cm extra width for doorways and passages. For top-opening, ensure 10-15cm clearance above the machine when the lid is fully open.
- **Drainage:** Ensure the drain hose connection is at least 9cm above the floor. The drain hose can be positioned to the left, right, or rear.
- **Leveling:** The machine must be installed on a firm, level surface to prevent excessive vibration and noise during operation. Adjust the leveling feet as needed.

# 商品寸法+10cm以上の幅が必要です。

## 《搬入における確認項目》

※段差やコーナー箇所があり、直線ではない場合、+10cm以上の幅が必要となります。  
 ※手すり・照明・装飾物などがある場合、そこから+10cmの幅が必要となります。

### 〈商品の寸法〉



### 〈玄関の高さ〉

商品寸法+10cm

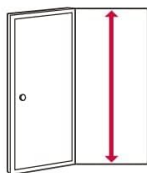

### 〈玄関の幅〉

商品寸法+10cm

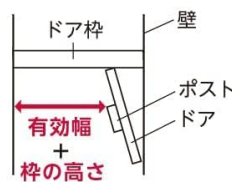

### 〈廊下の幅〉

商品寸法+10cm

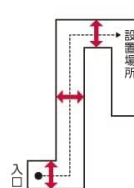

### 〈エレベータの幅〉

商品寸法+10cm

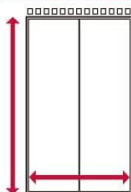

### 〈階段の幅〉

商品寸法+10cm

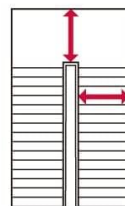

## 《設置における確認項目》

・必要なスペースは商品によって異なるため、詳細はメーカーページなどでご確認ください。  
 ・洗濯機の設置時にはドアを開閉するため上部のスペース確保が必要となります。

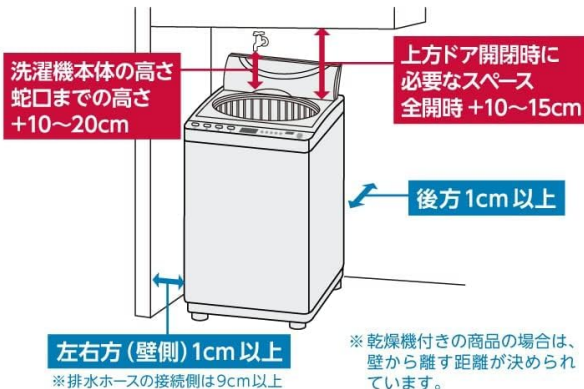

## 防水パンの有無と内側サイズをチェック

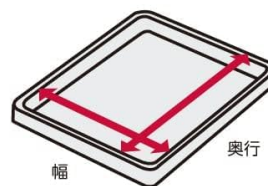

※排水エルボ・足台の有無と排水口位置によって、  
追加費用がかかることがあります。

Figure 3.1: Installation guidelines, including product dimensions and necessary clearances for doorways, stairs, and drainage.

(単位：mm)

# 寸法図

## 横幅500×奥行520×高さ910

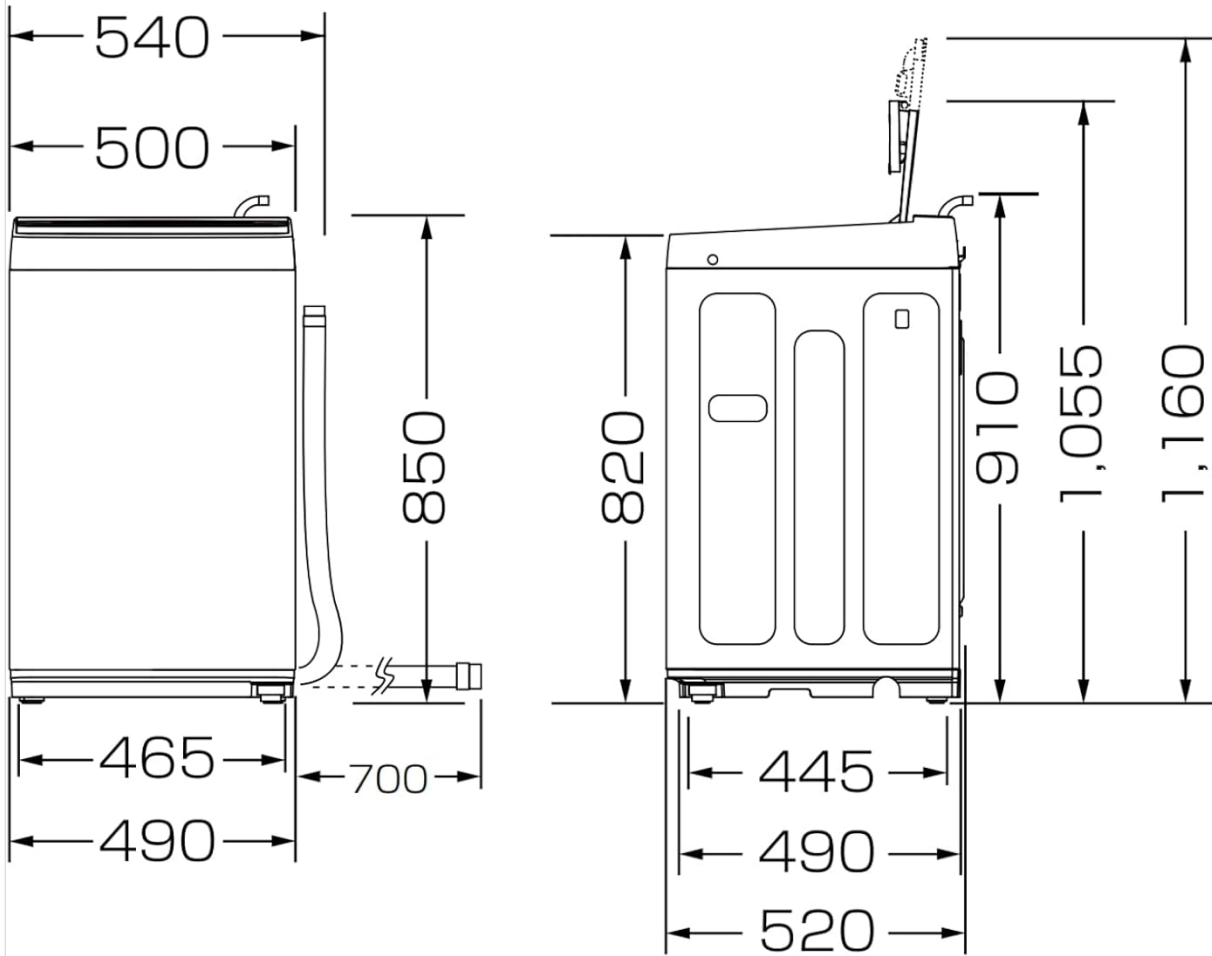

※画像はイメージです。

Figure 3.2: Detailed dimensional drawing of the washing machine (in mm).

### 3.2 Initial Setup Steps

1. Unpack the washing machine and remove all packaging materials.
2. Position the machine in the desired location, ensuring adequate space and a level surface.
3. Connect the water supply hose to the water tap and the machine's inlet.
4. Install the drain hose and ensure it is properly secured for drainage.
5. Plug the power cord into a grounded electrical outlet.

## 4. OPERATING INSTRUCTIONS

This section details how to operate your Hisense washing machine for various laundry needs.

### 4.1 Control Panel Overview

The control panel features clear buttons and a large digital display for easy selection of wash courses and functions.



Figure 4.1: Control panel showing wash course selections and digital display.

## 4.2 Wash Cycles and Functions

The HW-K60J offers a variety of wash courses to suit different fabric types and soil levels:

- **Standard:** For daily laundry.
- **Quick Wash (14 min):** For lightly soiled items or when time is limited.
- **Soak:** For heavily soiled items requiring pre-treatment.
- **Delicate:** For fragile garments.
- **Blanket:** For washing large items like blankets (up to 3.0kg).
- **Custom:** Allows you to combine wash, rinse, spin, and air dry settings.
- **Drum Clean:** For cleaning the washing machine tub.
- **Air Dry:** A standalone function to reduce moisture in clothes.
- **Wash + Air Dry:** Combines a wash cycle with the air dry function.



Figure 4.2: Display of diverse wash courses, including Standard, Quick Wash, Soak, and Air Dry.

### 4.3 Detergent Dispenser

The washing machine features a dedicated dispenser for liquid and powder detergents, as well as bleach. Detergent is foamed and introduced into the tub at the appropriate time for effective cleaning.



Figure 4.3: Detergent dispenser for liquid, powder, and bleach.

## 4.4 Reservation Function

You can set the washing machine to complete a cycle 1 to 24 hours in advance, allowing you to schedule laundry to fit your lifestyle.

# 自分の生活スタイルに 合わせる予約機能

起床時

帰宅時

24

洗濯終了時間を1時間単位で1~24時間後まで予約可能。

※画像はイメージです。

Figure 4.4: The 24-hour reservation function allows you to set the wash completion time.

## 4.5 Air Dry Function

The Air Dry function uses air circulation to remove moisture from clothes, significantly reducing drying time, especially useful for indoor drying.

# 風乾燥で乾燥時間を短くする

乾燥時間をもっと短くしたい時、非常に便利



Figure 4.5: The Air Dry function helps shorten drying time by blowing air over clothes.

## 5. MAINTENANCE

Regular maintenance ensures the efficiency and longevity of your washing machine.

### 5.1 Cleaning the Lint Filter

The washing machine is equipped with a large capacity lint filter. Clean it regularly to prevent lint from redepositing on clothes.

# 糸くずフィルター

大容量でお手入れがラクな糸くずフィルターを配置



Figure 5.1: The large capacity lint filter is designed for easy maintenance.

## 5.2 Cleaning the Drum

Use the 'Drum Clean' cycle periodically to remove detergent residue and prevent mold growth inside the tub.

## 5.3 General Cleaning

Wipe the exterior of the machine with a soft, damp cloth. Do not use abrasive cleaners or solvents.

## 6. TROUBLESHOOTING

This section addresses common issues you might encounter with your washing machine.

Problem	Possible Cause	Solution
Excessive vibration or noise during spin cycle	Machine is not level; uneven load; shipping bolts not removed.	Ensure the machine is on a level surface and adjust leveling feet. Redistribute laundry evenly. Confirm all shipping bolts are removed.

Problem	Possible Cause	Solution
Lint on clothes after washing	Lint filter is clogged or ineffective.	Clean the lint filter regularly. Consider using an additional external lint filter if the issue persists.
Door does not open immediately after pausing a cycle	Safety lock engaged.	After pressing pause, wait approximately 10 seconds for the door lock to disengage.
Detergent dispenser difficult to access	Tub position.	The tub can be manually rotated to bring the dispenser to a more convenient position for adding detergent.
Clothes are still very wet after spin cycle	Automatic spin time too short; overloaded.	Manually select a longer spin time (e.g., 6-9 minutes). Avoid overloading the machine.

## 7. SPECIFICATIONS

Feature	Specification
Brand	Hisense
Model	HW-K60J
Capacity	6 Kilograms
Product Dimensions (D x W x H)	52 cm x 50 cm x 91 cm
Product Weight	29 Kilograms
Operating Noise Level	47 dB
Voltage	100 Volts
Material	Stainless Steel
Installation Type	Freestanding
Door Position	Top
Special Features	Start Reservation Timer, Drum Clean, Remaining Time Display
Included Accessories	Drain Sleeve, Lint Filter, Water Supply Joint, Water Supply Hose

## 8. WARRANTY AND SUPPORT

For warranty information and customer support, please refer to the documentation included with your purchase or visit the official Hisense website. You can also contact Hisense customer service directly for assistance with product inquiries, technical support, or service requests.

Hisense Official Store: [Visit Hisense Store on Amazon.co.jp](https://www.amazon.co.jp)

© 2025 Hisense. All rights reserved.