

## Manuals+

[Q & A](#) | [Deep Search](#) | [Upload](#)

manuals.plus /

- › [Eridanus](#) /
- › [Eridanus 21-inch Ceramic Utility Sink Instruction Manual \(Model 201\)](#)

## Eridanus 201

# Eridanus 21-inch Ceramic Utility Sink Instruction Manual

Model: 201

## 1. INTRODUCTION

---

This manual provides instructions for the installation, operation, and maintenance of your Eridanus 21-inch ceramic utility sink. This sink is designed for various applications including laundry rooms, kitchens, bathrooms, and garages.

The Eridanus utility sink features a durable vitreous ceramic construction with a white enamel glaze, offering a smooth, non-porous surface resistant to tarnishing, fading, scratches, chips, and burns.



Image 1.1: Eridanus 21-inch ceramic utility sink with included components.

## 2. SAFETY INFORMATION

- Always wear appropriate personal protective equipment (PPE) such as safety glasses and gloves during installation.
- Ensure all water supply lines are shut off before beginning any plumbing work.
- The sink is heavy (approximately 59.9 lbs). Use proper lifting techniques or seek assistance to prevent injury.
- Verify that the wall structure is capable of supporting the weight of the sink and its contents if performing a wall-mounted installation.
- Consult a qualified plumber if you are unsure about any installation steps.

### 3. PACKAGE CONTENTS

---

Verify that all components are present before beginning installation:

- Eridanus 21-inch Ceramic Utility Sink
- Basket Strainer
- Mounting Brackets (two hanger brackets)
- Installation Instruction Guide (this manual)

## What's in the box:



Image 3.1: Package contents for the Eridanus utility sink.

### 4. SETUP AND INSTALLATION

---

The Eridanus utility sink supports dual installation methods: wall-mounted or top-mounted on a support base/cabinetry.

#### 4.1. Wall-Mounted Installation

The high back of the sink facilitates wall mounting. Two hanger brackets are included for this purpose. Note that screws and wall anchors are not included and must be sourced separately based on your wall material.

1. Determine the desired height and location for the sink.

2. Mark the positions for the mounting brackets on the wall, ensuring they are level and spaced correctly to support the sink. Refer to the sink's dimensions for accurate placement.
3. Install the mounting brackets securely into the wall using appropriate screws and anchors for your wall type. Ensure the brackets are firmly attached and can support the sink's weight.
4. Carefully lift the sink and position it onto the installed mounting brackets. Ensure the sink is stable and level.
5. Connect the plumbing for the faucet (not included) and drain.

## Wall Mounted Installation

Premium stainless steel brackets: compact size, heavy-duty performance.

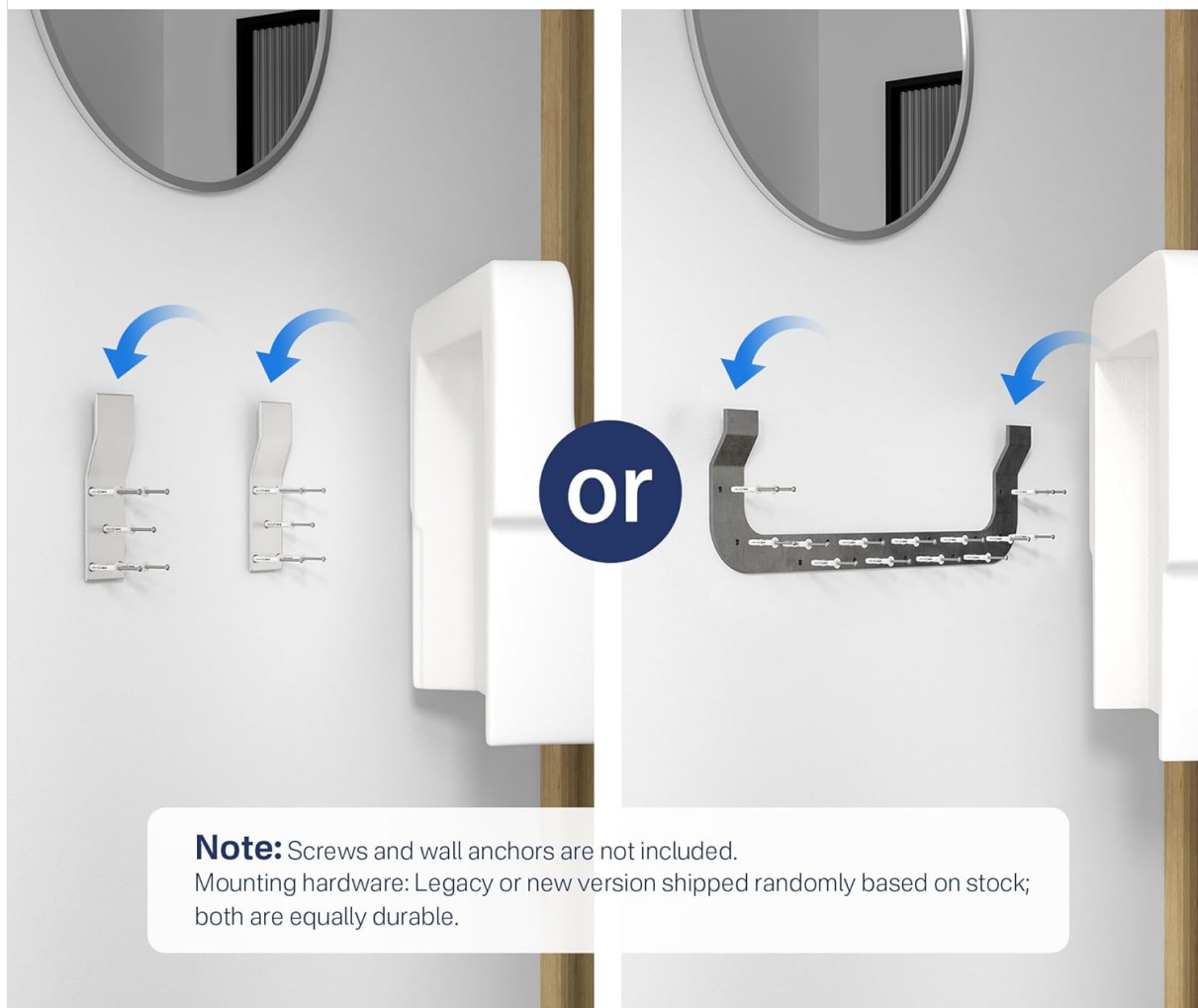

Image 4.1: Wall-mounted installation with mounting brackets.

### 4.2. Top-Mounted Installation

The sink can also be installed above counter, as a farmhouse apron sink, or as a drop-in sink into existing cabinetry or a support base. Ensure the cabinetry or base is robust enough to support the sink's weight.

1. Prepare the countertop or cabinet opening according to the sink's dimensions.
2. Place the sink into the prepared opening or onto the support base.
3. Secure the sink using appropriate fasteners or silicone sealant as required for your specific installation type.
4. Connect the plumbing for the faucet (not included) and drain.

## Different Install Style



Image 4.2: Various installation styles for the Eridanus utility sink.

## 5. OPERATING INSTRUCTIONS

The Eridanus utility sink is designed for general washing tasks. Its deep basin and 7.5-gallon capacity make it suitable for cleaning items, repotting plants, bathing small pets, and laundry pre-treatment.

- Ensure the drain stopper (if using) is properly seated before filling the sink with water.
- Adjust water temperature and flow using your installed faucet.
- The sink's bottom is designed to tilt towards the center for quick drainage, preventing water stagnation.

## Deep Sink Design

Provides ample depth for a variety of uses, with ample water storage to satisfy everything from laundry to pet washing.



**7.5 gallon capacity**

Image 5.1: Deep sink design with 7.5-gallon capacity.

## Suitable For Small Pet Care

Effortless at-home bathing for your small sized pets

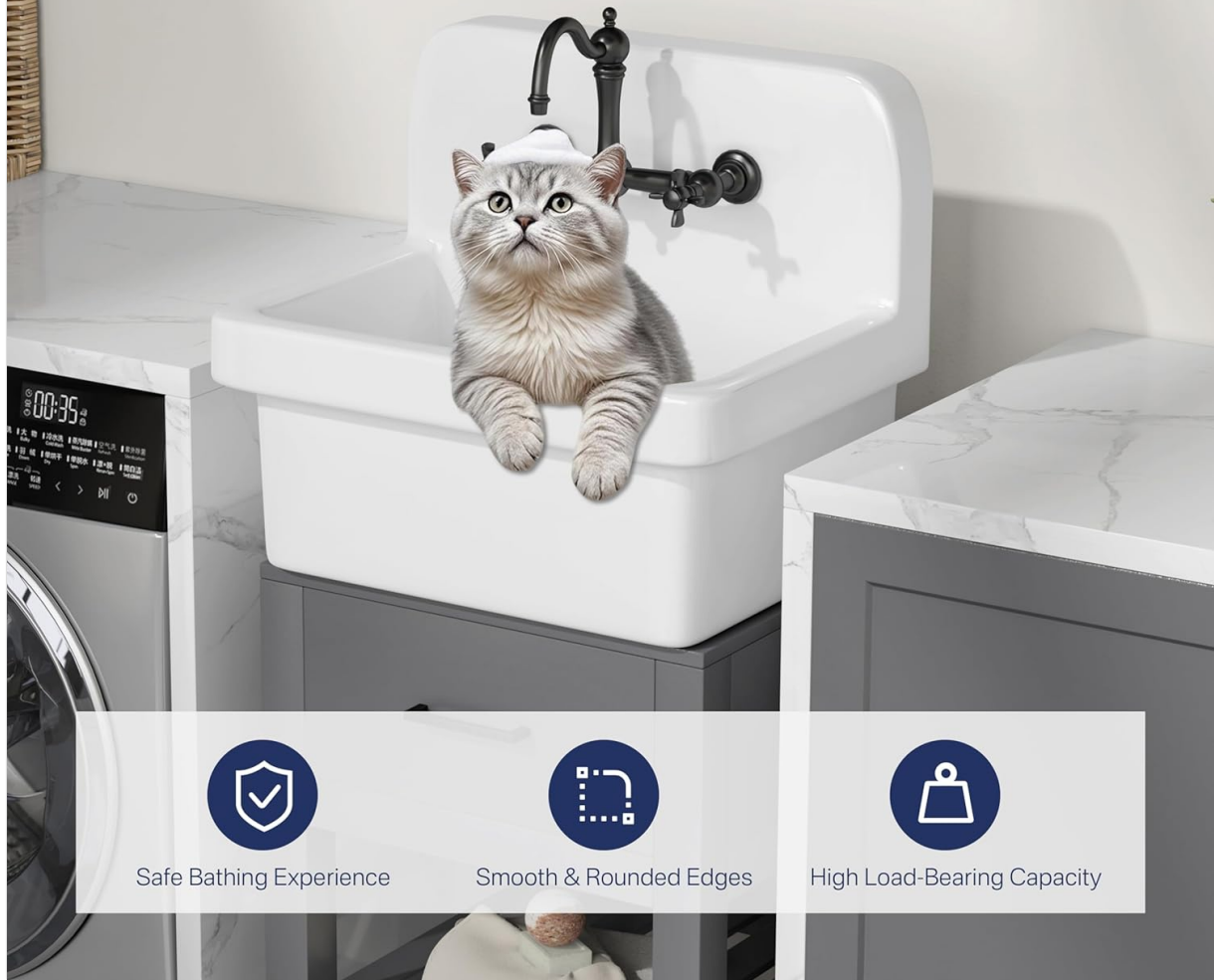

Safe Bathing Experience



Smooth & Rounded Edges



High Load-Bearing Capacity

Image 5.2: Sink suitable for small pet care.

## 6. MAINTENANCE AND CLEANING

The ceramic surface of your Eridanus sink is designed for easy cleaning and durability.

- For routine cleaning, simply wipe the surface of the sink with a damp cloth.
- Avoid abrasive cleaners, scouring pads, or harsh chemicals, as these can damage the enamel glaze.
- The smooth, non-porous surface resists stains and is easy to maintain.
- The basket strainer helps capture debris, preventing pipe clogging. Regularly clean the strainer.



## Quick Drainage

The bottom of the sink tilts towards the center, make the drainage speed faster without stagnal water.



## Maintenance Cleaning

Smooth ceramic glass surface makes cleaning / maintenance more easier.



Image 6.1: Quick drainage and easy maintenance features.

## 7. TROUBLESHOOTING

This section addresses common issues you might encounter with your utility sink.

### 7.1. Slow Drainage

- **Check Basket Strainer:** Remove and clean any debris accumulated in the basket strainer.
- **Inspect P-Trap:** A clog may be present in the P-trap beneath the sink. Carefully remove and clean it.
- **Ventilation:** Ensure your plumbing system's vent pipe is not blocked.

### 7.2. Leaks Around Drain or Faucet

- **Tighten Connections:** Ensure all nuts and connections on the drain assembly and faucet are securely tightened. Do not overtighten.
- **Check Gaskets/Washers:** Inspect rubber gaskets and washers for proper seating and damage. Replace if necessary.
- **Sealant:** Ensure plumber's putty or silicone sealant was properly applied during installation around the drain flange.



### 7.3. Water Splashing Out

- **Faucet Compatibility:** Ensure your chosen faucet's spout reach is appropriate for the sink's depth and width. A spout that extends too far or is too short can cause splashing.
- **Water Pressure:** High water pressure can cause splashing. Consider installing a pressure reducer if this is a persistent issue.

## 8. SPECIFICATIONS

---

<b>Brand</b>	Eridanus
<b>Model Number</b>	201
<b>Color</b>	White
<b>Material</b>	Vitreous Ceramic
<b>Exterior Dimensions (L x W x H)</b>	21.25" x 16.2" x 18.5"
<b>Installation Type</b>	Wall-Mount, Top-Mount (Above Counter, Farmhouse Apron, Drop-in)
<b>Finish Type</b>	Polished
<b>Shape</b>	Rectangular
<b>Drain Type</b>	Grid
<b>Hole Count</b>	1 (for faucet)
<b>Item Weight</b>	59.9 pounds
<b>Capacity</b>	7.5 gallons

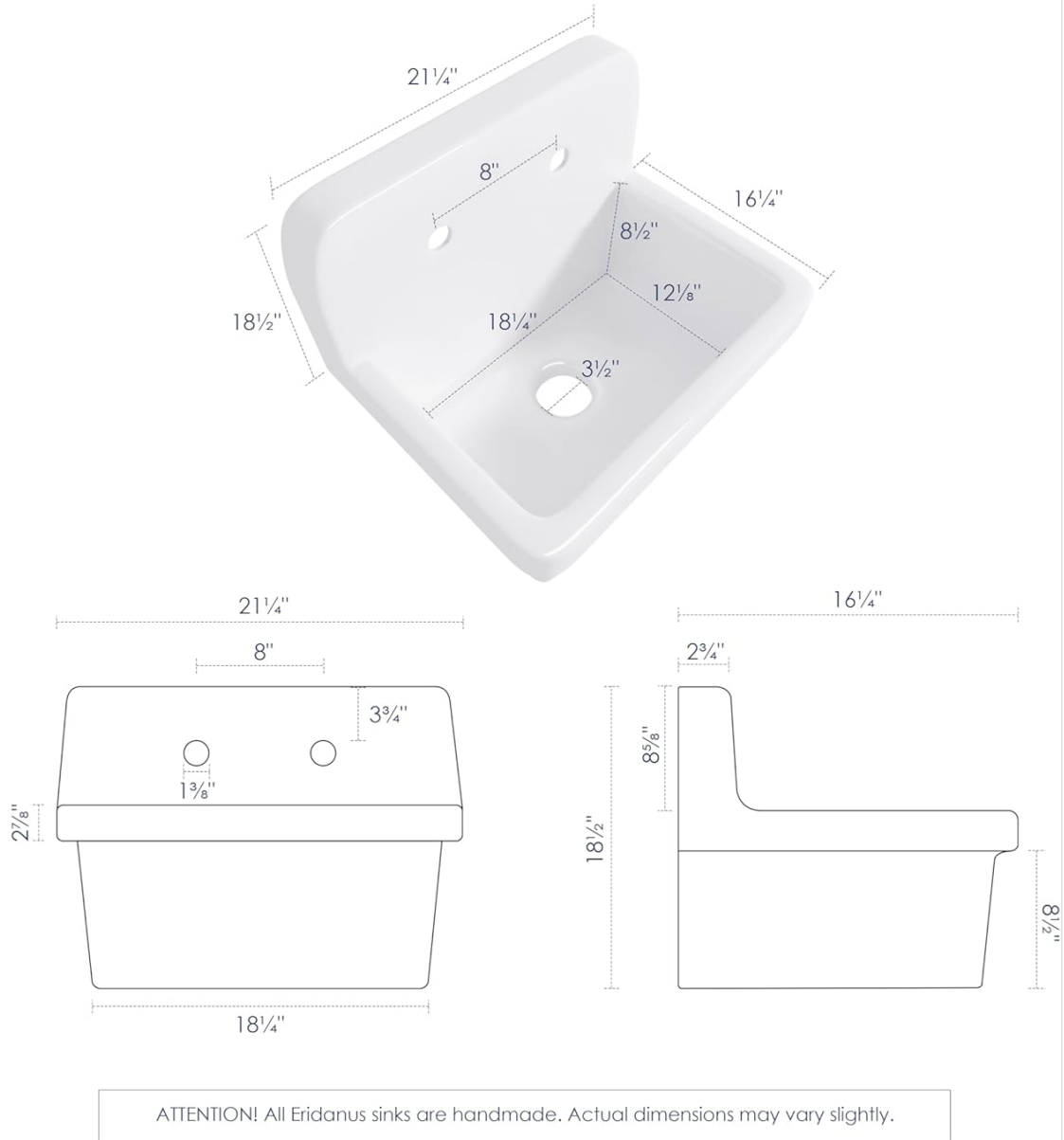

Image 8.1: Detailed dimensions of the Eridanus utility sink.

## 9. WARRANTY AND SUPPORT

### 9.1. Warranty Information

The Eridanus 21-inch Ceramic Utility Sink comes with a **2-year warranty** from the date of purchase, covering manufacturing defects and material flaws under normal use and service.





This warranty does not cover damage resulting from improper installation, misuse, abuse, accident, neglect, or unauthorized repairs or modifications.

### 9.2. Customer Support

For any questions, technical assistance, or warranty claims, please contact Eridanus customer support. We offer **24/7 customer support** to assist you.

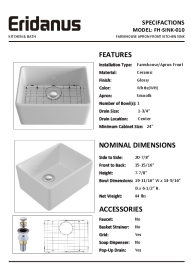
Please refer to the contact information provided on the Eridanus official website or your purchase documentation for the most current support channels.

## Related Documents - 201

 <p>The cover of the 'Installation Guide' for the Eridanus Wall Mount Utility Sink. It features the Eridanus logo at the top, the title 'Installation Guide' in a large font, and 'WALL MOUNT UTILITY SINK' below it. A photograph of the white utility sink is centered on a blue background.</p>	<p><a href="#">Eridanus Wall Mount Utility Sink Installation Guide</a></p> <p>Comprehensive installation guide for the Eridanus Wall Mount Utility Sink, including tools, materials, step-by-step instructions for wall mount and top mount installations, and care and cleaning recommendations.</p>
 <p>The cover of the 'Eridanus FH-SINK-010 Farmhouse Apron Front Ceramic Kitchen Sink: Specifications, Installation &amp; Warranty' document. It includes the Eridanus logo, the model name 'FH-SINK-010', and a list of features and nominal dimensions. A photograph of the white ceramic sink is shown.</p>	<p><a href="#">Eridanus FH-SINK-010 Farmhouse Apron Front Ceramic Kitchen Sink: Specifications, Installation &amp; Warranty</a></p> <p>Detailed specifications, care and maintenance guide, installation instructions, and lifetime limited warranty for the Eridanus FH-SINK-010 Farmhouse Apron Front Ceramic Kitchen Sink.</p>
 <p>The cover of the 'ERIDANUS Wall Mount Utility Sink Installation Guide'. It features the Eridanus logo, the title 'Installation Guide', and 'WALL MOUNT UTILITY SINK'. A photograph of the white utility sink is centered on a blue background.</p>	<p><a href="#">ERIDANUS Wall Mount Utility Sink Installation Guide</a></p> <p>This guide provides detailed instructions for installing and maintaining your ERIDANUS Wall Mount Utility Sink. It covers required tools, parts, step-by-step installation procedures for both wall-mount and top-mount configurations, and essential care and cleaning advice.</p>
 <p>The cover of the 'Eridanus Wall Mount Utility Sink Installation Guide'. It features the Eridanus logo, the title 'Installation Guide', and 'WALL MOUNT UTILITY SINK'. A photograph of the white utility sink is centered on a blue background.</p>	<p><a href="#">Eridanus Wall Mount Utility Sink Installation Guide</a></p> <p>Comprehensive installation guide for the Eridanus Wall Mount Utility Sink, covering tools, materials, procedures, and care instructions.</p>
 <p>The cover of the 'Eridanus Eclisse Pedestal Sink ERI-PB-521 Specifications' document. It includes the Eridanus logo, the model name 'Eclisse ERI-PB-521', and a photograph of the white pedestal sink with a chrome faucet. Technical specifications and features are listed.</p>	<p><a href="#">Eridanus Eclisse Pedestal Sink ERI-PB-521 Specifications</a></p> <p>Detailed specifications and features for the Eridanus Eclisse Pedestal Sink (Model ERI-PB-521), including dimensions, materials, and included parts.</p>

	<p><a href="#">ERIDANUS Smart Toilet Installation Guide</a></p> <p>Comprehensive installation guide for the ERIDANUS Smart Toilet, covering unpacking, preparation, installation steps, and final checks. Includes parts list and required tools for proper setup.</p>
----------------------------------------------------------------------------------	------------------------------------------------------------------------------------------------------------------------------------------------------------------------------------------------------------------------------------------------------------------------

Documents - Eridanus – 201



[\[pdf\]](#) User Manual Quick Start Guide Guide Warranty

HWSONG iOptron GEM28 Manual Mount with iPolar 1 5 Tripod G281A1 g28 gem28 manual agenaastro mw link id 141 Instruction manual iOptron G281A1 iOPTRON WITH iPOLAR LITEROC TRIPOD Testar Australia G28 Manual cdn shopify s files 0071 4935 5059 G28 v 1620964149 ||| ||| iOptron GEM28 German Equatorial Mount Instruction Manual Product GEM28 and GEM28EC Read the included Quick Setup Guide QSG BEFORE taking the mount out of the case This product is a iOptron GEM28 German Equatorial Mount Instruction Manual Product GEM28 and GEM28EC Read the includ ... Polaris on the LCD screen, as indicated in the left side of the figure below. For example, June 22, **2014**, 20:19:42 in Boston, US long. W7108 50 and lat. N4230 32 , UTC 300 min, the Polaris Position...  
lang:en score:39 filesize: 2.51 M page\_count: 49 document date: 2021-04-18



[\[pdf\]](#) User Manual Quick Start Guide Parts List Guide Warranty

HEM15 iOptron Instruction Manual ioptron v Manuals |||  
iOptron HEM15™ Hybrid Strain Wave GoTo Equatorial Mount Instruction Manual Product HEM15 Read the ... r-defined comet list. Find the orbit parameters of a comet in the SkyMap format. For example, the C/**2012** ISON has an orbit parameter: No. Name Year M Day q e I H G C/**2012** S1 ISON **2013** 11 28...  
lang:en score:39 filesize: 2.32 M page\_count: 46 document date: 2023-06-19

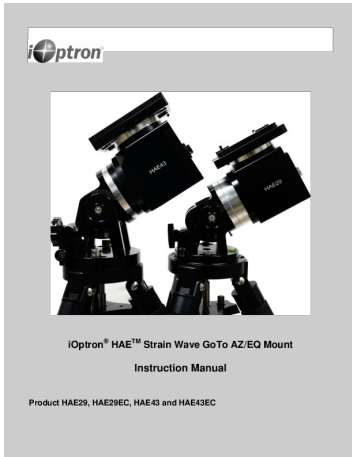

[iOptron HAE Strain Wave GoTo AZ/EQ Mount Instruction Manual - Setup and Operation Guide](#)

Detailed instruction manual for iOptron HAE29, HAE29EC, HAE43, HAE43EC Strain Wave GoTo AZ/EQ Mounts. Covers assembly, operation, features, technical specifications, and maintenance for astronomers and astrophotographers.

lang:en score:38 filesize: 2.36 M page\_count: 46 document date: 2023-01-07



[\[pdf\] User Manual Quick Start Guide Parts List Guide](#)

HAZ Mount Instruction Manual iOptron Corp HAE ioptron v manuals |||

iOptron HAZ™ Strain Wave Alt-Az GoTo Mount Instruction Manual Product HAZ31 and HAZ46 Read the Qu ... r-defined comet list. Find the orbit parameters of a comet in the SkyMap format. For example, the C/2012 ISON has an orbit parameter: No. Name Year M Day q e I H G C/2012 S1 ISON 2013 11 28...

lang:en score:37 filesize: 2.13 M page\_count: 44 document date: 2023-02-16



[\[pdf\] User Manual Quick Start Guide Parts List Guide](#)

HAE Mount Instruction Manual iOptron Corp HAEB ioptron v Manuals |||

Instruction Manual For iOptron HAEb Series Strain Wave Gear GoTo AZ/EQ Mount Product HAE29B/EC, HAE43B/EC ... R. A time and site information screen will be displayed: Daylight Saving Time Y UTC -300 Minute s 2019-03-09 10:19:18 Daylight Saving Time Longitude:W071d08m50s Latitude: N42d30m32s Northern Hemis...

lang:en score:37 filesize: 4.77 M page\_count: 67 document date: 2024-11-05



[\[pdf\] User Manual Quick Start Guide Parts List Guide](#)

HAE Mount Instruction Manual iOptron Corp HAEC ioptron v Manuals |||

Instruction Manual For iOptron HAEc Series Strain Wave Gear GoTo AZ/EQ Mount Product HAE29C/EC, HAE43C/EC ... R. A time and site information screen will be displayed: Daylight Saving Time Y UTC -300 Minute s 2019-03-09 10:19:18 Daylight Saving Time Longitude:W071d08m50s Latitude: N42d30m32s Northern Hemis...

lang:en score:37 filesize: 2.65 M page\_count: 57 document date: 2024-11-05

[\[pdf\]](#) User Manual Quick Start Guide Guide Warranty Accessories

HWSONG found a and thread it into the opening of DEC axis as iOptron GEM28 German Equatorial Mount Instruction Manual G28 Product GEM28EC Read included Quick Setup Guide QSG BEFORE taking mount out case! This product is precision instrument DO NOT plug ST 4 guiding camera cable this port It will damage guide electronics 2 Go2Nova® 8409 Hand Controller The hand controller HC shown in Figure standard used on has large LCD screen function direction number keys front an HBX 6 Instructional manual Tips for set up firmware upgrades check online latest version ASCOM driver Reviews feedback from other customers Accessories 1 US market only Actual contents design may vary star identifying After Polar Alignment Set Up Time Site slew telescope to bright manually or uses magnetic gear meshing ioptron v Manuals

iOptron GEM28 German Equatorial Mount Instruction Manual Product GEM28 and GEM28EC Read the includ ... Polaris on the LCD screen, as indicated in the left side of the figure below. For example, June 22, 2014, 20:19:42 in Boston, US long. W7108 50 and lat. N4230 32 , UTC 300 min, the Polaris Position...

lang:en score:36 filesize: 2.51 M page\_count: 49 document date: 2021-03-29



[\[pdf\]](#) User Manual Quick Start Guide Guide Warranty

HWSONG iOptron CEM70 Center Balanced Equatorial Mount 66888 2 Anleitung EN Ver 1 2020 6 reserves the rights to revise this instruction without notice WIFI connection The mount is equipped with most advanced GOTONOVA® GOTO DO NOT plug ST 4 guiding camera cable into port It will damage guide electronics 1X5525 5mmx5 5mm and 1X5521 1mmX5 DC output sockets for Please read entire Instruction Manual before operating You must hold firmly when disengaging gear switches nimax img de Produkt

iOptron CEM70 Center-Balanced Equatorial Mount Instruction Manual Product #C70A, #C70AG Please rea ... ER. A time and site information screen will be displayed: Daylight Saving Time Y UTC -300 Minute s 2014-03-09 10:19:18 Longitude:W07108 50 Latitude: N4230 32 Northern Hemisphere Set Local Time The ...

lang:en score:35 filesize: 2.85 M page\_count: 64 document date: 2020-06-22

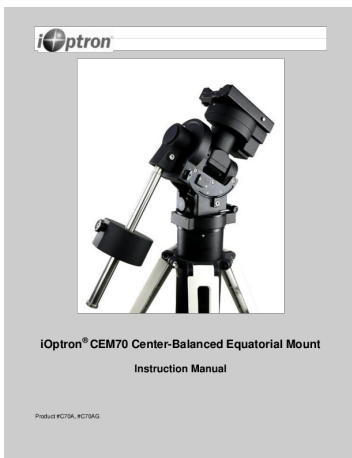

[\[pdf\]](#) User Manual Quick Start Guide Instructions Guide Warranty Accessories

HWSONG Instruction Manual iOptron USB port on an iPolar electronic polar scope • Click Connect and start alignment by following screen instructions Quick Polar Alignment If the mount 685717 bhphotovideo lit\_files German Equatorial Mount Manual< b> Product GEM28 GEM28EC 2 Read included Setup Guide (QSG) BEFORE taking out of case! This product is a precision instrument uses magnetic gear meshing mechanism Please read QSG before assembling entire 685723 Instructional manual< Tips for set up Hand controller firmware upgrades (check online latest version) ASCOM driver Reviews feedback from other customers Accessories 1 US market only Actual contents design function may vary 685719

iOptron GEM28 German Equatorial Mount Instruction Manual Product GEM28 and GEM28EC Read the includ ... Polaris on the LCD screen, as indicated in the left side of the figure below. For example, June 22, 2014, 20:19:42 in Boston, US long. W7108 50 and lat. N4230 32 , UTC 300 min, the Polaris Position...

lang:en score:35 filesize: 2.43 M page\_count: 50 document date: 2021-01-31

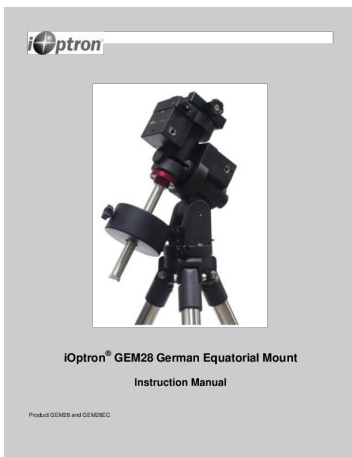



[\[pdf\]](#) User Manual Quick Start Guide Parts List Guide

HAZ Mount Instruction Manual iOptron Corp 1064238 bhphotovideo lit files |||

iOptron HAZ™ Strain Wave Alt-Az GoTo Mount Instruction Manual Product HAZ31 and HAZ46 Read the Qu ... r-defined comet list. Find the orbit parameters of a comet in the SkyMap format. For example, the C/2012 ISON has an orbit parameter: No. Name Year M Day q e I H G C/2012 S1 ISON 2013 11 28...

lang:en score:35 filesize: 2.13 M page\_count: 44 document date: 2023-04-02



[\[pdf\]](#) User Manual Quick Start Guide Parts List Guide

HAZ Mount Instruction Manual iOptron Corp 1067714 bhphotovideo lit files |||

iOptron HAZ™ Strain Wave Alt-Az GoTo Mount Instruction Manual Product HAZ31 and HAZ46 Read the Qu ... r-defined comet list. Find the orbit parameters of a comet in the SkyMap format. For example, the C/2012 ISON has an orbit parameter: No. Name Year M Day q e I H G C/2012 S1 ISON 2013 11 28...

lang:en score:35 filesize: 2.11 M page\_count: 44 document date: 2023-11-30

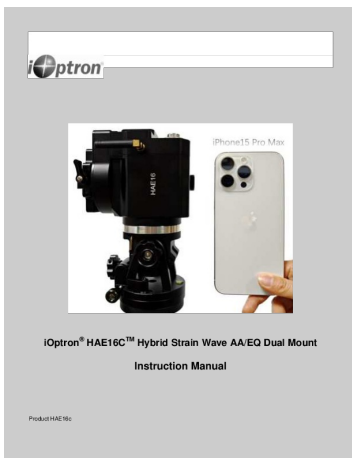

[iOptron HAE16C Hybrid Strain Wave AA/EQ Dual Mount Instruction Manual](#)

Comprehensive instruction manual for the iOptron HAE16C Hybrid Strain Wave AA/EQ Dual Mount, detailing setup, operation, and maintenance for astronomical observation.

lang:en score:35 filesize: 2.49 M page\_count: 51 document date: 2025-07-14

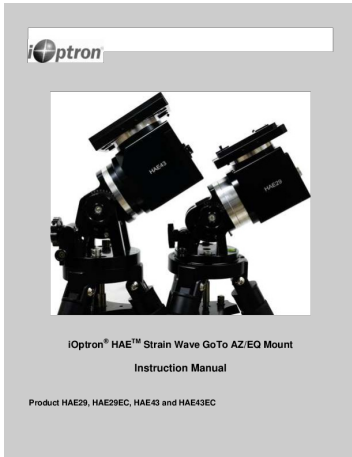

[\[pdf\]](#) User Manual Quick Start Guide Parts List Guide

HAE Mount Instruction Manual iOptron Corp 1064237 bhphotovideo lit files |||

iOptron HAETM Strain Wave GoTo AZ/EQ Mount Instruction Manual Product HAE29, HAE29EC, HAE43 and HAE4 ... r-defined comet list. Find the orbit parameters of a comet in the SkyMap format. For example, the C/2012 ISON has an orbit parameter: No. Name Year M Day q e I H G C/2012 S1 ISON 2013 11 28...

lang:en score:35 filesize: 2.36 M page\_count: 46 document date: 2023-07-17

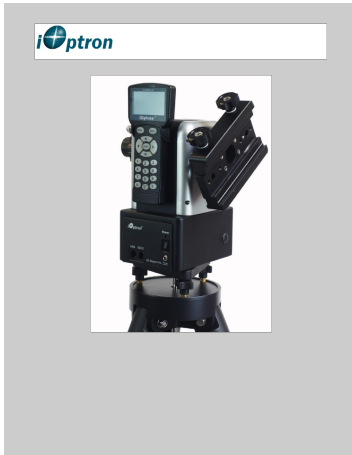

[iOptron AZ Mount Pro Instruction Manual: Setup and Operation Guide](#)

Comprehensive instruction manual for the iOptron AZ Mount Pro Altazimuth Mount, detailing setup, operation, features of the Go2Nova 8407 Hand Controller, and troubleshooting for astronomical observations. Includes model numbers #8900, #8903, #8920.

lang:en score:35 filesize: 2.07 M page\_count: 46 document date: 2022-02-02



[\[pdf\]](#) User Manual Parts List Warranty

Microsoft Word CEM120 Manual 190415 docx Kevin Zou iOptron Center Balanced Equatorial Mount instruction manual tejraj

iOptron CEM120 Center-Balanced Equatorial Mount Instruction Manual Product #7300, #7301 #7302 1 ... ON TWO YEAR TELESCOPE, MOUNT, AND CONTROLLER WARRANTY ..... 53 Ver. 1.3 2019.4 iOptron reserves the rights to revise this instruction without notice. Actual color/contents/...

lang:en score:34 filesize: 2.74 M page\_count: 53 document date: 2019-04-29





[\[pdf\]](#) User Manual Quick Start Guide Guide Warranty Accessories

HWSONG iOptron Center Balanced Equatorial Mount Instruction Manual C40 CEM40 Product CEM40G and CEM40EC C40XXX Please read the included Quick Setup Guide QSG BEFORE taking mount out of case! This product is a precision instrument before assembling entire operating Instructional manual Tips for set up Hand controller firmware upgrades check online latest version Commander ASCOM driver Reviews feedback from other customers Accessories 1 US market only Actual contents design color function may vary Features Unique equatorial CEM maximum payload minimum weight ioptron v Manuals iOptron Center-Balanced Equatorial Mount Instruction Manual Product CEM40, CEM40G and CEM40EC C40XX ... ER. A time and site information screen will be displayed: Daylight Saving Time Y UTC -300 Minute s **2019-03-09 10:19:18** Longitude:W071d08m50s Latitude: N42d30m32s Northern Hemisphere Set Local Time Th...

lang:en score:34 filesize: 2.05 M page\_count: 55 document date: 2021-04-27

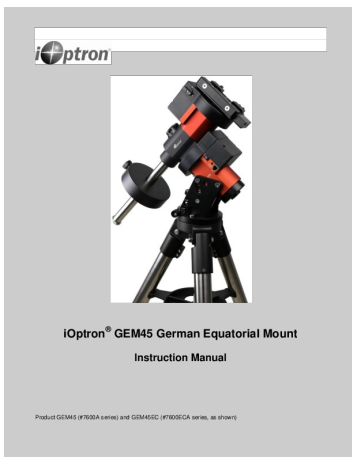

[\[pdf\]](#) User Manual Quick Start Guide Guide Warranty

HWSONG iOptron GEM45 Instru Index of 2019 12 Instruction Manual astronomyplus ||| iOptron GEM45 German Equatorial Mount Instruction Manual Product GEM45 #7600A series and GEM45EC ... .... 49 IOPTRON TWO YEAR TELESCOPE, MOUNT, AND CONTROLLER WARRANTY ..... 58 Ver. 1.0 **2019.9** iOptron reserves the rights to revise this instruction without notice. Actual color/contents/...

lang:en score:34 filesize: 2.29 M page\_count: 58 document date: 2019-09-24



[\[pdf\]](#) User Manual Quick Start Guide Parts List Guide

HAE Mount Instruction Manual iOptron Corp HAE69C Dual AZ EQ SWG w High Precision Encoder ioptron v Manuals ||| iOptron HAE69C Strain Wave GoTo AZ/EQ Mount Instruction Manual Product HE692C and HE694C Read the ... R. A time and site information screen will be displayed: Daylight Saving Time Y UTC -300 Minute s **2019-03-09 10:19:18** Daylight Saving Time Longitude:W071d08m50s Latitude: N42d30m32s Northern Hemis...

lang:en score:34 filesize: 2.37 M page\_count: 51 document date: 2023-10-12



[\[pdf\]](#) User Manual Quick Start Guide Parts List Guide

HAE Mount Instruction Manual iOptron Corp HAE69B EC iMate Dual AZ EQ SWG w Handset ioptron v Manuals |||

iOptron HAE69B iMate Strain Wave GoTo AZ/EQ Mount Instruction Manual Product HAE69B and HAE69B EC iM ... R. A time and site information screen will be displayed: Daylight Saving Time Y UTC -300 Minute s **2019-03-09 10:19:18** Daylight Saving Time Longitude:W071d08m50s Latitude: N42d30m32s Northern Hemis... lang:en score:34 filesize: 4.61 M page\_count: 63 document date: 2023-09-21

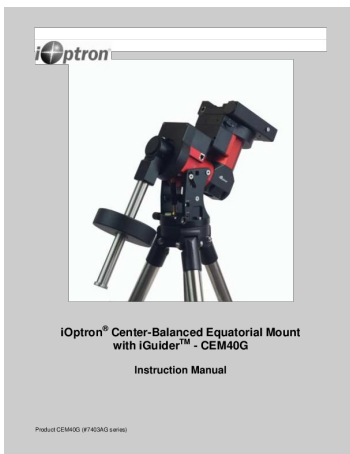

[\[pdf\]](#) User Manual Quick Start Guide Guide Warranty Accessories

HWSONG iOptron Center Balanced Equatorial Mount with iGuider CEM40G Instruction Manual Table of Contents Product 7403AG series 2 Please read the included CEM40 Quick Setup Guide QSG BEFORE taking mount out case! This product is a precision instrument before assembling Ver 1 0 2020 8 reserves rights to revise this instruction without notice Actual color entire operating Instructional manual Tips for set up Hand controller and firmware upgrades check online latest version ASCOM driver Reviews feedback from other customers Accessories US market only contents design function may vary Features Unique equatorial CEM maximum payload minimum weight You must hold firmly when disengaging gear switches 685702 ioptron v Manuals bhphotovideo lit files

iOptron Center-Balanced Equatorial Mount with iGuider™ - CEM40G Instruction Manual Product CEM40G ... ER. A time and site information screen will be displayed: Daylight Saving Time Y UTC -300 Minute s **2019-03-09 10:19:18** Longitude:W071d08m50s Latitude: N42d30m32s Northern Hemisphere Set Local Time Th...

lang:en score:33 filesize: 2.18 M page\_count: 56 document date: 2021-02-23



[\[pdf\]](#) User Manual Quick Start Guide Parts List Guide Warranty

HWSONG iOptron HEM27 Hybrid Stain Wave GoTo Equatorial Mount Instruction Manual tejraj |||

iOptron HEM27™ Hybrid Stain Wave GoTo Equatorial Mount Instruction Manual Product HEM27 and HEM27EC ... r-defined comet list. Find the orbit parameters of a comet in the SkyMap format. For example, the C/2012 ISON has an orbit parameter: No. Name Year M Day q e I H G C/2012 S1 ISON **2013 11 28...**

lang:en score:33 filesize: 2.54 M page\_count: 50 document date: 2022-07-26

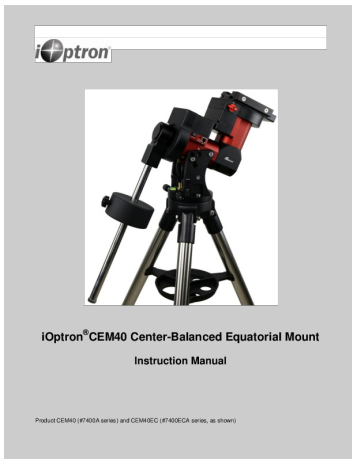

[\[pdf\]](#) User Manual Quick Start Guide Guide Warranty

HWSONG iOptron CEM40 Center Balanced Equatorial Mount cem 40 instruction manual tejraj iOptronCEM40 Center-Balanced Equatorial Mount Instruction Manual Product CEM40 #7400A series and C ... .... 49 IOPTRON TWO YEAR TELESCOPE, MOUNT, AND CONTROLLER WARRANTY ..... 58 Ver. 1.2 **2019.9** iOptron reserves the rights to revise this instruction without notice. Actual color/contents/... lang:en score:33 filesize: 2.44 M page\_count: 58 document date: 2019-09-24



[\[pdf\]](#) User Manual Quick Start Guide Parts List Guide Warranty

HWSONG iOptron HEM44 Instruction Manual Strain Wave AZ EQ Dual Mount Head with iPolar H442A hem44 manual agenaastro mw link id 370 ||| iOptron HEM44TM Hybrid Strain Wave GoTo Equatorial Mount Instruction Manual Product HEM44 and HEM44E ... r-defined comet list. Find the orbit parameters of a comet in the SkyMap format. For example, the C/2012 ISON has an orbit parameter: No. Name Year M Day q e I H G C/2012 S1 ISON 2013 11 28... lang:en score:33 filesize: 2.71 M page\_count: 48 document date: 2022-11-22



[\[pdf\]](#) User Manual Quick Start Guide Guide Warranty

HWSONG Table of Contents Product C70A C70AG Please read the included CEM70 Quick Setup Guide QSG BEFORE taking mount out case! This product is a precision instrument Instruction tejraj iOptron CEM70 Center-Balanced Equatorial Mount Instruction Manual Product #C70A, #C70AG Please rea ... ER. A time and site information screen will be displayed: Daylight Saving Time Y UTC -300 Minute s **2014-03-09 10:19:18** Longitude:W07108 50 Latitude: N4230 32 Northern Hemisphere Set Local Time The ... lang:en score:32 filesize: 2.93 M page\_count: 64 document date: 2020-06-12



[iOptron HEM27 & HEM27EC Hybrid Strain Wave GoTo Equatorial Mount Instruction Manual](#)

This instruction manual provides comprehensive guidance for the iOptron HEM27 and HEM27EC Hybrid Strain Wave GoTo Equatorial Mounts. Learn about assembly, operation, advanced features like GoTo and polar alignment, and essential maintenance for an optimal astronomy experience.

lang:en score:32 filesize: 2.57 M page\_count: 48 document date: 2022-08-02



[iOptron GEM45 German Equatorial Mount: Comprehensive Instruction Manual](#)

This instruction manual provides detailed guidance for the iOptron GEM45 German Equatorial Mount, covering assembly, setup, operation, and maintenance for astrophotography and visual observation. Learn about features like iPolar, iGuider, and the Go2Nova 8407+ hand controller.

lang:en score:32 filesize: 2.01 M page\_count: 55 document date: 2021-04-27

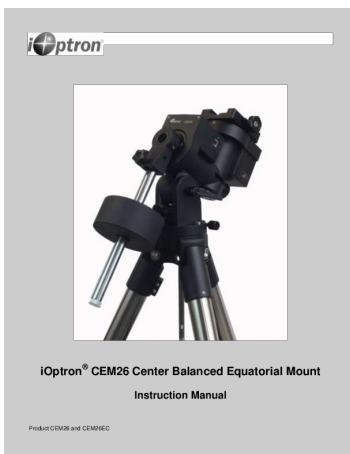

[\[pdf\] User Manual Quick Start Guide Installation Guide Guide Warranty](#)

HWSONG Step 6 Install counterweight Before putting on CW make sure iOptron CEM26 Center Balanced Equatorial Mount Instruction Manual C26 Product and CEM26EC Read the included Quick Setup Guide QSG BEFORE taking mount out Please read entire before 2 out of case! This product is a precision instrument uses magnetic gear meshing mechanism A may be equipped with an iPolar™ electronic polar scope or AccuAlign™ optical iPolar Polar Alignment For ioptron v Manuals iOptron CEM26 Center Balanced Equatorial Mount Instruction Manual Product CEM26 and CEM26EC Read t ... Polaris on the LCD screen, as indicated in the left side of the figure below. For example, June 22, 2014, 20:19:42 in Boston, US long. W7108 50 and lat. N4230 32 , UTC 300 min, the Polaris Position...

lang:en score:32 filesize: 2.38 M page\_count: 49 document date: 2021-04-18

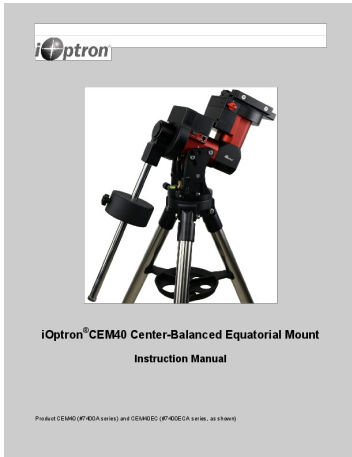

[\[pdf\]](#) User Manual Quick Start Guide Guide Warranty

Microsoft Word 20190503 CEM40 Manual V1 1 Gear Adjust docx Kevin Zou Instruction Product 7400A series and CEM40EC 7400ECA as shown 2 Please read the included Quick Setup Guide QSG BEFORE taking mount out of case! This product is a precision instrument uses magnetic gear meshing mechanism before assembling 490153 bhphotovideo lit files entire operating iOptronCEM40 Center-Balanced Equatorial Mount Instruction Manual Product CEM40 #7400A series and C ... .. 48 IOPTRON TWO YEAR TELESCOPE, MOUNT, AND CONTROLLER WARRANTY ..... 57 Ver. 1.1 **2019.5** iOptron reserves the rights to revise this instruction without notice. Actual color/contents/... lang:en score:32 filesize: 2.47 M page\_count: 57 document date: 2019-05-03

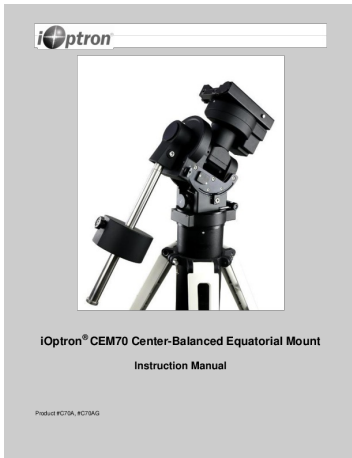

[\[pdf\]](#) User Manual Quick Start Guide Guide Warranty

HWSONG iOptron CEM70 Center Balanced Equatorial Mount Astroshop euThis mount also has an integrated electronic polar finder scope known as the iPolar This tool ensures accurate alignment of a telescope 66888 2 Anleitung ENAstroshop eu Produkt 66888 EN euManuale d uso ENThis iOptron Montierung GoTo66888 EN66888 ENomegon euManual de usuario ENManuale Montura CEM70G GoToiOptron ENv166888 es ||| ||| iOptron CEM70 Center-Balanced Equatorial Mount Instruction Manual Product #C70A, #C70AG Please read the included CEM70 Quick Setup Guide QSG BEFORE taking the mount out of the case This product is a precision instrument. Please read the inc ||| iOptron CEM70 Center-Balanced Equatorial Mount Instruction Manual Product #C70A, #C70AG Please read the included CEM70 Quick Setup Guide QSG BEFORE taking the mount out of the case This product is a precision instrument. Please read the inc iOptron CEM70 Center-Balanced Equatorial Mount Instruction Manual Product #C70A, #C70AG Please rea ... ER. A time and site information screen will be displayed: Daylight Saving Time Y UTC -300 Minute s **2014-03-09 10:19:18** Longitude:W07108 50 Latitude: N4230 32 Northern Hemisphere Set Local Time The ... lang:en score:32 filesize: 2.85 M page\_count: 64 document date: 2020-06-22



[\[pdf\]](#) User Manual Quick Start Guide Parts List Guide

HAZ Mount Instruction Manual iOptron Corp HAZ46 Alt Azimuth Strain Wave Head — Astronomics v 13327295684082795383 astronomics cdn shop files ||| iOptron HAZ™ Strain Wave Alt-Az GoTo Mount Instruction Manual Product HAZ31 and HAZ46 Read the Qu ... r-defined comet list. Find the orbit parameters of a comet in the SkyMap format. For example, the C/**2012** ISON has an orbit parameter: No. Name Year M Day q e I H G C/**2012** S1 ISON **2013** 11 28... lang:en score:31 filesize: 2.11 M page\_count: 44 document date: 2024-05-06



### [iOptron SkyHunter™ Portable EQ/AZ GOTO System Instruction Manual](#)

This instruction manual provides comprehensive guidance for setting up, operating, and maintaining the iOptron SkyHunter™ Portable EQ/AZ GOTO System, a lightweight and versatile telescope mount for astrophotography and observation.

lang:en score:31 filesize: 2.21 M page\_count: 43 document date: 2022-07-15



### [iOptron HAE69 Strain Wave GoTo AZ/EQ Mount Instruction Manual](#)

This manual provides detailed instructions for setting up, operating, and maintaining the iOptron HAE69 and HAE69EC Strain Wave GoTo AZ/EQ Mounts. It covers features, components, assembly, and advanced functions for astronomical observation and astrophotography.

lang:en score:31 filesize: 2.33 M page\_count: 46 document date: 2023-08-16



### [iOptron HAZ130 Mount: Strain Wave Alt-Az GoTo Telescope Mount Instruction Manual](#)

This instruction manual provides comprehensive details on setting up, operating, and maintaining the iOptron HAZ130 Strain Wave Alt-Az GoTo Mount, featuring advanced strain wave gear technology for astronomical observation and imaging.

lang:en score:30 filesize: 2.67 M page\_count: 50 document date: 2025-07-17



[\[pdf\]](#) User Manual Quick Start Guide Parts List Guide Warranty Accessories

Microsoft Word CEM120 Manual 180116.docx Kevin Zou iOptron Center Balanced Equatorial Mount Instructional manual Tips for set up Hand controller and mount firmware upgrades check online latest version ASCOM driver Reviews feedback from other customers Accessories 1 US market only Actual contents may vary Quick Start Guide 56285 Anleitung EN nimax img de Produkt iOptron CEM120 Center-Balanced Equatorial Mount Instruction Manual Product #7300 and#7301 1 Read t ... ON TWO YEAR TELESCOPE, MOUNT, AND CONTROLLER WARRANTY ..... 46 Ver. 0.9 2017.12 iOptron reserves the rights to revise this instruction without notice. Actual color/contents... lang:en score:30 filesize: 1.57 M page\_count: 46 document date: 2018-02-20

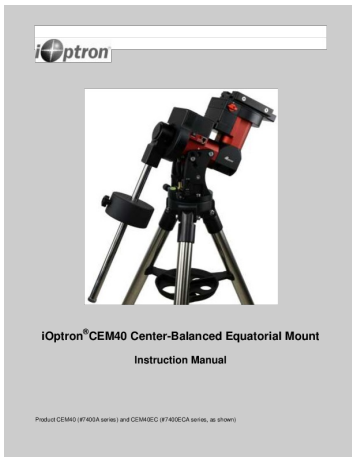

[iOptron CEM40 Center-Balanced Equatorial Mount Instruction Manual](#)

This document is the instruction manual for the iOptron CEM40 Center-Balanced Equatorial Mount, detailing its features, assembly, operation, and maintenance for astrophotography and visual observation. lang:en score:29 filesize: 2.01 M page\_count: 52 document date: 2021-02-23



[\[pdf\]](#) User Manual Parts List Warranty Accessories

HWSONG iOptron CEM120 Center Balanced Equatorial Mount Instruction Manual 7300 Table of Contents Instructional manual Tips for set up Hand controller and mount firmware upgrades check online latest version ASCOM driver Reviews feedback from other customers Accessories 1 US market only Actual contents may vary © Product 7301 7302 4 2 Operation the The can now be used to observe astronomical objects using HC Use arrow keys ▶ ◀ ▼ ▲ point telescope ioptron v Manuals 80 iOptron CEM120 Center-Balanced Equatorial Mount Instruction Manual Product #7300, #7301 #7302 1 ... ON TWO YEAR TELESCOPE, MOUNT, AND CONTROLLER WARRANTY ..... 53 Ver. 1.4 2019.6 iOptron reserves the rights to revise this instruction without notice. Actual color/contents/... lang:en score:29 filesize: 2.34 M page\_count: 53 document date: 2020-06-12

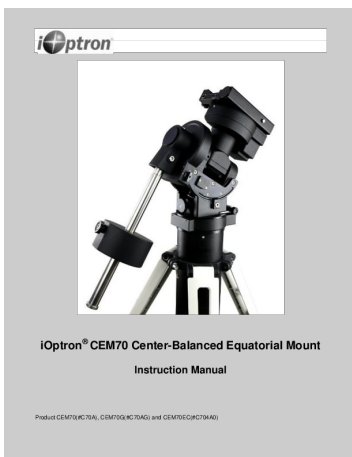

[iOptron CEM70 Center-Balanced Equatorial Mount Instruction Manual](#)

Comprehensive guide for the iOptron CEM70 Center-Balanced Equatorial Mount, detailing its features, setup, operation, and maintenance for astrophotography and astronomical observation. lang:en score:29 filesize: 2.93 M page\_count: 64 document date: 2021-01-20



[\[pdf\]](#) User Manual Quick Start Guide Guide Warranty

HWSONG iOptron CEM60 Center Balanced Equatorial Mount 2.6 Go2Nova® 8407 Hand Controller  
 Figure 8 hand controller The HC shown in is the standard used on mount It has an integrated heater that ensures LCD display will work at temperature as low 20°C 4°F 7200 Manual ioptron us Table of Contents · Quick Start Guide Instructional manual Tips for set up and firmware 4 Operation can now be to observe 80  
 iOptron CEM60 Center-Balanced Equatorial Mount Instruction Manual Product #7200 and #7201 Please read the included CEM60 Quick Setup Guide QSG BEFORE taking the mount out of the case This product is a precision instrument and uses a magnetic gear meshing mechanism. Please read the included QSG be...  
 lang:en score:29 filesize: 2.37 M page\_count: 49 document date: 2020-04-04



[\[pdf\]](#) User Manual Quick Start Guide Parts List Guide

HAE Mount Instruction Manual iOptron Corp HAE69B 1 HAE43B iMate Dual Equatorial and Alt Azimuth Strain Wave — Astronomics v 8078021216147614958 astronomics cdn shop files EC And Mo |||  
 iOptron HAE69B iMate Strain Wave GoTo AZ/EC Mount Instruction Manual Product HAE69B and HAE69B EC iM ... R. A time and site information screen will be displayed: Daylight Saving Time Y UTC -300 Minute s 2019-03-09 10:19:18 Daylight Saving Time Longitude:W071d08m50s Latitude: N42d30m32s Northern Hemi...  
 lang:en score:29 filesize: 4.61 M page\_count: 63 document date: 2023-12-21

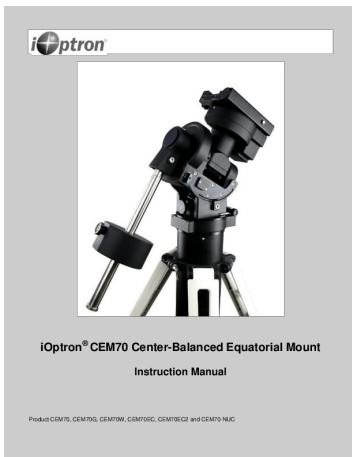

[\[pdf\]](#) User Manual Quick Start Guide Instructions Guide Warranty

CEM70 Instruction iOptron Corp C70 Manual CEM70EC center balanced go to equatorial mount with iPolar without tripod — Astronomics v 12417154092478753715 astronomics cdn shop files NUC Center Balanced Go To Equatorial Mount Fin 68ecd2dd ea54 4d7f 93df 470e447a39f9 CEM70EC2 version 470e447a39f9 Download Instructions in format iOptron Astronomics iOptron CEM 70 i Guider GoTo Computerised EQ 1 75inch Steel TripodiOptron Astronomics C70 12417154092478753715 C70 12417154092478753715 astronomics 12417154092478753715 tejraj product manual Manualastronomics |||  
 iOptron CEM70 Center-Balanced Equatorial Mount Instruction Manual Product CEM70, CEM70G, CEM70W, CEM ... ER. A time and site information screen will be displayed: Daylight Saving Time Y UTC -300 Minute s 2014-03-09 10:19:18 Longitude:W07108 50 Latitude: N4230 32 Northern Hemisphere Set Local Time The ...  
 lang:en score:28 filesize: 2.98 M page\_count: 61 document date: 2023-03-14





[\[pdf\]](#) User Manual Quick Start Guide Guide Warranty

GEM28 Instruction iOptron Corp G28 Manual go to German Equatorial Mount with Hard case and 1 75 LiteRoc Tripod — Astronemics v 2361796842743078483 astronemics cdn shop files GEM28EC iPolar hard |||

iOptron GEM28 German Equatorial Mount Instruction Manual Product GEM28 and GEM28EC Read the includ ... Polaris on the LCD screen, as indicated in the left side of the figure below. For example, June 22, **2014**, 20:19:42 in Boston, US long. W7108 50 and lat. N4230 32 , UTC 300 min, the Polaris Position...

lang:en score:28 filesize: 2.47 M page\_count: 51 document date: 2023-10-06

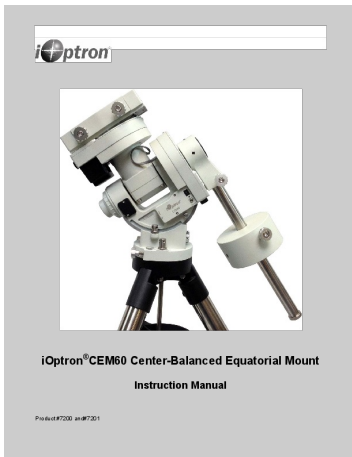

[\[pdf\]](#) User Manual Quick Start Guide Guide Warranty

Microsoft Word CEM60 Manual V1 2 150408 docx Kevin Zou iOptron Center Balanced Equatorial Mount Instruction Product 7200 and 7201 Please read the included Quick Setup Guide QSG BEFORE taking mount out of case! This product is a precision instrument uses magnetic gear meshing mechanism before assembling entire V1R2 ioptron us |||

iOptronCEM60 Center-Balanced Equatorial Mount Instruction Manual Product #7200 and#7201 Please read the included CEM60 Quick Setup Guide QSG BEFORE taking the mount out of the case This product is a precision instrument and uses a magnetic gear meshing mechanism. Please read the included QSG be...

lang:en score:28 filesize: 1.72 M page\_count: 47 document date: 2018-07-07

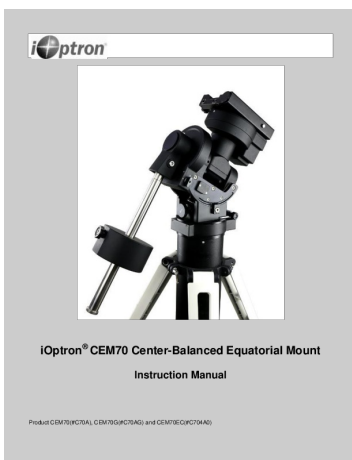

[\[pdf\]](#) User Manual Quick Start Guide Guide Warranty

HWSONG Mount Please read the entire Instruction Manual before operating mount You must hold firmly when disengaging gear switches C70\_CEM70\_Manual ioptron v Manuals iOptron Welcome to a new type of equatorial iOptron® Center-Balanced Equatorial or CEM! CEM70 offers benefits our PDF and Manual:

iPolar Software: firmware 3339\_iOptron\_iPolar exe manuals 3339\_iPolarOperationManual Product CEM70(#C70A) CEM70G(#C70AG) CEM70EC(#C70A0)

iOptron CEM70 Center-Balanced Equatorial Mount Instruction Manual Product CEM70 #C70A , CEM70G #C70A ... ER. A time and site information screen will be displayed: Daylight Saving Time Y UTC -300 Minute s **2014-03-09 10:19:18** Longitude:W07108 50 Latitude: N4230 32 Northern Hemisphere Set Local Time The ...

lang:en score:28 filesize: 2.69 M page\_count: 56 document date: 2021-04-27



[\[pdf\]](#) User Manual Quick Start Guide Parts List Guide Declaration of Conformity Accessories

Microsoft Word iEQ45 Pro Manual 20151104 Parking doc Kevin ProTM Equatorial Mount Instruction Product 8000E @ 2 This product is a precision instrument Please read the included QSG before assembling mount entire operating If you have any questions please contact us at support@ioptron 50029 1 Anleitung EN nimax img de Produkt iOptron Quick Start Guide instruction manual Tips for set up Hand controller and firmware upgrades check online latest version ASCOM driver Reviews feedback from other customers Accessories US market only Actual contents may vary  
 iOptron iEQ45 ProTM Equatorial Mount Instruction Manual Product #8000E This product is a precisio ... IOPTRON TWO YEAR TELESCOPE, MOUNT, AND CONTROLLER WARRANTY .....45 Rev. 2.0 2015.03 iOptron reserves the rights to revise this instruction without notice. Actual color/contents...  
 lang:en score:28 filesize: 1.48 M page\_count: 45 document date: 2018-02-07

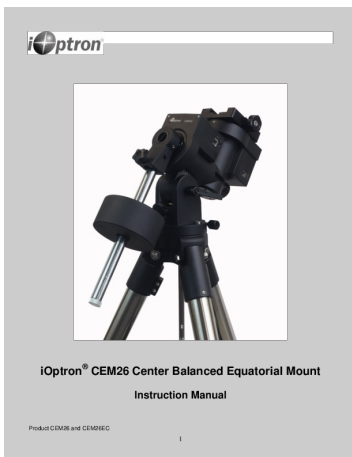

[\[pdf\]](#) User Manual Quick Start Guide Installation Guide Guide Warranty

HWSONG Step 7 Install telescope Read the included Quick Setup Guide QSG BEFORE taking mount out of case! This product is a precision instrument and uses magnetic gear meshing mechanism View C26 CEM26 Manual1 ioptron v Manuals |||  
 iOptron CEM26 Center Balanced Equatorial Mount Instruction Manual Product CEM26 and CEM26EC 1 2 ... Polaris on the LCD screen, as indicated in the left side of the figure below. For example, June 22, 2014, 20:19:42 in Boston, US long. W7108 50 and lat. N4230 32 , UTC 300 min, the Polaris Position...  
 lang:en score:27 filesize: 2.38 M page\_count: 50 document date: 2021-12-16

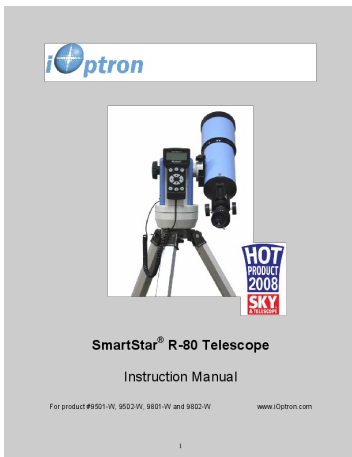

[SmartStar® R-80 Telescope Instruction Manual](#)

Comprehensive instruction manual for the iOptron SmartStar® R-80 telescope, covering assembly, setup, operation, maintenance, and troubleshooting. Learn how to use the GoToNova® 8405 hand controller for celestial and land object viewing.  
 lang:en score:27 filesize: 643.54 K page\_count: 38 document date: 2010-02-06

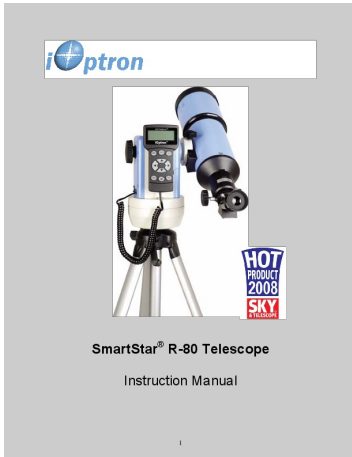

[pdf] User Manual Quick Start Guide Declaration of Conformity

Microsoft Word SmartStar R 80 Instruction V1 0 doc Kevin Zou 9500 9800 R80 Manual ioptron us  
 SmartStar R-80 Telescope Instruction Manual 1 Table of Content Table of Content  
 ..... ... 6 195 Sgr 5.5 196 Phi Tau 52 197 Chi Tau 19.4 198 118 Tau 4.8 199 6  
 Tri 3.9 200 Zet UMa 14 **201** Nu UMa 7.2 202 23 UMa 23 203 Ups UMa 11.6 204 Xi  
 UMa 1.8 205 Sig 2 UMa 3.9 206 57 UMa 5...

lang:en score:26 filesize: 1.13 M page\_count: 38 document date: 2009-10-19

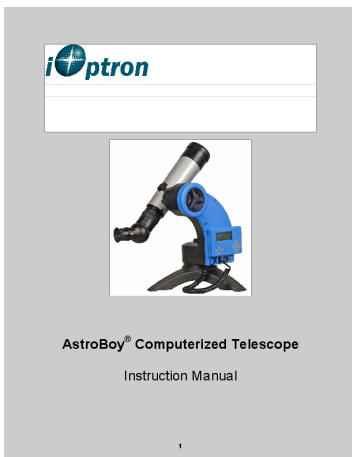

[pdf] User Manual Quick Start Guide Declaration of Conformity

Microsoft Word AstroBoy Instruction v1 3 doc Kevin Zou Instruction1 9400 ioptron images up us 80  
 Manual  
 AstroBoy Computerized Telescope Instruction Manual 1 Table of Content Table of  
 Content ..... actory. It is strongly suggested that to send your technical  
 questions to support ioptron.com. Dec, **2010** V1.3 iOptron reserves the rights to  
 revise this instruction without notice. Actual color/conten...

lang:en score:26 filesize: 681.66 K page\_count: 41 document date: 2011-08-10



[pdf] User Manual Quick Start Guide Declaration of Conformity

Microsoft Word SmartStar N 114 Instruction V1 0 doc Kevin Zou 9803 full manual ioptron 80 images up  
 SmartStar N114 Telescope Instruction Manual 1 Table of Content Table of Content  
 ..... ... 6 195 Sgr 5.5 196 Phi Tau 52 197 Chi Tau 19.4 198 118 Tau 4.8 199 6  
 Tri 3.9 200 Zet UMa 14 **201** Nu UMa 7.2 202 23 UMa 23 203 Ups UMa 11.6 204 Xi  
 UMa 1.8 205 Sig 2 UMa 3.9 206 57 UMa 5...

lang:en score:26 filesize: 1.03 M page\_count: 38 document date: 2009-10-19



[\[pdf\]](#) User Manual Instructions

Orion StarBlast 6 6i IntelliScope Reflector Instruction Manual Telescopios Chile INSTRUCTION MANUAL  
Francais Deutsche Italiano ❶ Pour obtenir le manuel d utilisation complet veuillez vous rendre sur site  
Web Either way we hope you enjoy your journey through the universe! These instructions will help set up  
and use telescope please read ORION STARBLAST EN 1 telescopioschile cl 2021 10  
INSTRUCTION MANUAL Orion StarBlast™ 6/6i IntelliScope Reflector Francais Pour  
obtenir le manuel d ... Eta Sigma ST194 Theta ST195 ST196 Bellatrix 698 ST197  
ST198 ST199 716 725 TL9 ST200 Delta ST201 ST202 119 718 ST203 ST204 RT  
747 ST205 Lambda ST206 ST207 Trapezium 752 ST208 ST209 Alni...  
lang:en score:26 filesize: 8.17 M page\_count: 64 document date: 2020-09-22