

## COBIZI Heavy Duty Gazebo

# COBIZI 12x20 Heavy Duty Outdoor Gazebo

**Model:** Heavy Duty Gazebo  
Instruction Manual

## 1. INTRODUCTION

---

Thank you for choosing the COBIZI 12x20 Heavy Duty Outdoor Gazebo. This manual contains important information regarding the safe assembly, operation, and maintenance of your gazebo. Please read it thoroughly before beginning assembly and retain it for future reference.

### Safety Precautions

- Ensure all components are present and undamaged before assembly. Do not proceed with assembly if any parts are missing or broken.
- Assembly requires at least 2 people.
- Choose a level and stable surface for installation.
- Securely anchor the gazebo to the ground using the provided expansion bolts and stakes, especially in windy conditions.
- Do not use open flames or heating appliances inside the gazebo.
- In case of strong winds, heavy rain, or snow, remove the canopy fabric to prevent damage to the structure.

## 2. PRODUCT OVERVIEW

---

The COBIZI 12x20 Heavy Duty Outdoor Gazebo is designed to provide a spacious and comfortable outdoor shelter. It features a robust steel frame, a double-layered roof for ventilation, and removable mosquito netting.

### Key Features:

- **Sturdy Steel Frame:** Powder-coated steel frame for rust resistance and durability. Features five supporting steel tubes and a sturdy beam structure.
- **Thickened Leg Tubes:** Each leg has a diameter of  $\Phi 80\text{mm}$  (3.1"), providing enhanced stability. Includes

expansion bolts and stakes for secure ground attachment.

- **Ventilated Double-Roof:** Designed for improved air circulation and wind resistance. The top roof includes a mosquito net. A drain hole prevents water accumulation.
- **Water and UV-Resistant Fabric:** Made from 1500ml water-pressure waterproof polyester fabric, offering UPF 50+ UV protection and fade resistance.
- **Removable Mosquito Netting:** Zippered mesh netting with curtain rings for easy opening and closing, providing ventilation and protection from insects.

## 12X20 LARGE GAZEBO with Netting

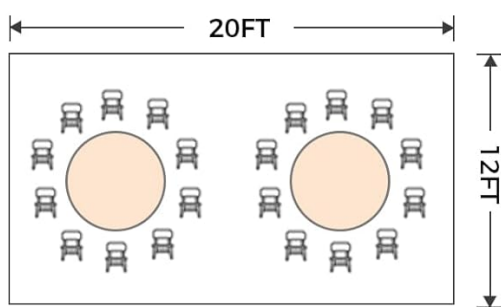
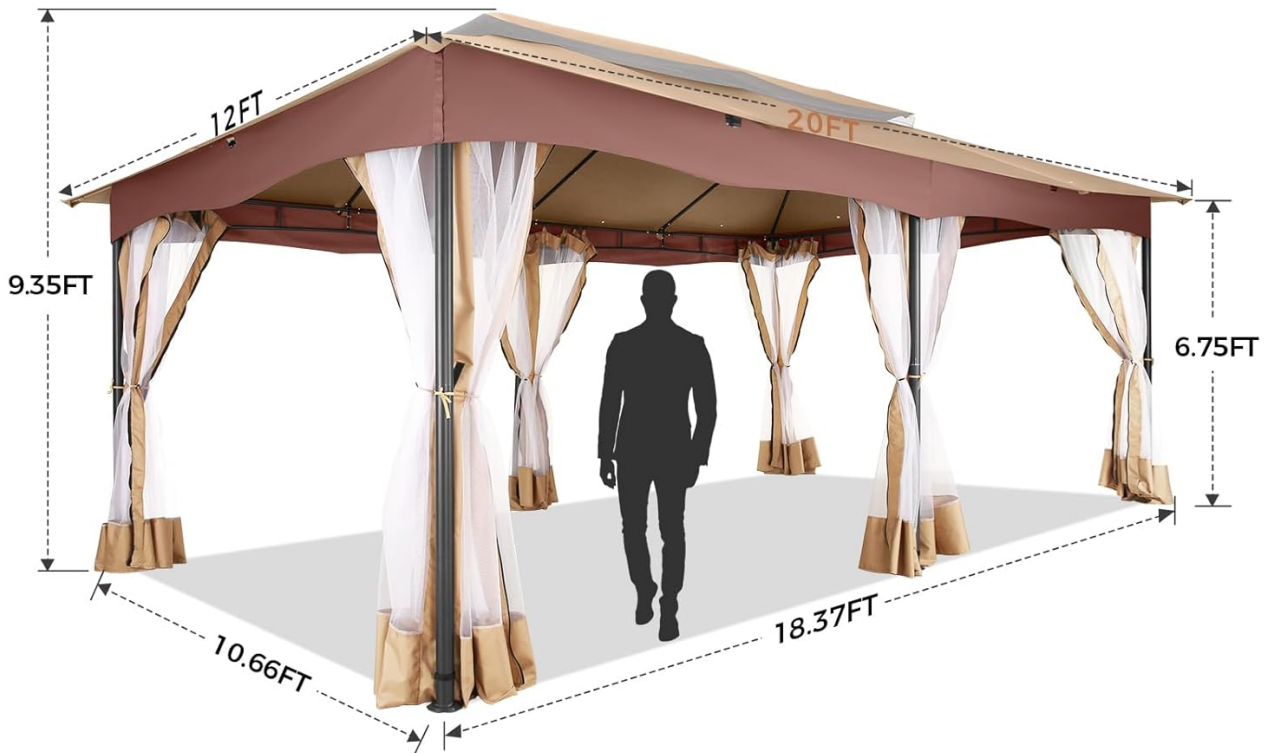

Figure 2.1: Gazebo dimensions and key features.

# NEW UPGRADE DURABLE METAL GAZEBO

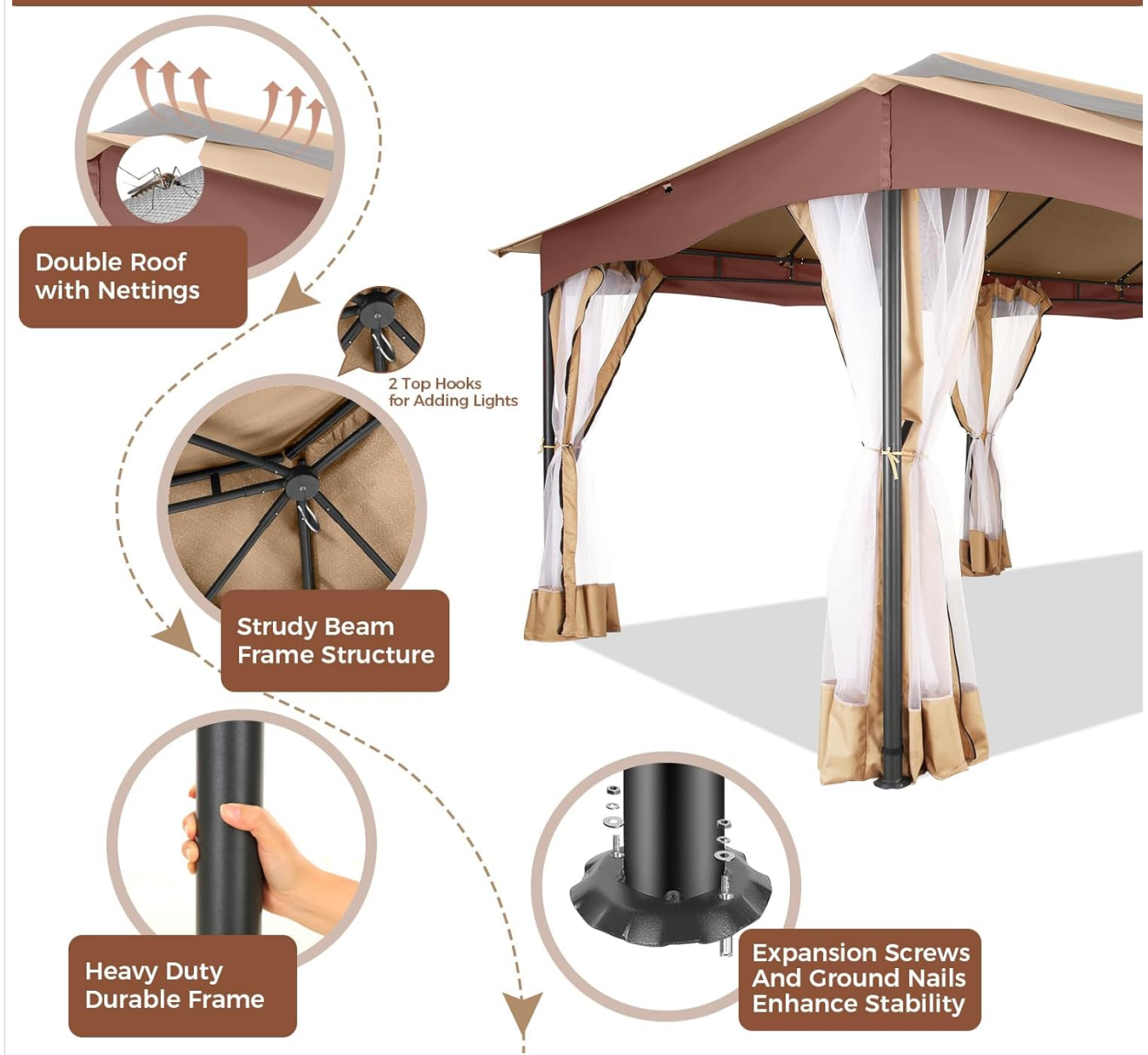

Figure 2.2: Detailed view of the gazebo's upgraded metal frame and roof design.



Figure 2.3: Components and features of the gazebo fabric and netting.

### 3. PACKING LIST

Before assembly, verify that all parts listed below are included in your package. If any parts are missing or damaged, please contact customer support.

# PACKING LIST



2 X Canopy Tops



6 X Netting Wall



12 X Ground Nails + 6 Expansion Screws

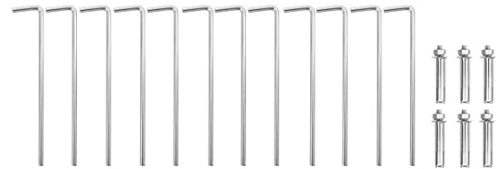

1 Frame (Several Connecting Rods + Several Nuts and Screw + 6 Pairs of Leg Tubes + 2 X Ceiling Hooks)

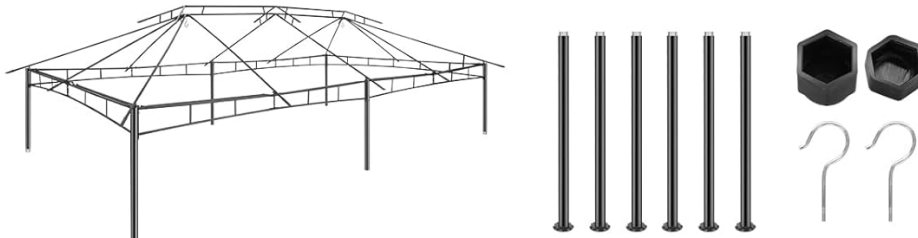

Figure 3.1: Contents of the COBIZI 12x20 Gazebo package.

- 2 x Canopy Tops
- 6 x Netting Walls
- 12 x Ground Nails
- 6 x Expansion Screws
- 1 x Frame (Includes various connecting rods, nuts, screws, 6 pairs of leg tubes, and 2 ceiling hooks)
- Other installation accessories (e.g., tools if provided)

## 4. SETUP INSTRUCTIONS

Follow these steps carefully for proper assembly. It is recommended that 2 or more people assemble this gazebo.

## STEP 01

Organize the corresponding numbered ribbed poles into a bottom frame according to the instructions

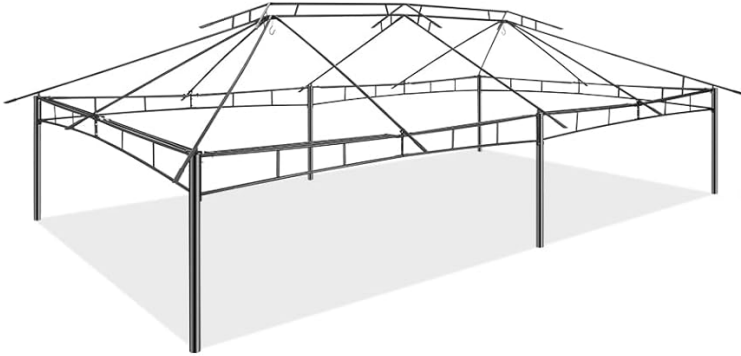
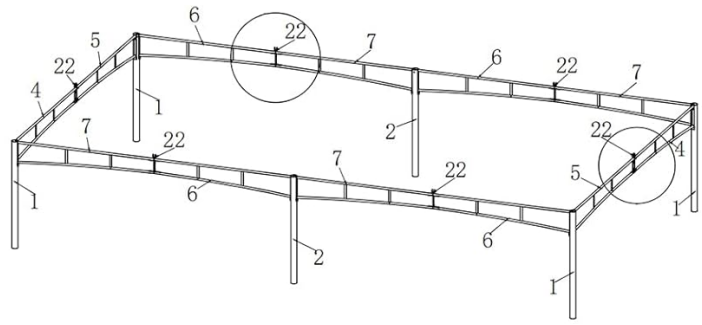

## STEP 02

Follow the instructions to Organize the corresponding numbered ribbed poles into a top frame and install them on the bottom frame



## STEP 03

Put the top fabric on the top frame first, then install the leg poles to raise the gazebo



## STEP 04

Use the included curtain rings to hang the mosquito netting

Figure 4.1: Visual guide for gazebo assembly steps.

### 1. Step 1: Assemble the Bottom Frame

Organize the corresponding numbered ribbed poles to form the bottom frame according to the provided instructions. Ensure all connections are secure.

### 2. Step 2: Assemble and Install the Top Frame

Follow the instructions to organize the corresponding numbered ribbed poles into the top frame. Install this assembled top frame onto the bottom frame.

### 3. Step 3: Attach Canopy Fabric and Leg Poles

First, place the top fabric onto the assembled top frame. Then, install the leg poles to raise the gazebo structure.

### 4. Step 4: Install Mosquito Netting

Use the included curtain rings to hang the mosquito netting around the perimeter of the gazebo.

**Note:** Assembly typically takes about 1 hour and requires 2 or more people.

## 5. OPERATING INSTRUCTIONS

Your COBIZI gazebo is designed for versatile use. Here are some tips for operation:

- **Mosquito Netting:** The zippered mesh netting can be easily opened or closed using the smooth double zippers. Use the portable straps to tie back the netting when not in use.
- **Curtains:** The gazebo includes curtains that can be drawn for privacy or tied back to allow an open view.
- **Ceiling Hooks:** Utilize the integrated metal hooks inside the gazebo to hang small items such as lamps or decorative lights.



Figure 5.1: Gazebo configurations for different weather and usage needs.

## 6. MAINTENANCE

Proper maintenance will extend the life of your gazebo.

- **Cleaning:** Clean the canopy fabric and netting with mild soap and water. Rinse thoroughly and allow to air dry completely before storage. Do not use harsh chemicals or abrasive cleaners.
- **Frame Care:** Inspect the steel frame periodically for any signs of rust or damage. Touch up any scratches with rust-inhibiting paint to prevent corrosion. Ensure all bolts and connections remain tight.
- **Weather Protection:** While the canopy is water-resistant, it is not fully waterproof. In anticipation of heavy

rain, strong winds, or snow, it is advisable to remove the canopy fabric and netting to prevent damage to the structure and fabric.

- **Storage:** When not in use for extended periods, especially during off-season, disassemble the gazebo and store all components in a dry, protected area to prevent wear and tear.

## 7. TROUBLESHOOTING

If you encounter issues with your gazebo, refer to the following common problems and solutions:

Problem	Possible Cause	Solution
Gazebo feels unstable or wobbly.	Improper anchoring; loose connections; uneven ground.	Ensure all leg poles are securely anchored with stakes and expansion bolts. Check and tighten all frame connections. Relocate to a level surface if necessary.
Water pooling on the roof.	Heavy rainfall exceeding drainage capacity; fabric sagging.	The roof has a drain hole to prevent pooling. If pooling occurs, gently push up from underneath to release water. Consider removing the canopy in very heavy rain. Ensure fabric is taut during assembly.
Mosquito netting not closing properly.	Zipper misalignment; fabric obstruction.	Ensure the netting is properly aligned on its curtain rings. Clear any fabric obstructions from the zipper path.
Difficulty with assembly.	Incorrect part orientation; insufficient personnel.	Refer to the numbered diagrams and ensure parts are oriented correctly. Ensure at least two people are assisting with assembly.

## 8. SPECIFICATIONS

Feature	Detail
Brand	COBIZI
Model Number	Heavy Duty Gazebo
Dimensions (L x W x H)	11.81"L x 15.75"W x 65.75"H (Note: Product title indicates 12x20 ft, this specification might be for packaging or a component)
Size	12X20 with Nettings (Flat Top)
Coverage	240 square feet
Occupancy	16-18 people
Frame Material	Reinforced Metal (Steel with powder-coating)

Feature	Detail
Canopy Material	1500ml water-pressure waterproof polyester fabric
UV Protection	UPF50+
Water Resistance Level	Not Water Resistant (Note: Product description states 'water-pressure waterproof polyester fabric' but spec says 'Not Water Resistant'. Treat as water-resistant for light rain, but not fully waterproof.)
Item Weight	123.5 Pounds
Required Assembly	Yes

## 9. WARRANTY AND SUPPORT

---

COBIZI stands behind the quality of its products. For specific warranty information, please refer to the warranty card included with your purchase or contact COBIZI customer support directly.

If you have any questions, require assistance with assembly, or need to report missing/damaged parts, please contact our customer support team:

- **Website:** Visit the official COBIZI website for support resources.
- **Email:** Refer to your purchase documentation for customer service email.
- **Phone:** Refer to your purchase documentation for customer service phone number.

Please have your model number (Heavy Duty Gazebo) and purchase date available when contacting support.